

Property of Lite-On Only

## Features

- \* Package in 12mm tape on 7" diameter reels.
- \* Compatible with automatic placement equipment.
- \* Compatible with infrared and vapor phase reflow solder process.
- \* EIA STD package.
- \* I.C. compatible.
- \* Meet green product and Pb-free(According to RoHS)

## Package Dimensions

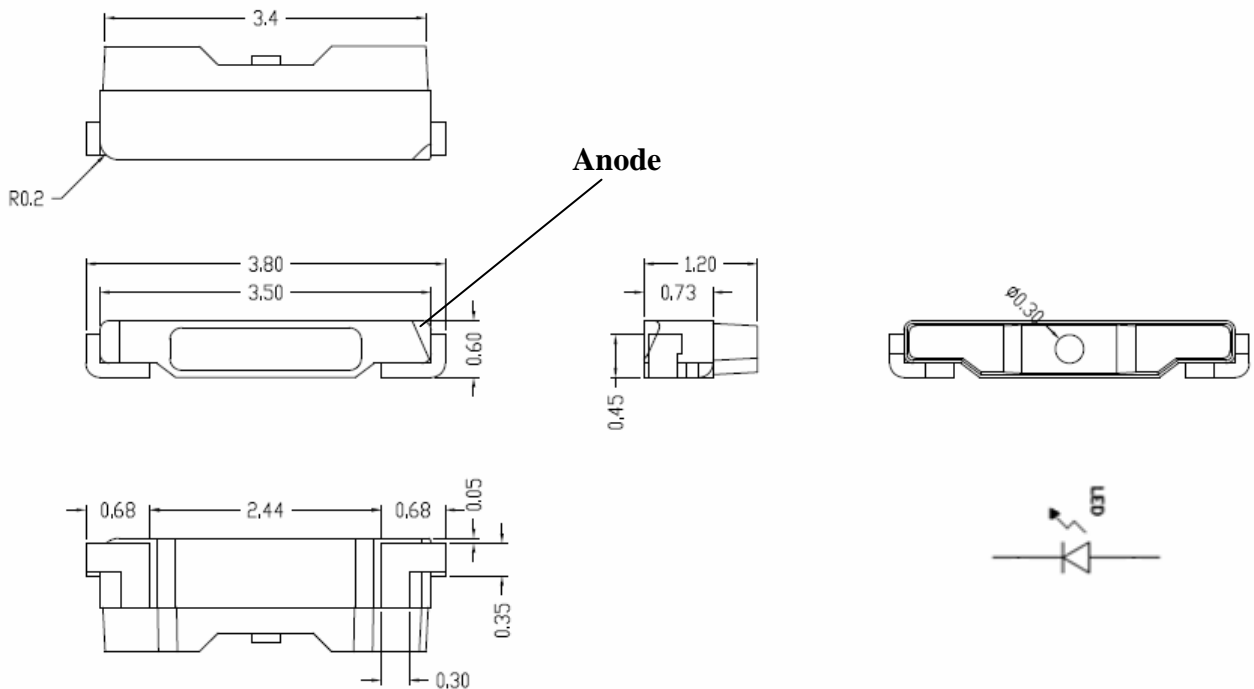

Part No.	Lens Color	Source Color
LTST-020QRL	limpid	AlGaInP Red

### Notes:

1. All dimensions are in millimeters (inches).
2. Tolerance is  $\pm 0.1$  mm (.004") unless otherwise noted.

### Definition of Distance Between of PAD and Reflector

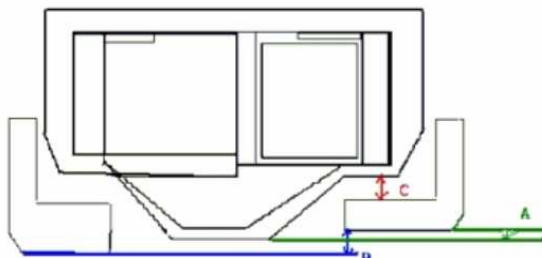

- A: The distance between pad's bottom and reflector.  
 B: The tolerance between right and left pad.  
 C: The distance between pad and reflector.

Symbol	Dimension (mm)			
A	0	min	0.05	max
B	0	min	0.03	max
C	0	min	0.05	max

## Property of Lite-On Only

### Absolute Maximum Ratings at Ta=25°C

Parameter	LTST-020QRL	Unit
Power Dissipation	120	mW
Peak Forward Current (1/10 Duty Cycle, 0.1ms Pulse Width)	100	mA
DC Forward Current	30	mA
Reverse Voltage	5	V
Operating Temperature Range	-30°C to +85°C	
Storage Temperature Range	-40°C to +100°C	
Reflow Soldering Condition	260°C For 10 Seconds	

Suggest IR Reflow Condition :

### R-Reflow Soldering Profile for lead free soldering (Acc. to J-STD-020B)

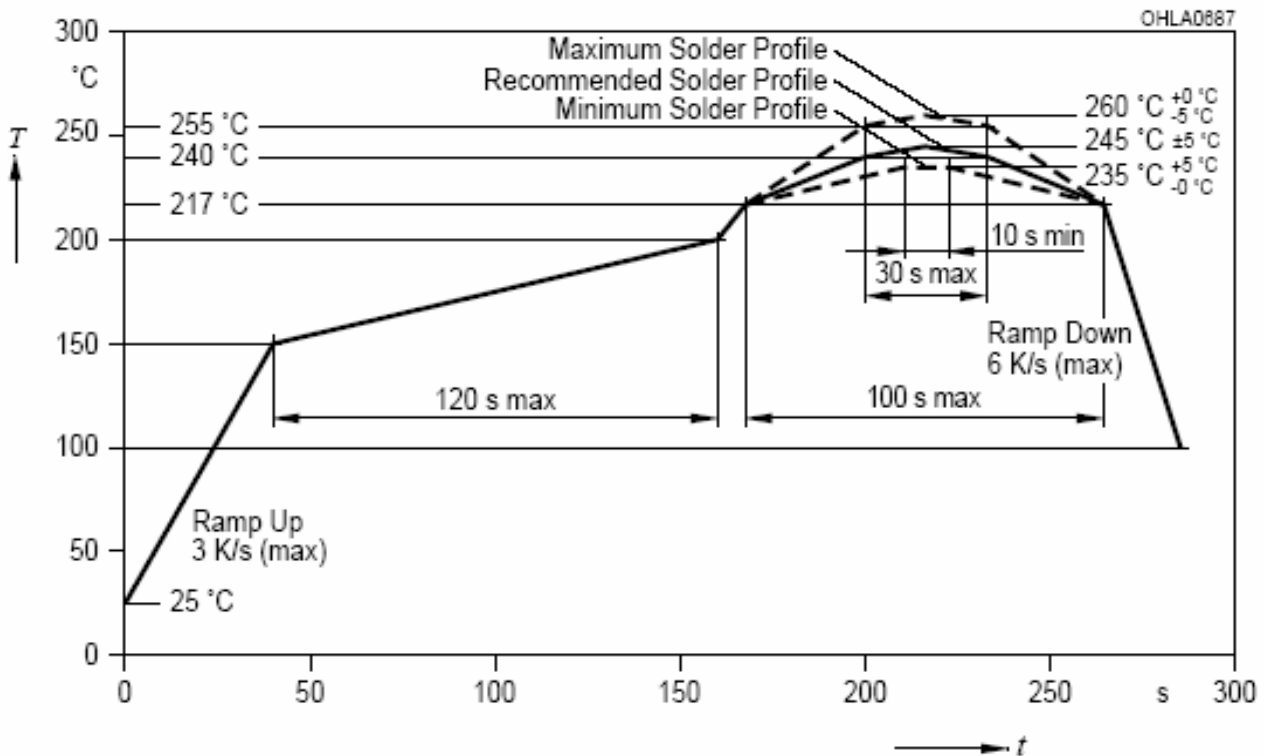

## Electrical Optical Characteristics At Ta=25°C

Parameter	Symbol	Part No. LTW-	Min.	Typ.	Max.	Unit	Test Condition
Luminous Intensity	IV	020QRL	200	-	400	mcd	IF = 20mA Note 1, 2, 4
Viewing Angle	$2\theta$ 1/2	020QRL		110		deg	Fig.6
Dominant Wavelength	$\lambda_d$	020QRL	619	-	629	nm	IF = 20mA Note 2, 5 Fig.1
Forward Voltage	VF	020QRL	-	2.0	2.4	V	IF = 20mA
ESD-Withstand Voltage	ESD	020QRL	2K			V	HBM

Note : 1. Luminous intensity is measured with a light sensor and filter combination that approximates the CIE eye-response curve.

2. Iv classification code is marked on each packing bag.

3. Caution in ESD:

Static Electricity and surge damages the LED. It is recommend to use a wrist band or anti-electrostatic glove when handling the LED. All devices, equipment and machinery must be properly grounded.

4. CAS140B is the test standard for the Dominant Wavelength & IV.

5. The Dominant Wavelength guarantee should be added +/- 2nm tolerance.

**Property of Lite-On Only****Bin Code List**

<b>VF Spec. Table</b>		
<b>VF Bin</b>	<b>Forward Voltage (V) at IF = 20mA</b>	
	<b>Min.</b>	<b>Max.</b>
<b>VA1</b>	<b>1.8</b>	<b>1.9</b>
<b>VA2</b>	<b>1.9</b>	<b>2.0</b>
<b>VB1</b>	<b>2.0</b>	<b>2.1</b>
<b>VB2</b>	<b>2.1</b>	<b>2.2</b>
<b>VC1</b>	<b>2.2</b>	<b>2.3</b>
<b>VC2</b>	<b>2.3</b>	<b>2.4</b>

Tolerance on each Forward Voltage bin is +/-0.10 volt

<b>IV Spec. Table</b>		
<b>IV Bin</b>	<b>Luminous Intensity (mcd) at IF = 20mA</b>	
	<b>Min.</b>	<b>Max.</b>
<b>P1</b>	<b>200</b>	<b>300</b>
<b>P2</b>	<b>300</b>	<b>400</b>
<b>Q1</b>	<b>400</b>	<b>500</b>
<b>Q2</b>	<b>500</b>	<b>600</b>
<b>R1</b>	<b>700</b>	<b>800</b>

Tolerance on each Luminous Intensity bin is +/- 10%.

## Property of Lite-On Only

### Typical Electrical / Optical Characteristics Curves (25°C Ambient Temperature Unless Otherwise Noted)

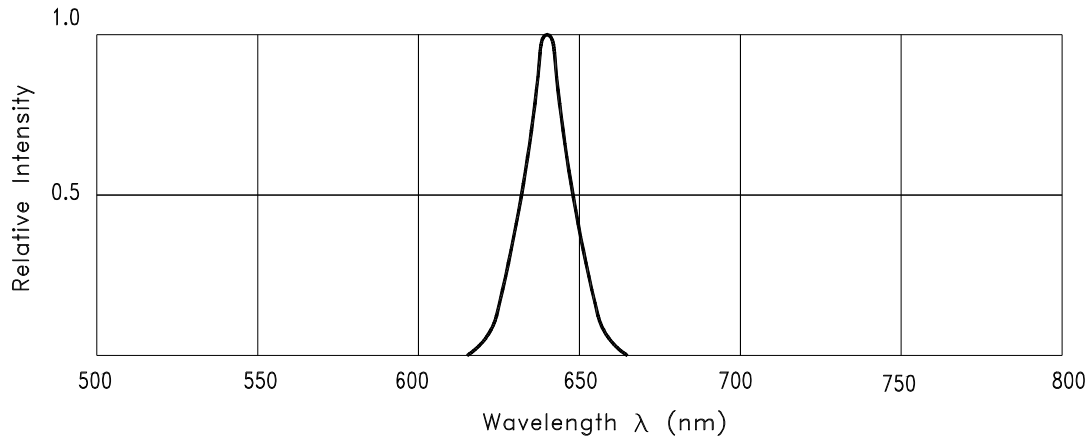

Fig.1 RELATIVE INTENSITY VS. WAVELENGTH

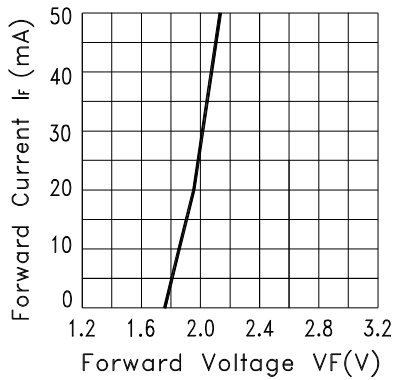

Fig.2 FORWARD CURRENT VS. FORWARD VOLTAGE

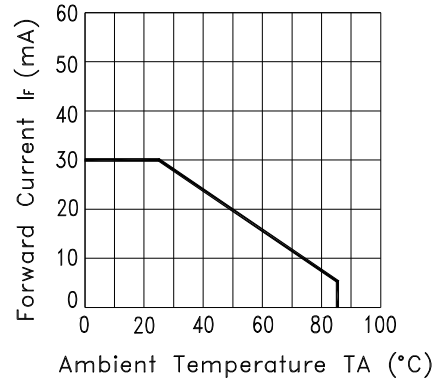

Fig.3 FORWARD CURRENT DERATING CURVE

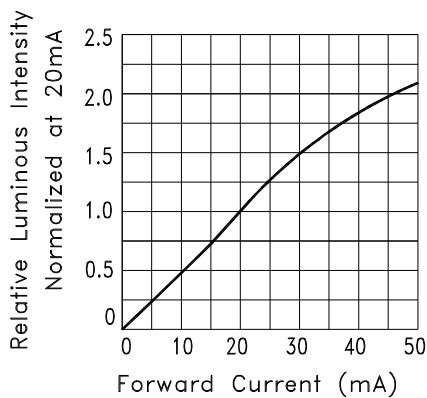

Fig.4 RELATIVE LUMINOUS INTENSITY VS. FORWARD CURRENT

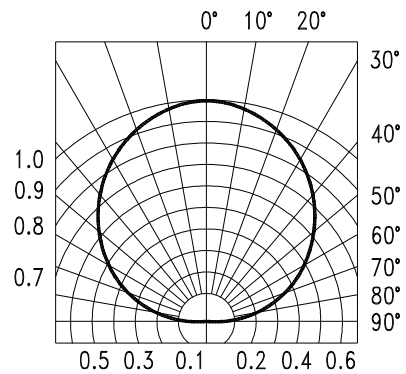

Fig.5 Spatial Distribution

Property of Lite-On Only

## User Guide

### Cleaning

Do not use unspecified chemical liquid to clean LED they could harm the package.  
If cleaning is necessary, immerse the LED in ethyl alcohol or isopropyl alcohol at normal temperature for less one minute.

### Recommend Printed Circuit Board Attachment Pad

Infrared / vapor phase  
Reflow Soldering



### Package Dimensions of Tape

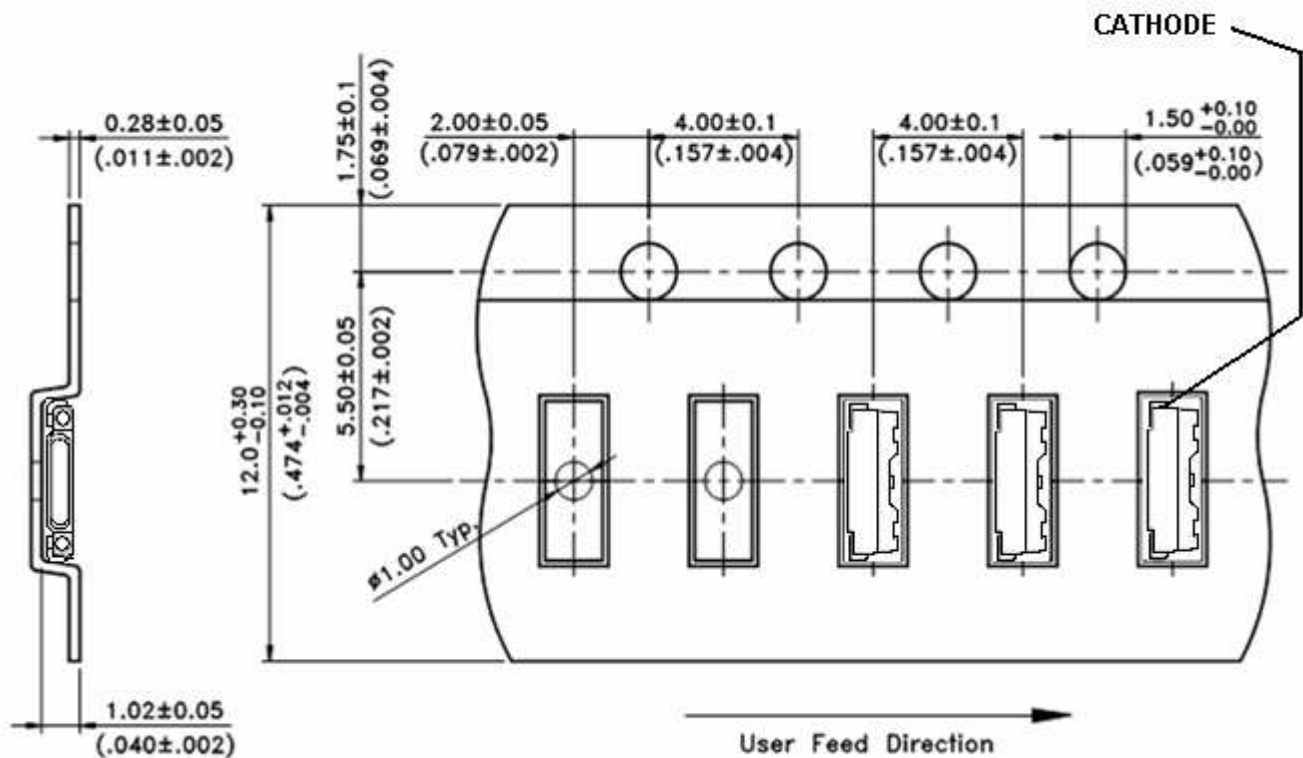

Property of Lite-On Only

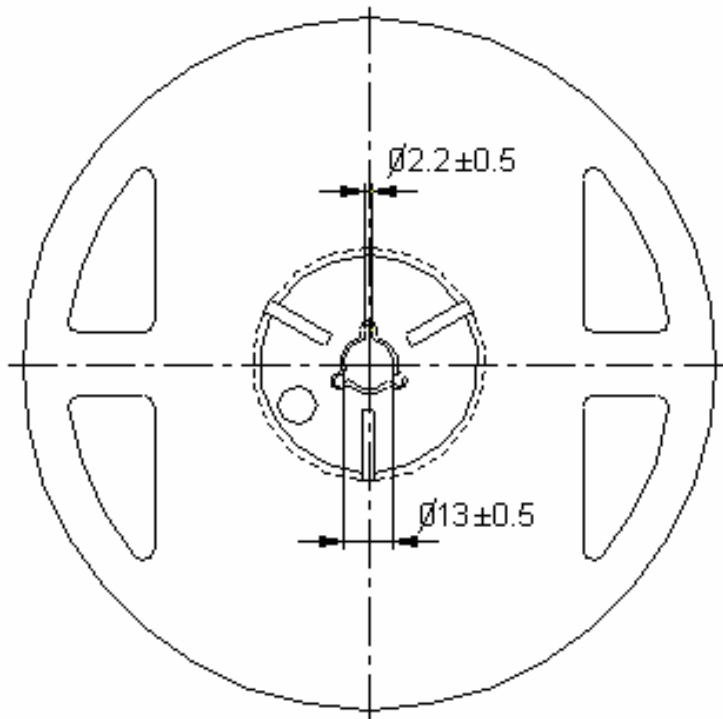
**Package Dimensions of Reel**

Note: 01. The tolerance unless mentioned is  $\pm 0.1$  mm  
02. The measured unit is "mm"

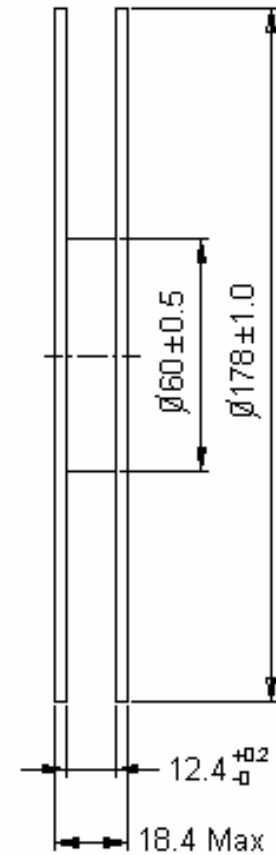

## Notes:

1. Empty component pockets sealed with top cover tape.
2. 7 inch reel-2000 pieces per reel.
3. The maximum number of consecutive missing lamps is two.
4. In accordance with EIA-481-1-B specifications.
5. Vacate 20 cm (min) on start of packing tape and vacate 50 cm (min) on last of packing tape.

## CAUTIONS

### 1. Application

The LEDs described here are intended to be used for ordinary electronic equipment (such as office equipment, communication equipment and household applications). Consult Liteon's Sales in advance for information on applications in which exceptional reliability is required, particularly when the failure or malfunction of the LEDs may directly jeopardize life or health (such as in aviation, transportation, traffic control equipment, medical and life support systems and safety devices).

### 2. Storage

The storage ambient for the LEDs should not exceed 85°C temperature or 60% relative humidity.

It is recommended that LEDs out of their original packaging are IR-reflowed within one week.

For extended storage out of their original packaging, it is recommended that the LEDs be stored in a sealed container with appropriate desiccant, or in a desiccators with nitrogen ambient.

LEDs stored out of their original packaging for more than a week should be baked at about 60 deg C for at least 24 hours before solder assembly.

### 3. Cleaning

Use alcohol-based cleaning solvents such as isopropyl alcohol to clean the LED if necessary.

### 4. Soldering

Recommended soldering conditions:

Reflow soldering		Soldering iron	
Pre-heat	120~150°C	Temperature	300°C Max.
Pre-heat time	120 sec. Max.	Soldering time	3 sec. Max.
Peak temperature	260°C Max.		(one time only)
Soldering time	30 sec. Max.		

### 5. Drive Method

An LED is a current-operated device. In order to ensure intensity uniformity on multiple LEDs connected in parallel in an application, it is recommended that a current limiting resistor be incorporated in the drive circuit, in series with each LED as shown in Circuit A below.

**Circuit model A**

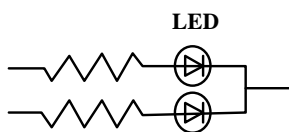

(A) Recommended circuit.

**Circuit model B**

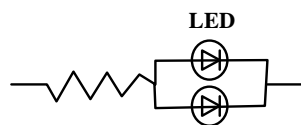

(B) The brightness of each LED might appear different due to the differences in the I-V characteristics of those LEDs.

### 6. ESD (Electrostatic Discharge)

Static Electricity or power surge will damage the LED.

Suggestions to prevent ESD damage:

- Use of a conductive wrist band or anti-electrostatic glove when handling these LEDs.
- All devices, equipment, and machinery must be properly grounded.
- Work tables, storage racks, etc. should be properly grounded.
- Use ion blower to neutralize the static charge which might have built up on surface of the LED's plastic lens as a result of friction between LEDs during storage and handling.



## Property of Lite-On Only

ESD-damaged LEDs will exhibit abnormal characteristics such as high reverse leakage current, low forward voltage, or “ no lightup ” at low currents.

To verify for ESD damage, check for “ lightup ” and Vf of the suspect LEDs at low currents.

The Vf of “ good ” LEDs should be  $>2.0V@0.1mA$  for InGaN product

### 7.1 Reliability Test

Test Item	Test Condition	Reference Standard	Note	Number of Damaged
Steady State Operating Life Condition	Ta= 25 °C, IF=20mA	1000 hrs	0/25	0
High Temperature Storage	Ta= 105 °C	1000 hrs	0/25	0
Low Temperature Storage	Ta= -55 °C	1000 hrs	0/25	0
Temperature Humidity Storage	Ta= 65 °C, RH= 90%	1000 hrs	0/25	0
Thermal Cycle	-55 °C ~25 °C ~105 °C~ 25 °C 30min 5min 30min 5min	100 cycles	0/25	0
Thermal Shock	-40 °C ~ 85 °C 10min 10min	100 cycles	0/25	0
Solder Resistance	Tsld=260+/- 5°C, 10sec (Lead Free Solder Profile)	1 time	0/25	0
IR-REFLOW	Tsld=250+/- 5°C, 20~40sec (Lead Free Solder Profile)	3 time	0/25	0

### 7.2 Criteria for Judging the Damage

Item	Symbol	Test Conditions	Criteria for Judgment	
			Min.	Max.
Forward Voltage	VF	IF=20mA	-	U.S.L.*) $\times$ 1.1
Reverse Current	IR	VR=5V	-	U.S.L.*) $\times$ 2.0
Luminous Intensity	IV	IF=20mA	U.S.L.***) $\times$ 0.7	-

**8. Others**

The appearance and specifications of the product may be modified for improvement without prior notice.

**9. Suggested Checking List**

## Training and Certification

1. Everyone working in a static-safe area is ESD-certified?
2. Training records kept and re-certification dates monitored?

## Static-Safe Workstation &amp; Work Areas

1. Static-safe workstation or work-areas have ESD signs?
2. All surfaces and objects at all static-safe workstation and within 1 ft measure less than 100V?
3. All ionizer activated, positioned towards the units?
4. Each work surface mats grounding is good?

## Personnel Grounding

1. Every person (including visitors) handling ESD sensitive (ESDS) items wear wrist strap, heel strap or conductive shoes with conductive flooring?
2. If conductive footwear used, conductive flooring also present where operator stand or walk?
3. Garments, hairs or anything closer than 1 ft to ESD items measure less than 100V\*?
4. Every wrist strap or heel strap/conductive shoes checked daily and result recorded for all DLs?
5. All wrist strap or heel strap checkers calibration up to date?

Note: \*50V for Blue LED.

## Device Handling

1. Every ESDS items identified by EIA-471 labels on item or packaging?
2. All ESDS items completely inside properly closed static-shielding containers when not at static-safe workstation?
3. No static charge generators (e.g. plastics) inside shielding containers with ESDS items?
4. All flexible conductive and dissipative package materials inspected before reuse or recycle?

## Others

1. Audit result reported to entity ESD control coordinator?
2. Corrective action from previous audits completed?
3. Are audit records complete and on file?

# Mouser Electronics

Authorized Distributor

Click to View Pricing, Inventory, Delivery & Lifecycle Information:

[Lite-On:](#)

[LTST-020QRL](#)

Компания «Океан Электроники» предлагает заключение долгосрочных отношений при поставках импортных электронных компонентов на взаимовыгодных условиях!

Наши преимущества:

- Поставка оригинальных импортных электронных компонентов напрямую с производств Америки, Европы и Азии, а так же с крупнейших складов мира;
- Широкая линейка поставок активных и пассивных импортных электронных компонентов (более 30 млн. наименований);
- Поставка сложных, дефицитных, либо снятых с производства позиций;
- Оперативные сроки поставки под заказ (от 5 рабочих дней);
- Экспресс доставка в любую точку России;
- Помощь Конструкторского Отдела и консультации квалифицированных инженеров;
- Техническая поддержка проекта, помощь в подборе аналогов, поставка прототипов;
- Поставка электронных компонентов под контролем ВП;
- Система менеджмента качества сертифицирована по Международному стандарту ISO 9001;
- При необходимости вся продукция военного и аэрокосмического назначения проходит испытания и сертификацию в лаборатории (по согласованию с заказчиком);
- Поставка специализированных компонентов военного и аэрокосмического уровня качества (Xilinx, Altera, Analog Devices, Intersil, Interpoint, Microsemi, Actel, Aeroflex, Peregrine, VPT, Syfer, Eurofarad, Texas Instruments, MS Kennedy, Miteq, Cobham, E2V, MA-COM, Hittite, Mini-Circuits, General Dynamics и др.);

Компания «Океан Электроники» является официальным дистрибьютором и эксклюзивным представителем в России одного из крупнейших производителей разъемов военного и аэрокосмического назначения «JONHON», а так же официальным дистрибьютором и эксклюзивным представителем в России производителя высокотехнологичных и надежных решений для передачи СВЧ сигналов «FORSTAR».



## JONHON

«JONHON» (основан в 1970 г.)

Разъемы специального, военного и аэрокосмического назначения:

(Применяются в военной, авиационной, аэрокосмической, морской, железнодорожной, горно- и нефтедобывающей отраслях промышленности)

«FORSTAR» (основан в 1998 г.)

ВЧ соединители, коаксиальные кабели, кабельные сборки и микроволновые компоненты:

(Применяются в телекоммуникациях гражданского и специального назначения, в средствах связи, РЛС, а так же военной, авиационной и аэрокосмической отраслях промышленности).



Телефон: 8 (812) 309-75-97 (многоканальный)

Факс: 8 (812) 320-03-32

Электронная почта: [ocean@oceanchips.ru](mailto:ocean@oceanchips.ru)

Web: <http://oceanchips.ru/>

Адрес: 198099, г. Санкт-Петербург, ул. Калинина, д. 2, корп. 4, лит. А