



DEUTSCH

BRANCHE CONNECTEURS AEROMILITAIRES



***ACT series*** Normes MIL-DTL 38999 Série III

Composite

1	Introduction
2	Synoptic
3	Technical characteristics
4	Part-numbering system
5	Arrangements
6	Receptacles
7	Plug / Panel seal
8	Mating and unmating dimensions
9	Mounting cutouts
10-11	Contacts and Tools

The Deutsch ACT is a high performance composite connector qualified to MIL-DTL-38999. What Deutsch Defense/Aerospace does better than anyone else is make wire termination devices for demanding applications.

Deutsch utilized its unprecedented achievements in the area of defense/aerospace composite technology enabling us to design and produce the latest version of MIL-DTL-38999 connectors.

The superior design of the ACT deliberately took into consideration the connector, its contacts, and the respective strain reliefs to favorably influence intra-system life-cycle performance and costs.

## ■ Performance

The total performance of the ACT connector is matched by individual components within the system. For example, the use of composite materials has increased the durability of the connector housing and coupling mechanism to 1500 cycles. Deutsch developed an extended life MIL-C-39029 contact to meet the increased performance requirements of today's systems.

## ■ Superior corrosion resistance

The ACT eliminates the largest contributing factor in advanced systems malfunction... corrosion, which is the main cause of mechanical, electrical, and electromagnetic connector degradation. Electromotive force differentials between many dissimilar metals found in connectors and accessories produce galvanic action. The ACT eliminates these dissimilar metals resulting in an interconnection system that withstands over 2000 hours of salt spray.

SEALED receptacles

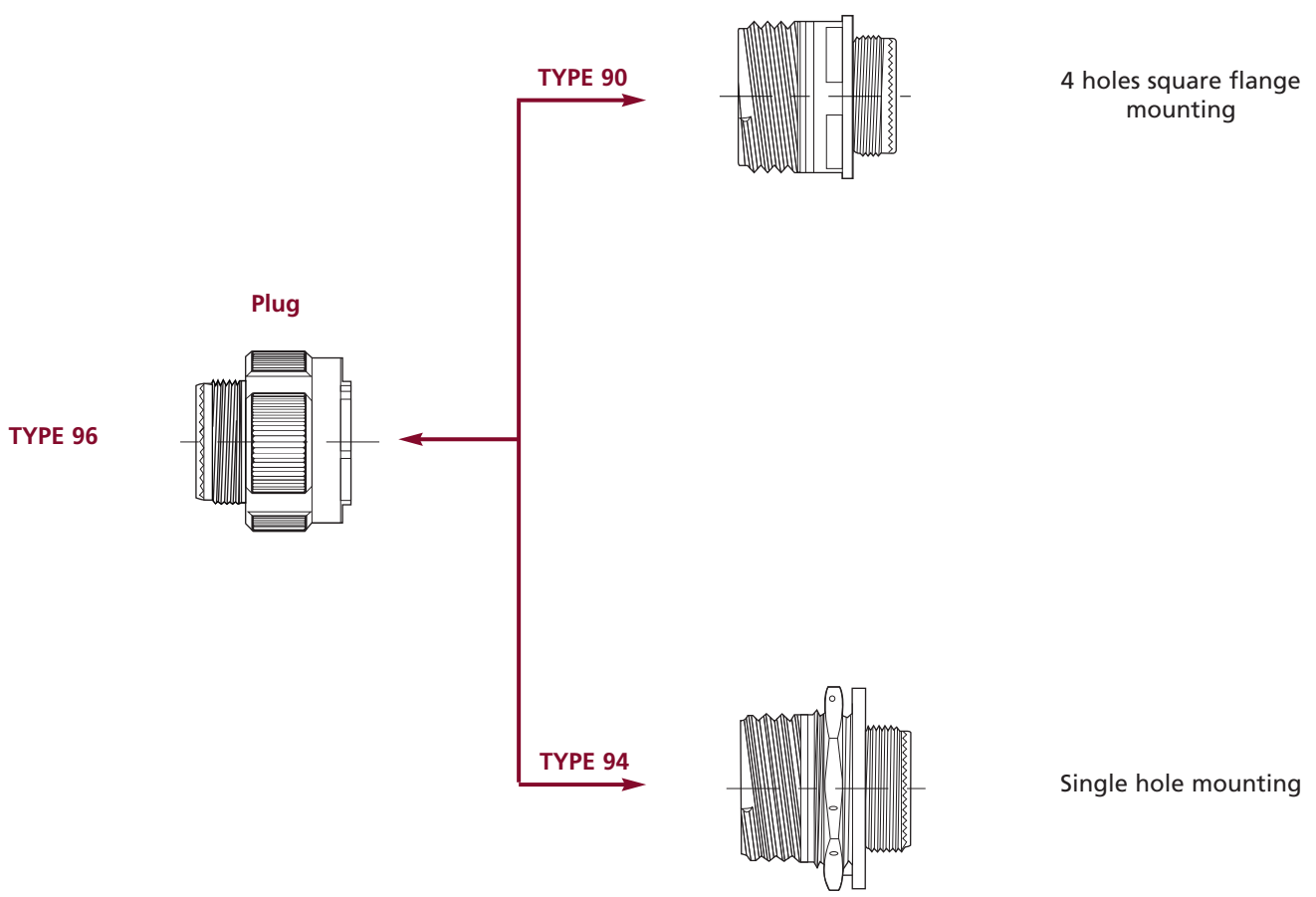

## Mechanical

Shell	Material	: Composite
	Plating	: W - Olive drab cadmium, M - Nickel coating
Insert	Material	: Thermoplastic and fluorinated silicone elastomer
Flat gasket and o'ring	Material	: fluoronited silicone elastomer
Contact	Material	: Copper alloy
	Plating	: Gold
	Type	: Crimp type or printed circuit pin (consult us)
Retention		: Size 22 D: 44 N Size 20 : 67 N Size 16 : 111 N Size 12 : 111 N Size 8 : 111 N
Vibrations		: As per MIL-DTL-38999
Physical shocks		: 300 g, 3 ms in the 3 axes
Durability		: 1500 coupling and uncoupling cycles

## Climatics

Service temperature		: Cadmium plating - 65° C to + 175° C : Nickel plating - 65° C to + 200° c
Thermal shocks		: As per MIL-DTL-38999
Sealing		: Leakage ≤ 16 cm <sup>3</sup> /h on mated connecting under 2,1 bars
Salt spray resistance		: 2000 hours, class W as per MIL-DTL-38999 2000 hours class M, as per MIL-DTL-38999

## Electrical

Withstanding voltage	at sea level	: Service M : 1300 V Service I : 1800 V Service II : 2300 V
	at 21000 m altitude	: Mated connector      Unmated connector Service M : 800 V      Service M : 350 V Service I : 1000 V      Service I : 400 V Service II : 1000 V      Service II : 500 V
Insulation resistance (Ambiant temperature)		: 5000 MΩ to 25° C and 65 % HR max.
Voltage drop		: size 22 : test to 5 Amp. = 73 millivolts max. Size 20 : test to 7,5 Amp. = 55 millivolts max. Size 16 : test to 12 Amp. = 49 millivolts max. Size 12 : test to 23 Amp. = 42 millivolts max. Size 8 : test to 46 Amp. = 26 millivolts max.
Shielding		: As per MIL-DTL-38999

Size	Contacts current Sealed version	Diameter over Insulation sheath in mm	Permitted wire Sizes section in mm <sup>2</sup>
22	5 A	0,76 to 1,37	0,095 to 0,38
20	7,5 A	1,01 to 2,10	0,21 to 0,60
16	13 A.	1,65 to 2,77	0,60 to 1,34
12	23 A.	2,46 to 3,61	1,91 to 3,18
8	46 A.	4,50 to 5,80	5,30 to 8,98

For more information, see MIL-DTL-38999 series III

## DEUTSCH System

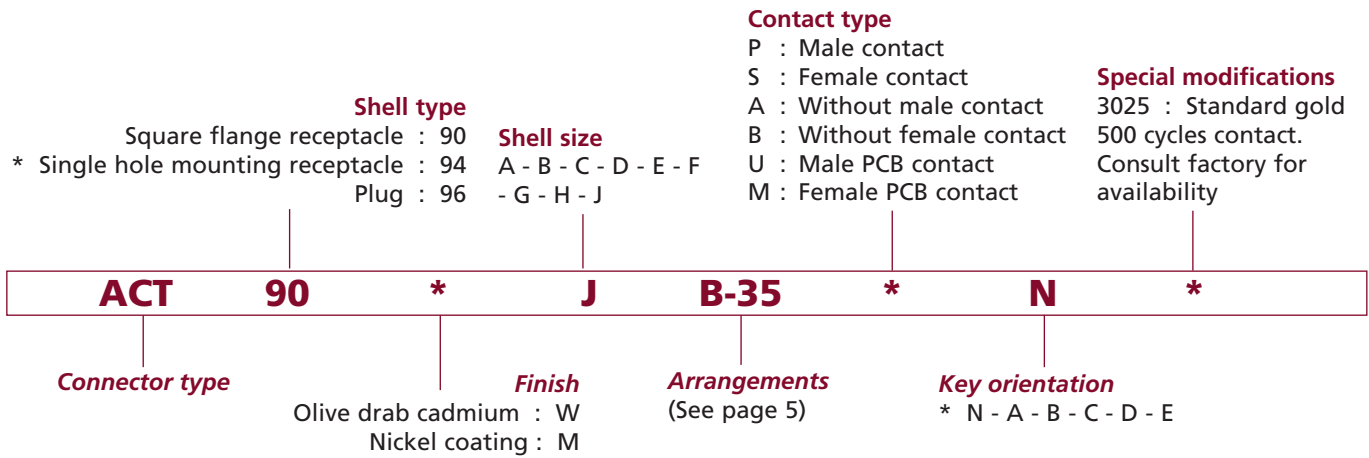





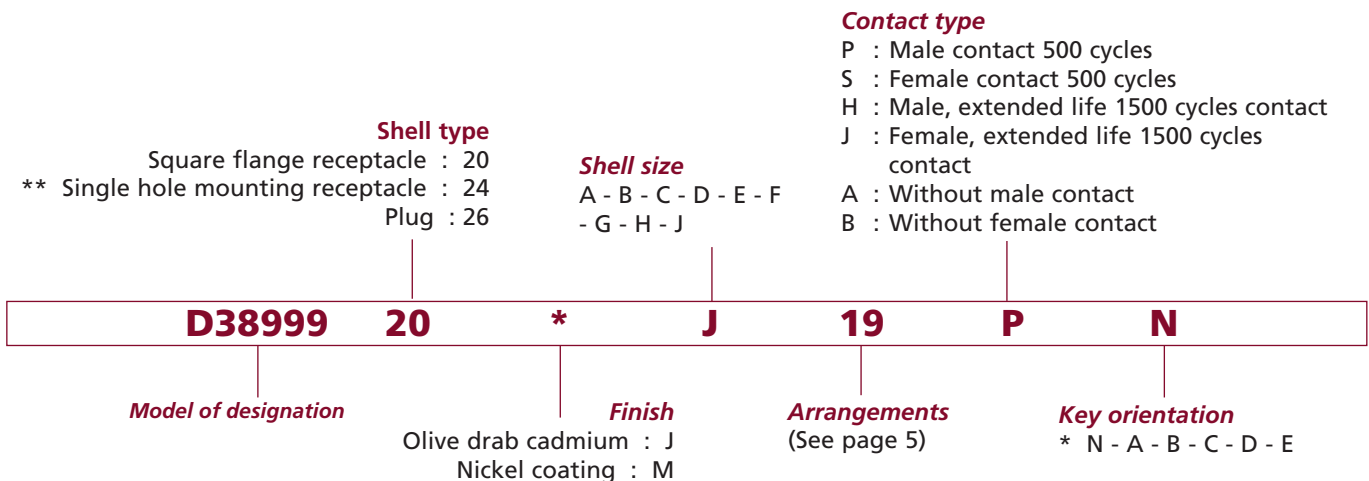































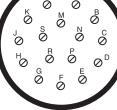



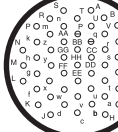

The square flange receptacle is never delivered with panel seal. For ordering panel seals see page 9.  
For standard contacts delivered with the connector, see page 10.

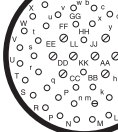
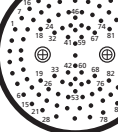
## MIL-DTL-38999 SYSTEM

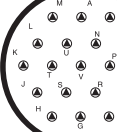

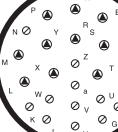
\* Consult factory for availability  
\*\* Consult factory for current QPL listing.

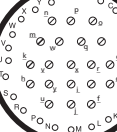
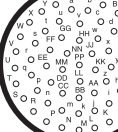
Male insert viewed from front face.

 <b>Disposition A-35</b> 6 contacts size 22	 <b>Disposition A-98</b> 3 contacts size 20	 <b>Disposition B-02</b> 2 contacts size 16	 <b>Disposition B-05</b> 5 contacts size 20	 <b>Disposition B-35</b> 13 contacts size 22	 <b>Disposition B-98</b> 6 contacts size 20	 <b>Disposition B-99</b> 7 contacts size 20	 <b>Disposition C-04</b> 4 contacts size 16
 <b>Disposition C-08</b> 8 contacts size 20	 <b>Disposition C-35</b> 22 contacts size 22	 <b>Disposition C-98</b> 10 contacts size 20	 <b>Disposition D-05</b> 5 contacts size 16	 <b>Disposition D-15</b> 14 contacts size 20 1 contacts size 16	 <b>Disposition D-18</b> 18 contacts size 20	 <b>Disposition D-19</b> 19 contacts size 20	 <b>Disposition D-35</b> 37 contacts size 22
 <b>Disposition D-97</b> 8 contacts size 20 4 contacts size 16	 <b>Disposition E-02</b> 38 contacts size 22 1 contacts size 8	 <b>Disposition E-06</b> 6 contacts size 12	 <b>Disposition E-08</b> 8 contacts size 16	 <b>Disposition E-26</b> 26 contacts size 20	 <b>Disposition E-35</b> 55 contacts size 22	 <b>Disposition E-99</b> 21 contacts size 20 2 contacts size 16	 <b>Disposition F-11</b> 11 contacts size 16
 <b>Disposition F-32</b> 32 contacts size 20	 <b>Disposition F-35</b> 66 contacts size 22	 <b>Disposition G-11</b> 11 contacts size 12	 <b>Disposition G-16</b> 16 contacts size 16	 <b>Disposition G-35</b> 79 contacts size 22	 <b>Disposition G-39</b> 2 contacts size 16 37 contacts size 20	 <b>Disposition G-41</b> 41 contacts size 20	 <b>Disposition G-75</b> 4 contacts size 8
 <b>Disposition H-21</b> 21 contacts size 16	 <b>Disposition H-35</b> 100 contacts size 22	 <b>Disposition H-53</b> 53 contacts size 20	 <b>Disposition H-55</b> 55 contacts size 20	 <b>Disposition J-04</b> 48 contacts size 20 8 contacts size 16	 <b>Disposition J-7</b> 97 contacts size 22 2 contacts size 8	 <b>Disposition J-8</b> 8 contacts size 8	
 <b>Disposition J-19</b> 19 contacts size 12	 <b>Disposition J-20*</b> 10 contacts size 20 13 contacts size 16 4 contacts size 12 3 contacts size 8	 <b>Disposition J-24</b> 12 contacts size 16 12 contacts size 12	 <b>Disposition J-29</b> 29 contacts size 16	 <b>Disposition J-35</b> 128 contacts size 22	 <b>Disposition J-43</b> 23 contacts size 20 20 contacts size 16	 <b>Disposition J-61</b> 61 contacts size 20	
 <b>Disposition J-90</b> 40 contacts size 20 4 contacts size 16 2 contacts size 8	<p>* Sold less contacts tools, and sealing plugs Arrangements is not currently a MIL-DTL-38999 specification, please refer to MIL-STD-1560</p>						

■ **Square flange - TYPE 90**

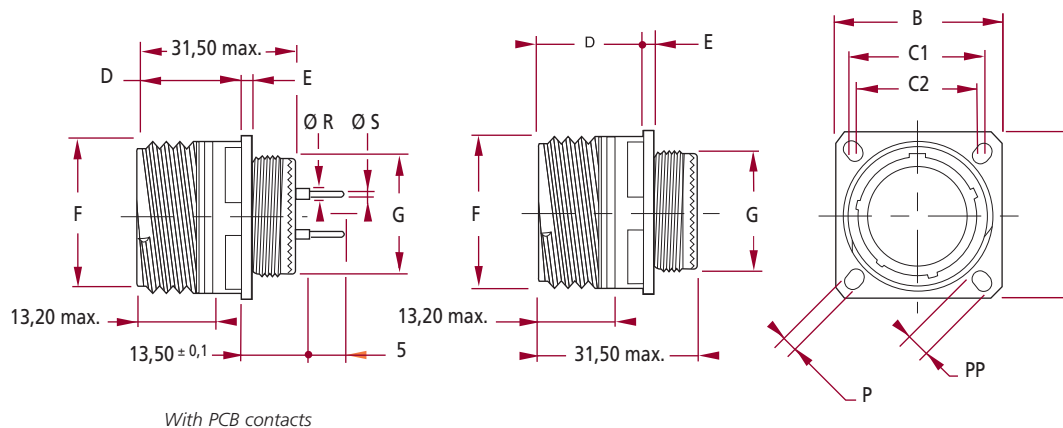

With PCB contacts

Contact Size	R	S
22	+0 -0,05	$\pm 0,05$
20	1,5	0,7
16	2,6	1,15

P/N PCB contacts, page 11

Size	B	C1	C2	D	E	F	G	P	PP	Mass
	$\pm 0,3$			$\text{max.}$		$\pm 0,1$	$\pm 0,1$	$\pm 0,2$	$\pm 0,2$	$\text{max.}$
A	23,80	18,26	15,09	19,50	3,65	15,75	11,90	3,25	5,49	8,00
B	26,20	20,62	18,26	19,50	3,65	18,90	14,90	3,25	4,93	11,00
C	28,60	23,01	20,62	19,50	3,65	22,10	17,90	3,25	4,93	14,00
D	31,00	24,61	23,01	19,50	3,65	25,25	21,90	3,25	4,93	18,00
E	33,30	26,97	24,61	19,50	3,65	29,95	24,90	3,25	4,93	23,00
F	36,50	29,36	26,97	19,50	3,65	31,55	27,90	3,25	4,93	26,00
G	39,70	31,75	29,36	18,70	4,35	34,70	30,90	3,25	4,93	31,00
H	42,90	34,93	31,75	18,70	4,35	37,90	33,90	3,91	6,15	36,00
J	46,00	38,10	34,93	18,70	4,35	41,10	36,90	3,91	6,15	43,00

■ **Single hole mounting - TYPE 94**

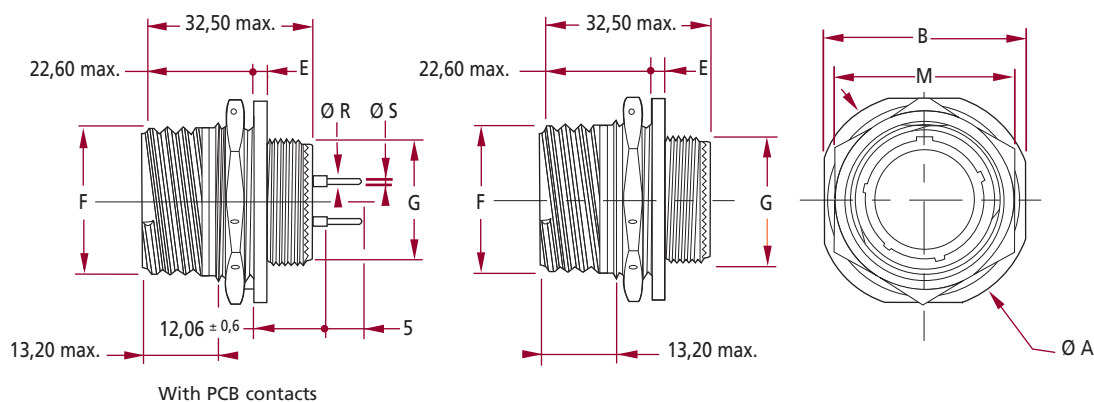

With PCB contacts

Contact Size	R	S
22	+0 -0,05	$\pm 0,05$
20	1,5	0,7
16	2,6	1,15

P/N PCB contacts, page 11

Size	A	B	E	F	G	M	Mass
	$\pm 0,3$	$\pm 0,4$	+0,7 -0,1	$\pm 0,1$	$\pm 0,1$		$\text{max.}$
A	30,20	27,00	3,00	15,75	11,90	21,82	11,00
B	34,90	31,80	3,00	18,90	14,90	24,99	14,00
C	38,10	34,90	3,00	22,10	17,90	29,77	18,00
D	41,30	38,10	3,00	25,25	21,90	32,91	23,00
E	44,50	41,30	3,00	29,95	24,90	36,12	29,00
F	49,20	46,00	3,70	31,55	27,90	39,25	35,00
G	52,40	49,20	3,70	34,70	30,90	42,47	38,00
H	55,60	52,40	3,70	37,90	33,90	45,61	46,00
J	58,70	55,60	3,70	41,10	36,90	49,25	55,00



■ **TYPE 96**

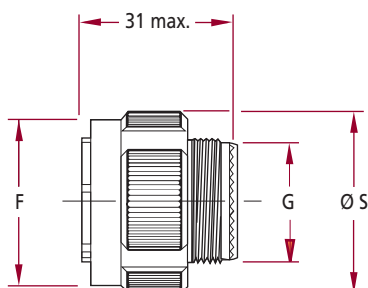

Size	F max.	G max.	S max.	Mass max.
A	18,40	11,90	21,80	9,00
B	21,10	14,90	25,00	13,00
C	25,40	17,90	29,40	18,00
D	28,70	21,90	32,50	23,00
E	32,20	24,90	35,70	25,00
F	34,90	27,90	38,50	32,00
G	38,10	30,90	41,70	35,00
H	41,10	33,90	44,90	41,00
J	44,30	36,90	48,00	48,00

Panel seal

■ **For square flange receptacle**

Sealed version

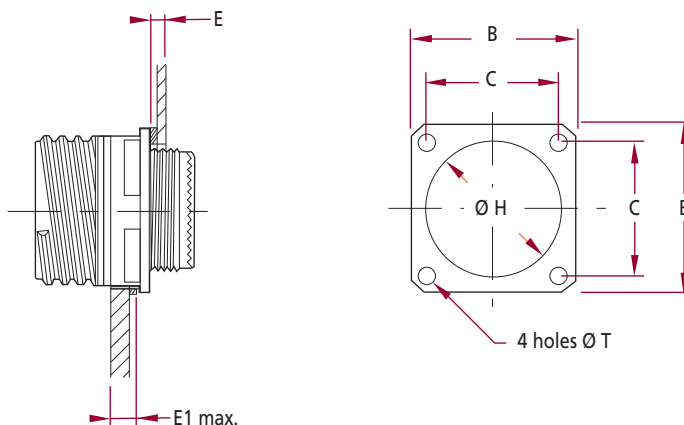

Front flange mounting							Rear flange mounting			
Size	Part-Number	H max.	B max.	C ± 0,10	E max.	E1 max.	T max.	H max.	Part-Number	Size
A	108-0003-10	15,40	24,30	18,30	3,00	5,92	3,30	14,10	108-0004-10	A
B	108-0001-12	18,40	26,70	20,60	3,00	5,92	3,30	17,20	108-0004-12	B
C	108-0001-14	22,70	29,10	23,00	3,00	5,92	3,30	20,40	108-0004-14	C
D	108-0001-16	25,90	31,30	24,60	3,00	5,92	3,30	23,60	108-0004-16	D
E	108-0003-18	29,10	33,70	27,00	3,00	5,92	3,30	26,80	108-0004-18	E
F	108-0003-20	32,30	36,90	29,40	3,00	5,92	3,30	30,60	108-0001-20	F
G	108-0003-22	35,40	40,10	31,75	3,00	5,16	3,30	33,50	108-0001-22	G
H	108-0003-24	38,60	43,30	34,90	3,00	5,16	4,30	36,30	108-0004-24	H
J	108-0001-25	41,10	46,00	38,10	3,00	4,87	3,90	37,70	108-0012-25	J

Nota : The panel seal is never delivered with receptacle. To be ordered separately.

## ■ Square flange - TYPES 90 - 96

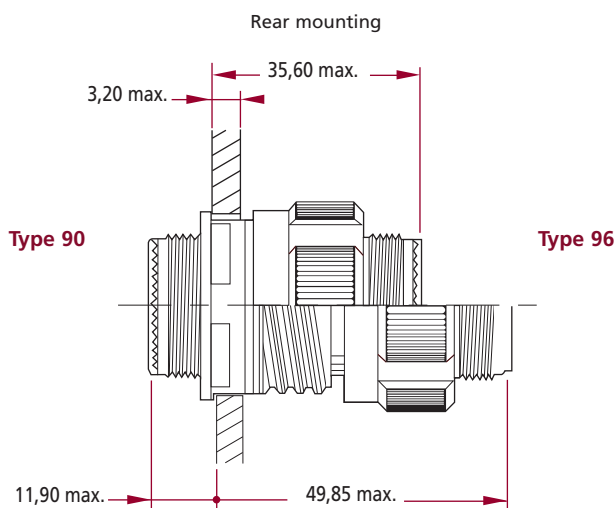
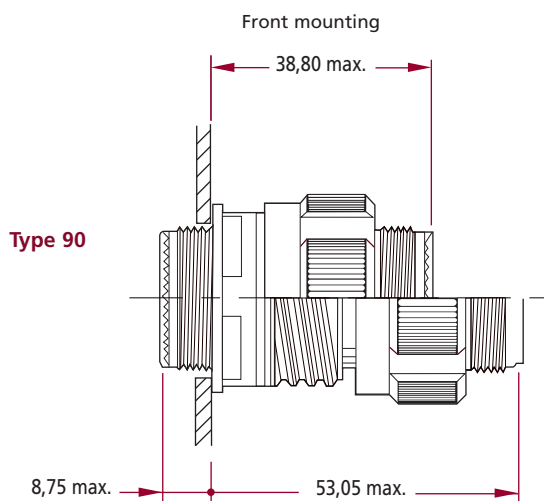

Size	Coupling torque	
	Mating Nm mini	Unmating Nm max.
A	0,2	0,9
B	0,2	1,4
C	0,2	1,8
D	0,3	2,3
E	0,3	2,7
F	0,3	3,2
G	0,6	3,6
H	0,6	4,1
J	0,6	4,6

## ■ TYPE 94 - 96

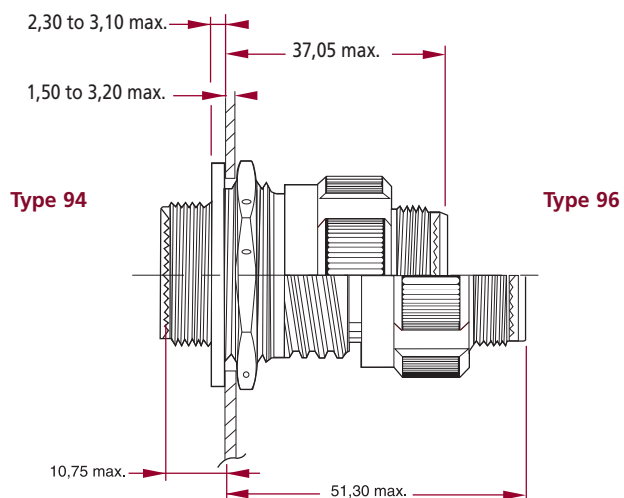

Size	Coupling torque	
	Mating Nm mini	Unmating Nm max.
A	0,2	0,9
B	0,2	1,4
C	0,2	1,8
D	0,3	2,3
E	0,3	2,7
F	0,3	3,2
G	0,6	3,6
H	0,6	4,1
J	0,6	4,6

## ■ For sealed receptacles - TYPE 90 - 94

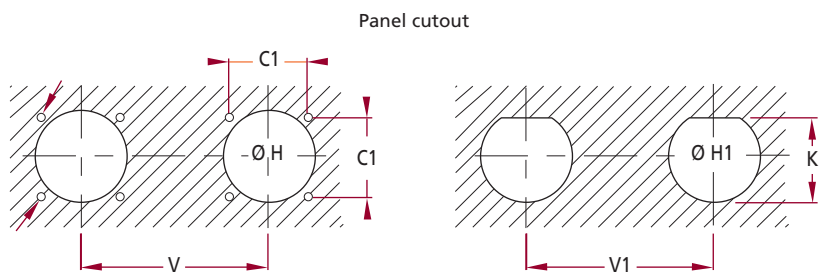
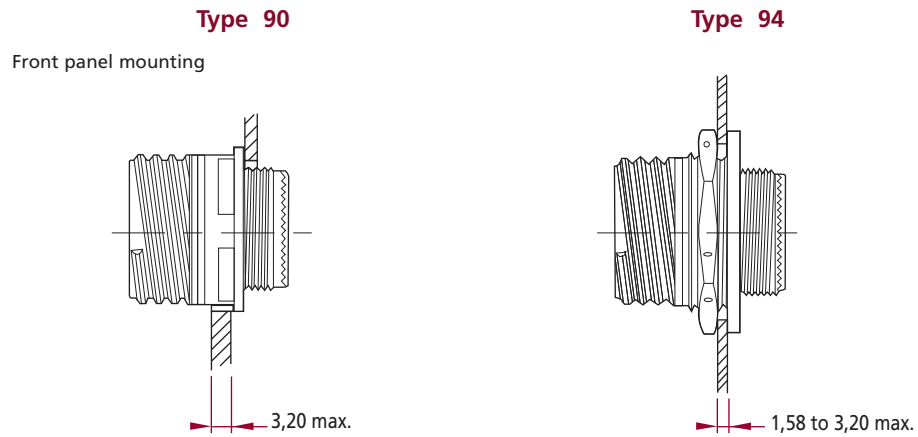

Size	C1	H mini		H1	K	V mini.	V1 mini.	Coupling torque	
		Front	Rear					Nm mini	Nm ma
A	18,26	13,11	16,66	17,70	16,99	24,60	27,80	3,40	4,00
B	20,62	15,08	22,22	20,88	19,53	27,00	32,60	4,50	5,20
C	23,01	19,05	23,42	25,58	24,26	30,20	36,00	6,20	6,80
D	24,61	23,01	26,59	28,80	27,53	33,30	39,60	7,90	8,50
E	26,97	25,81	30,96	31,98	30,68	36,50	43,30	9,00	9,60
F	29,36	28,98	32,94	35,15	33,86	39,30	47,00	10,20	10,70
G	31,75	32,16	36,12	38,28	37,06	42,50	50,60	11,30	12,40
H	34,93	34,93	39,29	41,50	40,01	45,70	54,20	12,40	13,50
J	38,10	37,69	42,47	44,68	43,41	48,80	59,70	13,60	14,70

## Standard gold 500 cycles contact (3025)

color code  
For contact P as per MIL-DTL 38999

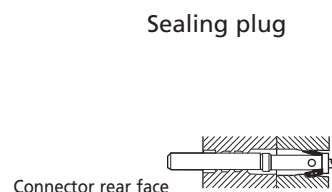
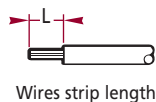
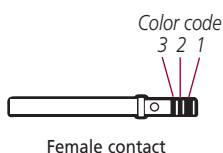
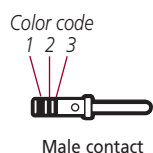

CONTACTS							CABLES			SEALING PLUG		
Commercial Part-number	Type	Size	Color code			Observations	Section mm <sup>2</sup>	AWG wire	Ø over sheath	L	P/N	Color code
			1	2	3							
724-0001-22	P	22	Orange	Blue	Black	Standard contact	0,10 to 0,38	22 - 28	0,76 to 1,37	5,00 to 5,80	028-0102-22	Yellow
724-0007-22	S	22	Orange	Yellow	Grey	Standard contact						
724-0001-20	P	20	Orange	Blue	Orange	Standard contact	0,21 to 0,60	20 - 24	1,02 to 2,11	5,80 to 6,60	006-0893-20	Red
724-0007-20	S	20	Orange	Green	Brown	Standard contact						
724-0001-16	P	16	Orange	Blue	Yellow	Standard contact	0,60 to 1,34	16 - 20	1,65 to 2,77	5,80 to 6,60	006-0893-16	Bleu
724-0007-16	S	16	Orange	Green	Red	Standard contact						
724-0001-12	P	12	Orange	Blue	Green	Standard contact	1,93 to 3,18	12 - 14	2,46 to 3,61	5,80 to 6,60	006-0892-12	Yellow
724-0007-12	S	12	Orange	Green	Orange	Standard contact						
182-0001-08	P	8	-	-	-	Power contact	5,30 to 8,98	8	4,50 to 5,80	9,20 to 9,80	182-0061-08	-
182-0003-08	S	8	-	-	-	Power contact						
182-0068-20	P	20	Yellow	Purple	Green	Alumel contact	0,21 to 0,60	20 - 24	1,02 to 2,11	5,80 to 6,60	006-0893-20	Red
182-0009-20	S	20	Yellow	Grey	Purple	Alumel contact						
182-0069-20	P	20	Yellow	Purple	Blue	Chromel contact	0,21 to 0,60	20 - 24	1,02 to 2,11	5,80 to 6,60	006-0893-20	Red
182-0010-20	S	20	Yellow	Grey	Grey	Chromel contact						
182-0068-22	P	22	Yellow	Purple	Brown	Alumel contact	0,10 to 0,38	22 - 28	0,76 to 1,37	5,00 to 5,80	028-0102-22	Yellow
182-0009-22	S	22	Yellow	White	Green	Alumel contact						
182-0069-22	P	22	Yellow	Purple	Red	Chromel contact	0,10 to 0,38	22 - 28	0,76 to 1,37	5,00 to 5,80	028-0102-22	Yellow
182-0010-22	S	22	Yellow	White	Blue	Chromel contact						

DATABUS CONTACTS SIZE 8 (TWISTED PAIR) AS PER MIL-C 38999 SERIES I, III AND IV STANDARD										
CONTACTS				CABLES			SLEEVE	TOOLS		
Part-number	Type	Size	Color code	Types	Conduct. max. section	Braid Ø max.	Types	Crimping tool Conductor	Ferrule	Tool Extraction
182-0034-03	P	8	Brown-red	braid simple	0,86 mm <sup>2</sup>	3,48	Thermosetting and silicone	TDB-CT-08	TDB-CT-HEX Mark C	114-008 or M 81969/14-06
182-0035-03	S	8	Brown-red	braid simple	0,86 mm <sup>2</sup>	3,48	Thermosetting and silicone	TDB-CT-08	TDB-CT-HEX Mark C	114-008 or M 81969/14-06
182-0034-04	P	8	Red-red	Hight immunity double braid	0,86 mm <sup>2</sup>	3,91	Thermosetting and silicone	TDB-CT-08	TDB-CT-HEX Mark D	114-008 or M 81969/14-06
182-0035-04	S	8	Red-red	Hight immunity double braid	0,86 mm <sup>2</sup>	3,91	Thermosetting and silicone	TDB-CT-08	TDB-CT-HEX Mark D	114-008 or M 81969/14-06

Nota : Standard contacts delivered with connector.  
Size 8 and Bus contacts are delivered with protect sleeve.

## Contact 1500 cycles contact

DEUTSCH EXTENDED LIFE FINISH						
Part number	Type	Size	Color code			
			1	2	3	
M39029/107-620	P	22	Blue	Red	Black	
M39029/106-614	S	22	Blue	Brown	Yellow	
M39029/107-621	P	20	Blue	Red	Brown	
M39029/106-615	S	20	Blue	Brown	Green	
M39029/107-622	P	16	Blue	Red	Red	
M39029/106-616	S	16	Blue	Brown	Blue	
M39029/107-623	P	12	Blue	Red	Orange	
M39029/106-617	S	12	Blue	Brown	Violet	

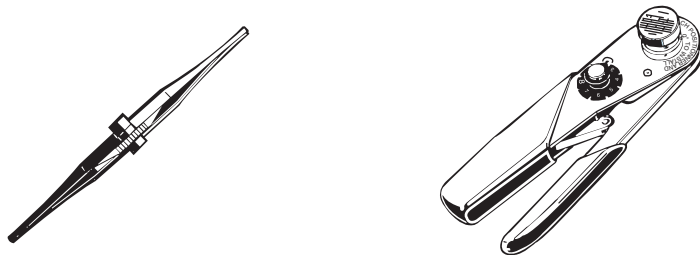

TOOLS				CONTACTS STANDARDISATION
Insertion	Tool Extraction	Crimping tool	Pilot stop for crimping tool	MIL-C
M 81969/14-01		M 22520/2-01	M 22520/2-09 M 22520/2-07	MIL-C 39029/58-360 MIL-C 39029/56-348
M 15570-20		M 22520/1-01	M 22520/1-04	MIL-C 39029/58-363 MIL-C 39029/56-351
M 15570-16		M 22520/1-01	M 22520/1-04	MIL-C 39029/58-364 MIL-C 39029/56-352
M 15570-12		M 22520/1-01	M 22520/1-04	MIL-C 39029/58-365 MIL-C 39029/56-353
Manual	M 81969/14-06	M 22520/5-01	SP 593	-
M 15570-20		M 22520/1-01	M 22520/1-04	MIL-C 39029/87-475 MIL-C 39029/88-487
M 15570-20		M 22520/1-01	M 22520/1-04	MIL-C 39029/87-476 MIL-C 39029/88-488
M 81969/14-01		M 22520/2-01	M 22520/2-09 M 22520/2-07	MIL-C 39029/87-471 MIL-C 39029/89-495
M 81969/14-01		M 22520/2-01	M 22520/2-09 M 22520/2-07	MIL-C 39029/87-472 MIL-C 39029/89-496

PCB Contacts		
Part-number	Type	Size
724-0902-22	P	22
724-0902-20		20
724-0902-16		16
724-0902-12		12
724-0904-22	S	22
724-0904-20		20
724-0904-16		16
724-0904-12		12

COAXIAL Contacts				
Part-number	Type	Size	MIL-C 39029	
724-0004-16	P	16	76	77
182-0013-16	S		102	103
182-0100-12	P	8	59	60
182-0101-12	S		59	60
182-0127-68	P		59	60
182-0128-68	S	8	59	60

SHIELDED CONTACTS				
Part-number	Type	Size	MIL-C 39029	
182-0098-12	P	12	28	52
182-0099-12	S		28	52





CONNECTEURS ELECTRIQUES DEUTSCH

17, rue Lavoisier z.i. n° 2 B.P. 117 27091 EVREUX CEDEX 09 (FRANCE) - Tél.: +33 (0)2 32 23 57 00 - Fax : +33 (0)2 32 23 58 00  
E-mail : [ced@deutsch.net](mailto:ced@deutsch.net) - Web : [www.deutsch.net](http://www.deutsch.net) - Réf.: CC 024-21 A Edition Mars 2008

Компания «Океан Электроники» предлагает заключение долгосрочных отношений при поставках импортных электронных компонентов на взаимовыгодных условиях!

Наши преимущества:

- Поставка оригинальных импортных электронных компонентов напрямую с производств Америки, Европы и Азии, а так же с крупнейших складов мира;
- Широкая линейка поставок активных и пассивных импортных электронных компонентов (более 30 млн. наименований);
- Поставка сложных, дефицитных, либо снятых с производства позиций;
- Оперативные сроки поставки под заказ (от 5 рабочих дней);
- Экспресс доставка в любую точку России;
- Помощь Конструкторского Отдела и консультации квалифицированных инженеров;
- Техническая поддержка проекта, помощь в подборе аналогов, поставка прототипов;
- Поставка электронных компонентов под контролем ВП;
- Система менеджмента качества сертифицирована по Международному стандарту ISO 9001;
- При необходимости вся продукция военного и аэрокосмического назначения проходит испытания и сертификацию в лаборатории (по согласованию с заказчиком);
- Поставка специализированных компонентов военного и аэрокосмического уровня качества (Xilinx, Altera, Analog Devices, Intersil, Interpoint, Microsemi, Actel, Aeroflex, Peregrine, VPT, Syfer, Eurofarad, Texas Instruments, MS Kennedy, Miteq, Cobham, E2V, MA-COM, Hittite, Mini-Circuits, General Dynamics и др.);

Компания «Океан Электроники» является официальным дистрибьютором и эксклюзивным представителем в России одного из крупнейших производителей разъемов военного и аэрокосмического назначения «JONHON», а так же официальным дистрибьютором и эксклюзивным представителем в России производителя высокотехнологичных и надежных решений для передачи СВЧ сигналов «FORSTAR».



## JONHON

«JONHON» (основан в 1970 г.)

Разъемы специального, военного и аэрокосмического назначения:

(Применяются в военной, авиационной, аэрокосмической, морской, железнодорожной, горно- и нефтедобывающей отраслях промышленности)

«FORSTAR» (основан в 1998 г.)

ВЧ соединители, коаксиальные кабели, кабельные сборки и микроволновые компоненты:

(Применяются в телекоммуникациях гражданского и специального назначения, в средствах связи, РЛС, а так же военной, авиационной и аэрокосмической отраслях промышленности).



Телефон: 8 (812) 309-75-97 (многоканальный)

Факс: 8 (812) 320-03-32

Электронная почта: [ocean@oceanchips.ru](mailto:ocean@oceanchips.ru)

Web: <http://oceanchips.ru/>

Адрес: 198099, г. Санкт-Петербург, ул. Калинина, д. 2, корп. 4, лит. А