

# YNV05T10 DC-DC Converter

3.0 - 5.5 VDC Input; 0.7525 - 3.63 VDC  
Programmable @ 10 A

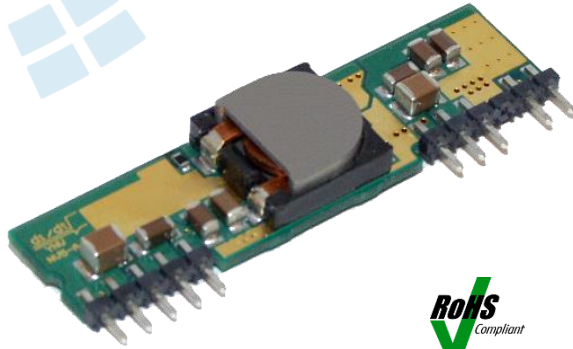

## Key Features & Benefits

- RoHS lead free solder and lead solder exempted products are available
- Delivers up to 10 A (36.3 W)
- No derating up to 85 °C
- Industry-standard footprint and pinout
- Single-in-Line Package (SIP): 2.0" x 0.575" x 0.28" (50.8 x 14.59 x 7.11 mm)
- Weight: 0.26 oz [7.28 g]
- Synchronous Buck Converter topology
- Start-up into pre-biased output
- No minimum load required
- Programmable output voltage via external resistor
- Operating ambient temperature: -40 °C to 85 °C
- Remote output sense
- Remote ON/OFF (positive or negative)
- Fixed-frequency operation
- Auto-reset output overcurrent protection
- Auto-reset overtemperature protection
- High reliability, MTBF = TBD million hours
- All materials meet UL94, V-0 flammability rating
- Approved to the latest edition and amendment of ITE Safety standards, UL/CSA 60950-1 and IEC60950-1

Bel Power Solutions point-of-load converters are recommended for use with regulated bus converters in an Intermediate Bus Architecture (IBA). The YNV05T10 non-isolated DC-DC converter delivers up to 10 A of output current in an industry-standard through-hole Single In-Line Package (SIP). Operating from a 3.0 – 5.5 V input, this converter is an ideal choice for Intermediate Bus Architectures where point-of-load power delivery is generally a requirement. The YNV05T10 provides an extremely tight regulated programmable output voltage from 0.7525 V to 3.63 V.

YNV05T10 converters provide exceptional thermal performance, even in high temperature environments with minimal airflow. No derating is needed up to 85 °C under natural convection conditions. This is accomplished through the use of circuitry, packaging, and processing techniques to achieve ultra-high efficiency and excellent thermal management, along with a very sleek body profile.

The sleek body profile and the preclusion of heat sinks minimize impedance to system airflow, thus enhancing cooling for both upstream and downstream devices. The use of 100% automation for assembly, coupled with advanced power electronics and thermal design, results in a product with extremely high reliability.

## Applications

- Intermediate Bus Architectures
- Telecommunications
- Data Communications
- Distributed Power Architectures
- Servers, Workstations

## Benefits

- High efficiency – no heat sink required
- Reduces Total Solution Board Area
- Minimizes Part Numbers in Inventory

### North America

+1-866.513.2839

### Asia-Pacific

+86.755.29885888

### Europe, Middle East

+353 61 225 977

tech.support@psbel.com  
[belpowersolutions.com](http://belpowersolutions.com)

# YNV05T10 DC-DC Converter

## Electrical Specifications

Conditions:  $T_A = 25\text{ }^\circ\text{C}$ , Airflow = 200 LFM (1 m/s),  $V_{in} = 5\text{ VDC}$ ,  $V_{out} = 0.7525 - 3.63\text{ V}$ , unless otherwise specified.

PARAMETER	NOTES	MIN	TYP	MAX	UNITS
<b>ABSOLUTE MAXIMUM RATINGS</b>					
Input Voltage	Continuous	-0.3		6	VDC
Operating Ambient Temperature		-40		85	$^\circ\text{C}$
Storage Temperature		-55		125	$^\circ\text{C}$
<b>FEATURE CHARACTERISTICS</b>					
Switching Frequency			300		kHz
Output Voltage Programming Range <sup>1</sup>	By external resistor, See Trim Table 1	0.7525		3.63	VDC
Remote Sense Compensation <sup>1</sup>				0.5	VDC
Turn-On Delay Time <sup>2</sup>	Full resistive load				
With $V_{in} = (\text{Converter Enabled, then } V_{in} \text{ applied})$	From $V_{in} = V_{in}(\text{min})$ to $V_o = 0.1 * V_o(\text{nom})$		3.5		ms
With Enable ( $V_{in} = V_{in}(\text{nom})$ applied, then enabled)	From enable to $V_o = 0.1 * V_o(\text{nom})$		3.5		ms
Rise time <sup>2</sup> (Full resistive load)	From $0.1 * V_o(\text{nom})$ to $0.9 * V_o(\text{nom})$		3.5		ms
ON/OFF Control (Positive Logic) <sup>3</sup>	Converter Off	-5		0.8	VDC
	Converter On	2.4		5.5	VDC
ON/OFF Control (Negative Logic) <sup>3</sup>	Converter Off	2.4		5.5	VDC
	Converter On	-5		0.8	VDC
<b>INPUT CHARACTERISTICS</b>					
Operating Input Voltage Range	For $V_{out} > 2.5\text{ V}$	4.5	5.0	5.5	VDC
	For $V_{out} \leq 2.5\text{ V}$	3.0	5.0	5.5	VDC
Input Under Voltage Lockout	Turn-on Threshold		2.05	2.15	VDC
	Turn-off Threshold	1.75	1.9		VDC
Maximum Input Current					
$V_{in} = 4.5\text{V}$ , $I_{out} = 10\text{A}$	$V_{OUT} = 3.3\text{ VDC}$			7.8	ADC
$V_{in} = 3.0\text{V}$ , $I_{out} = 10\text{A}$	$V_{OUT} = 2.5\text{ VDC}$			9	ADC
$V_{in} = 3.0\text{V}$ , $I_{out} = 10\text{A}$	$V_{OUT} = 2.0\text{ VDC}$			7.3	ADC
$V_{in} = 3.0\text{V}$ , $I_{out} = 10\text{A}$	$V_{OUT} = 1.8\text{ VDC}$			6.7	ADC
$V_{in} = 3.0\text{V}$ , $I_{out} = 10\text{A}$	$V_{OUT} = 1.5\text{ VDC}$			5.7	ADC
$V_{in} = 3.0\text{V}$ , $I_{out} = 10\text{A}$	$V_{OUT} = 1.2\text{ VDC}$			4.7	ADC
$V_{in} = 3.0\text{V}$ , $I_{out} = 10\text{A}$	$V_{OUT} = 1.0\text{ VDC}$			4.0	ADC
$V_{in} = 3.0\text{V}$ , $I_{out} = 10\text{A}$	$V_{OUT} = 0.7525\text{ VDC}$			3.3	ADC
Input Stand-by Current (Converter disabled)	$V_{in} = 5.0\text{ VDC}$		10		mA
Input No Load Current (Converter enabled)	$V_{in} = 5.5\text{ VDC}$				
	$V_{OUT} = 3.3\text{ VDC}$		90		mA
	$V_{OUT} = 2.5\text{ VDC}$		85		mA
	$V_{OUT} = 2.0\text{ VDC}$		80		mA
	$V_{OUT} = 1.8\text{ VDC}$		75		mA
	$V_{OUT} = 1.5\text{ VDC}$		70		mA
	$V_{OUT} = 1.2\text{ VDC}$		65		mA
	$V_{OUT} = 1.0\text{ VDC}$		60		mA
	$V_{OUT} = 0.7525\text{ VDC}$		50		mA
Input Reflected-Ripple Current - $i_s$	See Fig. G for setup. (BW=20MHz)		15		mA <sub>P-P</sub>

+1.866.513.2839

tech.support@psbel.com

[belpowersolutions.com](http://belpowersolutions.com)

# YNV05T10 DC-DC Converter

OUTPUT CHARACTERISTICS					
Output Voltage Set Point (no load)		-1.5	Vout	+1.5	%Vout
Output Regulation <sup>4</sup>					
Over Line	Vin = 3.0 V – 5.5 V, Full resistive load		0.2		%Vout
Over Load	From no load to full load		0.4		%Vout
Output Voltage Tolerance (Overall operating input voltage, resistive load and temperature conditions until end of life )		-3		+3	%Vout
Output Ripple and Noise - 20MHz bandwidth (Fig. G)	Over line, load and temperature				
Peak-to-Peak	Vout = 3.3 V Full load		40	70	mV <sub>P-P</sub>
Peak-to-Peak	Vout = 0.7525 V Full load		20	40	mV <sub>P-P</sub>
External Load Capacitance	Plus full load (resistive)				
Min ESR > 1 mΩ				1000	μF
Min ESR > 10 mΩ				5000	μF
Output Current Range		0		10	A
Output Current Limit Inception (I <sub>OUT</sub> )			15	18.5	A
Output Short- Circuit Current (Hiccup mode)	Short=10 mΩ, continuous		3		Arms
DYNAMIC RESPONSE					
Load current change from 5A – 10A, di/dt = 5 A/μS	Co = 100 μF ceramic + 1 μF ceramic		120 <sup>5</sup>		mV
Settling Time (V <sub>OUT</sub> < 10% peak deviation)			40		μs
Unloading current change 10A – 5A, di/dt =-5 A/μS	Co = 100 μF ceramic + 1 μF ceramic		125 <sup>5</sup>		mV
Settling Time (V <sub>OUT</sub> < 10% peak deviation)			40		μs
EFFICIENCY					
	Full load (5A)				
	V <sub>OUT</sub> = 3.3 VDC		95.5		%
	V <sub>OUT</sub> = 2.5 VDC		93.5		%
	V <sub>OUT</sub> = 2.0 VDC		92.0		%
	V <sub>OUT</sub> = 1.8 VDC		91.5		%
	V <sub>OUT</sub> = 1.5 VDC		90.0		%
	V <sub>OUT</sub> = 1.2 VDC		88.5		%
	V <sub>OUT</sub> = 1.0 VDC		86.5		%
	V <sub>OUT</sub> = 0.7525 VDC		83.0		%

## Notes:

- 1 The output voltage should not exceed 3.63 V (taking into account both the programming and remote sense compensation).
- 2 Note that start-up time is the sum of turn-on delay time and rise time
- 3 The converter is on if ON/OFF pin is left open.
- 4 Trim resistor connected across the GND (pin 5) and TRIM pins of the converter.
- 5 See waveforms for dynamic response and settling time for different output voltages.

# YNV05T10 DC-DC Converter

## Operations

### Input and Output Impedance

The YNV05T10 non-isolated converter should be connected via a low impedance to the DC power source. In many applications, the inductance associated with the distribution from the power source to the input of the converter can affect the stability of the converter. It is recommended to use decoupling capacitors (minimum 47  $\mu\text{F}$ ) placed as close as possible to the converter input pins in order to ensure stability of the converter and reduce input ripple voltage. Internally, the converter has 52  $\mu\text{F}$  (low ESR ceramics) of input capacitance.

In a typical application, low - ESR tantalum or POS capacitors will be sufficient to provide adequate ripple voltage filtering at the input of the converter. However, very low ESR ceramic capacitors 47  $\mu\text{F}$ -100  $\mu\text{F}$  are recommended at the input of the converter in order to minimize the input ripple voltage. They should be placed as close as possible to the input pins of the converter.

The YNV05T10 has been designed for stable operation with or without external output capacitance. Low ESR ceramic capacitors placed as close as possible to the load (Min 47  $\mu\text{F}$ ) are recommended for improved transient performance and lower output voltage ripple.

It is important to keep low resistance and low inductance PCB traces when the connecting load to the output pins of the converter in order to maintain good load regulation.

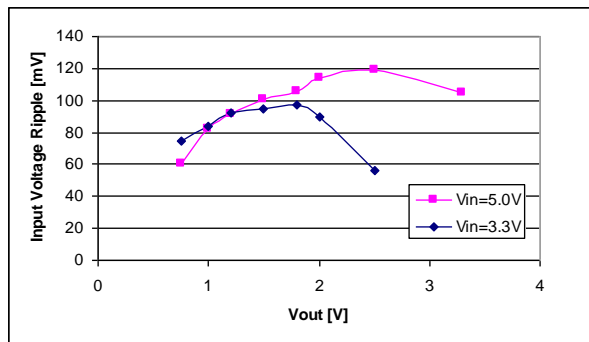

Fig. A: Input Voltage Ripple,  $C_{IN} = 4 \times 47 \mu\text{F}$  ceramic.

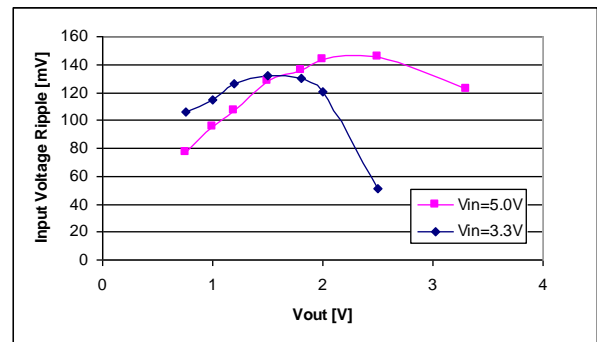

Fig. B: Input Voltage Ripple,  $C_{IN} = 470 \mu\text{F}$  polymer +  $2 \times 47 \mu\text{F}$  ceramic

### ON/OFF (Pin 10)

The ON/OFF pin is used to turn the converter on or off remotely via a system signal. There are two remote control options available, positive logic (standard option) and negative logic, and both are referenced to GND. Typical connections are shown in Fig. C.

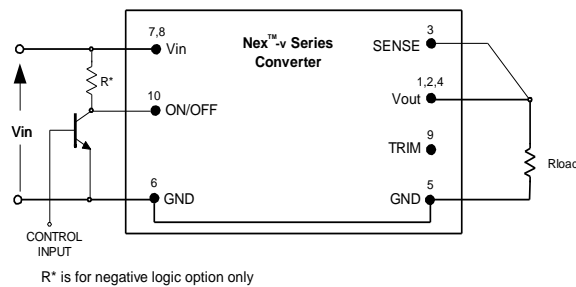

Fig. C: Circuit configuration for ON/OFF function.

The positive logic version turns the converter on when the ON/OFF pin is at a logic high or left open, and turns converter off when at a logic low or shorted to GND.

The negative logic version turns the converter on when the ON/OFF pin is at a logic low or left open, and turns the converter off when the ON/OFF pin is at a logic high or connected to Vin.

ON/OFF pin is internally pulled-up to Vin for a positive logic version, and pulled-down for a negative logic version. A TTL or CMOS logic gate, open collector (open drain) transistor can be used to drive ON/OFF pin. When using open collector

+1.866.513.2839

tech.support@psbel.com

belpowersolutions.com

# YNV05T10 DC-DC Converter

(open drain) transistor with a negative logic option, add a pull-up resistor ( $R^*$ ) of 10K to  $V_{in}$  as shown in Fig. C. External pull-up resistor ( $R^*$ ) can be increased to 20 K if minimum input voltage is more than 4.5 V. This device must be capable of:

- sinking up to 0.6 mA at a low level voltage of  $\leq 0.8$  V
- sourcing up to 0.25 mA at a high logic level of 2.3 V – 5.5 V

## Remote Sense (Pin 3)

The remote sense feature of the converter compensates for voltage drops occurring only between  $V_{out}$  of the converter and the load. The SENSE (Pin 3) pin should be connected at the load or at the point where regulation is required (see Fig. D). There is no sense feature on the output GND return pin, where a solid ground plane is recommended to provide a low voltage drop.

If remote sensing is not required, the SENSE pin must be connected to the  $V_{out}$  to ensure the converter will regulate at the specified output voltage. If these connections are not made, the converter will deliver an output voltage that is slightly higher than the specified value.

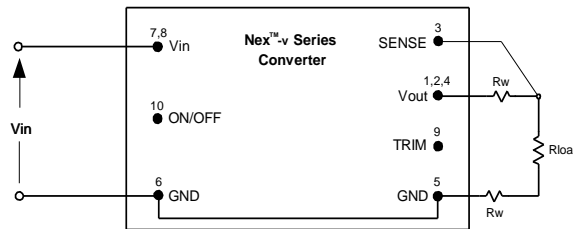

Fig. D: Remote sense circuit configuration.

Because the sense lead carries minimal current, large trace on the end-user board is not required. However, the sense trace should be located close to a ground plane to minimize system noise and insure optimum performance.

When utilizing the remote sense feature, care must be taken not to exceed the maximum allowable output power capability of the converter, equal to the product of the nominal output voltage and the allowable output current for the given conditions.

When using remote sense, the output voltage of the converter can be increased up to 0.5 V above the sense point voltage in order to maintain the required voltage across the load. Therefore, the designer must, if necessary, decrease the maximum current (originally obtained from the derating curves) by the same percentage to ensure the converter's actual output power remains at or below the maximum allowable output power.

## Output Voltage Programming (Pin 9)

The output voltage can be programmed from 0.7525 V to 3.63 V by connecting an external resistor between the TRIM pin (Pin 9) and the GND pin (Pin 5); see Fig. E. Note that when a trim resistor is not connected, the output voltage of the converter is 0.7525V.

A trim resistor,  $R_{TRIM}$ , for a desired output voltage can be calculated using the following equation:

$$R_{TRIM} = \frac{21.07}{(V_{O-REQ} - 0.7525)} - 5.11 \quad [k\Omega]$$

where,

$R_{TRIM}$  = Required value of trim resistor [ $k\Omega$ ]

$V_{O-REQ}$  = Desired (trimmed) output voltage [V]

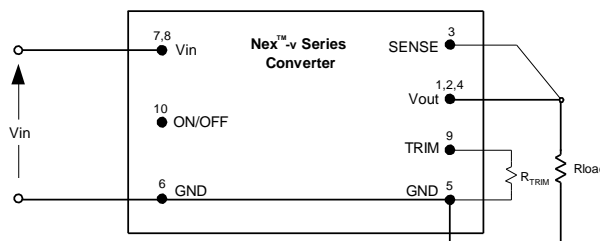

Fig. E: Configuration for programming output voltage.

+1.866.513.2839

tech.support@psbel.com

belpowersolutions.com

# YNV05T10 DC-DC Converter

Note that the tolerance of a trim resistor directly affects the output voltage tolerance. It is recommended to use standard 1% or 0.5% resistors. For tighter tolerance, two resistors in parallel are recommended rather than one standard value from Table 1.

Ground pin of the trim resistor should be connected directly to the converter GND pin (Pin 5) with no voltage drop in between. Table 1 provides the trim resistor values for popular output voltages.

V <sub>0-REG</sub> [V]	R <sub>TRIM</sub> [kΩ]	The Closest Standard Value [kΩ]
0.7525	open	
1.0	80.0	80.6
1.2	41.97	42.2
1.5	23.1	23.2
1.8	15	15
2.0	11.78	11.8
2.5	6.95	6.98
3.3	3.16	3.16
3.63	2.21	2.21

Table 1: Trim Resistor Value

The output voltage can also be programmed by external voltage source. To make trimming less sensitive, a series external resistor (R<sub>EXT</sub>) is recommended between the Trim pin (pin 9) and the programming voltage source. Control Voltage can be calculated by the formula:

$$V_{CTRL} = 0.7 - \frac{(5.11 + R_{EXT})(V_{O-REG} - 0.7525)}{30.1} \quad [V]$$

where,

V<sub>CTRL</sub> = Control voltage [V]

R<sub>EXT</sub> = External resistor between TRIM pin and voltage source; the value can be chosen depending on the required output voltage range [kΩ]

Control voltages with R<sub>EXT</sub> = 0 and R<sub>EXT</sub> = 15K are shown in Table 2.

V <sub>0-REG</sub> [V]	R <sub>EXT</sub> = 0	R <sub>EXT</sub> = 15 K
0.7525	0.700	0.700
1.0	0.658	0.535
1.2	0.624	0.401
1.5	0.573	0.201
1.8	0.522	-0.000
2.0	0.488	-0.133
2.5	0.403	-0.468
3.3	0.268	-1.002
3.63	0.257	-1.044

Table 2: Control Voltage [VDC]

# YNV05T10 DC-DC Converter

## Protection Features

### Input Undervoltage Lockout

Input undervoltage lockout is standard with this converter. The converter will shut down when the input voltage drops below a pre-determined voltage; it will start automatically when  $V_{in}$  returns to a specified range. The input voltage must be typically 2.0V for the converter to turn on. Once the converter has been turned on, it will shut off when the input voltage drops below typically 1.9V.

### Output Overcurrent Protection (OCP)

The converter is protected against over-current and short circuit conditions. Upon sensing an over-current condition, the converter will enter hiccup mode. Once the over-load or short circuit condition is removed,  $V_{out}$  will return to nominal value.

### Overtemperature Protection (OTP)

The converter will shut down under an over-temperature condition to protect itself from overheating caused by operation outside the thermal derating curves, or operation in abnormal conditions such as system fan failure. After the converter has cooled to a safe operating temperature, it will automatically restart.

## Safety Requirements

Approved to the latest edition and amendment of ITE Safety standards, UL/CSA 60950-1 and IEC60950-1.

The maximum DC voltage between any two pins is  $V_{in}$  under all operating conditions. Therefore, the unit has ELV (extra low voltage) output; it meets SELV requirements under the condition that all input voltages are ELV.

The converter is not internally fused. To comply with safety agencies requirements, a recognized fuse with a maximum rating of 20 Amps must be used in series with the input line.

## Characterization

### General Information

The converter has been characterized for many operational aspects, to include thermal derating (maximum load current as a function of ambient temperature and airflow) for vertical and horizontal mounting, efficiency, start-up parameters, output ripple and noise, and transient response to load step-change.

The figures are numbered as Fig. x.y, where x indicates the different output voltages, and y associates with specific plots (y = 1 for the vertical thermal derating, ...). For example, Fig. x.1 will refer to the vertical thermal derating for all the output voltages in general.

The following pages contain specific plots or waveforms associated with the converter. Additional comments for specific data are provided below.

### Test Conditions

All thermal and efficiency data presented were taken with the converter soldered to a test board, specifically a 0.060" thick printed wiring board (PWB) with four layers. The top and bottom layers were not metalized. The two inner layers, comprising two-ounce copper, were used to provide traces for connectivity to the converter.

The lack of metalization on the outer layers as well as the limited thermal connection ensured that heat transfer from the converter to the PWB was minimized. This provides a worst-case but consistent scenario for thermal derating purposes.

All measurements requiring airflow were made in vertical and horizontal wind tunnel facilities using Infrared (IR) thermography and thermocouples for thermometry.

Ensuring components on the converter do not exceed their ratings is important to maintaining high reliability. If one anticipates operating the converter at or close to the maximum loads specified in the derating curves, it is prudent to check actual operating temperatures in the application. Thermographic imaging is preferable; if this capability is not available, then thermocouples may be used. Bel Power Solutions recommends the use of AWG #40 gauge thermocouples to ensure measurement accuracy. Careful routing of the thermocouple leads will further minimize measurement error. Refer to Fig. F for optimum measuring thermocouple location.

+1.866.513.2839

tech.support@psbel.com

[belpowersolutions.com](http://belpowersolutions.com)

# YNV05T10 DC-DC Converter

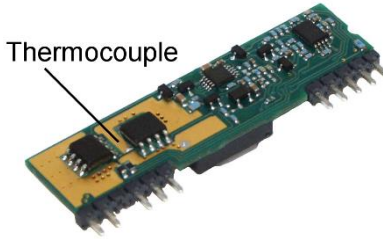

Fig. F: Location of the thermocouple for thermal testing.

## Thermal Derating

Load current vs. ambient temperature and airflow rates are given in Figs. x.1 to x.2 for maximum temperature of 120 °C. Ambient temperature was varied between 25 °C and 85 °C, with airflow rates from 30 to 500 LFM (0.15 m/s to 2.5 m/s), and vertical and horizontal converter mounting. The airflow during the testing is parallel to the long axis of the converter, going from ON/OFF pin to output pins.

For each set of conditions, the maximum load current was defined as the lowest of:

- (i) The output current at which any MOSFET temperature does not exceed a maximum specified temperature (120 °C) as indicated by the thermographic image, or
- (ii) The maximum current rating of the converter (10 A)

During normal operation, derating curves with maximum FET temperature less than or equal to 120°C should not be exceeded. Temperature on the PCB at the thermocouple locations shown in Fig. F should not exceed 120 °C in order to operate inside the derating curves.

## Efficiency

Fig. x.3 show the efficiency vs. load current plot for ambient temperature of 25 °C, airflow rate of 200 LFM (1 m/s) and input voltages of 4.5 V, 5.0 V, and 5.5 V.

Fig. x.4 show the efficiency vs. load current plot for ambient temperature of 25 °C, airflow rate of 200 LFM (1 m/s) and input voltages of 3.0 V, 3.3 V, and 3.6 V for output voltages 2.5 V.

## Power Dissipation

Fig. 3.3V.4 shows the power dissipation vs. load current plot for  $T_a = 25\text{ °C}$ , airflow rate of 200 LFM (1 m/s) with vertical mounting and input voltages of 4.5 V, 5.0 V and 5.5 V for 3.3V output voltage.

## Start-up

Output voltage waveforms, during the turn-on transient with application of  $V_{in}$  at full rated load current (resistive load) are shown with 47 $\mu\text{F}$  external load capacitance at  $V_{in} = 5\text{V}$  in Fig. x.5.

## Ripple and Noise

The output voltage ripple waveform is measured at full rated load current. Note that all output voltage waveforms are measured across a 1  $\mu\text{F}$  ceramic capacitor.

The output voltage ripple and input reflected ripple current waveforms are obtained using the test setup shown in Fig. G.

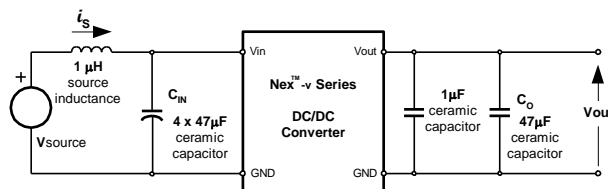

Fig. G: Test setup for measuring input reflected ripple currents,  $i_s$  and output voltage ripple.



# YNV05T10 DC-DC Converter

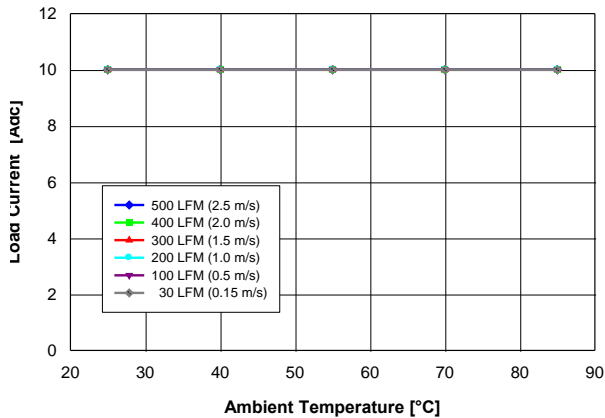

Fig. 3.3V.1: Available load current vs. ambient temperature and airflow rates for  $V_{out} = 3.3\text{V}$  converter mounted vertically with  $V_{in} = 5\text{V}$ , air flowing from pin 10 to pin 1, and maximum MOSFET temperature  $\leq 120^{\circ}\text{C}$ .

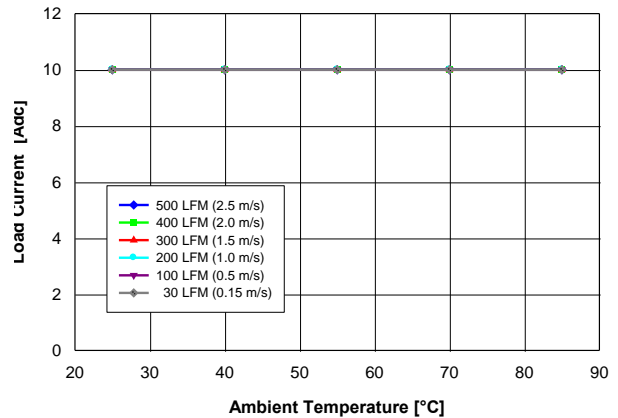

Fig. 3.3V.2: Available load current vs. ambient temperature and airflow rates for  $V_{out} = 3.3\text{V}$  converter mounted horizontally with  $V_{in} = 5\text{V}$ , air flowing from pin 10 to pin 1, and maximum MOSFET temperature  $\leq 120^{\circ}\text{C}$ .

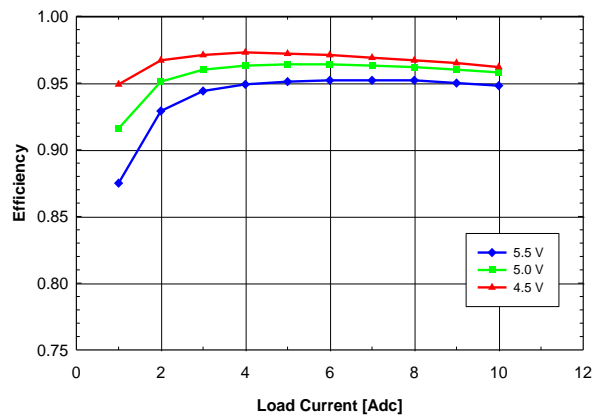

Fig. 3.3V.3: Efficiency vs. load current and input voltage for  $V_{out} = 3.3\text{V}$  converter mounted vertically with air flowing from pin 10 to pin 1 at a rate of 200 LFM (1m/s) and  $T_a = 25^{\circ}\text{C}$ .

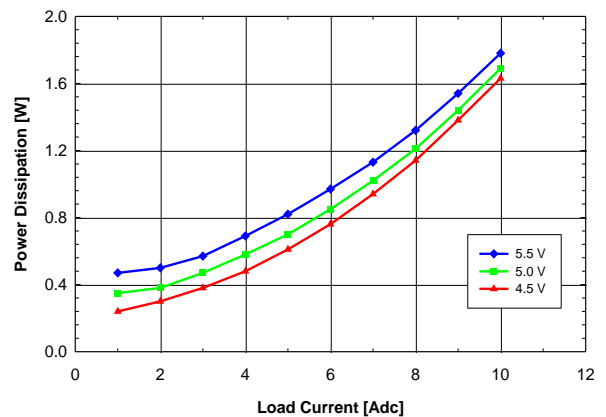

Fig. 3.3V.4: Power loss vs. load current and input voltage for  $V_{out} = 3.3\text{V}$  converter mounted vertically with air flowing from pin 10 to pin 1 at a rate of 200 LFM (1m/s) and  $T_a = 25^{\circ}\text{C}$ .

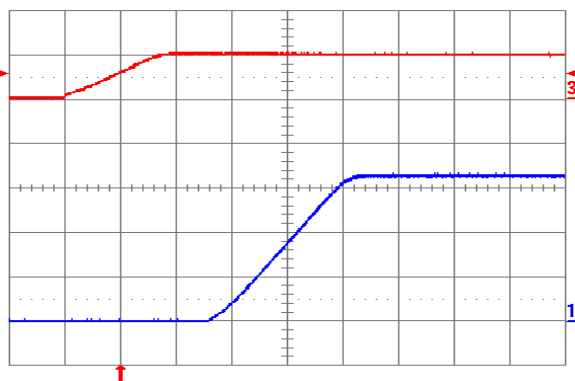

Fig. 3.3V.5: Turn-on transient for  $V_{out} = 3.3\text{V}$  with application of  $V_{in}$  at full rated load current (resistive) and  $47\mu\text{F}$  external capacitance at  $V_{in} = 5\text{V}$ . Top trace:  $V_{in}$  (5V/div.); Bottom trace: output voltage (1V/div.); Time scale: 2ms/div.

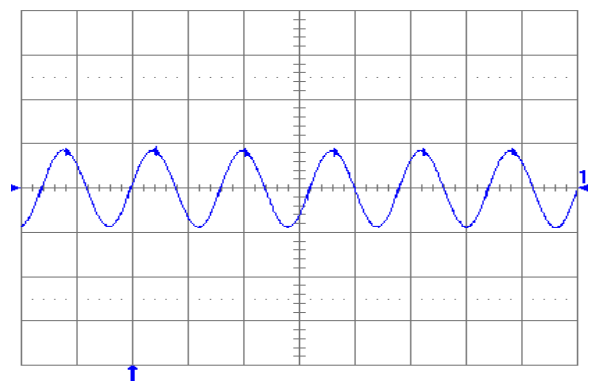

Fig. 3.3V.6: Output voltage ripple (20mV/div.) at full rated load current into a resistive load with external capacitance  $47\mu\text{F}$  ceramic +  $1\mu\text{F}$  ceramic and  $V_{in} = 5\text{V}$  for  $V_{out} = 3.3\text{V}$ . Time scale: 2µs/div.

# YNV05T10 DC-DC Converter

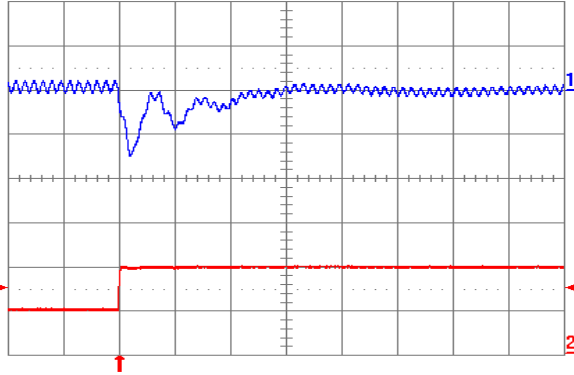

Fig. 3.3V.7: Output voltage response for  $V_{out} = 3.3V$  to positive load current step change from 2.5A to 5A with slew rate of  $5A/\mu s$  at  $V_{in} = 5V$ . Top trace: output voltage (100mV/div.); Bottom trace: load current (5A/div.).  $C_o = 100\mu F$  ceramic +  $1\mu F$  ceramic. Time scale:  $20\mu s/div$ .

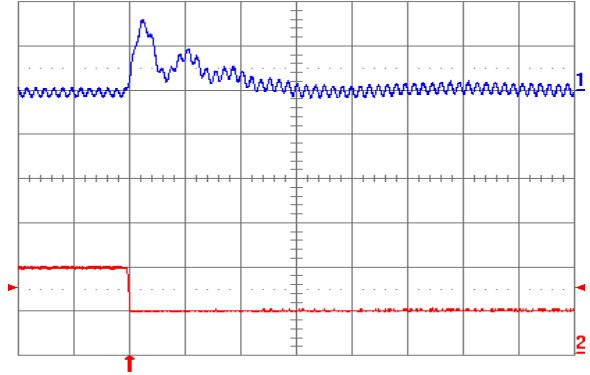

Fig. 3.3V.8: Output voltage response for  $V_{out} = 3.3V$  to negative load current step change from 5A to 2.5A with slew rate of  $-5A/\mu s$  at  $V_{in} = 5V$ . Top trace: output voltage (100mV/div.); Bottom trace: load current (5A/div.).  $C_o = 100\mu F$  ceramic +  $1\mu F$  ceramic. Time scale:  $20\mu s/div$ .

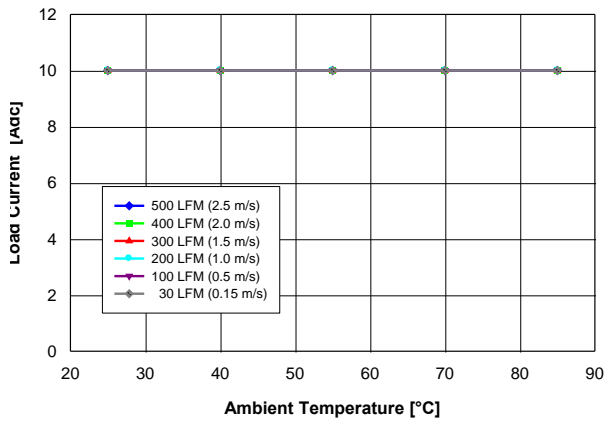

Fig. 2.5V.1: Available load current vs. ambient temperature and airflow rates for  $V_{out} = 2.5V$  converter mounted vertically with air flowing from pin 10 to pin 1, and maximum MOSFET temperature  $\leq 120^\circ C$ .

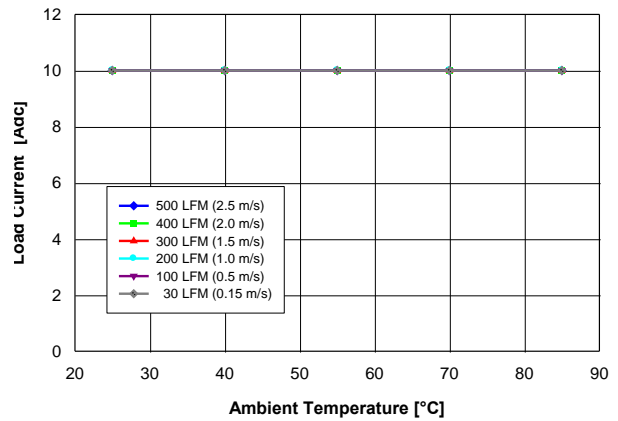

Fig. 2.5V.2: Available load current vs. ambient temperature and airflow rates for  $V_{out} = 2.5V$  converter mounted horizontally with air flowing from pin 10 to pin 1, and maximum MOSFET temperature  $\leq 120^\circ C$ .

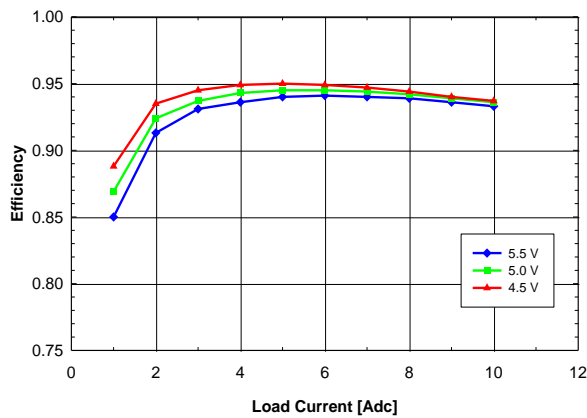

Fig. 2.5V.3: Efficiency vs. load current and input voltage for  $V_{out} = 2.5V$  converter mounted vertically with air flowing from pin 10 to pin 1 at a rate of 200 LFM (1m/s) and  $T_a = 25^\circ C$ .

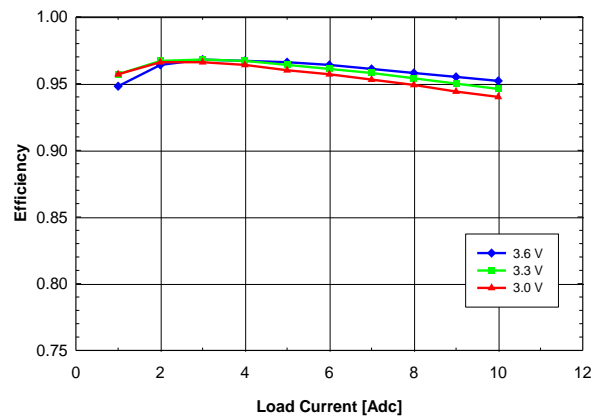

Fig. 2.5V.4: Efficiency vs. load current and input voltage for  $V_{out} = 2.5V$  converter mounted vertically with air flowing from pin 10 to pin 1 at a rate of 200 LFM (1m/s) and  $T_a = 25^\circ C$ .

# YNV05T10 DC-DC Converter

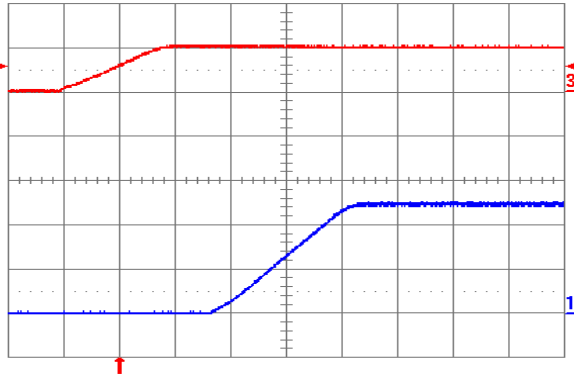

Fig. 2.5V.5: Turn-on transient for  $V_{out} = 2.5V$  with application of  $V_{in}$  at full rated load current (resistive) and  $47\mu F$  external capacitance at  $V_{in} = 5V$ . Top trace:  $V_{in}$  (5V/div.); Bottom trace: output voltage (1V/div.); Time scale: 2ms/div.

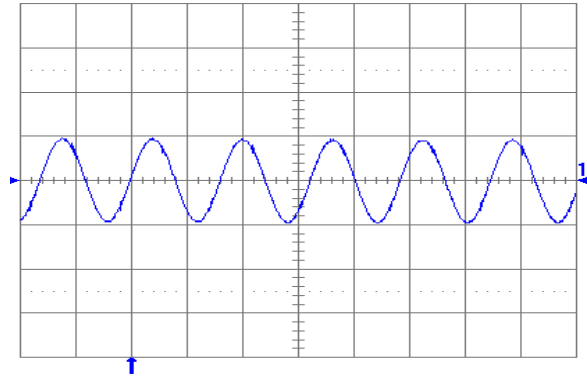

Fig. 2.5V.6: Output voltage ripple (20mV/div.) at full rated load current into a resistive load with external capacitance  $47\mu F$  ceramic +  $1\mu F$  ceramic and  $V_{in} = 5V$  for  $V_{out} = 2.5V$ . Time scale:  $2\mu s$ /div.

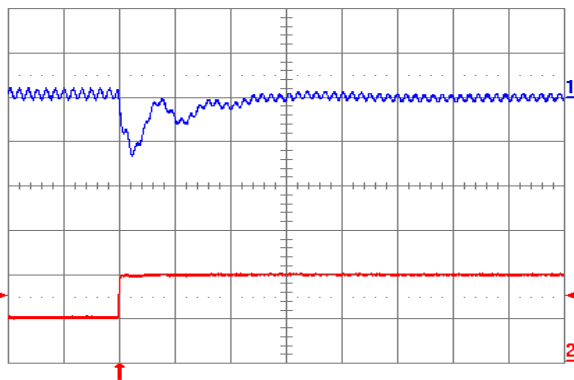

Fig. 2.5V.7: Output voltage response for  $V_{out} = 2.5V$  to positive load current step change from 2.5A to 5A with slew rate of  $5A/\mu s$  at  $V_{in} = 5V$ . Top trace: output voltage (100mV/div.); Bottom trace: load current (5A/div.).  $C_o = 100\mu F$  ceramic +  $1\mu F$  ceramic. Time scale:  $20\mu s$ /div.

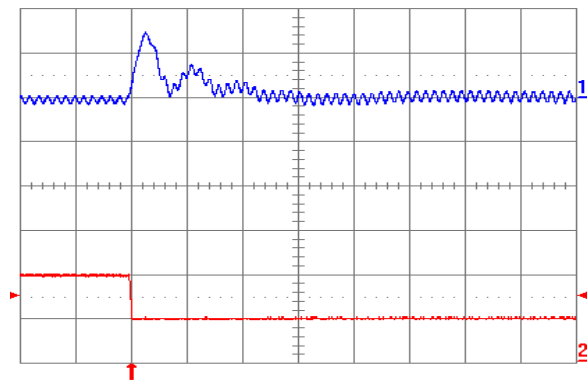

Fig. 2.5V.8: Output voltage response for  $V_{out} = 2.5V$  to negative load current step change from 5A to 2.5A with slew rate of  $-5A/\mu s$  at  $V_{in} = 5V$ . Top trace: output voltage (100mV/div.); Bottom trace: load current (5A/div.).  $C_o = 100\mu F$  ceramic +  $1\mu F$  ceramic. Time scale:  $20\mu s$ /div.

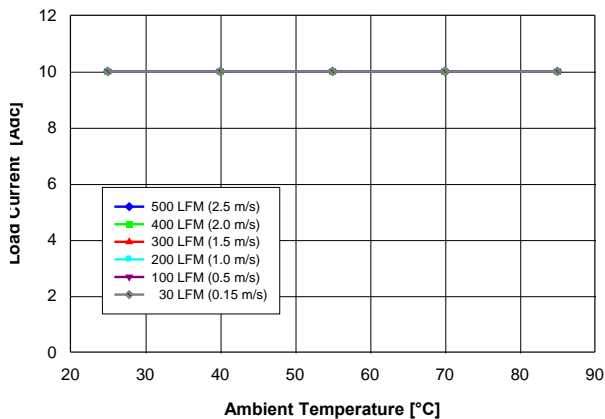

Fig. 2.0V.1: Available load current vs. ambient temperature and airflow rates for  $V_{out} = 2.0V$  converter mounted vertically with air flowing from pin 10 to pin 1, and maximum MOSFET temperature  $\leq 120^\circ C$ .

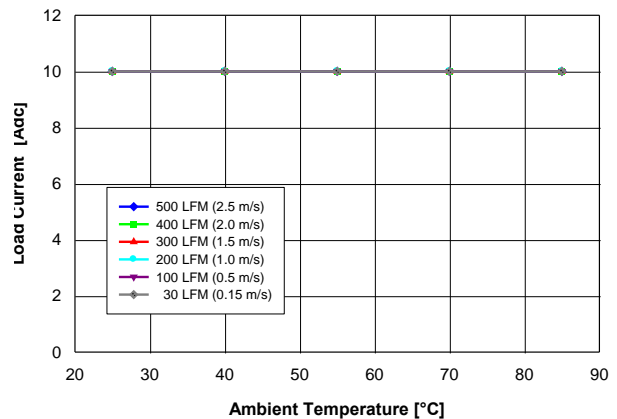

Fig. 2.0V.2: Available load current vs. ambient temperature and airflow rates for  $V_{out} = 2.0V$  converter mounted horizontally with air flowing from pin 10 to pin 1, and maximum MOSFET temperature  $\leq 120^\circ C$ .

# YNV05T10 DC-DC Converter

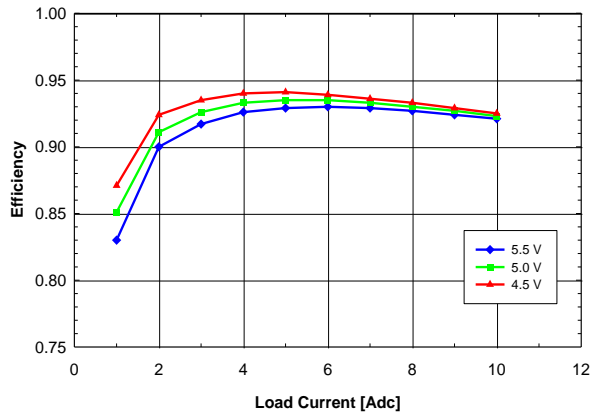

Fig. 2.0V.3: Efficiency vs. load current and input voltage for  $V_{out} = 2.0V$  converter mounted vertically with air flowing from pin 10 to pin 1 at a rate of 200 LFM (1m/s) and  $T_a = 25^{\circ}C$ .

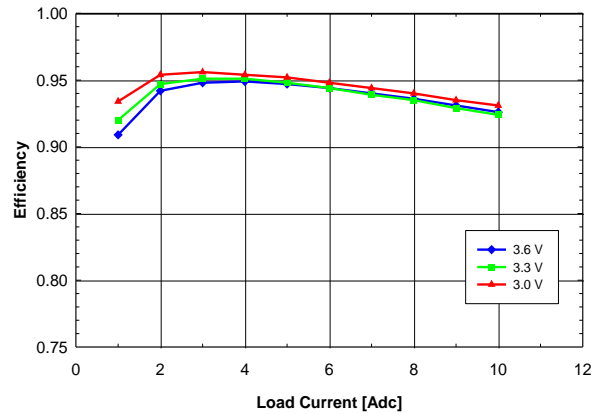

Fig. 2.0V.4: Efficiency vs. load current and input voltage for  $V_{out} = 2.0V$  converter mounted vertically with air flowing from pin 10 to pin 1 at a rate of 200 LFM (1m/s) and  $T_a = 25^{\circ}C$ .

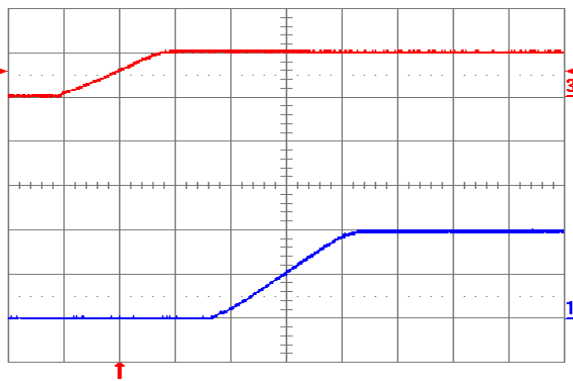

Fig. 2.0V.5: Turn-on transient for  $V_{out} = 2.0V$  with application of  $V_{in}$  at full rated load current (resistive) and  $47\mu F$  external capacitance at  $V_{in} = 5V$ . Top trace:  $V_{in}$  (5V/div.); Bottom trace: output voltage (1V/div.); Time scale: 2ms/div.

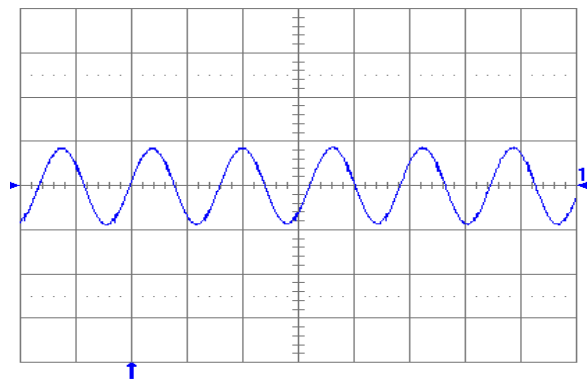

Fig. 2.0V.6: Output voltage ripple (20mV/div.) at full rated load current into a resistive load with external capacitance  $47\mu F$  ceramic +  $1\mu F$  ceramic and  $V_{in} = 5V$  for  $V_{out} = 2.0V$ . Time scale:  $2\mu s$ /div.

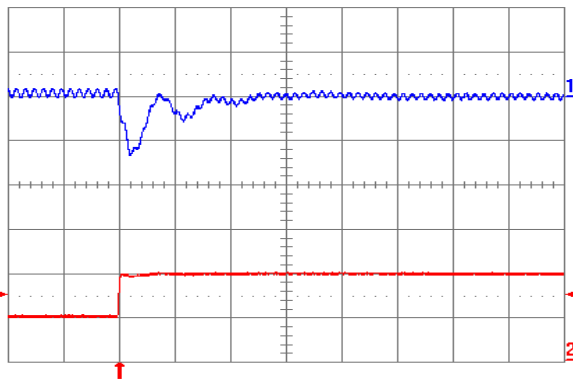

Fig. 2.0V.7: Output voltage response for  $V_{out} = 2.0V$  to positive load current step change from 2.5A to 5A with slew rate of  $5A/\mu s$  at  $V_{in} = 5V$ . Top trace: output voltage (100mV/div.); Bottom trace: load current (5A/div.).  $C_o = 100\mu F$  ceramic +  $1\mu F$  ceramic. Time scale:  $20\mu s$ /div.

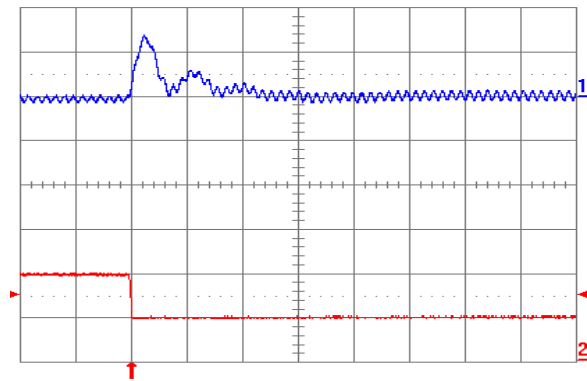

Fig. 2.0V.8: Output voltage response for  $V_{out} = 2.0V$  to negative load current step change from 5A to 2.5A with slew rate of  $-5A/\mu s$  at  $V_{in} = 5V$ . Top trace: output voltage (100mV/div.); Bottom trace: load current (5A/div.).  $C_o = 100\mu F$  ceramic +  $1\mu F$  ceramic. Time scale:  $20\mu s$ /div.

+1.866.513.2839

tech.support@psbel.com

belpowersolutions.com

# YNV05T10 DC-DC Converter

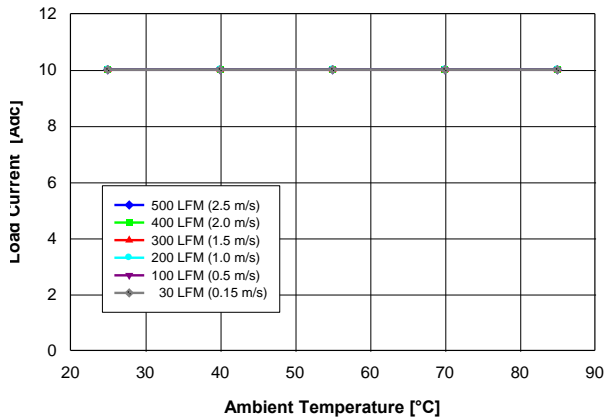

Fig. 1.8V.1: Available load current vs. ambient temperature and airflow rates for  $V_{out} = 1.8V$  converter mounted vertically with air flowing from pin 10 to pin 1, and maximum MOSFET temperature  $\leq 120^{\circ}C$ .

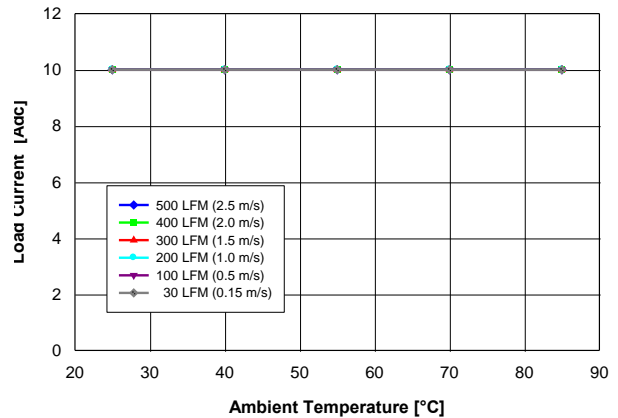

Fig. 1.8V.2: Available load current vs. ambient temperature and airflow rates for  $V_{out} = 1.8V$  converter mounted horizontally with air flowing from pin 10 to pin 1, and maximum MOSFET temperature  $\leq 120^{\circ}C$ .

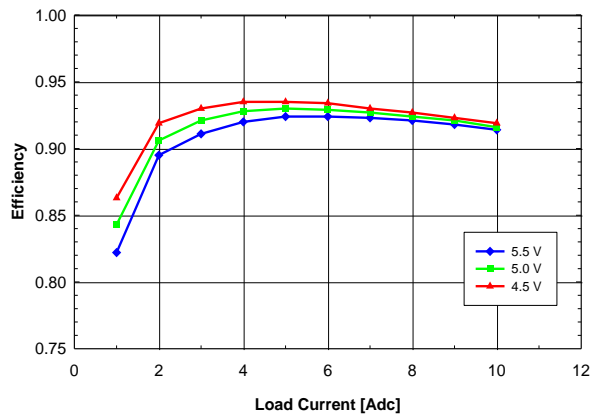

Fig. 1.8V.3: Efficiency vs. load current and input voltage for  $V_{out} = 1.8V$  converter mounted vertically with air flowing from pin 10 to pin 1 at a rate of 200 LFM (1m/s) and  $T_a = 25^{\circ}C$ .

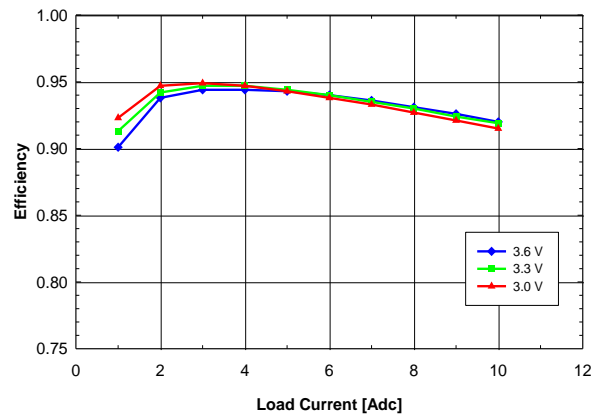

Fig. 1.8V.4: Efficiency vs. load current and input voltage for  $V_{out} = 1.8V$  converter mounted vertically with air flowing from pin 10 to pin 1 at a rate of 200 LFM (1m/s) and  $T_a = 25^{\circ}C$ .

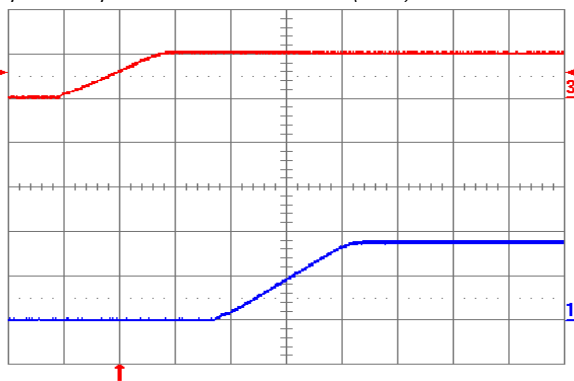

Fig. 1.8V.5: Turn-on transient for  $V_{out} = 1.8V$  with application of  $V_{in}$  at full rated load current (resistive) and  $47\mu F$  external capacitance at  $V_{in} = 5V$ . Top trace:  $V_{in}$  (5V/div.); Bottom trace: output voltage (1V/div.); Time scale: 2ms/div.

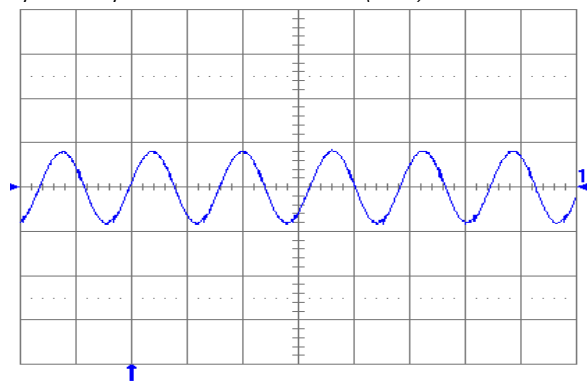

Fig. 1.8V.6: Output voltage ripple (20mV/div.) at full rated load current into a resistive load with external capacitance  $47\mu F$  ceramic +  $1\mu F$  ceramic and  $V_{in} = 5V$  for  $V_{out} = 1.8V$ . Time scale: 2µs/div.

# YNV05T10 DC-DC Converter

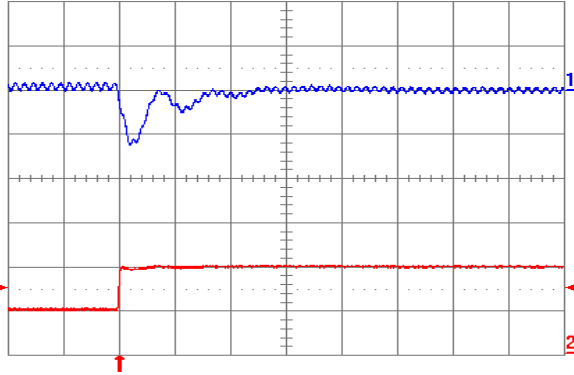

Fig. 1.8V.7: Output voltage response for  $V_{out} = 1.8V$  to positive load current step change from 2.5A to 5A with slew rate of  $5A/\mu s$  at  $V_{in} = 5V$ . Top trace: output voltage (100mV/div.); Bottom trace: load current (5A/div.).  $C_o = 100\mu F$  ceramic +  $1\mu F$  ceramic. Time scale:  $20\mu s/div.$

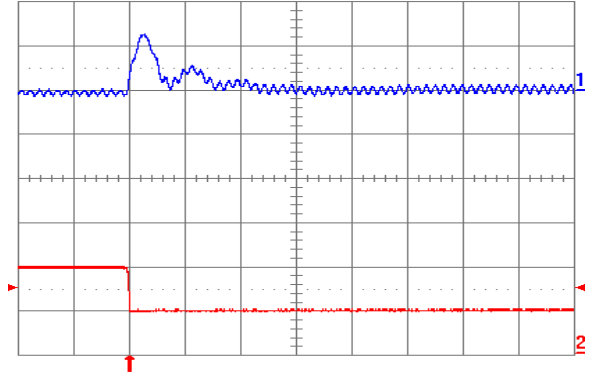

Fig. 1.8V.8: Output voltage response for  $V_{out} = 1.8V$  to negative load current step change from 5A to 2.5A with slew rate of  $-5A/\mu s$  at  $V_{in} = 5V$ . Top trace: output voltage (100mV/div.); Bottom trace: load current (5A/div.).  $C_o = 100\mu F$  ceramic +  $1\mu F$  ceramic. Time scale:  $20\mu s/div.$

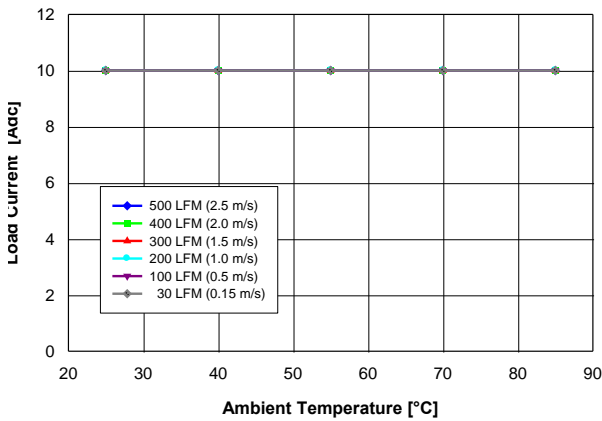

Fig. 1.5V.1: Available load current vs. ambient temperature and airflow rates for  $V_{out} = 1.5V$  converter mounted vertically with air flowing from pin 10 to pin 1, and maximum MOSFET temperature  $\leq 120^\circ C$ .

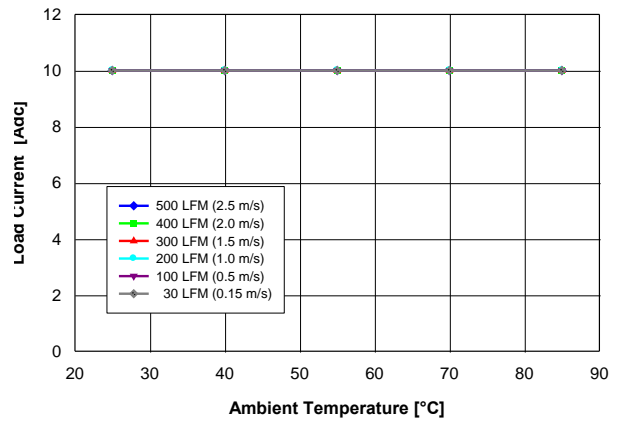

Fig. 1.5V.2: Available load current vs. ambient temperature and airflow rates for  $V_{out} = 1.5V$  converter mounted horizontally with air flowing from pin 10 to pin 1, and maximum MOSFET temperature  $\leq 120^\circ C$ .

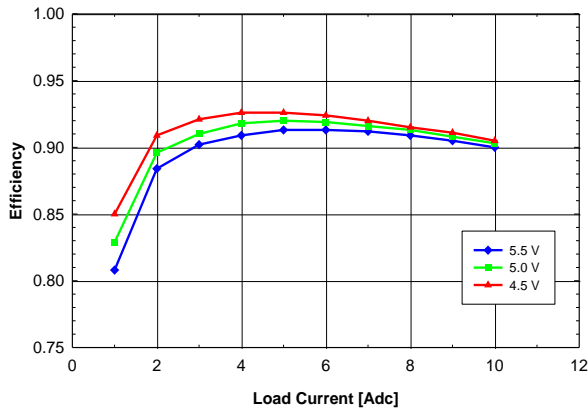

Fig. 1.5V.3: Efficiency vs. load current and input voltage for  $V_{out} = 1.5V$  converter mounted vertically with air flowing from pin 10 to pin 1 at a rate of 200 LFM (1m/s) and  $T_a = 25^\circ C$ .

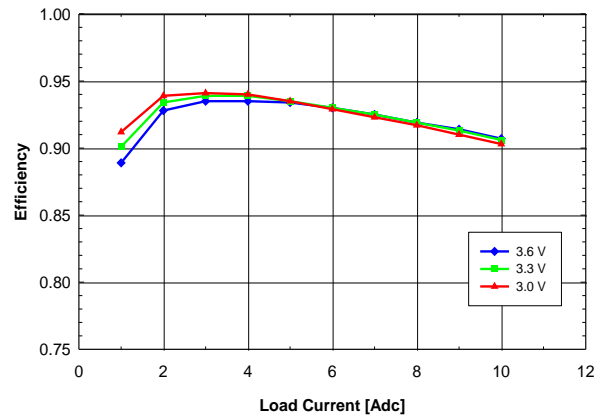

Fig. 1.5V.4: Efficiency vs. load current and input voltage for  $V_{out} = 1.5V$  converter mounted horizontally with air flowing from pin 10 to pin 1 at a rate of 200 LFM (1m/s) and  $T_a = 25^\circ C$ .

# YNV05T10 DC-DC Converter

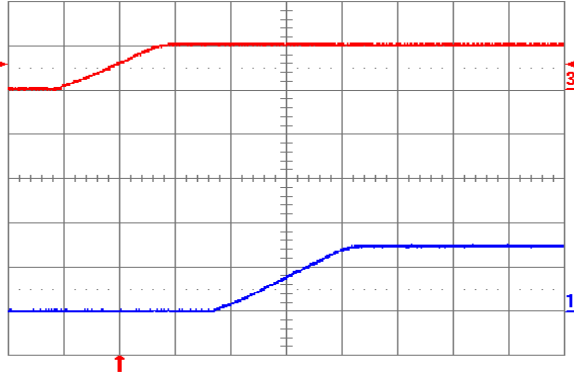

Fig. 1.5V.5: Turn-on transient for  $V_{out} = 1.5V$  with application of  $V_{in}$  at full rated load current (resistive) and  $47\mu F$  external capacitance at  $V_{in} = 5V$ . Top trace:  $V_{in}$  (5V/div.); Bottom trace: output voltage (1V/div.); Time scale: 2ms/div.

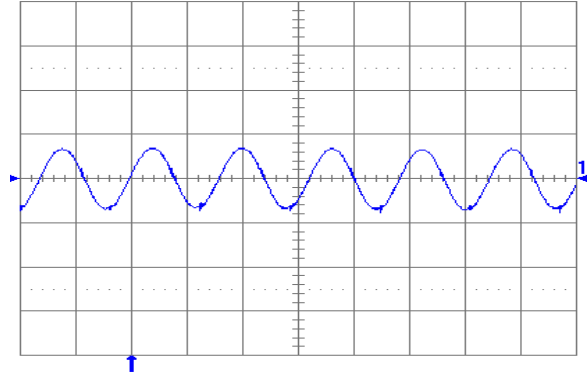

Fig. 1.5V.6: Output voltage ripple (20mV/div.) at full rated load current into a resistive load with external capacitance  $47\mu F$  ceramic +  $1\mu F$  ceramic and  $V_{in} = 5V$  for  $V_{out} = 1.5V$ . Time scale:  $2\mu s$ /div.

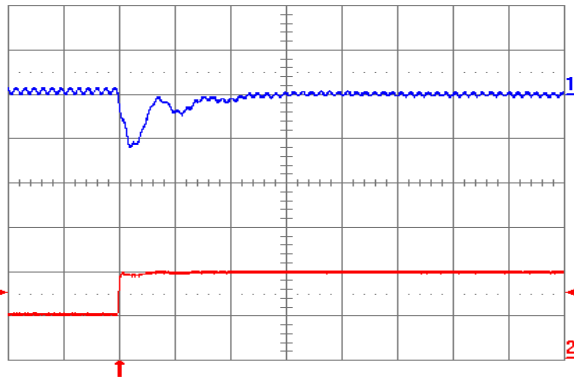

Fig. 1.5V.7: Output voltage response for  $V_{out} = 1.5V$  to positive load current step change from 2.5A to 5A with slew rate of  $5A/\mu s$  at  $V_{in} = 5V$ . Top trace: output voltage (100mV/div.); Bottom trace: load current (5A/div.).  $C_o = 100\mu F$  ceramic +  $1\mu F$  ceramic. Time scale:  $20\mu s$ /div.

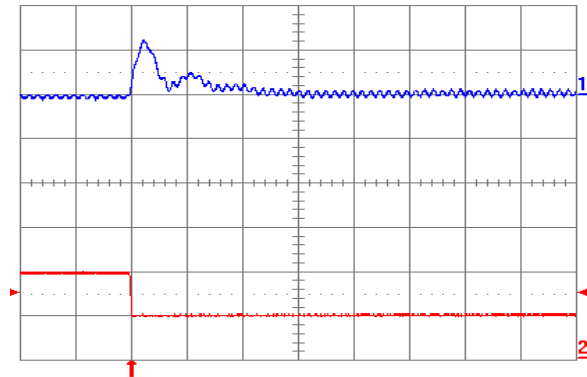

Fig. 1.5V.8: Output voltage response for  $V_{out} = 1.5V$  to negative load current step change from 5A to 2.5A with slew rate of  $-5A/\mu s$  at  $V_{in} = 5V$ . Top trace: output voltage (100mV/div.); Bottom trace: load current (5A/div.).  $C_o = 100\mu F$  ceramic +  $1\mu F$  ceramic. Time scale:  $20\mu s$ /div.

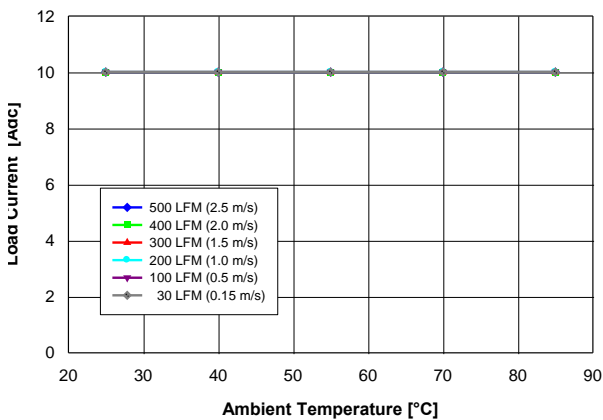

Fig. 1.2V.1: Available load current vs. ambient temperature and airflow rates for  $V_{out} = 1.2V$  converter mounted vertically with air flowing from pin 10 to pin 1, and maximum MOSFET temperature  $\leq 120^\circ C$ .

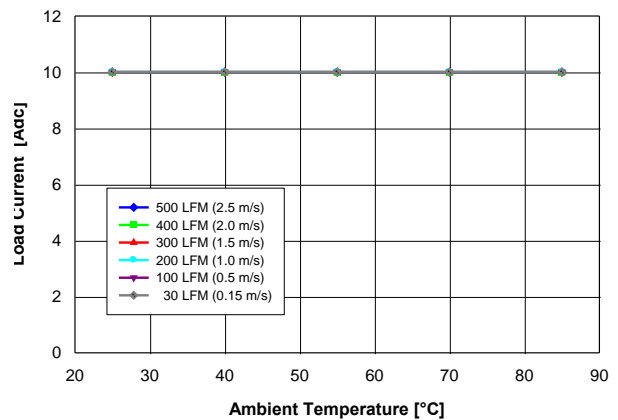

Fig. 1.2V.2: Available load current vs. ambient temperature and airflow rates for  $V_{out} = 1.2V$  converter mounted horizontally with air flowing from pin 10 to pin 1, and maximum MOSFET temperature  $\leq 120^\circ C$ .

# YNV05T10 DC-DC Converter

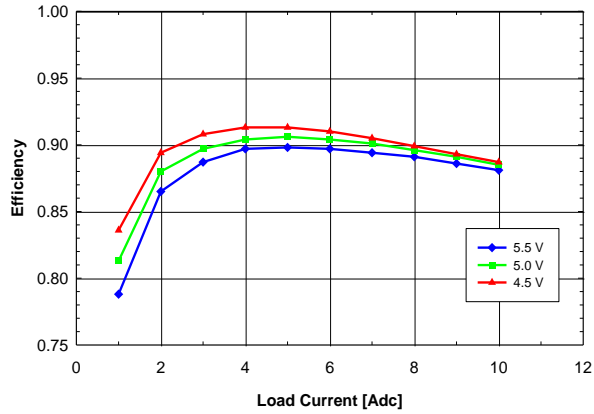

Fig. 1.2V.3: Efficiency vs. load current and input voltage for  $V_{out} = 1.2V$  converter mounted vertically with air flowing from pin 10 to pin 1 at a rate of 200 LFM (1m/s) and  $T_a = 25^\circ C$ .

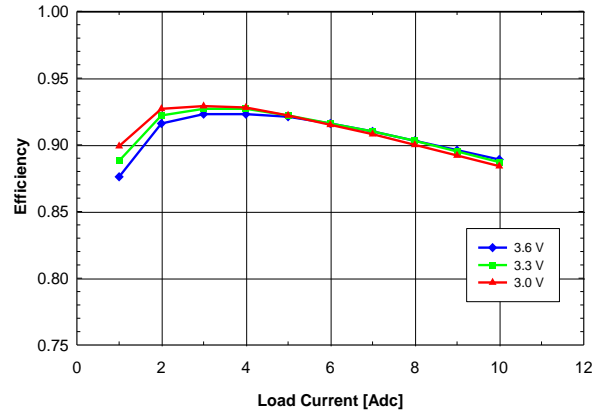

Fig. 1.2V.4: Efficiency vs. load current and input voltage for  $V_{out} = 1.2V$  converter mounted vertically with air flowing from pin 10 to pin 1 at a rate of 200 LFM (1m/s) and  $T_a = 25^\circ C$ .

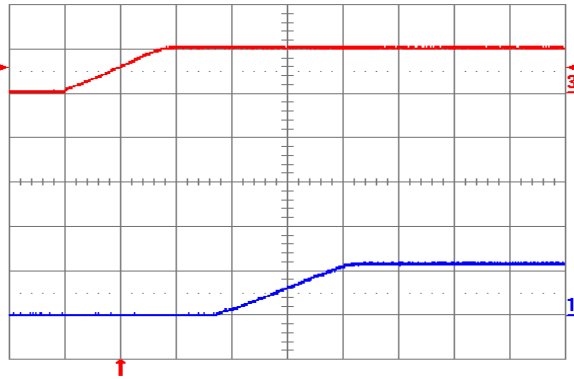

Fig. 1.2V.5: Turn-on transient for  $V_{out} = 1.2V$  with application of  $V_{in}$  at full rated load current (resistive) and  $47\mu F$  external capacitance at  $V_{in} = 5V$ . Top trace:  $V_{in}$  (5V/div.); Bottom trace: output voltage (1V/div.); Time scale: 2ms/div.

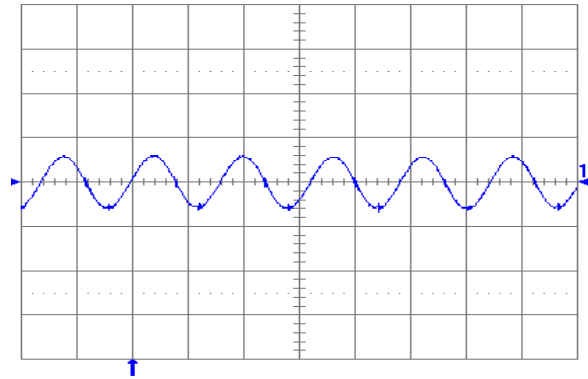

Fig. 1.2V.6: Output voltage ripple (20mV/div.) at full rated load current into a resistive load with external capacitance  $47\mu F$  ceramic +  $1\mu F$  ceramic and  $V_{in} = 5V$  for  $V_{out} = 1.2V$ . Time scale:  $2\mu s$ /div.

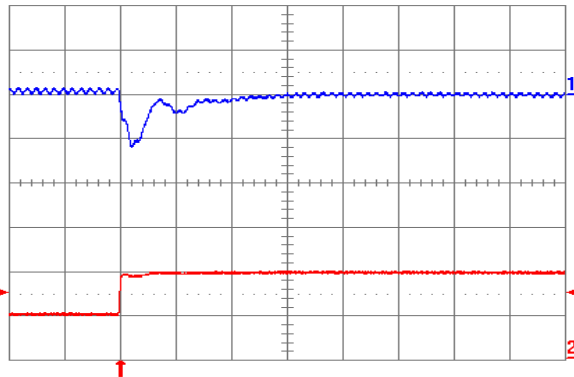

Fig. 1.2V.7: Output voltage response for  $V_{out} = 1.2V$  to positive load current step change from 2.5A to 5A with slew rate of  $5A/\mu s$  at  $V_{in} = 5V$ . Top trace: output voltage (100mV/div.); Bottom trace: load current (5A/div.).  $C_o = 100\mu F$  ceramic +  $1\mu F$  ceramic. Time scale:  $20\mu s$ /div.

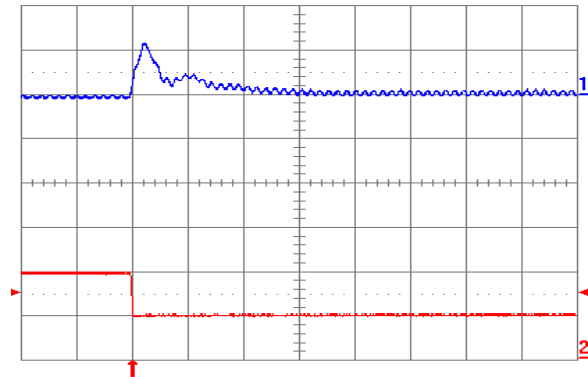

Fig. 1.2V.8: Output voltage response for  $V_{out} = 1.2V$  to negative load current step change from 5A to 2.5A with slew rate of  $-5A/\mu s$  at  $V_{in} = 5V$ . Top trace: output voltage (100mV/div.); Bottom trace: load current (5A/div.).  $C_o = 100\mu F$  ceramic +  $1\mu F$  ceramic. Time scale:  $20\mu s$ /div.



# YNV05T10 DC-DC Converter

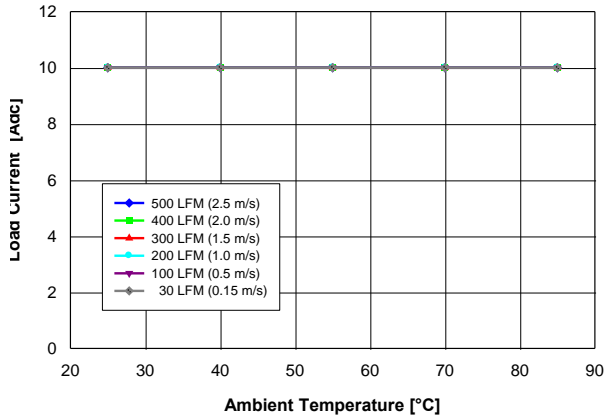

Fig. 1.0V.1: Available load current vs. ambient temperature and airflow rates for  $V_{out} = 1.0V$  converter mounted vertically with air flowing from pin 10 to pin 1, and maximum MOSFET temperature  $\leq 120^{\circ}C$ .

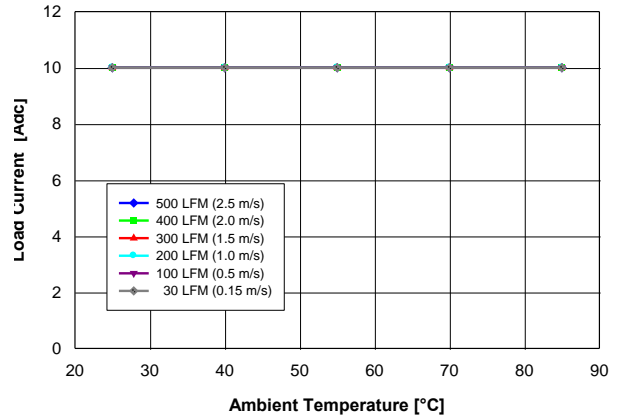

Fig. 1.0V.2: Available load current vs. ambient temperature and airflow rates for  $V_{out} = 1.0V$  converter mounted horizontally with air flowing from pin 10 to pin 1, and maximum MOSFET temperature  $\leq 120^{\circ}C$ .

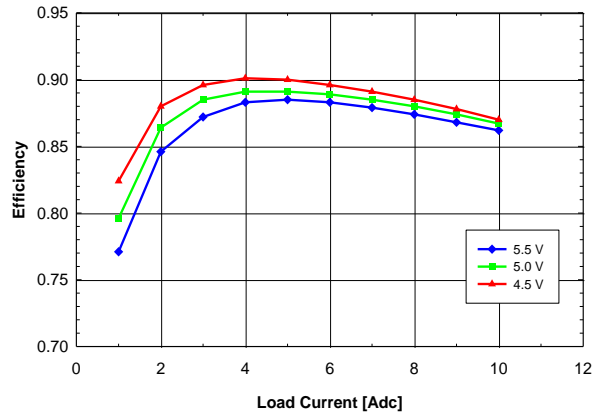

Fig. 1.0V.3: Efficiency vs. load current and input voltage for  $V_{out} = 1.0V$  converter mounted vertically with air flowing from pin 10 to pin 1 at a rate of 200 LFM (1m/s) and  $T_a = 25^{\circ}C$ .

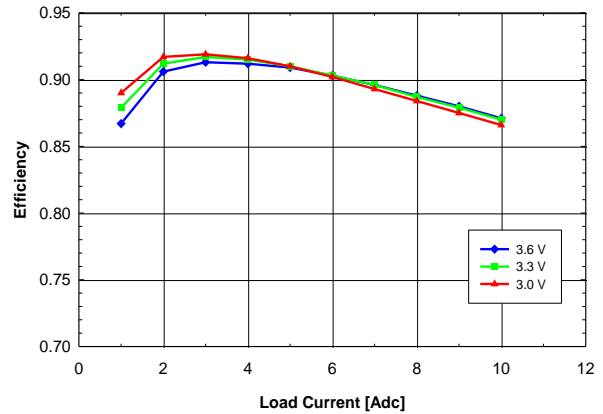

Fig. 1.0V.4: Efficiency vs. load current and input voltage for  $V_{out} = 1.0V$  converter mounted vertically with air flowing from pin 10 to pin 1 at a rate of 200 LFM (1m/s) and  $T_a = 25^{\circ}C$ .

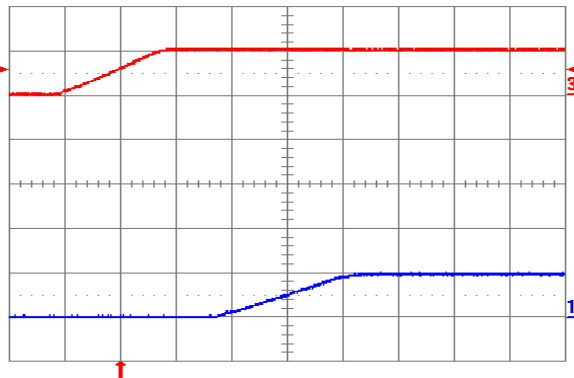

Fig. 1.0V.5: Turn-on transient for  $V_{out} = 1.0V$  with application of  $V_{in}$  at full rated load current (resistive) and  $47\mu F$  external capacitance at  $V_{in} = 5V$ . Top trace:  $V_{in}$  (5V/div.); Bottom trace: output voltage (1V/div.); Time scale: 2ms/div.

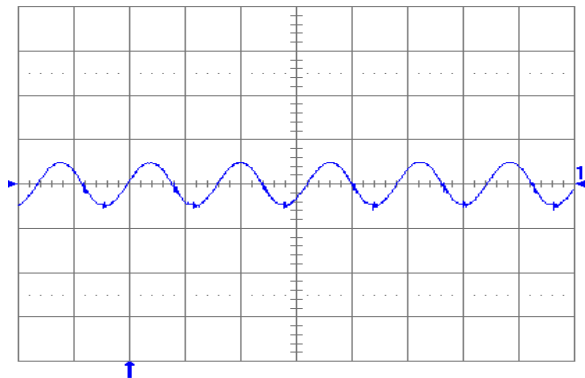

Fig. 1.0V.6: Output voltage ripple (20mV/div.) at full rated load current into a resistive load with external capacitance  $47\mu F$  ceramic +  $1\mu F$  ceramic and  $V_{in} = 5V$  for  $V_{out} = 1.0V$ . Time scale: 2µs/div.

# YNV05T10 DC-DC Converter

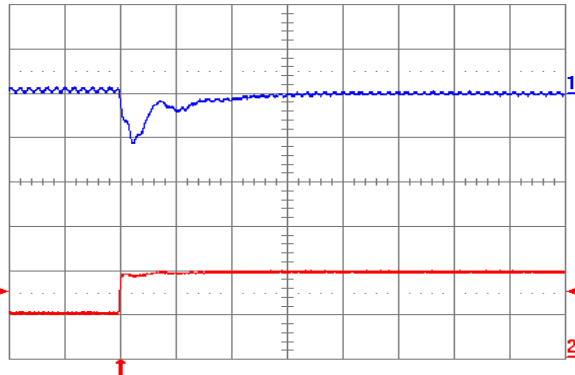

Fig. 1.0V.7: Output voltage response for  $V_{out} = 1.0V$  to positive load current step change from 2.5A to 5A with slew rate of  $5A/\mu s$  at  $V_{in} = 5V$ . Top trace: output voltage (100mV/div.); Bottom trace: load current (5A/div.).  $C_o = 100\mu F$  ceramic +  $1\mu F$  ceramic. Time scale:  $20\mu s/div.$

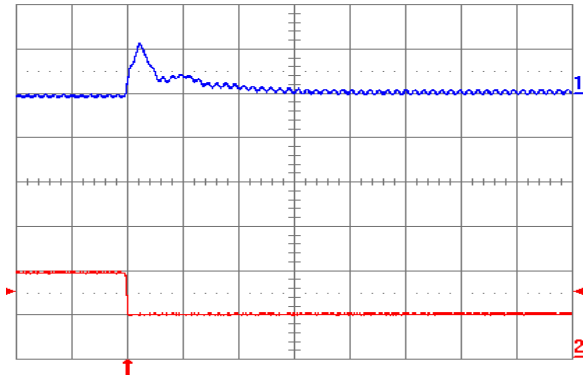

Fig. 1.0V.8: Output voltage response for  $V_{out} = 1.0V$  to negative load current step change from 5A to 2.5A with slew rate of  $-5A/\mu s$  at  $V_{in} = 5V$ . Top trace: output voltage (100mV/div.); Bottom trace: load current (5A/div.).  $C_o = 100\mu F$  ceramic +  $1\mu F$  ceramic. Time scale:  $20\mu s/div.$

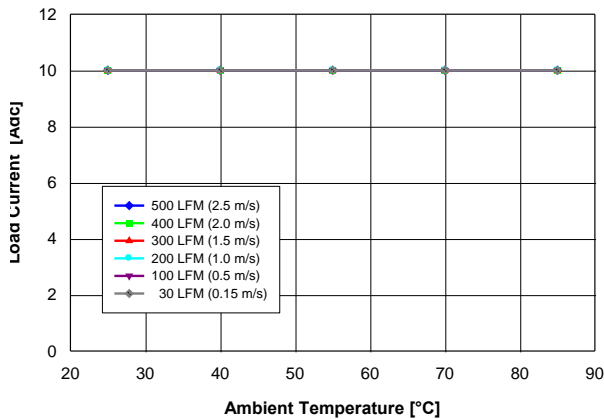

Fig. 0.7525V.1: Available load current vs. ambient temperature and airflow rates for  $V_{out} = 0.7525V$  converter mounted vertically with air flowing from pin 10 to pin 1, and maximum MOSFET temperature  $\leq 120^\circ C$ .

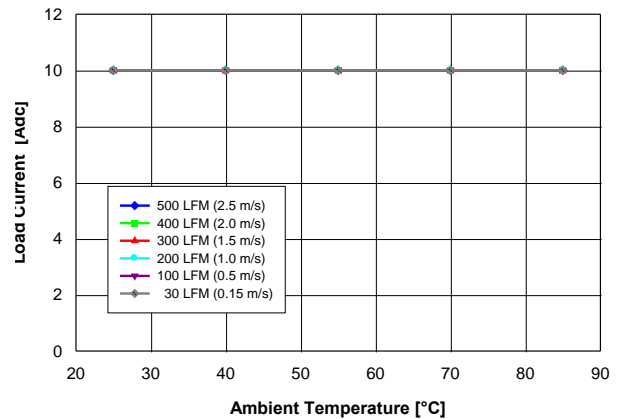

Fig. 0.7525V.2: Available load current vs. ambient temperature and airflow rates for  $V_{out} = 0.7525V$  converter mounted horizontally with air flowing from pin 10 to pin 1, and maximum MOSFET temperature  $\leq 120^\circ C$ .

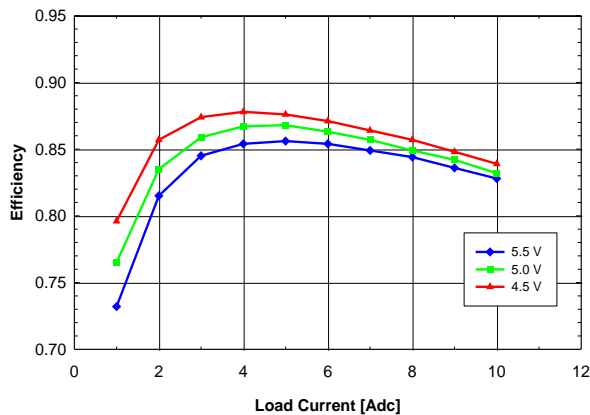

Fig. 0.7525V.3: Efficiency vs. load current and input voltage for  $V_{out} = 0.7525V$  converter mounted vertically with air flowing from pin 10 to pin 1 at a rate of 200 LFM (1m/s) and  $T_a = 25^\circ C$ .

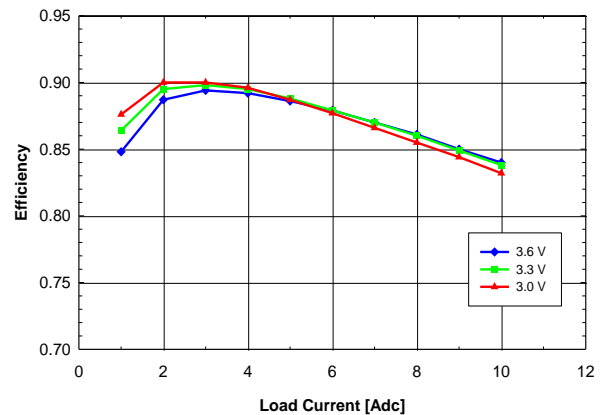

Fig. 0.7525V.4: Efficiency vs. load current and input voltage for  $V_{out} = 0.7525V$  converter mounted vertically with air flowing from pin 10 to pin 1 at a rate of 200 LFM (1m/s) and  $T_a = 25^\circ C$ .

# YNV05T10 DC-DC Converter

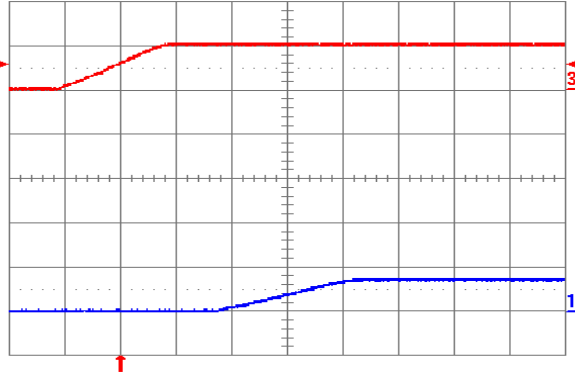

Fig. 0.7525V.5: Turn-on transient for  $V_{out} = 0.7525V$  with application of  $V_{in}$  at full rated load current (resistive) and  $47\mu F$  external capacitance at  $V_{in} = 5V$ . Top trace:  $V_{in}$  (5V/div.); Bottom trace: output voltage (1V/div.); Time scale: 2ms/div.

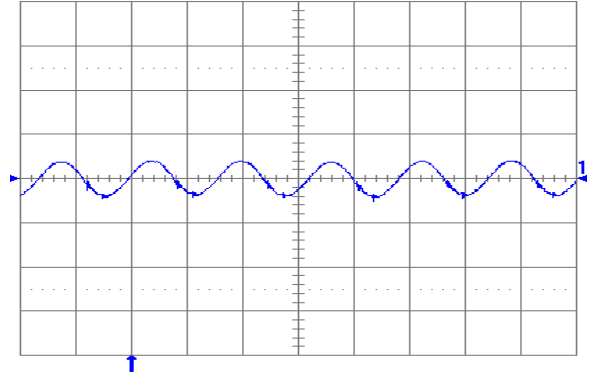

Fig. 0.7525V.6: Output voltage ripple (20mV/div.) at full rated load current into a resistive load with external capacitance  $47\mu F$  ceramic +  $1\mu F$  ceramic and  $V_{in} = 5V$  for  $V_{out} = 0.7525V$ . Time scale: 2 $\mu s$ /div.

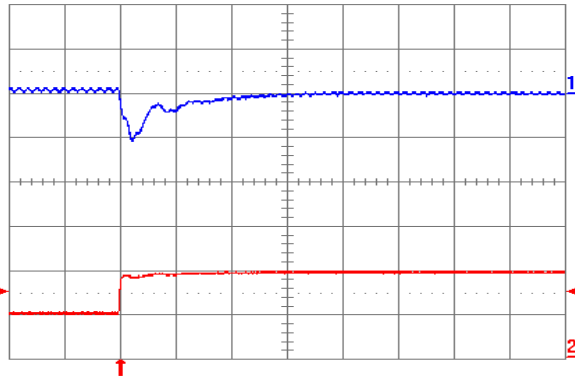

Fig. 0.7525V.7: Output voltage response for  $V_{out} = 0.7525V$  to positive load current step change from 2.5A to 5A with slew rate of  $5A/\mu s$  at  $V_{in} = 5V$ . Top trace: output voltage (100mV/div.); Bottom trace: load current (5A/div.).  $C_o = 100\mu F$  ceramic +  $1\mu F$  ceramic. Time scale: 20 $\mu s$ /div.

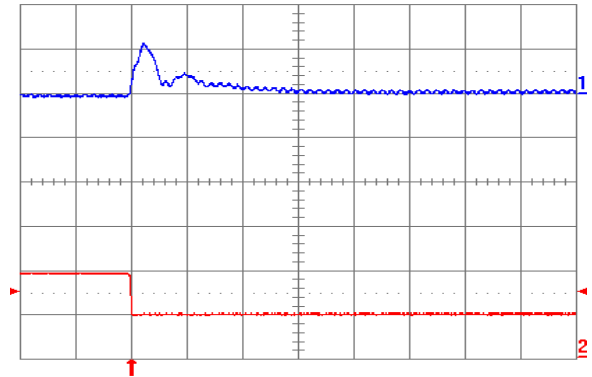
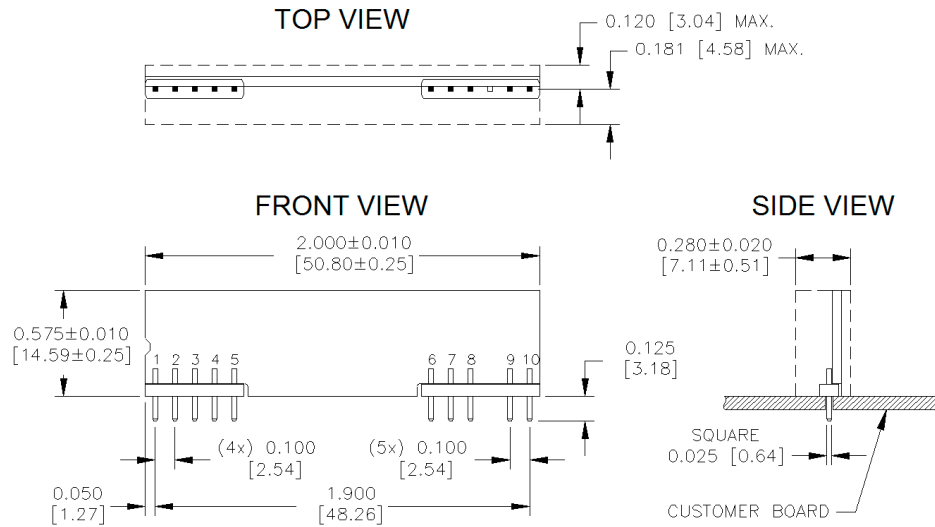

Fig. 0.7525V.8: Output voltage response for  $V_{out} = 0.7525V$  to negative load current step change from 5A to 2.5A with slew rate of  $-5A/\mu s$  at  $V_{in} = 5V$ . Top trace: output voltage (100mV/div.); Bottom trace: load current (5A/div.).  $C_o = 100\mu F$  ceramic +  $1\mu F$  ceramic. Time scale: 20 $\mu s$ /div.

# YNV05T10 DC-DC Converter

## Physical Information



PAD/PIN CONNECTIONS	
Pad/Pin #	Function
1	Vout
2	Vout
3	Vout SENSE
4	Vout
5	GND
6	GND
7	Vin
8	Vin
9	TRIM
10	ON/OFF

**YNV05T10 Pinout (Through-Hole - SIP)**

### YNV05T10 Platform Notes

- All dimensions are in inches [mm]
- Connector Material: Phosphor Bronze/ Brass Alloy 360
- Connector Finish: Tin over Nickel
- Converter Weight: 0.26 oz [7.28 g]
- Converter Height: 0.585" Max.
- Recommended Through Hole Via/Pad: Min. 0.043" X 0.064" [1.09 x 1.63]

## Ordering Information

Product Series	Input Voltage	Mounting Scheme	Rated Load Current	Enable Logic	Environmental
YNV	05	T	10	0	
Y-Series	3.0 – 5.5 V	T ⇒ Through-Hole (SIP)	10 A (0.7525V to 3.63 V)	0 ⇒ Standard (Positive Logic) D ⇒ Opposite of Standard (Negative Logic)	No Suffix ⇒ RoHS lead-solder-exempt compliant G ⇒ RoHS compliant for all six substances

The example above describes P/N YNV05T10-0: 3.0V – 5.5 V input, thru-hole (SIP), 10 A at 0.7525 V to 3.63 V output, standard enable logic, and RoHS lead solder exemption compliant. Please consult factory regarding availability of a specific version.

**For more information on these products consult: [tech.support@psbel.com](mailto:tech.support@psbel.com)**

**NUCLEAR AND MEDICAL APPLICATIONS** - Products are not designed or intended for use as critical components in life support systems, equipment used in hazardous environments, or nuclear control systems.

**TECHNICAL REVISIONS** - The appearance of products, including safety agency certifications pictured on labels, may change depending on the date manufactured. Specifications are subject to change without notice.

Компания «Океан Электроники» предлагает заключение долгосрочных отношений при поставках импортных электронных компонентов на взаимовыгодных условиях!

Наши преимущества:

- Поставка оригинальных импортных электронных компонентов напрямую с производств Америки, Европы и Азии, а так же с крупнейших складов мира;
- Широкая линейка поставок активных и пассивных импортных электронных компонентов (более 30 млн. наименований);
- Поставка сложных, дефицитных, либо снятых с производства позиций;
- Оперативные сроки поставки под заказ (от 5 рабочих дней);
- Экспресс доставка в любую точку России;
- Помощь Конструкторского Отдела и консультации квалифицированных инженеров;
- Техническая поддержка проекта, помощь в подборе аналогов, поставка прототипов;
- Поставка электронных компонентов под контролем ВП;
- Система менеджмента качества сертифицирована по Международному стандарту ISO 9001;
- При необходимости вся продукция военного и аэрокосмического назначения проходит испытания и сертификацию в лаборатории (по согласованию с заказчиком);
- Поставка специализированных компонентов военного и аэрокосмического уровня качества (Xilinx, Altera, Analog Devices, Intersil, Interpoint, Microsemi, Actel, Aeroflex, Peregrine, VPT, Syfer, Eurofarad, Texas Instruments, MS Kennedy, Miteq, Cobham, E2V, MA-COM, Hittite, Mini-Circuits, General Dynamics и др.);

Компания «Океан Электроники» является официальным дистрибьютором и эксклюзивным представителем в России одного из крупнейших производителей разъемов военного и аэрокосмического назначения «JONHON», а так же официальным дистрибьютором и эксклюзивным представителем в России производителя высокотехнологичных и надежных решений для передачи СВЧ сигналов «FORSTAR».



## JONHON

«JONHON» (основан в 1970 г.)

Разъемы специального, военного и аэрокосмического назначения:

(Применяются в военной, авиационной, аэрокосмической, морской, железнодорожной, горно- и нефтедобывающей отраслях промышленности)

«FORSTAR» (основан в 1998 г.)

ВЧ соединители, коаксиальные кабели,  
кабельные сборки и микроволновые компоненты:

(Применяются в телекоммуникациях гражданского и специального назначения, в средствах связи, РЛС, а так же военной, авиационной и аэрокосмической отраслях промышленности).



Телефон: 8 (812) 309-75-97 (многоканальный)

Факс: 8 (812) 320-03-32

Электронная почта: [ocean@oceanchips.ru](mailto:ocean@oceanchips.ru)

Web: <http://oceanchips.ru/>

Адрес: 198099, г. Санкт-Петербург, ул. Калинина, д. 2, корп. 4, лит. А