

True low-power platform (66 $\mu\text{A}/\text{MHz}$, and 0.60 μA for operation with only RTC and LVD) for the general-purpose applications, with 1.6-V to 5.5-V operation, 16- to 512-Kbyte code flash memory, and 44 DMIPS at 32 MHz

1. OUTLINE

1.1 Features

Ultra-Low Power Consumption Technology

- V_{DD} = single power supply voltage of 1.6 to 5.5 V which can operate a 1.8 V device at a low voltage
- HALT mode
- STOP mode
- SNOOZE mode

RL78 CPU Core

- CISC architecture with 3-stage pipeline
- Minimum instruction execution time: Can be changed from high speed (0.03125 μs : @ 32 MHz operation with high-speed on-chip oscillator) to ultra-low speed (30.5 μs : @ 32.768 kHz operation with subsystem clock)
- Multiply/divide/multiply & accumulate instructions are supported.
- Address space: 1 MB
- General-purpose registers: (8-bit register \times 8) \times 4 banks
- On-chip RAM: 2.5 to 48 KB

Code Flash Memory

- Code flash memory: 16 to 512 KB
- Block size: 1 KB
- Prohibition of block erase and rewriting (security function)
- On-chip debug function
- Self-programming (with boot swap function/flash shield window function)

Data Flash Memory

- Data flash memory: 4 KB and 8 KB
- Back ground operation (BGO): Instructions can be executed from the program memory while rewriting the data flash memory.
- Number of rewrites: 1,000,000 times (TYP.)
- Voltage of rewrites: $V_{DD} = 1.8$ to 5.5 V

High-speed On-chip Oscillator

- Select from 64 MHz, 48 MHz, 32 MHz, 24 MHz, 16 MHz, 12 MHz, 8 MHz, 6 MHz, 4 MHz, 3 MHz, 2 MHz, and 1 MHz
- High accuracy: $\pm 1.0\%$ ($V_{DD} = 1.8$ to 5.5 V, $T_A = -20$ to $+85^\circ\text{C}$)

Operating Ambient Temperature

- $T_A = -40$ to $+85^\circ\text{C}$ (A: Consumer applications, D: Industrial applications)
- $T_A = -40$ to $+105^\circ\text{C}$ (G: Industrial applications)

Power Management and Reset Function

- On-chip power-on-reset (POR) circuit
- On-chip voltage detector (LVD) (Select interrupt and reset from 14 levels)

Data Transfer Controller (DTC)

- Transfer modes: Normal transfer mode, repeat transfer mode, block transfer mode
- Activation sources: Activated by interrupt sources.
- Chain transfer function

Event Link Controller (ELC)

- Event signals of 19 to 26 types can be linked to the specified peripheral function.

Serial Interfaces

- CSI: 3 to 8 channels
- UART/UART (LIN-bus supported): 3 or 4 channels
- I²C/simplified I²C: 3 to 8 channels

Timer

- 16-bit timer: 8 to 12 channels (Timer Array Unit (TAU): 4 to 8 channels, Timer RJ: 1 channel, Timer RD: 2 channels, Timer RG: 1 channel)
- 12-bit interval timer: 1 channel
- Real-time clock: 1 channel (calendar for 99 years, alarm function, and clock correction function)
- Watchdog timer: 1 channel (operable with the dedicated low-speed on-chip oscillator)

A/D Converter

- 8/10-bit resolution A/D converter ($V_{DD} = 1.6$ to 5.5 V)
- Analog input: 8 to 20 channels
- Internal reference voltage (1.45 V) and temperature sensor

D/A Converter

- 8-bit resolution D/A converter ($V_{DD} = 1.6$ to 5.5 V)
- Analog output: None or up to two channels
- Output voltage: 0 V to V_{DD}
- Real-time output function

Comparator

- None or up to two channels
- Operating modes: Comparator high-speed mode, comparator low-speed mode, window mode
- The external reference voltage or internal reference voltage can be selected as the reference voltage.

I/O Port

- I/O port: 26 to 92 (N-ch open drain I/O [withstand voltage of 6 V]: 2 to 4, N-ch open drain I/O [V_{DD} withstand voltage/EV_{DD} withstand voltage]: 10 to 28)
- Can be set to N-ch open drain, TTL input buffer, and on-chip pull-up resistor
- Different potential interface: Can connect to a 1.8/2.5/3 V device
- On-chip key interrupt function
- On-chip clock output/buzzer output controller

Others

- On-chip BCD (binary-coded decimal) correction circuit

Remark The functions mounted depend on the product. See 1.6 Outline of Functions.

○ ROM, RAM capacities

| Flash ROM | Data flash | RAM | RL78/G14 | | | |
|-----------|------------|-------------|----------|----------|----------|----------|
| | | | 30 pins | 32 pins | 36 pins | 40 pins |
| 192 KB | 8 KB | 20 KB | — | — | — | R5F104EH |
| 128 KB | 8 KB | 16 KB | R5F104AG | R5F104BG | R5F104CG | R5F104EG |
| 96 KB | 8 KB | 12 KB | R5F104AF | R5F104BF | R5F104CF | R5F104EF |
| 64 KB | 4 KB | 5.5 KB Note | R5F104AE | R5F104BE | R5F104CE | R5F104EE |
| 48 KB | 4 KB | 5.5 KB Note | R5F104AD | R5F104BD | R5F104CD | R5F104ED |
| 32 KB | 4 KB | 4 KB | R5F104AC | R5F104BC | R5F104CC | R5F104EC |
| 16 KB | 4 KB | 2.5 KB | R5F104AA | R5F104BA | R5F104CA | R5F104EA |

| Flash ROM | Data flash | RAM | RL78/G14 | | | |
|-----------|------------|-------------|----------|----------|----------|----------|
| | | | 44 pins | 48 pins | 52 pins | 64 pins |
| 512 KB | 8 KB | 48 KB Note | — | R5F104GL | — | R5F104LL |
| 384 KB | 8 KB | 32 KB | — | R5F104GK | — | R5F104LK |
| 256 KB | 8 KB | 24 KB Note | R5F104FJ | R5F104GJ | R5F104JJ | R5F104LJ |
| 192 KB | 8 KB | 20 KB | R5F104FH | R5F104GH | R5F104JH | R5F104LH |
| 128 KB | 8 KB | 16 KB | R5F104FG | R5F104GG | R5F104JG | R5F104LG |
| 96 KB | 8 KB | 12 KB | R5F104FF | R5F104GF | R5F104JF | R5F104LF |
| 64 KB | 4 KB | 5.5 KB Note | R5F104FE | R5F104GE | R5F104JE | R5F104LE |
| 48 KB | 4 KB | 5.5 KB Note | R5F104FD | R5F104GD | R5F104JD | R5F104LD |
| 32 KB | 4 KB | 4 KB | R5F104FC | R5F104GC | R5F104JC | R5F104LC |
| 16 KB | 4 KB | 2.5 KB | R5F104FA | R5F104GA | — | — |

| Flash ROM | Data flash | RAM | RL78/G14 | |
|-----------|------------|------------|----------|----------|
| | | | 80 pins | 100 pins |
| 512 KB | 8 KB | 48 KB Note | R5F104ML | R5F104PL |
| 384 KB | 8 KB | 32 KB | R5F104MK | R5F104PK |
| 256 KB | 8 KB | 24 KB Note | R5F104MJ | R5F104PJ |
| 192 KB | 8 KB | 20 KB | R5F104MH | R5F104PH |
| 128 KB | 8 KB | 16 KB | R5F104MG | R5F104PG |
| 96 KB | 8 KB | 12 KB | R5F104MF | R5F104PF |

Note The flash library uses RAM in self-programming and rewriting of the data flash memory.
The target products and start address of the RAM areas used by the flash library are shown below.

R5F104xD (x = A to C, E to G, J, L): Start address FE900H

R5F104xE (x = A to C, E to G, J, L): Start address FE900H

R5F104xJ (x = F, G, J, L, M, P): Start address F9F00H

R5F104xL (x = G, L, M, P): Start address F3F00H

For the RAM areas used by the flash library, see **Self RAM list of Flash Self-Programming Library for RL78 Family (R20UT2944)**.

1.2 Ordering Information

<R>

Figure 1 - 1 Part Number, Memory Size, and Package of RL78/G14

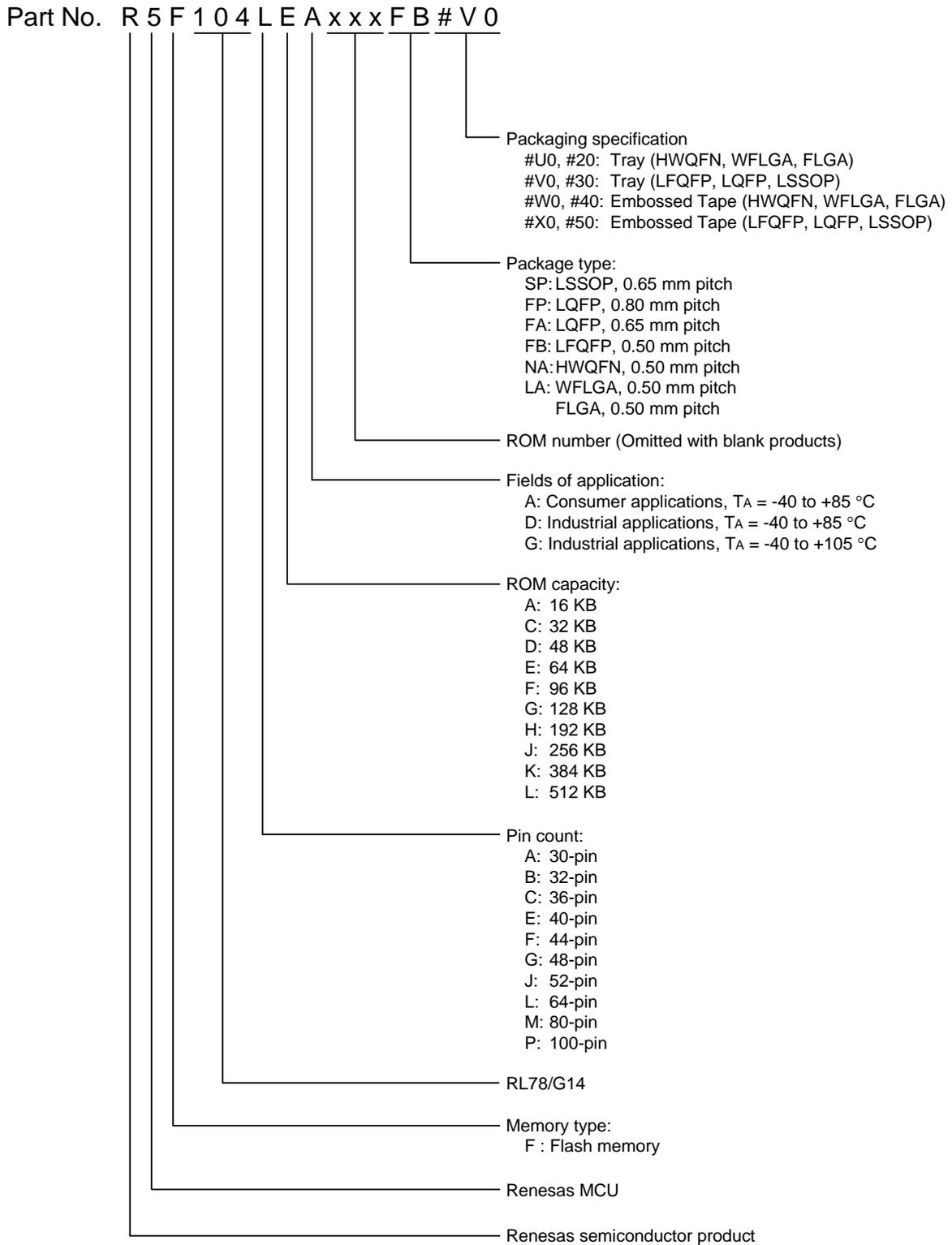

<R>

Table 1 - 1 List of Ordering Part Numbers (1/12)

| Pin count | Package | Fields of Application Note | Ordering Part Number | RENESAS Code |
|-----------|---|----------------------------|--|--------------|
| 30 pins | 30-pin plastic LSSOP (7.62 mm (300), 0.65 mm pitch) | A | R5F104AAASP#V0, R5F104ACASP#V0, R5F104ADASP#V0, R5F104AEASP#V0, R5F104AFASP#V0, R5F104AGASP#V0 R5F104AAASP#X0, R5F104ACASP#X0, R5F104ADASP#X0, R5F104AEASP#X0, R5F104AFASP#X0, R5F104AGASP#X0 R5F104AAASP#30, R5F104ACASP#30, R5F104ADASP#30, R5F104AEASP#30, R5F104AFASP#30, R5F104AGASP#30 R5F104AAASP#50, R5F104ACASP#50, R5F104ADASP#50, R5F104AEASP#50, R5F104AFASP#50, R5F104AGASP#50 | PLSP0030JB-B |
| | | D | R5F104AADSP#V0, R5F104ACDSP#V0, R5F104ADDSP#V0, R5F104AEDSP#V0, R5F104AFDSP#V0, R5F104AGDSP#V0 R5F104AADSP#X0, R5F104ACDSP#X0, R5F104ADDSP#X0, R5F104AEDSP#X0, R5F104AFDSP#X0, R5F104AGDSP#X0 R5F104AADSP#30, R5F104ACDSP#30, R5F104ADDSP#30, R5F104AEDSP#30, R5F104AFDSP#30, R5F104AGDSP#30 R5F104AADSP#50, R5F104ACDSP#50, R5F104ADDSP#50, R5F104AEDSP#50, R5F104AFDSP#50, R5F104AGDSP#50 | |
| | | G | R5F104AAGSP#V0, R5F104ACGSP#V0, R5F104ADGSP#V0, R5F104AEGSP#V0, R5F104AFGSP#V0, R5F104AGGSP#V0 R5F104AAGSP#X0, R5F104ACGSP#X0, R5F104ADGSP#X0, R5F104AEGSP#X0, R5F104AFGSP#X0, R5F104AGGSP#X0 R5F104AAGSP#30, R5F104ACGSP#30, R5F104ADGSP#30, R5F104AEGSP#30, R5F104AFGSP#30, R5F104AGGSP#30 R5F104AAGSP#50, R5F104ACGSP#50, R5F104ADGSP#50, R5F104AEGSP#50, R5F104AFGSP#50, R5F104AGGSP#50 | |

Note For the fields of application, refer to **Figure 1 - 1 Part Number, Memory Size, and Package of RL78/G14**.

Caution The ordering part numbers represent the numbers at the time of publication. For the latest ordering part numbers, refer to the target product page of the Renesas Electronics website.

<R>

Table 1 - 1 List of Ordering Part Numbers (2/12)

| Pin count | Package | Fields of Application Note | Ordering Part Number | RENESAS Code | | |
|-----------|---|--|--|--|--|--------------|
| 32 pins | 32-pin plastic HWQFN (5 × 5 mm, 0.5 mm pitch) | A | R5F104BAANA#U0, R5F104BCANA#U0, R5F104BDANA#U0, R5F104BEANA#U0, R5F104BFANA#U0, R5F104BGANA#U0 R5F104BAANA#W0, R5F104BCANA#W0, R5F104BDANA#W0, R5F104BEANA#W0, R5F104BFANA#W0, R5F104BGANA#W0 | PWQN0032KB-A | | |
| | | | R5F104BAANA#20, R5F104BCANA#20, R5F104BDANA#20, R5F104BEANA#20, R5F104BFANA#20, R5F104BGANA#20 R5F104BAANA#40, R5F104BCANA#40, R5F104BDANA#40, R5F104BEANA#40, R5F104BFANA#40, R5F104BGANA#40 | PWQN0032KE-A | | |
| | | D | R5F104BADNA#U0, R5F104BCDNA#U0, R5F104BDDNA#U0, R5F104BEDNA#U0, R5F104BFDNA#U0, R5F104BGDNA#U0 R5F104BADNA#W0, R5F104BCDNA#W0, R5F104BDDNA#W0, R5F104BEDNA#W0, R5F104BFDNA#W0, R5F104BGDNA#W0 | PWQN0032KB-A | | |
| | | | G | R5F104BAGNA#U0, R5F104BCGNA#U0, R5F104BDGNA#U0, R5F104BEGNA#U0, R5F104BFGNA#U0, R5F104BGGNA#U0 R5F104BAGNA#W0, R5F104BCGNA#W0, R5F104BDGNA#W0, R5F104BEGNA#W0, R5F104BFGNA#W0, R5F104BGGNA#W0 | PWQN0032KE-A | |
| | | R5F104BAGNA#20, R5F104BCGNA#20, R5F104BDGNA#20, R5F104BEGNA#20, R5F104BFGNA#20, R5F104BGGNA#20 R5F104BAGNA#40, R5F104BCGNA#40, R5F104BDGNA#40, R5F104BEGNA#40, R5F104BFGNA#40, R5F104BGGNA#40 | | | | |
| | | 32-pin plastic LQFP (7 × 7 mm, 0.8 mm pitch) | | A | R5F104BAAFP#V0, R5F104BCAFP#V0, R5F104BDAFP#V0, R5F104BEAFP#V0, R5F104BFAFP#V0, R5F104BGAFP#V0 R5F104BAAFP#X0, R5F104BCAFP#X0, R5F104BDAFP#X0, R5F104BEAFP#X0, R5F104BFAFP#X0, R5F104BGAFP#X0 R5F104BAAFP#30, R5F104BCAFP#30, R5F104BDAFP#30, R5F104BEAFP#30, R5F104BFAFP#30, R5F104BGAFP#30 R5F104BAAFP#50, R5F104BCAFP#50, R5F104BDAFP#50, R5F104BEAFP#50, R5F104BFAFP#50, R5F104BGAFP#50 | PLQP0032GB-A |
| | | | | | D | |
| | | | | G | | |
| | | | | | | |

Note For the fields of application, refer to **Figure 1 - 1 Part Number, Memory Size, and Package of RL78/G14**.

Caution The ordering part numbers represent the numbers at the time of publication. For the latest ordering part numbers, refer to the target product page of the Renesas Electronics website.

<R>

Table 1 - 1 List of Ordering Part Numbers (3/12)

| Pin count | Package | Fields of Application Note | Ordering Part Number | RENESAS Code |
|-----------|--|----------------------------|--|--------------|
| 36 pins | 36-pin plastic WFLGA (4 × 4 mm, 0.5 mm pitch) | A | R5F104CAALA#U0, R5F104CCALA#U0, R5F104CDALA#U0, R5F104CEALA#U0, R5F104CFALA#U0, R5F104CGALA#U0 R5F104CAALA#W0, R5F104CCALA#W0, R5F104CDALA#W0, R5F104CEALA#W0, R5F104CFALA#W0, R5F104CGALA#W0 | PWL0036KA-A |
| | | G | R5F104CAGLA#U0, R5F104CCGLA#U0, R5F104CDGLA#U0, R5F104CEGLA#U0, R5F104CFGLA#U0, R5F104CGGLA#U0 R5F104CAGLA#W0, R5F104CCGLA#W0, R5F104CDGLA#W0, R5F104CEGLA#W0, R5F104CFGLA#W0, R5F104CGGLA#W0 | |
| 40 pins | 40-pin plastic HWQFN (6 × 6 mm, 0.5 mm pitch) | A | R5F104EAANA#U0, R5F104ECANA#U0, R5F104EDANA#U0, R5F104EEANA#U0, R5F104EFANA#U0, R5F104EGANA#U0, R5F104EHANA#U0 R5F104EAANA#W0, R5F104ECANA#W0, R5F104EDANA#W0, R5F104EEANA#W0, R5F104EFANA#W0, R5F104EGANA#W0, R5F104EHANA#W0 | PWQN0040KC-A |
| | | D | R5F104EADNA#U0, R5F104ECDNA#U0, R5F104EDDNA#U0, R5F104EEDNA#U0, R5F104EFDNA#U0, R5F104EGDNA#U0, R5F104EHDNA#U0 R5F104EADNA#W0, R5F104ECDNA#W0, R5F104EDDNA#W0, R5F104EEDNA#W0, R5F104EFDNA#W0, R5F104EGDNA#W0, R5F104EHDNA#W0 | |
| | | G | R5F104EAGNA#U0, R5F104ECGNA#U0, R5F104EDGNA#U0, R5F104EEGNA#U0, R5F104EFGNA#U0, R5F104EGGNA#U0, R5F104EHGNA#U0 R5F104EAGNA#W0, R5F104ECGNA#W0, R5F104EDGNA#W0, R5F104EEGNA#W0, R5F104EFGNA#W0, R5F104EGGNA#W0, R5F104EHGNA#W0 | |

Note For the fields of application, refer to **Figure 1 - 1 Part Number, Memory Size, and Package of RL78/G14**.

Caution The ordering part numbers represent the numbers at the time of publication. For the latest ordering part numbers, refer to the target product page of the Renesas Electronics website.

<R>

Table 1 - 1 List of Ordering Part Numbers (4/12)

| Pin count | Package | Fields of Application Note | Ordering Part Number | RENESAS Code | |
|-----------|--|----------------------------|--|--------------|-------------------------------|
| 44 pins | 44-pin plastic LQFP (10 × 10 mm, 0.8 mm pitch) | A | R5F104FAAFP#V0, R5F104FCAFP#V0, R5F104FDAFP#V0, R5F104FEAFP#V0, R5F104FFAFP#V0, R5F104FGAFP#V0, R5F104FHAFP#V0, R5F104FJAFP#V0 | PLQP0044GC-A | |
| | | | R5F104FAAFP#X0, R5F104FCAFP#X0, R5F104FDAFP#X0, R5F104FEAFP#X0, R5F104FFAFP#X0, R5F104FGAFP#X0, R5F104FHAFP#X0, R5F104FJAFP#X0 | | |
| | | | R5F104FAAFP#30, R5F104FCAFP#30, R5F104FDAFP#30, R5F104FEAFP#30, R5F104FFAFP#30, R5F104FGAFP#30, R5F104FHAFP#30, R5F104FJAFP#30 | | PLQP0044GC-A/ PLQP0044GC-D |
| | | | R5F104FAAFP#50, R5F104FCAFP#50, R5F104FDAFP#50, R5F104FEAFP#50, R5F104FFAFP#50, R5F104FGAFP#50, R5F104FHAFP#50, R5F104FJAFP#50 | | |
| | | D | R5F104FADFP#V0, R5F104FCDFP#V0, R5F104FDDFP#V0, R5F104FEDFP#V0, R5F104FFDFP#V0, R5F104FGDFP#V0, R5F104FHDFP#V0, R5F104FJDFP#V0 | PLQP0044GC-A | |
| | | | R5F104FADFP#X0, R5F104FCDFP#X0, R5F104FDDFP#X0, R5F104FEDFP#X0, R5F104FFDFP#X0, R5F104FGDFP#X0, R5F104FHDFP#X0, R5F104FJDFP#X0 | | |
| | | | R5F104FADFP#30, R5F104FCDFP#30, R5F104FDDFP#30, R5F104FEDFP#30, R5F104FFDFP#30, R5F104FGDFP#30, R5F104FHDFP#30, R5F104FJDFP#30 | | PLQP0044GC-A/ PLQP0044GC-D |
| | | | R5F104FADFP#50, R5F104FCDFP#50, R5F104FDDFP#50, R5F104FEDFP#50, R5F104FFDFP#50, R5F104FGDFP#50, R5F104FHDFP#50, R5F104FJDFP#50 | | |
| | | G | R5F104FAGFP#V0, R5F104FCGFP#V0, R5F104FDGFP#V0, R5F104FEGFP#V0, R5F104FFGFP#V0, R5F104FGGFP#V0, R5F104FHGFP#V0, R5F104FJGFP#V0 | PLQP0044GC-A | |
| | | | R5F104FAGFP#X0, R5F104FCGFP#X0, R5F104FDGFP#X0, R5F104FEGFP#X0, R5F104FFGFP#X0, R5F104FGGFP#X0, R5F104FHGFP#X0, R5F104FJGFP#X0 | | |
| | | | R5F104FAGFP#30, R5F104FCGFP#30, R5F104FDGFP#30, R5F104FEGFP#30, R5F104FFGFP#30, R5F104FGGFP#30, R5F104FHGFP#30, R5F104FJGFP#30 | | PLQP0044GC-A/ PLQP0044GC-D |
| | | | R5F104FAGFP#50, R5F104FCGFP#50, R5F104FDGFP#50, R5F104FEGFP#50, R5F104FFGFP#50, R5F104FGGFP#50, R5F104FHGFP#50, R5F104FJGFP#50 | | |

Note For the fields of application, refer to **Figure 1 - 1 Part Number, Memory Size, and Package of RL78/G14**.

Caution The ordering part numbers represent the numbers at the time of publication. For the latest ordering part numbers, refer to the target product page of the Renesas Electronics website.

<R>

Table 1 - 1 List of Ordering Part Numbers (5/12)

| Pin count | Package | Fields of Application Note | Ordering Part Number | RENESAS Code | |
|-----------|---|----------------------------|--|--------------|--------------|
| 48 pins | 48-pin plastic LFQFP (7 × 7 mm, 0.5 mm pitch) | A | R5F104GAAFB#V0, R5F104GCAFB#V0, R5F104GDADF#V0, R5F104GEAFB#V0, R5F104GFafb#V0, R5F104GGAFB#V0, R5F104GHAFB#V0, R5F104GJAFB#V0 | PLQP0048KF-A | |
| | | | R5F104GAAFB#X0, R5F104GCAFB#X0, R5F104GDADF#X0, R5F104GEAFB#X0, R5F104GFafb#X0, R5F104GGAFB#X0, R5F104GHAFB#X0, R5F104GJAFB#X0 | | |
| | | | R5F104GAAFB#30, R5F104GCAFB#30, R5F104GDADF#30, R5F104GEAFB#30, R5F104GFafb#30, R5F104GGAFB#30, R5F104GHAFB#30, R5F104GJAFB#30, R5F104GKAFB#30, R5F104GLAFB#30 | | PLQP0048KB-B |
| | | | R5F104GAAFB#50, R5F104GCAFB#50, R5F104GDADF#50, R5F104GEAFB#50, R5F104GFafb#50, R5F104GGAFB#50, R5F104GHAFB#50, R5F104GJAFB#50, R5F104GKAFB#50, R5F104GLAFB#50 | | |
| | | D | R5F104GADFB#V0, R5F104GCDFB#V0, R5F104GDDFB#V0, R5F104GEDFB#V0, R5F104GFDFB#V0, R5F104GGDFB#V0, R5F104GHDFB#V0, R5F104GJDFB#V0 | PLQP0048KF-A | |
| | | | R5F104GADFB#X0, R5F104GCDFB#X0, R5F104GDDFB#X0, R5F104GEDFB#X0, R5F104GFDFB#X0, R5F104GGDFB#X0, R5F104GHDFB#X0, R5F104GJDFB#X0 | | |
| | | | R5F104GADFB#30, R5F104GCDFB#30, R5F104GDDFB#30, R5F104GEDFB#30, R5F104GFDFB#30, R5F104GGDFB#30, R5F104GHDFB#30, R5F104GJDFB#30 | | PLQP0048KB-B |
| | | | R5F104GADFB#50, R5F104GCDFB#50, R5F104GDDFB#50, R5F104GEDFB#50, R5F104GFDFB#50, R5F104GGDFB#50, R5F104GHDFB#50, R5F104GJDFB#50 | | |
| | | G | R5F104GAGFB#V0, R5F104GCGFB#V0, R5F104GDGFB#V0, R5F104GEGFB#V0, R5F104GFGFB#V0, R5F104GGGFB#V0, R5F104GHGFB#V0, R5F104GJGFB#V0 | PLQP0048KF-A | |
| | | | R5F104GAGFB#X0, R5F104GCGFB#X0, R5F104GDGFB#X0, R5F104GEGFB#X0, R5F104GFGFB#X0, R5F104GGGFB#X0, R5F104GHGFB#X0, R5F104GJGFB#X0 | | |
| | | | R5F104GAGFB#30, R5F104GCGFB#30, R5F104GDGFB#30, R5F104GEGFB#30, R5F104GFGFB#30, R5F104GGGFB#30, R5F104GHGFB#30, R5F104GJGFB#30, R5F104GKGF#30, R5F104GLGFB#30 | | PLQP0048KB-B |
| | | | R5F104GAGFB#50, R5F104GCGFB#50, R5F104GDGFB#50, R5F104GEGFB#50, R5F104GFGFB#50, R5F104GGGFB#50, R5F104GHGFB#50, R5F104GJGFB#50, R5F104GKGF#50, R5F104GLGFB#50 | | |

Note For the fields of application, refer to **Figure 1 - 1 Part Number, Memory Size, and Package of RL78/G14**.

Caution The ordering part numbers represent the numbers at the time of publication. For the latest ordering part numbers, refer to the target product page of the Renesas Electronics website.

<R>

Table 1 - 1 List of Ordering Part Numbers (6/12)

| Pin count | Package | Fields of Application Note | Ordering Part Number | RENESAS Code |
|-----------|--|----------------------------|--|--------------|
| 48 pins | 48-pin plastic HWQFN (7 × 7 mm, 0.5 mm pitch) | A | R5F104GAANA#U0, R5F104GCANA#U0, R5F104GDANA#U0, R5F104GEANA#U0, R5F104GFANA#U0, R5F104GGANA#U0, R5F104GHANA#U0, R5F104GJANA#U0, R5F104GKANA#U0, R5F104GLANA#U0 R5F104GAANA#W0, R5F104GCANA#W0, R5F104GDANA#W0, R5F104GEANA#W0, R5F104GFANA#W0, R5F104GGANA#W0, R5F104GHANA#W0, R5F104GJANA#W0, R5F104GKANA#W0, R5F104GLANA#W0 | PWQN0048KB-A |
| | | D | R5F104GADNA#U0, R5F104GCDNA#U0, R5F104GDDNA#U0, R5F104GEDNA#U0, R5F104GFDNA#U0, R5F104GGDNA#U0, R5F104GHDNA#U0, R5F104GJDNA#U0 R5F104GADNA#W0, R5F104GCDNA#W0, R5F104GDDNA#W0, R5F104GEDNA#W0, R5F104GFDNA#W0, R5F104GGDNA#W0, R5F104GHDNA#W0, R5F104GJDNA#W0 | |
| | | G | R5F104GAGNA#U0, R5F104GCGNA#U0, R5F104GDGNA#U0, R5F104GEGNA#U0, R5F104GFGNA#U0, R5F104GGGNA#U0, R5F104GHGNA#U0, R5F104GJGNA#U0, R5F104GKGNA#U0, R5F104GLGNA#U0 R5F104GAGNA#W0, R5F104GCGNA#W0, R5F104GDGNA#W0, R5F104GEGNA#W0, R5F104GFGNA#W0, R5F104GGGNA#W0, R5F104GHGNA#W0, R5F104GJGNA#W0, R5F104GKGNA#W0, R5F104GLGNA#W0 | |

Note For the fields of application, refer to **Figure 1 - 1 Part Number, Memory Size, and Package of RL78/G14**.

Caution The ordering part numbers represent the numbers at the time of publication. For the latest ordering part numbers, refer to the target product page of the Renesas Electronics website.

<R>

Table 1 - 1 List of Ordering Part Numbers (7/12)

| Pin count | Package | Fields of Application Note | Ordering Part Number | RENESAS Code |
|-----------|---|----------------------------|--|--------------|
| 52 pins | 52-pin plastic LQFP (10 × 10 mm, 0.65 mm pitch) | A | R5F104JCAFA#V0, R5F104JDAFA#V0, R5F104JEAFA#V0, R5F104JFAFA#V0, R5F104JGFAFA#V0, R5F104JHFAFA#V0, R5F104JJFAFA#V0 R5F104JCAFA#X0, R5F104JDAFA#X0, R5F104JEAFA#X0, R5F104JFAFA#X0, R5F104JGFAFA#X0, R5F104JHFAFA#X0, R5F104JJFAFA#X0 R5F104JCAFA#30, R5F104JDAFA#30, R5F104JEAFA#30, R5F104JFAFA#30, R5F104JGFAFA#30, R5F104JHFAFA#30, R5F104JJFAFA#30 R5F104JCAFA#50, R5F104JDAFA#50, R5F104JEAFA#50, R5F104JFAFA#50, R5F104JGFAFA#50, R5F104JHFAFA#50, R5F104JJFAFA#50 | PLQP0052JA-A |
| | | D | R5F104JCDFA#V0, R5F104JDDFA#V0, R5F104JEDFA#V0, R5F104JFDFA#V0, R5F104JGDFA#V0, R5F104JHDFFA#V0, R5F104JJDFFA#V0 R5F104JCDFA#X0, R5F104JDDFA#X0, R5F104JEDFA#X0, R5F104JFDFA#X0, R5F104JGDFA#X0, R5F104JHDFFA#X0, R5F104JJDFFA#X0 R5F104JCDFA#30, R5F104JDDFA#30, R5F104JEDFA#30, R5F104JFDFA#30, R5F104JGDFA#30, R5F104JHDFFA#30, R5F104JJDFFA#30 R5F104JCDFA#50, R5F104JDDFA#50, R5F104JEDFA#50, R5F104JFDFA#50, R5F104JGDFA#50, R5F104JHDFFA#50, R5F104JJDFFA#50 | |
| | | G | R5F104JCGFA#V0, R5F104JDGFA#V0, R5F104JEGFA#V0, R5F104JFGFA#V0, R5F104JGGFA#V0, R5F104JHGFA#V0, R5F104JJGFA#V0 R5F104JCGFA#X0, R5F104JDGFA#X0, R5F104JEGFA#X0, R5F104JFGFA#X0, R5F104JGGFA#X0, R5F104JHGFA#X0, R5F104JJGFA#X0 R5F104JCGFA#30, R5F104JDGFA#30, R5F104JEGFA#30, R5F104JFGFA#30, R5F104JGGFA#30, R5F104JHGFA#30, R5F104JJGFA#30 R5F104JCGFA#50, R5F104JDGFA#50, R5F104JEGFA#50, R5F104JFGFA#50, R5F104JGGFA#50, R5F104JHGFA#50, R5F104JJGFA#50 | |

Note For the fields of application, refer to **Figure 1 - 1 Part Number, Memory Size, and Package of RL78/G14**.

Caution The ordering part numbers represent the numbers at the time of publication. For the latest ordering part numbers, refer to the target product page of the Renesas Electronics website.

<R>

Table 1 - 1 List of Ordering Part Numbers (8/12)

| Pin count | Package | Fields of Application <small>Note</small> | Ordering Part Number | RENESAS Code |
|-----------|---|---|--|--------------|
| 64 pins | 64-pin plastic LQFP (12 × 12 mm, 0.65 mm pitch) | A | R5F104LCAFA#V0, R5F104LDAFA#V0, R5F104LEAFA#V0, R5F104LFafa#V0, R5F104LGafa#V0, R5F104LHafa#V0, R5F104LJafa#V0 R5F104LCAFA#X0, R5F104LDAFA#X0, R5F104LEAFA#X0, R5F104LFafa#X0, R5F104LGafa#X0, R5F104LHafa#X0, R5F104LJafa#X0 R5F104LCAFA#30, R5F104LDAFA#30, R5F104LEAFA#30, R5F104LFafa#30, R5F104LGafa#30, R5F104LHafa#30, R5F104LJafa#30, R5F104LKafa#30, R5F104LLafa#30 R5F104LCAFA#50, R5F104LDAFA#50, R5F104LEAFA#50, R5F104LFafa#50, R5F104LGafa#50, R5F104LHafa#50, R5F104LJafa#50, R5F104LKafa#50, R5F104LLafa#50 | PLQP0064JA-A |
| | | D | R5F104LCDFA#V0, R5F104LDDFA#V0, R5F104LEDFA#V0, R5F104LFDFA#V0, R5F104LGdFA#V0, R5F104LHDFA#V0, R5F104LJDFA#V0 R5F104LCDFA#X0, R5F104LDDFA#X0, R5F104LEDFA#X0, R5F104LFDFA#X0, R5F104LGdFA#X0, R5F104LHDFA#X0, R5F104LJDFA#X0 R5F104LCDFA#30, R5F104LDDFA#30, R5F104LEDFA#30, R5F104LFDFA#30, R5F104LGdFA#30, R5F104LHDFA#30, R5F104LJDFA#30 R5F104LCDFA#50, R5F104LDDFA#50, R5F104LEDFA#50, R5F104LFDFA#50, R5F104LGdFA#50, R5F104LHDFA#50, R5F104LJDFA#50 | |
| | | G | R5F104LCGFA#V0, R5F104LDGFA#V0, R5F104LEGFA#V0, R5F104LFGFA#V0, R5F104LGGFA#V0, R5F104LHGFA#V0, R5F104LJGFA#V0 R5F104LCGFA#X0, R5F104LDGFA#X0, R5F104LEGFA#X0, R5F104LFGFA#X0, R5F104LGGFA#X0, R5F104LHGFA#X0, R5F104LJGFA#X0 R5F104LCGFA#30, R5F104LDGFA#30, R5F104LEGFA#30, R5F104LFGFA#30, R5F104LGGFA#30, R5F104LHGFA#30, R5F104LJGFA#30, R5F104LKGFA#30, R5F104LLGFA#30 R5F104LCGFA#50, R5F104LDGFA#50, R5F104LEGFA#50, R5F104LFGFA#50, R5F104LGGFA#50, R5F104LHGFA#50, R5F104LJGFA#50, R5F104LKGFA#50, R5F104LLGFA#50 | |

Note For the fields of application, refer to **Figure 1 - 1 Part Number, Memory Size, and Package of RL78/G14.**

Caution The ordering part numbers represent the numbers at the time of publication. For the latest ordering part numbers, refer to the target product page of the Renesas Electronics website.

<R>

Table 1 - 1 List of Ordering Part Numbers (9/12)

| Pin count | Package | Fields of Application Note | Ordering Part Number | RENESAS Code | | |
|-----------|---|----------------------------|--|--------------|--|--|
| 64 pins | 64-pin plastic LFQFP (10 × 10 mm, 0.5 mm pitch) | A | R5F104LCAFB#V0, R5F104LDAFB#V0, R5F104LEAFB#V0, R5F104LFAFB#V0, R5F104LGAFB#V0, R5F104LHAFB#V0, R5F104LJAFB#V0 | PLQP0064KF-A | | |
| | | | R5F104LCAFB#X0, R5F104LDAFB#X0, R5F104LEAFB#X0, R5F104LFAFB#X0, R5F104LGAFB#X0, R5F104LHAFB#X0, R5F104LJAFB#X0 | | | |
| | | | R5F104LCAFB#30, R5F104LDAFB#30, R5F104LEAFB#30, R5F104LFAFB#30, R5F104LGAFB#30, R5F104LHAFB#30, R5F104LJAFB#30, R5F104LKAFB#30, R5F104LLAFB#30 | PLQP0064KB-C | | |
| | | D | R5F104LCDFB#V0, R5F104LDDFB#V0, R5F104LEDFB#V0, R5F104LDFB#V0, R5F104LGDFB#V0, R5F104LHDFB#V0, R5F104LJDFB#V0 | PLQP0064KF-A | | |
| | | | R5F104LCDFB#X0, R5F104LDDFB#X0, R5F104LEDFB#X0, R5F104LDFB#X0, R5F104LGDFB#X0, R5F104LHDFB#X0, R5F104LJDFB#X0 | | | |
| | | | R5F104LCDFB#30, R5F104LDDFB#30, R5F104LEDFB#30, R5F104LDFB#30, R5F104LGDFB#30, R5F104LHDFB#30, R5F104LJDFB#30 | PLQP0064KB-C | | |
| | | G | R5F104LCGFB#V0, R5F104LDGFB#V0, R5F104LEGFB#V0, R5F104LFGFB#V0, R5F104LGGFB#V0, R5F104LHGFB#V0, R5F104LJGFB#V0 | PLQP0064KF-A | | |
| | | | R5F104LCGFB#X0, R5F104LDGFB#X0, R5F104LEGFB#X0, R5F104LFGFB#X0, R5F104LGGFB#X0, R5F104LHGFB#X0, R5F104LJGFB#X0 | | | |
| | | | R5F104LCGFB#30, R5F104LDGFB#30, R5F104LEGFB#30, R5F104LFGFB#30, R5F104LGGFB#30, R5F104LHGFB#30, R5F104LJGFB#30, R5F104LKGFB#30, R5F104LLGFB#30 | PLQP0064KB-C | | |
| | | | | | R5F104LCGFB#50, R5F104LDGFB#50, R5F104LEGFB#50, R5F104LFGFB#50, R5F104LGGFB#50, R5F104LHGFB#50, R5F104LJGFB#50, R5F104LKGFB#50, R5F104LLGFB#50 | |

Note For the fields of application, refer to **Figure 1 - 1 Part Number, Memory Size, and Package of RL78/G14**.

Caution The ordering part numbers represent the numbers at the time of publication. For the latest ordering part numbers, refer to the target product page of the Renesas Electronics website.

<R>

Table 1 - 1 List of Ordering Part Numbers (10/12)

| Pin count | Package | Fields of Application Note | Ordering Part Number | RENESAS Code |
|---|---|----------------------------|--|--------------|
| 64 pins | 64-pin plastic FLGA (5 × 5 mm, 0.5 mm pitch) | A | R5F104LCALA#U0, R5F104LDALA#U0, R5F104LEALA#U0, R5F104LFALA#U0, R5F104LGALA#U0, R5F104LHALA#U0, R5F104LJALA#U0, R5F104LKALA#U0, R5F104LLALA#U0 R5F104LCALA#W0, R5F104LDALA#W0, R5F104LEALA#W0, R5F104LFALA#W0, R5F104LGALA#W0, R5F104LHALA#W0, R5F104LJALA#W0, R5F104LKALA#W0, R5F104LLALA#W0 | PWLG0064KA-A |
| | | G | R5F104LCGLA#U0, R5F104LDGLA#U0, R5F104LEGLA#U0, R5F104LFGLA#U0, R5F104LGGLA#U0, R5F104LHGLA#U0, R5F104LJGLA#U0, R5F104LKGLA#U0, R5F104LLGLA#U0 R5F104LCGLA#W0, R5F104LDGLA#W0, R5F104LEGLA#W0, R5F104LFGLA#W0, R5F104LGGLA#W0, R5F104LHGLA#W0, R5F104LJGLA#W0, R5F104LKGLA#W0, R5F104LLGLA#W0 | |
| 64-pin plastic LQFP (14 × 14 mm, 0.8 mm pitch) | | A | R5F104LCAFP#V0, R5F104LDAFP#V0, R5F104LEAFP#V0, R5F104LFAFP#V0, R5F104LGAFP#V0, R5F104LHAFP#V0, R5F104LJAFP#V0 R5F104LCAFP#X0, R5F104LDAFP#X0, R5F104LEAFP#X0, R5F104LFAFP#X0, R5F104LGAFP#X0, R5F104LHAFP#X0, R5F104LJAFP#X0 R5F104LCAFP#30, R5F104LDAFP#30, R5F104LEAFP#30, R5F104LFAFP#30, R5F104LGAFP#30, R5F104LHAFP#30, R5F104LJAFP#30 R5F104LCAFP#50, R5F104LDAFP#50, R5F104LEAFP#50, R5F104LFAFP#50, R5F104LGAFP#50, R5F104LHAFP#50, R5F104LJAFP#50 | PLQP0064GA-A |
| | | D | R5F104LCDFP#V0, R5F104LDDFP#V0, R5F104LEDFP#V0, R5F104LDFDP#V0, R5F104LGDFP#V0, R5F104LHDFP#V0, R5F104LJDFP#V0 R5F104LCDFP#X0, R5F104LDDFP#X0, R5F104LEDFP#X0, R5F104LDFDP#X0, R5F104LGDFP#X0, R5F104LHDFP#X0, R5F104LJDFP#X0 R5F104LCDFP#30, R5F104LDDFP#30, R5F104LEDFP#30, R5F104LDFDP#30, R5F104LGDFP#30, R5F104LHDFP#30, R5F104LJDFP#30 R5F104LCDFP#50, R5F104LDDFP#50, R5F104LEDFP#50, R5F104LDFDP#50, R5F104LGDFP#50, R5F104LHDFP#50, R5F104LJDFP#50 | |
| | | G | R5F104LCGFP#V0, R5F104LDGFP#V0, R5F104LEGFP#V0, R5F104LFGFP#V0, R5F104LGGFP#V0, R5F104LHGFP#V0, R5F104LJGFP#V0 R5F104LCGFP#X0, R5F104LDGFP#X0, R5F104LEGFP#X0, R5F104LFGFP#X0, R5F104LGGFP#X0, R5F104LHGFP#X0, R5F104LJGFP#X0 R5F104LCGFP#30, R5F104LDGFP#30, R5F104LEGFP#30, R5F104LFGFP#30, R5F104LGGFP#30, R5F104LHGFP#30, R5F104LJGFP#30 R5F104LCGFP#50, R5F104LDGFP#50, R5F104LEGFP#50, R5F104LFGFP#50, R5F104LGGFP#50, R5F104LHGFP#50, R5F104LJGFP#50 | |

Note For the fields of application, refer to **Figure 1 - 1 Part Number, Memory Size, and Package of RL78/G14**.

Caution The ordering part numbers represent the numbers at the time of publication. For the latest ordering part numbers, refer to the target product page of the Renesas Electronics website.

<R>

Table 1 - 1 List of Ordering Part Numbers (11/12)

| Pin count | Package | Fields of Application Note | Ordering Part Number | RENESAS Code |
|---|---|----------------------------|--|--------------|
| 80 pins | 80-pin plastic LFQFP (12 × 12 mm, 0.5 mm pitch) | A | R5F104MFAFB#V0, R5F104MGAFB#V0, R5F104MHAFB#V0, R5F104MJAFB#V0 | PLQP0080KE-A |
| | | | R5F104MFAFB#X0, R5F104MGAFB#X0, R5F104MHAFB#X0, R5F104MJAFB#X0 | |
| | | | R5F104MFAFB#30, R5F104MGAFB#30, R5F104MHAFB#30, R5F104MJAFB#30, R5F104MKAFB#30, R5F104MLAFB#30 | PLQP0080KB-B |
| | | | R5F104MFAFB#50, R5F104MGAFB#50, R5F104MHAFB#50, R5F104MJAFB#50, R5F104MKAFB#50, R5F104MLAFB#50 | |
| | | D | R5F104MFDFB#V0, R5F104MGDFB#V0, R5F104MHDFB#V0, R5F104MJDFB#V0 | PLQP0080KE-A |
| | | | R5F104MFDFB#X0, R5F104MGDFB#X0, R5F104MHDFB#X0, R5F104MJDFB#X0 | |
| | | | R5F104MFDFB#30, R5F104MGDFB#30, R5F104MHDFB#30, R5F104MJDFB#30 | PLQP0080KB-B |
| | | | R5F104MFDFB#50, R5F104MGDFB#50, R5F104MHDFB#50, R5F104MJDFB#50 | |
| | | G | R5F104MFGFB#V0, R5F104MGGFB#V0, R5F104MHGFB#V0, R5F104MJGFB#V0 | PLQP0080KE-A |
| | | | R5F104MFGFB#X0, R5F104MGGFB#X0, R5F104MHGFB#X0, R5F104MJGFB#X0 | |
| | | | R5F104MFGFB#30, R5F104MGGFB#30, R5F104MHGFB#30, R5F104MJGFB#30, R5F104MKGFB#30, R5F104MLGFB#30 | PLQP0080KB-B |
| | | | R5F104MFGFB#50, R5F104MGGFB#50, R5F104MHGFB#50, R5F104MJGFB#50, R5F104MKGFB#50, R5F104MLGFB#50 | |
| 80-pin plastic LQFP (14 × 14 mm, 0.65 mm pitch) | 80-pin plastic LQFP (14 × 14 mm, 0.65 mm pitch) | A | R5F104MFafa#V0, R5F104MGafa#V0, R5F104MHafa#V0, R5F104MJafa#V0 | PLQP0080JB-E |
| | | | R5F104MFafa#X0, R5F104MGafa#X0, R5F104MHafa#X0, R5F104MJafa#X0 | |
| | | | R5F104MFafa#30, R5F104MGafa#30, R5F104MHafa#30, R5F104MJafa#30, R5F104MKafa#30, R5F104MLafa#30 | PLQP0080JB-E |
| | | | R5F104MFafa#50, R5F104MGafa#50, R5F104MHafa#50, R5F104MJafa#50, R5F104MKafa#50, R5F104MLafa#50 | |
| | | D | R5F104MFDfa#V0, R5F104MGdfa#V0, R5F104MHDfa#V0, R5F104MJdfa#V0 | PLQP0080JB-E |
| | | | R5F104MFDfa#X0, R5F104MGdfa#X0, R5F104MHDfa#X0, R5F104MJdfa#X0 | |
| | | | R5F104MFDfa#30, R5F104MGdfa#30, R5F104MHDfa#30, R5F104MJdfa#30 | PLQP0080KB-B |
| | | | R5F104MFDfa#50, R5F104MGdfa#50, R5F104MHDfa#50, R5F104MJdfa#50 | |
| | | G | R5F104MFGfa#V0, R5F104MGGfa#V0, R5F104MHGfa#V0, R5F104MJGfa#V0 | PLQP0080KE-A |
| | | | R5F104MFGfa#X0, R5F104MGGfa#X0, R5F104MHGfa#X0, R5F104MJGfa#X0 | |
| | | | R5F104MFGfa#30, R5F104MGGfa#30, R5F104MHGfa#30, R5F104MJGfa#30, R5F104MKGfa#30, R5F104MLGfa#30 | PLQP0080KB-B |
| | | | R5F104MFGfa#50, R5F104MGGfa#50, R5F104MHGfa#50, R5F104MJGfa#50, R5F104MKGfa#50, R5F104MLGfa#50 | |

Note For the fields of application, refer to **Figure 1 - 1 Part Number, Memory Size, and Package of RL78/G14**.

Caution The ordering part numbers represent the numbers at the time of publication. For the latest ordering part numbers, refer to the target product page of the Renesas Electronics website.

<R>

Table 1 - 1 List of Ordering Part Numbers (12/12)

| Pin count | Package | Fields of Application Note | Ordering Part Number | RENESAS Code | |
|--|--|--|--|--|--------------|
| 100 pins | 100-pin plastic LFQFP (14 × 14 mm, 0.5 mm pitch) | A | R5F104PFAFB#V0, R5F104PGAFA#V0, R5F104PHAFB#V0, R5F104PJAFB#V0 | PLQP0100KE-A | |
| | | | R5F104PFAFB#X0, R5F104PGAFA#X0, R5F104PHAFB#X0, R5F104PJAFB#X0 | | |
| | | | R5F104PFAFB#30, R5F104PGAFA#30, R5F104PHAFB#30, R5F104PJAFB#30, R5F104PKAFB#30, R5F104PLAFB#30 | PLQP0100KB-B | |
| | | | R5F104PFAFB#50, R5F104PGAFA#50, R5F104PHAFB#50, R5F104PJAFB#50, R5F104PKAFB#50, R5F104PLAFB#50 | | |
| | | | D | R5F104PFDFB#V0, R5F104PGDFB#V0, R5F104PHDFB#V0, R5F104PJDFB#V0 | PLQP0100KE-A |
| | | | | R5F104PFDFB#X0, R5F104PGDFB#X0, R5F104PHDFB#X0, R5F104PJDFB#X0 | |
| | | R5F104PFDFB#30, R5F104PGDFB#30, R5F104PHDFB#30, R5F104PJDFB#30 | | PLQP0100KB-B | |
| | | R5F104PFDFB#50, R5F104PGDFB#50, R5F104PHDFB#50, R5F104PJDFB#50 | | | |
| | | G | | R5F104PFGFB#V0, R5F104PGGFB#V0, R5F104PHGFB#V0, R5F104PJGFB#V0 | PLQP0100KE-A |
| | | | | R5F104PFGFB#X0, R5F104PGGFB#X0, R5F104PHGFB#X0, R5F104PJGFB#X0 | |
| | | | R5F104PFGFB#30, R5F104PGGFB#30, R5F104PHGFB#30, R5F104PJGFB#30, R5F104PKGFB#30, R5F104PLGFB#30 | PLQP0100KB-B | |
| | | | R5F104PFGFB#50, R5F104PGGFB#50, R5F104PHGFB#50, R5F104PJGFB#50, R5F104PKGFB#50, R5F104PLGFB#50 | | |
| 100-pin plastic LQFP (14 × 20 mm, 0.65 mm pitch) | A | | R5F104PFafa#V0, R5F104PGAfa#V0, R5F104PHafa#V0, R5F104PJafa#V0 | PLQP0100JC-A | |
| | | | R5F104PFafa#X0, R5F104PGAfa#X0, R5F104PHafa#X0, R5F104PJafa#X0 | | |
| | | R5F104PFafa#30, R5F104PGAfa#30, R5F104PHafa#30, R5F104PJafa#30, R5F104PKafa#30, R5F104PLafa#30 | | | |
| | | R5F104PFafa#50, R5F104PGAfa#50, R5F104PHafa#50, R5F104PJafa#50, R5F104PKafa#50, R5F104PLafa#50 | | | |
| | | D | R5F104PFdFa#V0, R5F104PGdFa#V0, R5F104PHdFa#V0, R5F104PJdFa#V0 | | |
| | | | R5F104PFdFa#X0, R5F104PGdFa#X0, R5F104PHdFa#X0, R5F104PJdFa#X0 | | |
| | R5F104PFdFa#30, R5F104PGdFa#30, R5F104PHdFa#30, R5F104PJdFa#30 | | | | |
| | G | R5F104PFGfa#V0, R5F104PGGfa#V0, R5F104PHGfa#V0, R5F104PJGfa#V0 | | | |
| | | R5F104PFGfa#X0, R5F104PGGfa#X0, R5F104PHGfa#X0, R5F104PJGfa#X0 | | | |
| R5F104PFGfa#30, R5F104PGGfa#30, R5F104PHGfa#30, R5F104PJGfa#30, R5F104PKGfa#30, R5F104PLGfa#30 | | | | | |

Note For the fields of application, refer to **Figure 1 - 1 Part Number, Memory Size, and Package of RL78/G14**.

Caution The ordering part numbers represent the numbers at the time of publication. For the latest ordering part numbers, refer to the target product page of the Renesas Electronics website.

1.3 Pin Configuration (Top View)

1.3.1 30-pin products

- 30-pin plastic LSSOP (7.62 mm (300), 0.65 mm pitch)

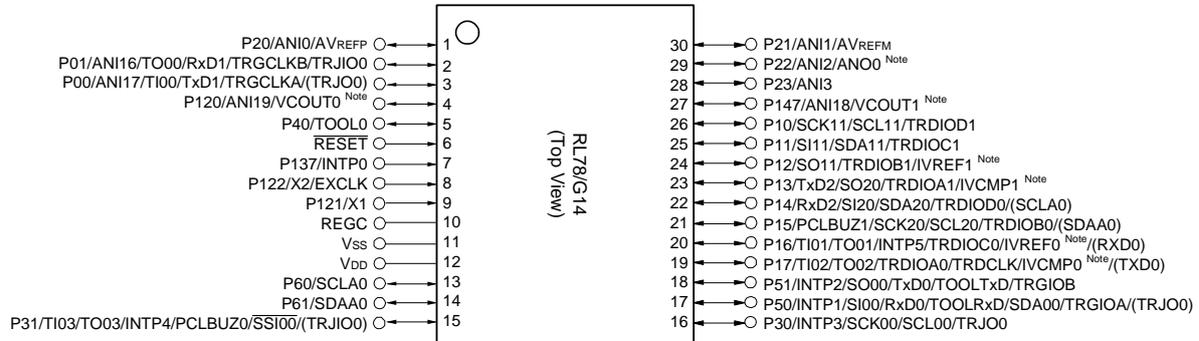

Note Mounted on the 96 KB or more code flash memory products.

Caution Connect the REGC pin to V_{SS} pin via a capacitor (0.47 to 1 μ F).

Remark 1. For pin identification, see 1.4 Pin Identification.

Remark 2. Functions in parentheses in the above figure can be assigned via settings in the peripheral I/O redirection register 0, 1 (PIOR0, 1).

1.3.2 32-pin products

- 32-pin plastic HWQFN (5 × 5 mm, 0.5 mm pitch)

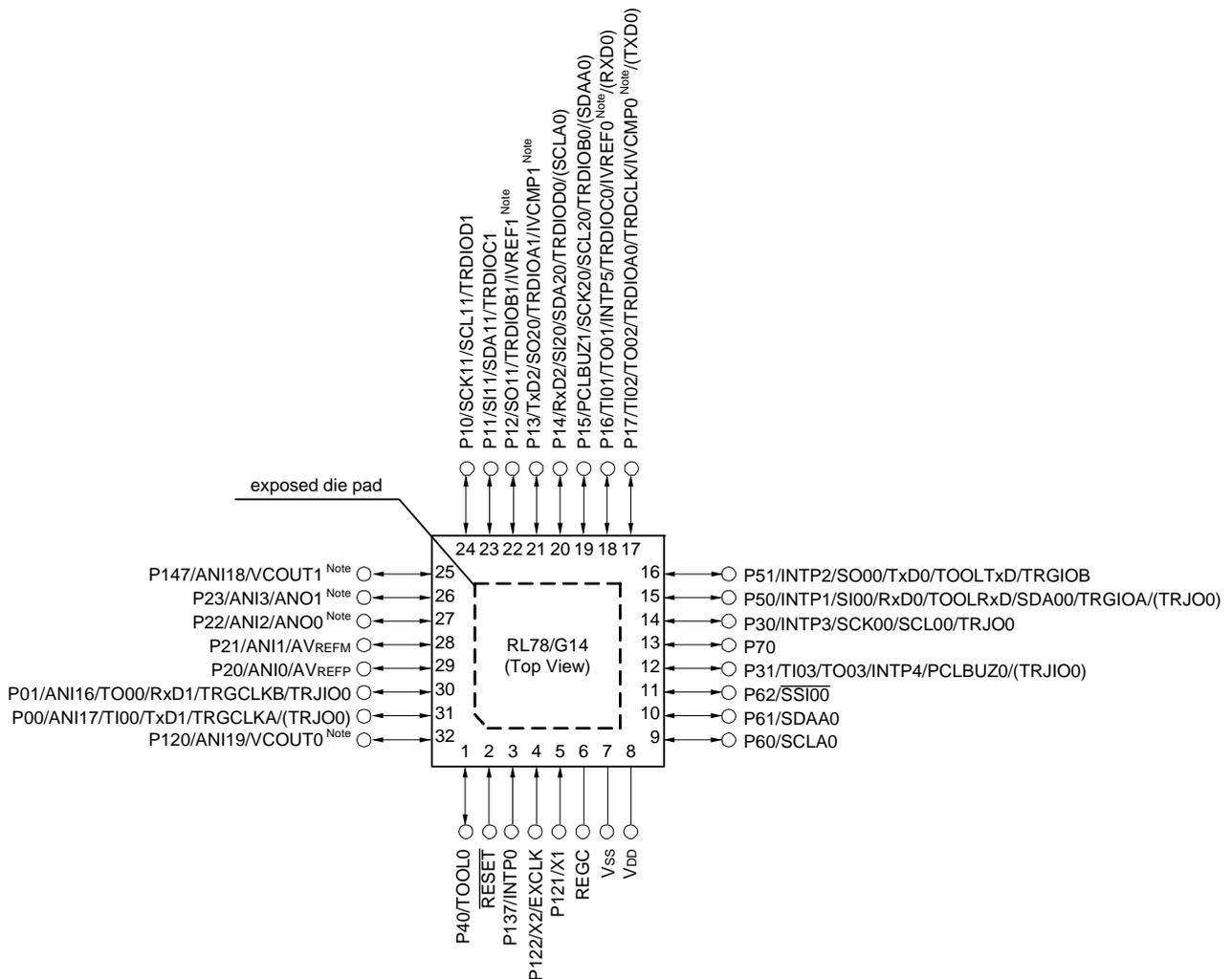

Note Mounted on the 96 KB or more code flash memory products.

Caution Connect the REGC pin to V_{SS} pin via a capacitor (0.47 to 1 μF).

Remark 1. For pin identification, see 1.4 Pin Identification.

Remark 2. Functions in parentheses in the above figure can be assigned via settings in the peripheral I/O redirection register 0, 1 (PIOR0, 1).

Remark 3. It is recommended to connect an exposed die pad to V_{SS}.

- 32-pin plastic LQFP (7 × 7 mm, 0.8 mm pitch)

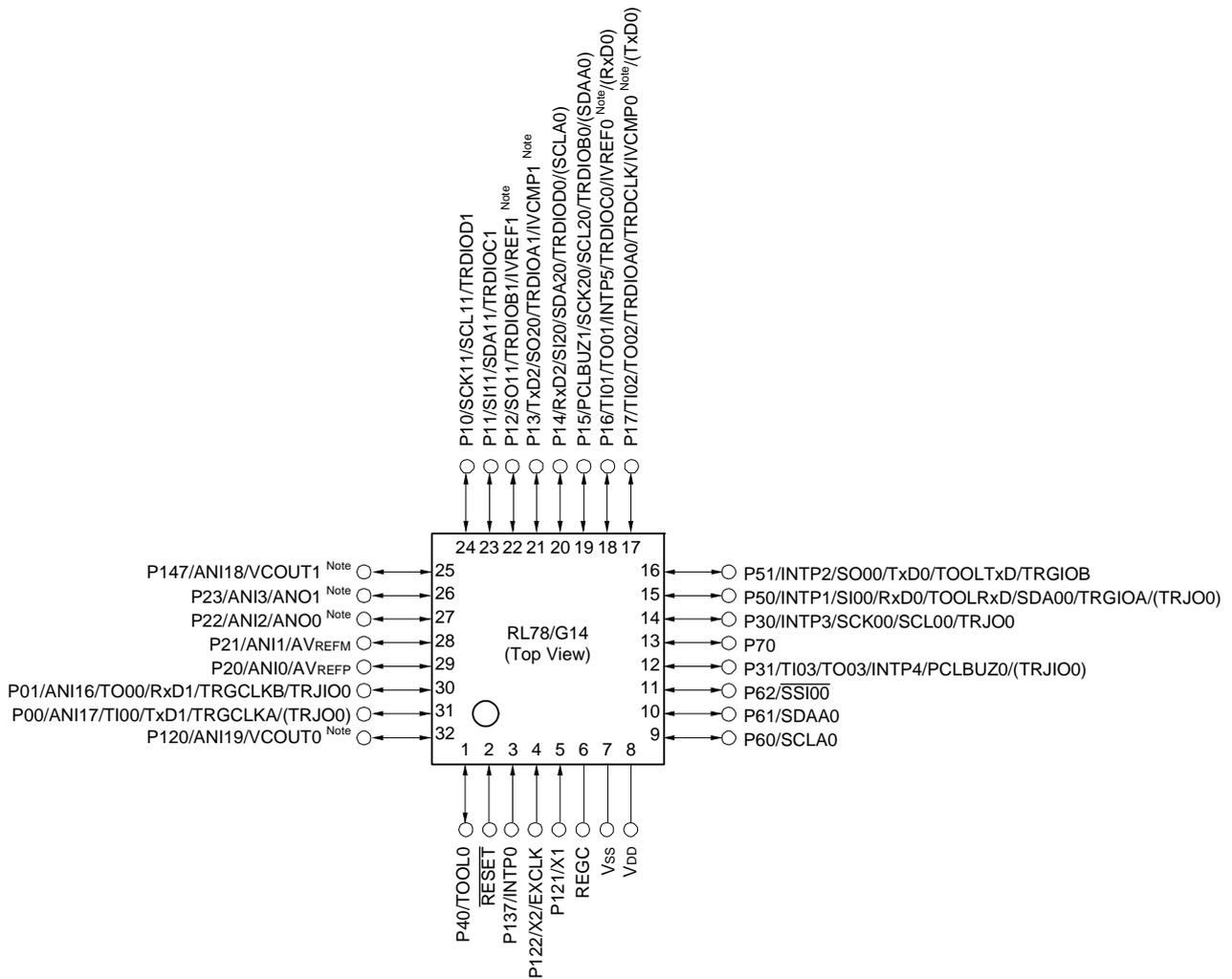

Note Mounted on the 96 KB or more code flash memory products.

Caution Connect the REGC pin to V_{SS} pin via a capacitor (0.47 to 1 μF).

Remark 1. For pin identification, see 1.4 Pin Identification.

Remark 2. Functions in parentheses in the above figure can be assigned via settings in the peripheral I/O redirection register 0, 1 (PIOR0, 1).

1.3.3 36-pin products

- 36-pin plastic WFLGA (4 × 4 mm, 0.5 mm pitch)

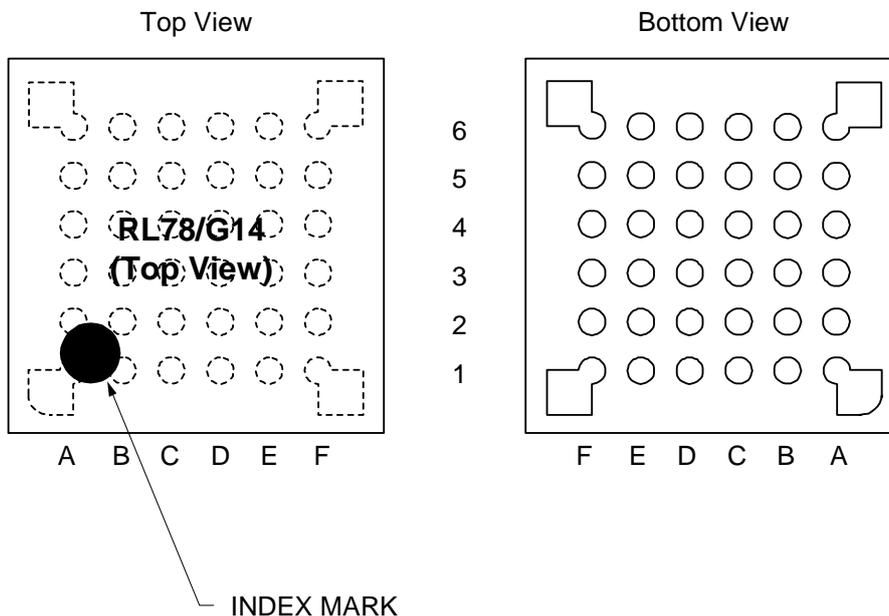

| | A | B | C | D | E | F | |
|---|--|---|---|--|---------------------------------------|--------------------------------------|---|
| 6 | P60/SCLA0 | V _{DD} | P121/X1 | P122/X2/EXCLK | P137/INTP0 | P40/TOOL0 | 6 |
| 5 | P62/ $\overline{\text{SSI00}}$ | P61/SDAA0 | V _{SS} | REGC | $\overline{\text{RESET}}$ | P120/ANI19/ VCOUT0 Note | 5 |
| 4 | P72/SO21 | P71/SI21/ SDA21 | P14/RxD2/SI20/ SDA20/TRDIOD0/ (SCLA0) | P31/TI03/TO03/ INTP4/PCLBUZ0/ (TRJIO0) | P00/TI00/TxD1/ TRGCLKA/ (TRJO0) | P01/TO00/ RxD1/TRGCLKB/ TRJIO0 | 4 |
| 3 | P50/INTP1/ SI00/RxD0/ TOOLRxD/ SDA00/TRGIOA/ (TRJO0) | P70/SCK21/ SCL21 | P15/PCLBUZ1/ SCK20/SCL20/ TRDIOB0/ (SDAA0) | P22/ANI2/ ANO0 Note | P20/ANI0/ AVREFP | P21/ANI1/ AVREFM | 3 |
| 2 | P30/INTP3/ SCK00/SCL00/ TRJO0 | P16/TI01/TO01/ INTP5/TRDIOC0/ IVREF0 Note/ (RXD0) | P12/SO11/ TRDIOB1/ IVREF1 Note | P11/SI11/ SDA11/ TRDIOC1 | P24/ANI4 | P23/ANI3/ ANO1 Note | 2 |
| 1 | P51/INTP2/ SO00/TxD0/ TOOLTxD/ TRGIOB | P17/TI02/TO02/ TRDIOA0/ TRDCLK/ IVCMP0 Note/ (TXD0) | P13/TxD2/ SO20/TRDIOA1/ IVCMP1 Note | P10/SCK11/ SCL11/ TRDIOD1 | P147/ANI18/ VCOUT1 Note | P25/ANI5 | 1 |
| | A | B | C | D | E | F | |

Note Mounted on the 96 KB or more code flash memory products.

Caution Connect the REGC pin to V_{SS} pin via a capacitor (0.47 to 1 μF).

Remark 1. For pin identification, see 1.4 Pin Identification.

Remark 2. Functions in parentheses in the above figure can be assigned via settings in the peripheral I/O redirection register 0, 1 (PIOR0, 1).

1.3.4 40-pin products

- 40-pin plastic HWQFN (6 × 6 mm, 0.5 mm pitch)

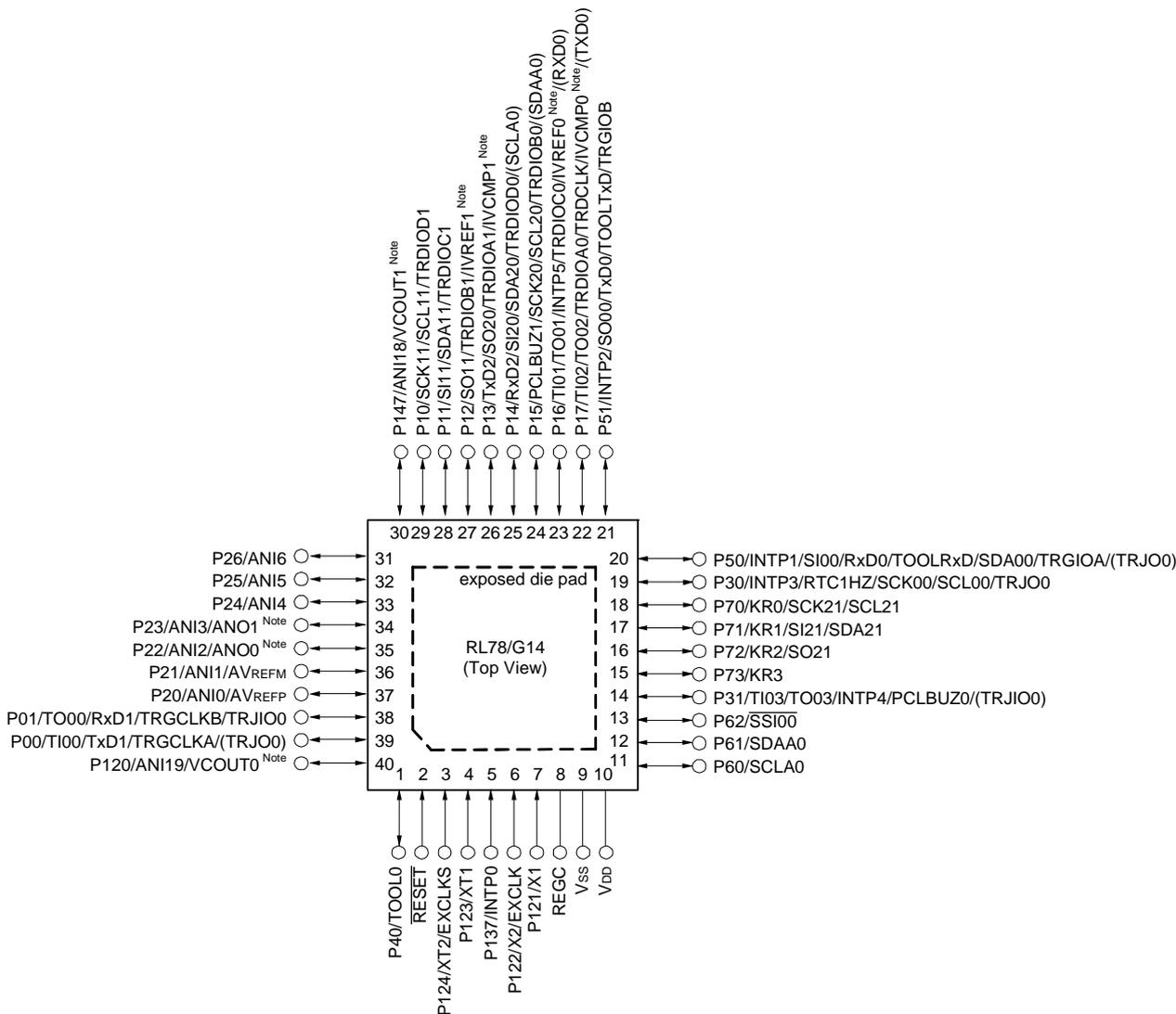

Note Mounted on the 96 KB or more code flash memory products.

Caution Connect the REGC pin to Vss pin via a capacitor (0.47 to 1 μF).

Remark 1. For pin identification, see 1.4 Pin Identification.

Remark 2. Functions in parentheses in the above figure can be assigned via settings in the peripheral I/O redirection register 0, 1 (PIOR0, 1).

Remark 3. It is recommended to connect an exposed die pad to Vss.

1.3.5 44-pin products

- 44-pin plastic LQFP (10 × 10 mm, 0.8 mm pitch)

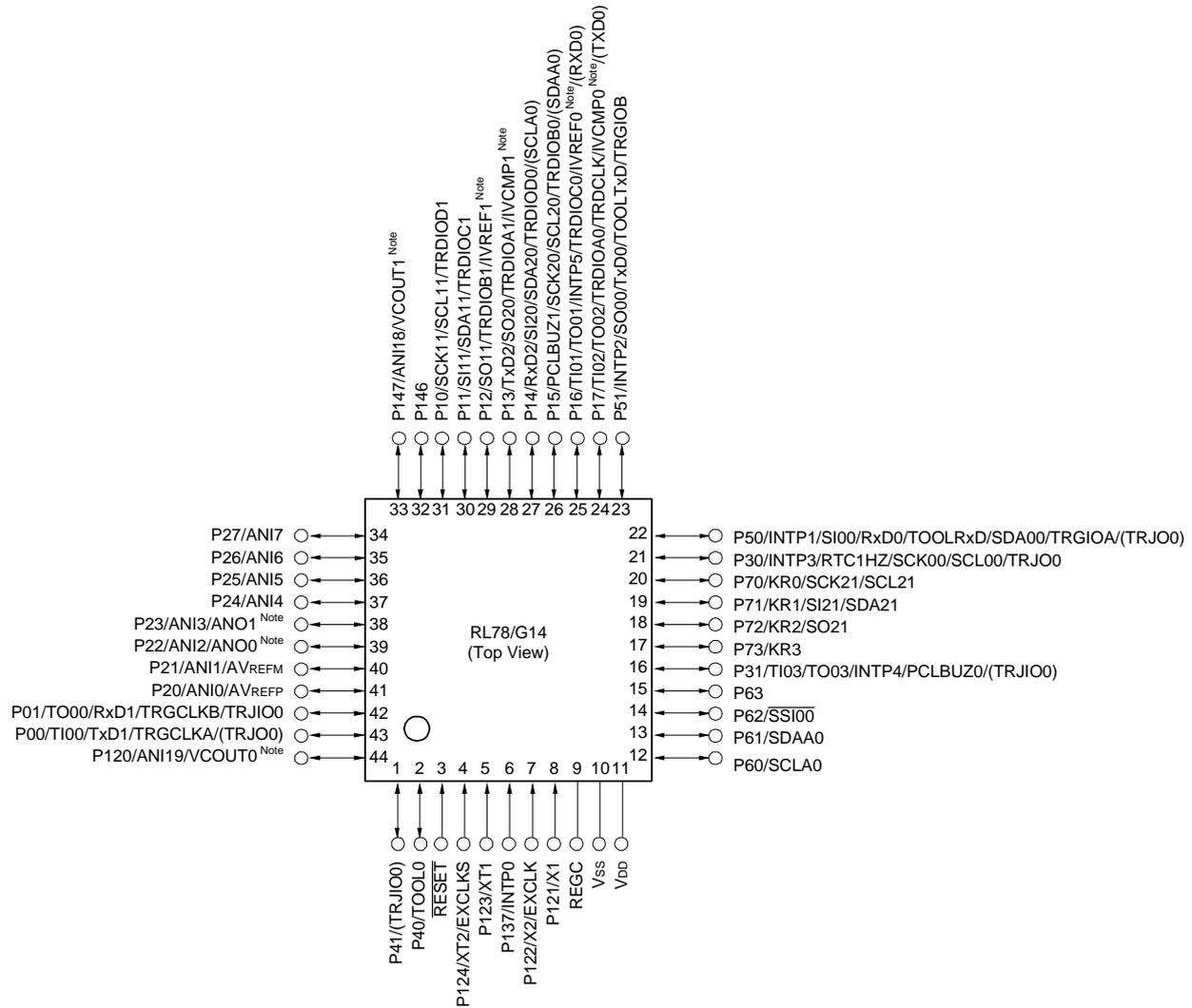

Note Mounted on the 96 KB or more code flash memory products.

Caution Connect the REGC pin to V_{ss} pin via a capacitor (0.47 to 1 μF).

Remark 1. For pin identification, see 1.4 Pin Identification.

Remark 2. Functions in parentheses in the above figure can be assigned via settings in the peripheral I/O redirection register 0, 1 (PIOR0, 1).

1.3.6 48-pin products

- 48-pin plastic LQFP (7 × 7 mm, 0.5 mm pitch)

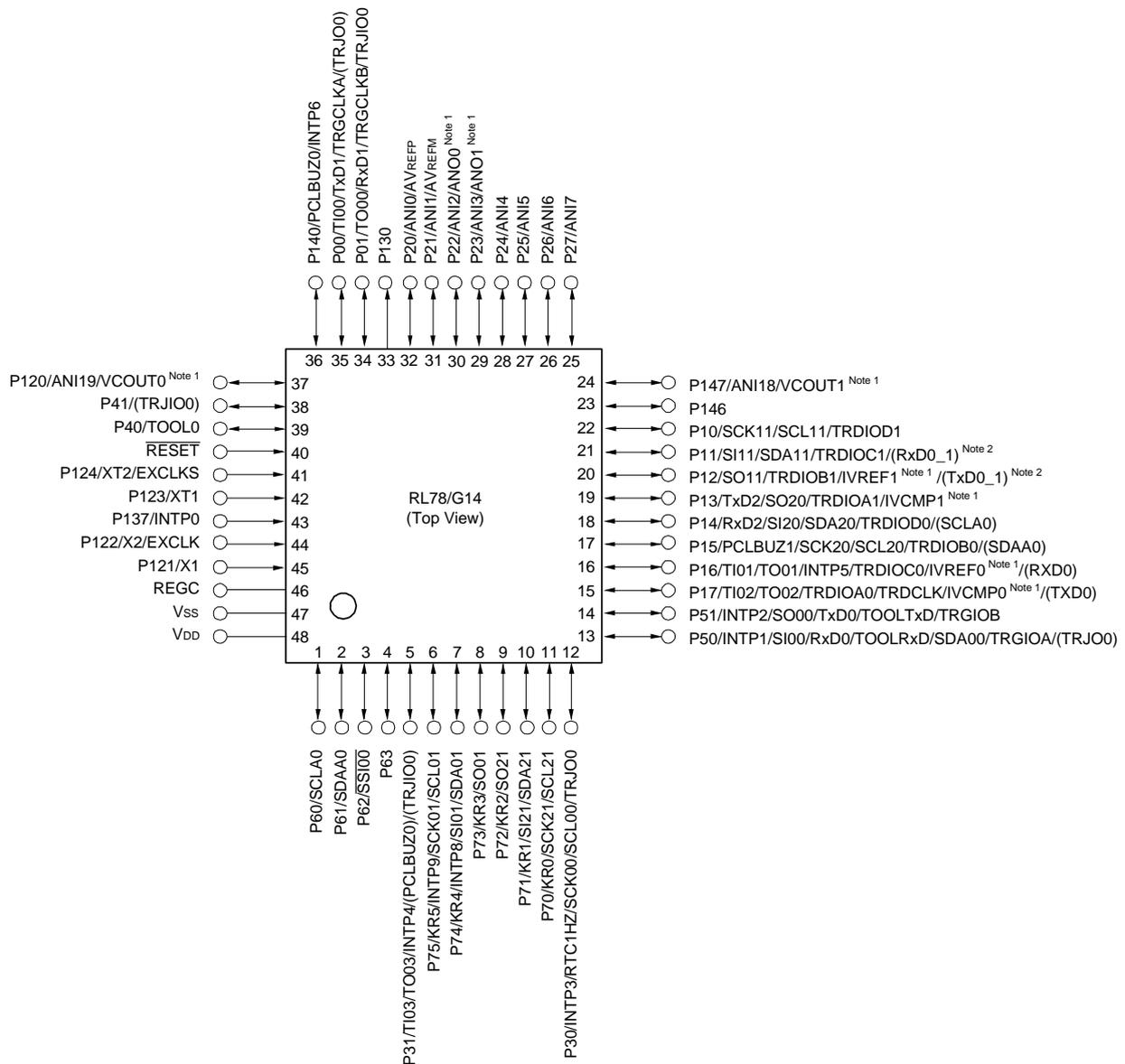

Note 1. Mounted on the 96 KB or more code flash memory products.

Note 2. Mounted on the 384 KB or more code flash memory products.

Caution Connect the REGC pin to Vss pin via a capacitor (0.47 to 1 μF).

Remark 1. For pin identification, see 1.4 Pin Identification.

Remark 2. Functions in parentheses in the above figure can be assigned via settings in the peripheral I/O redirection register 0, 1 (PIOR0, 1).

- 48-pin plastic HWQFN (7 × 7 mm, 0.5 mm pitch)

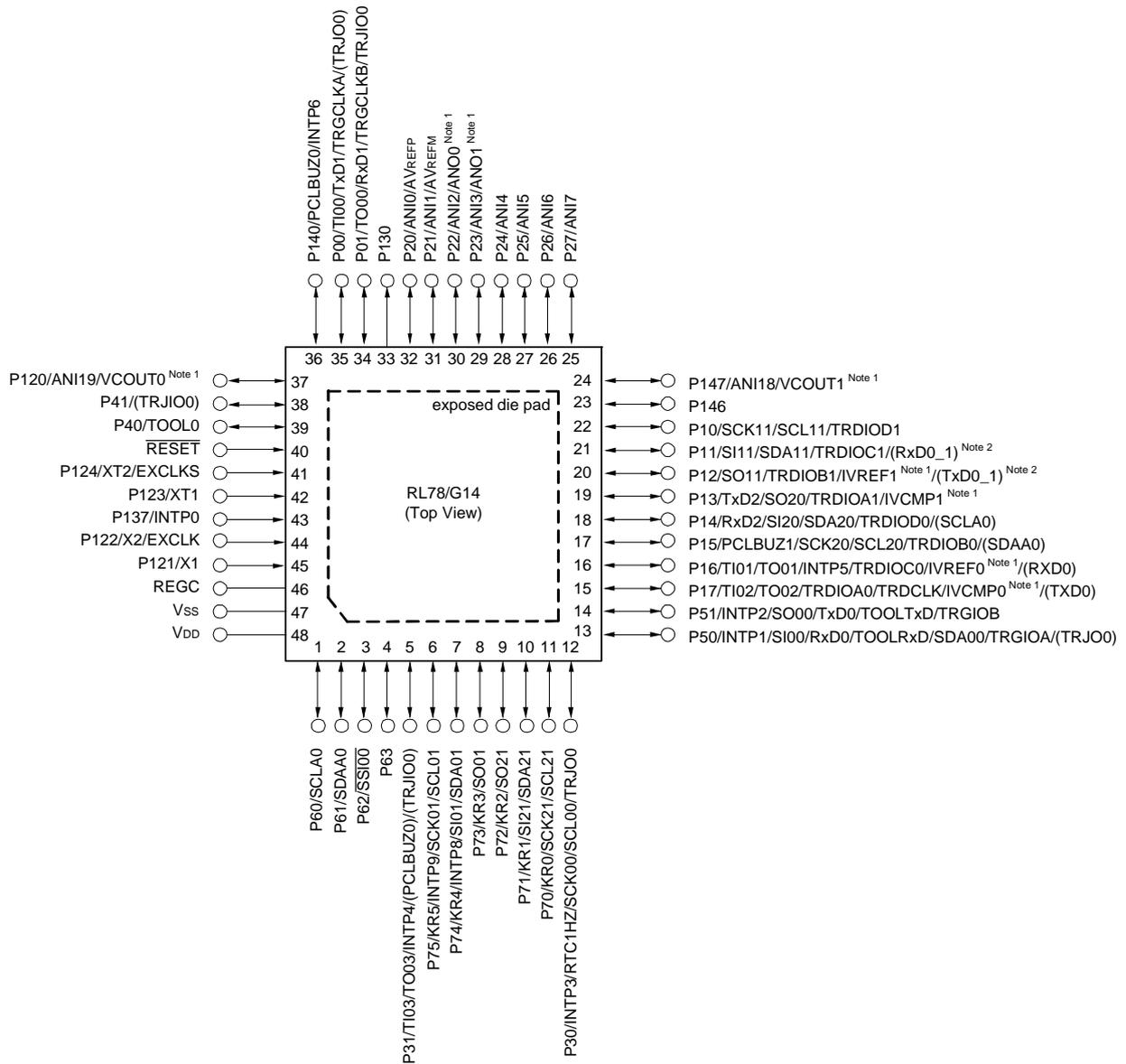

Note 1. Mounted on the 96 KB or more code flash memory products.

Note 2. Mounted on the 384 KB or more code flash memory products.

Caution Connect the REGC pin to V_{SS} pin via a capacitor (0.47 to 1 μF).

Remark 1. For pin identification, see 1.4 Pin Identification.

Remark 2. Functions in parentheses in the above figure can be assigned via settings in the peripheral I/O redirection register 0, 1 (PIOR0, 1).

Remark 3. It is recommended to connect an exposed die pad to V_{SS}.

1.3.7 52-pin products

- 52-pin plastic LQFP (10 × 10 mm, 0.65 mm pitch)

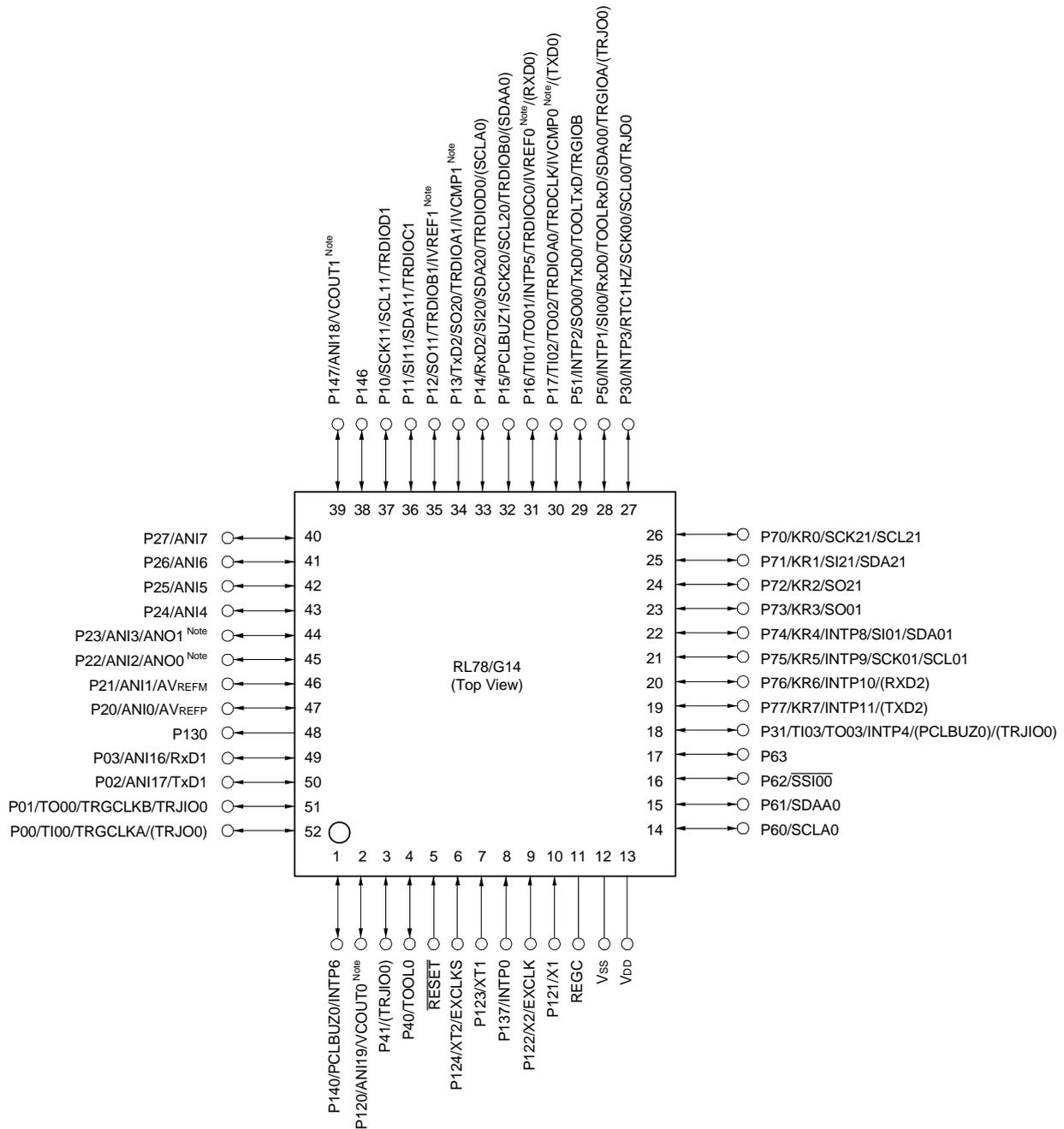

Note Mounted on the 96 KB or more code flash memory products.

Caution Connect the REGC pin to Vss pin via a capacitor (0.47 to 1 μF).

Remark 1. For pin identification, see 1.4 Pin Identification.

Remark 2. Functions in parentheses in the above figure can be assigned via settings in the peripheral I/O redirection register 0, 1 (PIOR0, 1).

1.3.8 64-pin products

- 64-pin plastic LQFP (14 × 14 mm, 0.8 mm pitch)
- 64-pin plastic LQFP (12 × 12 mm, 0.65 mm pitch)
- 64-pin plastic LFQFP (10 × 10 mm, 0.5 mm pitch)

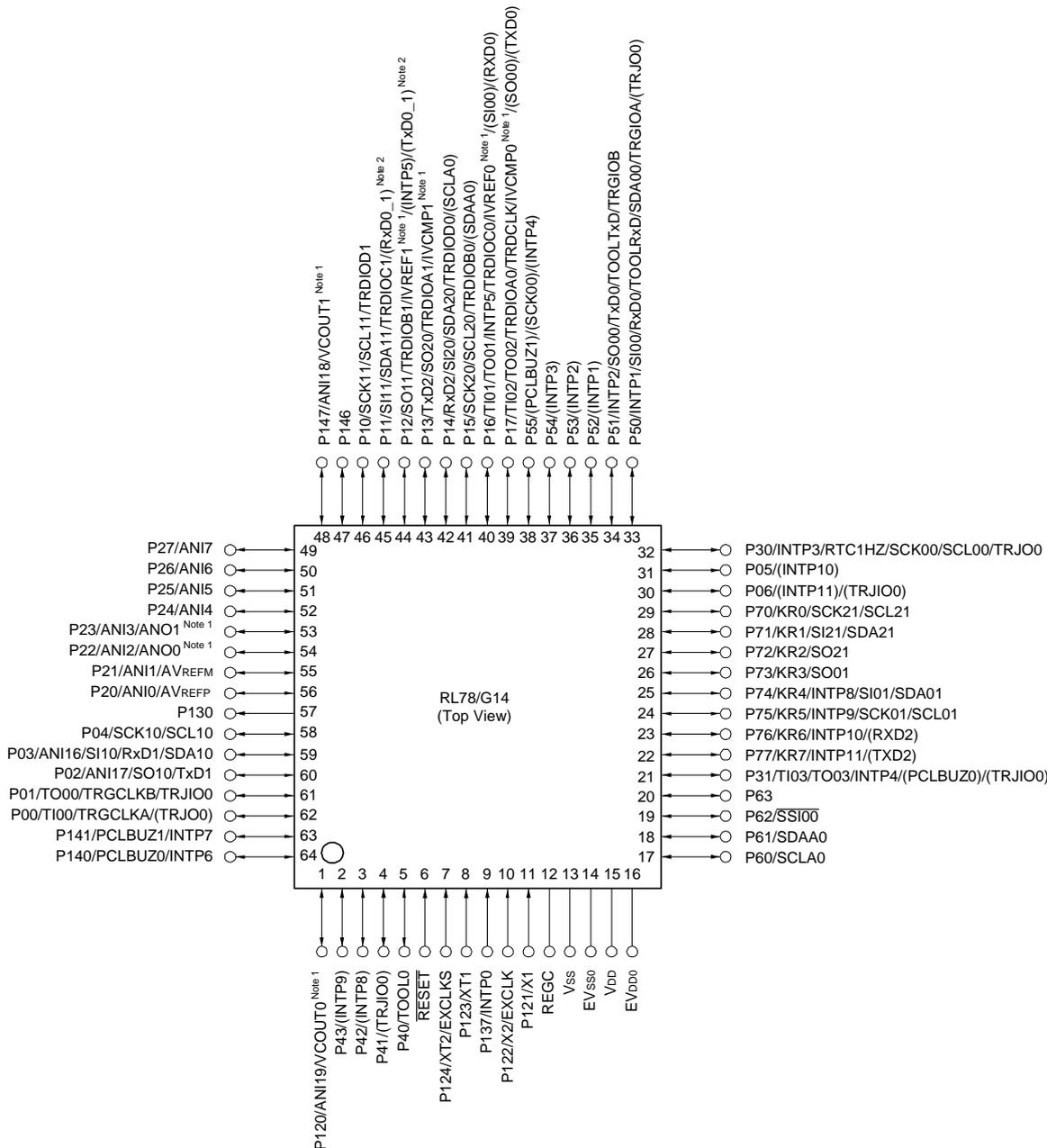

Note 1. Mounted on the 96 KB or more code flash memory products.

Note 2. Mounted on the 384 KB or more code flash memory products.

Caution 1. Make EVSS0 pin the same potential as Vss pin.

Caution 2. Make VDD pin the potential that is higher than EVDD0 pin.

Caution 3. Connect the REGC pin to Vss pin via a capacitor (0.47 to 1 μF).

Remark 1. For pin identification, see 1.4 Pin Identification.

Remark 2. When using the microcontroller for an application where the noise generated inside the microcontroller must be reduced, it is recommended to supply separate powers to the VDD and EVDD0 pins and connect the Vss and EVSS0 pins to separate ground lines.

Remark 3. Functions in parentheses in the above figure can be assigned via settings in the peripheral I/O redirection register 0, 1 (PIOR0, 1).

- 64-pin plastic FLGA (5 × 5 mm, 0.5 mm pitch)

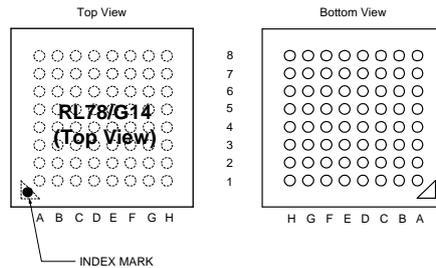

| | A | B | C | D | E | F | G | H | |
|---|---|---|--|--|---|--|-----------------------------------|------------------------------|---|
| 8 | EVDD0 | EVSS0 | P121/X1 | P122/X2/ EXCLK | P137/INTP0 | P123/XT1 | P124/XT2/ EXCLKS | P120/ANI19/ VCOUT0 Note 1 | 8 |
| 7 | P60/SCLA0 | VDD | VSS | REGC | RESET | P01/TO00/ TRGCLKB/ TRJIO0 | P00/TI00/ TRGCLKA/ (TRJIO0) | P140/ PCLBUZ0/ INTP6 | 7 |
| 6 | P61/SDAA0 | P62/SSIO0 | P63 | P40/TOOL0 | P41/(TRJIO0) | P43/(INTP9) | P02/ANI17/ SO10/TxD1 | P141/ PCLBUZ1/ INTP7 | 6 |
| 5 | P77/KR7/ INTP11/(TXD2) | P31/TI03/ TO03/INTP4/ (PCLBUZ0)/ (TRJIO0) | P53/(INTP2) | P42/(INTP8) | P03/ANI16/ SI10/RxD1/ SDA10 | P04/SCK10/ SCL10 | P130 | P20/ANI0/ AVREFP | 5 |
| 4 | P75/KR5/ INTP9/ SCK01/ SCL01 | P76/KR6/ INTP10/ (RxD2) | P52/(INTP1) | P54/(INTP3) | P16/TI01/ TO01/INTP5/ TRDI0C0/ IVREF0 Note 1/ (SI00)/(RxD0) | P21/ANI1/ AVREFM | P22/ANI2/ ANO0 Note 1 | P23/ANI3/ ANO1 Note 1 | 4 |
| 3 | P70/KR0/ SCK21/ SCL21 | P73/KR3/ SO01 | P74/KR4/ INTP8/SI01/ SDA01 | P17/TI02/TO02/ TRDIOA0/ TRDCLK/ IVCMP0 Note 1/ (SO00)/(TXD0) | P15/SCK20/ SCL20/ TRDIOB0/ (SDAA0) | P12/SO11/ TRDIOB1/ IVREF1 Note 1/ (INTP5)/ (TxD0_1) Note 2 | P24/ANI4 | P26/ANI6 | 3 |
| 2 | P30/INTP3/ RTC1HZ/ SCK00/ SCL00/TRJIO0 | P72/KR2/ SO21 | P71/KR1/ SI21/SDA21 | P06/(INTP11)/ (TRJIO0) | P14/RxD2/ SI20/SDA20/ TRDIOD0/ (SCLA0) | P11/SI11/ SDA11/ TRDI0C1/ (RxD0_1) Note 2 | P25/ANI5 | P27/ANI7 | 2 |
| 1 | P05/(INTP10) | P50/INTP1/ SI00/RxD0/ TOOLRxD/ SDA00/ TRGIOA/ (TRJIO0) | P51/INTP2/ SO00/TxD0/ TOOLTxD/ TRGIOB | P55/ (PCLBUZ1)/ (SCK00)/ (INTP4) | P13/TxD2/ SO20/ TRDIOA1/ IVCMP1 Note 1 | P10/SCK11/ SCL11/ TRDIOD1 | P146 | P147/ANI18/ VCOUT1 Note 1 | 1 |
| | A | B | C | D | E | F | G | H | |

- Note 1.** Mounted on the 96 KB or more code flash memory products.
Note 2. Mounted on the 384 KB or more code flash memory products.

- Caution 1.** Make EVSS0 pin the same potential as VSS pin.
Caution 2. Make VDD pin the potential that is higher than EVDD0 pin.
Caution 3. Connect the REGC pin to VSS pin via a capacitor (0.47 to 1 μF).

- Remark 1.** For pin identification, see 1.4 Pin Identification.
Remark 2. When using the microcontroller for an application where the noise generated inside the microcontroller must be reduced, it is recommended to supply separate powers to the VDD and EVDD0 pins and connect the VSS and EVSS0 pins to separate ground lines.
Remark 3. Functions in parentheses in the above figure can be assigned via settings in the peripheral I/O redirection register 0, 1 (PIOR0, 1).

1.3.9 80-pin products

- 80-pin plastic LQFP (14 × 14 mm, 0.65 mm pitch)
- 80-pin plastic LFQFP (12 × 12 mm, 0.5 mm pitch)

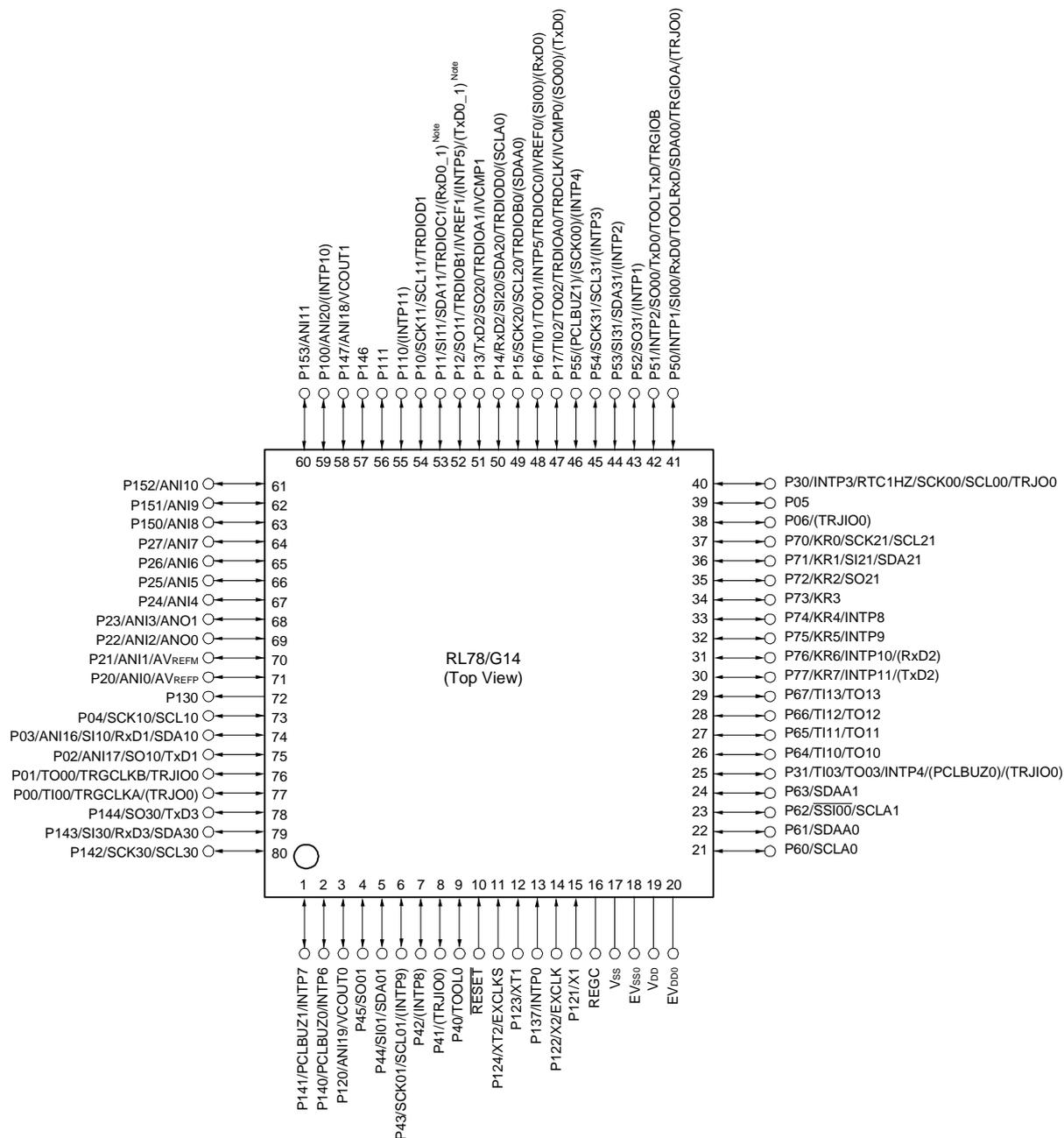

Note Mounted on the 384 KB or more code flash memory products.

Caution 1. Make EV_{SS0} pin the same potential as V_{SS} pin.

Caution 2. Make V_{DD} pin the potential that is higher than EV_{DD0} pin.

Caution 3. Connect the REGC pin to V_{SS} pin via a capacitor (0.47 to 1 μF).

Remark 1. For pin identification, see 1.4 Pin Identification.

Remark 2. When using the microcontroller for an application where the noise generated inside the microcontroller must be reduced, it is recommended to supply separate powers to the V_{DD} and EV_{DD0} pins and connect the V_{SS} and EV_{SS0} pins to separate ground lines.

Remark 3. Functions in parentheses in the above figure can be assigned via settings in the peripheral I/O redirection register 0, 1 (PIOR0, 1).

1.3.10 100-pin products

- 100-pin plastic LFQFP (14 × 14 mm, 0.5 mm pitch)

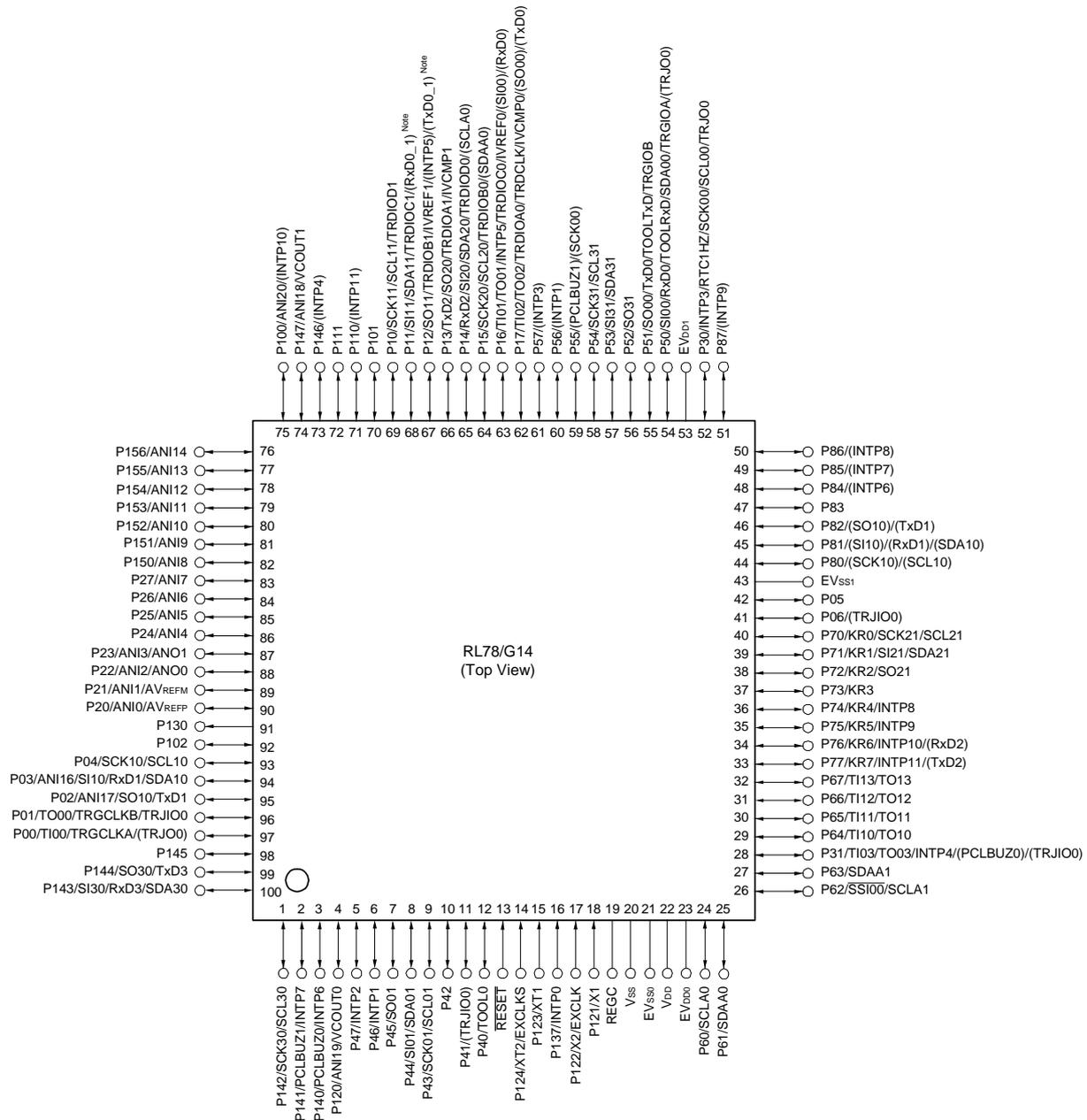

Note Mounted on the 384 KB or more code flash memory products.

Caution 1. Make EVSS0, EVSS1 pins the same potential as VSS pin.

Caution 2. Make VDD pin the potential that is higher than EVDD0, EVDD1 pins (EVDD0 = EVDD1).

Caution 3. Connect the REGC pin to VSS pin via a capacitor (0.47 to 1 μF).

Remark 1. For pin identification, see 1.4 Pin Identification.

Remark 2. When using the microcontroller for an application where the noise generated inside the microcontroller must be reduced, it is recommended to supply separate powers to the VDD, EVDD0 and EVDD1 pins and connect the VSS, EVSS0 and EVSS1 pins to separate ground lines.

Remark 3. Functions in parentheses in the above figure can be assigned via settings in the peripheral I/O redirection register 0, 1 (PIOR0, 1).

- 100-pin plastic LQFP (14 × 20 mm, 0.65 mm pitch)

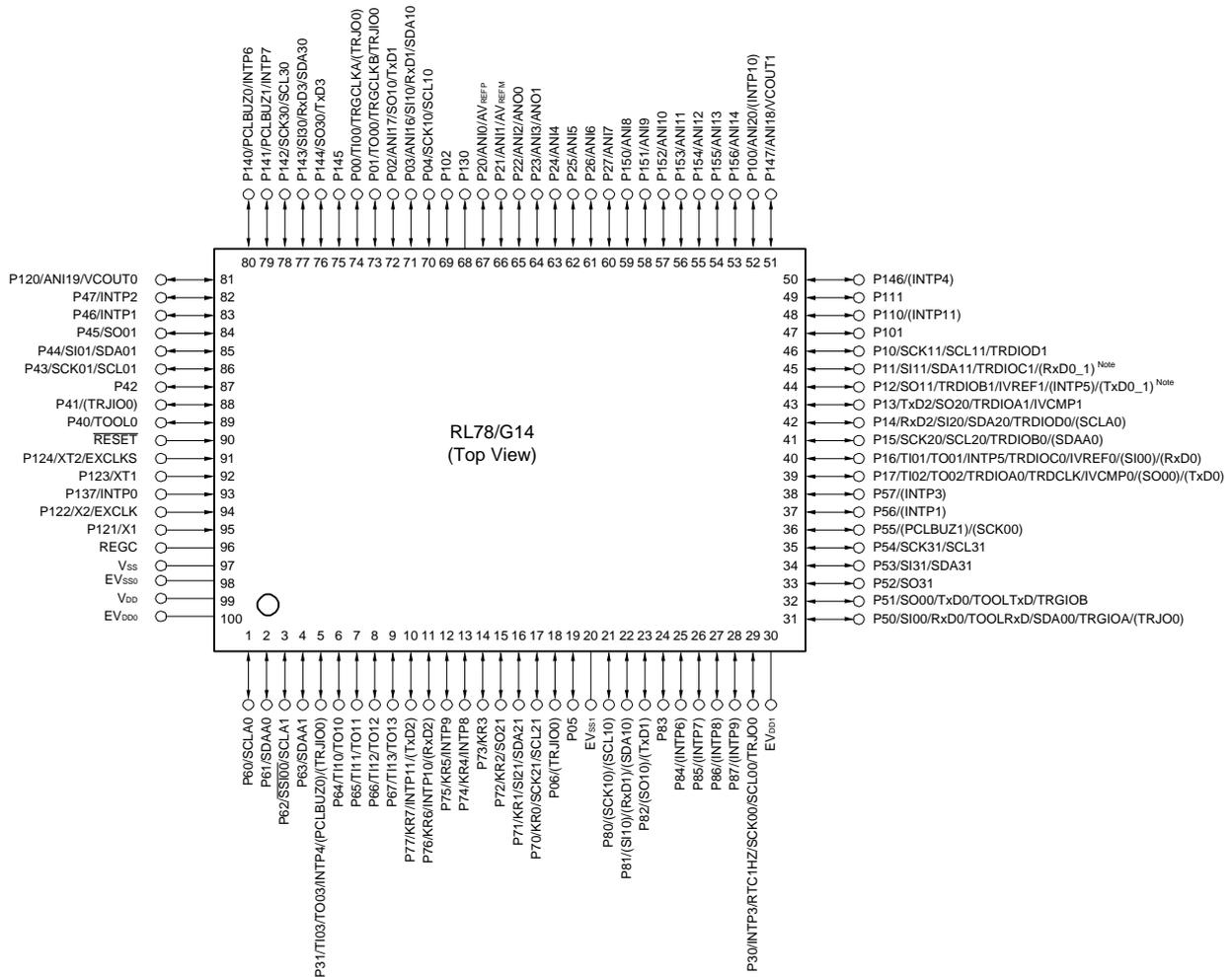

Note Mounted on the 384 KB or more code flash memory products.

Caution 1. Make EV_{SS0}, EV_{SS1} pins the same potential as V_{SS} pin.

Caution 2. Make V_{DD} pin the potential that is higher than EV_{DD0}, EV_{DD1} pins (EV_{DD0} = EV_{DD1}).

Caution 3. Connect the REGC pin to V_{SS} pin via a capacitor (0.47 to 1 μF).

Remark 1. For pin identification, see 1.4 Pin Identification.

Remark 2. When using the microcontroller for an application where the noise generated inside the microcontroller must be reduced, it is recommended to supply separate powers to the V_{DD}, EV_{DD0} and EV_{DD1} pins and connect the V_{SS}, EV_{SS0} and EV_{SS1} pins to separate ground lines.

Remark 3. Functions in parentheses in the above figure can be assigned via settings in the peripheral I/O redirection register 0, 1 (PIOR0, 1).

1.4 Pin Identification

| | | | |
|-----------------------------|--|---|--|
| ANI0 to ANI14, | | RxD0 to RxD3: | Receive data |
| ANI16 to ANI20: | Analog output | SCK00, SCK01, SCK10, | |
| ANO0, ANO1: | Analog output | SCK11, SCK20, SCK21, | |
| AVREFM: | A/D converter reference potential (– side) input | SCK30, SCK31, SCLA0, SCLA1: | Serial clock input/output |
| AVREFF: | A/D converter reference potential (+ side) input | SCL00, SCL01, SCL10, SCL11, SCL20, SCL21, SCL30, | |
| EVDD0, EVDD1: | Power supply for port | SCL31: | Serial clock output |
| EVSS0, EVSS1: | Ground for port | SDAA0, SDAA1, SDA00, | |
| EXCLK: | External clock input (main system clock) | SDA01, SDA10, SDA11, SDA20, SDA21, SDA30, | |
| EXCLKS: | External clock input (subsystem clock) | SDA31: | Serial data input/output |
| INTP0 to INTP11: | External interrupt input | SI00, SI01, SI10, SI11, SI20, SI21, SI30, SI31: | Serial data input |
| IVCMP0, IVCMP1: | Comparator input | SO00, SO01, SO10, | |
| IVREF0, IVREF1: | Comparator reference input | SO11, SO20, SO21, SO30, SO31: | Serial data output |
| KR0 to KR7: | Key return | $\overline{\text{SSI00}}$: | Serial interface chip select input |
| P00 to P06: | Port 0 | TI00 to TI03, | |
| P10 to P17: | Port 1 | TI10 to TI13: | Timer input |
| P20 to P27: | Port 2 | TO00 to TO03, | |
| P30, P31: | Port 3 | TO10 to TO13, TRJ00: | Timer output |
| P40 to P47: | Port 4 | TOOL0: | Data input/output for tool |
| P50 to P57: | Port 5 | TOOLRxD, TOOLTxD: | Data input/output for external device |
| P60 to P67: | Port 6 | TRDCLK, TRGCLKA, | |
| P70 to P77: | Port 7 | TRGCLKB: | Timer external input clock |
| P80 to P87: | Port 8 | TRDIOA0, TRDIOB0, | |
| P100 to P102: | Port 10 | TRDIOC0, TRDIOD0, | |
| P110, P111: | Port 11 | TRDIOA1, TRDIOB1, | |
| P120 to P124: | Port 12 | TRDIOC1, TRDIOD1, | |
| P130, P137: | Port 13 | TRGIOA, TRGIOB, TRJIO0: | Timer input/output |
| P140 to P147: | Port 14 | TxD0 to TxD3: | Transmit data |
| P150 to P156: | Port 15 | VCOUT0, VCOUT1: | Comparator output |
| PCLBUZ0, PCLBUZ1: | Programmable clock output/buzzer output | VDD: | Power supply |
| REGC: | Regulator capacitance | VSS: | Ground |
| $\overline{\text{RESET}}$: | Reset | X1, X2: | Crystal oscillator (main system clock) |
| RTC1HZ: | Real-time clock correction clock (1 Hz) output | XT1, XT2: | Crystal oscillator (subsystem clock) |

1.5 Block Diagram

1.5.1 30-pin products

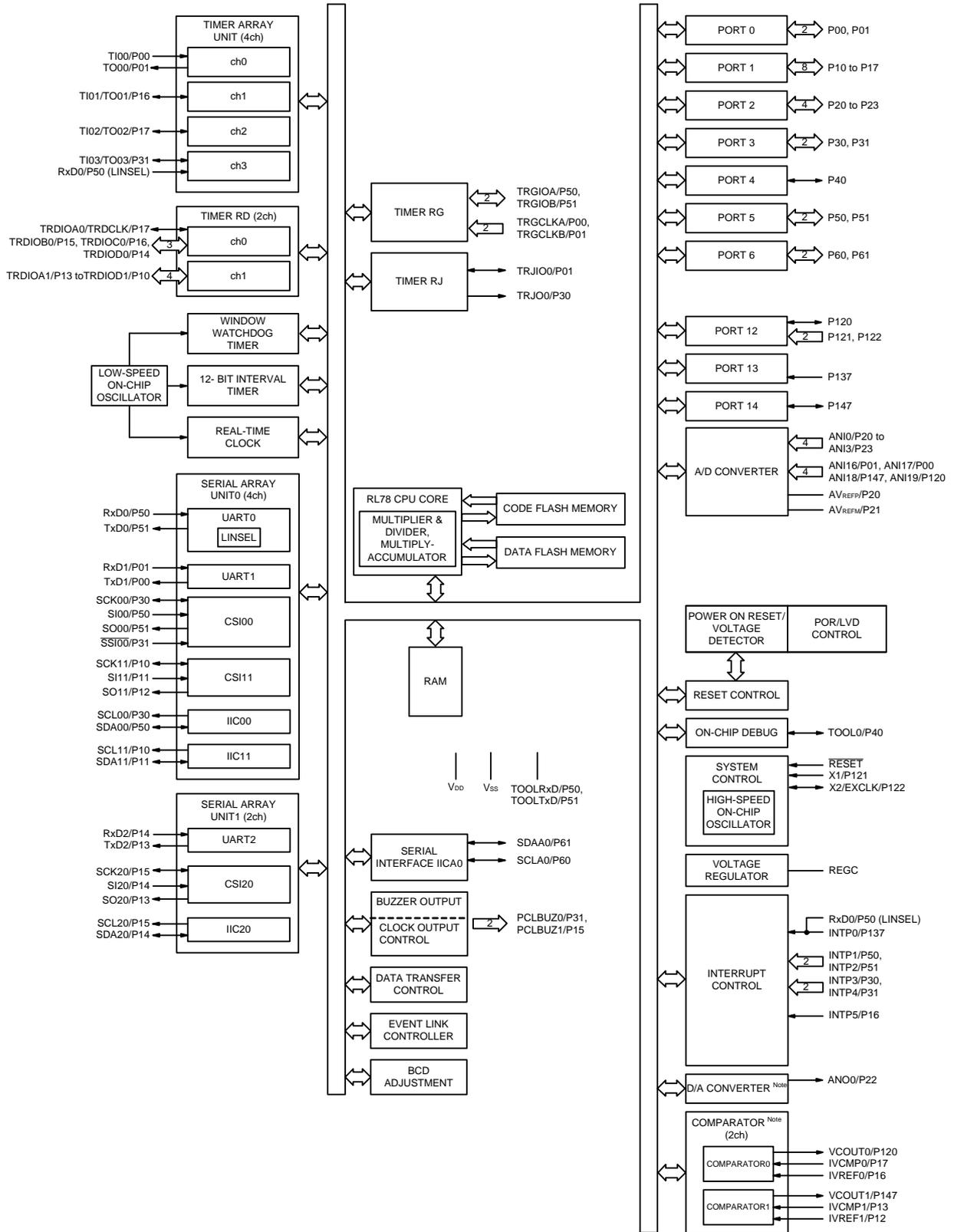

Note Mounted on the 96 KB or more code flash memory products.

1.5.2 32-pin products

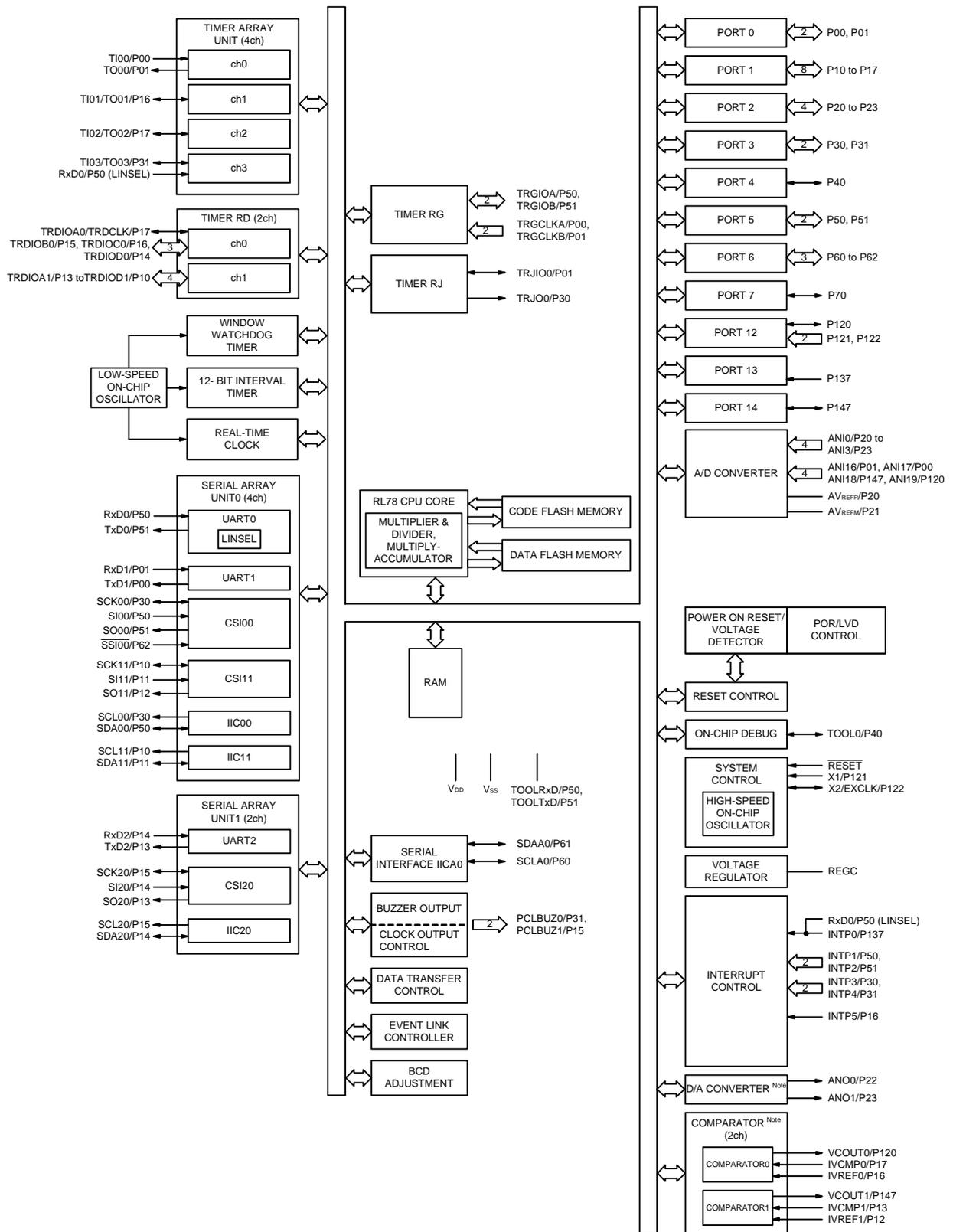

Note Mounted on the 96 KB or more code flash memory products.

1.5.3 36-pin products

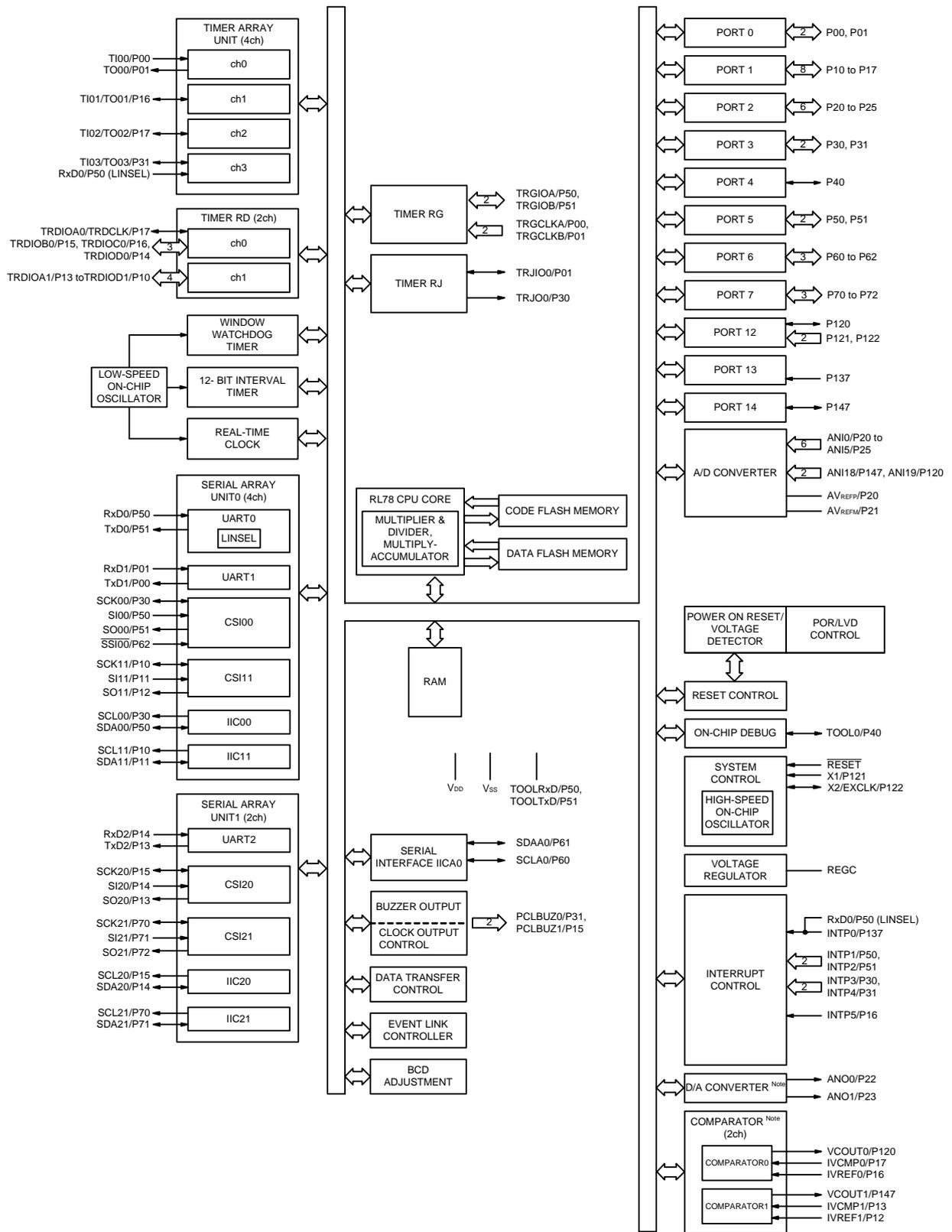

Note Mounted on the 96 KB or more code flash memory products.

1.5.4 40-pin products

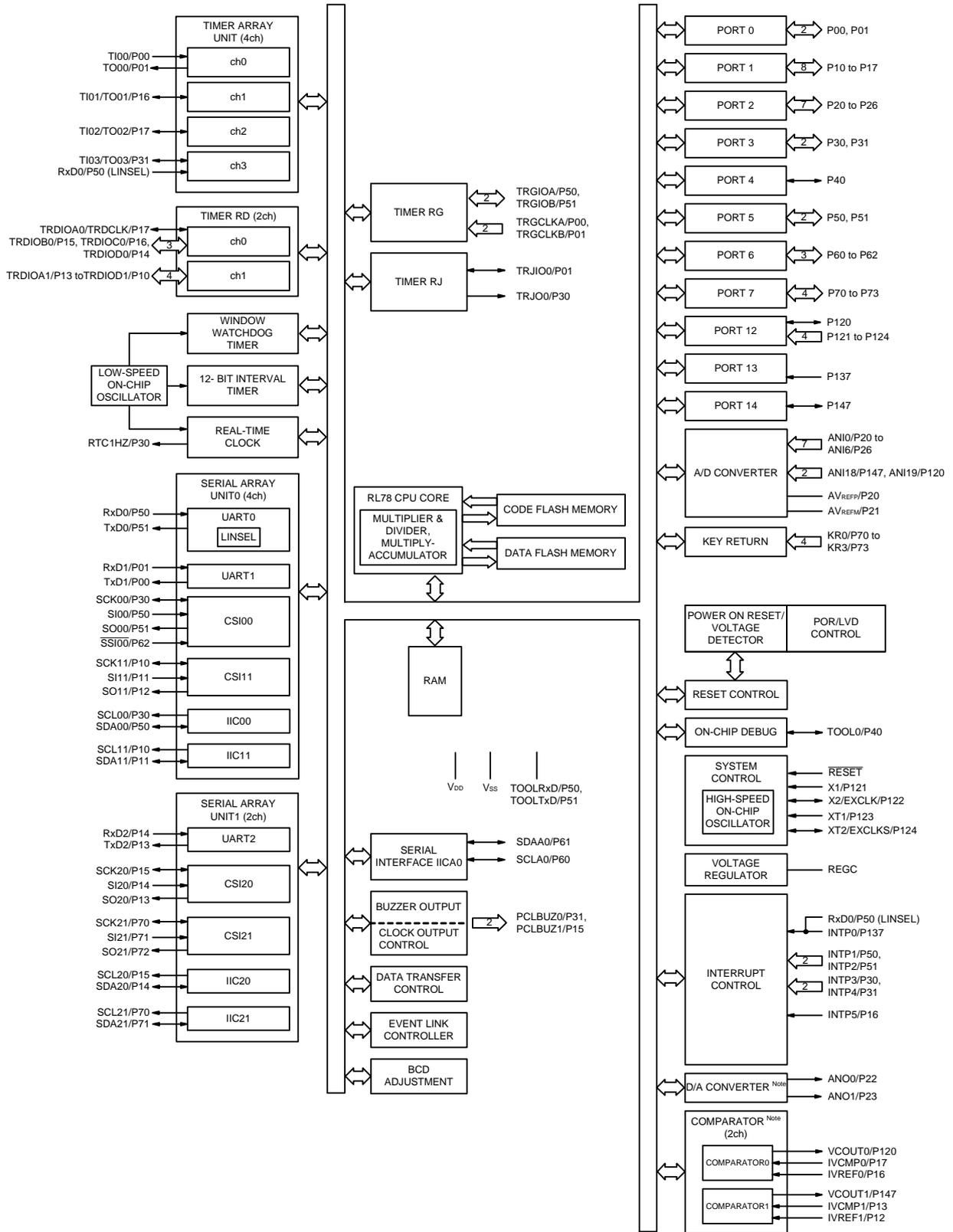

Note Mounted on the 96 KB or more code flash memory products.

1.5.5 44-pin products

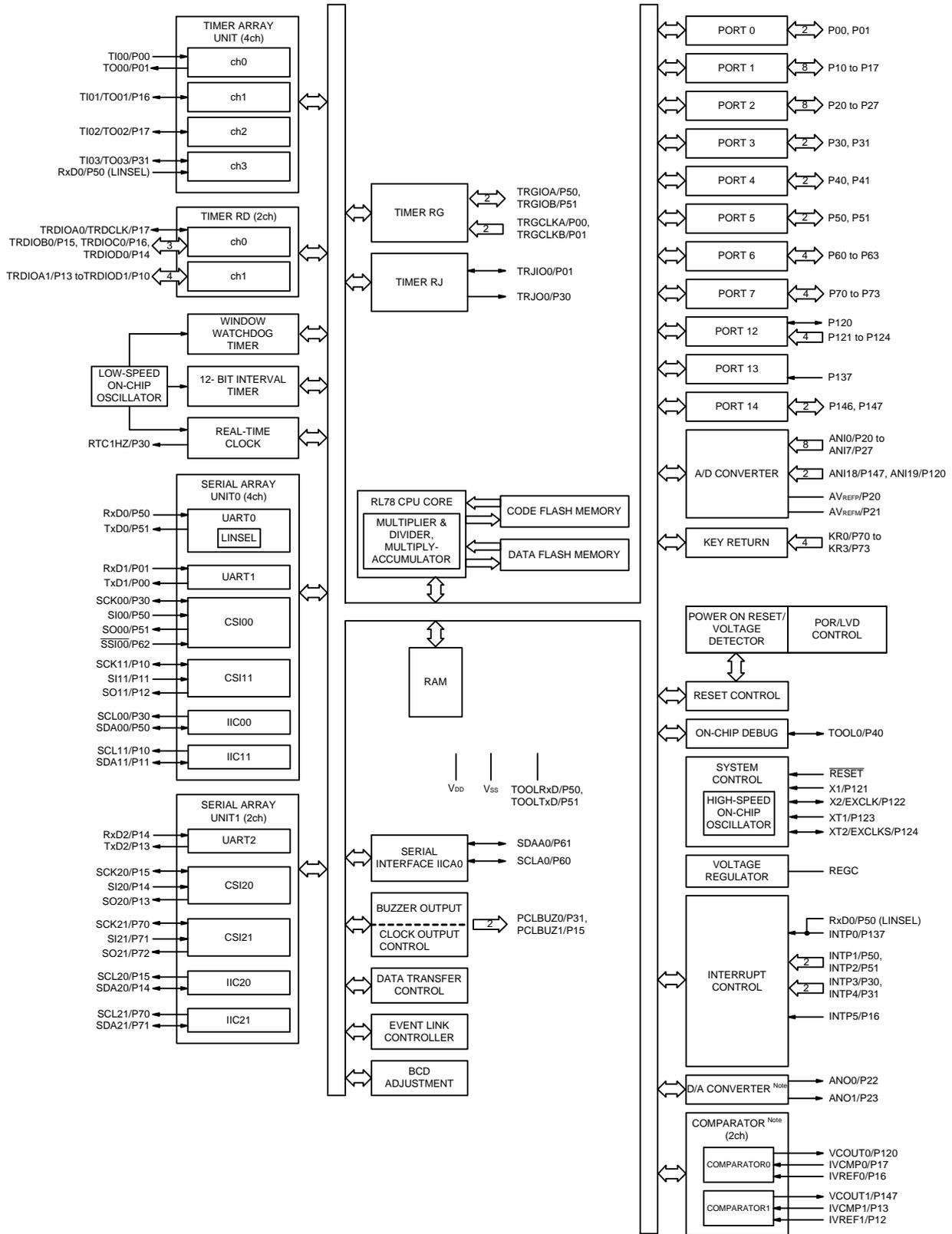

Note Mounted on the 96 KB or more code flash memory products.

1.5.6 48-pin products

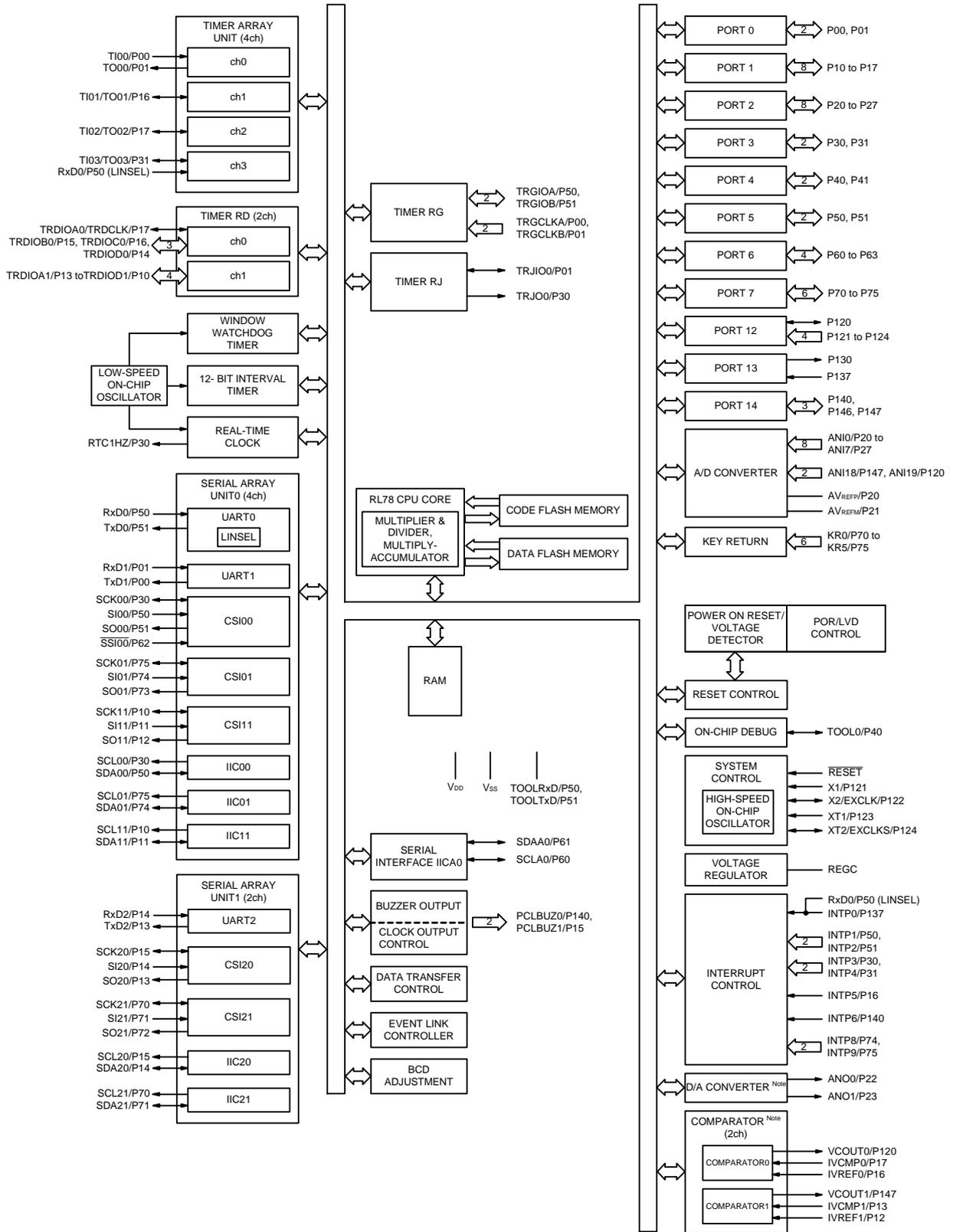

Note Mounted on the 96 KB or more code flash memory products.

1.5.7 52-pin products

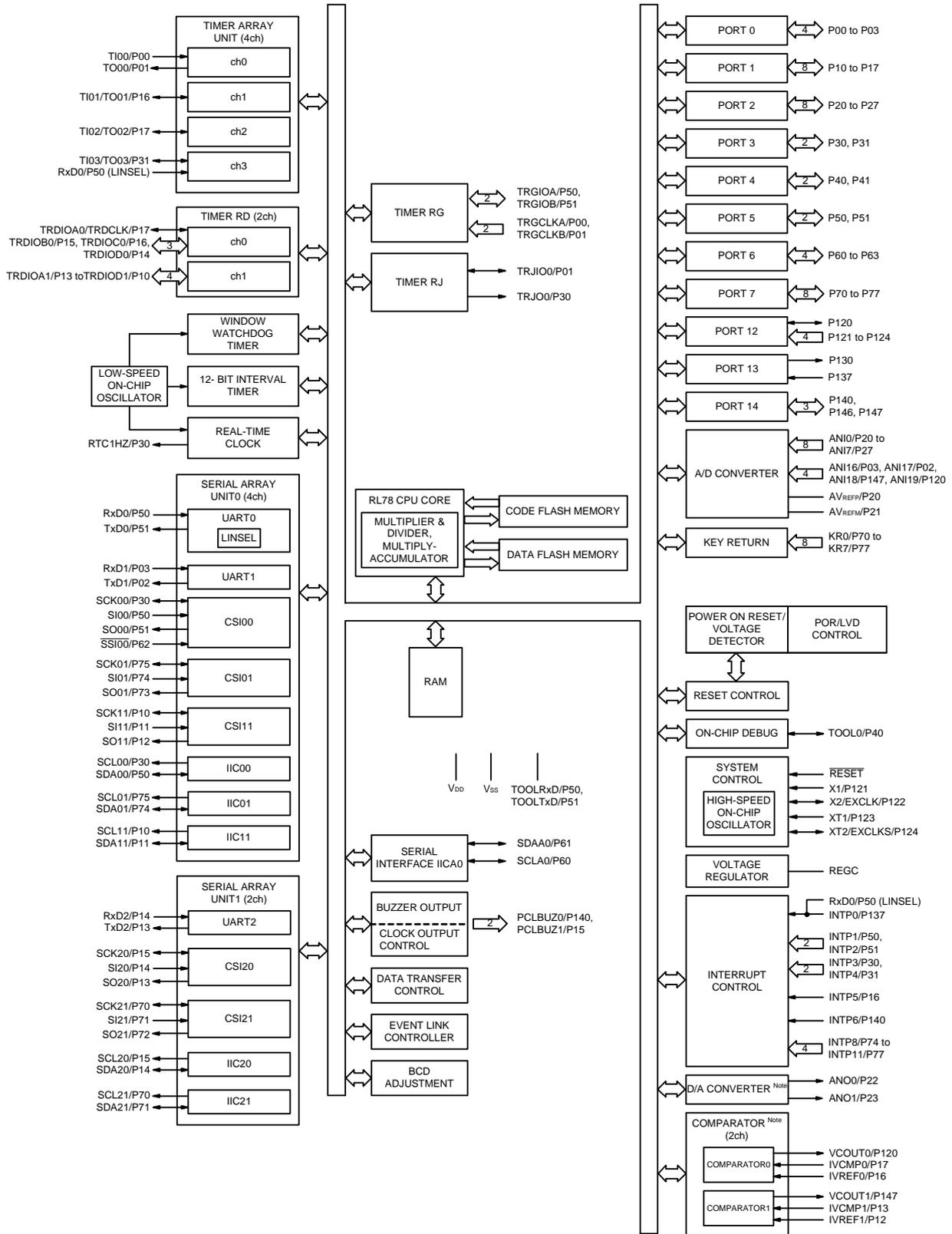

Note Mounted on the 96 KB or more code flash memory products.

1.5.8 64-pin products

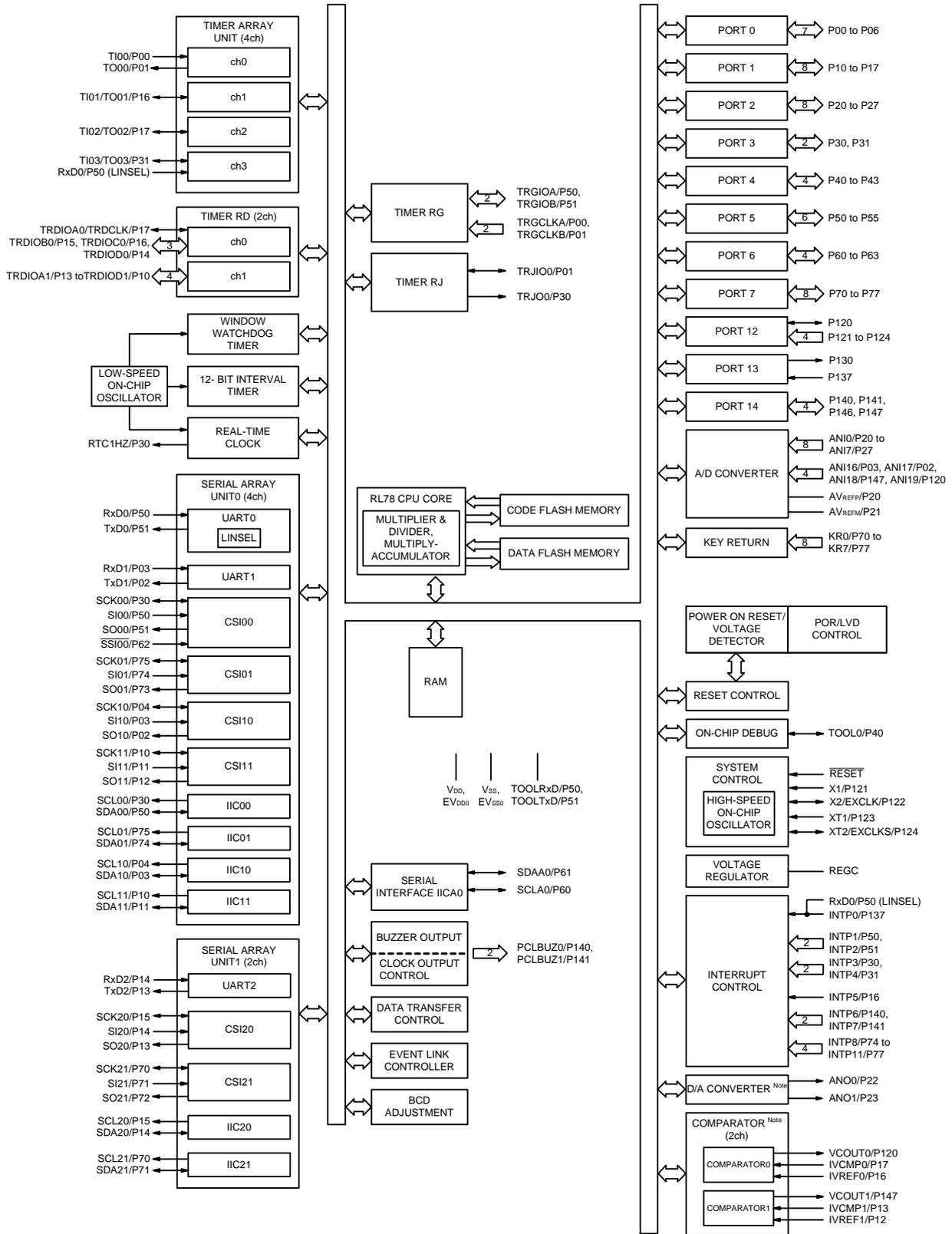

Note Mounted on the 96 KB or more code flash memory products.

1.5.9 80-pin products

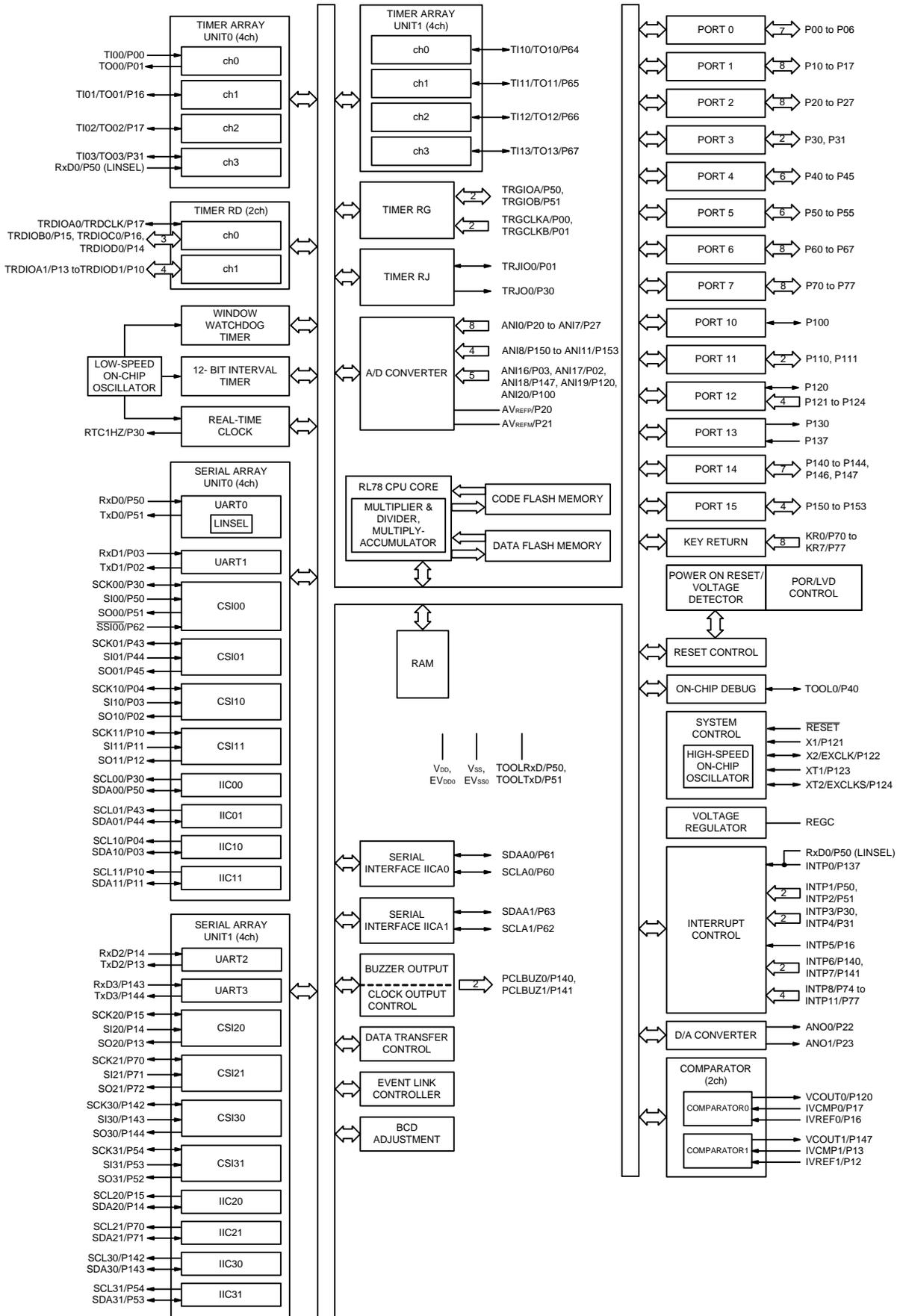

1.5.10 100-pin products

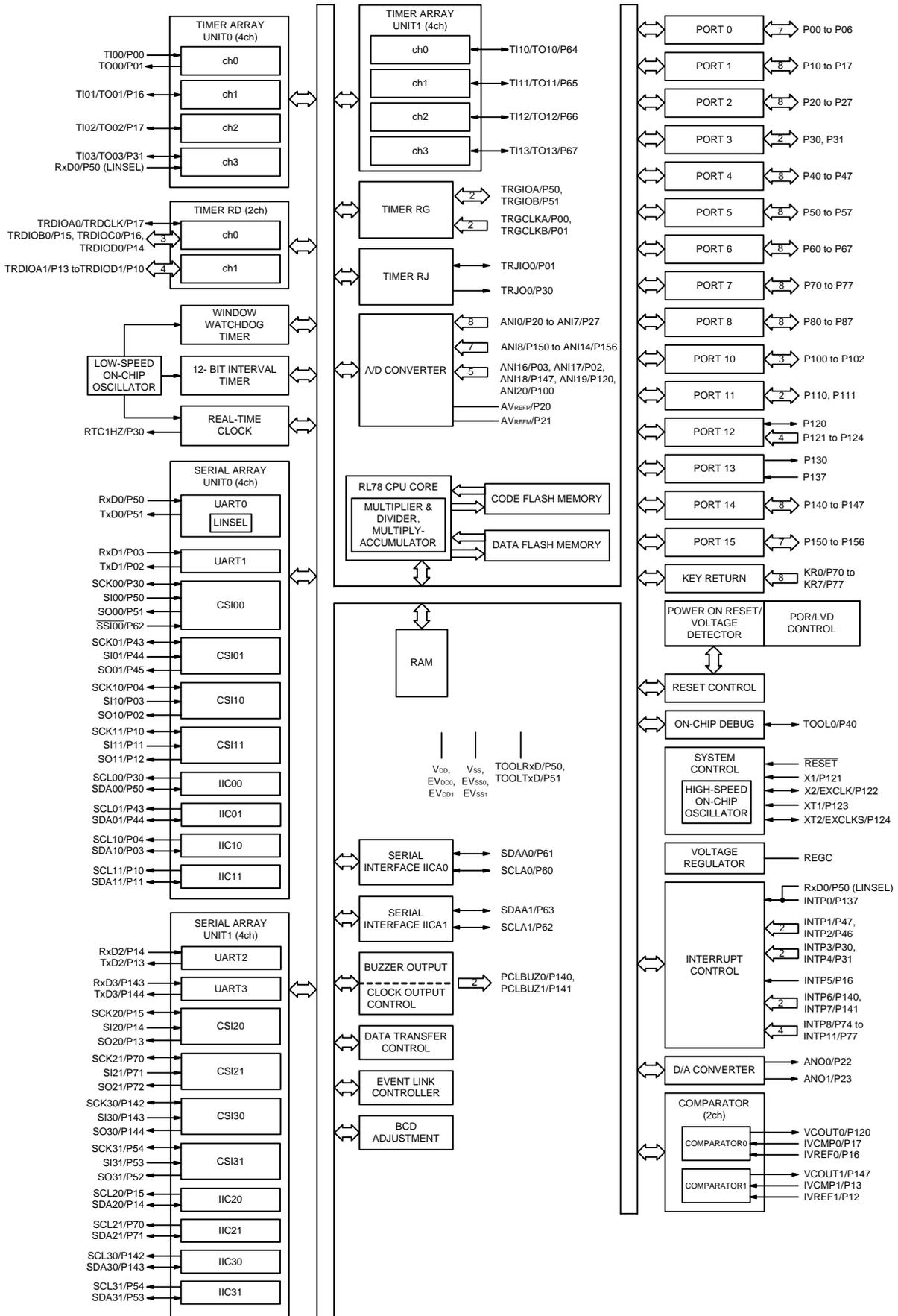

1.6 Outline of Functions

[30-pin, 32-pin, 36-pin, 40-pin products (code flash memory 16 KB to 64 KB)]

Caution This outline describes the functions at the time when Peripheral I/O redirection register 0, 1 (PIOR0, 1) are set to 00H.

(1/2)

| Item | | 30-pin | 32-pin | 36-pin | 40-pin |
|------------------------------------|--|--|-----------------------------|-----------------------------|---|
| | | R5F104Ax (x = A, C to E) | R5F104Bx (x = A, C to E) | R5F104Cx (x = A, C to E) | R5F104Ex (x = A, C to E) |
| Code flash memory (KB) | | 16 to 64 | 16 to 64 | 16 to 64 | 16 to 64 |
| Data flash memory (KB) | | 4 | 4 | 4 | 4 |
| RAM (KB) | | 2.5 to 5.5 Note | 2.5 to 5.5 Note | 2.5 to 5.5 Note | 2.5 to 5.5 Note |
| Address space | | 1 MB | | | |
| Main system clock | High-speed system clock | X1 (crystal/ceramic) oscillation, external main system clock input (EXCLK) HS (high-speed main) mode: 1 to 20 MHz (V _{DD} = 2.7 to 5.5 V), HS (high-speed main) mode: 1 to 16 MHz (V _{DD} = 2.4 to 5.5 V), LS (low-speed main) mode: 1 to 8 MHz (V _{DD} = 1.8 to 5.5 V), LV (low-voltage main) mode: 1 to 4 MHz (V _{DD} = 1.6 to 5.5 V) | | | |
| | High-speed on-chip oscillator clock (f _{IH}) | HS (high-speed main) mode: 1 to 32 MHz (V _{DD} = 2.7 to 5.5 V), HS (high-speed main) mode: 1 to 16 MHz (V _{DD} = 2.4 to 5.5 V), LS (low-speed main) mode: 1 to 8 MHz (V _{DD} = 1.8 to 5.5 V), LV (low-voltage main) mode: 1 to 4 MHz (V _{DD} = 1.6 to 5.5 V) | | | |
| Subsystem clock | | — | | | XT1 (crystal) oscillation, external subsystem clock input (EXCLKS) 32.768 kHz |
| Low-speed on-chip oscillator clock | | 15 kHz (TYP.): V _{DD} = 1.6 to 5.5 V | | | |
| General-purpose register | | 8 bits × 32 registers (8 bits × 8 registers × 4 banks) | | | |
| Minimum instruction execution time | | 0.03125 μs (High-speed on-chip oscillator clock: f _{IH} = 32 MHz operation) | | | |
| | | 0.05 μs (High-speed system clock: f _{MX} = 20 MHz operation) | | | |
| | | — | | | 30.5 μs (Subsystem clock: f _{SUB} = 32.768 kHz operation) |
| Instruction set | | <ul style="list-style-type: none"> Data transfer (8/16 bits) Adder and subtractor/logical operation (8/16 bits) Multiplication (8 bits × 8 bits, 16 bits × 16 bits), Division (16 bits ÷ 16 bits, 32 bits ÷ 32 bits) Multiplication and Accumulation (16 bits × 16 bits + 32 bits) Rotate, barrel shift, and bit manipulation (Set, reset, test, and Boolean operation), etc. | | | |
| I/O port | Total | 26 | 28 | 32 | 36 |
| | CMOS I/O | 21 | 22 | 26 | 28 |
| | CMOS input | 3 | 3 | 3 | 5 |
| | CMOS output | — | — | — | — |
| | N-ch open-drain I/O (6 V tolerance) | 2 | 3 | 3 | 3 |
| Timer | 16-bit timer | 8 channels (TAU: 4 channels, Timer RJ: 1 channel, Timer RD: 2 channels, Timer RG: 1 channel) | | | |
| | Watchdog timer | 1 channel | | | |
| | Real-time clock (RTC) | 1 channel | | | |
| | 12-bit interval timer | 1 channel | | | |
| | Timer output | Timer outputs: 13 channels PWM outputs: 9 channels | | | |
| | RTC output | — | | | 1 • 1 Hz (subsystem clock: f _{SUB} = 32.768 kHz) |

(Note is listed on the next page.)

Note The flash library uses RAM in self-programming and rewriting of the data flash memory.
The target products and start address of the RAM areas used by the flash library are shown below.
R5F104xD (x = A to C, E to G, J, L): Start address FE900H
R5F104xE (x = A to C, E to G, J, L): Start address FE900H
For the RAM areas used by the flash library, see **Self RAM list of Flash Self-Programming Library for RL78 Family (R20UT2944)**.

(2/2)

| Item | 30-pin | 32-pin | 36-pin | 40-pin |
|-----------------------------------|--|-----------------------------|-----------------------------|--|
| | R5F104Ax (x = A, C to E) | R5F104Bx (x = A, C to E) | R5F104Cx (x = A, C to E) | R5F104Ex (x = A, C to E) |
| Clock output/buzzer output | 2 | 2 | 2 | 2 |
| | [30-pin, 32-pin, 36-pin products] • 2.44 kHz, 4.88 kHz, 9.76 kHz, 1.25 MHz, 2.5 MHz, 5 MHz, 10 MHz (Main system clock: $f_{MAIN} = 20$ MHz operation) [40-pin products] • 2.44 kHz, 4.88 kHz, 9.76 kHz, 1.25 MHz, 2.5 MHz, 5 MHz, 10 MHz (Main system clock: $f_{MAIN} = 20$ MHz operation) • 256 Hz, 512 Hz, 1.024 kHz, 2.048 kHz, 4.096 kHz, 8.192 kHz, 16.384 kHz, 32.768 kHz (Subsystem clock: $f_{SUB} = 32.768$ kHz operation) | | | |
| 8/10-bit resolution A/D converter | 8 channels | 8 channels | 8 channels | 9 channels |
| Serial interface | [30-pin, 32-pin products] • CSI: 1 channel/UART (UART supporting LIN-bus): 1 channel/simplified I ² C: 1 channel • CSI: 1 channel/UART: 1 channel/simplified I ² C: 1 channel • CSI: 1 channel/UART: 1 channel/simplified I ² C: 1 channel [36-pin, 40-pin products] • CSI: 1 channel/UART (UART supporting LIN-bus): 1 channel/simplified I ² C: 1 channel • CSI: 1 channel/UART: 1 channel/simplified I ² C: 1 channel • CSI: 2 channels/UART: 1 channel/simplified I ² C: 2 channels | | | |
| I ² C bus | 1 channel | 1 channel | 1 channel | 1 channel |
| Data transfer controller (DTC) | 28 sources | | | 29 sources |
| Event link controller (ELC) | Event input: 19 Event trigger output: 7 | | | Event input: 20 Event trigger output: 7 |
| Vectored interrupt sources | Internal | 24 | 24 | 24 |
| | External | 6 | 6 | 7 |
| Key interrupt | — | — | — | 4 |
| Reset | <ul style="list-style-type: none"> Reset by \overline{RESET} pin Internal reset by watchdog timer Internal reset by power-on-reset Internal reset by voltage detector Internal reset by illegal instruction execution ^{Note} Internal reset by RAM parity error Internal reset by illegal-memory access | | | |
| Power-on-reset circuit | <ul style="list-style-type: none"> Power-on-reset: 1.51 ±0.04 V ($T_A = -40$ to +85°C) 1.51 ±0.06 V ($T_A = -40$ to +105°C) Power-down-reset: 1.50 ±0.04 V ($T_A = -40$ to +85°C) 1.50 ±0.06 V ($T_A = -40$ to +105°C) | | | |
| Voltage detector | 1.63 V to 4.06 V (14 stages) | | | |
| On-chip debug function | Provided | | | |
| Power supply voltage | $V_{DD} = 1.6$ to 5.5 V ($T_A = -40$ to +85°C) $V_{DD} = 2.4$ to 5.5 V ($T_A = -40$ to +105°C) | | | |
| Operating ambient temperature | $T_A = -40$ to +85°C (A: Consumer applications, D: Industrial applications), $T_A = -40$ to +105°C (G: Industrial applications) | | | |

Note The illegal instruction is generated when instruction code FFH is executed.

Reset by the illegal instruction execution not is issued by emulation with the in-circuit emulator or on-chip debug emulator.

[30-pin, 32-pin, 36-pin, 40-pin products (code flash memory 96 KB to 256 KB)]

Caution This outline describes the functions at the time when Peripheral I/O redirection register 0, 1 (PIOR0, 1) are set to 00H.

(1/2)

| Item | | 30-pin | 32-pin | 36-pin | 40-pin |
|------------------------------------|--|--|------------------------|------------------------|--|
| | | R5F104Ax (x = F, G) | R5F104Bx (x = F, G) | R5F104Cx (x = F, G) | R5F104Ex (x = F to H) |
| Code flash memory (KB) | | 96 to 128 | 96 to 128 | 96 to 128 | 96 to 192 |
| Data flash memory (KB) | | 8 | 8 | 8 | 8 |
| RAM (KB) | | 12 to 16 <i>Note</i> | 12 to 16 <i>Note</i> | 12 to 16 <i>Note</i> | 12 to 20 <i>Note</i> |
| Address space | | 1 MB | | | |
| Main system clock | High-speed system clock | X1 (crystal/ceramic) oscillation, external main system clock input (EXCLK) HS (high-speed main) mode: 1 to 20 MHz ($V_{DD} = 2.7$ to 5.5 V), HS (high-speed main) mode: 1 to 16 MHz ($V_{DD} = 2.4$ to 5.5 V), LS (low-speed main) mode: 1 to 8 MHz ($V_{DD} = 1.8$ to 5.5 V), LV (low-voltage main) mode: 1 to 4 MHz ($V_{DD} = 1.6$ to 5.5 V) | | | |
| | High-speed on-chip oscillator clock (f _{IH}) | HS (high-speed main) mode: 1 to 32 MHz ($V_{DD} = 2.7$ to 5.5 V), HS (high-speed main) mode: 1 to 16 MHz ($V_{DD} = 2.4$ to 5.5 V), LS (low-speed main) mode: 1 to 8 MHz ($V_{DD} = 1.8$ to 5.5 V), LV (low-voltage main) mode: 1 to 4 MHz ($V_{DD} = 1.6$ to 5.5 V) | | | |
| Subsystem clock | | — | | | XT1 (crystal) oscillation, external subsystem clock input (EXCLKS) 32.768 kHz |
| Low-speed on-chip oscillator clock | | 15 kHz (TYP.): $V_{DD} = 1.6$ to 5.5 V | | | |
| General-purpose register | | 8 bits × 32 registers (8 bits × 8 registers × 4 banks) | | | |
| Minimum instruction execution time | | 0.03125 μs (High-speed on-chip oscillator clock: f _{IH} = 32 MHz operation) | | | |
| | | 0.05 μs (High-speed system clock: f _{MX} = 20 MHz operation) | | | |
| | | — | | | 30.5 μs (Subsystem clock: f _{SUB} = 32.768 kHz operation) |
| Instruction set | | <ul style="list-style-type: none"> • Data transfer (8/16 bits) • Adder and subtractor/logical operation (8/16 bits) • Multiplication (8 bits × 8 bits, 16 bits × 16 bits), Division (16 bits ÷ 16 bits, 32 bits ÷ 32 bits) • Multiplication and Accumulation (16 bits × 16 bits + 32 bits) • Rotate, barrel shift, and bit manipulation (Set, reset, test, and Boolean operation), etc. | | | |
| I/O port | Total | 26 | 28 | 32 | 36 |
| | CMOS I/O | 21 | 22 | 26 | 28 |
| | CMOS input | 3 | 3 | 3 | 5 |
| | CMOS output | — | — | — | — |
| | N-ch open-drain I/O (6 V tolerance) | 2 | 3 | 3 | 3 |
| Timer | 16-bit timer | 8 channels (TAU: 4 channels, Timer RJ: 1 channel, Timer RD: 2 channels, Timer RG: 1 channel) | | | |
| | Watchdog timer | 1 channel | | | |
| | Real-time clock (RTC) | 1 channel | | | |
| | 12-bit interval timer | 1 channel | | | |
| | Timer output | Timer outputs: 13 channels PWM outputs: 9 channels | | | |
| | RTC output | — | | | 1 • 1 Hz (subsystem clock: f _{SUB} = 32.768 kHz) |

(Note is listed on the next page.)

Note The flash library uses RAM in self-programming and rewriting of the data flash memory.
The target products and start address of the RAM areas used by the flash library are shown below.
R5F104xJ (x = F, G, J, L, M, P): Start address F9F00H
For the RAM areas used by the flash library, see **Self RAM list of Flash Self-Programming Library for RL78 Family (R20UT2944)**.

(2/2)

| Item | 30-pin | 32-pin | 36-pin | 40-pin |
|-----------------------------------|--|--|------------------------|--|
| | R5F104Ax (x = F, G) | R5F104Bx (x = F, G) | R5F104Cx (x = F, G) | R5F104Ex (x = F to H) |
| Clock output/buzzer output | 2 | 2 | 2 | 2 |
| | [30-pin, 32-pin, 36-pin products] • 2.44 kHz, 4.88 kHz, 9.76 kHz, 1.25 MHz, 2.5 MHz, 5 MHz, 10 MHz (Main system clock: $f_{MAIN} = 20$ MHz operation) [40-pin products] • 2.44 kHz, 4.88 kHz, 9.76 kHz, 1.25 MHz, 2.5 MHz, 5 MHz, 10 MHz (Main system clock: $f_{MAIN} = 20$ MHz operation) • 256 Hz, 512 Hz, 1.024 kHz, 2.048 kHz, 4.096 kHz, 8.192 kHz, 16.384 kHz, 32.768 kHz (Subsystem clock: $f_{SUB} = 32.768$ kHz operation) | | | |
| 8/10-bit resolution A/D converter | 8 channels | 8 channels | 8 channels | 9 channels |
| D/A converter | 1 channel | 2 channels | | |
| Comparator | 2 channels | | | |
| Serial interface | [30-pin, 32-pin products] • CSI: 1 channel/UART (UART supporting LIN-bus): 1 channel/simplified I ² C: 1 channel • CSI: 1 channel/UART: 1 channel/simplified I ² C: 1 channel • CSI: 1 channel/UART: 1 channel/simplified I ² C: 1 channel [36-pin, 40-pin products] • CSI: 1 channel/UART (UART supporting LIN-bus): 1 channel/simplified I ² C: 1 channel • CSI: 1 channel/UART: 1 channel/simplified I ² C: 1 channel • CSI: 2 channels/UART: 1 channel/simplified I ² C: 2 channels | | | |
| | I ² C bus | 1 channel | 1 channel | 1 channel |
| Data transfer controller (DTC) | 30 sources | | | 31 sources |
| Event link controller (ELC) | Event input: 21 Event trigger output: 8 | Event input: 21, Event trigger output: 9 | | Event input: 22 Event trigger output: 9 |
| Vectored interrupt sources | Internal | 24 | 24 | 24 |
| | External | 6 | 6 | 7 |
| Key interrupt | — | — | — | 4 |
| Reset | <ul style="list-style-type: none"> Reset by \overline{RESET} pin Internal reset by watchdog timer Internal reset by power-on-reset Internal reset by voltage detector Internal reset by illegal instruction execution ^{Note} Internal reset by RAM parity error Internal reset by illegal-memory access | | | |
| Power-on-reset circuit | <ul style="list-style-type: none"> Power-on-reset: 1.51 ±0.04 V ($T_A = -40$ to +85°C) 1.51 ±0.06 V ($T_A = -40$ to +105°C) Power-down-reset: 1.50 ±0.04 V ($T_A = -40$ to +85°C) 1.50 ±0.06 V ($T_A = -40$ to +105°C) | | | |
| Voltage detector | 1.63 V to 4.06 V (14 stages) | | | |
| On-chip debug function | Provided | | | |
| Power supply voltage | $V_{DD} = 1.6$ to 5.5 V ($T_A = -40$ to +85°C) $V_{DD} = 2.4$ to 5.5 V ($T_A = -40$ to +105°C) | | | |
| Operating ambient temperature | $T_A = -40$ to +85°C (A: Consumer applications, D: Industrial applications), $T_A = -40$ to +105°C (G: Industrial applications) | | | |

Note The illegal instruction is generated when instruction code FFH is executed.
Reset by the illegal instruction execution not is issued by emulation with the in-circuit emulator or on-chip debug emulator.

[44-pin, 48-pin, 52-pin, 64-pin products (code flash memory 16 KB to 64 KB)]

Caution This outline describes the functions at the time when Peripheral I/O redirection register 0, 1 (PIOR0, 1) are set to 00H.

(1/2)

| Item | | 44-pin | 48-pin | 52-pin | 64-pin |
|------------------------------------|--|--|-----------------------------|--------------------------|--------------------------|
| | | R5F104Fx (x = A, C to E) | R5F104Gx (x = A, C to E) | R5F104Jx (x = C to E) | R5F104Lx (x = C to E) |
| Code flash memory (KB) | | 16 to 64 | 16 to 64 | 32 to 64 | 32 to 64 |
| Data flash memory (KB) | | 4 | 4 | 4 | 4 |
| RAM (KB) | | 2.5 to 5.5 Note | 2.5 to 5.5 Note | 4 to 5.5 Note | 4 to 5.5 Note |
| Address space | | 1 MB | | | |
| Main system clock | High-speed system clock | X1 (crystal/ceramic) oscillation, external main system clock input (EXCLK) HS (high-speed main) mode: 1 to 20 MHz (V _{DD} = 2.7 to 5.5 V), HS (high-speed main) mode: 1 to 16 MHz (V _{DD} = 2.4 to 5.5 V), LS (low-speed main) mode: 1 to 8 MHz (V _{DD} = 1.8 to 5.5 V), LV (low-voltage main) mode: 1 to 4 MHz (V _{DD} = 1.6 to 5.5 V) | | | |
| | High-speed on-chip oscillator clock (f _{IH}) | HS (high-speed main) mode: 1 to 32 MHz (V _{DD} = 2.7 to 5.5 V), HS (high-speed main) mode: 1 to 16 MHz (V _{DD} = 2.4 to 5.5 V), LS (low-speed main) mode: 1 to 8 MHz (V _{DD} = 1.8 to 5.5 V), LV (low-voltage main) mode: 1 to 4 MHz (V _{DD} = 1.6 to 5.5 V) | | | |
| Subsystem clock | | XT1 (crystal) oscillation, external subsystem clock input (EXCLKS) 32.768 kHz | | | |
| Low-speed on-chip oscillator clock | | 15 kHz (TYP.): V _{DD} = 1.6 to 5.5 V | | | |
| General-purpose register | | 8 bits × 32 registers (8 bits × 8 registers × 4 banks) | | | |
| Minimum instruction execution time | | 0.03125 μs (High-speed on-chip oscillator clock: f _{IH} = 32 MHz operation) | | | |
| | | 0.05 μs (High-speed system clock: f _{MX} = 20 MHz operation) | | | |
| | | 30.5 μs (Subsystem clock: f _{SUB} = 32.768 kHz operation) | | | |
| Instruction set | | <ul style="list-style-type: none"> • Data transfer (8/16 bits) • Adder and subtractor/logical operation (8/16 bits) • Multiplication (8 bits × 8 bits, 16 bits × 16 bits), Division (16 bits ÷ 16 bits, 32 bits ÷ 32 bits) • Multiplication and Accumulation (16 bits × 16 bits + 32 bits) • Rotate, barrel shift, and bit manipulation (Set, reset, test, and Boolean operation), etc. | | | |
| I/O port | Total | 40 | 44 | 48 | 58 |
| | CMOS I/O | 31 | 34 | 38 | 48 |
| | CMOS input | 5 | 5 | 5 | 5 |
| | CMOS output | — | 1 | 1 | 1 |
| | N-ch open-drain I/O (6 V tolerance) | 4 | 4 | 4 | 4 |
| Timer | 16-bit timer | 8 channels (TAU: 4 channels, Timer RJ: 1 channel, Timer RD: 2 channels, Timer RG: 1 channel) | | | |
| | Watchdog timer | 1 channel | | | |
| | Real-time clock (RTC) | 1 channel | | | |
| | 12-bit interval timer | 1 channel | | | |
| | Timer output | Timer outputs: 13 channels PWM outputs: 9 channels | | | |
| | RTC output | 1 • 1 Hz (subsystem clock: f _{SUB} = 32.768 kHz) | | | |

(Note is listed on the next page.)

Note The flash library uses RAM in self-programming and rewriting of the data flash memory.
The target products and start address of the RAM areas used by the flash library are shown below.
R5F104xD (x = A to C, E to G, J, L): Start address FE900H
R5F104xE (x = A to C, E to G, J, L): Start address FE900H
For the RAM areas used by the flash library, see **Self RAM list of Flash Self-Programming Library for RL78 Family (R20UT2944)**.

(2/2)

| Item | 44-pin | 48-pin | 52-pin | 64-pin | |
|-----------------------------------|---|-----------------------------|--------------------------|--------------------------|-----------|
| | R5F104Fx (x = A, C to E) | R5F104Gx (x = A, C to E) | R5F104Jx (x = C to E) | R5F104Lx (x = C to E) | |
| Clock output/buzzer output | 2 | 2 | 2 | 2 | |
| | <ul style="list-style-type: none"> 2.44 kHz, 4.88 kHz, 9.76 kHz, 1.25 MHz, 2.5 MHz, 5 MHz, 10 MHz (Main system clock: f_{MAIN} = 20 MHz operation) 256 Hz, 512 Hz, 1.024 kHz, 2.048 kHz, 4.096 kHz, 8.192 kHz, 16.384 kHz, 32.768 kHz (Subsystem clock: f_{SUB} = 32.768 kHz operation) | | | | |
| 8/10-bit resolution A/D converter | 10 channels | 10 channels | 12 channels | 12 channels | |
| Serial interface | [44-pin products] <ul style="list-style-type: none"> CSI: 1 channel/UART (UART supporting LIN-bus): 1 channel/simplified I²C: 1 channel CSI: 1 channel/UART: 1 channel/simplified I²C: 1 channel CSI: 2 channels/UART: 1 channel/simplified I²C: 2 channels [48-pin, 52-pin products] <ul style="list-style-type: none"> CSI: 2 channels/UART (UART supporting LIN-bus): 1 channel/simplified I²C: 2 channels CSI: 1 channel/UART: 1 channel/simplified I²C: 1 channel CSI: 2 channels/UART: 1 channel/simplified I²C: 2 channels [64-pin products] <ul style="list-style-type: none"> CSI: 2 channels/UART (UART supporting LIN-bus): 1 channel/simplified I²C: 2 channels CSI: 2 channels/UART: 1 channel/simplified I²C: 2 channels CSI: 2 channels/UART: 1 channel/simplified I²C: 2 channels | | | | |
| | I ² C bus | 1 channel | 1 channel | 1 channel | 1 channel |
| Data transfer controller (DTC) | 29 sources | 30 sources | | 31 sources | |
| Event link controller (ELC) | Event input: 20 Event trigger output: 7 | | | | |
| Vectored interrupt sources | Internal | 24 | 24 | 24 | 24 |
| | External | 7 | 10 | 12 | 13 |
| Key interrupt | 4 | 6 | 8 | 8 | |
| Reset | <ul style="list-style-type: none"> Reset by RESET pin Internal reset by watchdog timer Internal reset by power-on-reset Internal reset by voltage detector Internal reset by illegal instruction execution ^{Note} Internal reset by RAM parity error Internal reset by illegal-memory access | | | | |
| Power-on-reset circuit | <ul style="list-style-type: none"> Power-on-reset: 1.51 ±0.04 V (T_A = -40 to +85°C) 1.51 ±0.06 V (T_A = -40 to +105°C) Power-down-reset: 1.50 ±0.04 V (T_A = -40 to +85°C) 1.50 ±0.06 V (T_A = -40 to +105°C) | | | | |
| Voltage detector | 1.63 V to 4.06 V (14 stages) | | | | |
| On-chip debug function | Provided | | | | |
| Power supply voltage | V _{DD} = 1.6 to 5.5 V (T _A = -40 to +85°C) V _{DD} = 2.4 to 5.5 V (T _A = -40 to +105°C) | | | | |
| Operating ambient temperature | T _A = -40 to +85°C (A: Consumer applications, D: Industrial applications), T _A = -40 to +105°C (G: Industrial applications) | | | | |

Note The illegal instruction is generated when instruction code FFH is executed.
Reset by the illegal instruction execution is not issued by emulation with the in-circuit emulator or on-chip debug emulator.

[44-pin, 48-pin, 52-pin, 64-pin products (code flash memory 96 KB to 256 KB)]

Caution This outline describes the functions at the time when Peripheral I/O redirection register 0, 1 (PIOR0, 1) are set to 00H.

(1/2)

| Item | | 44-pin | 48-pin | 52-pin | 64-pin |
|------------------------------------|--|--|-----------------------------|-----------------------------|-----------------------------|
| | | R5F104Fx (x = F to H, J) | R5F104Gx (x = F to H, J) | R5F104Jx (x = F to H, J) | R5F104Lx (x = F to H, J) |
| Code flash memory (KB) | | 96 to 256 | 96 to 256 | 96 to 256 | 96 to 256 |
| Data flash memory (KB) | | 8 | 8 | 8 | 8 |
| RAM (KB) | | 12 to 24 Note | 12 to 24 Note | 12 to 24 Note | 12 to 24 Note |
| Address space | | 1 MB | | | |
| Main system clock | High-speed system clock | X1 (crystal/ceramic) oscillation, external main system clock input (EXCLK) HS (high-speed main) mode: 1 to 20 MHz (V _{DD} = 2.7 to 5.5 V), HS (high-speed main) mode: 1 to 16 MHz (V _{DD} = 2.4 to 5.5 V), LS (low-speed main) mode: 1 to 8 MHz (V _{DD} = 1.8 to 5.5 V), LV (low-voltage main) mode: 1 to 4 MHz (V _{DD} = 1.6 to 5.5 V) | | | |
| | High-speed on-chip oscillator clock (f _{IH}) | HS (high-speed main) mode: 1 to 32 MHz (V _{DD} = 2.7 to 5.5 V), HS (high-speed main) mode: 1 to 16 MHz (V _{DD} = 2.4 to 5.5 V), LS (low-speed main) mode: 1 to 8 MHz (V _{DD} = 1.8 to 5.5 V), LV (low-voltage main) mode: 1 to 4 MHz (V _{DD} = 1.6 to 5.5 V) | | | |
| Subsystem clock | | XT1 (crystal) oscillation, external subsystem clock input (EXCLKS) 32.768 kHz | | | |
| Low-speed on-chip oscillator clock | | 15 kHz (TYP.): V _{DD} = 1.6 to 5.5 V | | | |
| General-purpose register | | 8 bits × 32 registers (8 bits × 8 registers × 4 banks) | | | |
| Minimum instruction execution time | | 0.03125 μs (High-speed on-chip oscillator clock: f _{IH} = 32 MHz operation) | | | |
| | | 0.05 μs (High-speed system clock: f _{MX} = 20 MHz operation) | | | |
| | | 30.5 μs (Subsystem clock: f _{SUB} = 32.768 kHz operation) | | | |
| Instruction set | | <ul style="list-style-type: none"> • Data transfer (8/16 bits) • Adder and subtractor/logical operation (8/16 bits) • Multiplication (8 bits × 8 bits, 16 bits × 16 bits), Division (16 bits ÷ 16 bits, 32 bits ÷ 32 bits) • Multiplication and Accumulation (16 bits × 16 bits + 32 bits) • Rotate, barrel shift, and bit manipulation (Set, reset, test, and Boolean operation), etc. | | | |
| I/O port | Total | 40 | 44 | 48 | 58 |
| | CMOS I/O | 31 | 34 | 38 | 48 |
| | CMOS input | 5 | 5 | 5 | 5 |
| | CMOS output | — | 1 | 1 | 1 |
| | N-ch open-drain I/O (6 V tolerance) | 4 | 4 | 4 | 4 |
| Timer | 16-bit timer | 8 channels (TAU: 4 channels, Timer RJ: 1 channel, Timer RD: 2 channels, Timer RG: 1 channel) | | | |
| | Watchdog timer | 1 channel | | | |
| | Real-time clock (RTC) | 1 channel | | | |
| | 12-bit interval timer | 1 channel | | | |
| | Timer output | Timer outputs: 14 channels PWM outputs: 9 channels | | | |
| | RTC output | 1 • 1 Hz (subsystem clock: f _{SUB} = 32.768 kHz) | | | |

(Note is listed on the next page.)

Note The flash library uses RAM in self-programming and rewriting of the data flash memory.
The target products and start address of the RAM areas used by the flash library are shown below.
R5F104xJ (x = F, G, J, L, M, P): Start address F9F00H
For the RAM areas used by the flash library, see **Self RAM list of Flash Self-Programming Library for RL78 Family (R20UT2944)**.

(2/2)

| Item | 44-pin | 48-pin | 52-pin | 64-pin |
|-----------------------------------|---|-----------------------------|-----------------------------|-----------------------------|
| | R5F104Fx (x = F to H, J) | R5F104Gx (x = F to H, J) | R5F104Jx (x = F to H, J) | R5F104Lx (x = F to H, J) |
| Clock output/buzzer output | 2 | 2 | 2 | 2 |
| | <ul style="list-style-type: none"> • 2.44 kHz, 4.88 kHz, 9.76 kHz, 1.25 MHz, 2.5 MHz, 5 MHz, 10 MHz (Main system clock: f_{MAIN} = 20 MHz operation) • 256 Hz, 512 Hz, 1.024 kHz, 2.048 kHz, 4.096 kHz, 8.192 kHz, 16.384 kHz, 32.768 kHz (Subsystem clock: f_{SUB} = 32.768 kHz operation) | | | |
| 8/10-bit resolution A/D converter | 10 channels | 10 channels | 12 channels | 12 channels |
| D/A converter | 2 channels | | | |
| Comparator | 2 channels | | | |
| Serial interface | [44-pin products] <ul style="list-style-type: none"> • CSI: 1 channel/UART (UART supporting LIN-bus): 1 channel/simplified I²C: 1 channel • CSI: 1 channel/UART: 1 channel/simplified I²C: 1 channel • CSI: 2 channels/UART: 1 channel/simplified I²C: 2 channels [48-pin, 52-pin products] <ul style="list-style-type: none"> • CSI: 2 channels/UART (UART supporting LIN-bus): 1 channel/simplified I²C: 2 channels • CSI: 1 channel/UART: 1 channel/simplified I²C: 1 channel • CSI: 2 channels/UART: 1 channel/simplified I²C: 2 channels [64-pin products] <ul style="list-style-type: none"> • CSI: 2 channels/UART (UART supporting LIN-bus): 1 channel/simplified I²C: 2 channels • CSI: 2 channels/UART: 1 channel/simplified I²C: 2 channels • CSI: 2 channels/UART: 1 channel/simplified I²C: 2 channels | | | |
| | I ² C bus | 1 channel | 1 channel | 1 channel |
| Data transfer controller (DTC) | 31 sources | 32 sources | | 33 sources |
| Event link controller (ELC) | Event input: 22 Event trigger output: 9 | | | |
| Vectored interrupt sources | Internal | 24 | 24 | 24 |
| | External | 7 | 10 | 13 |
| Key interrupt | 4 | 6 | 8 | 8 |
| Reset | <ul style="list-style-type: none"> • Reset by $\overline{\text{RESET}}$ pin • Internal reset by watchdog timer • Internal reset by power-on-reset • Internal reset by voltage detector • Internal reset by illegal instruction execution ^{Note} • Internal reset by RAM parity error • Internal reset by illegal-memory access | | | |
| Power-on-reset circuit | <ul style="list-style-type: none"> • Power-on-reset: 1.51 ±0.04 V (T_A = -40 to +85°C) 1.51 ±0.06 V (T_A = -40 to +105°C) • Power-down-reset: 1.50 ±0.04 V (T_A = -40 to +85°C) 1.50 ±0.06 V (T_A = -40 to +105°C) | | | |
| Voltage detector | 1.63 V to 4.06 V (14 stages) | | | |
| On-chip debug function | Provided | | | |
| Power supply voltage | V _{DD} = 1.6 to 5.5 V (T _A = -40 to +85°C) V _{DD} = 2.4 to 5.5 V (T _A = -40 to +105°C) | | | |
| Operating ambient temperature | T _A = -40 to +85°C (A: Consumer applications, D: Industrial applications), T _A = -40 to +105°C (G: Industrial applications) | | | |

Note The illegal instruction is generated when instruction code FFH is executed.
Reset by the illegal instruction execution is not issued by emulation with the in-circuit emulator or on-chip debug emulator.

[48-pin, 64-pin products (code flash memory 384 KB to 512 KB)]

Caution This outline describes the functions at the time when Peripheral I/O redirection register 0, 1 (PIOR0, 1) are set to 00H.

(1/2)

| Item | | 48-pin | 64-pin |
|------------------------------------|--|--|------------------------|
| | | R5F104Gx (x = K, L) | R5F104Lx (x = K, L) |
| Code flash memory (KB) | | 384 to 512 | 384 to 512 |
| Data flash memory (KB) | | 8 | 8 |
| RAM (KB) | | 32 to 48 Note | 32 to 48 Note |
| Address space | | 1 MB | |
| Main system clock | High-speed system clock | X1 (crystal/ceramic) oscillation, external main system clock input (EXCLK) HS (high-speed main) mode: 1 to 20 MHz (V _{DD} = 2.7 to 5.5 V), HS (high-speed main) mode: 1 to 16 MHz (V _{DD} = 2.4 to 5.5 V), LS (low-speed main) mode: 1 to 8 MHz (V _{DD} = 1.8 to 5.5 V), LV (low-voltage main) mode: 1 to 4 MHz (V _{DD} = 1.6 to 5.5 V) | |
| | High-speed on-chip oscillator clock (f _{IH}) | HS (high-speed main) mode: 1 to 32 MHz (V _{DD} = 2.7 to 5.5 V), HS (high-speed main) mode: 1 to 16 MHz (V _{DD} = 2.4 to 5.5 V), LS (low-speed main) mode: 1 to 8 MHz (V _{DD} = 1.8 to 5.5 V), LV (low-voltage main) mode: 1 to 4 MHz (V _{DD} = 1.6 to 5.5 V) | |
| Subsystem clock | | XT1 (crystal) oscillation, external subsystem clock input (EXCLKS) 32.768 kHz | |
| Low-speed on-chip oscillator clock | | 15 kHz (TYP.): V _{DD} = 1.6 to 5.5 V | |
| General-purpose register | | 8 bits × 32 registers (8 bits × 8 registers × 4 banks) | |
| Minimum instruction execution time | | 0.03125 μs (High-speed on-chip oscillator clock: f _{IH} = 32 MHz operation) | |
| | | 0.05 μs (High-speed system clock: f _{MX} = 20 MHz operation) | |
| | | 30.5 μs (Subsystem clock: f _{SUB} = 32.768 kHz operation) | |
| Instruction set | | <ul style="list-style-type: none"> • Data transfer (8/16 bits) • Adder and subtractor/logical operation (8/16 bits) • Multiplication (8 bits × 8 bits, 16 bits × 16 bits), Division (16 bits ÷ 16 bits, 32 bits ÷ 32 bits) • Multiplication and Accumulation (16 bits × 16 bits + 32 bits) • Rotate, barrel shift, and bit manipulation (Set, reset, test, and Boolean operation), etc. | |
| I/O port | Total | 44 | 58 |
| | CMOS I/O | 34 | 48 |
| | CMOS input | 5 | 5 |
| | CMOS output | 1 | 1 |
| | N-ch open-drain I/O (6 V tolerance) | 4 | 4 |
| Timer | 16-bit timer | 8 channels (TAU: 4 channels, Timer RJ: 1 channel, Timer RD: 2 channels, Timer RG: 1 channel) | |
| | Watchdog timer | 1 channel | |
| | Real-time clock (RTC) | 1 channel | |
| | 12-bit interval timer | 1 channel | |
| | Timer output | Timer outputs: 14 channels PWM outputs: 9 channels | |
| | RTC output | 1 • 1 Hz (subsystem clock: f _{SUB} = 32.768 kHz) | |

(Note is listed on the next page.)

Note The flash library uses RAM in self-programming and rewriting of the data flash memory.
The target products and start address of the RAM areas used by the flash library are shown below.
R5F104xL (x = G, L, M, P): Start address F3F00H
For the RAM areas used by the flash library, see **Self RAM list of Flash Self-Programming Library for RL78 Family (R20UT2944)**.

(2/2)

| Item | 48-pin | | 64-pin | |
|-----------------------------------|--|-----------|------------------------|--|
| | R5F104Gx (x = K, L) | | R5F104Lx (x = K, L) | |
| Clock output/buzzer output | 2 | | 2 | |
| | <ul style="list-style-type: none"> • 2.44 kHz, 4.88 kHz, 9.76 kHz, 1.25 MHz, 2.5 MHz, 5 MHz, 10 MHz (Main system clock: $f_{MAIN} = 20$ MHz operation) • 256 Hz, 512 Hz, 1.024 kHz, 2.048 kHz, 4.096 kHz, 8.192 kHz, 16.384 kHz, 32.768 kHz (Subsystem clock: $f_{SUB} = 32.768$ kHz operation) | | | |
| 8/10-bit resolution A/D converter | 10 channels | | 12 channels | |
| D/A converter | 2 channels | | | |
| Comparator | 2 channels | | | |
| Serial interface | [48-pin products] | | | |
| | <ul style="list-style-type: none"> • CSI: 2 channels/UART (UART supporting LIN-bus): 1 channel/simplified I²C: 2 channels • CSI: 1 channel/UART: 1 channel/simplified I²C: 1 channel • CSI: 2 channels/UART: 1 channel/simplified I²C: 2 channels | | | |
| Serial interface | [64-pin products] | | | |
| | <ul style="list-style-type: none"> • CSI: 2 channels/UART (UART supporting LIN-bus): 1 channel/simplified I²C: 2 channels • CSI: 2 channels/UART: 1 channel/simplified I²C: 2 channels • CSI: 2 channels/UART: 1 channel/simplified I²C: 2 channels | | | |
| | I ² C bus | 1 channel | 1 channel | |
| Data transfer controller (DTC) | 32 sources | | 33 sources | |
| Event link controller (ELC) | Event input: 22 Event trigger output: 9 | | | |
| Vectored interrupt sources | Internal | 24 | 24 | |
| | External | 10 | 13 | |
| Key interrupt | 6 | | 8 | |
| Reset | <ul style="list-style-type: none"> • Reset by \overline{RESET} pin • Internal reset by watchdog timer • Internal reset by power-on-reset • Internal reset by voltage detector • Internal reset by illegal instruction execution ^{Note} • Internal reset by RAM parity error • Internal reset by illegal-memory access | | | |
| Power-on-reset circuit | <ul style="list-style-type: none"> • Power-on-reset: 1.51 ±0.04 V ($T_A = -40$ to +85°C) 1.51 ±0.06 V ($T_A = -40$ to +105°C) • Power-down-reset: 1.50 ±0.04 V ($T_A = -40$ to +85°C) 1.50 ±0.06 V ($T_A = -40$ to +105°C) | | | |
| Voltage detector | 1.63 V to 4.06 V (14 stages) | | | |
| On-chip debug function | Provided | | | |
| Power supply voltage | V _{DD} = 1.6 to 5.5 V ($T_A = -40$ to +85°C) V _{DD} = 2.4 to 5.5 V ($T_A = -40$ to +105°C) | | | |
| Operating ambient temperature | T _A = -40 to +85°C (A: Consumer applications, D: Industrial applications), T _A = -40 to +105°C (G: Industrial applications) | | | |

Note The illegal instruction is generated when instruction code FFH is executed.
Reset by the illegal instruction execution is not issued by emulation with the in-circuit emulator or on-chip debug emulator.

[80-pin, 100-pin products (code flash memory 96 KB to 256 KB)]

Caution This outline describes the functions at the time when Peripheral I/O redirection register 0, 1 (PIOR0, 1) are set to 00H.

(1/2)

| Item | | 80-pin | 100-pin |
|------------------------------------|--|--|-----------------------------|
| | | R5F104Mx (x = F to H, J) | R5F104Px (x = F to H, J) |
| Code flash memory (KB) | | 96 to 256 | 96 to 256 |
| Data flash memory (KB) | | 8 | 8 |
| RAM (KB) | | 12 to 24 Note | 12 to 24 Note |
| Address space | | 1 MB | |
| Main system clock | High-speed system clock | X1 (crystal/ceramic) oscillation, external main system clock input (EXCLK) HS (high-speed main) mode: 1 to 20 MHz ($V_{DD} = 2.7$ to 5.5 V), HS (high-speed main) mode: 1 to 16 MHz ($V_{DD} = 2.4$ to 5.5 V), LS (low-speed main) mode: 1 to 8 MHz ($V_{DD} = 1.8$ to 5.5 V), LV (low-voltage main) mode: 1 to 4 MHz ($V_{DD} = 1.6$ to 5.5 V) | |
| | High-speed on-chip oscillator clock (f _{IH}) | HS (high-speed main) mode: 1 to 32 MHz ($V_{DD} = 2.7$ to 5.5 V), HS (high-speed main) mode: 1 to 16 MHz ($V_{DD} = 2.4$ to 5.5 V), LS (low-speed main) mode: 1 to 8 MHz ($V_{DD} = 1.8$ to 5.5 V), LV (low-voltage main) mode: 1 to 4 MHz ($V_{DD} = 1.6$ to 5.5 V) | |
| Subsystem clock | | XT1 (crystal) oscillation, external subsystem clock input (EXCLKS) 32.768 kHz | |
| Low-speed on-chip oscillator clock | | 15 kHz (TYP.): $V_{DD} = 1.6$ to 5.5 V | |
| General-purpose register | | 8 bits × 32 registers (8 bits × 8 registers × 4 banks) | |
| Minimum instruction execution time | | 0.03125 μs (High-speed on-chip oscillator clock: f _{IH} = 32 MHz operation) | |
| | | 0.05 μs (High-speed system clock: f _{MX} = 20 MHz operation) | |
| | | 30.5 μs (Subsystem clock: f _{SUB} = 32.768 kHz operation) | |
| Instruction set | | <ul style="list-style-type: none"> • Data transfer (8/16 bits) • Adder and subtractor/logical operation (8/16 bits) • Multiplication (8 bits × 8 bits, 16 bits × 16 bits), Division (16 bits ÷ 16 bits, 32 bits ÷ 32 bits) • Multiplication and Accumulation (16 bits × 16 bits + 32 bits) • Rotate, barrel shift, and bit manipulation (Set, reset, test, and Boolean operation), etc. | |
| I/O port | Total | 74 | 92 |
| | CMOS I/O | 64 | 82 |
| | CMOS input | 5 | 5 |
| | CMOS output | 1 | 1 |
| | N-ch open-drain I/O (6 V tolerance) | 4 | 4 |
| Timer | 16-bit timer | 12 channels (TAU: 8 channels, Timer RJ: 1 channel, Timer RD: 2 channels, Timer RG: 1 channel) | |
| | Watchdog timer | 1 channel | |
| | Real-time clock (RTC) | 1 channel | |
| | 12-bit interval timer | 1 channel | |
| | Timer output | Timer outputs: 18 channels PWM outputs: 12 channels | |
| | RTC output | 1 • 1 Hz (subsystem clock: f _{SUB} = 32.768 kHz) | |

Note In the case of the 24 KB, this is about 23 KB when the self-programming function and data flash function are used (For details, see **CHAPTER 3** in the RL78/G14 User's Manual).

(2/2)

| Item | 80-pin | | 100-pin | |
|-----------------------------------|---|------------|-----------------------------|--|
| | R5F104Mx (x = F to H, J) | | R5F104Px (x = F to H, J) | |
| Clock output/buzzer output | 2 | | 2 | |
| | <ul style="list-style-type: none"> • 2.44 kHz, 4.88 kHz, 9.76 kHz, 1.25 MHz, 2.5 MHz, 5 MHz, 10 MHz (Main system clock: f_{MAIN} = 20 MHz operation) • 256 Hz, 512 Hz, 1.024 kHz, 2.048 kHz, 4.096 kHz, 8.192 kHz, 16.384 kHz, 32.768 kHz (Subsystem clock: f_{SUB} = 32.768 kHz operation) | | | |
| 8/10-bit resolution A/D converter | 17 channels | | 20 channels | |
| D/A converter | 2 channels | | 2 channels | |
| Comparator | 2 channels | | 2 channels | |
| Serial interface | [80-pin, 100-pin products] | | | |
| | <ul style="list-style-type: none"> • CSI: 2 channels/UART (UART supporting LIN-bus): 1 channel/simplified I²C: 2 channels • CSI: 2 channels/UART: 1 channel/simplified I²C: 2 channels • CSI: 2 channels/UART: 1 channel/simplified I²C: 2 channels • CSI: 2 channels/UART: 1 channel/simplified I²C: 2 channels | | | |
| | I ² C bus | 2 channels | 2 channels | |
| Data transfer controller (DTC) | 39 sources | | 39 sources | |
| Event link controller (ELC) | Event input: 26 Event trigger output: 9 | | | |
| Vectored interrupt sources | Internal | 32 | 32 | |
| | External | 13 | 13 | |
| Key interrupt | 8 | | 8 | |
| Reset | <ul style="list-style-type: none"> • Reset by $\overline{\text{RESET}}$ pin • Internal reset by watchdog timer • Internal reset by power-on-reset • Internal reset by voltage detector • Internal reset by illegal instruction execution ^{Note} • Internal reset by RAM parity error • Internal reset by illegal-memory access | | | |
| Power-on-reset circuit | <ul style="list-style-type: none"> • Power-on-reset: 1.51 ±0.04 V (T_A = -40 to +85°C) 1.51 ±0.06 V (T_A = -40 to +105°C) • Power-down-reset: 1.50 ±0.04 V (T_A = -40 to +85°C) 1.50 ±0.06 V (T_A = -40 to +105°C) | | | |
| Voltage detector | 1.63 V to 4.06 V (14 stages) | | | |
| On-chip debug function | Provided | | | |
| Power supply voltage | V _{DD} = 1.6 to 5.5 V (T _A = -40 to +85°C) V _{DD} = 2.4 to 5.5 V (T _A = -40 to +105°C) | | | |
| Operating ambient temperature | T _A = -40 to +85°C (A: Consumer applications, D: Industrial applications), T _A = -40 to +105°C (G: Industrial applications) | | | |

Note The illegal instruction is generated when instruction code FFH is executed.
Reset by the illegal instruction execution is not issued by emulation with the in-circuit emulator or on-chip debug emulator.

[80-pin, 100-pin products (code flash memory 384 KB to 512 KB)]

Caution This outline describes the functions at the time when Peripheral I/O redirection register 0, 1 (PIOR0, 1) are set to 00H.

(1/2)

| Item | | 80-pin | 100-pin |
|------------------------------------|--|--|------------------------|
| | | R5F104Mx (x = K, L) | R5F104Px (x = K, L) |
| Code flash memory (KB) | | 384 to 512 | 384 to 512 |
| Data flash memory (KB) | | 8 | 8 |
| RAM (KB) | | 32 to 48 Note | 32 to 48 Note |
| Address space | | 1 MB | |
| Main system clock | High-speed system clock | X1 (crystal/ceramic) oscillation, external main system clock input (EXCLK) HS (high-speed main) mode: 1 to 20 MHz (V _{DD} = 2.7 to 5.5 V), HS (high-speed main) mode: 1 to 16 MHz (V _{DD} = 2.4 to 5.5 V), LS (low-speed main) mode: 1 to 8 MHz (V _{DD} = 1.8 to 5.5 V), LV (low-voltage main) mode: 1 to 4 MHz (V _{DD} = 1.6 to 5.5 V) | |
| | High-speed on-chip oscillator clock (f _{IH}) | HS (high-speed main) mode: 1 to 32 MHz (V _{DD} = 2.7 to 5.5 V), HS (high-speed main) mode: 1 to 16 MHz (V _{DD} = 2.4 to 5.5 V), LS (low-speed main) mode: 1 to 8 MHz (V _{DD} = 1.8 to 5.5 V), LV (low-voltage main) mode: 1 to 4 MHz (V _{DD} = 1.6 to 5.5 V) | |
| Subsystem clock | | XT1 (crystal) oscillation, external subsystem clock input (EXCLKS) 32.768 kHz | |
| Low-speed on-chip oscillator clock | | 15 kHz (TYP.): V _{DD} = 1.6 to 5.5 V | |
| General-purpose register | | 8 bits × 32 registers (8 bits × 8 registers × 4 banks) | |
| Minimum instruction execution time | | 0.03125 μs (High-speed on-chip oscillator clock: f _{IH} = 32 MHz operation) | |
| | | 0.05 μs (High-speed system clock: f _{MX} = 20 MHz operation) | |
| | | 30.5 μs (Subsystem clock: f _{SUB} = 32.768 kHz operation) | |
| Instruction set | | <ul style="list-style-type: none"> • Data transfer (8/16 bits) • Adder and subtractor/logical operation (8/16 bits) • Multiplication (8 bits × 8 bits, 16 bits × 16 bits), Division (16 bits ÷ 16 bits, 32 bits ÷ 32 bits) • Multiplication and Accumulation (16 bits × 16 bits + 32 bits) • Rotate, barrel shift, and bit manipulation (Set, reset, test, and Boolean operation), etc. | |
| I/O port | Total | 74 | 92 |
| | CMOS I/O | 64 | 82 |
| | CMOS input | 5 | 5 |
| | CMOS output | 1 | 1 |
| | N-ch open-drain I/O (6 V tolerance) | 4 | 4 |
| Timer | 16-bit timer | 12 channels (TAU: 8 channels, Timer RJ: 1 channel, Timer RD: 2 channels, Timer RG: 1 channel) | |
| | Watchdog timer | 1 channel | |
| | Real-time clock (RTC) | 1 channel | |
| | 12-bit interval timer | 1 channel | |
| | Timer output | Timer outputs: 18 channels PWM outputs: 12 channels | |
| | RTC output | 1 • 1 Hz (subsystem clock: f _{SUB} = 32.768 kHz) | |

Note In the case of the 48 KB, this is about 47 KB when the self-programming function and data flash function are used (For details, see **CHAPTER 3** in the RL78/G14 User's Manual).

(2/2)

| Item | 80-pin | | 100-pin | |
|-----------------------------------|---|------------|------------------------|--|
| | R5F104Mx (x = K, L) | | R5F104Px (x = K, L) | |
| Clock output/buzzer output | 2 | | 2 | |
| | <ul style="list-style-type: none"> • 2.44 kHz, 4.88 kHz, 9.76 kHz, 1.25 MHz, 2.5 MHz, 5 MHz, 10 MHz (Main system clock: f_{MAIN} = 20 MHz operation) • 256 Hz, 512 Hz, 1.024 kHz, 2.048 kHz, 4.096 kHz, 8.192 kHz, 16.384 kHz, 32.768 kHz (Subsystem clock: f_{SUB} = 32.768 kHz operation) | | | |
| 8/10-bit resolution A/D converter | 17 channels | | 20 channels | |
| D/A converter | 2 channels | | 2 channels | |
| Comparator | 2 channels | | 2 channels | |
| Serial interface | [80-pin, 100-pin products] | | | |
| | <ul style="list-style-type: none"> • CSI: 2 channels/UART (UART supporting LIN-bus): 1 channel/simplified I²C: 2 channels • CSI: 2 channels/UART: 1 channel/simplified I²C: 2 channels • CSI: 2 channels/UART: 1 channel/simplified I²C: 2 channels • CSI: 2 channels/UART: 1 channel/simplified I²C: 2 channels | | | |
| | I ² C bus | 2 channels | 2 channels | |
| Data transfer controller (DTC) | 39 sources | | 39 sources | |
| Event link controller (ELC) | Event input: 26 Event trigger output: 9 | | | |
| Vectored interrupt sources | Internal | 32 | 32 | |
| | External | 13 | 13 | |
| Key interrupt | 8 | | 8 | |
| Reset | <ul style="list-style-type: none"> • Reset by $\overline{\text{RESET}}$ pin • Internal reset by watchdog timer • Internal reset by power-on-reset • Internal reset by voltage detector • Internal reset by illegal instruction execution ^{Note} • Internal reset by RAM parity error • Internal reset by illegal-memory access | | | |
| Power-on-reset circuit | <ul style="list-style-type: none"> • Power-on-reset: 1.51 ±0.04 V (T_A = -40 to +85°C) 1.51 ±0.06 V (T_A = -40 to +105°C) • Power-down-reset: 1.50 ±0.04 V (T_A = -40 to +85°C) 1.50 ±0.06 V (T_A = -40 to +105°C) | | | |
| Voltage detector | 1.63 V to 4.06 V (14 stages) | | | |
| On-chip debug function | Provided | | | |
| Power supply voltage | V _{DD} = 1.6 to 5.5 V (T _A = -40 to +85°C) V _{DD} = 2.4 to 5.5 V (T _A = -40 to +105°C) | | | |
| Operating ambient temperature | T _A = -40 to +85°C (A: Consumer applications, D: Industrial applications), T _A = -40 to +105°C (G: Industrial applications) | | | |

Note The illegal instruction is generated when instruction code FFH is executed.
Reset by the illegal instruction execution is not issued by emulation with the in-circuit emulator or on-chip debug emulator.

2. ELECTRICAL SPECIFICATIONS (TA = -40 to +85°C)

This chapter describes the following electrical specifications.

Target products A: Consumer applications TA = -40 to +85°C

R5F104xxAxx

D: Industrial applications TA = -40 to +85°C

R5F104xxDxx

G: Industrial applications when TA = -40 to +105°C products is used in the range of TA = -40 to +85°C

R5F104xxGxx

Caution 1. The RL78 microcontrollers have an on-chip debug function, which is provided for development and evaluation. Do not use the on-chip debug function in products designated for mass production, because the guaranteed number of rewritable times of the flash memory may be exceeded when this function is used, and product reliability therefore cannot be guaranteed. Renesas Electronics is not liable for problems occurring when the on-chip debug function is used.

Caution 2. With products not provided with an EVDD0, EVDD1, EVSS0, or EVSS1 pin, replace EVDD0 and EVDD1 with VDD, or replace EVSS0 and EVSS1 with Vss.

Caution 3. The pins mounted depend on the product. Refer to 2.1 Port Functions to 2.2.1 Functions for each product in the RL78/G14 User's Manual.

2.1 Absolute Maximum Ratings

Absolute Maximum Ratings

(1/2)

| Parameter | Symbols | Conditions | Ratings | Unit |
|------------------------|---------------------------------------|---|---|------|
| Supply voltage | V _{DD} | | -0.5 to +6.5 | V |
| | EV _{DD0} , EV _{DD1} | EV _{DD0} = EV _{DD1} | -0.5 to +6.5 | V |
| | EV _{SS0} , EV _{SS1} | EV _{SS0} = EV _{SS1} | -0.5 to +0.3 | V |
| REGC pin input voltage | V _{IREGC} | REGC | -0.3 to +2.8 and -0.3 to V _{DD} +0.3 Note 1 | V |
| Input voltage | V _{I1} | P00 to P06, P10 to P17, P30, P31, P40 to P47, P50 to P57, P64 to P67, P70 to P77, P80 to P87, P100 to P102, P110, P111, P120, P140 to P147 | -0.3 to EV _{DD0} +0.3 and -0.3 to V _{DD} +0.3 Note 2 | V |
| | V _{I2} | P60 to P63 (N-ch open-drain) | -0.3 to +6.5 | V |
| | V _{I3} | P20 to P27, P121 to P124, P137, P150 to P156, EXCLK, EXCLKS, $\overline{\text{RESET}}$ | -0.3 to V _{DD} +0.3 Note 2 | V |
| Output voltage | V _{O1} | P00 to P06, P10 to P17, P30, P31, P40 to P47, P50 to P57, P60 to P67, P70 to P77, P80 to P87, P100 to P102, P110, P111, P120, P130, P140 to P147 | -0.3 to EV _{DD0} +0.3 and -0.3 to V _{DD} +0.3 Note 2 | V |
| | V _{O2} | P20 to P27, P150 to P156 | -0.3 to V _{DD} +0.3 Note 2 | V |
| Analog input voltage | V _{AI1} | ANI16 to ANI20 | -0.3 to EV _{DD0} +0.3 and -0.3 to AV _{REF} (+) +0.3 Notes 2, 3 | V |
| | V _{AI2} | ANI0 to ANI14 | -0.3 to V _{DD} +0.3 and -0.3 to AV _{REF} (+) +0.3 Notes 2, 3 | V |

Note 1. Connect the REGC pin to V_{SS} via a capacitor (0.47 to 1 μF). This value regulates the absolute maximum rating of the REGC pin. Do not use this pin with voltage applied to it.

Note 2. Must be 6.5 V or lower.

Note 3. Do not exceed AV_{REF} (+) + 0.3 V in case of A/D conversion target pin.

Caution Product quality may suffer if the absolute maximum rating is exceeded even momentarily for any parameter. That is, the absolute maximum ratings are rated values at which the product is on the verge of suffering physical damage, and therefore the product must be used under conditions that ensure that the absolute maximum ratings are not exceeded.

Remark 1. Unless specified otherwise, the characteristics of alternate-function pins are the same as those of the port pins.

Remark 2. AV_{REF} (+): + side reference voltage of the A/D converter.

Remark 3. V_{SS}: Reference voltage

Absolute Maximum Ratings**(2/2)**

| Parameter | Symbols | Conditions | | Ratings | Unit |
|-------------------------------|----------------------------------|------------------------------|--|--|------------|
| Output current, high | IOH1 | Per pin | P00 to P06, P10 to P17, P30, P31, P40 to P47, P50 to P57, P64 to P67, P70 to P77, P80 to P87, P100 to P102, P110, P111, P120, P130, P140 to P147 | -40 | mA |
| | | Total of all pins -170 mA | P00 to P04, P40 to P47, P102, P120, P130, P140 to P145 | -70 | mA |
| | | | P05, P06, P10 to P17, P30, P31, P50 to P57, P64 to P67, P70 to P77, P80 to P87, P100, P101, P110, P111, P146, P147 | -100 | mA |
| | IOH2 | Per pin | P20 to P27, P150 to P156 | -0.5 | mA |
| | | Total of all pins | | -2 | mA |
| | Output current, low | IOL1 | Per pin | P00 to P06, P10 to P17, P30, P31, P40 to P47, P50 to P57, P64 to P67, P70 to P77, P80 to P87, P100 to P102, P110, P111, P120, P130, P140 to P147 | 40 |
| Total of all pins 170 mA | | | P00 to P04, P40 to P47, P102, P120, P130, P140 to P145 | 70 | mA |
| | | | P05, P06, P10 to P17, P30, P31, P50 to P57, P60 to P67, P70 to P77, P80 to P87, P100, P101, P110, P111, P146, P147 | 100 | mA |
| IOL2 | | Per pin | P20 to P27, P150 to P156 | 1 | mA |
| | | Total of all pins | | 5 | mA |
| Operating ambient temperature | | TA | In normal operation mode | | -40 to +85 |
| | In flash memory programming mode | | | | |
| Storage temperature | Tstg | | | -65 to +150 | °C |

Caution Product quality may suffer if the absolute maximum rating is exceeded even momentarily for any parameter. That is, the absolute maximum ratings are rated values at which the product is on the verge of suffering physical damage, and therefore the product must be used under conditions that ensure that the absolute maximum ratings are not exceeded.

Remark Unless specified otherwise, the characteristics of alternate-function pins are the same as those of the port pins.

2.2 Oscillator Characteristics

2.2.1 X1, XT1 characteristics

(TA = -40 to +85°C, 1.6 V ≤ VDD ≤ 5.5 V, VSS = 0 V)

| Resonator | Resonator | Conditions | MIN. | TYP. | MAX. | Unit |
|---|---|---------------------|------|--------|------|------|
| X1 clock oscillation frequency (fx) ^{Note} | Ceramic resonator/ crystal resonator | 2.7 V ≤ VDD ≤ 5.5 V | 1.0 | | 20.0 | MHz |
| | | 2.4 V ≤ VDD < 2.7 V | 1.0 | | 16.0 | |
| | | 1.8 V ≤ VDD < 2.4 V | 1.0 | | 8.0 | |
| | | 1.6 V ≤ VDD < 1.8 V | 1.0 | | 4.0 | |
| XT1 clock oscillation frequency (fxT) ^{Note} | Crystal resonator | | 32 | 32.768 | 35 | kHz |

Note Indicates only permissible oscillator frequency ranges. Refer to **AC Characteristics** for instruction execution time. Request evaluation by the manufacturer of the oscillator circuit mounted on a board to check the oscillator characteristics.

Caution Since the CPU is started by the high-speed on-chip oscillator clock after a reset release, check the X1 clock oscillation stabilization time using the oscillation stabilization time counter status register (OSTC) by the user. Determine the oscillation stabilization time of the OSTC register and the oscillation stabilization time select register (OSTS) after sufficiently evaluating the oscillation stabilization time with the resonator to be used.

Remark When using the X1 oscillator and XT1 oscillator, refer to **5.4 System Clock Oscillator** in the RL78/G14 User's Manual.

2.2.2 On-chip oscillator characteristics

(TA = -40 to +85°C, 1.6 V ≤ VDD ≤ 5.5 V, VSS = 0 V)

| Oscillators | Parameters | Conditions | | MIN. | TYP. | MAX. | Unit |
|---|-----------------|--------------|---------------------|------|------|------|------|
| High-speed on-chip oscillator clock frequency Notes 1, 2 | f _{IH} | | | 1 | | 32 | MHz |
| High-speed on-chip oscillator clock frequency accuracy | | -20 to +85°C | 1.8 V ≤ VDD ≤ 5.5 V | -1.0 | | +1.0 | % |
| | | | 1.6 V ≤ VDD < 1.8 V | -5.0 | | +5.0 | % |
| | | -40 to -20°C | 1.8 V ≤ VDD < 5.5 V | -1.5 | | +1.5 | % |
| | | | 1.6 V ≤ VDD < 1.8 V | -5.5 | | +5.5 | % |
| Low-speed on-chip oscillator clock frequency | f _{IL} | | | | 15 | | kHz |
| Low-speed on-chip oscillator clock frequency accuracy | | | | -15 | | +15 | % |

Note 1. High-speed on-chip oscillator frequency is selected with bits 0 to 4 of the option byte (000C2H) and bits 0 to 2 of the HOCODIV register.

Note 2. This only indicates the oscillator characteristics. Refer to **AC Characteristics** for instruction execution time.

2.3 DC Characteristics

2.3.1 Pin characteristics

(TA = -40 to +85°C, 1.6 V ≤ EVDD0 = EVDD1 ≤ VDD ≤ 5.5 V, VSS = EVSS0 = EVSS1 = 0 V)

(1/5)

| Items | Symbol | Conditions | MIN. | TYP. | MAX. | Unit | |
|---|---|---|-----------------------|------|------------------|-----------------|----|
| Output current, high ^{Note 1} | IOH1 | Per pin for P00 to P06, P10 to P17, P30, P31, P40 to P47, P50 to P57, P64 to P67, P70 to P77, P80 to P87, P100 to P102, P110, P111, P120, P130, P140 to P147 | 1.6 V ≤ EVDD0 ≤ 5.5 V | | | -10.0 Note 2 | mA |
| | | Total of P00 to P04, P40 to P47, P102, P120, P130, P140 to P145 (When duty ≤ 70% ^{Note 3}) | 4.0 V ≤ EVDD0 ≤ 5.5 V | | | -55.0 | mA |
| | | | 2.7 V ≤ EVDD0 < 4.0 V | | | -10.0 | mA |
| | | | 1.8 V ≤ EVDD0 < 2.7 V | | | -5.0 | mA |
| | | | 1.6 V ≤ EVDD0 < 1.8 V | | | -2.5 | mA |
| | | Total of P05, P06, P10 to P17, P30, P31, P50 to P57, P64 to P67, P70 to P77, P80 to P87, P100, P101, P110, P111, P146, P147 (When duty ≤ 70% ^{Note 3}) | 4.0 V ≤ EVDD0 ≤ 5.5 V | | | -80.0 | mA |
| | 2.7 V ≤ EVDD0 < 4.0 V | | | | -19.0 | mA | |
| | 1.8 V ≤ EVDD0 < 2.7 V | | | | -10.0 | mA | |
| | 1.6 V ≤ EVDD0 < 1.8 V | | | | -5.0 | mA | |
| | Total of all pins (When duty ≤ 70% ^{Note 3}) | 1.6 V ≤ EVDD0 ≤ 5.5 V | | | -135.0 Note 4 | mA | |
| | IOH2 | Per pin for P20 to P27, P150 to P156 | 1.6 V ≤ VDD ≤ 5.5 V | | | -0.1 Note 2 | mA |
| Total of all pins (When duty ≤ 70% ^{Note 3}) | | 1.6 V ≤ VDD ≤ 5.5 V | | | -1.5 | mA | |

Note 1. Value of current at which the device operation is guaranteed even if the current flows from the EVDD0, EVDD1, VDD pins to an output pin.

Note 2. Do not exceed the total current value.

Note 3. Specification under conditions where the duty factor ≤ 70%.

The output current value that has changed to the duty factor > 70% the duty ratio can be calculated with the following expression (when changing the duty factor from 70% to n%).

- Total output current of pins = (IOH × 0.7)/(n × 0.01)
<Example> Where n = 80% and IOH = -10.0 mA
Total output current of pins = (-10.0 × 0.7)/(80 × 0.01) ≈ -8.7 mA

However, the current that is allowed to flow into one pin does not vary depending on the duty factor.

A current higher than the absolute maximum rating must not flow into one pin.

Note 4. -100 mA for industrial applications (R5F104xxDxx, R5F104xxGxx).

Caution P00, P02 to P04, P10, P11, P13 to P15, P17, P30, P43 to P45, P50 to P55, P71, P74, P80 to P82, and P142 to P144 do not output high level in N-ch open-drain mode.

Remark Unless specified otherwise, the characteristics of alternate-function pins are the same as those of the port pins.

(TA = -40 to +85°C, 1.6 V ≤ EVDD0 = EVDD1 ≤ VDD ≤ 5.5 V, VSS = EVSS0 = EVSS1 = 0 V)

(2/5)

| Items | Symbol | Conditions | MIN. | TYP. | MAX. | Unit | |
|---|---|---|--|-----------------------|----------------|------|----|
| Output current, low ^{Note 1} | IOL1 | Per pin for P00 to P06, P10 to P17, P30, P31, P40 to P47, P50 to P57, P64 to P67, P70 to P77, P80 to P87, P100 to P102, P110, P111, P120, P130, P140 to P147 | | | 20.0 Note 2 | mA | |
| | | | | | 15.0 Note 2 | mA | |
| | | | Total of P00 to P04, P40 to P47, P102, P120, P130, P140 to P145 (When duty ≤ 70% ^{Note 3}) | 4.0 V ≤ EVDD0 ≤ 5.5 V | | 70.0 | mA |
| | | | | 2.7 V ≤ EVDD0 < 4.0 V | | 15.0 | mA |
| | | 1.8 V ≤ EVDD0 < 2.7 V | | | 9.0 | mA | |
| | | 1.6 V ≤ EVDD0 < 1.8 V | | | 4.5 | mA | |
| | | Total of P05, P06, P10 to P17, P30, P31, P50 to P57, P60 to P67, P70 to P77, P80 to P87, P100, P101, P110, P111, P146, P147 (When duty ≤ 70% ^{Note 3}) | 4.0 V ≤ EVDD0 ≤ 5.5 V | | 80.0 | mA | |
| | | | 2.7 V ≤ EVDD0 < 4.0 V | | 35.0 | mA | |
| | | | 1.8 V ≤ EVDD0 < 2.7 V | | 20.0 | mA | |
| | | | 1.6 V ≤ EVDD0 < 1.8 V | | 10.0 | mA | |
| | Total of all pins (When duty ≤ 70% ^{Note 3}) | | | 150.0 | mA | | |
| | IOL2 | Per pin for P20 to P27, P150 to P156 | | | 0.4 Note 2 | mA | |
| | | | 1.6 V ≤ VDD ≤ 5.5 V | | 5.0 | mA | |
| Total of all pins (When duty ≤ 70% ^{Note 3}) | | | | | | | |

Note 1. Value of current at which the device operation is guaranteed even if the current flows from an output pin to the EVSS0, EVSS1, and VSS pins.

Note 2. Do not exceed the total current value.

Note 3. Specification under conditions where the duty factor ≤ 70%.

The output current value that has changed to the duty factor > 70% the duty ratio can be calculated with the following expression (when changing the duty factor from 70% to n%).

- Total output current of pins = (IOL × 0.7)/(n × 0.01)

<Example> Where n = 80% and IOL = 10.0 mA

$$\text{Total output current of pins} = (10.0 \times 0.7)/(80 \times 0.01) \approx 8.7 \text{ mA}$$

However, the current that is allowed to flow into one pin does not vary depending on the duty factor.

A current higher than the absolute maximum rating must not flow into one pin.

Remark Unless specified otherwise, the characteristics of alternate-function pins are the same as those of the port pins.

(TA = -40 to +85°C, 1.6 V ≤ EVDD0 = EVDD1 ≤ VDD ≤ 5.5 V, VSS = EVSS0 = EVSS1 = 0 V)

(3/5)

| Items | Symbol | Conditions | MIN. | TYP. | MAX. | Unit | |
|---------------------|--|--|---|-----------|---------|-----------|---|
| Input voltage, high | V _{IH1} | P00 to P06, P10 to P17, P30, P31, P40 to P47, P50 to P57, P64 to P67, P70 to P77, P80 to P87, P100 to P102, P110, P111, P120, P140 to P147 | Normal input buffer | 0.8 EVDD0 | | EVDD0 | V |
| | V _{IH2} | P01, P03, P04, P10, P14 to P17, P30, P43, P44, P50, P53 to P55, P80, P81, P142, P143 | TTL input buffer 4.0 V ≤ EVDD0 ≤ 5.5 V | 2.2 | | EVDD0 | V |
| | | | TTL input buffer 3.3 V ≤ EVDD0 < 4.0 V | 2.0 | | EVDD0 | V |
| | | | TTL input buffer 1.6 V ≤ EVDD0 < 3.3 V | 1.5 | | EVDD0 | V |
| | V _{IH3} | P20 to P27, P150 to P156 | | 0.7 VDD | | VDD | V |
| | V _{IH4} | P60 to P63 | | 0.7 EVDD0 | | 6.0 | V |
| V _{IH5} | P121 to P124, P137, EXCLK, EXCLKS, RESET | | 0.8 VDD | | VDD | V | |
| Input voltage, low | V _{IL1} | P00 to P06, P10 to P17, P30, P31, P40 to P47, P50 to P57, P64 to P67, P70 to P77, P80 to P87, P100 to P102, P110, P111, P120, P140 to P147 | Normal input buffer | 0 | | 0.2 EVDD0 | V |
| | V _{IL2} | P01, P03, P04, P10, P14 to P17, P30, P43, P44, P50, P53 to P55, P80, P81, P142, P143 | TTL input buffer 4.0 V ≤ EVDD0 ≤ 5.5 V | 0 | | 0.8 | V |
| | | | TTL input buffer 3.3 V ≤ EVDD0 < 4.0 V | 0 | | 0.5 | V |
| | | | TTL input buffer 1.6 V ≤ EVDD0 < 3.3 V | 0 | | 0.32 | V |
| | V _{IL3} | P20 to P27, P150 to P156 | | 0 | | 0.3 VDD | V |
| | V _{IL4} | P60 to P63 | | 0 | | 0.3 EVDD0 | V |
| V _{IL5} | P121 to P124, P137, EXCLK, EXCLKS, RESET | | 0 | | 0.2 VDD | V | |

Caution The maximum value of V_{IH} of pins P00, P02 to P04, P10, P11, P13 to P15, P17, P30, P43 to P45, P50 to P55, P71, P74, P80 to P82, and P142 to P144 is EVDD0, even in the N-ch open-drain mode.

Remark Unless specified otherwise, the characteristics of alternate-function pins are the same as those of the port pins.

(TA = -40 to +85°C, 1.6 V ≤ EVDD0 = EVDD1 ≤ VDD ≤ 5.5 V, VSS = EVSS0 = EVSS1 = 0 V)

(4/5)

| Items | Symbol | Conditions | MIN. | TYP. | MAX. | Unit |
|----------------------|--------|--|---|-------------|------|------|
| Output voltage, high | VOH1 | P00 to P06, P10 to P17, P30, P31, P40 to P47, P50 to P57, P64 to P67, P70 to P77, P80 to P87, P100 to P102, P110, P111, P120, P130, P140 to P147 | 4.0 V ≤ EVDD0 ≤ 5.5 V, IOH1 = -10.0 mA | EVDD0 - 1.5 | | V |
| | | | 4.0 V ≤ EVDD0 ≤ 5.5 V, IOH1 = -3.0 mA | EVDD0 - 0.7 | | V |
| | | | 1.8 V ≤ EVDD0 ≤ 5.5 V, IOH1 = -1.5 mA | EVDD0 - 0.5 | | V |
| | | | 1.6 V ≤ EVDD0 < 1.8 V, IOH1 = -1.0 mA | EVDD0 - 0.5 | | V |
| | VOH2 | P20 to P27, P150 to P156 | 1.6 V ≤ VDD ≤ 5.5 V, IOH2 = -100 μA | VDD - 0.5 | | V |
| Output voltage, low | VOL1 | P00 to P06, P10 to P17, P30, P31, P40 to P47, P50 to P57, P64 to P67, P70 to P77, P80 to P87, P100 to P102, P110, P111, P120, P130, P140 to P147 | 4.0 V ≤ EVDD0 ≤ 5.5 V, IOL1 = 20.0 mA | | 1.3 | V |
| | | | 4.0 V ≤ EVDD0 ≤ 5.5 V, IOL1 = 8.5 mA | | 0.7 | V |
| | | | 2.7 V ≤ EVDD0 ≤ 5.5 V, IOL1 = 3.0 mA | | 0.6 | V |
| | | | 2.7 V ≤ EVDD0 ≤ 5.5 V, IOL1 = 1.5 mA | | 0.4 | V |
| | | | 1.8 V ≤ EVDD0 ≤ 5.5 V, IOL1 = 0.6 mA | | 0.4 | V |
| | | | 1.6 V ≤ EVDD0 ≤ 5.5 V, IOL1 = 0.3 mA | | 0.4 | V |
| | VOL2 | P20 to P27, P150 to P156 | 1.6 V ≤ VDD ≤ 5.5 V, IOL2 = 400 μA | | 0.4 | V |
| | VOL3 | P60 to P63 | 4.0 V ≤ EVDD0 ≤ 5.5 V, IOL3 = 15.0 mA | | 2.0 | V |
| | | | 4.0 V ≤ EVDD0 ≤ 5.5 V, IOL3 = 5.0 mA | | 0.4 | V |
| | | | 2.7 V ≤ EVDD0 ≤ 5.5 V, IOL3 = 3.0 mA | | 0.4 | V |
| | | | 1.8 V ≤ EVDD0 ≤ 5.5 V, IOL3 = 2.0 mA | | 0.4 | V |
| | | | 1.6 V ≤ EVDD0 ≤ 5.5 V, IOL3 = 1.0 mA | | 0.4 | V |

Caution P00, P02 to P04, P10, P11, P13 to P15, P17, P30, P43 to P45, P50 to P55, P71, P74, P80 to P82, P142 to P144 do not output high level in N-ch open-drain mode.

Remark Unless specified otherwise, the characteristics of alternate-function pins are the same as those of the port pins.

(TA = -40 to +85°C, 1.6 V ≤ EVDD0 = EVDD1 ≤ VDD ≤ 5.5 V, VSS = EVSS0 = EVSS1 = 0 V)

(5/5)

| Items | Symbol | Conditions | MIN. | TYP. | MAX. | Unit | | |
|-----------------------------|--------|--|---------------------------|------|---------------------------------------|------|-----|----|
| Input leakage current, high | ILIH1 | P00 to P06, P10 to P17, P30, P31, P40 to P47, P50 to P57, P64 to P67, P70 to P77, P80 to P87, P100 to P102, P110, P111, P120, P140 to P147 | Vi = EVDD0 | | | 1 | μA | |
| | ILIH2 | P20 to P27, P137, P150 to P156, RESET | Vi = VDD | | | 1 | μA | |
| | ILIH3 | P121 to P124 (X1, X2, EXCLK, XT1, XT2, EXCLKS) | Vi = VDD | | In input port or external clock input | | 1 | μA |
| | | | | | In resonator connection | | 10 | μA |
| Input leakage current, low | ILIL1 | P00 to P06, P10 to P17, P30, P31, P40 to P47, P50 to P57, P64 to P67, P70 to P77, P80 to P87, P100 to P102, P110, P111, P120, P140 to P147 | Vi = EVSS0 | | | -1 | μA | |
| | ILIL2 | P20 to P27, P137, P150 to P156, RESET | Vi = VSS | | | -1 | μA | |
| | ILIL3 | P121 to P124 (X1, X2, EXCLK, XT1, XT2, EXCLKS) | Vi = VSS | | In input port or external clock input | | -1 | μA |
| | | | | | In resonator connection | | -10 | μA |
| On-chip pull-up resistance | Ru | P00 to P06, P10 to P17, P30, P31, P40 to P47, P50 to P57, P64 to P67, P70 to P77, P80 to P87, P100 to P102, P110, P111, P120, P140 to P147 | Vi = EVSS0, In input port | | 10 | 20 | 100 | kΩ |

Remark Unless specified otherwise, the characteristics of alternate-function pins are the same as those of the port pins.

2.3.2 Supply current characteristics

(1) Flash ROM: 16 to 64 KB of 30- to 64-pin products

(TA = -40 to +85°C, 1.6 V ≤ EVDD0 ≤ VDD ≤ 5.5 V, VSS = EVSS0 = 0 V)

(1/2)

| Parameter | Symbol | Conditions | | | | MIN. | TYP. | MAX. | Unit | | |
|--|--|--|--|--|--|------------------|-------------|------|------|----|-----|
| Supply current Note 1 | IDD1 | Operating mode | HS (high-speed main) mode Note 5 | fHOCO = 64 MHz, fIH = 32 MHz Note 3 | Basic operation | VDD = 5.0 V | | 2.4 | | mA | |
| | | | | | | VDD = 3.0 V | | 2.4 | | | |
| | | | | fHOCO = 32 MHz, fIH = 32 MHz Note 3 | Basic operation | VDD = 5.0 V | | 2.1 | | | |
| | | | | | | VDD = 3.0 V | | 2.1 | | | |
| | | | | HS (high-speed main) mode Note 5 | fHOCO = 64 MHz, fIH = 32 MHz Note 3 | Normal operation | VDD = 5.0 V | | 5.1 | | 8.7 |
| | | | | | | | VDD = 3.0 V | | 5.1 | | 8.7 |
| | | | fHOCO = 32 MHz, fIH = 32 MHz Note 3 | | Normal operation | VDD = 5.0 V | | 4.8 | 8.1 | | |
| | | | | | | VDD = 3.0 V | | 4.8 | 8.1 | | |
| | | | fHOCO = 48 MHz, fIH = 24 MHz Note 3 | | Normal operation | VDD = 5.0 V | | 4.0 | 6.9 | | |
| | | | | | | VDD = 3.0 V | | 4.0 | 6.9 | | |
| | | | fHOCO = 24 MHz, fIH = 24 MHz Note 3 | Normal operation | VDD = 5.0 V | | 3.8 | 6.3 | | | |
| | | | | | VDD = 3.0 V | | 3.8 | 6.3 | | | |
| | | fHOCO = 16 MHz, fIH = 16 MHz Note 3 | Normal operation | VDD = 5.0 V | | 2.8 | 4.6 | | | | |
| | | | | VDD = 3.0 V | | 2.8 | 4.6 | | | | |
| | | LS (low-speed main) mode Note 5 | fHOCO = 8 MHz, fIH = 8 MHz Note 3 | Normal operation | VDD = 3.0 V | | 1.3 | 2.0 | | | |
| | | | | | VDD = 2.0 V | | 1.3 | 2.0 | | | |
| | | LV (low-voltage main) mode Note 5 | fHOCO = 4 MHz, fIH = 4 MHz Note 3 | Normal operation | VDD = 3.0 V | | 1.3 | 1.8 | | | |
| | | | | | VDD = 2.0 V | | 1.3 | 1.8 | | | |
| | | HS (high-speed main) mode Note 5 | fMX = 20 MHz Note 2, VDD = 5.0 V | Normal operation | Square wave input | | 3.3 | 5.3 | | | |
| | | | | | Resonator connection | | 3.4 | 5.5 | | | |
| | | | | Normal operation | Square wave input | | 3.3 | 5.3 | | | |
| | | | | | Resonator connection | | 3.4 | 5.5 | | | |
| | | | fMX = 10 MHz Note 2, VDD = 5.0 V | Normal operation | Square wave input | | 2.0 | 3.1 | | | |
| | | | | | Resonator connection | | 2.1 | 3.2 | | | |
| Normal operation | Square wave input | | | | 2.0 | 3.1 | | | | | |
| | Resonator connection | | | | 2.1 | 3.2 | | | | | |
| LS (low-speed main) mode Note 5 | fMX = 8 MHz Note 2, VDD = 3.0 V | Normal operation | Square wave input | | 1.2 | 1.9 | | | | | |
| | | | Resonator connection | | 1.2 | 2.0 | | | | | |
| | fMX = 8 MHz Note 2, VDD = 2.0 V | Normal operation | Square wave input | | 1.2 | 1.9 | | | | | |
| | | | Resonator connection | | 1.2 | 2.0 | | | | | |
| Subsystem clock operation | fSUB = 32.768 kHz Note 4 TA = -40°C | Normal operation | Square wave input | | 4.7 | 6.1 | | | | | |
| | | | Resonator connection | | 4.7 | 6.1 | | | | | |
| | fSUB = 32.768 kHz Note 4 TA = +25°C | Normal operation | Square wave input | | 4.7 | 6.1 | | | | | |
| | | | Resonator connection | | 4.7 | 6.1 | | | | | |
| | fSUB = 32.768 kHz Note 4 TA = +50°C | Normal operation | Square wave input | | 4.8 | 6.7 | | | | | |
| | | | Resonator connection | | 4.8 | 6.7 | | | | | |
| fSUB = 32.768 kHz Note 4 TA = +70°C | Normal operation | Square wave input | | 4.8 | 7.5 | | | | | | |
| fSUB = 32.768 kHz Note 4 TA = +85°C | | Resonator connection | | 4.8 | 7.5 | | | | | | |
| | fSUB = 32.768 kHz Note 4 TA = +85°C | Normal operation | Square wave input | | 5.4 | 8.9 | | | | | |
| | fSUB = 32.768 kHz Note 4 TA = +85°C | | Resonator connection | | 5.4 | 8.9 | | | | | |

(Notes and Remarks are listed on the next page.)

- Note 1.** Total current flowing into V_{DD} and EV_{DD0}, including the input leakage current flowing when the level of the input pin is fixed to V_{DD}, EV_{DD0} or V_{SS}, EV_{SS0}. The values below the MAX. column include the peripheral operation current. However, not including the current flowing into the A/D converter, LVD circuit, I/O port, and on-chip pull-up/pull-down resistors and the current flowing during data flash rewrite.
- Note 2.** When high-speed on-chip oscillator and subsystem clock are stopped.
- Note 3.** When high-speed system clock and subsystem clock are stopped.
- Note 4.** When high-speed on-chip oscillator and high-speed system clock are stopped. When AMPHS1 = 1 (Ultra-low power consumption oscillation). However, not including the current flowing into the RTC, 12-bit interval timer, and watchdog timer.
- Note 5.** Relationship between operation voltage width, operation frequency of CPU and operation mode is as below.
- | | |
|-----------------------------|---|
| HS (high-speed main) mode: | 2.7 V ≤ V _{DD} ≤ 5.5 V@1 MHz to 32 MHz |
| | 2.4 V ≤ V _{DD} ≤ 5.5 V@1 MHz to 16 MHz |
| LS (low-speed main) mode: | 1.8 V ≤ V _{DD} ≤ 5.5 V@1 MHz to 8 MHz |
| LV (low-voltage main) mode: | 1.6 V ≤ V _{DD} ≤ 5.5 V@1 MHz to 4 MHz |
- Remark 1.** f_{MX}: High-speed system clock frequency (X1 clock oscillation frequency or external main system clock frequency)
- Remark 2.** f_{HOCO}: High-speed on-chip oscillator clock frequency (64 MHz max.)
- Remark 3.** f_{IH}: High-speed on-chip oscillator clock frequency (32 MHz max.)
- Remark 4.** f_{SUB}: Subsystem clock frequency (XT1 clock oscillation frequency)
- Remark 5.** Except subsystem clock operation, temperature condition of the TYP. value is T_A = 25°C

(1) Flash ROM: 16 to 64 KB of 30- to 64-pin products

(TA = -40 to +85°C, 1.6 V ≤ EVDD0 ≤ VDD ≤ 5.5 V, VSS = EVSS0 = 0 V)

(2/2)

| Parameter | Symbol | Conditions | | MIN. | TYP. | MAX. | Unit | |
|---|----------------------------|---------------------|--|---|----------------------|------|------|----|
| Supply current Note 1 | I _{DD2} Note 2 | HALT mode Note 7 | HS (high-speed main) mode Note 7 | fHOCO = 64 MHz, fIH = 32 MHz Note 4 | VDD = 5.0 V | 0.80 | 3.09 | mA |
| | | | | | VDD = 3.0 V | 0.80 | 3.09 | |
| | | | | fHOCO = 32 MHz, fIH = 32 MHz Note 4 | VDD = 5.0 V | 0.49 | 2.40 | |
| | | | | | VDD = 3.0 V | 0.49 | 2.40 | |
| | | | | fHOCO = 48 MHz, fIH = 24 MHz Note 4 | VDD = 5.0 V | 0.62 | 2.40 | |
| | | | | | VDD = 3.0 V | 0.62 | 2.40 | |
| | | | fHOCO = 24 MHz, fIH = 24 MHz Note 4 | VDD = 5.0 V | 0.4 | 1.83 | | |
| | | | | VDD = 3.0 V | 0.4 | 1.83 | | |
| | | | fHOCO = 16 MHz, fIH = 16 MHz Note 4 | VDD = 5.0 V | 0.37 | 1.38 | | |
| | | | | VDD = 3.0 V | 0.37 | 1.38 | | |
| | | | LS (low-speed main) mode Note 7 | fHOCO = 8 MHz, fIH = 8 MHz Note 4 | VDD = 3.0 V | 260 | 710 | μA |
| | | | | | VDD = 2.0 V | 260 | 710 | |
| | | | LV (low-voltage main) mode Note 7 | fHOCO = 4 MHz, fIH = 4 MHz Note 4 | VDD = 3.0 V | 420 | 700 | μA |
| | | | | | VDD = 2.0 V | 420 | 700 | |
| | | | HS (high-speed main) mode Note 7 | fMX = 20 MHz Note 3, VDD = 5.0 V | Square wave input | 0.28 | 1.55 | mA |
| | | | | | Resonator connection | 0.40 | 1.74 | |
| | | | | fMX = 20 MHz Note 3, VDD = 3.0 V | Square wave input | 0.28 | 1.55 | |
| | | | | | Resonator connection | 0.40 | 1.74 | |
| | | | | fMX = 10 MHz Note 3, VDD = 5.0 V | Square wave input | 0.19 | 0.86 | |
| | | | | | Resonator connection | 0.25 | 0.93 | |
| | | | | fMX = 10 MHz Note 3, VDD = 3.0 V | Square wave input | 0.19 | 0.86 | |
| | | | | | Resonator connection | 0.25 | 0.93 | |
| | | | LS (low-speed main) mode Note 7 | fMX = 8 MHz Note 3, VDD = 3.0 V | Square wave input | 95 | 550 | μA |
| | | | | | Resonator connection | 140 | 590 | |
| | | | | fMX = 8 MHz Note 3, VDD = 2.0 V | Square wave input | 95 | 550 | |
| | | | | | Resonator connection | 140 | 590 | |
| | | | Subsystem clock operation | fsUB = 32.768 kHz Note 5, TA = -40°C | Square wave input | 0.25 | 0.57 | μA |
| Resonator connection | 0.44 | 0.76 | | | | | | |
| fsUB = 32.768 kHz Note 5, TA = +25°C | Square wave input | 0.30 | | 0.57 | | | | |
| | Resonator connection | 0.49 | | 0.76 | | | | |
| fsUB = 32.768 kHz Note 5, TA = +50°C | Square wave input | 0.36 | | 1.17 | | | | |
| | Resonator connection | 0.59 | | 1.36 | | | | |
| fsUB = 32.768 kHz Note 5, TA = +70°C | Square wave input | 0.49 | | 1.97 | | | | |
| | Resonator connection | 0.72 | | 2.16 | | | | |
| fsUB = 32.768 kHz Note 5, TA = +85°C | Square wave input | 0.97 | 3.37 | | | | | |
| | Resonator connection | 1.16 | 3.56 | | | | | |
| I _{DD3} Note 6 | STOP mode Note 8 | TA = -40°C | 0.18 | 0.51 | μA | | | |
| | | TA = +25°C | 0.24 | 0.51 | | | | |
| | | TA = +50°C | 0.29 | 1.10 | | | | |
| | | TA = +70°C | 0.41 | 1.90 | | | | |
| | | TA = +85°C | 0.90 | 3.30 | | | | |

(Notes and Remarks are listed on the next page.)

(2) Flash ROM: 96 to 256 KB of 30- to 100-pin products

(TA = -40 to +85°C, 1.6 V ≤ EVDD0 = EVDD1 ≤ VDD ≤ 5.5 V, VSS = EVSS0 = EVSS1 = 0 V)

(1/2)

| Parameter | Symbol | Conditions | | | | MIN. | TYP. | MAX. | Unit | | |
|---|--|---|---|---|---|-------------------------|-------------------------|------|------|----|--|
| Supply current Note 1 | I _{DD1} | Operating mode | HS (high-speed main) mode Note 5 | f _{HOCO} = 64 MHz, f _{IIH} = 32 MHz Note 3 | Basic operation | V _{DD} = 5.0 V | | 2.6 | | mA | |
| | | | | | | V _{DD} = 3.0 V | | 2.6 | | | |
| | | | | | f _{HOCO} = 32 MHz, f _{IIH} = 32 MHz Note 3 | Basic operation | V _{DD} = 5.0 V | | 2.3 | | |
| | | | | | | | V _{DD} = 3.0 V | | 2.3 | | |
| | | | HS (high-speed main) mode Note 5 | f _{HOCO} = 64 MHz, f _{IIH} = 32 MHz Note 3 | Normal operation | V _{DD} = 5.0 V | | 5.4 | 10.2 | mA | |
| | | | | | | V _{DD} = 3.0 V | | 5.4 | 10.2 | | |
| | | f _{HOCO} = 32 MHz, f _{IIH} = 32 MHz Note 3 | | Normal operation | V _{DD} = 5.0 V | | 5.0 | 9.6 | | | |
| | | | | | V _{DD} = 3.0 V | | 5.0 | 9.6 | | | |
| | | f _{HOCO} = 48 MHz, f _{IIH} = 24 MHz Note 3 | | Normal operation | V _{DD} = 5.0 V | | 4.2 | 7.8 | | | |
| | | | | | V _{DD} = 3.0 V | | 4.2 | 7.8 | | | |
| | | f _{HOCO} = 24 MHz, f _{IIH} = 24 MHz Note 3 | Normal operation | V _{DD} = 5.0 V | | 4.0 | 7.4 | | | | |
| | | | | | V _{DD} = 3.0 V | | 4.0 | | 7.4 | | |
| | | f _{HOCO} = 16 MHz, f _{IIH} = 16 MHz Note 3 | Normal operation | V _{DD} = 5.0 V | | 3.0 | 5.3 | | | | |
| | | | | | V _{DD} = 3.0 V | | 3.0 | | 5.3 | | |
| | | LS (low-speed main) mode Note 5 | f _{HOCO} = 8 MHz, f _{IIH} = 8 MHz Note 3 | Normal operation | V _{DD} = 3.0 V | | 1.4 | 2.3 | mA | | |
| | | | | | V _{DD} = 2.0 V | | 1.4 | 2.3 | | | |
| | | LV (low-voltage main) mode Note 5 | f _{HOCO} = 4 MHz, f _{IIH} = 4 MHz Note 3 | Normal operation | V _{DD} = 3.0 V | | 1.3 | 1.9 | mA | | |
| | | | | | V _{DD} = 2.0 V | | 1.3 | 1.9 | | | |
| | | HS (high-speed main) mode Note 5 | f _{MX} = 20 MHz Note 2, V _{DD} = 5.0 V | Normal operation | Square wave input | | 3.4 | 6.2 | mA | | |
| | | | | | Resonator connection | | 3.6 | 6.4 | | | |
| | | | f _{MX} = 20 MHz Note 2, V _{DD} = 3.0 V | Normal operation | Square wave input | | 3.4 | 6.2 | | | |
| | | | | | Resonator connection | | 3.6 | 6.4 | | | |
| | | | f _{MX} = 10 MHz Note 2, V _{DD} = 5.0 V | Normal operation | Square wave input | | 2.1 | 3.6 | | | |
| | | | | | Resonator connection | | 2.2 | 3.7 | | | |
| f _{MX} = 10 MHz Note 2, V _{DD} = 3.0 V | Normal operation | | Square wave input | | 2.1 | 3.6 | | | | | |
| | | | Resonator connection | | 2.2 | 3.7 | | | | | |
| LS (low-speed main) mode Note 5 | f _{MX} = 8 MHz Note 2, V _{DD} = 3.0 V | Normal operation | Square wave input | | 1.2 | 2.2 | mA | | | | |
| | | | Resonator connection | | 1.2 | 2.3 | | | | | |
| | f _{MX} = 8 MHz Note 2, V _{DD} = 2.0 V | Normal operation | Square wave input | | 1.2 | 2.2 | | | | | |
| | | | Resonator connection | | 1.2 | 2.3 | | | | | |
| Subsystem clock operation | f _{SUB} = 32.768 kHz Note 4 TA = -40°C | Normal operation | Square wave input | | 4.9 | 7.1 | μA | | | | |
| | | | Resonator connection | | 4.9 | 7.1 | | | | | |
| | f _{SUB} = 32.768 kHz Note 4 TA = +25°C | Normal operation | Square wave input | | 4.9 | 7.1 | | | | | |
| | | | Resonator connection | | 4.9 | 7.1 | | | | | |
| | f _{SUB} = 32.768 kHz Note 4 TA = +50°C | Normal operation | Square wave input | | 5.1 | 8.8 | | | | | |
| | | | Resonator connection | | 5.1 | 8.8 | | | | | |
| f _{SUB} = 32.768 kHz Note 4 TA = +70°C | Normal operation | Square wave input | | 5.5 | 10.5 | | | | | | |
| | | Resonator connection | | 5.5 | 10.5 | | | | | | |
| f _{SUB} = 32.768 kHz Note 4 TA = +85°C | Normal operation | Square wave input | | 6.5 | 14.5 | | | | | | |
| | | Resonator connection | | 6.5 | 14.5 | | | | | | |

(Notes and Remarks are listed on the next page.)

- Note 1.** Total current flowing into V_{DD}, EV_{DD0}, and EV_{DD1}, including the input leakage current flowing when the level of the input pin is fixed to V_{DD}, EV_{DD0}, and EV_{DD1}, or V_{SS}, EV_{SS0}, and EV_{SS1}. The values below the MAX. column include the peripheral operation current. However, not including the current flowing into the A/D converter, D/A converter, comparator, LVD circuit, I/O port, and on-chip pull-up/pull-down resistors and the current flowing during data flash rewrite.
- Note 2.** When high-speed on-chip oscillator and subsystem clock are stopped.
- Note 3.** When high-speed system clock and subsystem clock are stopped.
- Note 4.** When high-speed on-chip oscillator and high-speed system clock are stopped. When AMPHS1 = 1 (Ultra-low power consumption oscillation). However, not including the current flowing into the 12-bit interval timer and watchdog timer.
- Note 5.** Relationship between operation voltage width, operation frequency of CPU and operation mode is as below.
- | | |
|-----------------------------|---|
| HS (high-speed main) mode: | 2.7 V ≤ V _{DD} ≤ 5.5 V@1 MHz to 32 MHz |
| | 2.4 V ≤ V _{DD} ≤ 5.5 V@1 MHz to 16 MHz |
| LS (low-speed main) mode: | 1.8 V ≤ V _{DD} ≤ 5.5 V@1 MHz to 8 MHz |
| LV (low-voltage main) mode: | 1.6 V ≤ V _{DD} ≤ 5.5 V@1 MHz to 4 MHz |
- Remark 1.** f_{MX}: High-speed system clock frequency (X1 clock oscillation frequency or external main system clock frequency)
- Remark 2.** f_{HOCO}: High-speed on-chip oscillator clock frequency (64 MHz max.)
- Remark 3.** f_{IH}: High-speed on-chip oscillator clock frequency (32 MHz max.)
- Remark 4.** f_{SUB}: Subsystem clock frequency (XT1 clock oscillation frequency)
- Remark 5.** Except subsystem clock operation, temperature condition of the TYP. value is T_A = 25°C

(2) Flash ROM: 96 to 256 KB of 30- to 100-pin products**(TA = -40 to +85°C, 1.6 V ≤ EVDD0 = EVDD1 ≤ VDD ≤ 5.5 V, VSS = EVSS0 = EVSS1 = 0 V)****(2/2)**

| Parameter | Symbol | Conditions | | | MIN. | TYP. | MAX. | Unit | | | |
|-----------------------|----------------------------|---|--|--|--|--|-------------------------|------|------|-----|----|
| Supply current Note 1 | I _{DD2} Note 2 | HALT mode | HS (high-speed main) mode Note 7 | f _{HOCO} = 64 MHz, f _{IH} = 32 MHz Note 4 | V _{DD} = 5.0 V | | 0.79 | 3.32 | mA | | |
| | | | | | V _{DD} = 3.0 V | | 0.79 | 3.32 | | | |
| | | | | f _{HOCO} = 32 MHz, f _{IH} = 32 MHz Note 4 | V _{DD} = 5.0 V | | 0.49 | 2.63 | | | |
| | | | | | V _{DD} = 3.0 V | | 0.49 | 2.63 | | | |
| | | | | f _{HOCO} = 48 MHz, f _{IH} = 24 MHz Note 4 | V _{DD} = 5.0 V | | 0.62 | 2.57 | | | |
| | | | | | V _{DD} = 3.0 V | | 0.62 | 2.57 | | | |
| | | | f _{HOCO} = 24 MHz, f _{IH} = 24 MHz Note 4 | V _{DD} = 5.0 V | | 0.4 | 2.00 | | | | |
| | | | | V _{DD} = 3.0 V | | 0.4 | 2.00 | | | | |
| | | | f _{HOCO} = 16 MHz, f _{IH} = 16 MHz Note 4 | V _{DD} = 5.0 V | | 0.38 | 1.49 | | | | |
| | | | | V _{DD} = 3.0 V | | 0.38 | 1.49 | | | | |
| | | | | | LS (low-speed main) mode Note 7 | f _{HOCO} = 8 MHz, f _{IH} = 8 MHz Note 4 | V _{DD} = 3.0 V | | 250 | 800 | μA |
| | | | | | | | V _{DD} = 2.0 V | | 250 | 800 | |
| | | | | LV (low-voltage main) mode Note 7 | f _{HOCO} = 4 MHz, f _{IH} = 4 MHz Note 4 | V _{DD} = 3.0 V | | 420 | 755 | μA | |
| | | | | | | V _{DD} = 2.0 V | | 420 | 755 | | |
| | | | | HS (high-speed main) mode Note 7 | f _{MX} = 20 MHz Note 3, V _{DD} = 5.0 V | Square wave input | | 0.30 | 1.63 | mA | |
| | | | | | | Resonator connection | | 0.40 | 1.85 | | |
| | | | | | | Square wave input | | 0.30 | 1.63 | | |
| | | | | | | Resonator connection | | 0.40 | 1.85 | | |
| | | | | | f _{MX} = 10 MHz Note 3, V _{DD} = 5.0 V | Square wave input | | 0.20 | 0.89 | | |
| | | | | | | Resonator connection | | 0.25 | 0.97 | | |
| | | | | | | Square wave input | | 0.20 | 0.89 | | |
| | | | | | | Resonator connection | | 0.25 | 0.97 | | |
| | | | | LS (low-speed main) mode Note 7 | f _{MX} = 8 MHz Note 3, V _{DD} = 3.0 V | Square wave input | | 110 | 580 | μA | |
| | | | | | | Resonator connection | | 140 | 630 | | |
| | | | | | f _{MX} = 8 MHz Note 3, V _{DD} = 2.0 V | Square wave input | | 110 | 580 | | |
| | | | | | | Resonator connection | | 140 | 630 | | |
| | | | | Subsystem clock operation | f _{SUB} = 32.768 kHz Note 5, TA = -40°C | Square wave input | | 0.28 | 0.66 | μA | |
| | | Resonator connection | | | | 0.47 | 0.85 | | | | |
| | | f _{SUB} = 32.768 kHz Note 5, TA = +25°C | Square wave input | | | 0.34 | 0.66 | | | | |
| | | | Resonator connection | | | 0.53 | 0.85 | | | | |
| | | f _{SUB} = 32.768 kHz Note 5, TA = +50°C | Square wave input | | | 0.37 | 2.35 | | | | |
| | | | Resonator connection | | | 0.56 | 2.54 | | | | |
| | | f _{SUB} = 32.768 kHz Note 5, TA = +70°C | Square wave input | | | 0.61 | 4.08 | | | | |
| | | | Resonator connection | | | 0.80 | 4.27 | | | | |
| | | f _{SUB} = 32.768 kHz Note 5, TA = +85°C | Square wave input | | 1.55 | 8.09 | | | | | |
| | | | Resonator connection | | 1.74 | 8.28 | | | | | |
| | I _{DD3} Note 6 | STOP mode Note 8 | TA = -40°C | | | 0.19 | 0.57 | μA | | | |
| | | | TA = +25°C | | | 0.25 | 0.57 | | | | |
| | | | TA = +50°C | | | 0.33 | 2.26 | | | | |
| | | | TA = +70°C | | | 0.52 | 3.99 | | | | |
| | | | TA = +85°C | | | 1.46 | 8.00 | | | | |

(Notes and Remarks are listed on the next page.)

- Note 1.** Total current flowing into VDD, EVDD0, and EVDD1, including the input leakage current flowing when the level of the input pin is fixed to VDD, EVDD0, and EVDD1, or Vss, EVss0, and EVss1. The values below the MAX. column include the peripheral operation current. However, not including the current flowing into the A/D converter, D/A converter, comparator, LVD circuit, I/O port, and on-chip pull-up/pull-down resistors and the current flowing during data flash rewrite.
- Note 2.** During HALT instruction execution by flash memory.
- Note 3.** When high-speed on-chip oscillator and subsystem clock are stopped.
- Note 4.** When high-speed system clock and subsystem clock are stopped.
- Note 5.** When high-speed on-chip oscillator and high-speed system clock are stopped. When RTCLPC = 1 and setting ultra-low current consumption (AMPHS1 = 1). The current flowing into the RTC is included. However, not including the current flowing into the 12-bit interval timer and watchdog timer.
- Note 6.** Not including the current flowing into the RTC, 12-bit interval timer, and watchdog timer.
- Note 7.** Relationship between operation voltage width, operation frequency of CPU and operation mode is as below.
 HS (high-speed main) mode: $2.7\text{ V} \leq V_{DD} \leq 5.5\text{ V}@1\text{ MHz to }32\text{ MHz}$
 $2.4\text{ V} \leq V_{DD} \leq 5.5\text{ V}@1\text{ MHz to }16\text{ MHz}$
 LS (low-speed main) mode: $1.8\text{ V} \leq V_{DD} \leq 5.5\text{ V}@1\text{ MHz to }8\text{ MHz}$
 LV (low-voltage main) mode: $1.6\text{ V} \leq V_{DD} \leq 5.5\text{ V}@1\text{ MHz to }4\text{ MHz}$
- Note 8.** Regarding the value for current to operate the subsystem clock in STOP mode, refer to that in HALT mode.
- Remark 1.** fMX: High-speed system clock frequency (X1 clock oscillation frequency or external main system clock frequency)
- Remark 2.** fHOCO: High-speed on-chip oscillator clock frequency (64 MHz max.)
- Remark 3.** fIH: High-speed on-chip oscillator clock frequency (32 MHz max.)
- Remark 4.** fSUB: Subsystem clock frequency (XT1 clock oscillation frequency)
- Remark 5.** Except subsystem clock operation and STOP mode, temperature condition of the TYP. value is TA = 25°C

(3) Flash ROM: 384 to 512 KB of 48- to 100-pin products

(TA = -40 to +85°C, 1.6 V ≤ EVDD0 = EVDD1 ≤ VDD ≤ 5.5 V, VSS = EVSS0 = EVSS1 = 0 V)

(1/2)

| Parameter | Symbol | Conditions | | | | MIN. | TYP. | MAX. | Unit | | | |
|---------------------------|------------------|--|---|---|---|-------------------------|-------------------------|------|------|----|------|----|
| Supply current Note 1 | I _{DD1} | Operating mode | HS (high-speed main) mode Note 5 | f _{HOCO} = 64 MHz, f _{IIH} = 32 MHz Note 3 | Basic operation | V _{DD} = 5.0 V | | 2.9 | | mA | | |
| | | | | | | V _{DD} = 3.0 V | | 2.9 | | | | |
| | | | | f _{HOCO} = 32 MHz, f _{IIH} = 32 MHz Note 3 | Basic operation | V _{DD} = 5.0 V | | 2.5 | | | | |
| | | | | | | V _{DD} = 3.0 V | | 2.5 | | | | |
| | | | | HS (high-speed main) mode Note 5 | f _{HOCO} = 64 MHz, f _{IIH} = 32 MHz Note 3 | Normal operation | V _{DD} = 5.0 V | | 6.0 | | 11.2 | mA |
| | | | | | | | V _{DD} = 3.0 V | | 6.0 | | 11.2 | |
| | | | f _{HOCO} = 32 MHz, f _{IIH} = 32 MHz Note 3 | | Normal operation | V _{DD} = 5.0 V | | 5.5 | 10.6 | | | |
| | | | | | | V _{DD} = 3.0 V | | 5.5 | 10.6 | | | |
| | | | f _{HOCO} = 48 MHz, f _{IIH} = 24 MHz Note 3 | | Normal operation | V _{DD} = 5.0 V | | 4.7 | 8.6 | | | |
| | | | | | | V _{DD} = 3.0 V | | 4.7 | 8.6 | | | |
| | | | LS (low-speed main) mode Note 5 | f _{HOCO} = 24 MHz, f _{IIH} = 24 MHz Note 3 | Normal operation | V _{DD} = 5.0 V | | 4.4 | 8.2 | mA | | |
| | | | | | | V _{DD} = 3.0 V | | 4.4 | 8.2 | | | |
| | | LS (low-speed main) mode Note 5 | f _{HOCO} = 8 MHz, f _{IIH} = 8 MHz Note 3 | Normal operation | V _{DD} = 3.0 V | | 1.5 | 2.5 | mA | | | |
| | | | | | V _{DD} = 2.0 V | | 1.5 | 2.5 | | | | |
| | | LV (low-voltage main) mode Note 5 | f _{HOCO} = 4 MHz, f _{IIH} = 4 MHz Note 3 | Normal operation | V _{DD} = 3.0 V | | 1.5 | 2.1 | mA | | | |
| | | | | | V _{DD} = 2.0 V | | 1.5 | 2.1 | | | | |
| | | HS (high-speed main) mode Note 5 | f _{MX} = 20 MHz Note 2, V _{DD} = 5.0 V | Normal operation | Square wave input | | 3.7 | 6.8 | mA | | | |
| | | | | | Resonator connection | | 3.9 | 7.0 | | | | |
| | | | | Normal operation | Square wave input | | 3.7 | 6.8 | | | | |
| | | | | | Resonator connection | | 3.9 | 7.0 | | | | |
| | | | f _{MX} = 10 MHz Note 2, V _{DD} = 5.0 V | Normal operation | Square wave input | | 2.3 | 4.1 | | | | |
| | | | | | Resonator connection | | 2.3 | 4.2 | | | | |
| | | | | Normal operation | Square wave input | | 2.3 | 4.1 | | | | |
| | | | | | Resonator connection | | 2.3 | 4.2 | | | | |
| | | LS (low-speed main) mode Note 5 | f _{MX} = 8 MHz Note 2, V _{DD} = 3.0 V | Normal operation | Square wave input | | 1.4 | 2.4 | mA | | | |
| | | | | | Resonator connection | | 1.4 | 2.5 | | | | |
| | | | Normal operation | Square wave input | | 1.4 | 2.4 | | | | | |
| | | | | Resonator connection | | 1.4 | 2.5 | | | | | |
| Subsystem clock operation | | f _{SUB} = 32.768 kHz Note 4 TA = -40°C | Normal operation | Square wave input | | 5.2 | | μA | | | | |
| | | | | Resonator connection | | 5.2 | | | | | | |
| | | f _{SUB} = 32.768 kHz Note 4 TA = +25°C | Normal operation | Square wave input | | 5.3 | 7.7 | | | | | |
| | | | | Resonator connection | | 5.3 | 7.7 | | | | | |
| | | f _{SUB} = 32.768 kHz Note 4 TA = +50°C | Normal operation | Square wave input | | 5.5 | 10.6 | | | | | |
| | | | | Resonator connection | | 5.5 | 10.6 | | | | | |
| | | f _{SUB} = 32.768 kHz Note 4 TA = +70°C | Normal operation | Square wave input | | 5.9 | 13.2 | | | | | |
| | | | | Resonator connection | | 6.0 | 13.2 | | | | | |
| | | f _{SUB} = 32.768 kHz Note 4 TA = +85°C | Normal operation | Square wave input | | 6.8 | 17.5 | | | | | |
| | | | | Resonator connection | | 6.9 | 17.5 | | | | | |

(Notes and Remarks are listed on the next page.)

- Note 1.** Total current flowing into V_{DD}, EV_{DD0}, and EV_{DD1}, including the input leakage current flowing when the level of the input pin is fixed to V_{DD}, EV_{DD0}, and EV_{DD1}, or V_{SS}, EV_{SS0}, and EV_{SS1}. The values below the MAX. column include the peripheral operation current. However, not including the current flowing into the A/D converter, D/A converter, comparator, LVD circuit, I/O port, and on-chip pull-up/pull-down resistors and the current flowing during data flash rewrite.
- Note 2.** When high-speed on-chip oscillator and subsystem clock are stopped.
- Note 3.** When high-speed system clock and subsystem clock are stopped.
- Note 4.** When high-speed on-chip oscillator and high-speed system clock are stopped. When AMPHS1 = 1 (Ultra-low power consumption oscillation). However, not including the current flowing into the 12-bit interval timer and watchdog timer.
- Note 5.** Relationship between operation voltage width, operation frequency of CPU and operation mode is as below.
- | | |
|-----------------------------|---|
| HS (high-speed main) mode: | 2.7 V ≤ V _{DD} ≤ 5.5 V@1 MHz to 32 MHz |
| | 2.4 V ≤ V _{DD} ≤ 5.5 V@1 MHz to 16 MHz |
| LS (low-speed main) mode: | 1.8 V ≤ V _{DD} ≤ 5.5 V@1 MHz to 8 MHz |
| LV (low-voltage main) mode: | 1.6 V ≤ V _{DD} ≤ 5.5 V@1 MHz to 4 MHz |
- Remark 1.** f_{MX}: High-speed system clock frequency (X1 clock oscillation frequency or external main system clock frequency)
- Remark 2.** f_{HOCO}: High-speed on-chip oscillator clock frequency (64 MHz max.)
- Remark 3.** f_{IH}: High-speed on-chip oscillator clock frequency (32 MHz max.)
- Remark 4.** f_{SUB}: Subsystem clock frequency (XT1 clock oscillation frequency)
- Remark 5.** Except subsystem clock operation, temperature condition of the TYP. value is T_A = 25°C

(3) Flash ROM: 384 to 512 KB of 48- to 100-pin products**(TA = -40 to +85°C, 1.6 V ≤ EVDD0 = EVDD1 ≤ VDD ≤ 5.5 V, VSS = EVSS0 = EVSS1 = 0 V)****(2/2)**

| Parameter | Symbol | Conditions | | | MIN. | TYP. | MAX. | Unit | | | |
|-----------------------|----------------------------|---|--|--|--|--|-------------------------|-------|------|-----|----|
| Supply current Note 1 | I _{DD2} Note 2 | HALT mode | HS (high-speed main) mode Note 7 | f _{HOCO} = 64 MHz, f _{IH} = 32 MHz Note 4 | V _{DD} = 5.0 V | | 0.93 | 3.32 | mA | | |
| | | | | | V _{DD} = 3.0 V | | 0.93 | 3.32 | | | |
| | | | | f _{HOCO} = 32 MHz, f _{IH} = 32 MHz Note 4 | V _{DD} = 5.0 V | | 0.5 | 2.63 | | | |
| | | | | | V _{DD} = 3.0 V | | 0.5 | 2.63 | | | |
| | | | | f _{HOCO} = 48 MHz, f _{IH} = 24 MHz Note 4 | V _{DD} = 5.0 V | | 0.72 | 2.60 | | | |
| | | | | | V _{DD} = 3.0 V | | 0.72 | 2.60 | | | |
| | | | f _{HOCO} = 24 MHz, f _{IH} = 24 MHz Note 4 | V _{DD} = 5.0 V | | 0.42 | 2.03 | | | | |
| | | | | V _{DD} = 3.0 V | | 0.42 | 2.03 | | | | |
| | | | f _{HOCO} = 16 MHz, f _{IH} = 16 MHz Note 4 | V _{DD} = 5.0 V | | 0.39 | 1.50 | | | | |
| | | | | V _{DD} = 3.0 V | | 0.39 | 1.50 | | | | |
| | | | | | LS (low-speed main) mode Note 7 | f _{HOCO} = 8 MHz, f _{IH} = 8 MHz Note 4 | V _{DD} = 3.0 V | | 270 | 800 | μA |
| | | | | | | | V _{DD} = 2.0 V | | 270 | 800 | |
| | | | | LV (low-voltage main) mode Note 7 | f _{HOCO} = 4 MHz, f _{IH} = 4 MHz Note 4 | V _{DD} = 3.0 V | | 450 | 755 | μA | |
| | | | | | | V _{DD} = 2.0 V | | 450 | 755 | | |
| | | | | HS (high-speed main) mode Note 7 | f _{MX} = 20 MHz Note 3, V _{DD} = 5.0 V | Square wave input | | 0.31 | 1.69 | mA | |
| | | | | | | Resonator connection | | 0.41 | 1.91 | | |
| | | | | | | Square wave input | | 0.31 | 1.69 | | |
| | | | | | | Resonator connection | | 0.41 | 1.91 | | |
| | | | | | f _{MX} = 10 MHz Note 3, V _{DD} = 5.0 V | Square wave input | | 0.21 | 0.94 | | |
| | | | | | | Resonator connection | | 0.26 | 1.02 | | |
| | | | | | f _{MX} = 10 MHz Note 3, V _{DD} = 3.0 V | Square wave input | | 0.21 | 0.94 | | |
| | | | | | | Resonator connection | | 0.26 | 1.02 | | |
| | | | | LS (low-speed main) mode Note 7 | f _{MX} = 8 MHz Note 3, V _{DD} = 3.0 V | Square wave input | | 110 | 610 | μA | |
| | | | | | | Resonator connection | | 150 | 660 | | |
| | | | | | f _{MX} = 8 MHz Note 3, V _{DD} = 2.0 V | Square wave input | | 110 | 610 | | |
| | | | | | | Resonator connection | | 150 | 660 | | |
| | | | | Subsystem clock operation | f _{SUB} = 32.768 kHz Note 5, TA = -40°C | Square wave input | | 0.31 | | μA | |
| | | Resonator connection | | | | 0.50 | | | | | |
| | | f _{SUB} = 32.768 kHz Note 5, TA = +25°C | Square wave input | | | 0.38 | 0.76 | | | | |
| | | | Resonator connection | | | 0.57 | 0.95 | | | | |
| | | f _{SUB} = 32.768 kHz Note 5, TA = +50°C | Square wave input | | | 0.47 | 3.59 | | | | |
| | | | Resonator connection | | | 0.70 | 3.78 | | | | |
| | | f _{SUB} = 32.768 kHz Note 5, TA = +70°C | Square wave input | | | 0.80 | 6.20 | | | | |
| | | | Resonator connection | | | 1.00 | 6.39 | | | | |
| | | f _{SUB} = 32.768 kHz Note 5, TA = +85°C | Square wave input | | 1.65 | 10.56 | | | | | |
| | | | Resonator connection | | 1.84 | 10.75 | | | | | |
| | I _{DD3} Note 6 | STOP mode Note 8 | TA = -40°C | | | | 0.19 | | μA | | |
| | | | TA = +25°C | | | | 0.30 | 0.59 | | | |
| | | | TA = +50°C | | | | 0.41 | 3.42 | | | |
| | | | TA = +70°C | | | | 0.80 | 6.03 | | | |
| | | | TA = +85°C | | | | 1.53 | 10.39 | | | |

(Notes and Remarks are listed on the next page.)

- Note 1.** Total current flowing into VDD, EVDD0, and EVDD1, including the input leakage current flowing when the level of the input pin is fixed to VDD, EVDD0, and EVDD1, or Vss, EVss0, and EVss1. The values below the MAX. column include the peripheral operation current. However, not including the current flowing into the A/D converter, D/A converter, comparator, LVD circuit, I/O port, and on-chip pull-up/pull-down resistors and the current flowing during data flash rewrite.
- Note 2.** During HALT instruction execution by flash memory.
- Note 3.** When high-speed on-chip oscillator and subsystem clock are stopped.
- Note 4.** When high-speed system clock and subsystem clock are stopped.
- Note 5.** When high-speed on-chip oscillator and high-speed system clock are stopped. When RTCLPC = 1 and setting ultra-low current consumption (AMPHS1 = 1). The current flowing into the RTC is included. However, not including the current flowing into the 12-bit interval timer and watchdog timer.
- Note 6.** Not including the current flowing into the RTC, 12-bit interval timer, and watchdog timer.
- Note 7.** Relationship between operation voltage width, operation frequency of CPU and operation mode is as below.
 HS (high-speed main) mode: $2.7\text{ V} \leq V_{DD} \leq 5.5\text{ V}@1\text{ MHz to }32\text{ MHz}$
 $2.4\text{ V} \leq V_{DD} \leq 5.5\text{ V}@1\text{ MHz to }16\text{ MHz}$
 LS (low-speed main) mode: $1.8\text{ V} \leq V_{DD} \leq 5.5\text{ V}@1\text{ MHz to }8\text{ MHz}$
 LV (low-voltage main) mode: $1.6\text{ V} \leq V_{DD} \leq 5.5\text{ V}@1\text{ MHz to }4\text{ MHz}$
- Note 8.** Regarding the value for current to operate the subsystem clock in STOP mode, refer to that in HALT mode.
- Remark 1.** fMX: High-speed system clock frequency (X1 clock oscillation frequency or external main system clock frequency)
- Remark 2.** fHOCO: High-speed on-chip oscillator clock frequency (64 MHz max.)
- Remark 3.** fIH: High-speed on-chip oscillator clock frequency (32 MHz max.)
- Remark 4.** fSUB: Subsystem clock frequency (XT1 clock oscillation frequency)
- Remark 5.** Except subsystem clock operation and STOP mode, temperature condition of the TYP. value is TA = 25°C

(4) Peripheral Functions (Common to all products)**(TA = -40 to +85°C, 1.6 V ≤ EVDD0 = EVDD1 ≤ VDD ≤ 5.5 V, VSS = EVSS0 = EVSS1 = 0 V)**

| Parameter | Symbol | Conditions | | MIN. | TYP. | MAX. | Unit |
|--|----------------------|--|---|------|------|-------|------|
| Low-speed on-chip oscillator operating current | IFIL Note 1 | | | | 0.20 | | μA |
| RTC operating current | IRTC Notes 1, 2, 3 | | | | 0.02 | | μA |
| 12-bit interval timer operating current | IIT Notes 1, 2, 4 | | | | 0.02 | | μA |
| Watchdog timer operating current | IWDT Notes 1, 2, 5 | fil = 15 kHz | | | 0.22 | | μA |
| A/D converter operating current | IADC Notes 1, 6 | When conversion at maximum speed | Normal mode, AVREFP = VDD = 5.0 V | | 1.3 | 1.7 | mA |
| | | | Low voltage mode, AVREFP = VDD = 3.0 V | | 0.5 | 0.7 | mA |
| A/D converter reference voltage current | IADREF Note 1 | | | | 75.0 | | μA |
| Temperature sensor operating current | ITMPS Note 1 | | | | 75.0 | | μA |
| D/A converter operating current | IDAC Notes 1, 11, 13 | Per D/A converter channel | | | | 1.5 | mA |
| Comparator operating current | ICMP Notes 1, 12, 13 | VDD = 5.0 V, Regulator output voltage = 2.1 V | Window mode | | 12.5 | | μA |
| | | | Comparator high-speed mode | | 6.5 | | μA |
| | | | Comparator low-speed mode | | 1.7 | | μA |
| | | VDD = 5.0 V, Regulator output voltage = 1.8 V | Window mode | | 8.0 | | μA |
| | | | Comparator high-speed mode | | 4.0 | | μA |
| | | | Comparator low-speed mode | | 1.3 | | μA |
| LVD operating current | ILVD Notes 1, 7 | | | | 0.08 | | μA |
| Self-programming operating current | IFSP Notes 1, 9 | | | | 2.50 | 12.20 | mA |
| BGO operating current | IBGO Notes 1, 8 | | | | 2.50 | 12.20 | mA |
| SNOOZE operating current | ISNOZ Note 1 | ADC operation | The mode is performed Note 10 | | 0.50 | 0.60 | mA |
| | | | The A/D conversion operations are performed, Low voltage mode, AVREFP = VDD = 3.0 V | | 1.20 | 1.44 | |
| | | CSI/JART operation | | 0.70 | 0.84 | | |
| | | DTC operation | | 3.10 | | | |

Note 1. Current flowing to VDD.**Note 2.** When high speed on-chip oscillator and high-speed system clock are stopped.**Note 3.** Current flowing only to the real-time clock (RTC) (excluding the operating current of the low-speed on-chip oscillator and the XT1 oscillator). The supply current of the RL78 microcontrollers is the sum of the values of either IDD1 or IDD2, and IRTC, when the real-time clock operates in operation mode or HALT mode. When the low-speed on-chip oscillator is selected, IFIL should be added. IDD2 subsystem clock operation includes the operational current of the real-time clock.**Note 4.** Current flowing only to the 12-bit interval timer (excluding the operating current of the low-speed on-chip oscillator and the XT1 oscillator). The supply current of the RL78 microcontrollers is the sum of the values of either IDD1 or IDD2, and IIT, when the 12-bit interval timer operates in operation mode or HALT mode. When the low-speed on-chip oscillator is selected, IFIL should be added.

- Note 5.** Current flowing only to the watchdog timer (including the operating current of the low-speed on-chip oscillator). The supply current of the RL78 microcontrollers is the sum of I_{DD1}, I_{DD2} or I_{DD3} and I_{WDT} when the watchdog timer is in operation.
- Note 6.** Current flowing only to the A/D converter. The supply current of the RL78 microcontrollers is the sum of I_{DD1} or I_{DD2} and I_{ADC} when the A/D converter operates in an operation mode or the HALT mode.
- Note 7.** Current flowing only to the LVD circuit. The supply current of the RL78 microcontrollers is the sum of I_{DD1}, I_{DD2} or I_{DD3} and I_{LVD} when the LVD circuit is in operation.
- Note 8.** Current flowing during programming of the data flash.
- Note 9.** Current flowing during self-programming.
- Note 10.** For shift time to the SNOOZE mode, see **23.3.3 SNOOZE mode** in the RL78/G14 User's Manual.
- Note 11.** Current flowing only to the D/A converter. The supply current of the RL78 microcontrollers is the sum of I_{DD1} or I_{DD2} and I_{DAC} when the D/A converter operates in an operation mode or the HALT mode.
- Note 12.** Current flowing only to the comparator circuit. The supply current of the RL78 microcontrollers is the sum of I_{DD1}, I_{DD2}, or I_{DD3} and I_{COMP} when the comparator circuit is in operation.
- Note 13.** A comparator and D/A converter are provided in products with 96 KB or more code flash memory.
- Remark 1.** f_{IL}: Low-speed on-chip oscillator clock frequency
- Remark 2.** f_{SUB}: Subsystem clock frequency (XT1 clock oscillation frequency)
- Remark 3.** f_{CLK}: CPU/peripheral hardware clock frequency
- Remark 4.** Temperature condition of the TYP. value is T_A = 25°C

2.4 AC Characteristics

(TA = -40 to +85°C, 1.6 V ≤ EVDD0 = EVDD1 ≤ VDD ≤ 5.5 V, VSS = EVSS0 = EVSS1 = 0 V)

(1/2)

| Items | Symbol | Conditions | | MIN. | TYP. | MAX. | Unit | |
|--|---------------------|---|----------------------------------|---------------------|---------|------|------|----|
| Instruction cycle (minimum instruction execution time) | Tcy | Main system clock (fMAIN) operation | HS (high-speed main) mode | 2.7 V ≤ VDD ≤ 5.5 V | 0.03125 | | 1 | μs |
| | | | | 2.4 V ≤ VDD < 2.7 V | 0.0625 | | 1 | μs |
| | | | LS (low-speed main) mode | 1.8 V ≤ VDD ≤ 5.5 V | 0.125 | | 1 | μs |
| | | | LV (low-voltage main) mode | 1.6 V ≤ VDD ≤ 5.5 V | 0.25 | | 1 | μs |
| | | | Subsystem clock (fSUB) operation | 1.8 V ≤ VDD ≤ 5.5 V | 28.5 | 30.5 | 31.3 | μs |
| | | In the self- programming mode | HS (high-speed main) mode | 2.7 V ≤ VDD ≤ 5.5 V | 0.03125 | | 1 | μs |
| | | | | 2.4 V ≤ VDD < 2.7 V | 0.0625 | | 1 | μs |
| | | | LS (low-speed main) mode | 1.8 V ≤ VDD ≤ 5.5 V | 0.125 | | 1 | μs |
| LV (low-voltage main) mode | 1.8 V ≤ VDD ≤ 5.5 V | | 0.25 | | 1 | μs | | |
| External system clock frequency | fex | 2.7 V ≤ VDD ≤ 5.5 V | | 1.0 | | 20.0 | MHz | |
| | | 2.4 V ≤ VDD ≤ 2.7 V | | 1.0 | | 16.0 | MHz | |
| | | 1.8 V ≤ VDD < 2.4 V | | 1.0 | | 8.0 | MHz | |
| | | 1.6 V ≤ VDD < 1.8 V | | 1.0 | | 4.0 | MHz | |
| | fexs | | | 32 | | 35 | kHz | |
| External system clock input high-level width, low-level width | tEXH, tEXL | 2.7 V ≤ VDD ≤ 5.5 V | | 24 | | | ns | |
| | | 2.4 V ≤ VDD ≤ 2.7 V | | 30 | | | ns | |
| | | 1.8 V ≤ VDD < 2.4 V | | 60 | | | ns | |
| | | 1.6 V ≤ VDD < 1.8 V | | 120 | | | ns | |
| | tEXHS, tEXLS | | | 13.7 | | | μs | |
| T100 to T103, T110 to T113 input high-level width, low-level width | tT1H, tT1L | | | 1/fMCK + 10 Note | | | ns | |
| Timer RJ input cycle | fc | TRJIO | 2.7 V ≤ EVDD0 ≤ 5.5 V | 100 | | | ns | |
| | | | 1.8 V ≤ EVDD0 < 2.7 V | 300 | | | ns | |
| | | | 1.6 V ≤ EVDD0 < 1.8 V | 500 | | | ns | |
| Timer RJ input high- level width, low-level width | tTJH, tTJL | TRJIO | 2.7 V ≤ EVDD0 ≤ 5.5 V | 40 | | | ns | |
| | | | 1.8 V ≤ EVDD0 < 2.7 V | 120 | | | ns | |
| | | | 1.6 V ≤ EVDD0 < 1.8 V | 200 | | | ns | |

Note The following conditions are required for low voltage interface when EVDD0 < VDD

1.8 V ≤ EVDD0 < 2.7 V: MIN. 125 ns

1.6 V ≤ EVDD0 < 1.8 V: MIN. 250 ns

Remark fMCK: Timer array unit operation clock frequency

(Operation clock to be set by the CKSmn bit of timer mode register mn (TMRmn). m: Unit number (m = 0, 1), n: Channel number (n = 0 to 3))

(TA = -40 to +85°C, 1.6 V ≤ EVDD0 = EVDD1 ≤ VDD ≤ 5.5 V, VSS = EVSS0 = EVSS1 = 0 V)

(2/2)

| Items | Symbol | Conditions | | MIN. | TYP. | MAX. | Unit |
|--|-----------------------|---|-----------------------|------------|------|------|------|
| Timer RD input high-level width, low-level width | tTDIH, tTDIL | TRDIOA0, TRDIOA1, TRDIOB0, TRDIOB1, TRDIOC0, TRDIOC1, TRDIOD0, TRDIOD1 | | 3/fCLK | | | ns |
| Timer RD forced cutoff signal input low-level width | tTDSIL | P130/INTP0 | 2MHz < fCLK ≤ 32 MHz | 1 | | | μs |
| | | | fCLK ≤ 2 MHz | 1/fCLK + 1 | | | |
| Timer RG input high-level width, low-level width | tTGIH, tTGIL | TRGIOA, TRGIOB | | 2.5/fCLK | | | ns |
| TO00 to TO03, TO10 to TO13, TRJIO0, TRJO0, TRDIOA0, TRDIOA1, TRDIOB0, TRDIOB1, TRDIOC0, TRDIOC1, TRDIOD0, TRDIOD1, TRGIOA, TRGIOB output frequency | fTO | HS (high-speed main) mode | 4.0 V ≤ EVDD0 ≤ 5.5 V | | | 16 | MHz |
| | | | 2.7 V ≤ EVDD0 < 4.0 V | | | 8 | MHz |
| | | | 1.8 V ≤ EVDD0 < 2.7 V | | | 4 | MHz |
| | | | 1.6 V ≤ EVDD0 < 1.8 V | | | 2 | MHz |
| | | LS (low-speed main) mode | 1.8 V ≤ EVDD0 ≤ 5.5 V | | | 4 | MHz |
| | | | 1.6 V ≤ EVDD0 < 1.8 V | | | 2 | MHz |
| LV (low-voltage main) mode | 1.6 V ≤ EVDD0 ≤ 5.5 V | | | 2 | MHz | | |
| PCLBUZ0, PCLBUZ1 output frequency | fPCL | HS (high-speed main) mode | 4.0 V ≤ EVDD0 ≤ 5.5 V | | | 16 | MHz |
| | | | 2.7 V ≤ EVDD0 < 4.0 V | | | 8 | MHz |
| | | | 1.8 V ≤ EVDD0 < 2.7 V | | | 4 | MHz |
| | | | 1.6 V ≤ EVDD0 < 1.8 V | | | 2 | MHz |
| | | LS (low-speed main) mode | 1.8 V ≤ EVDD0 ≤ 5.5 V | | | 4 | MHz |
| | | | 1.6 V ≤ EVDD0 < 1.8 V | | | 2 | MHz |
| LV (low-voltage main) mode | 1.8 V ≤ EVDD0 ≤ 5.5 V | | | 4 | MHz | | |
| | | 1.6 V ≤ EVDD0 < 1.8 V | | | 2 | MHz | |
| Interrupt input high-level width, low-level width | tINTH, tINTL | INTP0 | 1.6 V ≤ VDD ≤ 5.5 V | 1 | | | μs |
| | | INTP1 to INTP11 | 1.6 V ≤ EVDD0 ≤ 5.5 V | 1 | | | μs |
| Key interrupt input low-level width | tKR | KR0 to KR7 | 1.8 V ≤ EVDD0 ≤ 5.5 V | 250 | | | ns |
| | | | 1.6 V ≤ EVDD0 < 1.8 V | 1 | | | μs |
| RESET low-level width | tRSL | | | 10 | | | μs |

Minimum Instruction Execution Time during Main System Clock Operation

Tcy vs VDD (HS (high-speed main) mode)

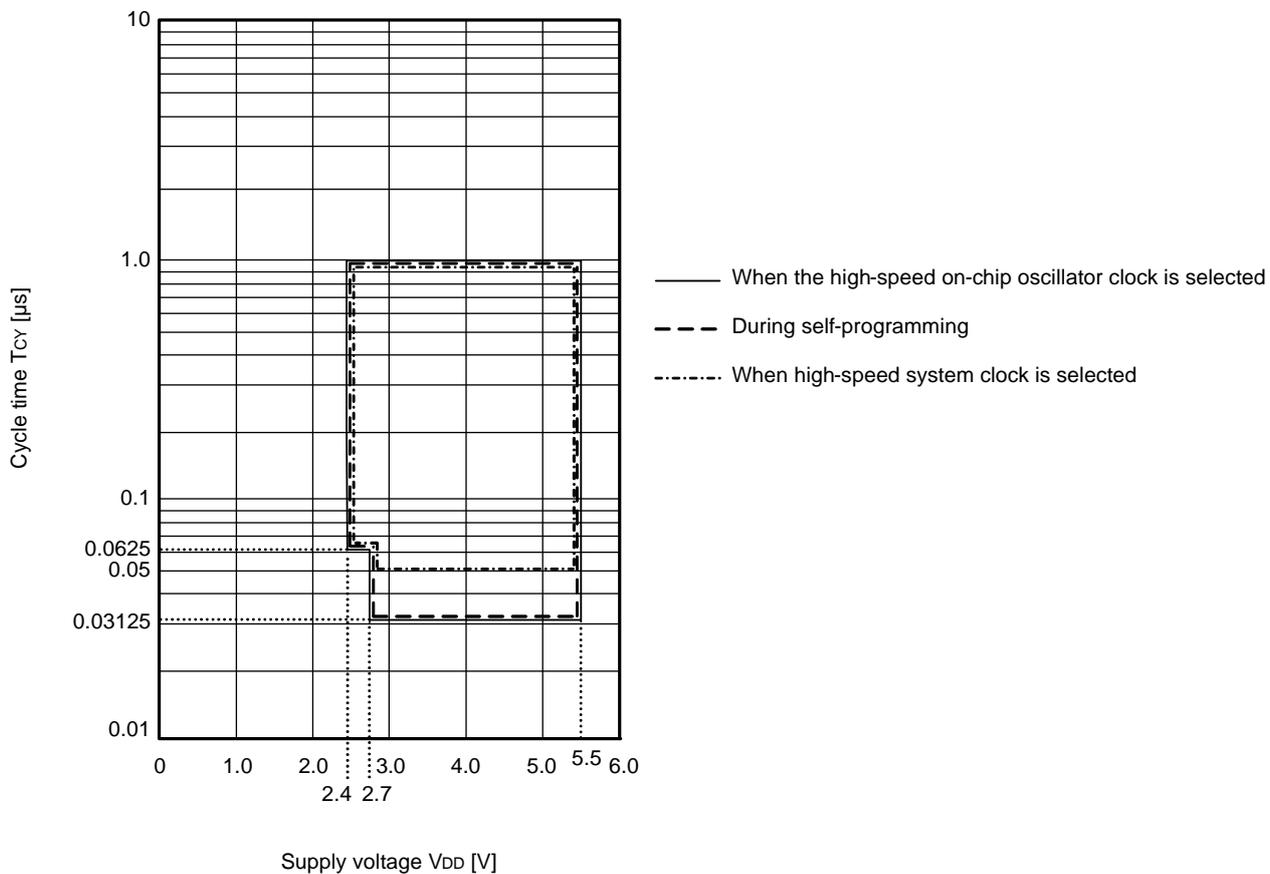

T_{CY} vs V_{DD} (LS (low-speed main) mode)

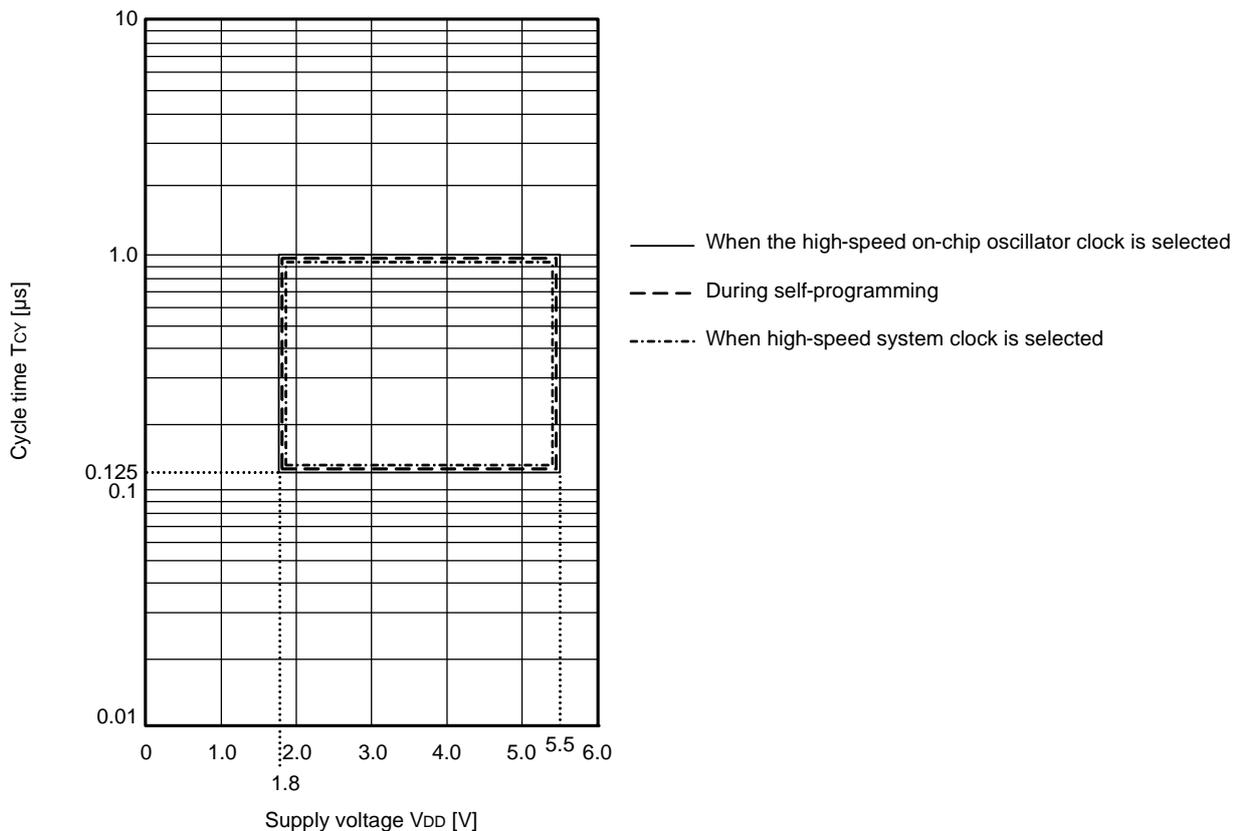

T_{CY} vs V_{DD} (LV (low-voltage main) mode)

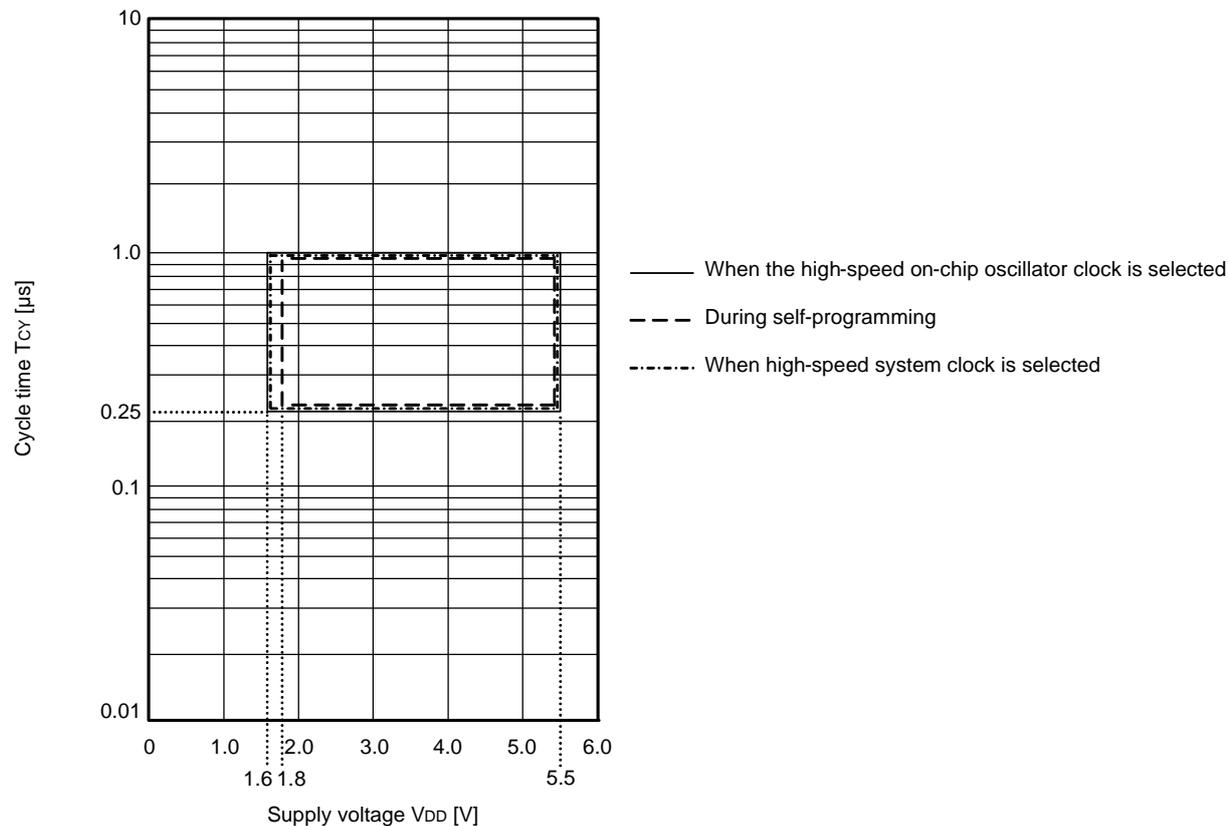

AC Timing Test Points

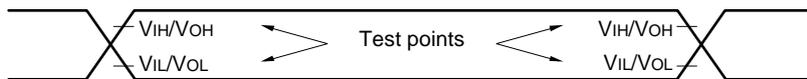

External System Clock Timing

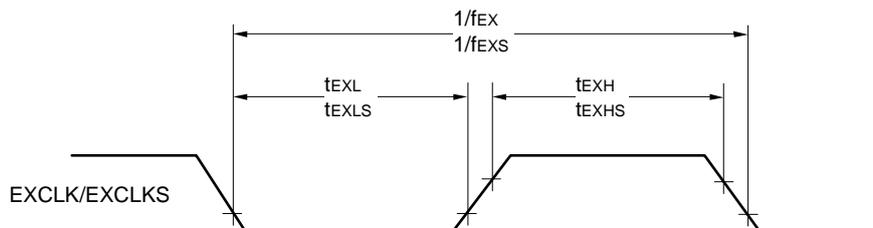

TI/TO Timing

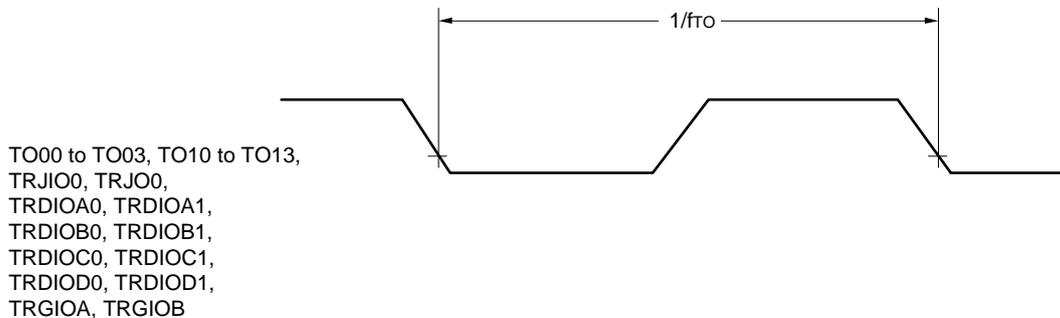
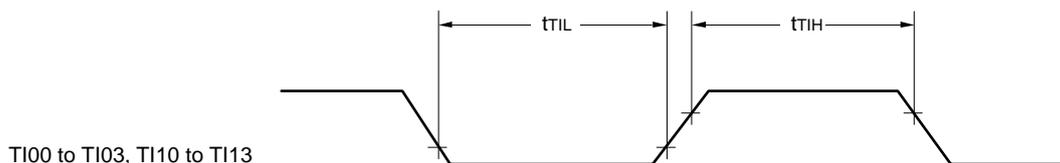

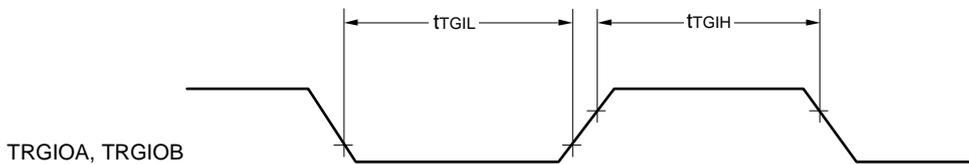
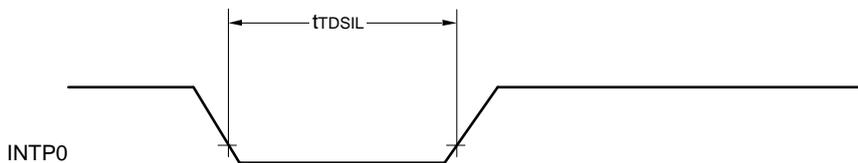
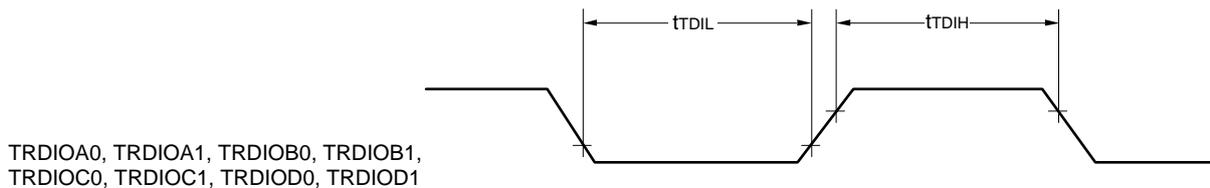
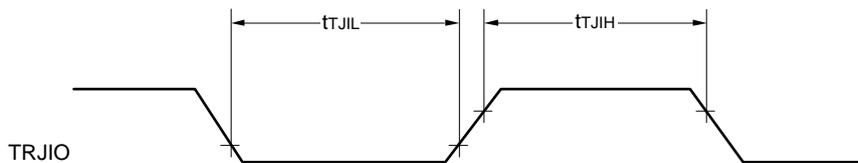

Interrupt Request Input Timing

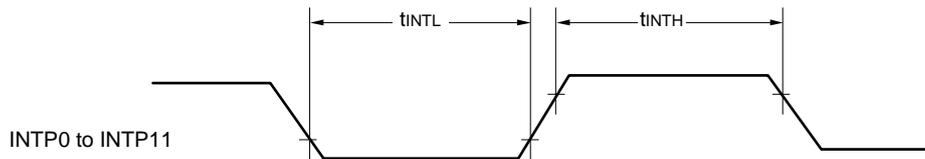

Key Interrupt Input Timing

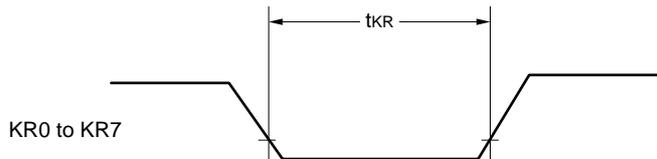

RESET Input Timing

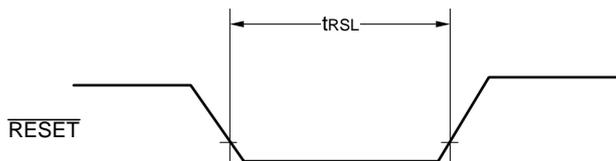

2.5 Peripheral Functions Characteristics

AC Timing Test Points

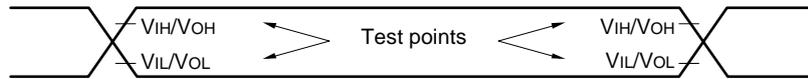

2.5.1 Serial array unit

(1) During communication at same potential (UART mode)

(TA = -40 to +85°C, 1.6 V ≤ EVDD0 = EVDD1 ≤ 5.5 V, VSS = EVSS0 = EVSS1 = 0 V)

| Parameter | Symbol | Conditions | HS (high-speed main) Mode | | LS (low-speed main) Mode | | LV (low-voltage main) Mode | | Unit |
|-------------------------|--------|--|---------------------------|---------------|--------------------------|---------------|----------------------------|--------|------|
| | | | MIN. | MAX. | MIN. | MAX. | MIN. | MAX. | |
| Transfer rate Note 1 | | 2.4 V ≤ EVDD0 ≤ 5.5 V | | fMCK/6 Note 2 | | fMCK/6 | | fMCK/6 | bps |
| | | Theoretical value of the maximum transfer rate fMCK = fCLK Note 3 | | 5.3 | | 1.3 | | 0.6 | Mbps |
| | | 1.8 V ≤ EVDD0 ≤ 5.5 V | | fMCK/6 Note 2 | | fMCK/6 | | fMCK/6 | bps |
| | | Theoretical value of the maximum transfer rate fMCK = fCLK Note 3 | | 5.3 | | 1.3 | | 0.6 | Mbps |
| | | 1.7 V ≤ EVDD0 ≤ 5.5 V | | fMCK/6 Note 2 | | fMCK/6 Note 2 | | fMCK/6 | bps |
| | | Theoretical value of the maximum transfer rate fMCK = fCLK Note 3 | | 5.3 | | 1.3 | | 0.6 | Mbps |
| | | 1.6 V ≤ EVDD0 ≤ 5.5 V | — | | | fMCK/6 Note 2 | | fMCK/6 | bps |
| | | Theoretical value of the maximum transfer rate fMCK = fCLK Note 3 | — | | | 1.3 | | 0.6 | Mbps |

Note 1. Transfer rate in the SNOOZE mode is 4800 bps only.

However, the SNOOZE mode cannot be used when FRQSEL4 = 1.

Note 2. The following conditions are required for low voltage interface when EVDD0 < VDD.

2.4 V ≤ EVDD0 < 2.7 V: MAX. 2.6 Mbps

1.8 V ≤ EVDD0 < 2.4 V: MAX. 1.3 Mbps

1.6 V ≤ EVDD0 < 1.8 V: MAX. 0.6 Mbps

Note 3. The maximum operating frequencies of the CPU/peripheral hardware clock (fCLK) are:

HS (high-speed main) mode: 32 MHz (2.7 V ≤ VDD ≤ 5.5 V)

16 MHz (2.4 V ≤ VDD ≤ 5.5 V)

LS (low-speed main) mode: 8 MHz (1.8 V ≤ VDD ≤ 5.5 V)

LV (low-voltage main) mode: 4 MHz (1.6 V ≤ VDD ≤ 5.5 V)

Caution Select the normal input buffer for the RxDq pin and the normal output mode for the TxDq pin by using port input mode register g (PIMg) and port output mode register g (POMg).

UART mode connection diagram (during communication at same potential)

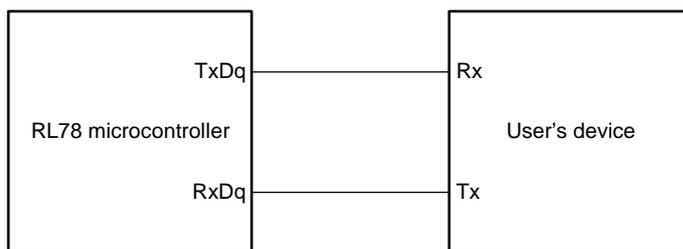

UART mode bit width (during communication at same potential) (reference)

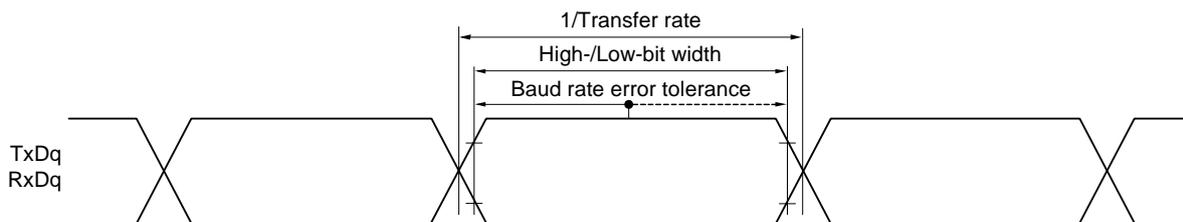

Remark 1. q: UART number (q = 0 to 3), g: PIM and POM number (g = 0, 1, 5, 14)

Remark 2. f_{MCK}: Serial array unit operation clock frequency

(Operation clock to be set by the CKSmn bit of serial mode register mn (SMRmn). m: Unit number, n: Channel number (mn = 00 to 03, 10 to 13))

(2) During communication at same potential (CSI mode) (master mode, SCKp... internal clock output, corresponding CSI00 only)**(TA = -40 to +85°C, 2.7 V ≤ EVDD0 = EVDD1 ≤ VDD ≤ 5.5 V, VSS = EVSS0 = EVSS1 = 0 V)**

| Parameter | Symbol | Conditions | HS (high-speed main) mode | | LS (low-speed main) mode | | LV (low-voltage main) mode | | Unit |
|---|---------------|---|---------------------------|------|--------------------------|------|----------------------------|------|------|
| | | | MIN. | MAX. | MIN. | MAX. | MIN. | MAX. | |
| SCKp cycle time | tkCY1 | tkCY1 ≥ 2/fCLK 4.0 V ≤ EVDD0 ≤ 5.5 V | 62.5 | | 250 | | 500 | | ns |
| | | | 83.3 | | 250 | | 500 | | ns |
| SCKp high-/low-level width | tkH1, tkL1 | 4.0 V ≤ EVDD0 ≤ 5.5 V | tkCY1/2 - 7 | | tkCY1/2 - 50 | | tkCY1/2 - 50 | | ns |
| | | 2.7 V ≤ EVDD0 ≤ 5.5 V | tkCY1/2 - 10 | | tkCY1/2 - 50 | | tkCY1/2 - 50 | | ns |
| Slp setup time (to SCKp↑) Note 1 | tsIK1 | 4.0 V ≤ EVDD0 ≤ 5.5 V | 23 | | 110 | | 110 | | ns |
| | | 2.7 V ≤ EVDD0 ≤ 5.5 V | 33 | | 110 | | 110 | | ns |
| Slp hold time (from SCKp↑) Note 2 | tkSI1 | 2.7 V ≤ EVDD0 ≤ 5.5 V | 10 | | 10 | | 10 | | ns |
| Delay time from SCKp↓ to SOp output Note 3 | tkSO1 | C = 20 pF Note 4 | | 10 | | 10 | | 10 | ns |

Note 1. When DAPmn = 0 and CKPmn = 0, or DAPmn = 1 and CKPmn = 1. The Slp setup time becomes “to SCKp↓” when DAPmn = 0 and CKPmn = 1, or DAPmn = 1 and CKPmn = 0.

Note 2. When DAPmn = 0 and CKPmn = 0, or DAPmn = 1 and CKPmn = 1. The Slp hold time becomes “from SCKp↓” when DAPmn = 0 and CKPmn = 1, or DAPmn = 1 and CKPmn = 0.

Note 3. When DAPmn = 0 and CKPmn = 0, or DAPmn = 1 and CKPmn = 1. The delay time to SOp output becomes “from SCKp↑” when DAPmn = 0 and CKPmn = 1, or DAPmn = 1 and CKPmn = 0.

Note 4. C is the load capacitance of the SCKp and SOp output lines.

Caution Select the normal input buffer for the Slp pin and the normal output mode for the SOp pin and SCKp pin by using port input mode register g (PIMg) and port output mode register g (POMg).

Remark 1. This value is valid only when CSI00's peripheral I/O redirect function is not used.

Remark 2. p: CSI number (p = 00), m: Unit number (m = 0), n: Channel number (n = 0),
g: PIM and POM numbers (g = 1)

Remark 3. fMCK: Serial array unit operation clock frequency
(Operation clock to be set by the CKSmn bit of serial mode register mn (SMRmn). m: Unit number,
n: Channel number (mn = 00))

(3) During communication at same potential (CSI mode) (master mode, SCKp... internal clock output)
(TA = -40 to +85°C, 1.6 V ≤ EVDD0 = EVDD1 ≤ VDD ≤ 5.5 V, VSS = EVSS0 = EVSS1 = 0 V)

| Parameter | Symbol | Conditions | | HS (high-speed main) mode | | LS (low-speed main) mode | | LV (low-voltage main) mode | | Unit |
|--|---------------|---|-----------------------|---------------------------|---------------|--------------------------|---------------|----------------------------|------|------|
| | | | | MIN. | MAX. | MIN. | MAX. | MIN. | MAX. | |
| SCKp cycle time | tkCY1 | tkCY1 ≥ 4/fCLK | 2.7 V ≤ EVDD0 ≤ 5.5 V | 125 | | 500 | | 1000 | | ns |
| | | | 2.4 V ≤ EVDD0 ≤ 5.5 V | 250 | | 500 | | 1000 | | ns |
| | | | 1.8 V ≤ EVDD0 ≤ 5.5 V | 500 | | 500 | | 1000 | | ns |
| | | | 1.7 V ≤ EVDD0 ≤ 5.5 V | 1000 | | 1000 | | 1000 | | ns |
| | | | 1.6 V ≤ EVDD0 ≤ 5.5 V | — | | 1000 | | 1000 | | ns |
| SCKp high-/low-level width | tkH1, tkL1 | 4.0 V ≤ EVDD0 ≤ 5.5 V | tkCY1/2 - 12 | | tkCY1/2 - 50 | | tkCY1/2 - 50 | | ns | |
| | | 2.7 V ≤ EVDD0 ≤ 5.5 V | tkCY1/2 - 18 | | tkCY1/2 - 50 | | tkCY1/2 - 50 | | ns | |
| | | 2.4 V ≤ EVDD0 ≤ 5.5 V | tkCY1/2 - 38 | | tkCY1/2 - 50 | | tkCY1/2 - 50 | | ns | |
| | | 1.8 V ≤ EVDD0 ≤ 5.5 V | tkCY1/2 - 50 | | tkCY1/2 - 50 | | tkCY1/2 - 50 | | ns | |
| | | 1.7 V ≤ EVDD0 ≤ 5.5 V | tkCY1/2 - 100 | | tkCY1/2 - 100 | | tkCY1/2 - 100 | | ns | |
| | | 1.6 V ≤ EVDD0 ≤ 5.5 V | — | | tkCY1/2 - 100 | | tkCY1/2 - 100 | | ns | |
| Slp setup time (to SCKp↑) Note 1 | tsIK1 | 4.0 V ≤ EVDD0 ≤ 5.5 V | 44 | | 110 | | 110 | | ns | |
| | | 2.7 V ≤ EVDD0 ≤ 5.5 V | 44 | | 110 | | 110 | | ns | |
| | | 2.4 V ≤ EVDD0 ≤ 5.5 V | 75 | | 110 | | 110 | | ns | |
| | | 1.8 V ≤ EVDD0 ≤ 5.5 V | 110 | | 110 | | 110 | | ns | |
| | | 1.7 V ≤ EVDD0 ≤ 5.5 V | 220 | | 220 | | 220 | | ns | |
| | | 1.6 V ≤ EVDD0 ≤ 5.5 V | — | | 220 | | 220 | | ns | |
| Slp hold time (from SCKp↑) Note 2 | tkSI1 | 1.7 V ≤ EVDD0 ≤ 5.5 V | 19 | | 19 | | 19 | | ns | |
| | | 1.6 V ≤ EVDD0 ≤ 5.5 V | — | | 19 | | 19 | | ns | |
| Delay time from SCKp↓ to SOp output Note 3 | tkSO1 | 1.7 V ≤ EVDD0 ≤ 5.5 V C = 30 pF Note 4 | | 25 | | 25 | | 25 | ns | |
| | | 1.6 V ≤ EVDD0 ≤ 5.5 V C = 30 pF Note 4 | | — | | 25 | | 25 | ns | |

Note 1. When DAPmn = 0 and CKPmn = 0, or DAPmn = 1 and CKPmn = 1. The Slp setup time becomes “to SCKp↓” when DAPmn = 0 and CKPmn = 1, or DAPmn = 1 and CKPmn = 0.

Note 2. When DAPmn = 0 and CKPmn = 0, or DAPmn = 1 and CKPmn = 1. The Slp hold time becomes “from SCKp↓” when DAPmn = 0 and CKPmn = 1, or DAPmn = 1 and CKPmn = 0.

Note 3. When DAPmn = 0 and CKPmn = 0, or DAPmn = 1 and CKPmn = 1. The delay time to SOp output becomes “from SCKp↑” when DAPmn = 0 and CKPmn = 1, or DAPmn = 1 and CKPmn = 0.

Note 4. C is the load capacitance of the SCKp and SOp output lines.

Caution Select the normal input buffer for the Slp pin and the normal output mode for the SOp pin and SCKp pin by using port input mode register g (PIMg) and port output mode register g (POMg).

Remark 1. p: CSI number (p = 00, 01, 10, 11, 20, 21, 30, 31), m: Unit number (m = 0, 1), n: Channel number (n = 0 to 3), g: PIM number (g = 0, 1, 3 to 5, 14)

Remark 2. fMCK: Serial array unit operation clock frequency
 (Operation clock to be set by the CKSmn bit of serial mode register mn (SMRmn). m: Unit number, n: Channel number (mn = 00 to 03, 10 to 13))

(4) During communication at same potential (CSI mode) (slave mode, SCKp... external clock input)**(TA = -40 to +85°C, 1.6 V ≤ EVDD0 = EVDD1 ≤ VDD ≤ 5.5 V, VSS = EVSS0 = EVSS1 = 0 V)****(1/2)**

| Parameter | Symbol | Conditions | | HS (high-speed main) mode | | LS (low-speed main) mode | | LV (low-voltage main) mode | | Unit |
|--|------------|-----------------------|-----------------------|---------------------------|-----------------|--------------------------|-----------------|----------------------------|------|------|
| | | | | MIN. | MAX. | MIN. | MAX. | MIN. | MAX. | |
| SCKp cycle time Note 5 | tkCY2 | 4.0 V ≤ EVDD0 ≤ 5.5 V | 20 MHz < fMCK | 8/fMCK | — | — | — | — | ns | |
| | | | fMCK ≤ 20 MHz | 6/fMCK | — | 6/fMCK | 6/fMCK | ns | | |
| | | 2.7 V ≤ EVDD0 ≤ 5.5 V | 16 MHz < fMCK | 8/fMCK | — | — | — | ns | | |
| | | | fMCK ≤ 16 MHz | 6/fMCK | — | 6/fMCK | 6/fMCK | ns | | |
| | | 2.4 V ≤ EVDD0 ≤ 5.5 V | | 6/fMCK and 500 | 6/fMCK and 500 | 6/fMCK and 500 | 6/fMCK and 500 | ns | | |
| | | 1.8 V ≤ EVDD0 ≤ 5.5 V | | 6/fMCK and 750 | 6/fMCK and 750 | 6/fMCK and 750 | 6/fMCK and 750 | ns | | |
| | | 1.7 V ≤ EVDD0 ≤ 5.5 V | | 6/fMCK and 1500 | 6/fMCK and 1500 | 6/fMCK and 1500 | 6/fMCK and 1500 | ns | | |
| | | 1.6 V ≤ EVDD0 ≤ 5.5 V | | — | 6/fMCK and 1500 | 6/fMCK and 1500 | 6/fMCK and 1500 | ns | | |
| SCKp high-/low-level width | tkH2, tkL2 | 4.0 V ≤ EVDD0 ≤ 5.5 V | | tkCY2/2 - 7 | tkCY2/2 - 7 | tkCY2/2 - 7 | tkCY2/2 - 7 | ns | | |
| | | 2.7 V ≤ EVDD0 ≤ 5.5 V | | tkCY2/2 - 8 | tkCY2/2 - 8 | tkCY2/2 - 8 | tkCY2/2 - 8 | ns | | |
| | | 1.8 V ≤ EVDD0 ≤ 5.5 V | | tkCY2/2 - 18 | tkCY2/2 - 18 | tkCY2/2 - 18 | tkCY2/2 - 18 | ns | | |
| | | 1.7 V ≤ EVDD0 ≤ 5.5 V | | tkCY2/2 - 66 | tkCY2/2 - 66 | tkCY2/2 - 66 | tkCY2/2 - 66 | ns | | |
| | | 1.6 V ≤ EVDD0 ≤ 5.5 V | | — | tkCY2/2 - 66 | tkCY2/2 - 66 | tkCY2/2 - 66 | ns | | |
| Slp setup time (to SCKp↑) Note 1 | tsIK2 | 2.7 V ≤ EVDD0 ≤ 5.5 V | | 1/fMCK + 20 | 1/fMCK + 30 | 1/fMCK + 30 | 1/fMCK + 30 | ns | | |
| | | 1.8 V ≤ EVDD0 ≤ 5.5 V | | 1/fMCK + 30 | 1/fMCK + 30 | 1/fMCK + 30 | 1/fMCK + 30 | ns | | |
| | | 1.7 V ≤ EVDD0 ≤ 5.5 V | | 1/fMCK + 40 | 1/fMCK + 40 | 1/fMCK + 40 | 1/fMCK + 40 | ns | | |
| | | 1.6 V ≤ EVDD0 ≤ 5.5 V | | — | 1/fMCK + 40 | 1/fMCK + 40 | 1/fMCK + 40 | ns | | |
| Slp hold time (from SCKp↑) Note 2 | tkSI2 | 1.8 V ≤ EVDD0 ≤ 5.5 V | | 1/fMCK + 31 | 1/fMCK + 31 | 1/fMCK + 31 | 1/fMCK + 31 | ns | | |
| | | 1.7 V ≤ EVDD0 ≤ 5.5 V | | 1/fMCK + 250 | 1/fMCK + 250 | 1/fMCK + 250 | 1/fMCK + 250 | ns | | |
| | | 1.6 V ≤ EVDD0 ≤ 5.5 V | | — | 1/fMCK + 250 | 1/fMCK + 250 | 1/fMCK + 250 | ns | | |
| Delay time from SCKp↓ to SOp output Note 3 | tkSO2 | C = 30 pF Note 4 | 2.7 V ≤ EVDD0 ≤ 5.5 V | 2/fMCK + 44 | 2/fMCK + 110 | 2/fMCK + 110 | 2/fMCK + 110 | ns | | |
| | | | 2.4 V ≤ EVDD0 ≤ 5.5 V | 2/fMCK + 75 | 2/fMCK + 110 | 2/fMCK + 110 | 2/fMCK + 110 | ns | | |
| | | | 1.8 V ≤ EVDD0 ≤ 5.5 V | 2/fMCK + 100 | 2/fMCK + 110 | 2/fMCK + 110 | 2/fMCK + 110 | ns | | |
| | | | 1.7 V ≤ EVDD0 ≤ 5.5 V | 2/fMCK + 220 | 2/fMCK + 220 | 2/fMCK + 220 | 2/fMCK + 220 | ns | | |
| | | | 1.6 V ≤ EVDD0 ≤ 5.5 V | — | 2/fMCK + 220 | 2/fMCK + 220 | 2/fMCK + 220 | ns | | |

Note 1. When DAPmn = 0 and CKPmn = 0, or DAPmn = 1 and CKPmn = 1. The Slp setup time becomes “to SCKp↓” when DAPmn = 0 and CKPmn = 1, or DAPmn = 1 and CKPmn = 0.

Note 2. When DAPmn = 0 and CKPmn = 0, or DAPmn = 1 and CKPmn = 1. The Slp hold time becomes “from SCKp↓” when DAPmn = 0 and CKPmn = 1, or DAPmn = 1 and CKPmn = 0.

Note 3. When DAPmn = 0 and CKPmn = 0, or DAPmn = 1 and CKPmn = 1. The delay time to SOp output becomes “from SCKp↑” when DAPmn = 0 and CKPmn = 1, or DAPmn = 1 and CKPmn = 0.

Note 4. C is the load capacitance of the SOp output lines.

Note 5. The maximum transfer rate when using the SNOOZE mode is 1 Mbps.

Caution Select the normal input buffer for the Slp pin and SCKp pin and the normal output mode for the SOp pin by using port input mode register g (PIMg) and port output mode register g (POMg).

Remark 1. p: CSI number (p = 00, 01, 10, 11, 20, 21, 30, 31), m: Unit number (m = 0, 1),
n: Channel number (n = 0 to 3), g: PIM number (g = 0, 1, 3 to 5, 14)

Remark 2. f_{MCK}: Serial array unit operation clock frequency
(Operation clock to be set by the CKSmn bit of serial mode register mn (SMRmn). m: Unit number,
n: Channel number (mn = 00 to 03, 10 to 13))

(4) During communication at same potential (CSI mode) (slave mode, SCKp... external clock input)

(TA = -40 to +85°C, 1.6 V ≤ EVDD0 = EVDD1 ≤ VDD ≤ 5.5 V, VSS = EVSS0 = EVSS1 = 0 V)

(2/2)

| Parameter | Symbol | Conditions | HS (high-speed main) mode | | LS (low-speed main) mode | | LV (low-voltage main) mode | | Unit | |
|------------------|--------|------------|---------------------------|--------------|--------------------------|--------------|----------------------------|--------------|------|----|
| | | | MIN. | MAX. | MIN. | MAX. | MIN. | MAX. | | |
| SSI00 setup time | tSSIK | DAPmn = 0 | 2.7 V ≤ EVDD0 ≤ 5.5 V | 120 | | 120 | | 120 | | ns |
| | | | 1.8 V ≤ EVDD0 ≤ 5.5 V | 200 | | 200 | | 200 | | ns |
| | | | 1.7 V ≤ EVDD0 ≤ 5.5 V | 400 | | 400 | | 400 | | ns |
| | | | 1.6 V ≤ EVDD0 ≤ 5.5 V | — | | 400 | | 400 | | ns |
| | | DAPmn = 1 | 2.7 V ≤ EVDD0 ≤ 5.5 V | 1/fMCK + 120 | | 1/fMCK + 120 | | 1/fMCK + 120 | | ns |
| | | | 1.8 V ≤ EVDD0 ≤ 5.5 V | 1/fMCK + 200 | | 1/fMCK + 200 | | 1/fMCK + 200 | | ns |
| | | | 1.7 V ≤ EVDD0 ≤ 5.5 V | 1/fMCK + 400 | | 1/fMCK + 400 | | 1/fMCK + 400 | | ns |
| | | | 1.6 V ≤ EVDD0 ≤ 5.5 V | — | | 1/fMCK + 400 | | 1/fMCK + 400 | | ns |
| SSI00 hold time | tkSSI | DAPmn = 0 | 2.7 V ≤ EVDD0 ≤ 5.5 V | 1/fMCK + 120 | | 1/fMCK + 120 | | 1/fMCK + 120 | | ns |
| | | | 1.8 V ≤ EVDD0 ≤ 5.5 V | 1/fMCK + 200 | | 1/fMCK + 200 | | 1/fMCK + 200 | | ns |
| | | | 1.7 V ≤ EVDD0 ≤ 5.5 V | 1/fMCK + 400 | | 1/fMCK + 400 | | 1/fMCK + 400 | | ns |
| | | | 1.6 V ≤ EVDD0 ≤ 5.5 V | — | | 1/fMCK + 400 | | 1/fMCK + 400 | | ns |
| | | DAPmn = 1 | 2.7 V ≤ EVDD0 ≤ 5.5 V | 120 | | 120 | | 120 | | ns |
| | | | 1.8 V ≤ EVDD0 ≤ 5.5 V | 200 | | 200 | | 200 | | ns |
| | | | 1.7 V ≤ EVDD0 ≤ 5.5 V | 400 | | 400 | | 400 | | ns |
| | | | 1.6 V ≤ EVDD0 ≤ 5.5 V | — | | 400 | | 400 | | ns |

Caution Select the normal input buffer for the SIp pin and SCKp pin and the normal output mode for the SOp pin by using port input mode register g (PIMg) and port output mode register g (POMg).

Remark p: CSI number (p = 00), m: Unit number (m = 0), n: Channel number (n = 0), g: PIM number (g = 3, 5)

CSI mode connection diagram (during communication at same potential)

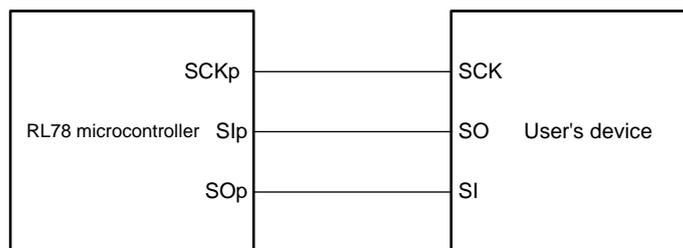

**CSI mode connection diagram (during communication at same potential)
(Slave Transmission of slave select input function (CSI00))**

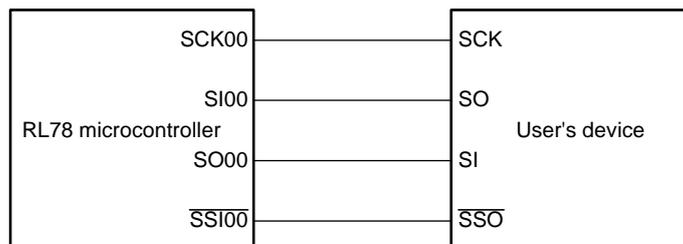

Remark 1. p: CSI number (p = 00, 01, 10, 11, 20, 21, 30, 31)

Remark 2. m: Unit number, n: Channel number (mn = 00 to 03, 10 to 13)

CSI mode serial transfer timing (during communication at same potential)
(When DAPmn = 0 and CKPmn = 0, or DAPmn = 1 and CKPmn = 1.)

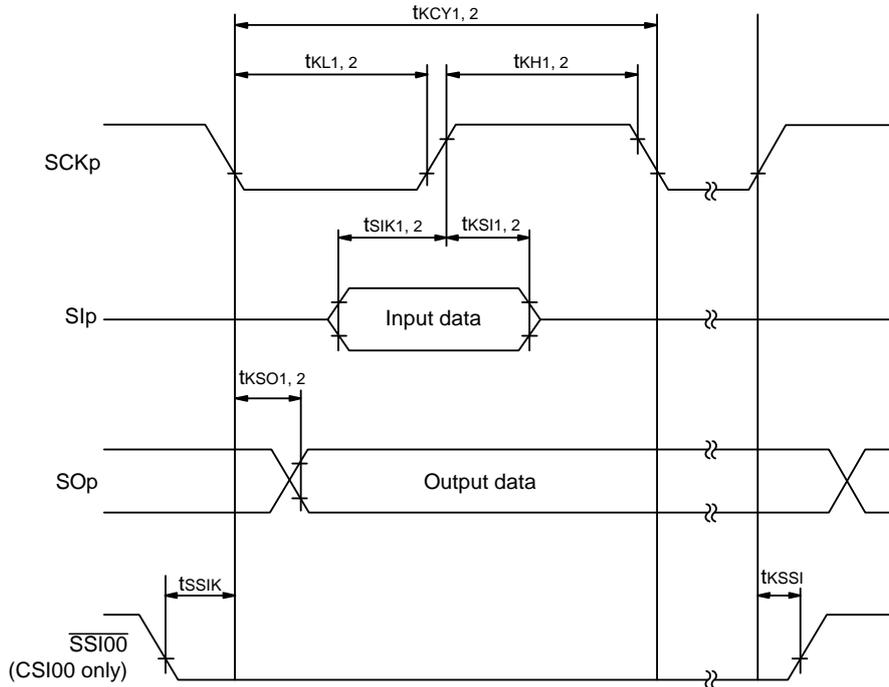

CSI mode serial transfer timing (during communication at same potential)
(When DAPmn = 0 and CKPmn = 1, or DAPmn = 1 and CKPmn = 0.)

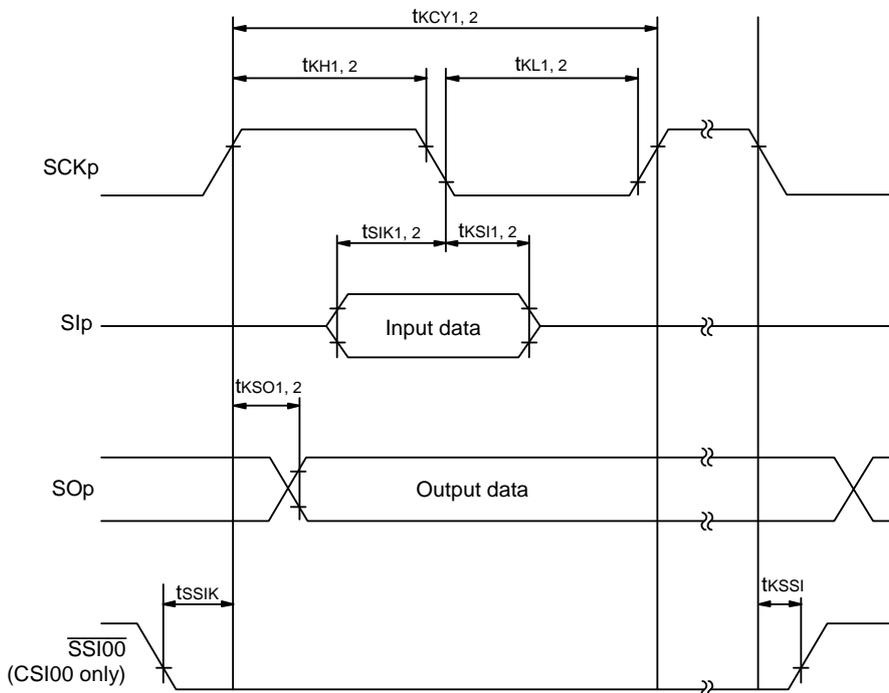

Remark 1. p: CSI number (p = 00, 01, 10, 11, 20, 21, 30, 31)

Remark 2. m: Unit number, n: Channel number (mn = 00 to 03, 10 to 13)

(5) During communication at same potential (simplified I²C mode)**(TA = -40 to +85°C, 1.6 V ≤ EVDD0 = EVDD1 ≤ VDD ≤ 5.5 V, VSS = EVSS0 = EVSS1 = 0 V)****(1/2)**

| Parameter | Symbol | Conditions | HS (high-speed main) mode | | LS (low-speed main) mode | | LV (low-voltage main) mode | | Unit |
|---------------------------|-------------------|---|---------------------------|-------------|--------------------------|------------|----------------------------|------------|------|
| | | | MIN. | MAX. | MIN. | MAX. | MIN. | MAX. | |
| SCLr clock frequency | f _{SCL} | 2.7 V ≤ EVDD0 ≤ 5.5 V, Cb = 50 pF, Rb = 2.7 kΩ | | 1000 Note 1 | | 400 Note 1 | | 400 Note 1 | kHz |
| | | 1.8 V ≤ EVDD0 ≤ 5.5 V, Cb = 100 pF, Rb = 3 kΩ | | 400 Note 1 | | 400 Note 1 | | 400 Note 1 | kHz |
| | | 1.8 V ≤ EVDD0 < 2.7 V, Cb = 100 pF, Rb = 5 kΩ | | 300 Note 1 | | 300 Note 1 | | 300 Note 1 | kHz |
| | | 1.7 V ≤ EVDD0 < 1.8 V, Cb = 100 pF, Rb = 5 kΩ | | 250 Note 1 | | 250 Note 1 | | 250 Note 1 | kHz |
| | | 1.6 V ≤ EVDD0 < 1.8 V, Cb = 100 pF, Rb = 5 kΩ | | — | | 250 Note 1 | | 250 Note 1 | kHz |
| Hold time when SCLr = "L" | t _{LOW} | 2.7 V ≤ EVDD0 ≤ 5.5 V, Cb = 50 pF, Rb = 2.7 kΩ | 475 | | 1150 | | 1150 | | ns |
| | | 1.8 V ≤ EVDD0 ≤ 5.5 V, Cb = 100 pF, Rb = 3 kΩ | 1150 | | 1150 | | 1150 | | ns |
| | | 1.8 V ≤ EVDD0 < 2.7 V, Cb = 100 pF, Rb = 5 kΩ | 1550 | | 1550 | | 1550 | | ns |
| | | 1.7 V ≤ EVDD0 < 1.8 V, Cb = 100 pF, Rb = 5 kΩ | 1850 | | 1850 | | 1850 | | ns |
| | | 1.6 V ≤ EVDD0 < 1.8 V, Cb = 100 pF, Rb = 5 kΩ | — | | 1850 | | 1850 | | ns |
| Hold time when SCLr = "H" | t _{HIGH} | 2.7 V ≤ EVDD0 ≤ 5.5 V, Cb = 50 pF, Rb = 2.7 kΩ | 475 | | 1150 | | 1150 | | ns |
| | | 1.8 V ≤ EVDD0 ≤ 5.5 V, Cb = 100 pF, Rb = 3 kΩ | 1150 | | 1150 | | 1150 | | ns |
| | | 1.8 V ≤ EVDD0 < 2.7 V, Cb = 100 pF, Rb = 5 kΩ | 1550 | | 1550 | | 1550 | | ns |
| | | 1.7 V ≤ EVDD0 < 1.8 V, Cb = 100 pF, Rb = 5 kΩ | 1850 | | 1850 | | 1850 | | ns |
| | | 1.6 V ≤ EVDD0 < 1.8 V, Cb = 100 pF, Rb = 5 kΩ | — | | 1850 | | 1850 | | ns |

(Notes and Caution are listed on the next page, and Remarks are listed on the page after the next page.)

(5) During communication at same potential (simplified I²C mode)**(TA = -40 to +85°C, 1.6 V ≤ EVDD0 = EVDD1 ≤ VDD ≤ 5.5 V, VSS = EVSS0 = EVSS1 = 0 V)****(2/2)**

| Parameter | Symbol | Conditions | HS (high-speed main) mode | | LS (low-speed main) mode | | LV (low-voltage main) mode | | Unit |
|-------------------------------|----------|--|---------------------------|------|--------------------------|------|----------------------------|------|------|
| | | | MIN. | MAX. | MIN. | MAX. | MIN. | MAX. | |
| Data setup time (reception) | tsu: DAT | 2.7 V ≤ EVDD0 ≤ 5.5 V, Cb = 50 pF, Rb = 2.7 kΩ | 1/fmck + 85 Note 2 | | 1/fmck + 145 Note 2 | | 1/fmck + 145 Note 2 | | ns |
| | | 1.8 V ≤ EVDD0 ≤ 5.5 V, Cb = 100 pF, Rb = 3 kΩ | 1/fmck + 145 Note 2 | | 1/fmck + 145 Note 2 | | 1/fmck + 145 Note 2 | | ns |
| | | 1.8 V ≤ EVDD0 < 2.7 V, Cb = 100 pF, Rb = 5 kΩ | 1/fmck + 230 Note 2 | | 1/fmck + 230 Note 2 | | 1/fmck + 230 Note 2 | | ns |
| | | 1.7 V ≤ EVDD0 < 1.8 V, Cb = 100 pF, Rb = 5 kΩ | 1/fmck + 290 Note 2 | | 1/fmck + 290 Note 2 | | 1/fmck + 290 Note 2 | | ns |
| | | 1.6 V ≤ EVDD0 < 1.8 V, Cb = 100 pF, Rb = 5 kΩ | — | | 1/fmck + 290 Note 2 | | 1/fmck + 290 Note 2 | | ns |
| Data hold time (transmission) | thd: DAT | 2.7 V ≤ EVDD0 ≤ 5.5 V, Cb = 50 pF, Rb = 2.7 kΩ | 0 | 305 | 0 | 305 | 0 | 305 | ns |
| | | 1.8 V ≤ EVDD0 ≤ 5.5 V, Cb = 100 pF, Rb = 3 kΩ | 0 | 355 | 0 | 355 | 0 | 355 | ns |
| | | 1.8 V ≤ EVDD0 < 2.7 V, Cb = 100 pF, Rb = 5 kΩ | 0 | 405 | 0 | 405 | 0 | 405 | ns |
| | | 1.7 V ≤ EVDD0 < 1.8 V, Cb = 100 pF, Rb = 5 kΩ | 0 | 405 | 0 | 405 | 0 | 405 | ns |
| | | 1.6 V ≤ EVDD0 < 1.8 V, Cb = 100 pF, Rb = 5 kΩ | — | | 0 | 405 | 0 | 405 | ns |

Note 1. The value must also be equal to or less than fmck/4.

Note 2. Set the fmck value to keep the hold time of SCLr = "L" and SCLr = "H".

Caution Select the normal input buffer and the N-ch open drain output (V_{DD} tolerance (for the 30- to 52-pin products)/EV_{DD} tolerance (for the 64- to 100-pin products)) mode for the SDAr pin and the normal output mode for the SCLr pin by using port input mode register g (PIMg) and port output mode register h (POMh).

(Remarks are listed on the next page.)

Simplified I²C mode connection diagram (during communication at same potential)

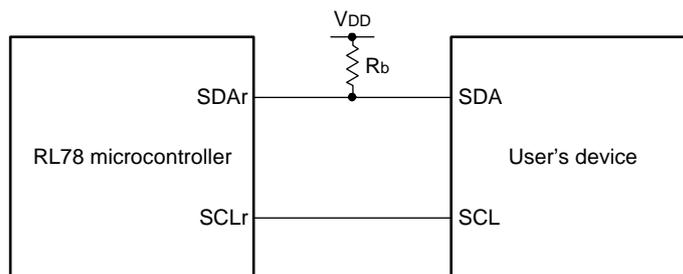

Simplified I²C mode serial transfer timing (during communication at same potential)

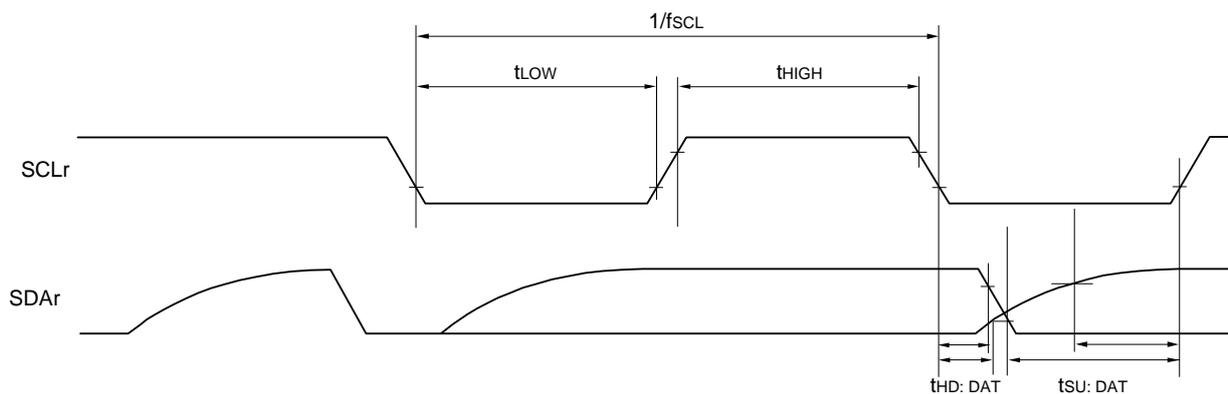

Remark 1. R_b[Ω]: Communication line (SDAr) pull-up resistance, C_b[F]: Communication line (SDAr, SCLr) load capacitance

Remark 2. r: IIC number (r = 00, 01, 10, 11, 20, 21, 30, 31), g: PIM number (g = 0, 1, 3 to 5, 14),
h: POM number (h = 0, 1, 3 to 5, 7, 14)

Remark 3. f_{MCK}: Serial array unit operation clock frequency
(Operation clock to be set by the CKS_{mn} bit of serial mode register mn (SMR_{mn}). m: Unit number (m = 0, 1),
n: Channel number (n = 0 to 3), mn = 00 to 03, 10 to 13)

(6) Communication at different potential (1.8 V, 2.5 V, 3 V) (UART mode)**(TA = -40 to +85°C, 1.6 V ≤ EVDD0 = EVDD1 ≤ VDD ≤ 5.5 V, VSS = EVSS0 = EVSS1 = 0 V)****(1/2)**

| Parameter | Symbol | Conditions | HS (high-speed main) mode | | LS (low-speed main) mode | | LV (low-voltage main) mode | | Unit | |
|---------------|--------|------------|--|------|--------------------------|------|----------------------------|------|----------------------|------|
| | | | MIN. | MAX. | MIN. | MAX. | MIN. | MAX. | | |
| Transfer rate | | reception | 4.0 V ≤ EVDD0 ≤ 5.5 V, 2.7 V ≤ Vb ≤ 4.0 V | | fMCK/6 Note 1 | | fMCK/6 Note 1 | | fMCK/6 Note 1 | bps |
| | | | Theoretical value of the maximum transfer rate fMCK = fCLK Note 4 | | 5.3 | | 1.3 | | 0.6 | Mbps |
| | | | 2.7 V ≤ EVDD0 < 4.0 V, 2.3 V ≤ Vb ≤ 2.7 V | | fMCK/6 Note 1 | | fMCK/6 Note 1 | | fMCK/6 Note 1 | bps |
| | | | Theoretical value of the maximum transfer rate fMCK = fCLK Note 4 | | 5.3 | | 1.3 | | 0.6 | Mbps |
| | | | 1.8 V ≤ EVDD0 < 3.3 V, 1.6 V ≤ Vb ≤ 2.0 V | | fMCK/6 Notes 1, 2, 3 | | fMCK/6 Notes 1, 2 | | fMCK/6 Notes 1, 2 | bps |
| | | | Theoretical value of the maximum transfer rate fMCK = fCLK Note 4 | | 5.3 | | 1.3 | | 0.6 | Mbps |

Note 1. Transfer rate in the SNOOZE mode is 4800 bps only.

However, the SNOOZE mode cannot be used when FRQSEL4 = 1.

Note 2. Use it with EVDD0 ≥ Vb.

Note 3. The following conditions are required for low voltage interface when EVDD0 < VDD.

2.4 V ≤ EVDD0 < 2.7 V: MAX. 2.6 Mbps

1.8 V ≤ EVDD0 < 2.4 V: MAX. 1.3 Mbps

Note 4. The maximum operating frequencies of the CPU/peripheral hardware clock (fCLK) are:

HS (high-speed main) mode: 32 MHz (2.7 V ≤ VDD ≤ 5.5 V)

16 MHz (2.4 V ≤ VDD ≤ 5.5 V)

LS (low-speed main) mode: 8 MHz (1.8 V ≤ VDD ≤ 5.5 V)

LV (low-voltage main) mode: 4 MHz (1.6 V ≤ VDD ≤ 5.5 V)

Caution Select the TTL input buffer for the RxDq pin and the N-ch open drain output (VDD tolerance (for the 30- to 52-pin products)/EVDD tolerance (for the 64- to 100-pin products)) mode for the TxDq pin by using port input mode register g (PIMg) and port output mode register g (POMg). For VIH and VIL, see the DC characteristics with TTL input buffer selected.

Remark 1. Vb [V]: Communication line voltage

Remark 2. q: UART number (q = 0 to 3), g: PIM and POM number (g = 0, 1, 5, 14)

Remark 3. fMCK: Serial array unit operation clock frequency

(Operation clock to be set by the CKSmn bit of serial mode register mn (SMRmn). m: Unit number,

n: Channel number (mn = 00 to 03, 10 to 13)

Remark 4. UART2 cannot communicate at different potential when bit 1 (PIOR01) of peripheral I/O redirection register 0 (PIOR0) is 1.

(6) Communication at different potential (1.8 V, 2.5 V, 3 V) (UART mode)**(TA = -40 to +85°C, 1.6 V ≤ EVDD0 = EVDD1 ≤ VDD ≤ 5.5 V, VSS = EVSS0 = EVSS1 = 0 V)****(2/2)**

| Parameter | Symbol | Conditions | HS (high-speed main) mode | | LS (low-speed main) mode | | LV (low-voltage main) mode | | Unit | |
|---------------|--------|--------------|--|------|--------------------------|------|----------------------------|------|-------------|------|
| | | | MIN. | MAX. | MIN. | MAX. | MIN. | MAX. | | |
| Transfer rate | | transmission | 4.0 V ≤ EVDD0 ≤ 5.5 V, 2.7 V ≤ Vb ≤ 4.0 V | | Note 1 | | Note 1 | | Note 1 | bps |
| | | | Theoretical value of the maximum transfer rate Cb = 50 pF, Rb = 1.4 kΩ, Vb = 2.7 V | | 2.8 Note 2 | | 2.8 Note 2 | | 2.8 Note 2 | Mbps |
| | | | 2.7 V ≤ EVDD0 < 4.0 V, 2.3 V ≤ Vb ≤ 2.7 V | | Note 3 | | Note 3 | | Note 3 | bps |
| | | | Theoretical value of the maximum transfer rate Cb = 50 pF, Rb = 2.7 kΩ, Vb = 2.3 V | | 1.2 Note 4 | | 1.2 Note 4 | | 1.2 Note 4 | Mbps |
| | | | 1.8 V ≤ EVDD0 < 3.3 V, 1.6 V ≤ Vb ≤ 2.0 V | | Notes 5, 6 | | Notes 5, 6 | | Notes 5, 6 | bps |
| | | | Theoretical value of the maximum transfer rate Cb = 50 pF, Rb = 5.5 kΩ, Vb = 1.6 V | | 0.43 Note 7 | | 0.43 Note 7 | | 0.43 Note 7 | Mbps |

Note 1. The smaller maximum transfer rate derived by using $f_{MCK}/6$ or the following expression is the valid maximum transfer rate. Expression for calculating the transfer rate when $4.0\text{ V} \leq \text{EVDD}_0 \leq 5.5\text{ V}$ and $2.7\text{ V} \leq V_b \leq 4.0\text{ V}$

$$\text{Maximum transfer rate} = \frac{1}{\{-C_b \times R_b \times \ln(1 - \frac{2.2}{V_b})\} \times 3} \text{ [bps]}$$

$$\text{Baud rate error (theoretical value)} = \frac{\frac{1}{\text{Transfer rate} \times 2} - \{-C_b \times R_b \times \ln(1 - \frac{2.2}{V_b})\}}{(\frac{1}{\text{Transfer rate}}) \times \text{Number of transferred bits}} \times 100 \text{ [%]}$$

* This value is the theoretical value of the relative difference between the transmission and reception sides

Note 2. This value as an example is calculated when the conditions described in the "Conditions" column are met. Refer to **Note 1** above to calculate the maximum transfer rate under conditions of the customer.

Note 3. The smaller maximum transfer rate derived by using $f_{MCK}/6$ or the following expression is the valid maximum transfer rate.

Expression for calculating the transfer rate when $2.7\text{ V} \leq \text{EVDD}_0 < 4.0\text{ V}$ and $2.3\text{ V} \leq V_b \leq 2.7\text{ V}$

$$\text{Maximum transfer rate} = \frac{1}{\{-C_b \times R_b \times \ln(1 - \frac{2.0}{V_b})\} \times 3} \text{ [bps]}$$

$$\text{Baud rate error (theoretical value)} = \frac{\frac{1}{\text{Transfer rate} \times 2} - \{-C_b \times R_b \times \ln(1 - \frac{2.0}{V_b})\}}{(\frac{1}{\text{Transfer rate}}) \times \text{Number of transferred bits}} \times 100 \text{ [%]}$$

* This value is the theoretical value of the relative difference between the transmission and reception sides

Note 4. This value as an example is calculated when the conditions described in the "Conditions" column are met. Refer to **Note 3** above to calculate the maximum transfer rate under conditions of the customer.

Note 5. Use it with $EV_{DD0} \geq V_b$.

Note 6. The smaller maximum transfer rate derived by using $f_{mck}/6$ or the following expression is the valid maximum transfer rate.

Expression for calculating the transfer rate when $1.8 \text{ V} \leq EV_{DD0} < 3.3 \text{ V}$ and $1.6 \text{ V} \leq V_b \leq 2.0 \text{ V}$

$$\text{Maximum transfer rate} = \frac{1}{\{-C_b \times R_b \times \ln(1 - \frac{1.5}{V_b})\} \times 3} \text{ [bps]}$$

$$\text{Baud rate error (theoretical value)} = \frac{\frac{1}{\text{Transfer rate} \times 2} - \{-C_b \times R_b \times \ln(1 - \frac{1.5}{V_b})\}}{\left(\frac{1}{\text{Transfer rate}}\right) \times \text{Number of transferred bits}} \times 100 \text{ [%]}$$

* This value is the theoretical value of the relative difference between the transmission and reception sides

Note 7. This value as an example is calculated when the conditions described in the "Conditions" column are met. Refer to **Note 6** above to calculate the maximum transfer rate under conditions of the customer.

Caution Select the TTL input buffer for the RxDq pin and the N-ch open drain output (V_{DD} tolerance (for the 30- to 52-pin products)/EV_{DD} tolerance (for the 64- to 100-pin products)) mode for the TxDq pin by using port input mode register g (PIMg) and port output mode register g (POMg). For V_{IH} and V_{IL}, see the DC characteristics with TTL input buffer selected.

(Remarks are listed on the next page.)

UART mode connection diagram (during communication at different potential)

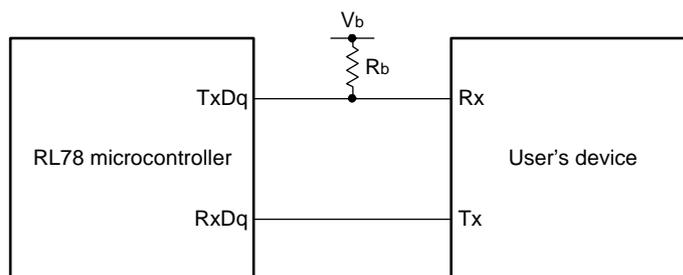

UART mode bit width (during communication at different potential) (reference)

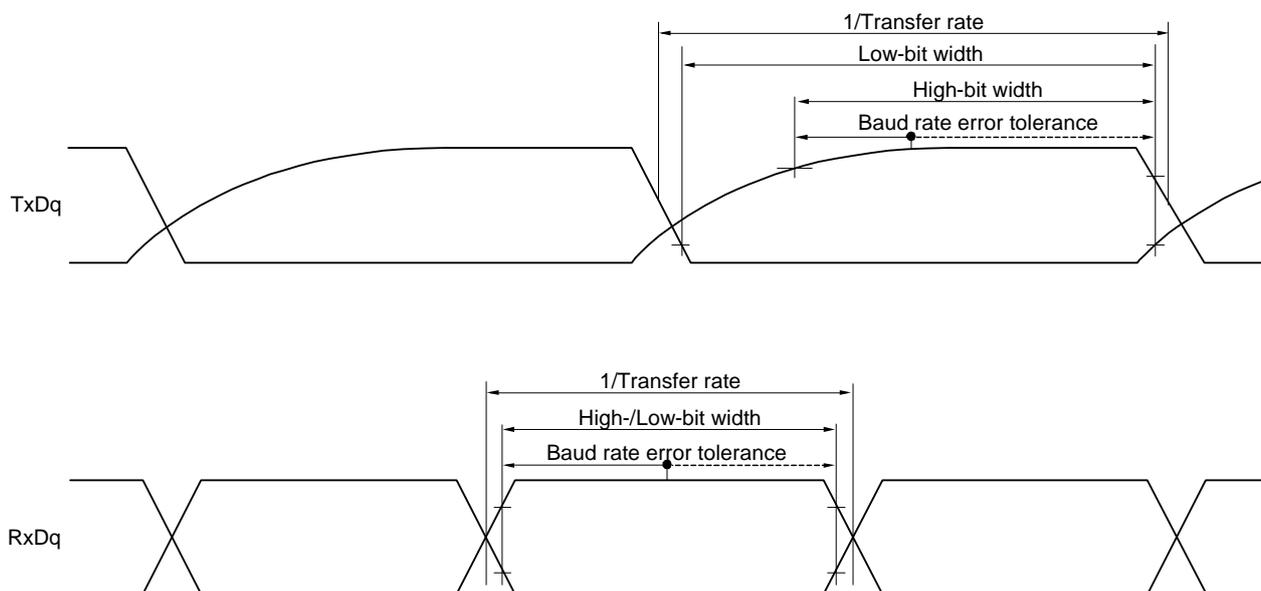

- Remark 1.** R_b[Ω]: Communication line (TxDq) pull-up resistance,
C_b[F]: Communication line (TxDq) load capacitance, V_b[V]: Communication line voltage
- Remark 2.** q: UART number (q = 0 to 3), g: PIM and POM number (g = 0, 1, 5, 14)
- Remark 3.** f_{MCK}: Serial array unit operation clock frequency
(Operation clock to be set by the CKSmn bit of serial mode register mn (SMRmn).
m: Unit number, n: Channel number (mn = 00 to 03, 10 to 13))
- Remark 4.** UART2 cannot communicate at different potential when bit 1 (PIOR01) of peripheral I/O redirection register 0 (PIOR0) is 1.

(7) Communication at different potential (2.5 V, 3 V) (CSI mode) (master mode, SCKp... internal clock output, corresponding CSI00 only)**(TA = -40 to +85°C, 2.7 V ≤ EVDD0 = EVDD1 ≤ VDD ≤ 5.5 V, VSS = EVSS0 = EVSS1 = 0 V)****(1/2)**

| Parameter | Symbol | Conditions | HS (high-speed main) mode | | LS (low-speed main) mode | | LV (low-voltage main) mode | | Unit |
|---|--------|--|---------------------------|------|--------------------------|------|----------------------------|------|------|
| | | | MIN. | MAX. | MIN. | MAX. | MIN. | MAX. | |
| SCKp cycle time | tkCY1 | tkCY1 ≥ 2/fCLK 4.0 V ≤ EVDD0 ≤ 5.5 V, 2.7 V ≤ Vb ≤ 4.0 V, Cb = 20 pF, Rb = 1.4 kΩ | 200 | | 1150 | | 1150 | | ns |
| | | | 300 | | 1150 | | 1150 | | ns |
| SCKp high-level width | tkH1 | 4.0 V ≤ EVDD0 ≤ 5.5 V, 2.7 V ≤ Vb ≤ 4.0 V, Cb = 20 pF, Rb = 1.4 kΩ | tkCY1/2 - 50 | | tkCY1/2 - 50 | | tkCY1/2 - 50 | | ns |
| | | 2.7 V ≤ EVDD0 < 4.0 V, 2.3 V ≤ Vb ≤ 2.7 V, Cb = 20 pF, Rb = 2.7 kΩ | tkCY1/2 - 120 | | tkCY1/2 - 120 | | tkCY1/2 - 120 | | ns |
| SCKp low-level width | tkL1 | 4.0 V ≤ EVDD0 ≤ 5.5 V, 2.7 V ≤ Vb ≤ 4.0 V, Cb = 20 pF, Rb = 1.4 kΩ | tkCY1/2 - 7 | | tkCY1/2 - 50 | | tkCY1/2 - 50 | | ns |
| | | 2.7 V ≤ EVDD0 < 4.0 V, 2.3 V ≤ Vb ≤ 2.7 V, Cb = 20 pF, Rb = 2.7 kΩ | tkCY1/2 - 10 | | tkCY1/2 - 50 | | tkCY1/2 - 50 | | ns |
| Slp setup time (to SCKp↑) ^{Note 1} | tSIK1 | 4.0 V ≤ EVDD0 ≤ 5.5 V, 2.7 V ≤ Vb ≤ 4.0 V, Cb = 20 pF, Rb = 1.4 kΩ | 58 | | 479 | | 479 | | ns |
| | | 2.7 V ≤ EVDD0 < 4.0 V, 2.3 V ≤ Vb ≤ 2.7 V, Cb = 20 pF, Rb = 2.7 kΩ | 121 | | 479 | | 479 | | ns |
| Slp hold time (from SCKp↑) ^{Note 1} | tKSI1 | 4.0 V ≤ EVDD0 ≤ 5.5 V, 2.7 V ≤ Vb ≤ 4.0 V, Cb = 20 pF, Rb = 1.4 kΩ | 10 | | 10 | | 10 | | ns |
| | | 2.7 V ≤ EVDD0 < 4.0 V, 2.3 V ≤ Vb ≤ 2.7 V, Cb = 20 pF, Rb = 2.7 kΩ | 10 | | 10 | | 10 | | ns |
| Delay time from SCKp↓ to SOp output ^{Note 1} | tkSO1 | 4.0 V ≤ EVDD0 ≤ 5.5 V, 2.7 V ≤ Vb ≤ 4.0 V, Cb = 20 pF, Rb = 1.4 kΩ | | 60 | | 60 | | 60 | ns |
| | | 2.7 V ≤ EVDD0 < 4.0 V, 2.3 V ≤ Vb ≤ 2.7 V, Cb = 20 pF, Rb = 2.7 kΩ | | 130 | | 130 | | 130 | ns |

(Notes, Caution, and Remarks are listed on the next page.)

(7) Communication at different potential (2.5 V, 3 V) (CSI mode) (master mode, SCKp... internal clock output, corresponding CSI00 only)**(TA = -40 to +85°C, 2.7 V ≤ EVDD0 = EVDD1 ≤ VDD ≤ 5.5 V, VSS = EVSS0 = EVSS1 = 0 V)****(2/2)**

| Parameter | Symbol | Conditions | HS (high-speed main) mode | | LS (low-speed main) mode | | LV (low-voltage main) mode | | Unit |
|---|--------|--|---------------------------|------|--------------------------|------|----------------------------|------|------|
| | | | MIN. | MAX. | MIN. | MAX. | MIN. | MAX. | |
| Slp setup time (to SCKp↓) Note 2 | tsIK1 | 4.0 V ≤ EVDD0 ≤ 5.5 V, 2.7 V ≤ Vb ≤ 4.0 V, Cb = 20 pF, Rb = 1.4 kΩ | 23 | | 110 | | 110 | | ns |
| | | 2.7 V ≤ EVDD0 < 4.0 V, 2.3 V ≤ Vb ≤ 2.7 V, Cb = 20 pF, Rb = 2.7 kΩ | 33 | | 110 | | 110 | | ns |
| Slp hold time (from SCKp↓) Note 2 | tKSI1 | 4.0 V ≤ EVDD0 ≤ 5.5 V, 2.7 V ≤ Vb ≤ 4.0 V, Cb = 20 pF, Rb = 1.4 kΩ | 10 | | 10 | | 10 | | ns |
| | | 2.7 V ≤ EVDD0 < 4.0 V, 2.3 V ≤ Vb ≤ 2.7 V, Cb = 20 pF, Rb = 2.7 kΩ | 10 | | 10 | | 10 | | ns |
| Delay time from SCKp↑ to SOp output Note 2 | tKSO1 | 4.0 V ≤ EVDD0 ≤ 5.5 V, 2.7 V ≤ Vb ≤ 4.0 V, Cb = 20 pF, Rb = 1.4 kΩ | | 10 | | 10 | | 10 | ns |
| | | 2.7 V ≤ EVDD0 < 4.0 V, 2.3 V ≤ Vb ≤ 2.7 V, Cb = 20 pF, Rb = 2.7 kΩ | | 10 | | 10 | | 10 | ns |

Note 1. When DAPmn = 0 and CKPmn = 0, or DAPmn = 1 and CKPmn = 1.

Note 2. When DAPmn = 0 and CKPmn = 1, or DAPmn = 1 and CKPmn = 0.

Caution Select the TTL input buffer for the Slp pin and the N-ch open drain output (VDD tolerance (for the 30- to 52-pin products)/EVDD tolerance (for the 64- to 100-pin products)) mode for the SOp pin and SCKp pin by using port input mode register g (PIMg) and port output mode register g (POMg). For VIH and VIL, see the DC characteristics with TTL input buffer selected.

Remark 1. Rb[Ω]: Communication line (SCKp, SOp) pull-up resistance, Cb[F]: Communication line (SCKp, SOp) load capacitance, Vb[V]: Communication line voltage

Remark 2. p: CSI number (p = 00), m: Unit number (m = 0), n: Channel number (n = 0), g: PIM and POM number (g = 3, 5)

Remark 3. fMCK: Serial array unit operation clock frequency

(Operation clock to be set by the CKSmn bit of serial mode register mn (SMRmn). m: Unit number, n: Channel number (mn = 00))

Remark 4. This value is valid only when CSI00's peripheral I/O redirect function is not used.

(8) Communication at different potential (1.8 V, 2.5 V, 3 V) (CSI mode) (master mode, SCKp... internal clock output)**(TA = -40 to +85°C, 1.8 V ≤ EVDD0 = EVDD1 ≤ VDD ≤ 5.5 V, VSS = EVSS0 = EVSS1 = 0 V)****(1/3)**

| Parameter | Symbol | Conditions | HS (high-speed main) mode | | LS (low-speed main) mode | | LV (low-voltage main) mode | | Unit |
|-----------------------|--------|--|---------------------------|------|--------------------------|------|----------------------------|------|------|
| | | | MIN. | MAX. | MIN. | MAX. | MIN. | MAX. | |
| SCKp cycle time | tkCY1 | tkCY1 ≥ 4/fCLK 4.0 V ≤ EVDD0 ≤ 5.5 V, 2.7 V ≤ Vb ≤ 4.0 V, Cb = 30 pF, Rb = 1.4 kΩ | 300 | | 1150 | | 1150 | | ns |
| | | | 500 | | 1150 | | 1150 | | ns |
| | | | 1150 | | 1150 | | 1150 | | ns |
| SCKp high-level width | tkH1 | 4.0 V ≤ EVDD0 ≤ 5.5 V, 2.7 V ≤ Vb ≤ 4.0 V, Cb = 30 pF, Rb = 1.4 kΩ | tkCY1/2 - 75 | | tkCY1/2 - 75 | | tkCY1/2 - 75 | | ns |
| | | | tkCY1/2 - 170 | | tkCY1/2 - 170 | | tkCY1/2 - 170 | | ns |
| | | | tkCY1/2 - 458 | | tkCY1/2 - 458 | | tkCY1/2 - 458 | | ns |
| SCKp low-level width | tkL1 | 4.0 V ≤ EVDD0 ≤ 5.5 V, 2.7 V ≤ Vb ≤ 4.0 V, Cb = 30 pF, Rb = 1.4 kΩ | tkCY1/2 - 12 | | tkCY1/2 - 50 | | tkCY1/2 - 50 | | ns |
| | | | tkCY1/2 - 18 | | tkCY1/2 - 50 | | tkCY1/2 - 50 | | ns |
| | | | tkCY1/2 - 50 | | tkCY1/2 - 50 | | tkCY1/2 - 50 | | ns |

Note Use it with EVDD0 ≥ Vb.

Caution Select the TTL input buffer for the Slp pin and the N-ch open drain output (VDD tolerance (for the 30- to 52-pin products)/EVDD tolerance (for the 64- to 100-pin products)) mode for the SOp pin and SCKp pin by using port input mode register g (PIMg) and port output mode register g (POMg). For VIH and VIL, see the DC characteristics with TTL input buffer selected.

(Remarks are listed two pages after the next page.)

(8) Communication at different potential (1.8 V, 2.5 V, 3 V) (CSI mode) (master mode, SCKp... internal clock output)**(TA = -40 to +85°C, 1.8 V ≤ EVDD0 = EVDD1 ≤ VDD ≤ 5.5 V, VSS = EVSS0 = EVSS1 = 0 V)****(2/3)**

| Parameter | Symbol | Conditions | HS (high-speed main) mode | | LS (low-speed main) mode | | LV (low-voltage main) mode | | Unit |
|---|--------|---|---------------------------|------|--------------------------|------|----------------------------|------|------|
| | | | MIN. | MAX. | MIN. | MAX. | MIN. | MAX. | |
| Slp setup time (to SCKp↑) Note 1 | tSIK1 | 4.0 V ≤ EVDD0 ≤ 5.5 V, 2.7 V ≤ Vb ≤ 4.0 V, Cb = 30 pF, Rb = 1.4 kΩ | 81 | | 479 | | 479 | | ns |
| | | 2.7 V ≤ EVDD0 < 4.0 V, 2.3 V ≤ Vb ≤ 2.7 V, Cb = 30 pF, Rb = 2.7 kΩ | 177 | | 479 | | 479 | | ns |
| | | 1.8 V ≤ EVDD0 < 3.3 V, 1.6 V ≤ Vb ≤ 2.0 V Note 2, Cb = 30 pF, Rb = 5.5 kΩ | 479 | | 479 | | 479 | | ns |
| Slp hold time (from SCKp↑) Note 1 | tKSI1 | 4.0 V ≤ EVDD0 ≤ 5.5 V, 2.7 V ≤ Vb ≤ 4.0 V, Cb = 30 pF, Rb = 1.4 kΩ | 19 | | 19 | | 19 | | ns |
| | | 2.7 V ≤ EVDD0 < 4.0 V, 2.3 V ≤ Vb ≤ 2.7 V, Cb = 30 pF, Rb = 2.7 kΩ | 19 | | 19 | | 19 | | ns |
| | | 1.8 V ≤ EVDD0 < 3.3 V, 1.6 V ≤ Vb ≤ 2.0 V Note 2, Cb = 30 pF, Rb = 5.5 kΩ | 19 | | 19 | | 19 | | ns |
| Delay time from SCKp↓ to SOp output Note 1 | tKSO1 | 4.0 V ≤ EVDD0 ≤ 5.5 V, 2.7 V ≤ Vb ≤ 4.0 V, Cb = 30 pF, Rb = 1.4 kΩ | | 100 | | 100 | | 100 | ns |
| | | 2.7 V ≤ EVDD0 < 4.0 V, 2.3 V ≤ Vb ≤ 2.7 V, Cb = 30 pF, Rb = 2.7 kΩ | | 195 | | 195 | | 195 | ns |
| | | 1.8 V ≤ EVDD0 < 3.3 V, 1.6 V ≤ Vb ≤ 2.0 V Note 2, Cb = 30 pF, Rb = 5.5 kΩ | | 483 | | 483 | | 483 | ns |

Note 1. When DAPmn = 0 and CKPmn = 0, or DAPmn = 1 and CKPmn = 1.**Note 2.** Use it with EVDD0 ≥ Vb.

Caution Select the TTL input buffer for the Slp pin and the N-ch open drain output (VDD tolerance (for the 30- to 52-pin products)/EVDD tolerance (for the 64- to 100-pin products)) mode for the SOp pin and SCKp pin by using port input mode register g (PIMg) and port output mode register g (POMg). For VIH and VIL, see the DC characteristics with TTL input buffer selected.

(Remarks are listed on the page after the next page.)

(8) Communication at different potential (1.8 V, 2.5 V, 3 V) (CSI mode) (master mode, SCKp... internal clock output)**(TA = -40 to +85°C, 1.8 V ≤ EVDD0 = EVDD1 ≤ VDD ≤ 5.5 V, VSS = EVSS0 = EVSS1 = 0 V)****(3/3)**

| Parameter | Symbol | Conditions | HS (high-speed main) mode | | LS (low-speed main) mode | | LV (low-voltage main) mode | | Unit |
|---|--------|---|---------------------------|------|--------------------------|------|----------------------------|------|------|
| | | | MIN. | MAX. | MIN. | MAX. | MIN. | MAX. | |
| Slp setup time (to SCKp↓) Note 1 | tSIK1 | 4.0 V ≤ EVDD0 ≤ 5.5 V, 2.7 V ≤ Vb ≤ 4.0 V, Cb = 30 pF, Rb = 1.4 kΩ | 44 | | 110 | | 110 | | ns |
| | | 2.7 V ≤ EVDD0 < 4.0 V, 2.3 V ≤ Vb ≤ 2.7 V, Cb = 30 pF, Rb = 2.7 kΩ | 44 | | 110 | | 110 | | ns |
| | | 1.8 V ≤ EVDD0 < 3.3 V, 1.6 V ≤ Vb ≤ 2.0 V Note 2, Cb = 30 pF, Rb = 5.5 kΩ | 110 | | 110 | | 110 | | ns |
| Slp hold time (from SCKp↓) Note 1 | tKSI1 | 4.0 V ≤ EVDD0 ≤ 5.5 V, 2.7 V ≤ Vb ≤ 4.0 V, Cb = 30 pF, Rb = 1.4 kΩ | 19 | | 19 | | 19 | | ns |
| | | 2.7 V ≤ EVDD0 < 4.0 V, 2.3 V ≤ Vb ≤ 2.7 V, Cb = 30 pF, Rb = 2.7 kΩ | 19 | | 19 | | 19 | | ns |
| | | 1.8 V ≤ EVDD0 < 3.3 V, 1.6 V ≤ Vb ≤ 2.0 V Note 2, Cb = 30 pF, Rb = 5.5 kΩ | 19 | | 19 | | 19 | | ns |
| Delay time from SCKp↑ to SOp output Note 1 | tKSO1 | 4.0 V ≤ EVDD0 ≤ 5.5 V, 2.7 V ≤ Vb ≤ 4.0 V, Cb = 30 pF, Rb = 1.4 kΩ | | 25 | | 25 | | 25 | ns |
| | | 2.7 V ≤ EVDD0 < 4.0 V, 2.3 V ≤ Vb ≤ 2.7 V, Cb = 30 pF, Rb = 2.7 kΩ | | 25 | | 25 | | 25 | ns |
| | | 1.8 V ≤ EVDD0 < 3.3 V, 1.6 V ≤ Vb ≤ 2.0 V Note 2, Cb = 30 pF, Rb = 5.5 kΩ | | 25 | | 25 | | 25 | ns |

Note 1. When DAPmn = 0 and CKPmn = 1, or DAPmn = 1 and CKPmn = 0.**Note 2.** Use it with EVDD0 ≥ Vb.

Caution Select the TTL input buffer for the Slp pin and the N-ch open drain output (VDD tolerance (for the 30- to 52-pin products)/EVDD tolerance (for the 64- to 100-pin products)) mode for the SOp pin and SCKp pin by using port input mode register g (PIMg) and port output mode register g (POMg). For VIH and VIL, see the DC characteristics with TTL input buffer selected.

(Remarks are listed on the next page.)

CSI mode connection diagram (during communication at different potential)

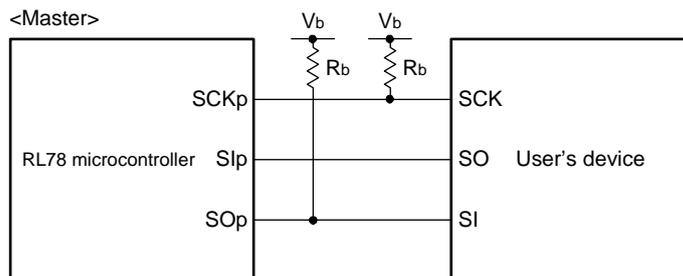

- Remark 1.** $R_b[\Omega]$: Communication line (SCKp, SOp) pull-up resistance, $C_b[F]$: Communication line (SCKp, SOp) load capacitance, $V_b[V]$: Communication line voltage
- Remark 2.** p: CSI number (p = 00, 01, 10, 20, 30, 31), m: Unit number (m = 0, 1), n: Channel number (n = 0 to 3), g: PIM and POM number (g = 0, 1, 3 to 5, 14)
- Remark 3.** f_{MCK} : Serial array unit operation clock frequency (Operation clock to be set by the CKSmn bit of serial mode register mn (SMRmn). m: Unit number, n: Channel number (mn = 00))
- Remark 4.** CSI01 of 48-, 52-, 64-pin products, and CSI11 and CSI21 cannot communicate at different potential. Use other CSI for communication at different potential.

CSI mode serial transfer timing (master mode) (during communication at different potential)
(When DAPmn = 0 and CKPmn = 0, or DAPmn = 1 and CKPmn = 1.)

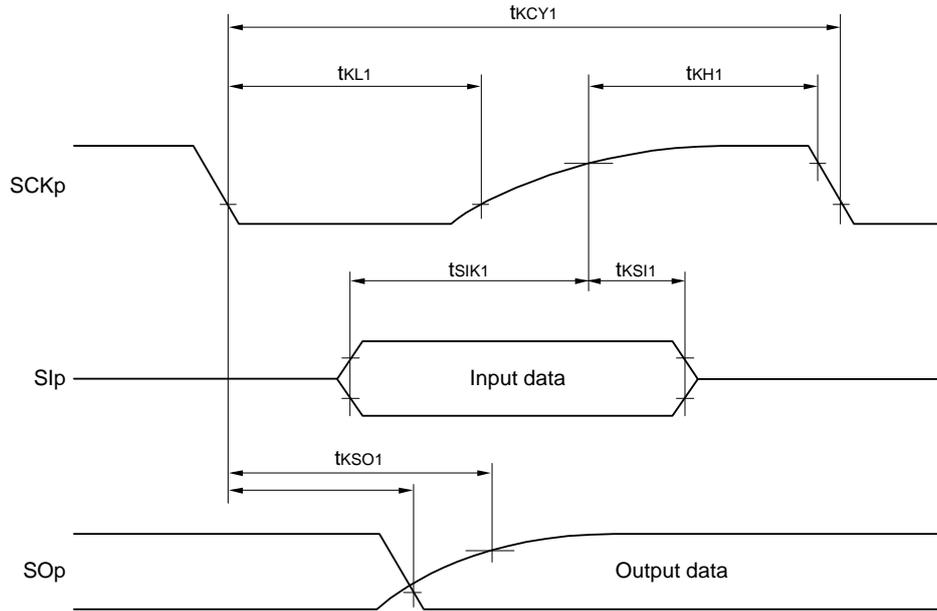

CSI mode serial transfer timing (master mode) (during communication at different potential)
(When DAPmn = 0 and CKPmn = 1, or DAPmn = 1 and CKPmn = 0.)

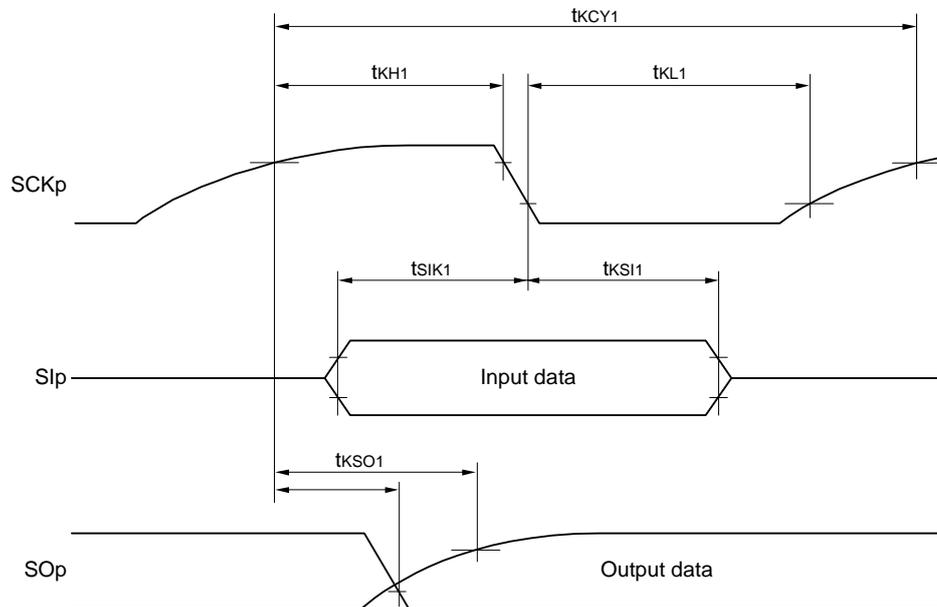

Remark 1. p: CSI number (p = 00, 01, 10, 20, 30, 31), m: Unit number (m = 0, 1), n: Channel number (n = 0 to 3),
 g: PIM and POM number (g = 0, 1, 3 to 5, 14)

Remark 2. CSI01 of 48-, 52-, 64-pin products, and CSI11 and CSI21 cannot communicate at different potential. Use other CSI for communication at different potential.

(9) Communication at different potential (1.8 V, 2.5 V, 3 V) (CSI mode) (slave mode, SCKp... external clock input)**(TA = -40 to +85°C, 1.8 V ≤ EVDD0 = EVDD1 ≤ VDD ≤ 5.5 V, VSS = EVSS0 = EVSS1 = 0 V)**

| Parameter | Symbol | Conditions | HS (high-speed main) mode | | LS (low-speed main) mode | | LV (low-voltage main) mode | | Unit |
|--|---------------|--|---------------------------|-----------------|--------------------------|-----------------|----------------------------|-----------------|------|
| | | | MIN. | MAX. | MIN. | MAX. | MIN. | MAX. | |
| SCKp cycle time Note 1 | tkcy2 | 4.0 V ≤ EVDD0 ≤ 5.5 V, 2.7 V ≤ Vb ≤ 4.0 V | 24 MHz < fmck | 14/fmck | — | — | — | — | ns |
| | | | 20 MHz < fmck ≤ 24 MHz | 12/fmck | — | — | — | — | ns |
| | | | 8 MHz < fmck ≤ 20 MHz | 10/fmck | — | — | — | — | ns |
| | | | 4 MHz < fmck ≤ 8 MHz | 8/fmck | — | 16/fmck | — | — | ns |
| | | | fmck ≤ 4 MHz | 6/fmck | — | 10/fmck | 10/fmck | — | ns |
| | | 2.7 V ≤ EVDD0 < 4.0 V, 2.3 V ≤ Vb ≤ 2.7 V | 24 MHz < fmck | 20/fmck | — | — | — | — | ns |
| | | | 20 MHz < fmck ≤ 24 MHz | 16/fmck | — | — | — | — | ns |
| | | | 16 MHz < fmck ≤ 20 MHz | 14/fmck | — | — | — | — | ns |
| | | | 8 MHz < fmck ≤ 16 MHz | 12/fmck | — | — | — | — | ns |
| | | | 4 MHz < fmck ≤ 8 MHz | 8/fmck | — | 16/fmck | — | — | ns |
| | | 1.8 V ≤ EVDD0 < 3.3 V, 1.6 V ≤ Vb ≤ 2.0 V Note 2 | 24 MHz < fmck | 48/fmck | — | — | — | — | ns |
| | | | 20 MHz < fmck ≤ 24 MHz | 36/fmck | — | — | — | — | ns |
| | | | 16 MHz < fmck ≤ 20 MHz | 32/fmck | — | — | — | — | ns |
| | | | 8 MHz < fmck ≤ 16 MHz | 26/fmck | — | — | — | — | ns |
| | | | 4 MHz < fmck ≤ 8 MHz | 16/fmck | — | 16/fmck | — | — | ns |
| | | fmck ≤ 4 MHz | | 10/fmck | — | 10/fmck | 10/fmck | — | ns |
| | | | | | 10/fmck | — | 10/fmck | — | ns |
| | | | | | 10/fmck | — | 10/fmck | — | ns |
| | | | | | 10/fmck | — | 10/fmck | — | ns |
| | | | | | 10/fmck | — | 10/fmck | — | ns |
| SCKp high/ low-level width | tkH2, tkL2 | 4.0 V ≤ EVDD0 ≤ 5.5 V, 2.7 V ≤ Vb ≤ 4.0 V | tkcy2/2 - 12 | — | tkcy2/2 - 50 | — | tkcy2/2 - 50 | — | ns |
| | | 2.7 V ≤ EVDD0 < 4.0 V, 2.3 V ≤ Vb ≤ 2.7 V | tkcy2/2 - 18 | — | tkcy2/2 - 50 | — | tkcy2/2 - 50 | — | ns |
| | | 1.8 V ≤ EVDD0 < 3.3 V, 1.6 V ≤ Vb ≤ 2.0 V Note 2 | tkcy2/2 - 50 | — | tkcy2/2 - 50 | — | tkcy2/2 - 50 | — | ns |
| Slp setup time (to SCKp↑) Note 3 | tsik2 | 4.0 V ≤ EVDD0 ≤ 5.5 V, 2.7 V ≤ Vb ≤ 4.0 V | 1/fmck + 20 | — | 1/fmck + 30 | — | 1/fmck + 30 | — | ns |
| | | 2.7 V ≤ EVDD0 < 4.0 V, 2.3 V ≤ Vb ≤ 2.7 V | 1/fmck + 20 | — | 1/fmck + 30 | — | 1/fmck + 30 | — | ns |
| | | 1.8 V ≤ EVDD0 < 3.3 V, 1.6 V ≤ Vb ≤ 2.0 V Note 2 | 1/fmck + 30 | — | 1/fmck + 30 | — | 1/fmck + 30 | — | ns |
| Slp hold time (from SCKp↑) Note 4 | tksl2 | | 1/fmck + 31 | — | 1/fmck + 31 | — | 1/fmck + 31 | — | ns |
| Delay time from SCKp↓ to SOp output Note 5 | tkso2 | 4.0 V ≤ EVDD0 ≤ 5.5 V, 2.7 V ≤ Vb ≤ 4.0 V, Cb = 30 pF, Rb = 1.4 kΩ | | 2/fmck + 120 | | 2/fmck + 573 | | 2/fmck + 573 | ns |
| | | 2.7 V ≤ EVDD0 < 4.0 V, 2.3 V ≤ Vb ≤ 2.7 V, Cb = 30 pF, Rb = 2.7 kΩ | | 2/fmck + 214 | | 2/fmck + 573 | | 2/fmck + 573 | ns |
| | | 1.8 V ≤ EVDD0 < 3.3 V, 1.6 V ≤ Vb ≤ 2.0 V Note 2, Cb = 30 pF, Rv = 5.5 kΩ | | 2/fmck + 573 | | 2/fmck + 573 | | 2/fmck + 573 | ns |

(Notes, Caution, and Remarks are listed on the next page.)

- Note 1.** Transfer rate in the SNOOZE mode: MAX. 1 Mbps
- Note 2.** Use it with $EV_{DD0} \geq V_b$.
- Note 3.** When $DAP_{mn} = 0$ and $CKP_{mn} = 0$, or $DAP_{mn} = 1$ and $CKP_{mn} = 1$. The Slp setup time becomes “to $SCKp\downarrow$ ” when $DAP_{mn} = 0$ and $CKP_{mn} = 1$, or $DAP_{mn} = 1$ and $CKP_{mn} = 0$.
- Note 4.** When $DAP_{mn} = 0$ and $CKP_{mn} = 0$, or $DAP_{mn} = 1$ and $CKP_{mn} = 1$. The Slp hold time becomes “from $SCKp\downarrow$ ” when $DAP_{mn} = 0$ and $CKP_{mn} = 1$, or $DAP_{mn} = 1$ and $CKP_{mn} = 0$.
- Note 5.** When $DAP_{mn} = 0$ and $CKP_{mn} = 0$, or $DAP_{mn} = 1$ and $CKP_{mn} = 1$. The delay time to SOp output becomes “from $SCKp\uparrow$ ” when $DAP_{mn} = 0$ and $CKP_{mn} = 1$, or $DAP_{mn} = 1$ and $CKP_{mn} = 0$.
- Caution** Select the TTL input buffer for the Slp pin and $SCKp$ pin, and the N-ch open drain output (V_{DD} tolerance (for the 30- to 52-pin products)/ EV_{DD} tolerance (for the 64- to 100-pin products)) mode for the SOp pin by using port input mode register g (PIMg) and port output mode register g (POMg). For V_{IH} and V_{IL} , see the DC characteristics with TTL input buffer selected.

CSI mode connection diagram (during communication at different potential)

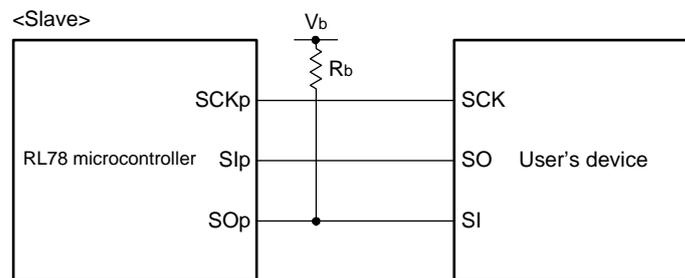

- Remark 1.** $R_b[\Omega]$: Communication line (SOp) pull-up resistance, $C_b[F]$: Communication line (SOp) load capacitance, $V_b[V]$: Communication line voltage
- Remark 2.** p: CSI number (p = 00, 01, 10, 20, 30, 31), m: Unit number (m = 0, 1), n: Channel number (n = 0 to 3), g: PIM and POM number (g = 0, 1, 3 to 5, 14)
- Remark 3.** f_{MCK} : Serial array unit operation clock frequency
(Operation clock to be set by the $CKSmn$ bit of serial mode register mn ($SMRmn$).
m: Unit number, n: Channel number (mn = 00, 01, 02, 10, 12, 13))
- Remark 4.** CSI01 of 48-, 52-, 64-pin products, and CSI11 and CSI21 cannot communicate at different potential. Use other CSI for communication at different potential.
Also, communication at different potential cannot be performed during clock synchronous serial communication with the slave select function.

**CSI mode serial transfer timing (slave mode) (during communication at different potential)
(When DAPmn = 0 and CKPmn = 0, or DAPmn = 1 and CKPmn = 1.)**

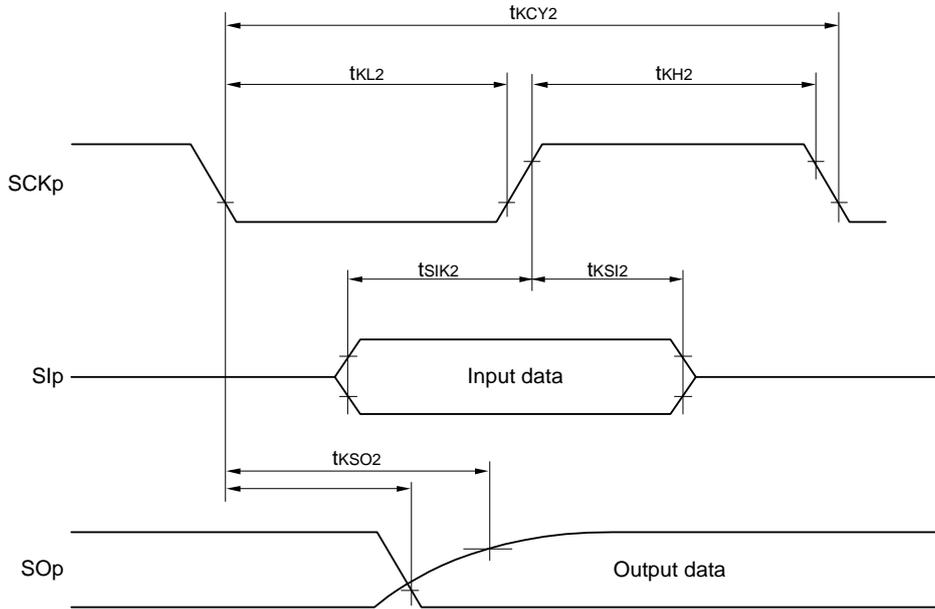

**CSI mode serial transfer timing (slave mode) (during communication at different potential)
(When DAPmn = 0 and CKPmn = 1, or DAPmn = 1 and CKPmn = 0.)**

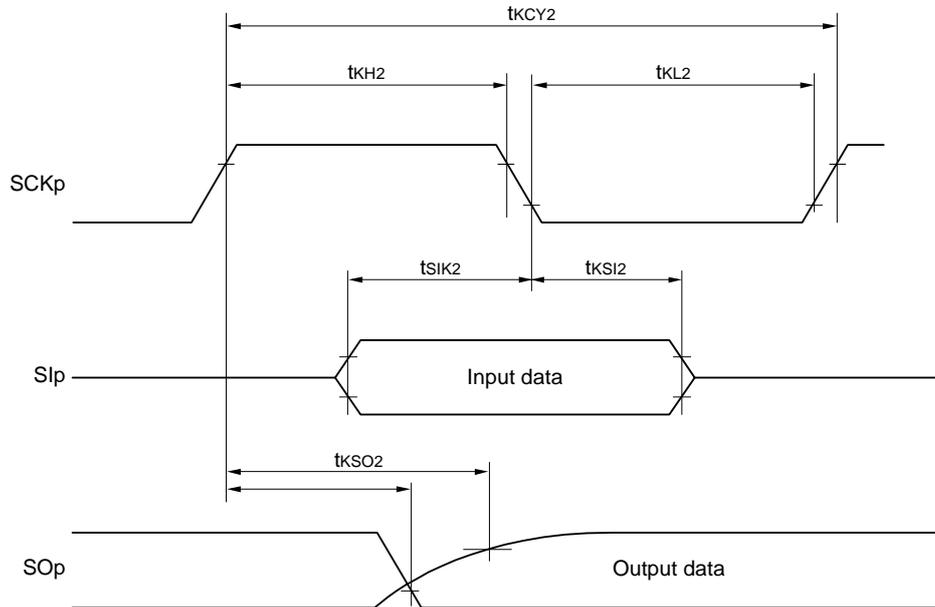

Remark 1. p: CSI number (p = 00, 01, 10, 20, 30, 31), m: Unit number (m = 0, 1), n: Channel number (n = 0 to 3), g: PIM and POM number (g = 0, 1, 3 to 5, 14)

Remark 2. CSI01 of 48-, 52-, 64-pin products, and CSI11 and CSI21 cannot communicate at different potential. Use other CSI for communication at different potential.

Also, communication at different potential cannot be performed during clock synchronous serial communication with the slave select function.

(10) Communication at different potential (1.8 V, 2.5 V, 3 V) (simplified I²C mode)**(TA = -40 to +85°C, 1.8 V ≤ EVDD0 = EVDD1 ≤ VDD ≤ 5.5 V, VSS = EVSS0 = EVSS1 = 0 V)****(1/2)**

| Parameter | Symbol | Conditions | HS (high-speed main) mode | | LS (low-speed main) mode | | LV (low-voltage main) mode | | Unit |
|---------------------------|--------|--|---------------------------|-------------|--------------------------|------------|----------------------------|------------|------|
| | | | MIN. | MAX. | MIN. | MAX. | MIN. | MAX. | |
| SCLr clock frequency | fSCL | 4.0 V ≤ EVDD0 ≤ 5.5 V, 2.7 V ≤ Vb ≤ 4.0 V, Cb = 50 pF, Rb = 2.7 kΩ | | 1000 Note 1 | | 300 Note 1 | | 300 Note 1 | kHz |
| | | 2.7 V ≤ EVDD0 < 4.0 V, 2.3 V ≤ Vb ≤ 2.7 V, Cb = 50 pF, Rb = 2.7 kΩ | | 1000 Note 1 | | 300 Note 1 | | 300 Note 1 | kHz |
| | | 4.0 V ≤ EVDD0 ≤ 5.5 V, 2.7 V ≤ Vb ≤ 4.0 V, Cb = 100 pF, Rb = 2.8 kΩ | | 400 Note 1 | | 300 Note 1 | | 300 Note 1 | kHz |
| | | 2.7 V ≤ EVDD0 < 4.0 V, 2.3 V ≤ Vb ≤ 2.7 V, Cb = 100 pF, Rb = 2.7 kΩ | | 400 Note 1 | | 300 Note 1 | | 300 Note 1 | kHz |
| | | 1.8 V ≤ EVDD0 < 3.3 V, 1.6 V ≤ Vb ≤ 2.0 V Note 2, Cb = 100 pF, Rb = 5.5 kΩ | | 300 Note 1 | | 300 Note 1 | | 300 Note 1 | kHz |
| Hold time when SCLr = "L" | tLOW | 4.0 V ≤ EVDD0 ≤ 5.5 V, 2.7 V ≤ Vb ≤ 4.0 V, Cb = 50 pF, Rb = 2.7 kΩ | 475 | | 1550 | | 1550 | | ns |
| | | 2.7 V ≤ EVDD0 < 4.0 V, 2.3 V ≤ Vb ≤ 2.7 V, Cb = 50 pF, Rb = 2.7 kΩ | 475 | | 1550 | | 1550 | | ns |
| | | 4.0 V ≤ EVDD0 ≤ 5.5 V, 2.7 V ≤ Vb ≤ 4.0 V, Cb = 100 pF, Rb = 2.8 kΩ | 1150 | | 1550 | | 1550 | | ns |
| | | 2.7 V ≤ EVDD0 < 4.0 V, 2.3 V ≤ Vb ≤ 2.7 V, Cb = 100 pF, Rb = 2.7 kΩ | 1150 | | 1550 | | 1550 | | ns |
| | | 1.8 V ≤ EVDD0 < 3.3 V, 1.6 V ≤ Vb ≤ 2.0 V Note 2, Cb = 100 pF, Rb = 5.5 kΩ | 1550 | | 1550 | | 1550 | | ns |
| Hold time when SCLr = "H" | tHIGH | 4.0 V ≤ EVDD0 ≤ 5.5 V, 2.7 V ≤ Vb ≤ 4.0 V, Cb = 50 pF, Rb = 2.7 kΩ | 245 | | 610 | | 610 | | ns |
| | | 2.7 V ≤ EVDD0 < 4.0 V, 2.3 V ≤ Vb ≤ 2.7 V, Cb = 50 pF, Rb = 2.7 kΩ | 200 | | 610 | | 610 | | ns |
| | | 4.0 V ≤ EVDD0 ≤ 5.5 V, 2.7 V ≤ Vb ≤ 4.0 V, Cb = 100 pF, Rb = 2.8 kΩ | 675 | | 610 | | 610 | | ns |
| | | 2.7 V ≤ EVDD0 < 4.0 V, 2.3 V ≤ Vb ≤ 2.7 V, Cb = 100 pF, Rb = 2.7 kΩ | 600 | | 610 | | 610 | | ns |
| | | 1.8 V ≤ EVDD0 < 3.3 V, 1.6 V ≤ Vb ≤ 2.0 V Note 2, Cb = 100 pF, Rb = 5.5 kΩ | 610 | | 610 | | 610 | | ns |

(10) Communication at different potential (1.8 V, 2.5 V, 3 V) (simplified I²C mode)**(TA = -40 to +85°C, 1.8 V ≤ EVDD0 = EVDD1 ≤ VDD ≤ 5.5 V, VSS = EVSS0 = EVSS1 = 0 V)****(2/2)**

| Parameter | Symbol | Conditions | HS (high-speed main) mode | | LS (low-speed main) mode | | LV (low-voltage main) mode | | Unit |
|-------------------------------|---------|--|---------------------------|------|--------------------------|------|----------------------------|------|------|
| | | | MIN. | MAX. | MIN. | MAX. | MIN. | MAX. | |
| Data setup time (reception) | tsu:DAT | 4.0 V ≤ EVDD0 ≤ 5.5 V, 2.7 V ≤ Vb ≤ 4.0 V, Cb = 50 pF, Rb = 2.7 kΩ | 1/fmck + 135 Note 3 | | 1/fmck + 190 Note 3 | | 1/fmck + 190 Note 3 | | ns |
| | | 2.7 V ≤ EVDD0 < 4.0 V, 2.3 V ≤ Vb ≤ 2.7 V, Cb = 50 pF, Rb = 2.7 kΩ | 1/fmck + 135 Note 3 | | 1/fmck + 190 Note 3 | | 1/fmck + 190 Note 3 | | ns |
| | | 4.0 V ≤ EVDD0 ≤ 5.5 V, 2.7 V ≤ Vb ≤ 4.0 V, Cb = 100 pF, Rb = 2.8 kΩ | 1/fmck + 190 Note 3 | | 1/fmck + 190 Note 3 | | 1/fmck + 190 Note 3 | | ns |
| | | 2.7 V ≤ EVDD0 < 4.0 V, 2.3 V ≤ Vb ≤ 2.7 V, Cb = 100 pF, Rb = 2.7 kΩ | 1/fmck + 190 Note 3 | | 1/fmck + 190 Note 3 | | 1/fmck + 190 Note 3 | | ns |
| | | 1.8 V ≤ EVDD0 < 3.3 V, 1.6 V ≤ Vb ≤ 2.0 V Note 2, Cb = 100 pF, Rb = 5.5 kΩ | 1/fmck + 190 Note 3 | | 1/fmck + 190 Note 3 | | 1/fmck + 190 Note 3 | | ns |
| Data hold time (transmission) | thd:DAT | 4.0 V ≤ EVDD0 ≤ 5.5 V, 2.7 V ≤ Vb ≤ 4.0 V, Cb = 50 pF, Rb = 2.7 kΩ | 0 | 305 | 0 | 305 | 0 | 305 | ns |
| | | 2.7 V ≤ EVDD0 < 4.0 V, 2.3 V ≤ Vb ≤ 2.7 V, Cb = 50 pF, Rb = 2.7 kΩ | 0 | 305 | 0 | 305 | 0 | 305 | ns |
| | | 4.0 V ≤ EVDD0 ≤ 5.5 V, 2.7 V ≤ Vb ≤ 4.0 V, Cb = 100 pF, Rb = 2.8 kΩ | 0 | 355 | 0 | 355 | 0 | 355 | ns |
| | | 2.7 V ≤ EVDD0 < 4.0 V, 2.3 V ≤ Vb ≤ 2.7 V, Cb = 100 pF, Rb = 2.7 kΩ | 0 | 355 | 0 | 355 | 0 | 355 | ns |
| | | 1.8 V ≤ EVDD0 < 3.3 V, 1.6 V ≤ Vb ≤ 2.0 V Note 2, Cb = 100 pF, Rb = 5.5 kΩ | 0 | 405 | 0 | 405 | 0 | 405 | ns |

Note 1. The value must also be equal to or less than fmck/4.

Note 2. Use it with EVDD0 ≥ Vb.

Note 3. Set the fmck value to keep the hold time of SCLr = "L" and SCLr = "H".

Caution Select the TTL input buffer and the N-ch open drain output (VDD tolerance (for the 30- to 52-pin products)/EVDD tolerance (for the 64- to 100-pin products)) mode for the SDAr pin and the N-ch open drain output (VDD tolerance (for the 30- to 52-pin products)/EVDD tolerance (for the 64- to 100-pin products)) mode for the SCLr pin by using port input mode register g (PIMg) and port output mode register g (POMg). For VIH and VIL, see the DC characteristics with TTL input buffer selected.

(Remarks are listed on the next page.)

Simplified I²C mode connection diagram (during communication at different potential)

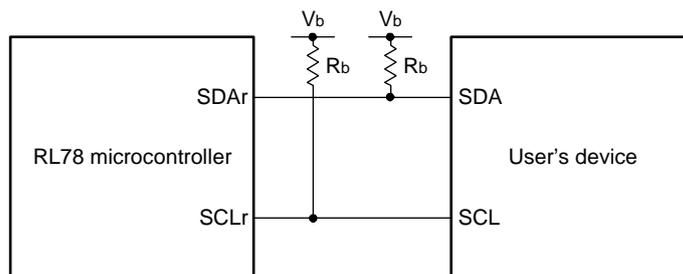

Simplified I²C mode serial transfer timing (during communication at different potential)

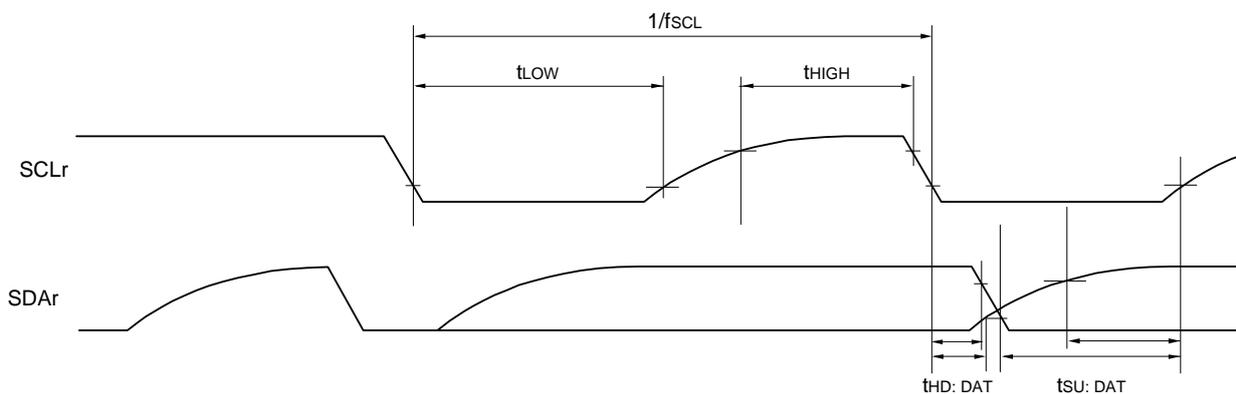

Remark 1. $R_b[\Omega]$: Communication line (SDAr, SCLr) pull-up resistance, $C_b[F]$: Communication line (SDAr, SCLr) load capacitance, $V_b[V]$: Communication line voltage

Remark 2. r: IIC number (r = 00, 01, 10, 11, 20, 30, 31), g: PIM, POM number (g = 0, 1, 3 to 5, 14)

Remark 3. f_{MCK} : Serial array unit operation clock frequency
 (Operation clock to be set by the CKSmn bit of serial mode register mn (SMRmn). m: Unit number (m = 0, 1),
 n: Channel number (n = 0, 2), mn = 00, 01, 02, 10, 12, 13)

2.5.2 Serial interface IICA

(1) I²C standard mode

(TA = -40 to +85°C, 1.6 V ≤ EVDD0 = EVDD1 ≤ VDD ≤ 5.5 V, VSS = EVSS0 = EVSS1 = 0 V)

(1/2)

| Parameter | Symbol | Conditions | HS (high-speed main) mode | | LS (low-speed main) mode | | LV (low-voltage main) mode | | Unit | |
|---------------------------------|----------------------|--|---------------------------|------|--------------------------|------|----------------------------|------|------|-----|
| | | | MIN. | MAX. | MIN. | MAX. | MIN. | MAX. | | |
| SCLA0 clock frequency | f _{SCL} | Standard mode: f _{CLK} ≥ 1 MHz | 2.7 V ≤ EVDD0 ≤ 5.5 V | 0 | 100 | 0 | 100 | 0 | 100 | kHz |
| | | | 1.8 V ≤ EVDD0 ≤ 5.5 V | 0 | 100 | 0 | 100 | 0 | 100 | kHz |
| | | | 1.7 V ≤ EVDD0 ≤ 5.5 V | 0 | 100 | 0 | 100 | 0 | 100 | kHz |
| | | | 1.6 V ≤ EVDD0 ≤ 5.5 V | — | | 0 | 100 | 0 | 100 | kHz |
| Setup time of restart condition | t _{SU, STA} | 2.7 V ≤ EVDD0 ≤ 5.5 V | 4.7 | | 4.7 | | 4.7 | | μs | |
| | | 1.8 V ≤ EVDD0 ≤ 5.5 V | 4.7 | | 4.7 | | 4.7 | | μs | |
| | | 1.7 V ≤ EVDD0 ≤ 5.5 V | 4.7 | | 4.7 | | 4.7 | | μs | |
| | | 1.6 V ≤ EVDD0 ≤ 5.5 V | — | | 4.7 | | 4.7 | | μs | |
| Hold time ^{Note 1} | t _{HD, STA} | 2.7 V ≤ EVDD0 ≤ 5.5 V | 4.0 | | 4.0 | | 4.0 | | μs | |
| | | 1.8 V ≤ EVDD0 ≤ 5.5 V | 4.0 | | 4.0 | | 4.0 | | μs | |
| | | 1.7 V ≤ EVDD0 ≤ 5.5 V | 4.0 | | 4.0 | | 4.0 | | μs | |
| | | 1.6 V ≤ EVDD0 ≤ 5.5 V | — | | 4.0 | | 4.0 | | μs | |
| Hold time when SCLA0 = "L" | t _{LOW} | 2.7 V ≤ EVDD0 ≤ 5.5 V | 4.7 | | 4.7 | | 4.7 | | μs | |
| | | 1.8 V ≤ EVDD0 ≤ 5.5 V | 4.7 | | 4.7 | | 4.7 | | μs | |
| | | 1.7 V ≤ EVDD0 ≤ 5.5 V | 4.7 | | 4.7 | | 4.7 | | μs | |
| | | 1.6 V ≤ EVDD0 ≤ 5.5 V | — | | 4.7 | | 4.7 | | μs | |
| Hold time when SCLA0 = "H" | t _{HIGH} | 2.7 V ≤ EVDD0 ≤ 5.5 V | 4.0 | | 4.0 | | 4.0 | | μs | |
| | | 1.8 V ≤ EVDD0 ≤ 5.5 V | 4.0 | | 4.0 | | 4.0 | | μs | |
| | | 1.7 V ≤ EVDD0 ≤ 5.5 V | 4.0 | | 4.0 | | 4.0 | | μs | |
| | | 1.6 V ≤ EVDD0 ≤ 5.5 V | — | | 4.0 | | 4.0 | | μs | |

(Notes, Caution, and Remark are listed on the next page.)

(1) I²C standard mode**(TA = -40 to +85°C, 1.6 V ≤ EVDD0 = EVDD1 ≤ VDD ≤ 5.5 V, VSS = EVSS0 = EVSS1 = 0 V)****(2/2)**

| Parameter | Symbol | Conditions | HS (high-speed main) mode | | LS (low-speed main) mode | | LV (low-voltage main) mode | | Unit |
|---|----------|-----------------------|---------------------------|------|--------------------------|------|----------------------------|------|------|
| | | | MIN. | MAX. | MIN. | MAX. | MIN. | MAX. | |
| Data setup time (reception) | tsu: DAT | 2.7 V ≤ EVDD0 ≤ 5.5 V | 250 | | 250 | | 250 | | ns |
| | | 1.8 V ≤ EVDD0 ≤ 5.5 V | 250 | | 250 | | 250 | | ns |
| | | 1.7 V ≤ EVDD0 ≤ 5.5 V | 250 | | 250 | | 250 | | ns |
| | | 1.6 V ≤ EVDD0 ≤ 5.5 V | — | | 250 | | 250 | | ns |
| Data hold time (transmission) Note 2 | thd: DAT | 2.7 V ≤ EVDD0 ≤ 5.5 V | 0 | 3.45 | 0 | 3.45 | 0 | 3.45 | μs |
| | | 1.8 V ≤ EVDD0 ≤ 5.5 V | 0 | 3.45 | 0 | 3.45 | 0 | 3.45 | μs |
| | | 1.7 V ≤ EVDD0 ≤ 5.5 V | 0 | 3.45 | 0 | 3.45 | 0 | 3.45 | μs |
| | | 1.6 V ≤ EVDD0 ≤ 5.5 V | — | | 0 | 3.45 | 0 | 3.45 | μs |
| Setup time of stop condition | tsu: STO | 2.7 V ≤ EVDD0 ≤ 5.5 V | 4.0 | | 4.0 | | 4.0 | | μs |
| | | 1.8 V ≤ EVDD0 ≤ 5.5 V | 4.0 | | 4.0 | | 4.0 | | μs |
| | | 1.7 V ≤ EVDD0 ≤ 5.5 V | 4.0 | | 4.0 | | 4.0 | | μs |
| | | 1.6 V ≤ EVDD0 ≤ 5.5 V | — | | 4.0 | | 4.0 | | μs |
| Bus-free time | tBUF | 2.7 V ≤ EVDD0 ≤ 5.5 V | 4.7 | | 4.7 | | 4.7 | | μs |
| | | 1.8 V ≤ EVDD0 ≤ 5.5 V | 4.7 | | 4.7 | | 4.7 | | μs |
| | | 1.7 V ≤ EVDD0 ≤ 5.5 V | 4.7 | | 4.7 | | 4.7 | | μs |
| | | 1.6 V ≤ EVDD0 ≤ 5.5 V | — | | 4.7 | | 4.7 | | μs |

Note 1. The first clock pulse is generated after this period when the start/restart condition is detected.

Note 2. The maximum value (MAX.) of thd: DAT is during normal transfer and a wait state is inserted in the ACK (acknowledge) timing.

Caution The values in the above table are applied even when bit 2 (PIOR02) in the peripheral I/O redirection register 0 (PIOR0) is 1. At this time, the pin characteristics (IOH1, IOL1, VOH1, VOL1) must satisfy the values in the redirect destination.

Remark The maximum value of C_b (communication line capacitance) and the value of R_b (communication line pull-up resistor) at that time in each mode are as follows.

Standard mode: C_b = 400 pF, R_b = 2.7 kΩ

(2) I²C fast mode

(TA = -40 to +85°C, 1.6 V ≤ EVDD0 = EVDD1 ≤ VDD ≤ 5.5 V, VSS = EVSS0 = EVSS1 = 0 V)

| Parameter | Symbol | Conditions | HS (high-speed main) mode | | LS (low-speed main) mode | | LV (low-voltage main) mode | | Unit | |
|--|----------|------------------------------|---------------------------|------|--------------------------|------|----------------------------|------|------|-----|
| | | | MIN. | MAX. | MIN. | MAX. | MIN. | MAX. | | |
| SCLA0 clock frequency | fSCL | Fast mode: fCLK ≥ 3.5 MHz | 2.7 V ≤ EVDD0 ≤ 5.5 V | 0 | 400 | 0 | 400 | 0 | 400 | kHz |
| | | | 1.8 V ≤ EVDD0 ≤ 5.5 V | 0 | 400 | 0 | 400 | 0 | 400 | kHz |
| Setup time of restart condition | tsu: STA | 2.7 V ≤ EVDD0 ≤ 5.5 V | 0.6 | | 0.6 | | 0.6 | | μs | |
| | | 1.8 V ≤ EVDD0 ≤ 5.5 V | 0.6 | | 0.6 | | 0.6 | | μs | |
| Hold time ^{Note 1} | tHD: STA | 2.7 V ≤ EVDD0 ≤ 5.5 V | 0.6 | | 0.6 | | 0.6 | | μs | |
| | | 1.8 V ≤ EVDD0 ≤ 5.5 V | 0.6 | | 0.6 | | 0.6 | | μs | |
| Hold time when SCLA0 = "L" | tLOW | 2.7 V ≤ EVDD0 ≤ 5.5 V | 1.3 | | 1.3 | | 1.3 | | μs | |
| | | 1.8 V ≤ EVDD0 ≤ 5.5 V | 1.3 | | 1.3 | | 1.3 | | μs | |
| Hold time when SCLA0 = "H" | tHIGH | 2.7 V ≤ EVDD0 ≤ 5.5 V | 0.6 | | 0.6 | | 0.6 | | μs | |
| | | 1.8 V ≤ EVDD0 ≤ 5.5 V | 0.6 | | 0.6 | | 0.6 | | μs | |
| Data setup time (reception) | tsu: DAT | 2.7 V ≤ EVDD0 ≤ 5.5 V | 100 | | 100 | | 100 | | ns | |
| | | 1.8 V ≤ EVDD0 ≤ 5.5 V | 100 | | 100 | | 100 | | ns | |
| Data hold time (transmission) ^{Note 2} | tHD: DAT | 2.7 V ≤ EVDD0 ≤ 5.5 V | 0 | 0.9 | 0 | 0.9 | 0 | 0.9 | μs | |
| | | 1.8 V ≤ EVDD0 ≤ 5.5 V | 0 | 0.9 | 0 | 0.9 | 0 | 0.9 | μs | |
| Setup time of stop condition | tsu: STO | 2.7 V ≤ EVDD0 ≤ 5.5 V | 0.6 | | 0.6 | | 0.6 | | μs | |
| | | 1.8 V ≤ EVDD0 ≤ 5.5 V | 0.6 | | 0.6 | | 0.6 | | μs | |
| Bus-free time | tBUF | 2.7 V ≤ EVDD0 ≤ 5.5 V | 1.3 | | 1.3 | | 1.3 | | μs | |
| | | 1.8 V ≤ EVDD0 ≤ 5.5 V | 1.3 | | 1.3 | | 1.3 | | μs | |

Note 1. The first clock pulse is generated after this period when the start/restart condition is detected.

Note 2. The maximum value (MAX.) of tHD: DAT is during normal transfer and a wait state is inserted in the ACK (acknowledge) timing.

Caution The values in the above table are applied even when bit 2 (PIOR02) in the peripheral I/O redirection register 0 (PIOR0) is 1. At this time, the pin characteristics (IOH1, IOL1, VOH1, VOL1) must satisfy the values in the redirect destination.

Remark The maximum value of C_b (communication line capacitance) and the value of R_b (communication line pull-up resistor) at that time in each mode are as follows.

Fast mode: C_b = 320 pF, R_b = 1.1 kΩ

(3) I²C fast mode plus

(TA = -40 to +85°C, 1.6 V ≤ EVDD0 = EVDD1 ≤ VDD ≤ 5.5 V, VSS = EVSS0 = EVSS1 = 0 V)

| Parameter | Symbol | Conditions | HS (high-speed main) mode | | LS (low-speed main) mode | | LV (low-voltage main) mode | | Unit |
|--------------------------------------|----------|---|---------------------------|------|--------------------------|------|----------------------------|------|------|
| | | | MIN. | MAX. | MIN. | MAX. | MIN. | MAX. | |
| SCLA0 clock frequency | fSCL | Fast mode plus: fCLK ≥ 10 MHz 2.7 V ≤ EVDD0 ≤ 5.5 V | 0 | 1000 | — | — | — | — | kHz |
| Setup time of restart condition | tSU: STA | 2.7 V ≤ EVDD0 ≤ 5.5 V | 0.26 | | — | — | — | — | μs |
| Hold time Note 1 | tHD: STA | 2.7 V ≤ EVDD0 ≤ 5.5 V | 0.26 | | — | — | — | — | μs |
| Hold time when SCLA0 = "L" | tLOW | 2.7 V ≤ EVDD0 ≤ 5.5 V | 0.5 | | — | — | — | — | μs |
| Hold time when SCLA0 = "H" | tHIGH | 2.7 V ≤ EVDD0 ≤ 5.5 V | 0.26 | | — | — | — | — | μs |
| Data setup time (reception) | tSU: DAT | 2.7 V ≤ EVDD0 ≤ 5.5 V | 50 | | — | — | — | — | ns |
| Data hold time (transmission) Note 2 | tHD: DAT | 2.7 V ≤ EVDD0 ≤ 5.5 V | 0 | 0.45 | — | — | — | — | μs |
| Setup time of stop condition | tSU: STO | 2.7 V ≤ EVDD0 ≤ 5.5 V | 0.26 | | — | — | — | — | μs |
| Bus-free time | tBUF | 2.7 V ≤ EVDD0 ≤ 5.5 V | 0.5 | | — | — | — | — | μs |

Note 1. The first clock pulse is generated after this period when the start/restart condition is detected.

Note 2. The maximum value (MAX.) of tHD: DAT is during normal transfer and a wait state is inserted in the ACK (acknowledge) timing.

Caution The values in the above table are applied even when bit 2 (PIOR02) in the peripheral I/O redirection register 0 (PIOR0) is 1. At this time, the pin characteristics (IOH1, IOL1, VOH1, VOL1) must satisfy the values in the redirect destination.

Note 3. The maximum value of C_b (communication line capacitance) and the value of R_b (communication line pull-up resistor) at that time in each mode are as follows.
Fast mode plus: C_b = 120 pF, R_b = 1.1 kΩ

I²C serial transfer timing

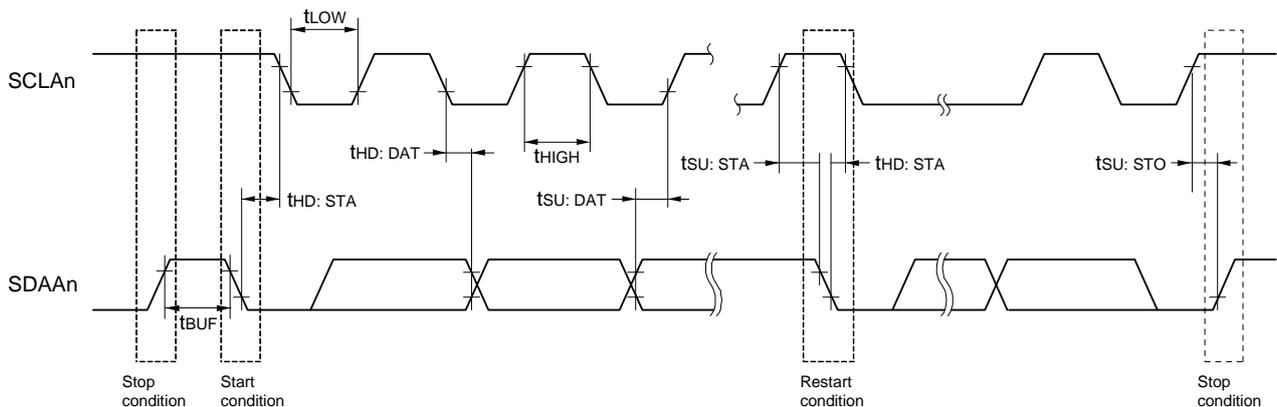

Remark n = 0, 1

2.6 Analog Characteristics

2.6.1 A/D converter characteristics

Classification of A/D converter characteristics

| Input channel | Reference Voltage | Reference voltage (+) = AV _{REFP} Reference voltage (-) = AV _{REFM} | Reference voltage (+) = V _{DD} Reference voltage (-) = V _{SS} | Reference voltage (+) = V _{BGR} Reference voltage (-) = AV _{REFM} |
|---|-------------------|--|--|--|
| ANI0 to ANI14 | | Refer to 2.6.1 (1). | Refer to 2.6.1 (3). | Refer to 2.6.1 (4). |
| ANI16 to ANI20 | | Refer to 2.6.1 (2). | | |
| Internal reference voltage Temperature sensor output voltage | | Refer to 2.6.1 (1). | | |

(1) When reference voltage (+) = AV_{REFP}/ANI0 (ADREFP1 = 0, ADREFP0 = 1), reference voltage (-) = AV_{REFM}/ANI1 (ADREFM = 1), target pin: ANI2 to ANI14, internal reference voltage, and temperature sensor output voltage

(TA = -40 to +85°C, 1.6 V ≤ AV_{REFP} ≤ V_{DD} ≤ 5.5 V, V_{SS} = 0 V, Reference voltage (+) = AV_{REFP}, Reference voltage (-) = AV_{REFM} = 0 V)

| Parameter | Symbol | Conditions | MIN. | TYP. | MAX. | Unit |
|-------------------------------------|-------------------|--|---|--------|----------------------------|------|
| Resolution | RES | | 8 | | 10 | bit |
| Overall error Note 1 | AINL | 10-bit resolution AV _{REFP} = V _{DD} Note 3 | 1.8 V ≤ AV _{REFP} ≤ 5.5 V | 1.2 | ±3.5 | LSB |
| | | | 1.6 V ≤ AV _{REFP} ≤ 5.5 V Note 4 | 1.2 | ±7.0 | LSB |
| Conversion time | t _{CONV} | 10-bit resolution Target pin: ANI2 to ANI14 | 3.6 V ≤ V _{DD} ≤ 5.5 V | 2.125 | 39 | μs |
| | | | 2.7 V ≤ V _{DD} ≤ 5.5 V | 3.1875 | 39 | μs |
| | | | 1.8 V ≤ V _{DD} ≤ 5.5 V | 17 | 39 | μs |
| | | | 1.6 V ≤ V _{DD} ≤ 5.5 V | 57 | 95 | μs |
| | | 10-bit resolution Target pin: Internal reference voltage, and temperature sensor output voltage (HS (high-speed main) mode) | 3.6 V ≤ V _{DD} ≤ 5.5 V | 2.375 | 39 | μs |
| | | | 2.7 V ≤ V _{DD} ≤ 5.5 V | 3.5625 | 39 | μs |
| | | 2.4 V ≤ V _{DD} ≤ 5.5 V | 17 | 39 | μs | |
| Zero-scale error Notes 1, 2 | EzS | 10-bit resolution AV _{REFP} = V _{DD} Note 3 | 1.8 V ≤ AV _{REFP} ≤ 5.5 V | | ±0.25 | %FSR |
| | | | 1.6 V ≤ AV _{REFP} ≤ 5.5 V Note 4 | | ±0.50 | %FSR |
| Full-scale error Notes 1, 2 | EFS | 10-bit resolution AV _{REFP} = V _{DD} Note 3 | 1.8 V ≤ AV _{REFP} ≤ 5.5 V | | ±0.25 | %FSR |
| | | | 1.6 V ≤ AV _{REFP} ≤ 5.5 V Note 4 | | ±0.50 | %FSR |
| Integral linearity error Note 1 | ILE | 10-bit resolution AV _{REFP} = V _{DD} Note 3 | 1.8 V ≤ AV _{REFP} ≤ 5.5 V | | ±2.5 | LSB |
| | | | 1.6 V ≤ AV _{REFP} ≤ 5.5 V Note 4 | | ±5.0 | LSB |
| Differential linearity error Note 1 | DLE | 10-bit resolution AV _{REFP} = V _{DD} Note 3 | 1.8 V ≤ AV _{REFP} ≤ 5.5 V | | ±1.5 | LSB |
| | | | 1.6 V ≤ AV _{REFP} ≤ 5.5 V Note 4 | | ±2.0 | LSB |
| Analog input voltage | V _{AIN} | ANI2 to ANI14 | 0 | | AV _{REFP} | V |
| | | Internal reference voltage (2.4 V ≤ V _{DD} ≤ 5.5 V, HS (high-speed main) mode) | | | V _{BGR} Note 5 | V |
| | | Temperature sensor output voltage (2.4 V ≤ V _{DD} ≤ 5.5 V, HS (high-speed main) mode) | | | V _{TMPS25} Note 5 | V |

Note 1. Excludes quantization error (±1/2 LSB).

Note 2. This value is indicated as a ratio (%FSR) to the full-scale value.

Note 3. When AV_{REFP} < V_{DD}, the MAX. values are as follows.

Overall error: Add ±1.0 LSB to the MAX. value when AV_{REFP} = V_{DD}.
 Zero-scale error/Full-scale error: Add ±0.05%FSR to the MAX. value when AV_{REFP} = V_{DD}.
 Integral linearity error/ Differential linearity error: Add ±0.5 LSB to the MAX. value when AV_{REFP} = V_{DD}.

Note 4. Values when the conversion time is set to 57 μs (min.) and 95 μs (max.).

Note 5. Refer to 2.6.2 Temperature sensor characteristics/internal reference voltage characteristic.

(2) When reference voltage (+) = $AV_{REFP}/ANI0$ (ADREFP1 = 0, ADREFP0 = 1), reference voltage (-) = $AV_{REFM}/ANI1$ (ADREFM = 1), target pin: ANI16 to ANI20

(TA = -40 to +85°C, $1.6\text{ V} \leq EV_{DD0} = EV_{DD1} \leq V_{DD} \leq 5.5\text{ V}$, $1.6\text{ V} \leq AV_{REFP} \leq V_{DD} \leq 5.5\text{ V}$, $V_{SS} = EV_{SS0} = EV_{SS1} = 0\text{ V}$, Reference voltage (+) = AV_{REFP} , Reference voltage (-) = $AV_{REFM} = 0\text{ V}$)

| Parameter | Symbol | Conditions | MIN. | TYP. | MAX. | Unit | |
|-------------------------------------|--------|--|--|--------|----------------------------------|-------|------|
| Resolution | RES | | 8 | | 10 | bit | |
| Overall error Note 1 | AINL | 10-bit resolution $EV_{DD0} \leq AV_{REFP} = V_{DD}$ Notes 3, 4 | $1.8\text{ V} \leq AV_{REFP} \leq 5.5\text{ V}$ | | 1.2 | ±5.0 | LSB |
| | | | $1.6\text{ V} \leq AV_{REFP} \leq 5.5\text{ V}$ Note 5 | | 1.2 | ±8.5 | LSB |
| Conversion time | tCONV | 10-bit resolution Target ANI pin: ANI16 to ANI20 | $3.6\text{ V} \leq V_{DD} \leq 5.5\text{ V}$ | 2.125 | | 39 | μs |
| | | | $2.7\text{ V} \leq V_{DD} \leq 5.5\text{ V}$ | 3.1875 | | 39 | μs |
| | | | $1.8\text{ V} \leq V_{DD} \leq 5.5\text{ V}$ | 17 | | 39 | μs |
| | | | $1.6\text{ V} \leq V_{DD} \leq 5.5\text{ V}$ | 57 | | 95 | μs |
| Zero-scale error Notes 1, 2 | EzS | 10-bit resolution $EV_{DD0} \leq AV_{REFP} = V_{DD}$ Notes 3, 4 | $1.8\text{ V} \leq AV_{REFP} \leq 5.5\text{ V}$ | | | ±0.35 | %FSR |
| | | | $1.6\text{ V} \leq AV_{REFP} \leq 5.5\text{ V}$ Note 5 | | | ±0.60 | %FSR |
| Full-scale error Notes 1, 2 | EFS | 10-bit resolution $EV_{DD0} \leq AV_{REFP} = V_{DD}$ Notes 3, 4 | $1.8\text{ V} \leq AV_{REFP} \leq 5.5\text{ V}$ | | | ±0.35 | %FSR |
| | | | $1.6\text{ V} \leq AV_{REFP} \leq 5.5\text{ V}$ Note 5 | | | ±0.60 | %FSR |
| Integral linearity error Note 1 | ILE | 10-bit resolution $EV_{DD0} \leq AV_{REFP} = V_{DD}$ Notes 3, 4 | $1.8\text{ V} \leq AV_{REFP} \leq 5.5\text{ V}$ | | | ±3.5 | LSB |
| | | | $1.6\text{ V} \leq AV_{REFP} \leq 5.5\text{ V}$ Note 5 | | | ±6.0 | LSB |
| Differential linearity error Note 1 | DLE | 10-bit resolution $EV_{DD0} \leq AV_{REFP} = V_{DD}$ Notes 3, 4 | $1.8\text{ V} \leq AV_{REFP} \leq 5.5\text{ V}$ | | | ±2.0 | LSB |
| | | | $1.6\text{ V} \leq AV_{REFP} \leq 5.5\text{ V}$ Note 5 | | | ±2.5 | LSB |
| Analog input voltage | VAIN | ANI16 to ANI20 | 0 | | AV_{REFP} and EV_{DD0} | V | |

Note 1. Excludes quantization error ($\pm 1/2$ LSB).

Note 2. This value is indicated as a ratio (%FSR) to the full-scale value.

Note 3. When $EV_{DD0} \leq AV_{REFP} \leq V_{DD}$, the MAX. values are as follows.

Overall error: Add ± 1.0 LSB to the MAX. value when $AV_{REFP} = V_{DD}$.

Zero-scale error/Full-scale error: Add $\pm 0.05\%$ FSR to the MAX. value when $AV_{REFP} = V_{DD}$.

Integral linearity error/ Differential linearity error: Add ± 0.5 LSB to the MAX. value when $AV_{REFP} = V_{DD}$.

Note 4. When $AV_{REFP} < EV_{DD0} \leq V_{DD}$, the MAX. values are as follows.

Overall error: Add ± 4.0 LSB to the MAX. value when $AV_{REFP} = V_{DD}$.

Zero-scale error/Full-scale error: Add $\pm 0.20\%$ FSR to the MAX. value when $AV_{REFP} = V_{DD}$.

Integral linearity error/ Differential linearity error: Add ± 2.0 LSB to the MAX. value when $AV_{REFP} = V_{DD}$.

Note 5. When the conversion time is set to 57 μs (min.) and 95 μs (max.).

- (3) When reference voltage (+) = V_{DD} (ADREFP1 = 0, ADREFP0 = 0), reference voltage (-) = V_{SS} (ADREFM = 0), target pin: ANI0 to ANI14, ANI16 to ANI20, internal reference voltage, and temperature sensor output voltage

(TA = -40 to +85°C, 1.6 V ≤ EV_{DD0} = EV_{DD1} ≤ V_{DD} ≤ 5.5 V, V_{SS} = EV_{SS0} = EV_{SS1} = 0 V, Reference voltage (+) = V_{DD}, Reference voltage (-) = V_{SS})

| Parameter | Symbol | Conditions | MIN. | TYP. | MAX. | Unit | |
|--|-------------------|--|--|--------|----------------------------|-------|------|
| Resolution | RES | | 8 | | 10 | bit | |
| Overall error Note 1 | AINL | 10-bit resolution | 1.8 V ≤ V _{DD} ≤ 5.5 V | | 1.2 | ±7.0 | LSB |
| | | | 1.6 V ≤ V _{DD} ≤ 5.5 V Note 3 | | 1.2 | ±10.5 | LSB |
| Conversion time | t _{CONV} | 10-bit resolution Target pin: ANI0 to ANI14, ANI16 to ANI20 | 3.6 V ≤ V _{DD} ≤ 5.5 V | 2.125 | | 39 | μs |
| | | | 2.7 V ≤ V _{DD} ≤ 5.5 V | 3.1875 | | 39 | μs |
| | | | 1.8 V ≤ V _{DD} ≤ 5.5 V | 17 | | 39 | μs |
| | | | 1.6 V ≤ V _{DD} ≤ 5.5 V | 57 | | 95 | μs |
| | | 10-bit resolution Target pin: internal reference voltage, and temperature sensor output voltage (HS (high-speed main) mode) | 3.6 V ≤ V _{DD} ≤ 5.5 V | 2.375 | | 39 | μs |
| | | | 2.7 V ≤ V _{DD} ≤ 5.5 V | 3.5625 | | 39 | μs |
| 2.4 V ≤ V _{DD} ≤ 5.5 V | 17 | | | 39 | μs | | |
| Zero-scale error Notes 1, 2 | E _{zs} | 10-bit resolution | 1.8 V ≤ V _{DD} ≤ 5.5 V | | | ±0.60 | %FSR |
| | | | 1.6 V ≤ V _{DD} ≤ 5.5 V Note 3 | | | ±0.85 | %FSR |
| Full-scale error Notes 1, 2 | E _{fs} | 10-bit resolution | 1.8 V ≤ V _{DD} ≤ 5.5 V | | | ±0.60 | %FSR |
| | | | 1.6 V ≤ V _{DD} ≤ 5.5 V Note 3 | | | ±0.85 | %FSR |
| Integral linearity error Note 1 | ILE | 10-bit resolution | 1.8 V ≤ V _{DD} ≤ 5.5 V | | | ±4.0 | LSB |
| | | | 1.6 V ≤ V _{DD} ≤ 5.5 V Note 3 | | | ±6.5 | LSB |
| Differential linearity error Note 1 | DLE | 10-bit resolution | 1.8 V ≤ V _{DD} ≤ 5.5 V | | | ±2.0 | LSB |
| | | | 1.6 V ≤ V _{DD} ≤ 5.5 V Note 3 | | | ±2.5 | LSB |
| Analog input voltage | V _{AIN} | ANI0 to ANI14 | 0 | | V _{DD} | V | |
| | | ANI16 to ANI20 | 0 | | EV _{DD0} | V | |
| | | Internal reference voltage (2.4 V ≤ V _{DD} ≤ 5.5 V, HS (high-speed main) mode) | | | V _{BGR} Note 4 | V | |
| | | Temperature sensor output voltage (2.4 V ≤ V _{DD} ≤ 5.5 V, HS (high-speed main) mode) | | | V _{TMPS25} Note 4 | V | |

Note 1. Excludes quantization error (±1/2 LSB).

Note 2. This value is indicated as a ratio (% FSR) to the full-scale value.

Note 3. When the conversion time is set to 57 μs (min.) and 95 μs (max.).

Note 4. Refer to 2.6.2 Temperature sensor characteristics/internal reference voltage characteristic.

(4) When reference voltage (+) = Internal reference voltage (ADREFP1 = 1, ADREFP0 = 0), reference voltage (-) = AVREFM/ANI1 (ADREFM = 1), target pin: ANI0, ANI2 to ANI14, ANI16 to ANI20

(TA = -40 to +85°C, 2.4 V ≤ VDD ≤ 5.5 V, 1.6 V ≤ EVDD = EVDD1 ≤ VDD, VSS = EVSS0 = EVSS1 = 0 V, Reference voltage (+) = VBGR ^{Note 3}, Reference voltage (-) = AVREFM = 0 V ^{Note 4}, HS (high-speed main) mode)

| Parameter | Symbol | Conditions | | MIN. | TYP. | MAX. | Unit |
|--|--------|------------------|---------------------|------|------|------------------------|-------|
| Resolution | RES | | | 8 | | | bit |
| Conversion time | tCONV | 8-bit resolution | 2.4 V ≤ VDD ≤ 5.5 V | 17 | | 39 | μs |
| Zero-scale error ^{Notes 1, 2} | Ezs | 8-bit resolution | 2.4 V ≤ VDD ≤ 5.5 V | | | ±0.60 | % FSR |
| Integral linearity error ^{Note 1} | ILE | 8-bit resolution | 2.4 V ≤ VDD ≤ 5.5 V | | | ±2.0 | LSB |
| Differential linearity error ^{Note 1} | DLE | 8-bit resolution | 2.4 V ≤ VDD ≤ 5.5 V | | | ±1.0 | LSB |
| Analog input voltage | VAIN | | | 0 | | VBGR ^{Note 3} | V |

Note 1. Excludes quantization error (±1/2 LSB).

Note 2. This value is indicated as a ratio (% FSR) to the full-scale value.

Note 3. Refer to **2.6.2 Temperature sensor characteristics/internal reference voltage characteristic**.

Note 4. When reference voltage (-) = VSS, the MAX. values are as follows.

Zero-scale error: Add ±0.35%FSR to the MAX. value when reference voltage (-) = AVREFM.

Integral linearity error: Add ±0.5 LSB to the MAX. value when reference voltage (-) = AVREFM.

Differential linearity error: Add ±0.2 LSB to the MAX. value when reference voltage (-) = AVREFM.

2.6.2 Temperature sensor characteristics/internal reference voltage characteristic

(TA = -40 to +85°C, 2.4 V ≤ VDD ≤ 5.5 V, VSS = EVSS0 = EVSS1 = 0 V, HS (high-speed main) mode)

| Parameter | Symbol | Conditions | MIN. | TYP. | MAX. | Unit |
|-----------------------------------|---------|--|------|------|------|-------|
| Temperature sensor output voltage | VTMPS25 | Setting ADS register = 80H, TA = +25°C | | 1.05 | | V |
| Internal reference voltage | VBGR | Setting ADS register = 81H | 1.38 | 1.45 | 1.5 | V |
| Temperature coefficient | FVTMPS | Temperature sensor that depends on the temperature | | -3.6 | | mV/°C |
| Operation stabilization wait time | tAMP | | 5 | | | μs |

2.6.3 D/A converter characteristics

(TA = -40 to +85°C, 1.6 V ≤ EVSS0 = EVSS1 ≤ VDD ≤ 5.5 V, VSS = EVSS0 = EVSS1 = 0 V)

| Parameter | Symbol | Conditions | | MIN. | TYP. | MAX. | Unit |
|---------------|--------|---------------|---------------------|------|------|------|------|
| Resolution | RES | | | | | 8 | bit |
| Overall error | AINL | Rload = 4 MΩ | 1.8 V ≤ VDD ≤ 5.5 V | | | ±2.5 | LSB |
| | | Rload = 8 MΩ | 1.8 V ≤ VDD ≤ 5.5 V | | | ±2.5 | LSB |
| Settling time | tSET | Cload = 20 pF | 2.7 V ≤ VDD ≤ 5.5 V | | | 3 | μs |
| | | | 1.6 V ≤ VDD < 2.7 V | | | 6 | μs |

2.6.4 Comparator

(TA = -40 to +85°C, 1.6 V ≤ EVDD0 = EVDD1 ≤ VDD ≤ 5.5 V, VSS = EVSS0 = EVSS1 = 0 V)

| Parameter | Symbol | Conditions | MIN. | TYP. | MAX. | Unit | |
|--|--------|--|--|----------|-------------|------|----|
| Input voltage range | Ivref | | 0 | | EVDD0 - 1.4 | V | |
| | Ivcmp | | -0.3 | | EVDD0 + 0.3 | V | |
| Output delay | td | VDD = 3.0 V Input slew rate > 50 mV/μs | Comparator high-speed mode, standard mode | | | 1.2 | μs |
| | | | Comparator high-speed mode, window mode | | | 2.0 | μs |
| | | | Comparator low-speed mode, standard mode | | 3.0 | 5.0 | μs |
| High-electric-potential reference voltage | VTW+ | Comparator high-speed mode, window mode | | 0.76 VDD | | V | |
| Low-electric-potential reference voltage | VTW- | Comparator high-speed mode, window mode | | 0.24 VDD | | V | |
| Operation stabilization wait time | tcMP | | 100 | | | μs | |
| Internal reference voltage Note | VBGR | 2.4 V ≤ VDD ≤ 5.5 V, HS (high-speed main) mode | 1.38 | 1.45 | 1.50 | V | |

Note Not usable in LS (low-speed main) mode, LV (low-voltage main) mode, sub-clock operation, or STOP mode.

2.6.5 POR circuit characteristics

(TA = -40 to +85°C, VSS = 0 V)

| Parameter | Symbol | Conditions | MIN. | TYP. | MAX. | Unit |
|-------------------------------|--------|---|------|------|------|------|
| Power on/down reset threshold | VPOR | Voltage threshold on VDD rising | 1.47 | 1.51 | 1.55 | V |
| | VPDR | Voltage threshold on VDD falling Note 1 | 1.46 | 1.50 | 1.54 | V |
| Minimum pulse width Note 2 | TPW | | 300 | | | μs |

Note 1. However, when the operating voltage falls while the LVD is off, enter STOP mode, or enable the reset status using the external reset pin before the voltage falls below the operating voltage range shown in 2.4 AC Characteristics.

Note 2. Minimum time required for a POR reset when VDD exceeds below VPDR. This is also the minimum time required for a POR reset from when VDD exceeds below 0.7 V to when VDD exceeds VPOR while STOP mode is entered or the main system clock is stopped through setting bit 0 (HIOSTOP) and bit 7 (MSTOP) in the clock operation status control register (CSC).

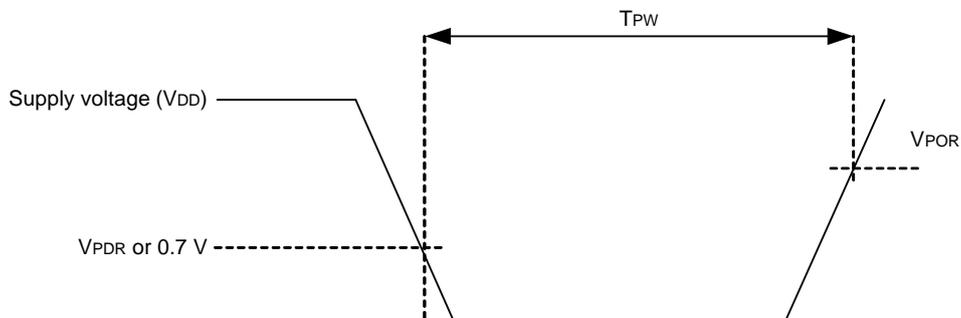

2.6.6 LVD circuit characteristics

(1) Reset Mode and Interrupt Mode

(TA = -40 to +85°C, VPDR ≤ VDD ≤ 5.5 V, VSS = 0 V)

| Parameter | | Symbol | Conditions | MIN. | TYP. | MAX. | Unit |
|-----------------------------|----------------------|--------|--------------|------|------|------|------|
| Voltage detection threshold | Supply voltage level | VLVD0 | Rising edge | 3.98 | 4.06 | 4.14 | V |
| | | | Falling edge | 3.90 | 3.98 | 4.06 | V |
| | | VLVD1 | Rising edge | 3.68 | 3.75 | 3.82 | V |
| | | | Falling edge | 3.60 | 3.67 | 3.74 | V |
| | | VLVD2 | Rising edge | 3.07 | 3.13 | 3.19 | V |
| | | | Falling edge | 3.00 | 3.06 | 3.12 | V |
| | | VLVD3 | Rising edge | 2.96 | 3.02 | 3.08 | V |
| | | | Falling edge | 2.90 | 2.96 | 3.02 | V |
| | | VLVD4 | Rising edge | 2.86 | 2.92 | 2.97 | V |
| | | | Falling edge | 2.80 | 2.86 | 2.91 | V |
| | | VLVD5 | Rising edge | 2.76 | 2.81 | 2.87 | V |
| | | | Falling edge | 2.70 | 2.75 | 2.81 | V |
| | | VLVD6 | Rising edge | 2.66 | 2.71 | 2.76 | V |
| | | | Falling edge | 2.60 | 2.65 | 2.70 | V |
| | | VLVD7 | Rising edge | 2.56 | 2.61 | 2.66 | V |
| | | | Falling edge | 2.50 | 2.55 | 2.60 | V |
| | | VLVD8 | Rising edge | 2.45 | 2.50 | 2.55 | V |
| | | | Falling edge | 2.40 | 2.45 | 2.50 | V |
| | | VLVD9 | Rising edge | 2.05 | 2.09 | 2.13 | V |
| | | | Falling edge | 2.00 | 2.04 | 2.08 | V |
| | | VLVD10 | Rising edge | 1.94 | 1.98 | 2.02 | V |
| | | | Falling edge | 1.90 | 1.94 | 1.98 | V |
| | | VLVD11 | Rising edge | 1.84 | 1.88 | 1.91 | V |
| | | | Falling edge | 1.80 | 1.84 | 1.87 | V |
| | | VLVD12 | Rising edge | 1.74 | 1.77 | 1.81 | V |
| | | | Falling edge | 1.70 | 1.73 | 1.77 | V |
| VLVD13 | Rising edge | 1.64 | 1.67 | 1.70 | V | | |
| | Falling edge | 1.60 | 1.63 | 1.66 | V | | |
| Minimum pulse width | tLW | | 300 | | | μs | |
| Detection delay time | | | | | 300 | μs | |

(2) Interrupt & Reset Mode**(TA = -40 to +85°C, VPDR ≤ VDD ≤ 5.5 V, VSS = 0 V)**

| Parameter | Symbol | Conditions | MIN. | TYP. | MAX. | Unit | |
|-----------------------------|--|--|------------------------------|------|------|------|---|
| Voltage detection threshold | VLVDA0 | VPOC2, VPOC1, VPOC0 = 0, 0, 0, falling reset voltage | 1.60 | 1.63 | 1.66 | V | |
| | VLVDA1 | LVIS1, LVIS0 = 1, 0 | Rising release reset voltage | 1.74 | 1.77 | 1.81 | V |
| | | | Falling interrupt voltage | 1.70 | 1.73 | 1.77 | V |
| | VLVDA2 | LVIS1, LVIS0 = 0, 1 | Rising release reset voltage | 1.84 | 1.88 | 1.91 | V |
| | | | Falling interrupt voltage | 1.80 | 1.84 | 1.87 | V |
| | VLVDA3 | LVIS1, LVIS0 = 0, 0 | Rising release reset voltage | 2.86 | 2.92 | 2.97 | V |
| | | | Falling interrupt voltage | 2.80 | 2.86 | 2.91 | V |
| | VLVDB0 | VPOC2, VPOC1, VPOC0 = 0, 0, 1, falling reset voltage | 1.80 | 1.84 | 1.87 | V | |
| | VLVDB1 | LVIS1, LVIS0 = 1, 0 | Rising release reset voltage | 1.94 | 1.98 | 2.02 | V |
| | | | Falling interrupt voltage | 1.90 | 1.94 | 1.98 | V |
| | VLVDB2 | LVIS1, LVIS0 = 0, 1 | Rising release reset voltage | 2.05 | 2.09 | 2.13 | V |
| | | | Falling interrupt voltage | 2.00 | 2.04 | 2.08 | V |
| VLVDB3 | LVIS1, LVIS0 = 0, 0 | Rising release reset voltage | 3.07 | 3.13 | 3.19 | V | |
| | | Falling interrupt voltage | 3.00 | 3.06 | 3.12 | V | |
| VLVDC0 | VPOC2, VPOC1, VPOC0 = 0, 1, 0, falling reset voltage | 2.40 | 2.45 | 2.50 | V | | |
| VLVDC1 | LVIS1, LVIS0 = 1, 0 | Rising release reset voltage | 2.56 | 2.61 | 2.66 | V | |
| | | Falling interrupt voltage | 2.50 | 2.55 | 2.60 | V | |
| VLVDC2 | LVIS1, LVIS0 = 0, 1 | Rising release reset voltage | 2.66 | 2.71 | 2.76 | V | |
| | | Falling interrupt voltage | 2.60 | 2.65 | 2.70 | V | |
| VLVDC3 | LVIS1, LVIS0 = 0, 0 | Rising release reset voltage | 3.68 | 3.75 | 3.82 | V | |
| | | Falling interrupt voltage | 3.60 | 3.67 | 3.74 | V | |
| VLVDD0 | VPOC2, VPOC1, VPOC0 = 0, 1, 1, falling reset voltage | 2.70 | 2.75 | 2.81 | V | | |
| VLVDD1 | LVIS1, LVIS0 = 1, 0 | Rising release reset voltage | 2.86 | 2.92 | 2.97 | V | |
| | | Falling interrupt voltage | 2.80 | 2.86 | 2.91 | V | |
| VLVDD2 | LVIS1, LVIS0 = 0, 1 | Rising release reset voltage | 2.96 | 3.02 | 3.08 | V | |
| | | Falling interrupt voltage | 2.90 | 2.96 | 3.02 | V | |
| VLVDD3 | LVIS1, LVIS0 = 0, 0 | Rising release reset voltage | 3.98 | 4.06 | 4.14 | V | |
| | | Falling interrupt voltage | 3.90 | 3.98 | 4.06 | V | |

2.6.7 Power supply voltage rising slope characteristics**(TA = -40 to +85°C, VSS = 0 V)**

| Parameter | Symbol | Conditions | MIN. | TYP. | MAX. | Unit |
|-----------------------------------|--------|------------|------|------|------|------|
| Power supply voltage rising slope | SVDD | | | | 54 | V/ms |

Caution Make sure to keep the internal reset state by the LVD circuit or an external reset until VDD reaches the operating voltage range shown in 2.4 AC Characteristics.

2.7 RAM Data Retention Characteristics

(TA = -40 to +85°C, VSS = 0V)

| Parameter | Symbol | Conditions | MIN. | TYP. | MAX. | Unit |
|-------------------------------|--------|------------|-----------|------|------|------|
| Data retention supply voltage | VDDDR | | 1.46 Note | | 5.5 | V |

Note The value depends on the POR detection voltage. When the voltage drops, the RAM data is retained before a POR reset is effected, but RAM data is not retained when a POR reset is effected.

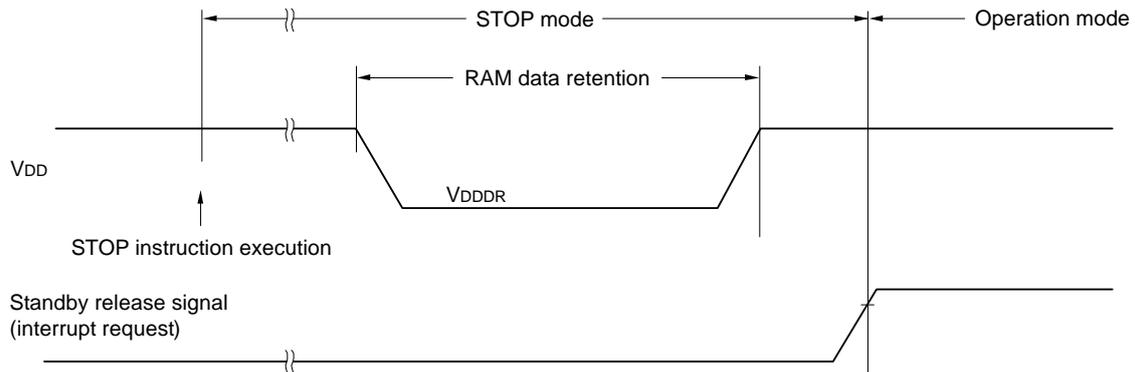

2.8 Flash Memory Programming Characteristics

(TA = -40 to +85°C, 1.8 V ≤ VDD ≤ 5.5 V, VSS = 0 V)

| Parameter | Symbol | Conditions | MIN. | TYP. | MAX. | Unit |
|--|-------------------|------------------------------------|---------|-----------|------|-------|
| System clock frequency | fCLK | 1.8 V ≤ VDD ≤ 5.5 V | 1 | | 32 | MHz |
| Number of code flash rewrites Notes 1, 2, 3 | C _{erwr} | Retained for 20 years TA = 85°C | 1,000 | | | Times |
| Number of data flash rewrites Notes 1, 2, 3 | | Retained for 1 year TA = 25°C | | 1,000,000 | | |
| | | Retained for 5 years TA = 85°C | 100,000 | | | |
| | | Retained for 20 years TA = 85°C | 10,000 | | | |

Note 1. 1 erase + 1 write after the erase is regarded as 1 rewrite. The retaining years are until next rewrite after the rewrite.

Note 2. When using flash memory programmer and Renesas Electronics self-programming library

Note 3. These are the characteristics of the flash memory and the results obtained from reliability testing by Renesas Electronics Corporation.

2.9 Dedicated Flash Memory Programmer Communication (UART)

(TA = -40 to +85°C, 1.8 V ≤ EVDD0 = EVDD1 ≤ VDD ≤ 5.5 V, VSS = EVSS0 = EVSS1 = 0 V)

| Parameter | Symbol | Conditions | MIN. | TYP. | MAX. | Unit |
|---------------|--------|---------------------------|---------|------|-----------|------|
| Transfer rate | | During serial programming | 115,200 | | 1,000,000 | bps |

2.10 Timing of Entry to Flash Memory Programming Modes

(TA = -40 to +85°C, 1.8 V ≤ EVDD0 = EVDD1 ≤ VDD ≤ 5.5 V, VSS = EVSS0 = EVSS1 = 0 V)

| Parameter | Symbol | Conditions | MIN. | TYP. | MAX. | Unit |
|---|---------|--|------|------|------|------|
| How long from when an external reset ends until the initial communication settings are specified | tsuINIT | POR and LVD reset must end before the external reset ends. | | | 100 | ms |
| How long from when the TOOL0 pin is placed at the low level until an external reset ends | tsu | POR and LVD reset must end before the external reset ends. | 10 | | | μs |
| How long the TOOL0 pin must be kept at the low level after an external reset ends (excluding the processing time of the firmware to control the flash memory) | tHD | POR and LVD reset must end before the external reset ends. | 1 | | | ms |

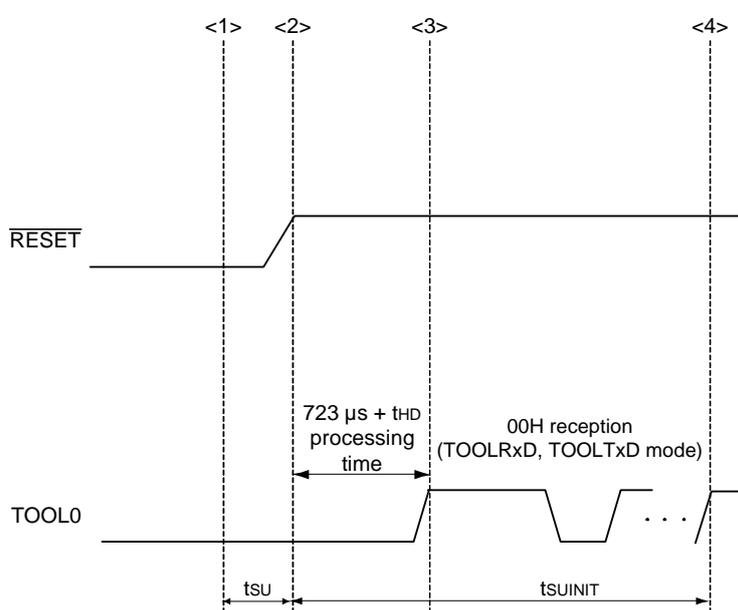

- <1> The low level is input to the TOOL0 pin.
- <2> The external reset ends (POR and LVD reset must end before the external reset ends).
- <3> The TOOL0 pin is set to the high level.
- <4> Setting of the flash memory programming mode by UART reception and complete the baud rate setting.

Remark tsuINIT: The segment shows that it is necessary to finish specifying the initial communication settings within 100 ms from when the external resets end.

tsu: How long from when the TOOL0 pin is placed at the low level until a pin reset ends

tHD: How long to keep the TOOL0 pin at the low level from when the external resets end (excluding the processing time of the firmware to control the flash memory)

3. ELECTRICAL SPECIFICATIONS (G: INDUSTRIAL APPLICATIONS $T_A = -40$ to $+105^\circ\text{C}$)

This chapter describes the following electrical specifications.

Target products G: Industrial applications $T_A = -40$ to $+105^\circ\text{C}$

R5F104xxGxx

Caution 1. The RL78 microcontrollers have an on-chip debug function, which is provided for development and evaluation. Do not use the on-chip debug function in products designated for mass production, because the guaranteed number of rewritable times of the flash memory may be exceeded when this function is used, and product reliability therefore cannot be guaranteed. Renesas Electronics is not liable for problems occurring when the on-chip debug function is used.

Caution 2. With products not provided with an EVDD0, EVDD1, EVSS0, or EVSS1 pin, replace EVDD0 and EVDD1 with VDD, or replace EVSS0 and EVSS1 with VSS.

Caution 3. The pins mounted depend on the product. Refer to 2.1 Port Functions to 2.2.1 Functions for each product in the RL78/G14 User's Manual.

Caution 4. Please contact Renesas Electronics sales office for derating of operation under $T_A = +85$ to $+105^\circ\text{C}$. Derating is the systematic reduction of load for the sake of improved reliability.

Remark When RL78/G14 is used in the range of $T_A = -40$ to $+85^\circ\text{C}$, see 2. ELECTRICAL SPECIFICATIONS ($T_A = -40$ to $+85^\circ\text{C}$).

Operation of products rated “G: Industrial applications (TA = -40 to + 105°C)” at ambient operating temperatures above 85°C differs from that of products rated “A: Consumer applications” and “D: Industrial applications” in the ways listed below.

| Parameter | A: Consumer applications, D: Industrial applications | G: Industrial applications |
|--|--|---|
| Operating ambient temperature | TA = -40 to +85°C | TA = -40 to +105°C |
| Operating mode Operating voltage range | HS (high-speed main) mode: 2.7 V ≤ VDD ≤ 5.5 V@1 MHz to 32 MHz 2.4 V ≤ VDD ≤ 5.5 V@1 MHz to 16 MHz LS (low-speed main) mode: 1.8 V ≤ VDD ≤ 5.5 V@1 MHz to 8 MHz LV (low-voltage main) mode: 1.6 V ≤ VDD ≤ 5.5 V@1 MHz to 4 MHz | HS (high-speed main) mode only: 2.7 V ≤ VDD ≤ 5.5 V@1 MHz to 32 MHz 2.4 V ≤ VDD ≤ 5.5 V@1 MHz to 16 MHz |
| High-speed on-chip oscillator clock accuracy | 1.8 V ≤ VDD ≤ 5.5 V: ±1.0% @ TA = -20 to +85°C ±1.5% @ TA = -40 to -20°C 1.6 V ≤ VDD < 1.8 V: ±5.0% @ TA = -20 to +85°C ±5.5% @ TA = -40 to -20°C | 2.4 V ≤ VDD ≤ 5.5 V: ±2.0% @ TA = +85 to +105°C ±1.0% @ TA = -20 to +85°C ±1.5% @ TA = -40 to -20°C |
| Serial array unit | UART CSI: fCLK/2 (16 Mbps supported), fCLK/4 Simplified I ² C communication | UART CSI: fCLK/4 Simplified I ² C communication |
| IICA | Standard mode Fast mode Fast mode plus | Standard mode Fast mode |
| Voltage detector | <ul style="list-style-type: none"> Rising: 1.67 V to 4.06 V (14 stages) Falling: 1.63 V to 3.98 V (14 stages) | <ul style="list-style-type: none"> Rising: 2.61 V to 4.06 V (8 stages) Falling: 2.55 V to 3.98 V (8 stages) |

Remark The electrical characteristics of products rated “G: Industrial applications (TA = -40 to + 105°C)” at ambient operating temperatures above 85°C differ from those of products rated “A: Consumer applications” and “D: Industrial applications”. For details, refer to 3.1 to 3.10.

3.1 Absolute Maximum Ratings

Absolute Maximum Ratings

(1/2)

| Parameter | Symbols | Conditions | Ratings | Unit |
|------------------------|---------------------------------------|---|---|------|
| Supply voltage | V _{DD} | | -0.5 to +6.5 | V |
| | EV _{DD0} , EV _{DD1} | EV _{DD0} = EV _{DD1} | -0.5 to +6.5 | V |
| | EV _{SS0} , EV _{SS1} | EV _{SS0} = EV _{SS1} | -0.5 to +0.3 | V |
| REGC pin input voltage | V _{IREGC} | REGC | -0.3 to +2.8 and -0.3 to V _{DD} +0.3 Note 1 | V |
| Input voltage | V _{I1} | P00 to P06, P10 to P17, P30, P31, P40 to P47, P50 to P57, P64 to P67, P70 to P77, P80 to P87, P100 to P102, P110, P111, P120, P140 to P147 | -0.3 to EV _{DD0} +0.3 and -0.3 to V _{DD} +0.3 Note 2 | V |
| | V _{I2} | P60 to P63 (N-ch open-drain) | -0.3 to +6.5 | V |
| | V _{I3} | P20 to P27, P121 to P124, P137, P150 to P156, EXCLK, EXCLKS, $\overline{\text{RESET}}$ | -0.3 to V _{DD} +0.3 Note 2 | V |
| Output voltage | V _{O1} | P00 to P06, P10 to P17, P30, P31, P40 to P47, P50 to P57, P60 to P67, P70 to P77, P80 to P87, P100 to P102, P110, P111, P120, P130, P140 to P147 | -0.3 to EV _{DD0} +0.3 and -0.3 to V _{DD} +0.3 Note 2 | V |
| | V _{O2} | P20 to P27, P150 to P156 | -0.3 to V _{DD} +0.3 Note 2 | V |
| Analog input voltage | V _{AI1} | ANI16 to ANI20 | -0.3 to EV _{DD0} +0.3 and -0.3 to AV _{REF} (+) +0.3 Notes 2, 3 | V |
| | V _{AI2} | ANI0 to ANI14 | -0.3 to V _{DD} +0.3 and -0.3 to AV _{REF} (+) +0.3 Notes 2, 3 | V |

Note 1. Connect the REGC pin to V_{SS} via a capacitor (0.47 to 1 μF). This value regulates the absolute maximum rating of the REGC pin. Do not use this pin with voltage applied to it.

Note 2. Must be 6.5 V or lower.

Note 3. Do not exceed AV_{REF} (+) + 0.3 V in case of A/D conversion target pin.

Caution Product quality may suffer if the absolute maximum rating is exceeded even momentarily for any parameter. That is, the absolute maximum ratings are rated values at which the product is on the verge of suffering physical damage, and therefore the product must be used under conditions that ensure that the absolute maximum ratings are not exceeded.

Remark 1. Unless specified otherwise, the characteristics of alternate-function pins are the same as those of the port pins.

Remark 2. AV_{REF} (+): + side reference voltage of the A/D converter.

Remark 3. V_{SS}: Reference voltage

Absolute Maximum Ratings**(2/2)**

| Parameter | Symbols | Conditions | | Ratings | Unit |
|-------------------------------|----------------------------------|------------------------------|--|--|-------------|
| Output current, high | IOH1 | Per pin | P00 to P06, P10 to P17, P30, P31, P40 to P47, P50 to P57, P64 to P67, P70 to P77, P80 to P87, P100 to P102, P110, P111, P120, P130, P140 to P147 | -40 | mA |
| | | Total of all pins -170 mA | P00 to P04, P40 to P47, P102, P120, P130, P140 to P145 | -70 | mA |
| | | | P05, P06, P10 to P17, P30, P31, P50 to P57, P64 to P67, P70 to P77, P80 to P87, P100, P101, P110, P111, P146, P147 | -100 | mA |
| | IOH2 | Per pin | P20 to P27, P150 to P156 | -0.5 | mA |
| | | Total of all pins | | -2 | mA |
| | Output current, low | IOL1 | Per pin | P00 to P06, P10 to P17, P30, P31, P40 to P47, P50 to P57, P64 to P67, P70 to P77, P80 to P87, P100 to P102, P110, P111, P120, P130, P140 to P147 | 40 |
| Total of all pins 170 mA | | | P00 to P04, P40 to P47, P102, P120, P130, P140 to P145 | 70 | mA |
| | | | P05, P06, P10 to P17, P30, P31, P50 to P57, P60 to P67, P70 to P77, P80 to P87, P100, P101, P110, P111, P146, P147 | 100 | mA |
| IOL2 | | Per pin | P20 to P27, P150 to P156 | 1 | mA |
| | | Total of all pins | | 5 | mA |
| Operating ambient temperature | | TA | In normal operation mode | | -40 to +105 |
| | In flash memory programming mode | | | | |
| Storage temperature | Tstg | | | -65 to +150 | °C |

Caution Product quality may suffer if the absolute maximum rating is exceeded even momentarily for any parameter. That is, the absolute maximum ratings are rated values at which the product is on the verge of suffering physical damage, and therefore the product must be used under conditions that ensure that the absolute maximum ratings are not exceeded.

Remark Unless specified otherwise, the characteristics of alternate-function pins are the same as those of the port pins.

3.2 Oscillator Characteristics

3.2.1 X1, XT1 characteristics

(TA = -40 to +105°C, 2.4 V ≤ VDD ≤ 5.5 V, VSS = 0 V)

| Resonator | Resonator | Conditions | MIN. | TYP. | MAX. | Unit |
|---|---|---------------------|------|--------|------|------|
| X1 clock oscillation frequency (fX) ^{Note} | Ceramic resonator/ crystal resonator | 2.7 V ≤ VDD ≤ 5.5 V | 1.0 | | 20.0 | MHz |
| | | 2.4 V ≤ VDD < 2.7 V | 1.0 | | 16.0 | |
| XT1 clock oscillation frequency (fXT) ^{Note} | Crystal resonator | | 32 | 32.768 | 35 | kHz |

Note Indicates only permissible oscillator frequency ranges. Refer to **AC Characteristics** for instruction execution time. Request evaluation by the manufacturer of the oscillator circuit mounted on a board to check the oscillator characteristics.

Caution Since the CPU is started by the high-speed on-chip oscillator clock after a reset release, check the X1 clock oscillation stabilization time using the oscillation stabilization time counter status register (OSTC) by the user. Determine the oscillation stabilization time of the OSTC register and the oscillation stabilization time select register (OSTS) after sufficiently evaluating the oscillation stabilization time with the resonator to be used.

Remark When using the X1 oscillator and XT1 oscillator, refer to 5.4 System Clock Oscillator in the RL78/G14 User's Manual.

3.2.2 On-chip oscillator characteristics

(TA = -40 to +105°C, 2.4 V ≤ VDD ≤ 5.5 V, VSS = 0 V)

| Oscillators | Parameters | Conditions | | MIN. | TYP. | MAX. | Unit |
|---|----------------|---------------|---------------------|------|------|------|------|
| High-speed on-chip oscillator clock frequency Notes 1, 2 | f _H | | | 1 | | 32 | MHz |
| High-speed on-chip oscillator clock frequency accuracy | | -20 to +85°C | 2.4 V ≤ VDD ≤ 5.5 V | -1.0 | | +1.0 | % |
| | | -40 to -20°C | 2.4 V ≤ VDD ≤ 5.5 V | -1.5 | | +1.5 | % |
| | | +85 to +105°C | 2.4 V ≤ VDD ≤ 5.5 V | -2.0 | | +2.0 | % |
| Low-speed on-chip oscillator clock frequency | f _L | | | | 15 | | kHz |
| Low-speed on-chip oscillator clock frequency accuracy | | | | -15 | | +15 | % |

Note 1. High-speed on-chip oscillator frequency is selected with bits 0 to 4 of the option byte (000C2H) and bits 0 to 2 of the HOCODIV register.

Note 2. This only indicates the oscillator characteristics. Refer to **AC Characteristics** for instruction execution time.

3.3 DC Characteristics

3.3.1 Pin characteristics

(TA = -40 to +105°C, 2.4 V ≤ EVDD0 = EVDD1 ≤ VDD ≤ 5.5 V, VSS = EVSS0 = EVSS1 = 0 V)

(1/5)

| Items | Symbol | Conditions | MIN. | TYP. | MAX. | Unit | |
|--|---|---|-----------------------|------|-------|----------------|----|
| Output current, high ^{Note 1} | IOH1 | Per pin for P00 to P06, P10 to P17, P30, P31, P40 to P47, P50 to P57, P64 to P67, P70 to P77, P80 to P87, P100 to P102, P110, P111, P120, P130, P140 to P147 | 2.4 V ≤ EVDD0 ≤ 5.5 V | | | -3.0 Note 2 | mA |
| | | Total of P00 to P04, P40 to P47, P102, P120, P130, P140 to P145 (When duty ≤ 70% ^{Note 3}) | 4.0 V ≤ EVDD0 ≤ 5.5 V | | | -30.0 | mA |
| | | | 2.7 V ≤ EVDD0 < 4.0 V | | | -10.0 | mA |
| | | | 2.4 V ≤ EVDD0 < 2.7 V | | | -5.0 | mA |
| | | Total of P05, P06, P10 to P17, P30, P31, P50 to P57, P64 to P67, P70 to P77, P80 to P87, P100, P101, P110, P111, P146, P147 (When duty ≤ 70% ^{Note 3}) | 4.0 V ≤ EVDD0 ≤ 5.5 V | | | -30.0 | mA |
| | | | 2.7 V ≤ EVDD0 < 4.0 V | | | -19.0 | mA |
| | 2.4 V ≤ EVDD0 < 2.7 V | | | | -10.0 | mA | |
| | Total of all pins (When duty ≤ 70% ^{Note 3}) | 2.4 V ≤ EVDD0 ≤ 5.5 V | | | -60.0 | mA | |
| | IOH2 | Per pin for P20 to P27, P150 to P156 | 2.4 V ≤ VDD ≤ 5.5 V | | | -0.1 Note 2 | mA |
| | | Total of all pins (When duty ≤ 70% ^{Note 3}) | 2.4 V ≤ VDD ≤ 5.5 V | | | -1.5 | mA |

Note 1. Value of current at which the device operation is guaranteed even if the current flows from the EVDD0, EVDD1, VDD pins to an output pin.

Note 2. Do not exceed the total current value.

Note 3. Specification under conditions where the duty factor ≤ 70%.

The output current value that has changed to the duty factor > 70% the duty ratio can be calculated with the following expression (when changing the duty factor from 70% to n%).

- Total output current of pins = (IOH × 0.7)/(n × 0.01)

<Example> Where n = 80% and IOH = -10.0 mA

$$\text{Total output current of pins} = (-10.0 \times 0.7)/(80 \times 0.01) \approx -8.7 \text{ mA}$$

However, the current that is allowed to flow into one pin does not vary depending on the duty factor.

A current higher than the absolute maximum rating must not flow into one pin.

Caution P00, P02 to P04, P10, P11, P13 to P15, P17, P30, P43 to P45, P50 to P55, P71, P74, P80 to P82, and P142 to P144 do not output high level in N-ch open-drain mode.

Remark Unless specified otherwise, the characteristics of alternate-function pins are the same as those of the port pins.

(TA = -40 to +105°C, 2.4 V ≤ EVDD0 = EVDD1 ≤ VDD ≤ 5.5 V, VSS = EVSS0 = EVSS1 = 0 V)

(2/5)

| Items | Symbol | Conditions | MIN. | TYP. | MAX. | Unit |
|---------------------------------------|---|---|-----------------------|---------------|----------------|------|
| Output current, low ^{Note 1} | IOL1 | Per pin for P00 to P06, P10 to P17, P30, P31, P40 to P47, P50 to P57, P64 to P67, P70 to P77, P80 to P87, P100 to P102, P110, P111, P120, P130, P140 to P147 | | | 8.5 Note 2 | mA |
| | | | | | 15.0 Note 2 | mA |
| | | | | | 40.0 | mA |
| | | Total of P00 to P04, P40 to P47, P102, P120, P130, P140 to P145 (When duty ≤ 70% ^{Note 3}) | 4.0 V ≤ EVDD0 ≤ 5.5 V | | 40.0 | mA |
| | | | 2.7 V ≤ EVDD0 < 4.0 V | | 15.0 | mA |
| | | | 2.4 V ≤ EVDD0 < 2.7 V | | 9.0 | mA |
| | | Total of P05, P06, P10 to P17, P30, P31, P50 to P57, P60 to P67, P70 to P77, P80 to P87, P100, P101, P110, P111, P146, P147 (When duty ≤ 70% ^{Note 3}) | 4.0 V ≤ EVDD0 ≤ 5.5 V | | 40.0 | mA |
| | 2.7 V ≤ EVDD0 < 4.0 V | | | 35.0 | mA | |
| | 2.4 V ≤ EVDD0 < 2.7 V | | | 20.0 | mA | |
| | Total of all pins (When duty ≤ 70% ^{Note 3}) | | | 80.0 | mA | |
| IOL2 | Per pin for P20 to P27, P150 to P156 | | | 0.4 Note 2 | mA | |
| | | 2.4 V ≤ VDD ≤ 5.5 V | | 5.0 | mA | |

Note 1. Value of current at which the device operation is guaranteed even if the current flows from an output pin to the EVSS0, EVSS1, and VSS pins.

Note 2. Do not exceed the total current value.

Note 3. Specification under conditions where the duty factor ≤ 70%.

The output current value that has changed to the duty factor > 70% the duty ratio can be calculated with the following expression (when changing the duty factor from 70% to n%).

- Total output current of pins = (IOL × 0.7)/(n × 0.01)

<Example> Where n = 80% and IOL = 10.0 mA

$$\text{Total output current of pins} = (10.0 \times 0.7)/(80 \times 0.01) \approx 8.7 \text{ mA}$$

However, the current that is allowed to flow into one pin does not vary depending on the duty factor.

A current higher than the absolute maximum rating must not flow into one pin.

Remark Unless specified otherwise, the characteristics of alternate-function pins are the same as those of the port pins.

(TA = -40 to +105°C, 2.4 V ≤ EVDD0 = EVDD1 ≤ VDD ≤ 5.5 V, VSS = EVSS0 = EVSS1 = 0 V)

(3/5)

| Items | Symbol | Conditions | MIN. | TYP. | MAX. | Unit | |
|---------------------|--|--|---|-----------|---------|-----------|---|
| Input voltage, high | VIH1 | P00 to P06, P10 to P17, P30, P31, P40 to P47, P50 to P57, P64 to P67, P70 to P77, P80 to P87, P100 to P102, P110, P111, P120, P140 to P147 | Normal input buffer | 0.8 EVDD0 | | EVDD0 | V |
| | VIH2 | P01, P03, P04, P10, P14 to P17, P30, P43, P44, P50, P53 to P55, P80, P81, P142, P143 | TTL input buffer 4.0 V ≤ EVDD0 ≤ 5.5 V | 2.2 | | EVDD0 | V |
| | | | TTL input buffer 3.3 V ≤ EVDD0 < 4.0 V | 2.0 | | EVDD0 | V |
| | | | TTL input buffer 2.4 V ≤ EVDD0 < 3.3 V | 1.5 | | EVDD0 | V |
| | VIH3 | P20 to P27, P150 to P156 | | 0.7 VDD | | VDD | V |
| | VIH4 | P60 to P63 | | 0.7 EVDD0 | | 6.0 | V |
| VIH5 | P121 to P124, P137, EXCLK, EXCLKS, RESET | | 0.8 VDD | | VDD | V | |
| Input voltage, low | VIL1 | P00 to P06, P10 to P17, P30, P31, P40 to P47, P50 to P57, P64 to P67, P70 to P77, P80 to P87, P100 to P102, P110, P111, P120, P140 to P147 | Normal input buffer | 0 | | 0.2 EVDD0 | V |
| | VIL2 | P01, P03, P04, P10, P14 to P17, P30, P43, P44, P50, P53 to P55, P80, P81, P142, P143 | TTL input buffer 4.0 V ≤ EVDD0 ≤ 5.5 V | 0 | | 0.8 | V |
| | | | TTL input buffer 3.3 V ≤ EVDD0 < 4.0 V | 0 | | 0.5 | V |
| | | | TTL input buffer 2.4 V ≤ EVDD0 < 3.3 V | 0 | | 0.32 | V |
| | VIL3 | P20 to P27, P150 to P156 | | 0 | | 0.3 VDD | V |
| | VIL4 | P60 to P63 | | 0 | | 0.3 EVDD0 | V |
| VIL5 | P121 to P124, P137, EXCLK, EXCLKS, RESET | | 0 | | 0.2 VDD | V | |

Caution The maximum value of VIH of pins P00, P02 to P04, P10, P11, P13 to P15, P17, P30, P43 to P45, P50 to P55, P71, P74, P80 to P82, and P142 to P144 is EVDD0, even in the N-ch open-drain mode.

Remark Unless specified otherwise, the characteristics of alternate-function pins are the same as those of the port pins.

(TA = -40 to +105°C, 2.4 V ≤ EVDD0 = EVDD1 ≤ VDD ≤ 5.5 V, VSS = EVSS0 = EVSS1 = 0 V)

(4/5)

| Items | Symbol | Conditions | MIN. | TYP. | MAX. | Unit | |
|----------------------|--------|--|--|------|-------------|------|---|
| Output voltage, high | VOH1 | P00 to P06, P10 to P17, P30, P31, P40 to P47, P50 to P57, P64 to P67, P70 to P77, P80 to P87, P100 to P102, P110, P111, P120, P130, P140 to P147 | 4.0 V ≤ EVDD0 ≤ 5.5 V, IOH1 = -3.0 mA | | EVDD0 - 0.7 | V | |
| | | | 2.7 V ≤ EVDD0 ≤ 5.5 V, IOH1 = -2.0 mA | | EVDD0 - 0.6 | V | |
| | | | 2.4 V ≤ EVDD0 ≤ 5.5 V, IOH1 = -1.5 mA | | EVDD0 - 0.5 | V | |
| | VOH2 | P20 to P27, P150 to P156 | 2.4 V ≤ VDD ≤ 5.5 V, IOH2 = -100 μA | | VDD - 0.5 | V | |
| Output voltage, low | VOL1 | P00 to P06, P10 to P17, P30, P31, P40 to P47, P50 to P57, P64 to P67, P70 to P77, P80 to P87, P100 to P102, P110, P111, P120, P130, P140 to P147 | 4.0 V ≤ EVDD0 ≤ 5.5 V, IOL1 = 8.5 mA | | | 0.7 | V |
| | | | 2.7 V ≤ EVDD0 ≤ 5.5 V, IOL1 = 3.0 mA | | | 0.6 | V |
| | | | 2.7 V ≤ EVDD0 ≤ 5.5 V, IOL1 = 1.5 mA | | | 0.4 | V |
| | | | 2.4 V ≤ EVDD0 ≤ 5.5 V, IOL1 = 0.6 mA | | | 0.4 | V |
| | VOL2 | P20 to P27, P150 to P156 | 2.4 V ≤ VDD ≤ 5.5 V, IOL2 = 400 μA | | | 0.4 | V |
| | VOL3 | P60 to P63 | 4.0 V ≤ EVDD0 ≤ 5.5 V, IOL3 = 15.0 mA | | | 2.0 | V |
| | | | 4.0 V ≤ EVDD0 ≤ 5.5 V, IOL3 = 5.0 mA | | | 0.4 | V |
| | | | 2.7 V ≤ EVDD0 ≤ 5.5 V, IOL3 = 3.0 mA | | | 0.4 | V |
| | | | 2.4 V ≤ EVDD0 ≤ 5.5 V, IOL3 = 2.0 mA | | | 0.4 | V |

Caution P00, P02 to P04, P10, P11, P13 to P15, P17, P30, P43 to P45, P50 to P55, P71, P74, P80 to P82, P142 to P144 do not output high level in N-ch open-drain mode.

Remark Unless specified otherwise, the characteristics of alternate-function pins are the same as those of the port pins.

(TA = -40 to +105°C, 2.4 V ≤ EVDD0 = EVDD1 ≤ VDD ≤ 5.5 V, VSS = EVSS0 = EVSS1 = 0 V)

(5/5)

| Items | Symbol | Conditions | MIN. | TYP. | MAX. | Unit | | |
|-----------------------------|--------|--|---------------------------|---------------------------------------|------|------|-----|----|
| Input leakage current, high | ILIH1 | P00 to P06, P10 to P17, P30, P31, P40 to P47, P50 to P57, P64 to P67, P70 to P77, P80 to P87, P100 to P102, P110, P111, P120, P140 to P147 | Vi = EVDD0 | | | 1 | μA | |
| | ILIH2 | P20 to P27, P137, P150 to P156, RESET | Vi = VDD | | | 1 | μA | |
| | ILIH3 | P121 to P124 (X1, X2, EXCLK, XT1, XT2, EXCLKS) | Vi = VDD | In input port or external clock input | | 1 | μA | |
| | | | | In resonator connection | | 10 | μA | |
| Input leakage current, low | ILIL1 | P00 to P06, P10 to P17, P30, P31, P40 to P47, P50 to P57, P64 to P67, P70 to P77, P80 to P87, P100 to P102, P110, P111, P120, P140 to P147 | Vi = EVSS0 | | | -1 | μA | |
| | ILIL2 | P20 to P27, P137, P150 to P156, RESET | Vi = VSS | | | -1 | μA | |
| | ILIL3 | P121 to P124 (X1, X2, EXCLK, XT1, XT2, EXCLKS) | Vi = VSS | In input port or external clock input | | -1 | μA | |
| | | | | In resonator connection | | -10 | μA | |
| On-chip pull-up resistance | Ru | P00 to P06, P10 to P17, P30, P31, P40 to P47, P50 to P57, P64 to P67, P70 to P77, P80 to P87, P100 to P102, P110, P111, P120, P140 to P147 | Vi = EVSS0, In input port | | 10 | 20 | 100 | kΩ |

Remark Unless specified otherwise, the characteristics of alternate-function pins are the same as those of the port pins.

3.3.2 Supply current characteristics

(1) Flash ROM: 16 to 64 KB of 30- to 64-pin products

(TA = -40 to +105°C, 2.4 V ≤ EVDD0 ≤ VDD ≤ 5.5 V, VSS = EVSS0 = 0 V)

(1/2)

| Parameter | Symbol | Conditions | | | | MIN. | TYP. | MAX. | Unit | |
|---------------------------|--|--|-------------------------------------|--|----------------------|-------------|------|------|------|----|
| Supply current Note 1 | IDD1 | Operating mode | HS (high-speed main) mode Note 5 | fHOCO = 64 MHz, fIH = 32 MHz Note 3 | Basic operation | VDD = 5.0 V | | 2.4 | | mA |
| | | | | | | VDD = 3.0 V | | 2.4 | | |
| | | | | fHOCO = 32 MHz, fIH = 32 MHz Note 3 | Basic operation | VDD = 5.0 V | | 2.1 | | |
| | | | | | | VDD = 3.0 V | | 2.1 | | |
| | | | HS (high-speed main) mode Note 5 | fHOCO = 64 MHz, fIH = 32 MHz Note 3 | Normal operation | VDD = 5.0 V | | 5.1 | 9.3 | mA |
| | | | | | | VDD = 3.0 V | | 5.1 | 9.3 | |
| | | | | fHOCO = 32 MHz, fIH = 32 MHz Note 3 | Normal operation | VDD = 5.0 V | | 4.8 | 8.7 | |
| | | | | | | VDD = 3.0 V | | 4.8 | 8.7 | |
| | | | | fHOCO = 48 MHz, fIH = 24 MHz Note 3 | Normal operation | VDD = 5.0 V | | 4.0 | 7.3 | |
| | | | | | | VDD = 3.0 V | | 4.0 | 7.3 | |
| | | fHOCO = 24 MHz, fIH = 24 MHz Note 3 | Normal operation | VDD = 5.0 V | | 3.8 | 6.7 | | | |
| | | | | VDD = 3.0 V | | 3.8 | 6.7 | | | |
| | | fHOCO = 16 MHz, fIH = 16 MHz Note 3 | Normal operation | VDD = 5.0 V | | 2.8 | 4.9 | | | |
| | | | | VDD = 3.0 V | | 2.8 | 4.9 | | | |
| | | HS (high-speed main) mode Note 5 | fMX = 20 MHz Note 2, VDD = 5.0 V | Normal operation | Square wave input | | 3.3 | 5.7 | mA | |
| | | | | | Resonator connection | | 3.4 | 5.8 | | |
| | | | | Normal operation | Square wave input | | 3.3 | 5.7 | | |
| | | | | | Resonator connection | | 3.4 | 5.8 | | |
| | | | fMX = 10 MHz Note 2, VDD = 5.0 V | Normal operation | Square wave input | | 2.0 | 3.4 | | |
| | | | | | Resonator connection | | 2.1 | 3.5 | | |
| Normal operation | Square wave input | | | | 2.0 | 3.4 | | | | |
| | Resonator connection | | | | 2.1 | 3.5 | | | | |
| Subsystem clock operation | fSUB = 32.768 kHz Note 4 TA = -40°C | Normal operation | Square wave input | | 4.7 | 6.1 | μA | | | |
| | | | Resonator connection | | 4.7 | 6.1 | | | | |
| | | Normal operation | Square wave input | | 4.7 | 6.1 | | | | |
| | | | Resonator connection | | 4.7 | 6.1 | | | | |
| | | Normal operation | Square wave input | | 4.8 | 6.7 | | | | |
| | | | Resonator connection | | 4.8 | 6.7 | | | | |
| | fSUB = 32.768 kHz Note 4 TA = +25°C | Normal operation | Square wave input | | 4.8 | 7.5 | | | | |
| | | | Resonator connection | | 4.8 | 7.5 | | | | |
| | | Normal operation | Square wave input | | 5.4 | 8.9 | | | | |
| | | | Resonator connection | | 5.4 | 8.9 | | | | |
| | | Normal operation | Square wave input | | 7.2 | 21.0 | | | | |
| | | | Resonator connection | | 7.3 | 21.1 | | | | |

(Notes and Remarks are listed on the next page.)

- Note 1.** Total current flowing into V_{DD} and EV_{DD0} , including the input leakage current flowing when the level of the input pin is fixed to V_{DD} , EV_{DD0} or V_{SS} , EV_{SS0} . The values below the MAX. column include the peripheral operation current. However, not including the current flowing into the A/D converter, LVD circuit, I/O port, and on-chip pull-up/pull-down resistors and the current flowing during data flash rewrite.
- Note 2.** When high-speed on-chip oscillator and subsystem clock are stopped.
- Note 3.** When high-speed system clock and subsystem clock are stopped.
- Note 4.** When high-speed on-chip oscillator and high-speed system clock are stopped. When AMPHS1 = 1 (Ultra-low power consumption oscillation). However, not including the current flowing into the RTC, 12-bit interval timer, and watchdog timer.
- Note 5.** Relationship between operation voltage width, operation frequency of CPU and operation mode is as below.
HS (high-speed main) mode: $2.7\text{ V} \leq V_{DD} \leq 5.5\text{ V}@1\text{ MHz to }32\text{ MHz}$
 $2.4\text{ V} \leq V_{DD} \leq 5.5\text{ V}@1\text{ MHz to }16\text{ MHz}$

Remark 1. f_{MX} : High-speed system clock frequency (X1 clock oscillation frequency or external main system clock frequency)

Remark 2. f_{HOCO} : High-speed on-chip oscillator clock frequency (64 MHz max.)

Remark 3. f_{IH} : High-speed on-chip oscillator clock frequency (32 MHz max.)

Remark 4. f_{SUB} : Subsystem clock frequency (XT1 clock oscillation frequency)

Remark 5. Except subsystem clock operation, temperature condition of the TYP. value is $T_A = 25^\circ\text{C}$

(1) Flash ROM: 16 to 64 KB of 30- to 64-pin products

(TA = -40 to +105°C, 2.4 V ≤ EVDD0 ≤ VDD ≤ 5.5 V, VSS = EVSS0 = 0 V)

(2/2)

| Parameter | Symbol | Conditions | | MIN. | TYP. | MAX. | Unit | | |
|--|------------------------------|---|--|--|---|----------------------|------|----|------|
| Supply current Note 1 | I _{DD2} Note 2 | HALT mode | HS (high-speed main) mode Note 7 | f _{HOCO} = 64 MHz, f _{IH} = 32 MHz Note 4 | V _{DD} = 5.0 V | 0.80 | 4.36 | mA | |
| | | | | | V _{DD} = 3.0 V | 0.80 | 4.36 | | |
| | | | | f _{HOCO} = 32 MHz, f _{IH} = 32 MHz Note 4 | V _{DD} = 5.0 V | 0.49 | 3.67 | | |
| | | | | | V _{DD} = 3.0 V | 0.49 | 3.67 | | |
| | | | | f _{HOCO} = 48 MHz, f _{IH} = 24 MHz Note 4 | V _{DD} = 5.0 V | 0.62 | 3.42 | | |
| | | | | | V _{DD} = 3.0 V | 0.62 | 3.42 | | |
| | | | f _{HOCO} = 24 MHz, f _{IH} = 24 MHz Note 4 | V _{DD} = 5.0 V | 0.4 | 2.85 | | | |
| | | | | V _{DD} = 3.0 V | 0.4 | 2.85 | | | |
| | | | f _{HOCO} = 16 MHz, f _{IH} = 16 MHz Note 4 | V _{DD} = 5.0 V | 0.37 | 2.08 | | | |
| | | | | V _{DD} = 3.0 V | 0.37 | 2.08 | | | |
| | | | HS (high-speed main) mode Note 7 | f _{MX} = 20 MHz Note 3, V _{DD} = 5.0 V | Square wave input | 0.28 | 2.45 | mA | |
| | | | | | Resonator connection | 0.40 | 2.57 | | |
| | | | | | f _{MX} = 20 MHz Note 3, V _{DD} = 3.0 V | Square wave input | 0.28 | | 2.45 |
| | | | | | | Resonator connection | 0.40 | | 2.57 |
| | | | | | f _{MX} = 10 MHz Note 3, V _{DD} = 5.0 V | Square wave input | 0.19 | | 1.28 |
| | | | | | | Resonator connection | 0.25 | | 1.36 |
| | | | | f _{MX} = 10 MHz Note 3, V _{DD} = 3.0 V | Square wave input | 0.19 | 1.28 | | |
| | | | | | Resonator connection | 0.25 | 1.36 | | |
| | Subsystem clock operation | f _{SUB} = 32.768 kHz Note 5, TA = -40°C | | Square wave input | 0.25 | 0.57 | μA | | |
| | | | | Resonator connection | 0.44 | 0.76 | | | |
| | | f _{SUB} = 32.768 kHz Note 5, TA = +25°C | | Square wave input | 0.30 | 0.57 | | | |
| | | | | Resonator connection | 0.49 | 0.76 | | | |
| | | f _{SUB} = 32.768 kHz Note 5, TA = +50°C | Square wave input | 0.36 | 1.17 | | | | |
| | | | Resonator connection | 0.59 | 1.36 | | | | |
| f _{SUB} = 32.768 kHz Note 5, TA = +70°C | | Square wave input | 0.49 | 1.97 | | | | | |
| | | Resonator connection | 0.72 | 2.16 | | | | | |
| f _{SUB} = 32.768 kHz Note 5, TA = +85°C | | Square wave input | 0.97 | 3.37 | | | | | |
| | | Resonator connection | 1.16 | 3.56 | | | | | |
| f _{SUB} = 32.768 kHz Note 5, TA = +105°C | | Square wave input | 3.20 | 17.10 | | | | | |
| | | Resonator connection | 3.40 | 17.50 | | | | | |
| I _{DD3} Note 6 | STOP mode Note 8 | TA = -40°C | | | 0.18 | 0.51 | μA | | |
| | | TA = +25°C | | | 0.24 | 0.51 | | | |
| | | TA = +50°C | | | 0.29 | 1.10 | | | |
| | | TA = +70°C | | | 0.41 | 1.90 | | | |
| | | TA = +85°C | | | 0.90 | 3.30 | | | |
| | | TA = +105°C | | | 3.10 | 17.00 | | | |

(Notes and Remarks are listed on the next page.)

- Note 1.** Total current flowing into V_{DD} and EV_{DD0}, including the input leakage current flowing when the level of the input pin is fixed to V_{DD}, EV_{DD0} or V_{SS}, EV_{SS0}. The values below the MAX. column include the peripheral operation current. However, not including the current flowing into the A/D converter, LVD circuit, I/O port, and on-chip pull-up/pull-down resistors and the current flowing during data flash rewrite.
- Note 2.** During HALT instruction execution by flash memory.
- Note 3.** When high-speed on-chip oscillator and subsystem clock are stopped.
- Note 4.** When high-speed system clock and subsystem clock are stopped.
- Note 5.** When high-speed on-chip oscillator and high-speed system clock are stopped. When RTCLPC = 1 and setting ultra-low current consumption (AMPHS1 = 1). The current flowing into the RTC is included. However, not including the current flowing into the 12-bit interval timer and watchdog timer.
- Note 6.** Not including the current flowing into the RTC, 12-bit interval timer, and watchdog timer.
- Note 7.** Relationship between operation voltage width, operation frequency of CPU and operation mode is as below.
 HS (high-speed main) mode: $2.7\text{ V} \leq V_{DD} \leq 5.5\text{ V}@1\text{ MHz to }32\text{ MHz}$
 $2.4\text{ V} \leq V_{DD} \leq 5.5\text{ V}@1\text{ MHz to }16\text{ MHz}$
- Note 8.** Regarding the value for current to operate the subsystem clock in STOP mode, refer to that in HALT mode.
- Remark 1.** f_{MX}: High-speed system clock frequency (X1 clock oscillation frequency or external main system clock frequency)
- Remark 2.** f_{HOCO}: High-speed on-chip oscillator clock frequency (64 MHz max.)
- Remark 3.** f_{IH}: High-speed on-chip oscillator clock frequency (32 MHz max.)
- Remark 4.** f_{SUB}: Subsystem clock frequency (XT1 clock oscillation frequency)
- Remark 5.** Except subsystem clock operation and STOP mode, temperature condition of the TYP. value is TA = 25°C

(2) Flash ROM: 96 to 256 KB of 30- to 100-pin products

(TA = -40 to +105°C, 2.4 V ≤ EVDD0 = EVDD1 ≤ VDD ≤ 5.5 V, VSS = EVSS0 = EVSS1 = 0 V)

(1/2)

| Parameter | Symbol | Conditions | | | | MIN. | TYP. | MAX. | Unit | |
|---|--|--|--|--|-------------------------|-------------------------|------|------|------|----|
| Supply current Note 1 | I _{DD1} | Operating mode | HS (high-speed main) mode Note 5 | f _{HOCO} = 64 MHz, f _{IH} = 32 MHz Note 3 | Basic operation | V _{DD} = 5.0 V | | 2.6 | | mA |
| | | | | | | V _{DD} = 3.0 V | | 2.6 | | |
| | | | | f _{HOCO} = 32 MHz, f _{IH} = 32 MHz Note 3 | Basic operation | V _{DD} = 5.0 V | | 2.3 | | |
| | | | | | | V _{DD} = 3.0 V | | 2.3 | | |
| | | | HS (high-speed main) mode Note 5 | f _{HOCO} = 64 MHz, f _{IH} = 32 MHz Note 3 | Normal operation | V _{DD} = 5.0 V | | 5.4 | 10.9 | |
| | | | | | | V _{DD} = 3.0 V | | 5.4 | 10.9 | |
| | | f _{HOCO} = 32 MHz, f _{IH} = 32 MHz Note 3 | | Normal operation | V _{DD} = 5.0 V | | 5.0 | 10.3 | | |
| | | | | | V _{DD} = 3.0 V | | 5.0 | 10.3 | | |
| | | f _{HOCO} = 48 MHz, f _{IH} = 24 MHz Note 3 | | Normal operation | V _{DD} = 5.0 V | | 4.2 | 8.2 | | |
| | | | | | V _{DD} = 3.0 V | | 4.2 | 8.2 | | |
| | | HS (high-speed main) mode Note 5 | f _{HOCO} = 24 MHz, f _{IH} = 24 MHz Note 3 | Normal operation | V _{DD} = 5.0 V | | 4.0 | 7.8 | | |
| | | | | | V _{DD} = 3.0 V | | 4.0 | 7.8 | | |
| | | | f _{HOCO} = 16 MHz, f _{IH} = 16 MHz Note 3 | Normal operation | V _{DD} = 5.0 V | | 3.0 | 5.6 | | |
| | | | | | V _{DD} = 3.0 V | | 3.0 | 5.6 | | |
| | | | HS (high-speed main) mode Note 5 | f _{MX} = 20 MHz Note 2, V _{DD} = 5.0 V | Normal operation | Square wave input | | 3.4 | 6.6 | |
| | | | | | | Resonator connection | | 3.6 | 6.7 | |
| | | f _{MX} = 20 MHz Note 2, V _{DD} = 3.0 V | | Normal operation | Square wave input | | 3.4 | 6.6 | | |
| | | | | | Resonator connection | | 3.6 | 6.7 | | |
| | | f _{MX} = 10 MHz Note 2, V _{DD} = 5.0 V | Normal operation | Square wave input | | 2.1 | 3.9 | | | |
| | | | | Resonator connection | | 2.2 | 4.0 | | | |
| | | f _{MX} = 10 MHz Note 2, V _{DD} = 3.0 V | Normal operation | Square wave input | | 2.1 | 3.9 | | | |
| | Resonator connection | | | 2.2 | 4.0 | | | | | |
| Subsystem clock operation | f _{SUB} = 32.768 kHz Note 4 TA = -40°C | Normal operation | Square wave input | | 4.9 | 7.1 | | | | |
| | | | Resonator connection | | 4.9 | 7.1 | | | | |
| | | f _{SUB} = 32.768 kHz Note 4 TA = +25°C | Normal operation | Square wave input | | 4.9 | 7.1 | | | |
| | | | | Resonator connection | | 4.9 | 7.1 | | | |
| | | f _{SUB} = 32.768 kHz Note 4 TA = +50°C | Normal operation | Square wave input | | 5.1 | 8.8 | | | |
| | | | | Resonator connection | | 5.1 | 8.8 | | | |
| f _{SUB} = 32.768 kHz Note 4 TA = +70°C | Normal operation | Square wave input | | 5.5 | 10.5 | | | | | |
| | | Resonator connection | | 5.5 | 10.5 | | | | | |
| f _{SUB} = 32.768 kHz Note 4 TA = +85°C | Normal operation | Square wave input | | 6.5 | 14.5 | | | | | |
| | | Resonator connection | | 6.5 | 14.5 | | | | | |
| f _{SUB} = 32.768 kHz Note 4 TA = +105°C | Normal operation | Square wave input | | 13.0 | 58.0 | | | | | |
| | | Resonator connection | | 13.0 | 58.0 | | | | | |

(Notes and Remarks are listed on the next page.)

- Note 1.** Total current flowing into V_{DD} , EV_{DD0} , and EV_{DD1} , including the input leakage current flowing when the level of the input pin is fixed to V_{DD} , EV_{DD0} , and EV_{DD1} , or V_{SS} , EV_{SS0} , and EV_{SS1} . The values below the MAX. column include the peripheral operation current. However, not including the current flowing into the A/D converter, D/A converter, comparator, LVD circuit, I/O port, and on-chip pull-up/pull-down resistors and the current flowing during data flash rewrite.
- Note 2.** When high-speed on-chip oscillator and subsystem clock are stopped.
- Note 3.** When high-speed system clock and subsystem clock are stopped.
- Note 4.** When high-speed on-chip oscillator and high-speed system clock are stopped. When $AMPHS1 = 1$ (Ultra-low power consumption oscillation). However, not including the current flowing into the 12-bit interval timer and watchdog timer.
- Note 5.** Relationship between operation voltage width, operation frequency of CPU and operation mode is as below.
- HS (high-speed main) mode: $2.7\text{ V} \leq V_{DD} \leq 5.5\text{ V}@1\text{ MHz to }32\text{ MHz}$
 $2.4\text{ V} \leq V_{DD} \leq 5.5\text{ V}@1\text{ MHz to }16\text{ MHz}$

Remark 1. f_{MX} : High-speed system clock frequency (X1 clock oscillation frequency or external main system clock frequency)

Remark 2. f_{HOCO} : High-speed on-chip oscillator clock frequency (64 MHz max.)

Remark 3. f_{IH} : High-speed on-chip oscillator clock frequency (32 MHz max.)

Remark 4. f_{SUB} : Subsystem clock frequency (XT1 clock oscillation frequency)

Remark 5. Except subsystem clock operation, temperature condition of the TYP. value is $T_A = 25^\circ\text{C}$

(2) Flash ROM: 96 to 256 KB of 30- to 100-pin products

(TA = -40 to +105°C, 2.4 V ≤ EVDD0 = EVDD1 ≤ VDD ≤ 5.5 V, VSS = EVSS0 = EVSS1 = 0 V)

(2/2)

| Parameter | Symbol | Conditions | | MIN. | TYP. | MAX. | Unit | | |
|--|-------------------------|---|--|--|-------------------------|------|------|----|----|
| Supply current Note 1 | I _{DD2} Note 2 | HALT mode | HS (high-speed main) mode Note 7 | f _{HOCO} = 64 MHz, f _{IH} = 32 MHz Note 4 | V _{DD} = 5.0 V | 0.79 | 4.86 | mA | |
| | | | | | V _{DD} = 3.0 V | 0.79 | 4.86 | | |
| | | | | f _{HOCO} = 32 MHz, f _{IH} = 32 MHz Note 4 | V _{DD} = 5.0 V | 0.49 | 4.17 | | |
| | | | | | V _{DD} = 3.0 V | 0.49 | 4.17 | | |
| | | | | f _{HOCO} = 48 MHz, f _{IH} = 24 MHz Note 4 | V _{DD} = 5.0 V | 0.62 | 3.82 | | |
| | | | | | V _{DD} = 3.0 V | 0.62 | 3.82 | | |
| | | | f _{HOCO} = 24 MHz, f _{IH} = 24 MHz Note 4 | V _{DD} = 5.0 V | 0.4 | 3.25 | | | |
| | | | | V _{DD} = 3.0 V | 0.4 | 3.25 | | | |
| | | | f _{HOCO} = 16 MHz, f _{IH} = 16 MHz Note 4 | V _{DD} = 5.0 V | 0.38 | 2.28 | | | |
| | | | | V _{DD} = 3.0 V | 0.38 | 2.28 | | | |
| | | | HS (high-speed main) mode Note 7 | f _{MX} = 20 MHz Note 3, V _{DD} = 5.0 V | Square wave input | 0.30 | 2.65 | mA | |
| | | | | | Resonator connection | 0.40 | 2.77 | | |
| | | f _{MX} = 20 MHz Note 3, V _{DD} = 3.0 V | | Square wave input | 0.30 | 2.65 | | | |
| | | | | Resonator connection | 0.40 | 2.77 | | | |
| | | f _{MX} = 10 MHz Note 3, V _{DD} = 5.0 V | | Square wave input | 0.20 | 1.36 | | | |
| | | | | Resonator connection | 0.25 | 1.46 | | | |
| | | f _{MX} = 10 MHz Note 3, V _{DD} = 3.0 V | | Square wave input | 0.20 | 1.36 | | | |
| | | | | Resonator connection | 0.25 | 1.46 | | | |
| | | Subsystem clock operation | | f _{SUB} = 32.768 kHz Note 5, TA = -40°C | Square wave input | 0.28 | 0.66 | | μA |
| | | | | | Resonator connection | 0.47 | 0.85 | | |
| | | | | f _{SUB} = 32.768 kHz Note 5, TA = +25°C | Square wave input | 0.34 | 0.66 | | |
| | | | | | Resonator connection | 0.53 | 0.85 | | |
| | | | f _{SUB} = 32.768 kHz Note 5, TA = +50°C | Square wave input | 0.37 | 2.35 | | | |
| | | | | Resonator connection | 0.56 | 2.54 | | | |
| f _{SUB} = 32.768 kHz Note 5, TA = +70°C | Square wave input | 0.61 | 4.08 | μA | | | | | |
| | Resonator connection | 0.80 | 4.27 | | | | | | |
| f _{SUB} = 32.768 kHz Note 5, TA = +85°C | Square wave input | 1.55 | 8.09 | μA | | | | | |
| | Resonator connection | 1.74 | 8.28 | | | | | | |
| f _{SUB} = 32.768 kHz Note 5, TA = +105°C | Square wave input | 6.00 | 51.00 | μA | | | | | |
| | Resonator connection | 6.00 | 51.00 | | | | | | |
| I _{DD3} Note 6 | STOP mode Note 8 | TA = -40°C | | 0.19 | 0.57 | μA | | | |
| | | TA = +25°C | | 0.25 | 0.57 | | | | |
| | | TA = +50°C | | 0.33 | 2.26 | | | | |
| | | TA = +70°C | | 0.52 | 3.99 | | | | |
| | | TA = +85°C | | 1.46 | 8.00 | | | | |
| | | TA = +105°C | | 5.50 | 50.00 | | | | |

(Notes and Remarks are listed on the next page.)

- Note 1.** Total current flowing into VDD, EVDD0, and EVDD1, including the input leakage current flowing when the level of the input pin is fixed to VDD, EVDD0, and EVDD1, or VSS, EVSS0, and EVSS1. The values below the MAX. column include the peripheral operation current. However, not including the current flowing into the A/D converter, D/A converter, comparator, LVD circuit, I/O port, and on-chip pull-up/pull-down resistors and the current flowing during data flash rewrite.
- Note 2.** During HALT instruction execution by flash memory.
- Note 3.** When high-speed on-chip oscillator and subsystem clock are stopped.
- Note 4.** When high-speed system clock and subsystem clock are stopped.
- Note 5.** When high-speed on-chip oscillator and high-speed system clock are stopped. When RTCLPC = 1 and setting ultra-low current consumption (AMPHS1 = 1). The current flowing into the RTC is included. However, not including the current flowing into the 12-bit interval timer and watchdog timer.
- Note 6.** Not including the current flowing into the RTC, 12-bit interval timer, and watchdog timer.
- Note 7.** Relationship between operation voltage width, operation frequency of CPU and operation mode is as below.
 HS (high-speed main) mode: $2.7\text{ V} \leq V_{DD} \leq 5.5\text{ V}@1\text{ MHz to }32\text{ MHz}$
 $2.4\text{ V} \leq V_{DD} \leq 5.5\text{ V}@1\text{ MHz to }16\text{ MHz}$
- Note 8.** Regarding the value for current to operate the subsystem clock in STOP mode, refer to that in HALT mode.
- Remark 1.** fMX: High-speed system clock frequency (X1 clock oscillation frequency or external main system clock frequency)
- Remark 2.** fHOCO: High-speed on-chip oscillator clock frequency (64 MHz max.)
- Remark 3.** fIH: High-speed on-chip oscillator clock frequency (32 MHz max.)
- Remark 4.** fSUB: Subsystem clock frequency (XT1 clock oscillation frequency)
- Remark 5.** Except subsystem clock operation and STOP mode, temperature condition of the TYP. value is TA = 25°C

(3) Flash ROM: 384 to 512 KB of 48- to 100-pin products

(TA = -40 to +105°C, 2.4 V ≤ EVDD0 = EVDD1 ≤ VDD ≤ 5.5 V, VSS = EVSS0 = EVSS1 = 0 V)

(1/2)

| Parameter | Symbol | Conditions | | | | MIN. | TYP. | MAX. | Unit | | |
|---|--|--|--|--|--|-------------------------|-------------------------|------|------|----|--|
| Supply current Note 1 | I _{DD1} | Operating mode | HS (high-speed main) mode Note 5 | f _{HOCO} = 64 MHz, f _{IH} = 32 MHz Note 3 | Basic operation | V _{DD} = 5.0 V | | 2.9 | | mA | |
| | | | | | | V _{DD} = 3.0 V | | 2.9 | | | |
| | | | | | f _{HOCO} = 32 MHz, f _{IH} = 32 MHz Note 3 | Basic operation | V _{DD} = 5.0 V | | 2.5 | | |
| | | | | | | | V _{DD} = 3.0 V | | 2.5 | | |
| | | | HS (high-speed main) mode Note 5 | f _{HOCO} = 64 MHz, f _{IH} = 32 MHz Note 3 | Normal operation | V _{DD} = 5.0 V | | 6.0 | 11.2 | mA | |
| | | | | | | V _{DD} = 3.0 V | | 6.0 | 11.2 | | |
| | | f _{HOCO} = 32 MHz, f _{IH} = 32 MHz Note 3 | | Normal operation | V _{DD} = 5.0 V | | 5.5 | 10.6 | | | |
| | | | | | V _{DD} = 3.0 V | | 5.5 | 10.6 | | | |
| | | f _{HOCO} = 48 MHz, f _{IH} = 24 MHz Note 3 | | Normal operation | V _{DD} = 5.0 V | | 4.7 | 8.6 | | | |
| | | | | | V _{DD} = 3.0 V | | 4.7 | 8.6 | | | |
| | | HS (high-speed main) mode Note 5 | f _{HOCO} = 24 MHz, f _{IH} = 24 MHz Note 3 | Normal operation | V _{DD} = 5.0 V | | 4.4 | 8.2 | mA | | |
| | | | | | V _{DD} = 3.0 V | | 4.4 | 8.2 | | | |
| | | | f _{HOCO} = 16 MHz, f _{IH} = 16 MHz Note 3 | Normal operation | V _{DD} = 5.0 V | | 3.3 | 5.9 | | | |
| | | | | | V _{DD} = 3.0 V | | 3.3 | 5.9 | | | |
| | | | HS (high-speed main) mode Note 5 | f _{MX} = 20 MHz Note 2, V _{DD} = 5.0 V | Normal operation | Square wave input | | 3.7 | 6.8 | mA | |
| | | | | | | Resonator connection | | 3.9 | 7.0 | | |
| | | f _{MX} = 20 MHz Note 2, V _{DD} = 3.0 V | | Normal operation | Square wave input | | 3.7 | 6.8 | | | |
| | | | | | Resonator connection | | 3.9 | 7.0 | | | |
| | | f _{MX} = 10 MHz Note 2, V _{DD} = 5.0 V | | Normal operation | Square wave input | | 2.3 | 4.1 | | | |
| | | | | | Resonator connection | | 2.3 | 4.2 | | | |
| | | f _{MX} = 10 MHz Note 2, V _{DD} = 3.0 V | | Normal operation | Square wave input | | 2.3 | 4.1 | | | |
| | | Resonator connection | | | 2.3 | 4.2 | | | | | |
| Subsystem clock operation | f _{SUB} = 32.768 kHz Note 4 TA = -40°C | Normal operation | Square wave input | | 5.2 | 7.7 | μA | | | | |
| | | | Resonator connection | | 5.2 | 7.7 | | | | | |
| | f _{SUB} = 32.768 kHz Note 4 TA = +25°C | Normal operation | Square wave input | | 5.3 | 7.7 | | | | | |
| | | | Resonator connection | | 5.3 | 7.7 | | | | | |
| | f _{SUB} = 32.768 kHz Note 4 TA = +50°C | Normal operation | Square wave input | | 5.5 | 10.6 | | | | | |
| | | | Resonator connection | | 5.5 | 10.6 | | | | | |
| | f _{SUB} = 32.768 kHz Note 4 TA = +70°C | Normal operation | Square wave input | | 5.9 | 13.2 | | | | | |
| | | | Resonator connection | | 6.0 | 13.2 | | | | | |
| f _{SUB} = 32.768 kHz Note 4 TA = +85°C | Normal operation | Square wave input | | 6.8 | 17.5 | | | | | | |
| | | Resonator connection | | 6.9 | 17.5 | | | | | | |
| f _{SUB} = 32.768 kHz Note 4 TA = +105°C | Normal operation | Square wave input | | 15.5 | 77.8 | | | | | | |
| | | Resonator connection | | 15.5 | 77.8 | | | | | | |

(Notes and Remarks are listed on the next page.)

- Note 1.** Total current flowing into V_{DD} , EV_{DD0} , and EV_{DD1} , including the input leakage current flowing when the level of the input pin is fixed to V_{DD} , EV_{DD0} , and EV_{DD1} , or V_{SS} , EV_{SS0} , and EV_{SS1} . The values below the MAX. column include the peripheral operation current. However, not including the current flowing into the A/D converter, D/A converter, comparator, LVD circuit, I/O port, and on-chip pull-up/pull-down resistors and the current flowing during data flash rewrite.
- Note 2.** When high-speed on-chip oscillator and subsystem clock are stopped.
- Note 3.** When high-speed system clock and subsystem clock are stopped.
- Note 4.** When high-speed on-chip oscillator and high-speed system clock are stopped. When $AMPHS1 = 1$ (Ultra-low power consumption oscillation). However, not including the current flowing into the 12-bit interval timer and watchdog timer.
- Note 5.** Relationship between operation voltage width, operation frequency of CPU and operation mode is as below.
- HS (high-speed main) mode: $2.7\text{ V} \leq V_{DD} \leq 5.5\text{ V}@1\text{ MHz to }32\text{ MHz}$
 $2.4\text{ V} \leq V_{DD} \leq 5.5\text{ V}@1\text{ MHz to }16\text{ MHz}$

Remark 1. f_{MX} : High-speed system clock frequency (X1 clock oscillation frequency or external main system clock frequency)

Remark 2. f_{HOCO} : High-speed on-chip oscillator clock frequency (64 MHz max.)

Remark 3. f_{IH} : High-speed on-chip oscillator clock frequency (32 MHz max.)

Remark 4. f_{SUB} : Subsystem clock frequency (XT1 clock oscillation frequency)

Remark 5. Except subsystem clock operation, temperature condition of the TYP. value is $T_A = 25^\circ\text{C}$

(3) Flash ROM: 384 to 512 KB of 48- to 100-pin products

(TA = -40 to +105°C, 2.4 V ≤ EVDD0 = EVDD1 ≤ VDD ≤ 5.5 V, VSS = EVSS0 = EVSS1 = 0 V)

(2/2)

| Parameter | Symbol | Conditions | | MIN. | TYP. | MAX. | Unit | |
|---|-------------------------|--|---|---|-------------------------|------|------|----|
| Supply current Note 1 | I _{DD2} Note 2 | HALT mode | HS (high-speed main) mode Note 7 | f _{HOCO} = 64 MHz, f _{IH} = 32 MHz Note 4 | V _{DD} = 5.0 V | 0.93 | 5.16 | mA |
| | | | | | V _{DD} = 3.0 V | 0.93 | 5.16 | |
| | | | | f _{HOCO} = 32 MHz, f _{IH} = 32 MHz Note 4 | V _{DD} = 5.0 V | 0.5 | 4.47 | |
| | | | | | V _{DD} = 3.0 V | 0.5 | 4.47 | |
| | | | | f _{HOCO} = 48 MHz, f _{IH} = 24 MHz Note 4 | V _{DD} = 5.0 V | 0.72 | 4.08 | |
| | | | | | V _{DD} = 3.0 V | 0.72 | 4.08 | |
| | | | f _{HOCO} = 24 MHz, f _{IH} = 24 MHz Note 4 | V _{DD} = 5.0 V | 0.42 | 3.51 | | |
| | | | | V _{DD} = 3.0 V | 0.42 | 3.51 | | |
| | | | f _{HOCO} = 16 MHz, f _{IH} = 16 MHz Note 4 | V _{DD} = 5.0 V | 0.39 | 2.38 | | |
| | | | | V _{DD} = 3.0 V | 0.39 | 2.38 | | |
| | | | HS (high-speed main) mode Note 7 | f _{MX} = 20 MHz Note 3, V _{DD} = 5.0 V | Square wave input | 0.31 | 2.83 | mA |
| | | | | | Resonator connection | 0.41 | 2.92 | |
| | | f _{MX} = 20 MHz Note 3, V _{DD} = 3.0 V | | Square wave input | 0.31 | 2.83 | | |
| | | | | Resonator connection | 0.41 | 2.92 | | |
| | | f _{MX} = 10 MHz Note 3, V _{DD} = 5.0 V | | Square wave input | 0.21 | 1.46 | | |
| | | | | Resonator connection | 0.26 | 1.57 | | |
| | | f _{MX} = 10 MHz Note 3, V _{DD} = 3.0 V | | Square wave input | 0.21 | 1.46 | | |
| | | | | Resonator connection | 0.26 | 1.57 | | |
| | | Subsystem clock operation | | f _{SUB} = 32.768 kHz Note 5, TA = -40°C | Square wave input | 0.31 | 0.76 | μA |
| | | | | | Resonator connection | 0.50 | 0.95 | |
| | | | | f _{SUB} = 32.768 kHz Note 5, TA = +25°C | Square wave input | 0.38 | 0.76 | |
| | | | | | Resonator connection | 0.57 | 0.95 | |
| | | | f _{SUB} = 32.768 kHz Note 5, TA = +50°C | Square wave input | 0.47 | 3.59 | | |
| | | | | Resonator connection | 0.70 | 3.78 | | |
| f _{SUB} = 32.768 kHz Note 5, TA = +70°C | Square wave input | | 0.80 | 6.20 | | | | |
| | Resonator connection | | 1.00 | 6.39 | | | | |
| f _{SUB} = 32.768 kHz Note 5, TA = +85°C | Square wave input | | 1.65 | 10.56 | | | | |
| | Resonator connection | | 1.84 | 10.75 | | | | |
| f _{SUB} = 32.768 kHz Note 5, TA = +105°C | Square wave input | | 8.00 | 65.7 | | | | |
| | Resonator connection | | 8.00 | 65.7 | | | | |
| I _{DD3} Note 6 | STOP mode Note 8 | TA = -40°C | | 0.19 | 0.63 | μA | | |
| | | TA = +25°C | | 0.30 | 0.63 | | | |
| | | TA = +50°C | | 0.41 | 3.47 | | | |
| | | TA = +70°C | | 0.80 | 6.08 | | | |
| | | TA = +85°C | | 1.53 | 10.44 | | | |
| | | TA = +105°C | | 6.50 | 67.14 | | | |

(Notes and Remarks are listed on the next page.)

- Note 1.** Total current flowing into V_{DD}, EV_{DD0}, and EV_{DD1}, including the input leakage current flowing when the level of the input pin is fixed to V_{DD}, EV_{DD0}, and EV_{DD1}, or V_{SS}, EV_{SS0}, and EV_{SS1}. The values below the MAX. column include the peripheral operation current. However, not including the current flowing into the A/D converter, D/A converter, comparator, LVD circuit, I/O port, and on-chip pull-up/pull-down resistors and the current flowing during data flash rewrite.
- Note 2.** During HALT instruction execution by flash memory.
- Note 3.** When high-speed on-chip oscillator and subsystem clock are stopped.
- Note 4.** When high-speed system clock and subsystem clock are stopped.
- Note 5.** When high-speed on-chip oscillator and high-speed system clock are stopped. When RTCLPC = 1 and setting ultra-low current consumption (AMPHS1 = 1). The current flowing into the RTC is included. However, not including the current flowing into the 12-bit interval timer and watchdog timer.
- Note 6.** Not including the current flowing into the RTC, 12-bit interval timer, and watchdog timer.
- Note 7.** Relationship between operation voltage width, operation frequency of CPU and operation mode is as below.
 HS (high-speed main) mode: $2.7\text{ V} \leq V_{DD} \leq 5.5\text{ V}@1\text{ MHz to }32\text{ MHz}$
 $2.4\text{ V} \leq V_{DD} \leq 5.5\text{ V}@1\text{ MHz to }16\text{ MHz}$
- Note 8.** Regarding the value for current to operate the subsystem clock in STOP mode, refer to that in HALT mode.
- Remark 1.** f_{MX}: High-speed system clock frequency (X1 clock oscillation frequency or external main system clock frequency)
- Remark 2.** f_{HOCO}: High-speed on-chip oscillator clock frequency (64 MHz max.)
- Remark 3.** f_{IH}: High-speed on-chip oscillator clock frequency (32 MHz max.)
- Remark 4.** f_{SUB}: Subsystem clock frequency (XT1 clock oscillation frequency)
- Remark 5.** Except subsystem clock operation and STOP mode, temperature condition of the TYP. value is TA = 25°C

(4) Peripheral Functions (Common to all products)**(TA = -40 to +105°C, 2.4 V ≤ EVDD0 = EVDD1 ≤ VDD ≤ 5.5 V, VSS = EVSS0 = EVSS1 = 0 V)**

| Parameter | Symbol | Conditions | | MIN. | TYP. | MAX. | Unit |
|--|-----------------------------------|--|---|------|------|-------|------|
| Low-speed on-chip oscillator operating current | IFIL Note 1 | | | | 0.20 | | μA |
| RTC operating current | IRTC Notes 1, 2, 3 | | | | 0.02 | | μA |
| 12-bit interval timer operating current | II _T Notes 1, 2, 4 | | | | 0.02 | | μA |
| Watchdog timer operating current | I _{WDT} Notes 1, 2, 5 | fil = 15 kHz | | | 0.22 | | μA |
| A/D converter operating current | I _{ADC} Notes 1, 6 | When conversion at maximum speed | Normal mode, AV _{REFP} = V _{DD} = 5.0 V | | 1.3 | 1.7 | mA |
| | | | Low voltage mode, AV _{REFP} = V _{DD} = 3.0 V | | 0.5 | 0.7 | mA |
| A/D converter reference voltage current | I _{ADREF} Note 1 | | | | 75.0 | | μA |
| Temperature sensor operating current | I _{TMPS} Note 1 | | | | 75.0 | | μA |
| D/A converter operating current | I _{DAC} Notes 1, 11, 13 | Per D/A converter channel | | | | 1.5 | mA |
| Comparator operating current | I _{COMP} Notes 1, 12, 13 | V _{DD} = 5.0 V, Regulator output voltage = 2.1 V | Window mode | | 12.5 | | μA |
| | | | Comparator high-speed mode | | 6.5 | | μA |
| | | | Comparator low-speed mode | | 1.7 | | μA |
| | | V _{DD} = 5.0 V, Regulator output voltage = 1.8 V | Window mode | | 8.0 | | μA |
| | | | Comparator high-speed mode | | 4.0 | | μA |
| | | | Comparator low-speed mode | | 1.3 | | μA |
| LVD operating current | I _{LVD} Notes 1, 7 | | | | 0.08 | | μA |
| Self-programming operating current | I _{FSP} Notes 1, 9 | | | | 2.50 | 12.20 | mA |
| BGO operating current | I _{BGO} Notes 1, 8 | | | | 2.50 | 12.20 | mA |
| SNOOZE operating current | I _{SNOZ} Note 1 | ADC operation | The mode is performed Note 10 | | 0.50 | 1.10 | mA |
| | | | The A/D conversion operations are performed, Low voltage mode, AV _{REFP} = V _{DD} = 3.0 V | | 1.20 | 2.04 | |
| | | CSI/JART operation | | 0.70 | 1.54 | | |
| | | DTC operation | | 3.10 | | | |

Note 1. Current flowing to V_{DD}.**Note 2.** When high speed on-chip oscillator and high-speed system clock are stopped.**Note 3.** Current flowing only to the real-time clock (RTC) (excluding the operating current of the low-speed on-chip oscillator and the XT1 oscillator). The supply current of the RL78 microcontrollers is the sum of the values of either I_{DD1} or I_{DD2}, and I_{RTC}, when the real-time clock operates in operation mode or HALT mode. When the low-speed on-chip oscillator is selected, I_{FIL} should be added. I_{DD2} subsystem clock operation includes the operational current of the real-time clock.**Note 4.** Current flowing only to the 12-bit interval timer (excluding the operating current of the low-speed on-chip oscillator and the XT1 oscillator). The supply current of the RL78 microcontrollers is the sum of the values of either I_{DD1} or I_{DD2}, and I_{IT}, when the 12-bit interval timer operates in operation mode or HALT mode. When the low-speed on-chip oscillator is selected, I_{FIL} should be added.

- Note 5.** Current flowing only to the watchdog timer (including the operating current of the low-speed on-chip oscillator). The supply current of the RL78 microcontrollers is the sum of I_{DD1} , I_{DD2} or I_{DD3} and I_{WDT} when the watchdog timer is in operation.
- Note 6.** Current flowing only to the A/D converter. The supply current of the RL78 microcontrollers is the sum of I_{DD1} or I_{DD2} and I_{ADC} when the A/D converter operates in an operation mode or the HALT mode.
- Note 7.** Current flowing only to the LVD circuit. The supply current of the RL78 microcontrollers is the sum of I_{DD1} , I_{DD2} or I_{DD3} and I_{LVD} when the LVD circuit is in operation.
- Note 8.** Current flowing during programming of the data flash.
- Note 9.** Current flowing during self-programming.
- Note 10.** For shift time to the SNOOZE mode, see **23.3.3 SNOOZE mode** in the RL78/G14 User's Manual.
- Note 11.** Current flowing only to the D/A converter. The supply current of the RL78 microcontrollers is the sum of I_{DD1} or I_{DD2} and I_{DAC} when the D/A converter operates in an operation mode or the HALT mode.
- Note 12.** Current flowing only to the comparator circuit. The supply current of the RL78 microcontrollers is the sum of I_{DD1} , I_{DD2} , or I_{DD3} and I_{CMP} when the comparator circuit is in operation.
- Note 13.** A comparator and D/A converter are provided in products with 96 KB or more code flash memory.

Remark 1. f_{IL} : Low-speed on-chip oscillator clock frequency

Remark 2. f_{SUB} : Subsystem clock frequency (XT1 clock oscillation frequency)

Remark 3. f_{CLK} : CPU/peripheral hardware clock frequency

Remark 4. Temperature condition of the TYP. value is $T_A = 25^\circ\text{C}$

3.4 AC Characteristics

(TA = -40 to +105°C, 2.4 V ≤ EVDD0 = EVDD1 ≤ VDD ≤ 5.5 V, VSS = EVSS0 = EVSS1 = 0 V)

(1/2)

| Items | Symbol | Conditions | | MIN. | TYP. | MAX. | Unit | |
|--|-----------------|---|------------------------------|-----------------------|---------|------|------|----|
| Instruction cycle (minimum instruction execution time) | Tcy | Main system clock (fMAIN) operation | HS (high-speed main) mode | 2.7 V ≤ VDD ≤ 5.5 V | 0.03125 | | 1 | μs |
| | | | | 2.4 V ≤ VDD < 2.7 V | 0.0625 | | 1 | μs |
| | | Subsystem clock (fSUB) operation | | 2.4 V ≤ VDD ≤ 5.5 V | 28.5 | 30.5 | 31.3 | μs |
| | | In the self- programming mode | HS (high-speed main) mode | 2.7 V ≤ VDD ≤ 5.5 V | 0.03125 | | 1 | μs |
| 2.4 V ≤ VDD < 2.7 V | 0.0625 | | | | 1 | μs | | |
| External system clock frequency | fex | 2.7 V ≤ VDD ≤ 5.5 V | | 1.0 | | 20.0 | MHz | |
| | | 2.4 V ≤ VDD ≤ 2.7 V | | 1.0 | | 16.0 | MHz | |
| | fexs | | | 32 | | 35 | kHz | |
| External system clock input high-level width, low-level width | tEXH, | 2.7 V ≤ VDD ≤ 5.5 V | | 24 | | | ns | |
| | tEXL | 2.4 V ≤ VDD ≤ 2.7 V | | 30 | | | ns | |
| | tEXHS, tEXLS | | | 13.7 | | | μs | |
| T100 to T103, T110 to T113 input high-level width, low-level width | tT1H, tT1L | | | 1/fMCK + 10 Note | | | ns | |
| Timer RJ input cycle | fc | TRJIO | | 2.7 V ≤ EVDD0 ≤ 5.5 V | 100 | | ns | |
| | | | | 2.4 V ≤ EVDD0 < 2.7 V | 300 | | ns | |
| Timer RJ input high- level width, low-level width | tTJH, tTJL | TRJIO | | 2.7 V ≤ EVDD0 ≤ 5.5 V | 40 | | ns | |
| | | | | 2.4 V ≤ EVDD0 < 2.7 V | 120 | | ns | |

Note The following conditions are required for low voltage interface when EVDD0 < VDD
2.4 V ≤ EVDD0 < 2.7 V: MIN. 125 ns

Remark fMCK: Timer array unit operation clock frequency
(Operation clock to be set by the CKSmn bit of timer mode register mn (TMRmn). m: Unit number (m = 0, 1), n: Channel number (n = 0 to 3))

(TA = -40 to +105°C, 2.4 V ≤ EVDD0 = EVDD1 ≤ VDD ≤ 5.5 V, VSS = EVSS0 = EVSS1 = 0 V)

(2/2)

| Items | Symbol | Conditions | | MIN. | TYP. | MAX. | Unit |
|--|-----------------|---|-----------------------|------------|------|------|------|
| Timer RD input high-level width, low-level width | tTDIH, tTDIL | TRDIOA0, TRDIOA1, TRDIOB0, TRDIOB1, TRDIOC0, TRDIOC1, TRDIOD0, TRDIOD1 | | 3/fCLK | | | ns |
| Timer RD forced cutoff signal input low-level width | tTDSIL | P130/INTP0 | 2MHz < fCLK ≤ 32 MHz | 1 | | | μs |
| | | | fCLK ≤ 2 MHz | 1/fCLK + 1 | | | |
| Timer RG input high-level width, low-level width | tTGIH, tTGIL | TRGIOA, TRGIOB | | 2.5/fCLK | | | ns |
| TO00 to TO03, TO10 to TO13, TRJIO0, TRJO0, TRDIOA0, TRDIOA1, TRDIOB0, TRDIOB1, TRDIOC0, TRDIOC1, TRDIOD0, TRDIOD1, TRGIOA, TRGIOB output frequency | fTO | HS (high-speed main) mode | 4.0 V ≤ EVDD0 ≤ 5.5 V | | | 16 | MHz |
| | | | 2.7 V ≤ EVDD0 < 4.0 V | | | 8 | MHz |
| | | | 2.4 V ≤ EVDD0 < 2.7 V | | | 4 | MHz |
| PCLBUZ0, PCLBUZ1 output frequency | fPCL | HS (high-speed main) mode | 4.0 V ≤ EVDD0 ≤ 5.5 V | | | 16 | MHz |
| | | | 2.7 V ≤ EVDD0 < 4.0 V | | | 8 | MHz |
| | | | 2.4 V ≤ EVDD0 < 2.7 V | | | 4 | MHz |
| Interrupt input high-level width, low-level width | tINTH, tINTL | INTP0 | 2.4 V ≤ VDD ≤ 5.5 V | 1 | | | μs |
| | | INTP1 to INTP11 | 2.4 V ≤ EVDD0 ≤ 5.5 V | 1 | | | μs |
| Key interrupt input low-level width | tKR | KR0 to KR7 | 2.4 V ≤ EVDD0 ≤ 5.5 V | 250 | | | ns |
| RESET low-level width | tRSL | | | 10 | | | μs |

Minimum Instruction Execution Time during Main System Clock Operation

Tcy vs VDD (HS (high-speed main) mode)

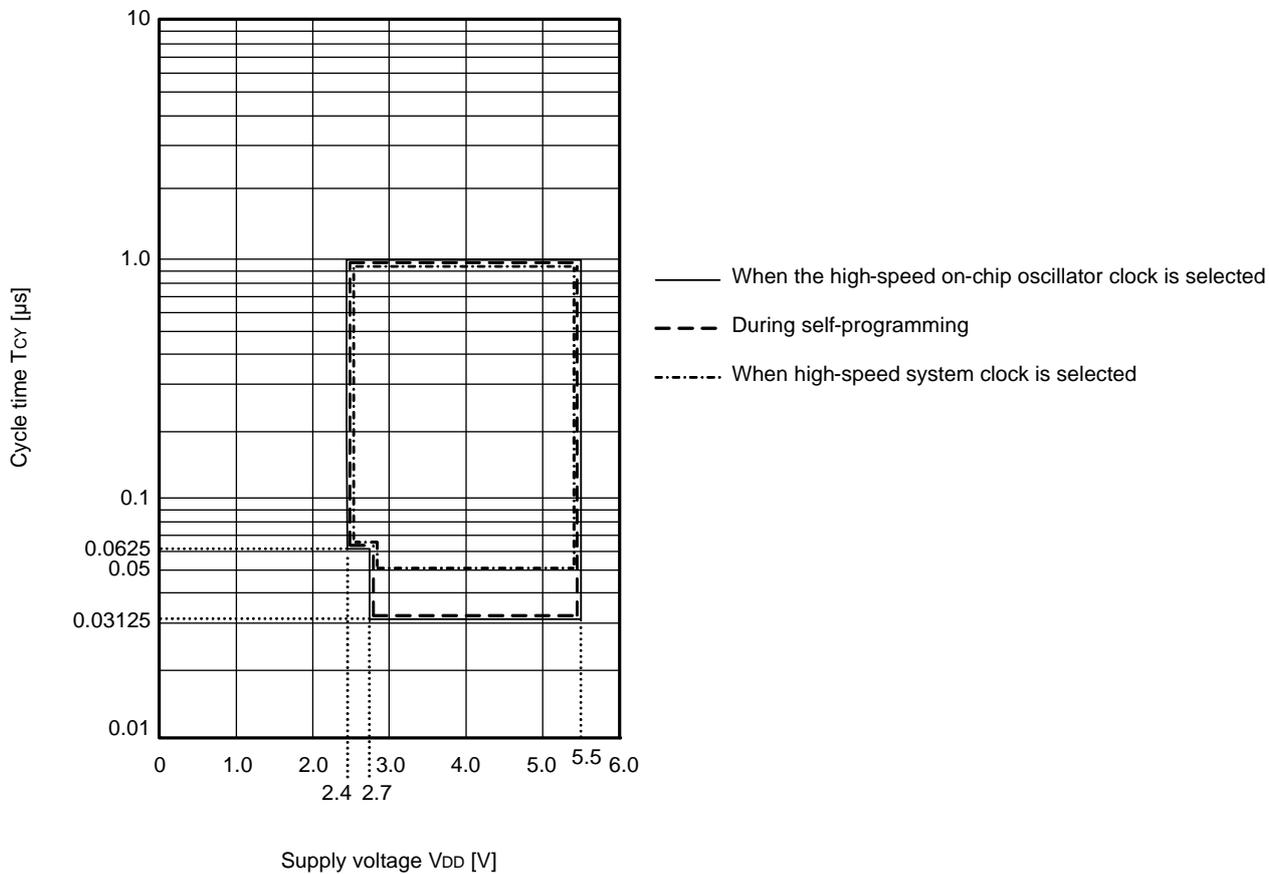

AC Timing Test Points

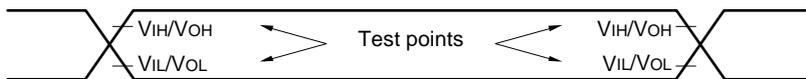

External System Clock Timing

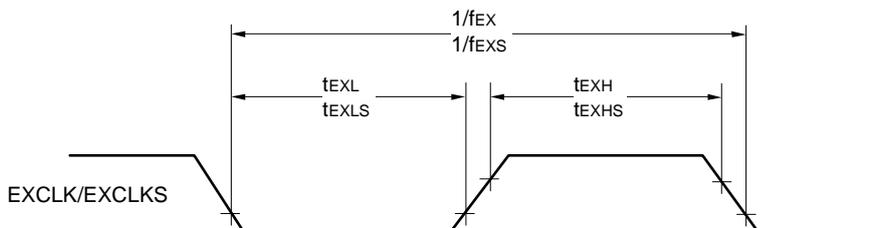

TI/TO Timing

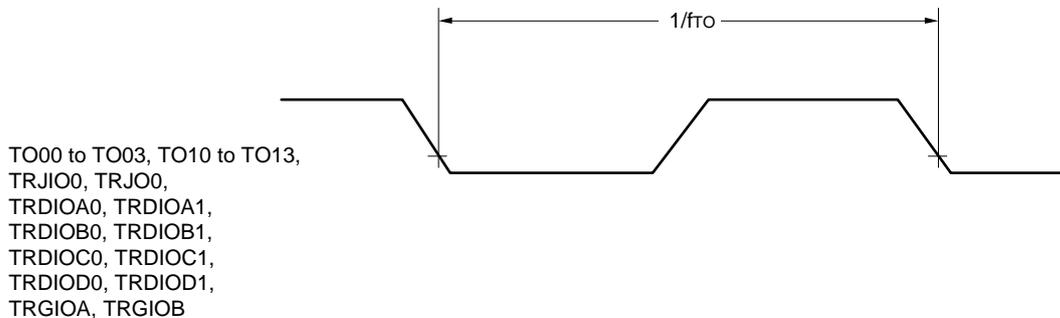
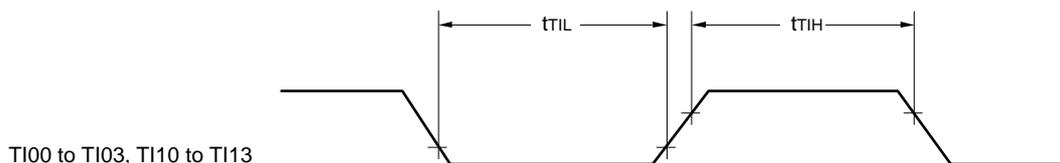

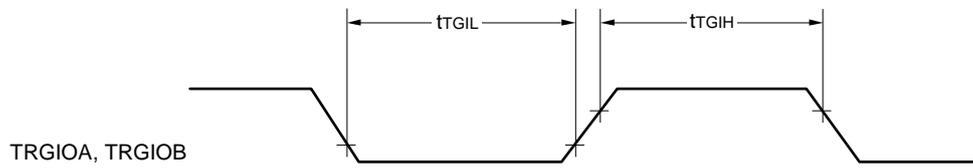
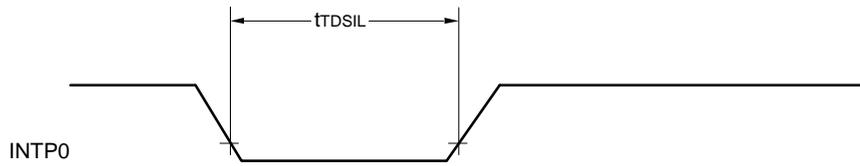
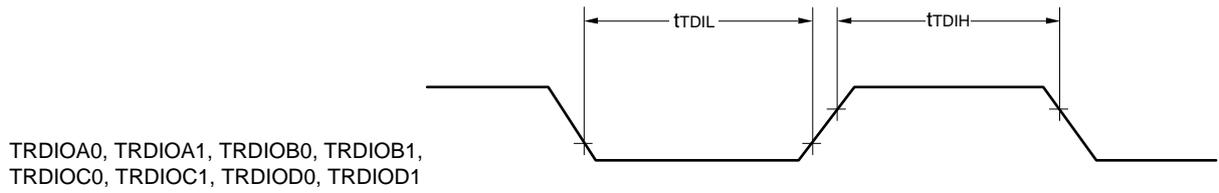
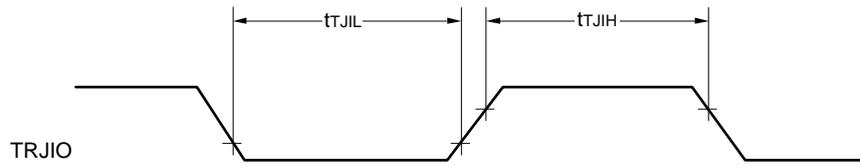

Interrupt Request Input Timing

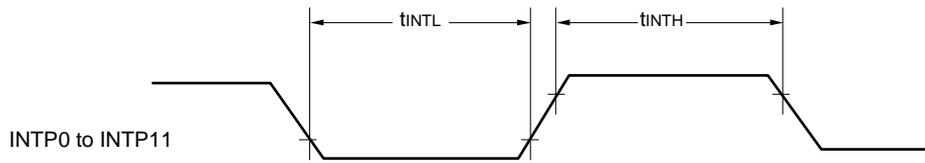

Key Interrupt Input Timing

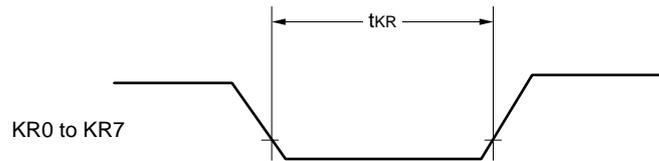

$\overline{\text{RESET}}$ Input Timing

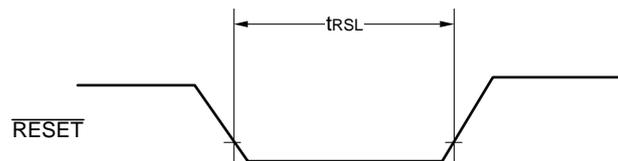

3.5 Peripheral Functions Characteristics

AC Timing Test Points

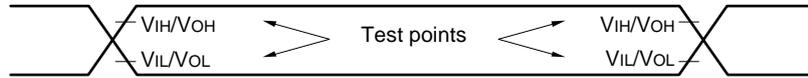

3.5.1 Serial array unit

(1) During communication at same potential (UART mode)

(TA = -40 to +105°C, 2.4 V ≤ EVDD0 = EVDD1 ≤ 5.5 V, VSS = EVSS0 = EVSS1 = 0 V)

| Parameter | Symbol | Conditions | HS (high-speed main) Mode | | Unit |
|----------------------|--------|--|---------------------------|----------------|------|
| | | | MIN. | MAX. | |
| Transfer rate Note 1 | | 2.4 V ≤ EVDD0 ≤ 5.5 V | | fMCK/12 Note 2 | bps |
| | | Theoretical value of the maximum transfer rate fMCK = fCLK Note 3 | | 2.6 | Mbps |

Note 1. Transfer rate in the SNOOZE mode is 4800 bps only. However, the SNOOZE mode cannot be used when FRQSEL4 = 1.

Note 2. The following conditions are required for low voltage interface when EVDD0 < VDD. 2.4 V ≤ EVDD0 < 2.7 V: MAX. 1.3 Mbps

Note 3. The maximum operating frequencies of the CPU/peripheral hardware clock (fCLK) are:
 HS (high-speed main) mode: 32 MHz (2.7 V ≤ VDD ≤ 5.5 V)
 16 MHz (2.4 V ≤ VDD ≤ 5.5 V)

Caution Select the normal input buffer for the RxDq pin and the normal output mode for the TxDq pin by using port input mode register g (PIMg) and port output mode register g (POMg).

UART mode connection diagram (during communication at same potential)

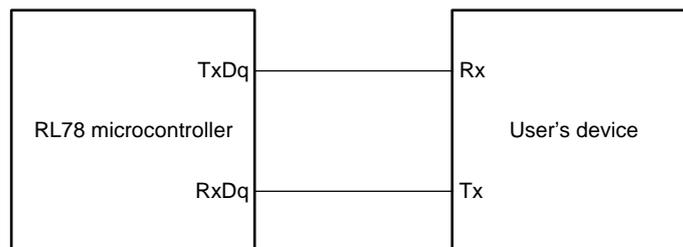

UART mode bit width (during communication at same potential) (reference)

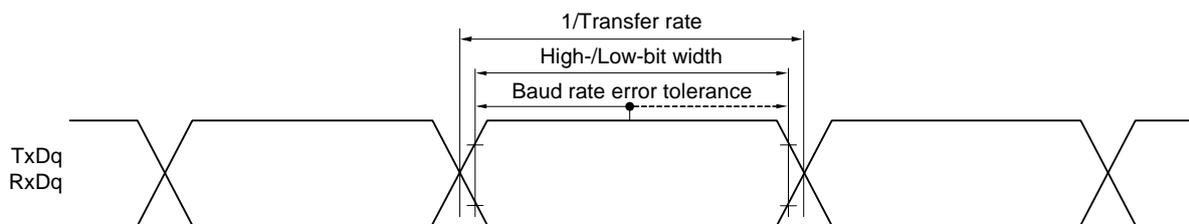

Remark 1. q: UART number (q = 0 to 3), g: PIM and POM number (g = 0, 1, 5, 14)

Remark 2. fMCK: Serial array unit operation clock frequency
 (Operation clock to be set by the CKSmn bit of serial mode register mn (SMRmn). m: Unit number, n: Channel number (mn = 00 to 03, 10 to 13))

(2) During communication at same potential (CSI mode) (master mode, SCKp... internal clock output)
($T_A = -40$ to $+105^\circ\text{C}$, $2.4\text{ V} \leq \text{EVDD0} = \text{EVDD1} \leq \text{VDD} \leq 5.5\text{ V}$, $\text{VSS} = \text{EVSS0} = \text{EVSS1} = 0\text{ V}$)

| Parameter | Symbol | Conditions | HS (high-speed main) mode | | Unit | |
|--|------------|--|--|------|------|----|
| | | | MIN. | MAX. | | |
| SCKp cycle time | tkCY1 | $\text{tkCY1} \geq 4/f_{\text{CLK}}$ | $2.7\text{ V} \leq \text{EVDD0} \leq 5.5\text{ V}$ | 250 | | ns |
| | | | $2.4\text{ V} \leq \text{EVDD0} \leq 5.5\text{ V}$ | 500 | | ns |
| SCKp high-/low-level width | tkH1, tkL1 | $4.0\text{ V} \leq \text{EVDD0} \leq 5.5\text{ V}$ | $\text{tkCY1}/2 - 24$ | | ns | |
| | | $2.7\text{ V} \leq \text{EVDD0} \leq 5.5\text{ V}$ | $\text{tkCY1}/2 - 36$ | | ns | |
| | | $2.4\text{ V} \leq \text{EVDD0} \leq 5.5\text{ V}$ | $\text{tkCY1}/2 - 76$ | | ns | |
| Slp setup time (to SCKp \uparrow) Note 1 | tsIK1 | $4.0\text{ V} \leq \text{EVDD0} \leq 5.5\text{ V}$ | 66 | | ns | |
| | | $2.7\text{ V} \leq \text{EVDD0} \leq 5.5\text{ V}$ | 66 | | ns | |
| | | $2.4\text{ V} \leq \text{EVDD0} \leq 5.5\text{ V}$ | 113 | | ns | |
| Slp hold time (from SCKp \uparrow) Note 2 | tkSH1 | | 38 | | ns | |
| Delay time from SCKp \downarrow to SOp output Note 3 | tkSO1 | $C = 30\text{ pF}$ Note 4 | | 50 | ns | |

Note 1. When DAPmn = 0 and CKPmn = 0, or DAPmn = 1 and CKPmn = 1. The Slp setup time becomes “to SCKp \downarrow ” when DAPmn = 0 and CKPmn = 1, or DAPmn = 1 and CKPmn = 0.

Note 2. When DAPmn = 0 and CKPmn = 0, or DAPmn = 1 and CKPmn = 1. The Slp hold time becomes “from SCKp \downarrow ” when DAPmn = 0 and CKPmn = 1, or DAPmn = 1 and CKPmn = 0.

Note 3. When DAPmn = 0 and CKPmn = 0, or DAPmn = 1 and CKPmn = 1. The delay time to SOp output becomes “from SCKp \uparrow ” when DAPmn = 0 and CKPmn = 1, or DAPmn = 1 and CKPmn = 0.

Note 4. C is the load capacitance of the SCKp and SOp output lines.

Caution Select the normal input buffer for the Slp pin and the normal output mode for the SOp pin and SCKp pin by using port input mode register g (PIMg) and port output mode register g (POMg).

Remark 1. p: CSI number (p = 00, 01, 10, 11, 20, 21, 30, 31), m: Unit number (m = 0, 1), n: Channel number (n = 0 to 3), g: PIM number (g = 0, 1, 3 to 5, 14)

Remark 2. f_{MCK}: Serial array unit operation clock frequency
 (Operation clock to be set by the CKSmn bit of serial mode register mn (SMRmn). m: Unit number, n: Channel number (mn = 00 to 03, 10 to 13))

(3) During communication at same potential (CSI mode) (slave mode, SCKp... external clock input)**(TA = -40 to +105°C, 2.4 V ≤ EVDD0 = EVDD1 ≤ VDD ≤ 5.5 V, VSS = EVSS0 = EVSS1 = 0 V)****(1/2)**

| Parameter | Symbol | Conditions | HS (high-speed main) mode | | Unit |
|---|------------|-----------------------------|---------------------------|--------------|------|
| | | | MIN. | MAX. | |
| SCKp cycle time ^{Note 5} | tkCY2 | 4.0 V ≤ EVDD0 ≤ 5.5 V | 20 MHz < fMCK | 16/fMCK | ns |
| | | | fMCK ≤ 20 MHz | 12/fMCK | ns |
| | | 2.7 V ≤ EVDD0 ≤ 5.5 V | 16 MHz < fMCK | 16/fMCK | ns |
| | | | fMCK ≤ 16 MHz | 12/fMCK | ns |
| | | 2.4 V ≤ EVDD0 ≤ 5.5 V | 12/fMCK and 1000 | ns | |
| SCKp high-/low-level width | tkH2, tkL2 | 4.0 V ≤ EVDD0 ≤ 5.5 V | tkCY2/2 - 14 | ns | |
| | | 2.7 V ≤ EVDD0 ≤ 5.5 V | tkCY2/2 - 16 | ns | |
| | | 2.4 V ≤ EVDD0 ≤ 5.5 V | tkCY2/2 - 36 | ns | |
| Slp setup time (to SCKp↑) ^{Note 1} | tSIK2 | 2.7 V ≤ EVDD0 ≤ 5.5 V | 1/fMCK + 40 | ns | |
| | | 2.4 V ≤ EVDD0 ≤ 5.5 V | 1/fMCK + 60 | ns | |
| Slp hold time (from SCKp↑) ^{Note 2} | tKSI2 | | 1/fMCK + 62 | ns | |
| Delay time from SCKp↓ to SOp output ^{Note 3} | tkSO2 | C = 30 pF ^{Note 4} | 2.7 V ≤ EVDD0 ≤ 5.5 V | 2/fMCK + 66 | ns |
| | | | 2.4 V ≤ EVDD0 ≤ 5.5 V | 2/fMCK + 113 | ns |

Note 1. When DAPmn = 0 and CKPmn = 0, or DAPmn = 1 and CKPmn = 1. The Slp setup time becomes “to SCKp↓” when DAPmn = 0 and CKPmn = 1, or DAPmn = 1 and CKPmn = 0.

Note 2. When DAPmn = 0 and CKPmn = 0, or DAPmn = 1 and CKPmn = 1. The Slp hold time becomes “from SCKp↓” when DAPmn = 0 and CKPmn = 1, or DAPmn = 1 and CKPmn = 0.

Note 3. When DAPmn = 0 and CKPmn = 0, or DAPmn = 1 and CKPmn = 1. The delay time to SOp output becomes “from SCKp↑” when DAPmn = 0 and CKPmn = 1, or DAPmn = 1 and CKPmn = 0.

Note 4. C is the load capacitance of the SOp output lines.

Note 5. The maximum transfer rate when using the SNOOZE mode is 1 Mbps.

Caution Select the normal input buffer for the Slp pin and SCKp pin and the normal output mode for the SOp pin by using port input mode register g (PIMg) and port output mode register g (POMg).

Remark 1. p: CSI number (p = 00, 01, 10, 11, 20, 21, 30, 31), m: Unit number (m = 0, 1), n: Channel number (n = 0 to 3), g: PIM number (g = 0, 1, 3 to 5, 14)

Remark 2. fMCK: Serial array unit operation clock frequency
(Operation clock to be set by the CKSmn bit of serial mode register mn (SMRmn). m: Unit number, n: Channel number (mn = 00 to 03, 10 to 13))

(3) During communication at same potential (CSI mode) (slave mode, SCKp... external clock input)

(TA = -40 to +105°C, 2.4 V ≤ EVDD0 = EVDD1 ≤ VDD ≤ 5.5 V, VSS = EVSS0 = EVSS1 = 0 V)

(2/2)

| Parameter | Symbol | Conditions | HS (high-speed main) mode | | Unit | |
|--------------------------------------|--------|------------|---------------------------|--------------|------|----|
| | | | MIN. | MAX. | | |
| $\overline{\text{SSI00}}$ setup time | tSSIK | DAPmn = 0 | 2.7 V ≤ EVDD0 ≤ 5.5 V | 240 | | ns |
| | | | 2.4 V ≤ EVDD0 ≤ 5.5 V | 400 | | ns |
| | | DAPmn = 1 | 2.7 V ≤ EVDD0 ≤ 5.5 V | 1/fMCK + 240 | | ns |
| | | | 2.4 V ≤ EVDD0 ≤ 5.5 V | 1/fMCK + 400 | | ns |
| $\overline{\text{SSI00}}$ hold time | tkSSI | DAPmn = 0 | 2.7 V ≤ EVDD0 ≤ 5.5 V | 1/fMCK + 240 | | ns |
| | | | 2.4 V ≤ EVDD0 ≤ 5.5 V | 1/fMCK + 400 | | ns |
| | | DAPmn = 1 | 2.7 V ≤ EVDD0 ≤ 5.5 V | 240 | | ns |
| | | | 2.4 V ≤ EVDD0 ≤ 5.5 V | 400 | | ns |

Caution Select the normal input buffer for the Slp pin and SCKp pin and the normal output mode for the SOp pin by using port input mode register g (PIMg) and port output mode register g (POMg).

Remark p: CSI number (p = 00), m: Unit number (m = 0), n: Channel number (n = 0), g: PIM number (g = 3, 5)

CSI mode connection diagram (during communication at same potential)

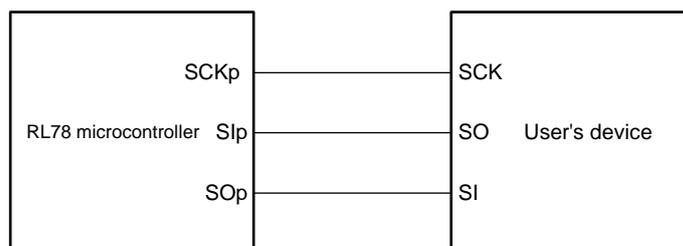

**CSI mode connection diagram (during communication at same potential)
(Slave Transmission of slave select input function (CSI00))**

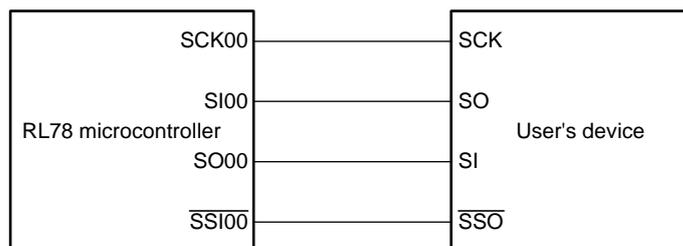

Remark 1. p: CSI number (p = 00, 01, 10, 11, 20, 21, 30, 31)

Remark 2. m: Unit number, n: Channel number (mn = 00 to 03, 10 to 13)

CSI mode serial transfer timing (during communication at same potential)
(When DAPmn = 0 and CKPmn = 0, or DAPmn = 1 and CKPmn = 1.)

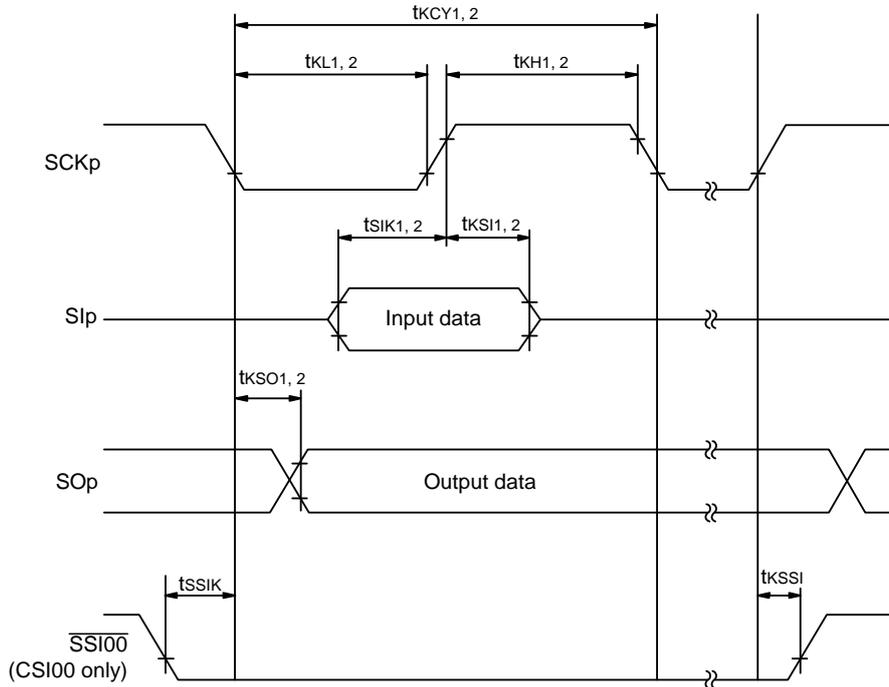

CSI mode serial transfer timing (during communication at same potential)
(When DAPmn = 0 and CKPmn = 1, or DAPmn = 1 and CKPmn = 0.)

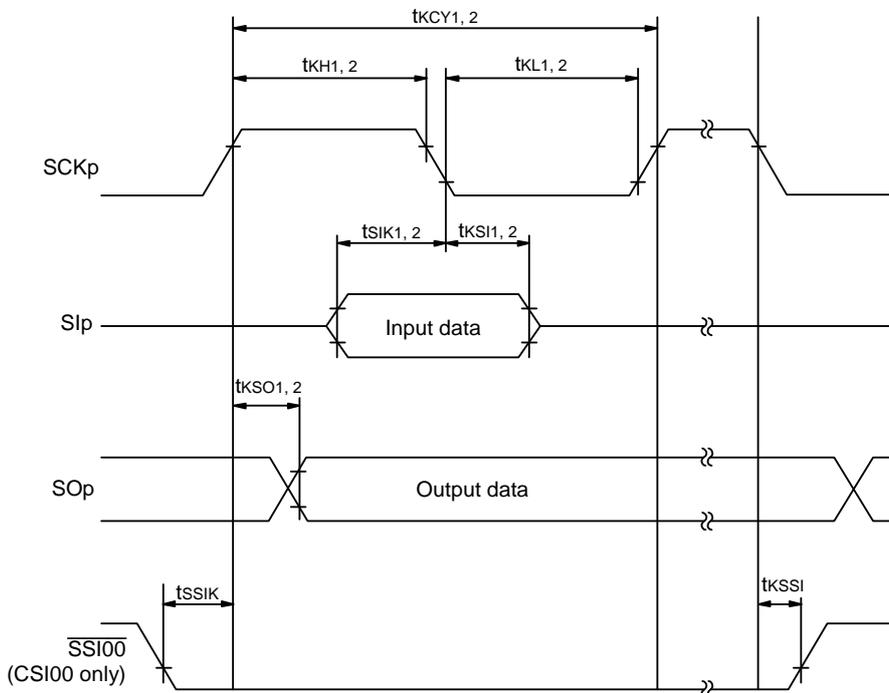

Remark 1. p: CSI number (p = 00, 01, 10, 11, 20, 21, 30, 31)

Remark 2. m: Unit number, n: Channel number (mn = 00 to 03, 10 to 13)

(4) During communication at same potential (simplified I²C mode)**(TA = -40 to +105°C, 2.4 V ≤ EVDD0 = EVDD1 ≤ VDD ≤ 5.5 V, VSS = EVSS0 = EVSS1 = 0 V)**

| Parameter | Symbol | Conditions | HS (high-speed main) mode | | Unit |
|-------------------------------|----------------------|---|---------------------------------|------------|------|
| | | | MIN. | MAX. | |
| SCLr clock frequency | f _{SCL} | 2.7 V ≤ EVDD0 ≤ 5.5 V, Cb = 50 pF, Rb = 2.7 kΩ | | 400 Note 1 | kHz |
| | | 2.4 V ≤ EVDD0 ≤ 5.5 V, Cb = 100 pF, Rb = 3 kΩ | | 100 Note 1 | kHz |
| Hold time when SCLr = "L" | t _{LOW} | 2.7 V ≤ EVDD0 ≤ 5.5 V, Cb = 50 pF, Rb = 2.7 kΩ | 1200 | | ns |
| | | 2.4 V ≤ EVDD0 ≤ 5.5 V, Cb = 100 pF, Rb = 3 kΩ | 4600 | | ns |
| Hold time when SCLr = "H" | t _{HIGH} | 2.7 V ≤ EVDD0 ≤ 5.5 V, Cb = 50 pF, Rb = 2.7 kΩ | 1200 | | ns |
| | | 2.4 V ≤ EVDD0 ≤ 5.5 V, Cb = 100 pF, Rb = 3 kΩ | 4600 | | ns |
| Data setup time (reception) | t _{SU: DAT} | 2.7 V ≤ EVDD0 ≤ 5.5 V, Cb = 50 pF, Rb = 2.7 kΩ | 1/f _{MCK} + 220 Note 2 | | ns |
| | | 2.4 V ≤ EVDD0 ≤ 5.5 V, Cb = 100 pF, Rb = 3 kΩ | 1/f _{MCK} + 580 Note 2 | | ns |
| Data hold time (transmission) | t _{HD: DAT} | 2.7 V ≤ EVDD0 ≤ 5.5 V, Cb = 50 pF, Rb = 2.7 kΩ | 0 | 770 | ns |
| | | 2.4 V ≤ EVDD0 ≤ 5.5 V, Cb = 100 pF, Rb = 3 kΩ | 0 | 1420 | ns |

Note 1. The value must also be equal to or less than f_{MCK}/4.**Note 2.** Set the f_{MCK} value to keep the hold time of SCLr = "L" and SCLr = "H".

Caution Select the normal input buffer and the N-ch open drain output (V_{DD} tolerance (for the 30- to 52-pin products)/EV_{DD} tolerance (for the 64- to 100-pin products)) mode for the SDAr pin and the normal output mode for the SCLr pin by using port input mode register g (PIMg) and port output mode register h (POMh).

(Remarks are listed on the next page.)

Simplified I²C mode connection diagram (during communication at same potential)

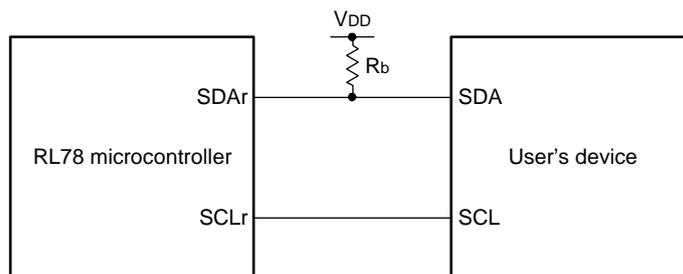

Simplified I²C mode serial transfer timing (during communication at same potential)

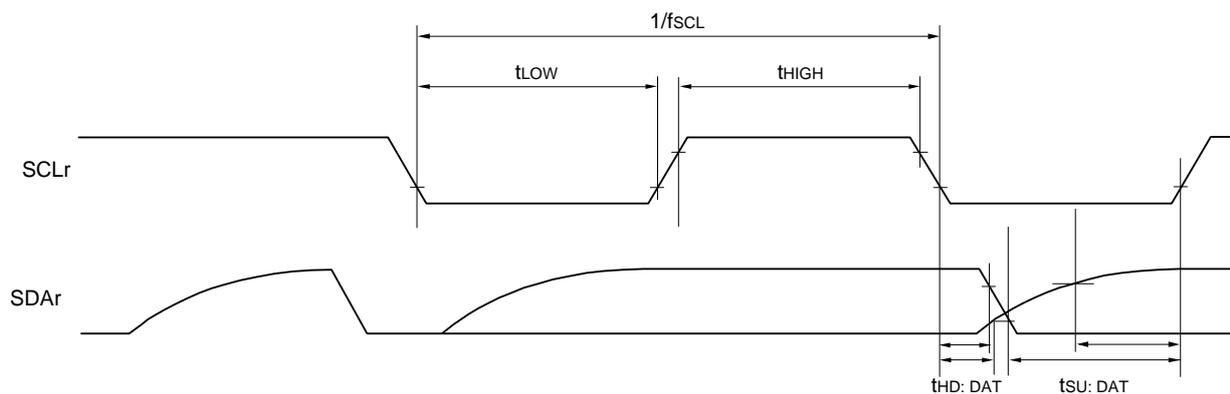

Remark 1. $R_b[\Omega]$: Communication line (SDAr) pull-up resistance, $C_b[F]$: Communication line (SDAr, SCLr) load capacitance

Remark 2. r: IIC number (r = 00, 01, 10, 11, 20, 21, 30, 31), g: PIM number (g = 0, 1, 3 to 5, 14),
h: POM number (h = 0, 1, 3 to 5, 7, 14)

Remark 3. f_{MCK} : Serial array unit operation clock frequency
(Operation clock to be set by the CKSmn bit of serial mode register mn (SMRmn). m: Unit number (m = 0, 1),
n: Channel number (n = 0 to 3), mn = 00 to 03, 10 to 13)

(5) Communication at different potential (1.8 V, 2.5 V, 3 V) (UART mode)**(TA = -40 to +105°C, 2.4 V ≤ EVDD0 = EVDD1 ≤ VDD ≤ 5.5 V, VSS = EVSS0 = EVSS1 = 0 V)****(1/2)**

| Parameter | Symbol | Conditions | HS (high-speed main) mode | | Unit | |
|---------------|--------|------------|--|------|--------------------|------|
| | | | MIN. | MAX. | | |
| Transfer rate | | reception | 4.0 V ≤ EVDD0 ≤ 5.5 V, 2.7 V ≤ Vb ≤ 4.0 V | | fMCK/12 Note 1 | bps |
| | | | Theoretical value of the maximum transfer rate fMCK = fCLK Note 3 | | 2.6 | Mbps |
| | | | 2.7 V ≤ EVDD0 < 4.0 V, 2.3 V ≤ Vb ≤ 2.7 V | | fMCK/12 Note 1 | bps |
| | | | Theoretical value of the maximum transfer rate fMCK = fCLK Note 3 | | 2.6 | Mbps |
| | | | 2.4 V ≤ EVDD0 < 3.3 V, 1.6 V ≤ Vb ≤ 2.0 V | | fMCK/12 Notes 1, 2 | bps |
| | | | Theoretical value of the maximum transfer rate fMCK = fCLK Note 3 | | 2.6 | Mbps |

Note 1. Transfer rate in the SNOOZE mode is 4800 bps only.

However, the SNOOZE mode cannot be used when FRQSEL4 = 1.

Note 2. The following conditions are required for low voltage interface when EVDD0 < VDD.

2.4 V ≤ EVDD0 < 2.7 V: MAX. 1.3 Mbps

Note 3. The maximum operating frequencies of the CPU/peripheral hardware clock (fCLK) are:

HS (high-speed main) mode: 32 MHz (2.7 V ≤ VDD ≤ 5.5 V)

16 MHz (2.4 V ≤ VDD ≤ 5.5 V)

Caution Select the TTL input buffer for the RxDq pin and the N-ch open drain output (VDD tolerance (for the 30- to 52-pin products)/EVDD tolerance (for the 64- to 100-pin products)) mode for the TxDq pin by using port input mode register g (PIMg) and port output mode register g (POMg). For VIH and VIL, see the DC characteristics with TTL input buffer selected.

Remark 1. Vb [V]: Communication line voltage

Remark 2. q: UART number (q = 0 to 3), g: PIM and POM number (g = 0, 1, 5, 14)

Remark 3. fMCK: Serial array unit operation clock frequency

(Operation clock to be set by the CKSmn bit of serial mode register mn (SMRmn). m: Unit number,

n: Channel number (mn = 00 to 03, 10 to 13)

Remark 4. UART2 cannot communicate at different potential when bit 1 (PIOR01) of peripheral I/O redirection register 0 (PIOR0) is 1.

(5) Communication at different potential (1.8 V, 2.5 V, 3 V) (UART mode)**(TA = -40 to +105°C, 2.4 V ≤ EVDD0 = EVDD1 ≤ VDD ≤ 5.5 V, VSS = EVSS0 = EVSS1 = 0 V)****(2/2)**

| Parameter | Symbol | Conditions | HS (high-speed main) mode | | Unit | |
|---------------|--------|--|--|-------------|------------|------|
| | | | MIN. | MAX. | | |
| Transfer rate | | transmission | 4.0 V ≤ EVDD0 ≤ 5.5 V, 2.7 V ≤ Vb ≤ 4.0 V | | Note 1 | bps |
| | | | Theoretical value of the maximum transfer rate Cb = 50 pF, Rb = 1.4 kΩ, Vb = 2.7 V | | 2.6 Note 2 | Mbps |
| | | 2.7 V ≤ EVDD0 < 4.0 V, 2.3 V ≤ Vb ≤ 2.7 V | | Note 3 | bps | |
| | | Theoretical value of the maximum transfer rate Cb = 50 pF, Rb = 2.7 kΩ, Vb = 2.3 V | | 1.2 Note 4 | Mbps | |
| | | 2.4 V ≤ EVDD0 < 3.3 V, 1.6 V ≤ Vb ≤ 2.0 V | | Note 5 | bps | |
| | | Theoretical value of the maximum transfer rate Cb = 50 pF, Rb = 5.5 kΩ, Vb = 1.6 V | | 0.43 Note 6 | Mbps | |

Note 1. The smaller maximum transfer rate derived by using fmck/12 or the following expression is the valid maximum transfer rate.

Expression for calculating the transfer rate when 4.0 V ≤ EVDD0 ≤ 5.5 V and 2.7 V ≤ Vb ≤ 4.0 V

$$\text{Maximum transfer rate} = \frac{1}{\{-C_b \times R_b \times \ln(1 - \frac{2.2}{V_b})\} \times 3} \text{ [bps]}$$

$$\text{Baud rate error (theoretical value)} = \frac{\frac{1}{\text{Transfer rate} \times 2} - \{-C_b \times R_b \times \ln(1 - \frac{2.2}{V_b})\}}{(\frac{1}{\text{Transfer rate}}) \times \text{Number of transferred bits}} \times 100 \text{ [%]}$$

* This value is the theoretical value of the relative difference between the transmission and reception sides

Note 2. This value as an example is calculated when the conditions described in the "Conditions" column are met. Refer to **Note 1** above to calculate the maximum transfer rate under conditions of the customer.

Note 3. The smaller maximum transfer rate derived by using fmck/12 or the following expression is the valid maximum transfer rate.

Expression for calculating the transfer rate when 2.7 V ≤ EVDD0 < 4.0 V and 2.3 V ≤ Vb ≤ 2.7 V

$$\text{Maximum transfer rate} = \frac{1}{\{-C_b \times R_b \times \ln(1 - \frac{2.0}{V_b})\} \times 3} \text{ [bps]}$$

$$\text{Baud rate error (theoretical value)} = \frac{\frac{1}{\text{Transfer rate} \times 2} - \{-C_b \times R_b \times \ln(1 - \frac{2.0}{V_b})\}}{(\frac{1}{\text{Transfer rate}}) \times \text{Number of transferred bits}} \times 100 \text{ [%]}$$

* This value is the theoretical value of the relative difference between the transmission and reception sides

Note 4. This value as an example is calculated when the conditions described in the "Conditions" column are met. Refer to **Note 3** above to calculate the maximum transfer rate under conditions of the customer.

Note 5. The smaller maximum transfer rate derived by using $f_{MCK}/12$ or the following expression is the valid maximum transfer rate.

Expression for calculating the transfer rate when $2.4\text{ V} \leq EV_{DD0} < 3.3\text{ V}$ and $1.6\text{ V} \leq V_b \leq 2.0\text{ V}$

$$\text{Maximum transfer rate} = \frac{1}{\{-C_b \times R_b \times \ln(1 - \frac{1.5}{V_b})\} \times 3} \text{ [bps]}$$

$$\text{Baud rate error (theoretical value)} = \frac{\frac{1}{\text{Transfer rate} \times 2} - \{-C_b \times R_b \times \ln(1 - \frac{1.5}{V_b})\}}{\left(\frac{1}{\text{Transfer rate}}\right) \times \text{Number of transferred bits}} \times 100 \text{ [%]}$$

* This value is the theoretical value of the relative difference between the transmission and reception sides

Note 6. This value as an example is calculated when the conditions described in the "Conditions" column are met. Refer to **Note 5** above to calculate the maximum transfer rate under conditions of the customer.

Caution Select the TTL input buffer for the RxDq pin and the N-ch open drain output (V_{DD} tolerance (for the 30- to 52-pin products)/ EV_{DD} tolerance (for the 64- to 100-pin products)) mode for the TxDq pin by using port input mode register g (PIMg) and port output mode register g (POMg). For V_{IH} and V_{IL} , see the DC characteristics with TTL input buffer selected.

(Remarks are listed on the next page.)

UART mode connection diagram (during communication at different potential)

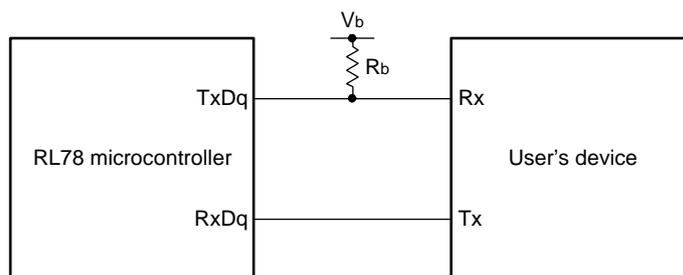

UART mode bit width (during communication at different potential) (reference)

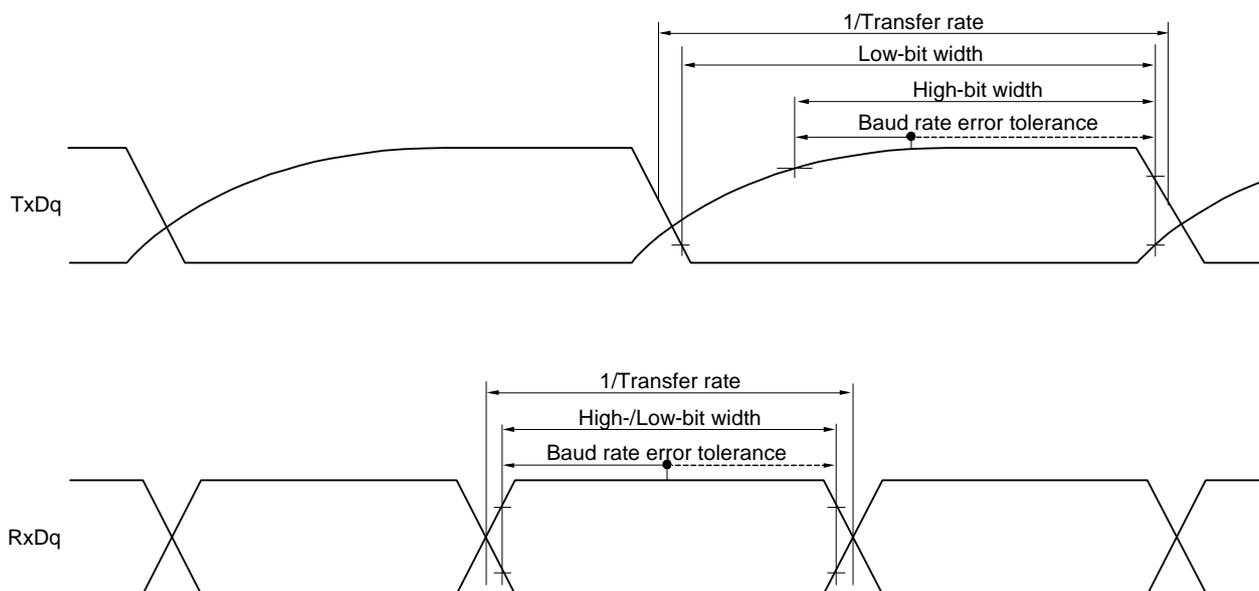

- Remark 1.** $R_b[\Omega]$: Communication line (TxDq) pull-up resistance,
 $C_b[F]$: Communication line (TxDq) load capacitance, $V_b[V]$: Communication line voltage
- Remark 2.** q: UART number (q = 0 to 3), g: PIM and POM number (g = 0, 1, 5, 14)
- Remark 3.** f_{mck} : Serial array unit operation clock frequency
 (Operation clock to be set by the CKSmn bit of serial mode register mn (SMRmn).
 m: Unit number, n: Channel number (mn = 00 to 03, 10 to 13))
- Remark 4.** UART2 cannot communicate at different potential when bit 1 (PIOR01) of peripheral I/O redirection register 0 (PIOR0) is 1.

(6) Communication at different potential (1.8 V, 2.5 V, 3 V) (CSI mode) (master mode, SCKp... internal clock output)**(TA = -40 to +105°C, 2.4 V ≤ EVDD0 = EVDD1 ≤ VDD ≤ 5.5 V, VSS = EVSS0 = EVSS1 = 0 V)****(1/3)**

| Parameter | Symbol | Conditions | HS (high-speed main) mode | | Unit |
|-----------------------|--------|--|---------------------------|------|------|
| | | | MIN. | MAX. | |
| SCKp cycle time | tkCY1 | tkCY1 ≥ 4/fCLK 4.0 V ≤ EVDD0 ≤ 5.5 V, 2.7 V ≤ Vb ≤ 4.0 V, Cb = 30 pF, Rb = 1.4 kΩ | 600 | | ns |
| | | | 1000 | | ns |
| | | | 2300 | | ns |
| SCKp high-level width | tkH1 | 4.0 V ≤ EVDD0 ≤ 5.5 V, 2.7 V ≤ Vb ≤ 4.0 V, Cb = 30 pF, Rb = 1.4 kΩ | tkCY1/2 - 150 | | ns |
| | | 2.7 V ≤ EVDD0 < 4.0 V, 2.3 V ≤ Vb ≤ 2.7 V, Cb = 30 pF, Rb = 2.7 kΩ | tkCY1/2 - 340 | | ns |
| | | 2.4 V ≤ EVDD0 < 3.3 V, 1.6 V ≤ Vb ≤ 2.0 V, Cb = 30 pF, Rb = 5.5 kΩ | tkCY1/2 - 916 | | ns |
| SCKp low-level width | tkL1 | 4.0 V ≤ EVDD0 ≤ 5.5 V, 2.7 V ≤ Vb ≤ 4.0 V, Cb = 30 pF, Rb = 1.4 kΩ | tkCY1/2 - 24 | | ns |
| | | 2.7 V ≤ EVDD0 < 4.0 V, 2.3 V ≤ Vb ≤ 2.7 V, Cb = 30 pF, Rb = 2.7 kΩ | tkCY1/2 - 36 | | ns |
| | | 2.4 V ≤ EVDD0 < 3.3 V, 1.6 V ≤ Vb ≤ 2.0 V, Cb = 30 pF, Rb = 5.5 kΩ | tkCY1/2 - 100 | | ns |

Caution Select the TTL input buffer for the SIp pin and the N-ch open drain output (VDD tolerance (for the 30- to 52-pin products)/EVDD tolerance (for the 64- to 100-pin products)) mode for the SOp pin and SCKp pin by using port input mode register g (PIMg) and port output mode register g (POMg). For VIH and VIL, see the DC characteristics with TTL input buffer selected.

(Remarks are listed two pages after the next page.)

(6) Communication at different potential (1.8 V, 2.5 V, 3 V) (CSI mode) (master mode, SCKp... internal clock output)**(TA = -40 to +105°C, 2.4 V ≤ EVDD0 = EVDD1 ≤ VDD ≤ 5.5 V, VSS = EVSS0 = EVSS1 = 0 V)****(2/3)**

| Parameter | Symbol | Conditions | HS (high-speed main) mode | | Unit |
|---|--------|--|---------------------------|------|------|
| | | | MIN. | MAX. | |
| Slp setup time (to SCKp↑) ^{Note} | tsIK1 | 4.0 V ≤ EVDD0 ≤ 5.5 V, 2.7 V ≤ Vb ≤ 4.0 V, Cb = 30 pF, Rb = 1.4 kΩ | 162 | | ns |
| | | 2.7 V ≤ EVDD0 < 4.0 V, 2.3 V ≤ Vb ≤ 2.7 V, Cb = 30 pF, Rb = 2.7 kΩ | 354 | | ns |
| | | 2.4 V ≤ EVDD0 < 3.3 V, 1.6 V ≤ Vb ≤ 2.0 V, Cb = 30 pF, Rb = 5.5 kΩ | 958 | | ns |
| Slp hold time (from SCKp↑) ^{Note} | tkSH1 | 4.0 V ≤ EVDD0 ≤ 5.5 V, 2.7 V ≤ Vb ≤ 4.0 V, Cb = 30 pF, Rb = 1.4 kΩ | 38 | | ns |
| | | 2.7 V ≤ EVDD0 < 4.0 V, 2.3 V ≤ Vb ≤ 2.7 V, Cb = 30 pF, Rb = 2.7 kΩ | 38 | | ns |
| | | 2.4 V ≤ EVDD0 < 3.3 V, 1.6 V ≤ Vb ≤ 2.0 V, Cb = 30 pF, Rb = 5.5 kΩ | 38 | | ns |
| Delay time from SCKp↓ to SOp output ^{Note} | tkSO1 | 4.0 V ≤ EVDD0 ≤ 5.5 V, 2.7 V ≤ Vb ≤ 4.0 V, Cb = 30 pF, Rb = 1.4 kΩ | | 200 | ns |
| | | 2.7 V ≤ EVDD0 < 4.0 V, 2.3 V ≤ Vb ≤ 2.7 V, Cb = 30 pF, Rb = 2.7 kΩ | | 390 | ns |
| | | 2.4 V ≤ EVDD0 < 3.3 V, 1.6 V ≤ Vb ≤ 2.0 V, Cb = 30 pF, Rb = 5.5 kΩ | | 966 | ns |

Note When DAPmn = 0 and CKPmn = 0, or DAPmn = 1 and CKPmn = 1.

Caution Select the TTL input buffer for the Slp pin and the N-ch open drain output (VDD tolerance (for the 30- to 52-pin products)/EVDD tolerance (for the 64- to 100-pin products)) mode for the SOp pin and SCKp pin by using port input mode register g (PIMg) and port output mode register g (POMg). For VIH and VIL, see the DC characteristics with TTL input buffer selected.

(Remarks are listed on the page after the next page.)

(6) Communication at different potential (1.8 V, 2.5 V, 3 V) (CSI mode) (master mode, SCKp... internal clock output)**(TA = -40 to +105°C, 2.4 V ≤ EVDD0 = EVDD1 ≤ VDD ≤ 5.5 V, VSS = EVSS0 = EVSS1 = 0 V)****(3/3)**

| Parameter | Symbol | Conditions | HS (high-speed main) mode | | Unit |
|---|--------|--|---------------------------|------|------|
| | | | MIN. | MAX. | |
| Slp setup time (to SCKp↓) ^{Note} | tsIK1 | 4.0 V ≤ EVDD0 ≤ 5.5 V, 2.7 V ≤ Vb ≤ 4.0 V, Cb = 30 pF, Rb = 1.4 kΩ | 88 | | ns |
| | | 2.7 V ≤ EVDD0 < 4.0 V, 2.3 V ≤ Vb ≤ 2.7 V, Cb = 30 pF, Rb = 2.7 kΩ | 88 | | ns |
| | | 2.4 V ≤ EVDD0 < 3.3 V, 1.6 V ≤ Vb ≤ 2.0 V, Cb = 30 pF, Rb = 5.5 kΩ | 220 | | ns |
| Slp hold time (from SCKp↓) ^{Note} | tkSH1 | 4.0 V ≤ EVDD0 ≤ 5.5 V, 2.7 V ≤ Vb ≤ 4.0 V, Cb = 30 pF, Rb = 1.4 kΩ | 38 | | ns |
| | | 2.7 V ≤ EVDD0 < 4.0 V, 2.3 V ≤ Vb ≤ 2.7 V, Cb = 30 pF, Rb = 2.7 kΩ | 38 | | ns |
| | | 2.4 V ≤ EVDD0 < 3.3 V, 1.6 V ≤ Vb ≤ 2.0 V, Cb = 30 pF, Rb = 5.5 kΩ | 38 | | ns |
| Delay time from SCKp↑ to SOp output ^{Note} | tkSO1 | 4.0 V ≤ EVDD0 ≤ 5.5 V, 2.7 V ≤ Vb ≤ 4.0 V, Cb = 30 pF, Rb = 1.4 kΩ | | 50 | ns |
| | | 2.7 V ≤ EVDD0 < 4.0 V, 2.3 V ≤ Vb ≤ 2.7 V, Cb = 30 pF, Rb = 2.7 kΩ | | 50 | ns |
| | | 2.4 V ≤ EVDD0 < 3.3 V, 1.6 V ≤ Vb ≤ 2.0 V, Cb = 30 pF, Rb = 5.5 kΩ | | 50 | ns |

Note When DAPmn = 0 and CKPmn = 1, or DAPmn = 1 and CKPmn = 0.

Caution Select the TTL input buffer for the Slp pin and the N-ch open drain output (VDD tolerance (for the 30- to 52-pin products)/EVDD tolerance (for the 64- to 100-pin products)) mode for the SOp pin and SCKp pin by using port input mode register g (PIMg) and port output mode register g (POMg). For VIH and VIL, see the DC characteristics with TTL input buffer selected.

(Remarks are listed on the next page.)

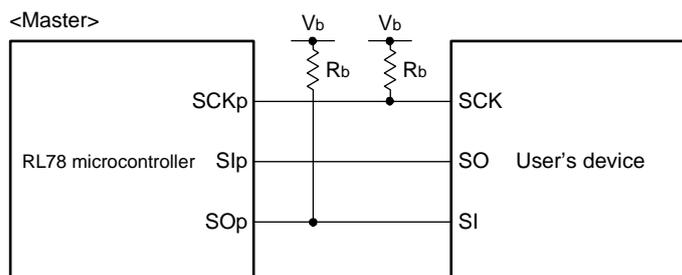
CSI mode connection diagram (during communication at different potential)

Remark 5. $R_b[\Omega]$: Communication line (SCKp, SOp) pull-up resistance, $C_b[F]$: Communication line (SCKp, SOp) load capacitance, $V_b[V]$: Communication line voltage

Remark 6. p: CSI number (p = 00, 01, 10, 20, 30, 31), m: Unit number (m = 0, 1), n: Channel number (n = 0 to 3), g: PIM and POM number (g = 0, 1, 3 to 5, 14)

Remark 7. f_{MCK} : Serial array unit operation clock frequency
(Operation clock to be set by the CKSmn bit of serial mode register mn (SMRmn). m: Unit number, n: Channel number (mn = 00))

Remark 8. CSI01 of 48-, 52-, 64-pin products, and CSI11 and CSI21 cannot communicate at different potential. Use other CSI for communication at different potential.

**CSI mode serial transfer timing (master mode) (during communication at different potential)
(When DAPmn = 0 and CKPmn = 0, or DAPmn = 1 and CKPmn = 1.)**

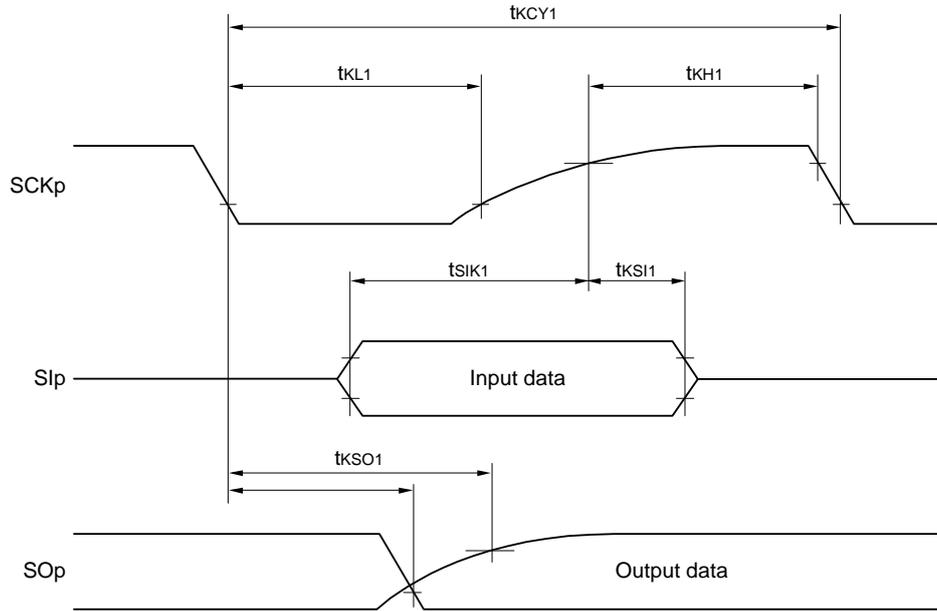

**CSI mode serial transfer timing (master mode) (during communication at different potential)
(When DAPmn = 0 and CKPmn = 1, or DAPmn = 1 and CKPmn = 0.)**

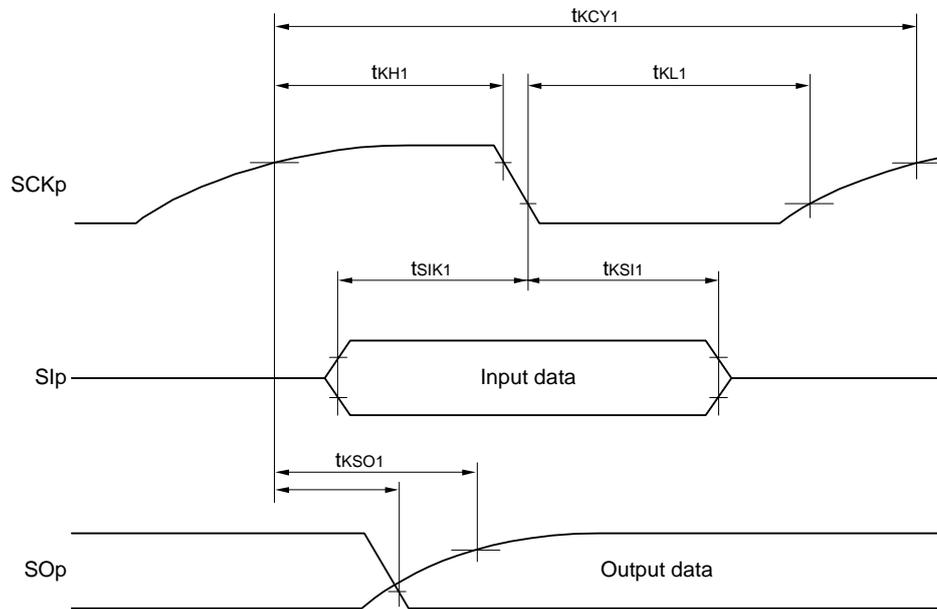

Remark 1. p: CSI number (p = 00, 01, 10, 20, 30, 31), m: Unit number (m = 0, 1), n: Channel number (n = 0 to 3),
g: PIM and POM number (g = 0, 1, 3 to 5, 14)

Remark 2. CSI01 of 48-, 52-, 64-pin products, and CSI11 and CSI21 cannot communicate at different potential. Use other CSI for communication at different potential.

(7) Communication at different potential (1.8 V, 2.5 V, 3 V) (CSI mode) (slave mode, SCKp... external clock input)**(TA = -40 to +105°C, 2.4 V ≤ EVDD0 = EVDD1 ≤ VDD ≤ 5.5 V, VSS = EVSS0 = EVSS1 = 0 V)**

| Parameter | Symbol | Conditions | HS (high-speed main) mode | | Unit | |
|---|--------|---|---------------------------|---------------|------|----|
| | | | MIN. | MAX. | | |
| SCKp cycle time ^{Note 1} | tkcy2 | 4.0 V ≤ EVDD0 ≤ 5.5 V, 2.7 V ≤ Vb ≤ 4.0 V | 24 MHz < fmck | 28/fmck | | ns |
| | | | 20 MHz < fmck ≤ 24 MHz | 24/fmck | | ns |
| | | | 8 MHz < fmck ≤ 20 MHz | 20/fmck | | ns |
| | | | 4 MHz < fmck ≤ 8 MHz | 16/fmck | | ns |
| | | | fmck ≤ 4 MHz | 12/fmck | | ns |
| | | 2.7 V ≤ EVDD0 < 4.0 V, 2.3 V ≤ Vb ≤ 2.7 V | 24 MHz < fmck | 40/fmck | | ns |
| | | | 20 MHz < fmck ≤ 24 MHz | 32/fmck | | ns |
| | | | 16 MHz < fmck ≤ 20 MHz | 28/fmck | | ns |
| | | | 8 MHz < fmck ≤ 16 MHz | 24/fmck | | ns |
| | | | 4 MHz < fmck ≤ 8 MHz | 16/fmck | | ns |
| | | 2.4 V ≤ EVDD0 < 3.3 V, 1.6 V ≤ Vb ≤ 2.0 V | 24 MHz < fmck | 96/fmck | | ns |
| | | | 20 MHz < fmck ≤ 24 MHz | 72/fmck | | ns |
| | | | 16 MHz < fmck ≤ 20 MHz | 64/fmck | | ns |
| | | | 8 MHz < fmck ≤ 16 MHz | 52/fmck | | ns |
| | | | 4 MHz < fmck ≤ 8 MHz | 32/fmck | | ns |
| | | fmck ≤ 4 MHz | 20/fmck | | ns | |
| | | SCKp high-/low-level width | | tkcy2/2 - 24 | | ns |
| | | 4.0 V ≤ EVDD0 ≤ 5.5 V, 2.7 V ≤ Vb ≤ 4.0 V | | | | |
| | | 2.7 V ≤ EVDD0 < 4.0 V, 2.3 V ≤ Vb ≤ 2.7 V | | | | |
| | | 2.4 V ≤ EVDD0 < 3.3 V, 1.6 V ≤ Vb ≤ 2.0 V | | tkcy2/2 - 100 | | ns |
| Slp setup time (to SCKp↑) ^{Note 2} | tsik2 | 4.0 V ≤ EVDD0 ≤ 5.5 V, 2.7 V ≤ Vb ≤ 4.0 V | 1/fmck + 40 | | ns | |
| | | 2.7 V ≤ EVDD0 < 4.0 V, 2.3 V ≤ Vb ≤ 2.7 V | 1/fmck + 40 | | ns | |
| | | 2.4 V ≤ EVDD0 < 3.3 V, 1.6 V ≤ Vb ≤ 2.0 V | 1/fmck + 60 | | ns | |
| Slp hold time (from SCKp↑) ^{Note 3} | tksl2 | | 1/fmck + 62 | | ns | |
| Delay time from SCKp↓ to SOp output ^{Note 4} | tkso2 | 4.0 V ≤ EVDD0 ≤ 5.5 V, 2.7 V ≤ Vb ≤ 4.0 V, Cb = 30 pF, Rb = 1.4 kΩ | | 2/fmck + 240 | ns | |
| | | 2.7 V ≤ EVDD0 < 4.0 V, 2.3 V ≤ Vb ≤ 2.7 V, Cb = 30 pF, Rb = 2.7 kΩ | | 2/fmck + 428 | ns | |
| | | 2.4 V ≤ EVDD0 < 3.3 V, 1.6 V ≤ Vb ≤ 2.0 V, Cb = 30 pF, Rv = 5.5 kΩ | | 2/fmck + 1146 | ns | |

(Notes, Caution, and Remarks are listed on the next page.)

- Note 1.** Transfer rate in the SNOOZE mode: MAX. 1 Mbps
- Note 2.** When $\text{DAPmn} = 0$ and $\text{CKPmn} = 0$, or $\text{DAPmn} = 1$ and $\text{CKPmn} = 1$. The Slp setup time becomes “to $\text{SCKp}\downarrow$ ” when $\text{DAPmn} = 0$ and $\text{CKPmn} = 1$, or $\text{DAPmn} = 1$ and $\text{CKPmn} = 0$.
- Note 3.** When $\text{DAPmn} = 0$ and $\text{CKPmn} = 0$, or $\text{DAPmn} = 1$ and $\text{CKPmn} = 1$. The Slp hold time becomes “from $\text{SCKp}\downarrow$ ” when $\text{DAPmn} = 0$ and $\text{CKPmn} = 1$, or $\text{DAPmn} = 1$ and $\text{CKPmn} = 0$.
- Note 4.** When $\text{DAPmn} = 0$ and $\text{CKPmn} = 0$, or $\text{DAPmn} = 1$ and $\text{CKPmn} = 1$. The delay time to SOp output becomes “from $\text{SCKp}\uparrow$ ” when $\text{DAPmn} = 0$ and $\text{CKPmn} = 1$, or $\text{DAPmn} = 1$ and $\text{CKPmn} = 0$.

Caution Select the TTL input buffer for the Slp pin and SCKp pin, and the N-ch open drain output (V_{DD} tolerance (for the 30- to 52-pin products)/ EV_{DD} tolerance (for the 64- to 100-pin products)) mode for the SOp pin by using port input mode register g (PIMg) and port output mode register g (POMg). For V_{IH} and V_{IL} , see the DC characteristics with TTL input buffer selected.

CSI mode connection diagram (during communication at different potential)

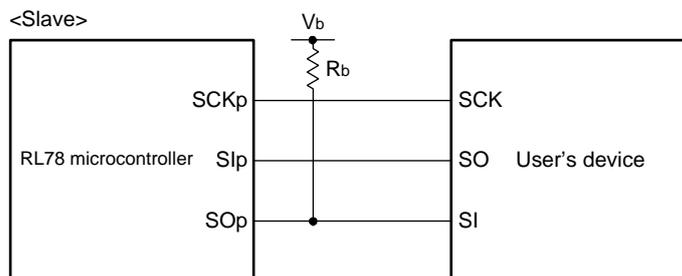

- Remark 1.** $R_b[\Omega]$: Communication line (SOp) pull-up resistance, $C_b[\text{F}]$: Communication line (SOp) load capacitance, $V_b[\text{V}]$: Communication line voltage
- Remark 2.** p: CSI number (p = 00, 01, 10, 20, 30, 31), m: Unit number (m = 0, 1), n: Channel number (n = 0 to 3), g: PIM and POM number (g = 0, 1, 3 to 5, 14)
- Remark 3.** f_{MCK} : Serial array unit operation clock frequency
(Operation clock to be set by the CKSmn bit of serial mode register mn (SMRmn).
m: Unit number, n: Channel number (mn = 00, 01, 02, 10, 12, 13))
- Remark 4.** CSI01 of 48-, 52-, 64-pin products, and CSI11 and CSI21 cannot communicate at different potential. Use other CSI for communication at different potential.
Also, communication at different potential cannot be performed during clock synchronous serial communication with the slave select function.

**CSI mode serial transfer timing (slave mode) (during communication at different potential)
(When DAPmn = 0 and CKPmn = 0, or DAPmn = 1 and CKPmn = 1.)**

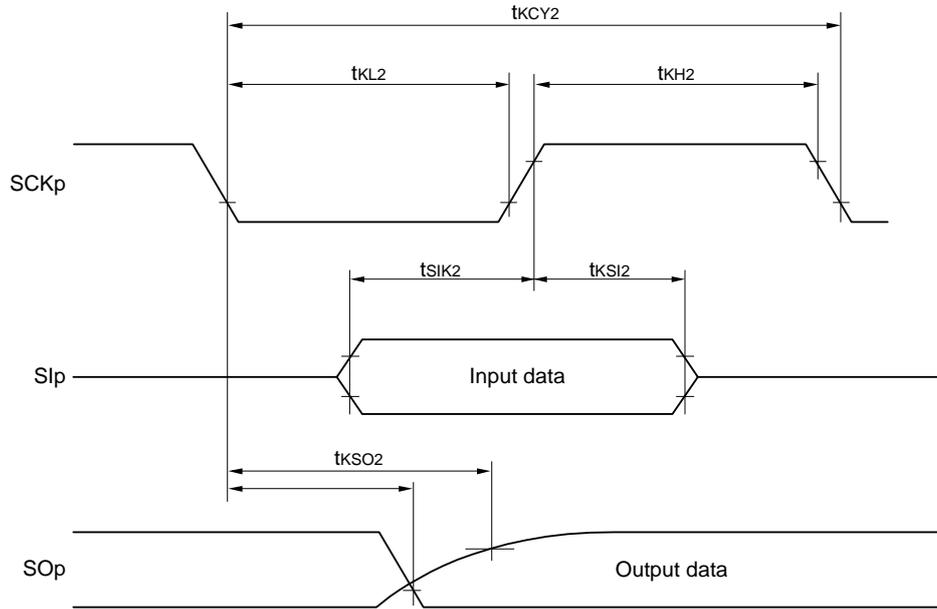

**CSI mode serial transfer timing (slave mode) (during communication at different potential)
(When DAPmn = 0 and CKPmn = 1, or DAPmn = 1 and CKPmn = 0.)**

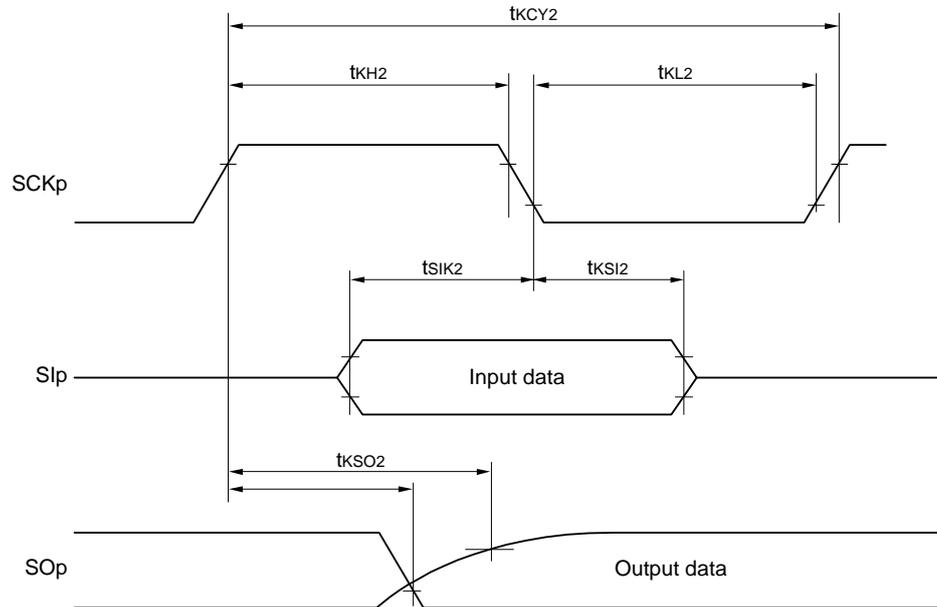

Remark 1. p: CSI number (p = 00, 01, 10, 20, 30, 31), m: Unit number (m = 0, 1), n: Channel number (n = 0 to 3), g: PIM and POM number (g = 0, 1, 3 to 5, 14)

Remark 2. CSI01 of 48-, 52-, 64-pin products, and CSI11 and CSI21 cannot communicate at different potential. Use other CSI for communication at different potential.

Also, communication at different potential cannot be performed during clock synchronous serial communication with the slave select function.

(8) Communication at different potential (1.8 V, 2.5 V, 3 V) (simplified I²C mode)**(TA = -40 to +105°C, 2.4 V ≤ EVDD0 = EVDD1 ≤ VDD ≤ 5.5 V, VSS = EVSS0 = EVSS1 = 0 V)****(1/2)**

| Parameter | Symbol | Conditions | HS (high-speed main) mode | | Unit |
|---------------------------|-------------------|---|---------------------------|------------|------|
| | | | MIN. | MAX. | |
| SCLr clock frequency | f _{SCL} | 4.0 V ≤ EVDD0 ≤ 5.5 V, 2.7 V ≤ Vb ≤ 4.0 V, Cb = 50 pF, Rb = 2.7 kΩ | | 400 Note 1 | kHz |
| | | 2.7 V ≤ EVDD0 < 4.0 V, 2.3 V ≤ Vb ≤ 2.7 V, Cb = 50 pF, Rb = 2.7 kΩ | | 400 Note 1 | kHz |
| | | 4.0 V ≤ EVDD0 ≤ 5.5 V, 2.7 V ≤ Vb ≤ 4.0 V, Cb = 100 pF, Rb = 2.8 kΩ | | 100 Note 1 | kHz |
| | | 2.7 V ≤ EVDD0 < 4.0 V, 2.3 V ≤ Vb ≤ 2.7 V, Cb = 100 pF, Rb = 2.7 kΩ | | 100 Note 1 | kHz |
| | | 2.4 V ≤ EVDD0 < 3.3 V, 1.6 V ≤ Vb ≤ 2.0 V, Cb = 100 pF, Rb = 5.5 kΩ | | 100 Note 1 | kHz |
| Hold time when SCLr = "L" | t _{LOW} | 4.0 V ≤ EVDD0 ≤ 5.5 V, 2.7 V ≤ Vb ≤ 4.0 V, Cb = 50 pF, Rb = 2.7 kΩ | 1200 | | ns |
| | | 2.7 V ≤ EVDD0 < 4.0 V, 2.3 V ≤ Vb ≤ 2.7 V, Cb = 50 pF, Rb = 2.7 kΩ | 1200 | | ns |
| | | 4.0 V ≤ EVDD0 ≤ 5.5 V, 2.7 V ≤ Vb ≤ 4.0 V, Cb = 100 pF, Rb = 2.8 kΩ | 4600 | | ns |
| | | 2.7 V ≤ EVDD0 < 4.0 V, 2.3 V ≤ Vb ≤ 2.7 V, Cb = 100 pF, Rb = 2.7 kΩ | 4600 | | ns |
| | | 2.4 V ≤ EVDD0 < 3.3 V, 1.6 V ≤ Vb ≤ 2.0 V, Cb = 100 pF, Rb = 5.5 kΩ | 4650 | | ns |
| Hold time when SCLr = "H" | t _{HIGH} | 4.0 V ≤ EVDD0 ≤ 5.5 V, 2.7 V ≤ Vb ≤ 4.0 V, Cb = 50 pF, Rb = 2.7 kΩ | 620 | | ns |
| | | 2.7 V ≤ EVDD0 < 4.0 V, 2.3 V ≤ Vb ≤ 2.7 V, Cb = 50 pF, Rb = 2.7 kΩ | 500 | | ns |
| | | 4.0 V ≤ EVDD0 ≤ 5.5 V, 2.7 V ≤ Vb ≤ 4.0 V, Cb = 100 pF, Rb = 2.8 kΩ | 2700 | | ns |
| | | 2.7 V ≤ EVDD0 < 4.0 V, 2.3 V ≤ Vb ≤ 2.7 V, Cb = 100 pF, Rb = 2.7 kΩ | 2400 | | ns |
| | | 2.4 V ≤ EVDD0 < 3.3 V, 1.6 V ≤ Vb ≤ 2.0 V, Cb = 100 pF, Rb = 5.5 kΩ | 1830 | | ns |

(8) Communication at different potential (1.8 V, 2.5 V, 3 V) (simplified I²C mode)**(TA = -40 to +105°C, 2.4 V ≤ EVDD0 = EVDD1 ≤ VDD ≤ 5.5 V, VSS = EVSS0 = EVSS1 = 0 V)****(2/2)**

| Parameter | Symbol | Conditions | HS (high-speed main) mode | | Unit |
|-------------------------------|---------------------|---|---------------------------------|------|------|
| | | | MIN. | MAX. | |
| Data setup time (reception) | t _{SU:DAT} | 4.0 V ≤ EVDD0 ≤ 5.5 V, 2.7 V ≤ V _b ≤ 4.0 V, C _b = 50 pF, R _b = 2.7 kΩ | 1/f _{MCK} + 340 Note 2 | | ns |
| | | 2.7 V ≤ EVDD0 < 4.0 V, 2.3 V ≤ V _b ≤ 2.7 V, C _b = 50 pF, R _b = 2.7 kΩ | 1/f _{MCK} + 340 Note 2 | | ns |
| | | 4.0 V ≤ EVDD0 ≤ 5.5 V, 2.7 V ≤ V _b ≤ 4.0 V, C _b = 100 pF, R _b = 2.8 kΩ | 1/f _{MCK} + 760 Note 2 | | ns |
| | | 2.7 V ≤ EVDD0 < 4.0 V, 2.3 V ≤ V _b ≤ 2.7 V, C _b = 100 pF, R _b = 2.7 kΩ | 1/f _{MCK} + 760 Note 2 | | ns |
| | | 2.4 V ≤ EVDD0 < 3.3 V, 1.6 V ≤ V _b ≤ 2.0 V, C _b = 100 pF, R _b = 5.5 kΩ | 1/f _{MCK} + 570 Note 2 | | ns |
| Data hold time (transmission) | t _{HD:DAT} | 4.0 V ≤ EVDD0 ≤ 5.5 V, 2.7 V ≤ V _b ≤ 4.0 V, C _b = 50 pF, R _b = 2.7 kΩ | 0 | 770 | ns |
| | | 2.7 V ≤ EVDD0 < 4.0 V, 2.3 V ≤ V _b ≤ 2.7 V, C _b = 50 pF, R _b = 2.7 kΩ | 0 | 770 | ns |
| | | 4.0 V ≤ EVDD0 ≤ 5.5 V, 2.7 V ≤ V _b ≤ 4.0 V, C _b = 100 pF, R _b = 2.8 kΩ | 0 | 1420 | ns |
| | | 2.7 V ≤ EVDD0 < 4.0 V, 2.3 V ≤ V _b ≤ 2.7 V, C _b = 100 pF, R _b = 2.7 kΩ | 0 | 1420 | ns |
| | | 2.4 V ≤ EVDD0 < 3.3 V, 1.6 V ≤ V _b ≤ 2.0 V, C _b = 100 pF, R _b = 5.5 kΩ | 0 | 1215 | ns |

Note 1. The value must also be equal to or less than f_{MCK}/4.

Note 2. Set the f_{MCK} value to keep the hold time of SCLr = "L" and SCLr = "H".

Caution Select the TTL input buffer and the N-ch open drain output (V_{DD} tolerance (for the 30- to 52-pin products)/EV_{DD} tolerance (for the 64- to 100-pin products)) mode for the SDAr pin and the N-ch open drain output (V_{DD} tolerance (for the 30- to 52-pin products)/EV_{DD} tolerance (for the 64- to 100-pin products)) mode for the SCLr pin by using port input mode register g (PIMg) and port output mode register g (POMg). For V_{IH} and V_{IL}, see the DC characteristics with TTL input buffer selected.

(Remarks are listed on the next page.)

Simplified I²C mode connection diagram (during communication at different potential)

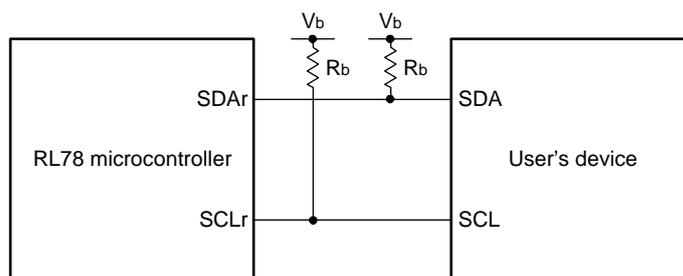

Simplified I²C mode serial transfer timing (during communication at different potential)

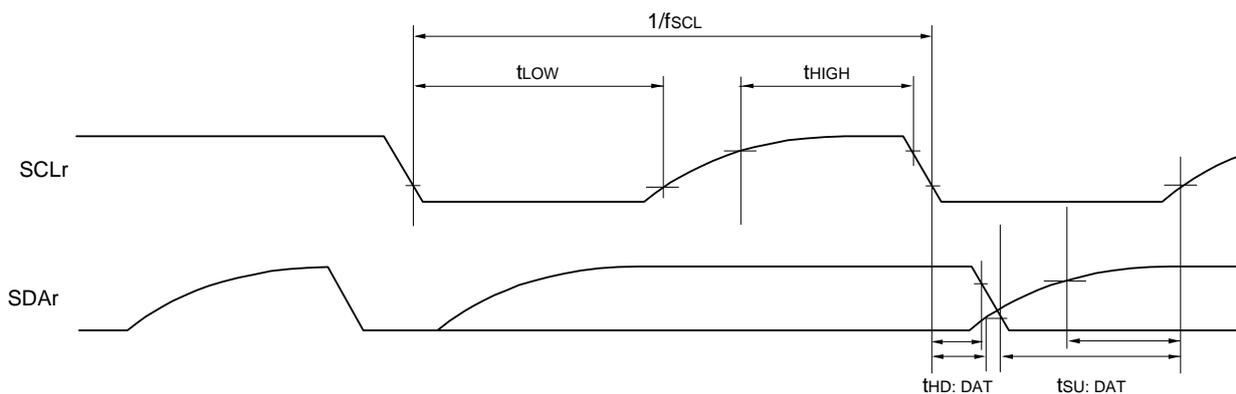

Remark 1. $R_b[\Omega]$: Communication line (SDAr, SCLr) pull-up resistance, $C_b[F]$: Communication line (SDAr, SCLr) load capacitance, $V_b[V]$: Communication line voltage

Remark 2. r: IIC number (r = 00, 01, 10, 11, 20, 30, 31), g: PIM, POM number (g = 0, 1, 3 to 5, 14)

Remark 3. f_{MCK} : Serial array unit operation clock frequency
 (Operation clock to be set by the CKSmn bit of serial mode register mn (SMRmn). m: Unit number (m = 0, 1),
 n: Channel number (n = 0, 2), mn = 00, 01, 02, 10, 12, 13)

3.5.2 Serial interface IICA

(TA = -40 to +105°C, 2.4 V ≤ EVDD0 = EVDD1 ≤ VDD ≤ 5.5 V, VSS = EVSS0 = EVSS1 = 0 V)

| Parameter | Symbol | Conditions | HS (high-speed main) mode | | | | Unit |
|--------------------------------------|----------|-----------------------------|---------------------------|------|-----------|------|------|
| | | | Standard mode | | Fast mode | | |
| | | | MIN. | MAX. | MIN. | MAX. | |
| SCLA0 clock frequency | fSCL | Fast mode: fCLK ≥ 3.5 MHz | — | — | 0 | 400 | kHz |
| | | Standard mode: fCLK ≥ 1 MHz | 0 | 100 | — | — | kHz |
| Setup time of restart condition | tSU: STA | | 4.7 | | 0.6 | | μs |
| Hold time Note 1 | tHD: STA | | 4.0 | | 0.6 | | μs |
| Hold time when SCLA0 = "L" | tLOW | | 4.7 | | 1.3 | | μs |
| Hold time when SCLA0 = "H" | tHIGH | | 4.0 | | 0.6 | | μs |
| Data setup time (reception) | tSU: DAT | | 250 | | 100 | | ns |
| Data hold time (transmission) Note 2 | tHD: DAT | | 0 | 3.45 | 0 | 0.9 | μs |
| Setup time of stop condition | tSU: STO | | 4.0 | | 0.6 | | μs |
| Bus-free time | tBUF | | 4.7 | | 1.3 | | μs |

Note 1. The first clock pulse is generated after this period when the start/restart condition is detected.

Note 2. The maximum value (MAX.) of tHD: DAT is during normal transfer and a wait state is inserted in the ACK (acknowledge) timing.

Caution The values in the above table are applied even when bit 2 (PIOR02) in the peripheral I/O redirection register 0 (PIOR0) is 1. At this time, the pin characteristics (IOH1, IOL1, VOH1, VOL1) must satisfy the values in the redirect destination.

Remark The maximum value of C_b (communication line capacitance) and the value of R_b (communication line pull-up resistor) at that time in each mode are as follows.

Standard mode: C_b = 400 pF, R_b = 2.7 kΩ

Fast mode: C_b = 320 pF, R_b = 1.1 kΩ

IICA serial transfer timing

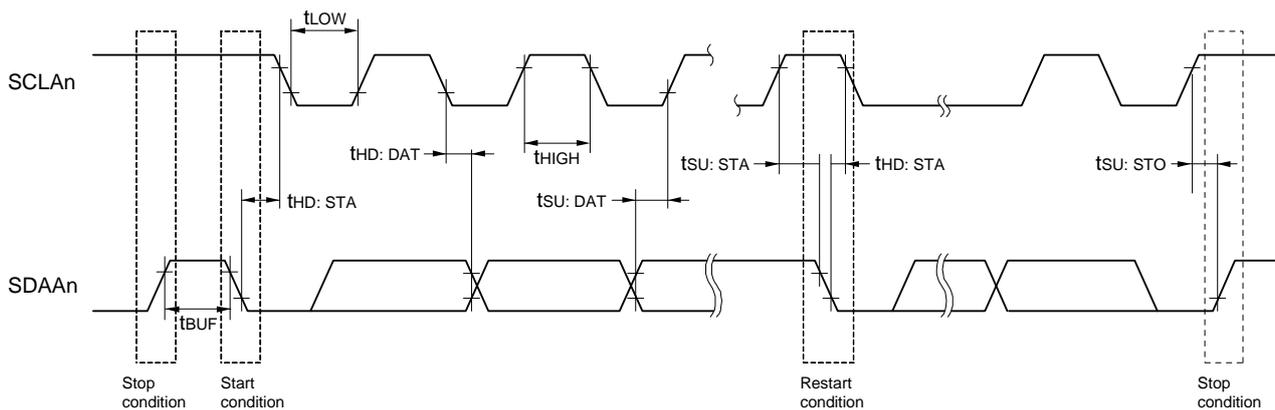

Remark n = 0, 1

3.6 Analog Characteristics

3.6.1 A/D converter characteristics

Classification of A/D converter characteristics

| Input channel | Reference Voltage | Reference voltage (+) = AVREFP Reference voltage (-) = AVREFM | Reference voltage (+) = VDD Reference voltage (-) = VSS | Reference voltage (+) = VBGR Reference voltage (-) = AVREFM |
|---|-------------------|--|--|--|
| ANI0 to ANI14 | | Refer to 3.6.1 (1). | Refer to 3.6.1 (3). | Refer to 3.6.1 (4). |
| ANI16 to ANI20 | | Refer to 3.6.1 (2). | | |
| Internal reference voltage Temperature sensor output voltage | | Refer to 3.6.1 (1). | | |

(1) When reference voltage (+) = AVREFP/ANI0 (ADREFP1 = 0, ADREFP0 = 1), reference voltage (-) = AVREFM/ANI1 (ADREFM = 1), target pin: ANI2 to ANI14, internal reference voltage, and temperature sensor output voltage

(TA = -40 to +105°C, 2.4 V ≤ AVREFP ≤ VDD ≤ 5.5 V, VSS = 0 V, Reference voltage (+) = AVREFP,
Reference voltage (-) = AVREFM = 0 V)

| Parameter | Symbol | Conditions | MIN. | TYP. | MAX. | Unit |
|-------------------------------------|--------|--|------------------------|--------|----------------|------|
| Resolution | RES | | 8 | | 10 | bit |
| Overall error Note 1 | AINL | 10-bit resolution AVREFP = VDD Note 3 | 2.4 V ≤ AVREFP ≤ 5.5 V | 1.2 | ±3.5 | LSB |
| Conversion time | tCONV | 10-bit resolution Target pin: ANI2 to ANI14 | 3.6 V ≤ VDD ≤ 5.5 V | 2.125 | 39 | μs |
| | | | 2.7 V ≤ VDD ≤ 5.5 V | 3.1875 | 39 | μs |
| | | | 2.4 V ≤ VDD ≤ 5.5 V | 17 | 39 | μs |
| | | 10-bit resolution Target pin: Internal reference voltage, and temperature sensor output voltage (HS (high-speed main) mode) | 3.6 V ≤ VDD ≤ 5.5 V | 2.375 | 39 | μs |
| | | | 2.7 V ≤ VDD ≤ 5.5 V | 3.5625 | 39 | μs |
| | | | 2.4 V ≤ VDD ≤ 5.5 V | 17 | 39 | μs |
| Zero-scale error Notes 1, 2 | EzS | 10-bit resolution AVREFP = VDD Note 3 | 2.4 V ≤ AVREFP ≤ 5.5 V | | ±0.25 | %FSR |
| Full-scale error Notes 1, 2 | EFS | 10-bit resolution AVREFP = VDD Note 3 | 2.4 V ≤ AVREFP ≤ 5.5 V | | ±0.25 | %FSR |
| Integral linearity error Note 1 | ILE | 10-bit resolution AVREFP = VDD Note 3 | 2.4 V ≤ AVREFP ≤ 5.5 V | | ±2.5 | LSB |
| Differential linearity error Note 1 | DLE | 10-bit resolution AVREFP = VDD Note 3 | 2.4 V ≤ AVREFP ≤ 5.5 V | | ±1.5 | LSB |
| Analog input voltage | VAIN | ANI2 to ANI14 | | 0 | AVREFP | V |
| | | Internal reference voltage output (2.4 V ≤ VDD ≤ 5.5 V, HS (high-speed main) mode) | | | VBGR Note 4 | V |
| | | Temperature sensor output voltage (2.4 V ≤ VDD ≤ 5.5 V, HS (high-speed main) mode) | | | VTMPS25 Note 4 | V |

Note 1. Excludes quantization error (±1/2 LSB).

Note 2. This value is indicated as a ratio (%FSR) to the full-scale value.

Note 3. When AVREFP < VDD, the MAX. values are as follows.

Overall error: Add ±1.0 LSB to the MAX. value when AVREFP = VDD.

Zero-scale error/Full-scale error: Add ±0.05%FSR to the MAX. value when AVREFP = VDD.

Integral linearity error/ Differential linearity error: Add ±0.5 LSB to the MAX. value when AVREFP = VDD.

Note 4. Refer to 3.6.2 Temperature sensor characteristics/internal reference voltage characteristic.

(2) When reference voltage (+) = $AV_{REFP}/ANI0$ ($ADREFP1 = 0$, $ADREFP0 = 1$), reference voltage (-) = $AV_{REFM}/ANI1$ ($ADREFM = 1$), target pin: ANI16 to ANI20

(TA = -40 to +105°C, $2.4\text{ V} \leq EV_{DD0} = EV_{DD1} \leq V_{DD} \leq 5.5\text{ V}$, $2.4\text{ V} \leq AV_{REFP} \leq V_{DD} \leq 5.5\text{ V}$,

$V_{SS} = EV_{SS0} = EV_{SS1} = 0\text{ V}$, Reference voltage (+) = AV_{REFP} , Reference voltage (-) = $AV_{REFM} = 0\text{ V}$)

| Parameter | Symbol | Conditions | MIN. | TYP. | MAX. | Unit | | |
|-------------------------------------|------------------|--|---|-------|----------------------------------|-------|------|----|
| Resolution | RES | | 8 | | 10 | bit | | |
| Overall error Note 1 | AINL | 10-bit resolution $EV_{DD0} \leq AV_{REFP} = V_{DD}$ Notes 3, 4 | $2.4\text{ V} \leq AV_{REFP} \leq 5.5\text{ V}$ | | 1.2 | ±5.0 | LSB | |
| Conversion time | tCONV | 10-bit resolution Target ANI pin: ANI16 to ANI20 | $3.6\text{ V} \leq V_{DD} \leq 5.5\text{ V}$ | 2.125 | | 39 | μs | |
| | | | $2.7\text{ V} \leq V_{DD} \leq 5.5\text{ V}$ | | 3.1875 | | 39 | μs |
| | | | $2.4\text{ V} \leq V_{DD} \leq 5.5\text{ V}$ | | 17 | | 39 | μs |
| Zero-scale error Notes 1, 2 | E _{ZS} | 10-bit resolution $EV_{DD0} \leq AV_{REFP} = V_{DD}$ Notes 3, 4 | $2.4\text{ V} \leq AV_{REFP} \leq 5.5\text{ V}$ | | | ±0.35 | %FSR | |
| Full-scale error Notes 1, 2 | E _{FS} | 10-bit resolution $EV_{DD0} \leq AV_{REFP} = V_{DD}$ Notes 3, 4 | $2.4\text{ V} \leq AV_{REFP} \leq 5.5\text{ V}$ | | | ±0.35 | %FSR | |
| Integral linearity error Note 1 | ILE | 10-bit resolution $EV_{DD0} \leq AV_{REFP} = V_{DD}$ Notes 3, 4 | $2.4\text{ V} \leq AV_{REFP} \leq 5.5\text{ V}$ | | | ±3.5 | LSB | |
| Differential linearity error Note 1 | DLE | 10-bit resolution $EV_{DD0} \leq AV_{REFP} = V_{DD}$ Notes 3, 4 | $2.4\text{ V} \leq AV_{REFP} \leq 5.5\text{ V}$ | | | ±2.0 | LSB | |
| Analog input voltage | V _{AIN} | ANI16 to ANI20 | 0 | | AV_{REFP} and EV_{DD0} | V | | |

Note 1. Excludes quantization error ($\pm 1/2$ LSB).

Note 2. This value is indicated as a ratio (%FSR) to the full-scale value.

Note 3. When $EV_{DD0} \leq AV_{REFP} \leq V_{DD}$, the MAX. values are as follows.

Overall error: Add ± 1.0 LSB to the MAX. value when $AV_{REFP} = V_{DD}$.
 Zero-scale error/Full-scale error: Add $\pm 0.05\%$ FSR to the MAX. value when $AV_{REFP} = V_{DD}$.
 Integral linearity error/ Differential linearity error: Add ± 0.5 LSB to the MAX. value when $AV_{REFP} = V_{DD}$.

Note 4. When $AV_{REFP} < EV_{DD0} \leq V_{DD}$, the MAX. values are as follows.

Overall error: Add ± 4.0 LSB to the MAX. value when $AV_{REFP} = V_{DD}$.
 Zero-scale error/Full-scale error: Add $\pm 0.20\%$ FSR to the MAX. value when $AV_{REFP} = V_{DD}$.
 Integral linearity error/ Differential linearity error: Add ± 2.0 LSB to the MAX. value when $AV_{REFP} = V_{DD}$.

- (3) When reference voltage (+) = V_{DD} (ADREFP1 = 0, ADREFP0 = 0), reference voltage (-) = V_{SS} (ADREFM = 0), target pin: ANI0 to ANI14, ANI16 to ANI20, internal reference voltage, and temperature sensor output voltage

(TA = -40 to +105°C, 2.4 V ≤ EV_{DD0} = EV_{DD1} ≤ V_{DD} ≤ 5.5 V, V_{SS} = EV_{SS0} = EV_{SS1} = 0 V, Reference voltage (+) = V_{DD}, Reference voltage (-) = V_{SS})

| Parameter | Symbol | Conditions | | MIN. | TYP. | MAX. | Unit |
|--|-------------------|--|---------------------------------|----------------------------|------|-------------------|------|
| Resolution | RES | | | 8 | | 10 | bit |
| Overall error Note 1 | AINL | 10-bit resolution | 2.4 V ≤ V _{DD} ≤ 5.5 V | | 1.2 | ±7.0 | LSB |
| Conversion time | t _{CONV} | 10-bit resolution Target pin: ANI0 to ANI14, ANI16 to ANI20 | 3.6 V ≤ V _{DD} ≤ 5.5 V | 2.125 | | 39 | μs |
| | | | 2.7 V ≤ V _{DD} ≤ 5.5 V | 3.1875 | | 39 | μs |
| | | | 2.4 V ≤ V _{DD} ≤ 5.5 V | 17 | | 39 | μs |
| | | 10-bit resolution Target pin: internal reference voltage, and temperature sensor output voltage (HS (high-speed main) mode) | 3.6 V ≤ V _{DD} ≤ 5.5 V | 2.375 | | 39 | μs |
| | | | 2.7 V ≤ V _{DD} ≤ 5.5 V | 3.5625 | | 39 | μs |
| | | | 2.4 V ≤ V _{DD} ≤ 5.5 V | 17 | | 39 | μs |
| Zero-scale error Notes 1, 2 | E _{ZS} | 10-bit resolution | 2.4 V ≤ V _{DD} ≤ 5.5 V | | | ±0.60 | %FSR |
| Full-scale error Notes 1, 2 | E _{FS} | 10-bit resolution | 2.4 V ≤ V _{DD} ≤ 5.5 V | | | ±0.60 | %FSR |
| Integral linearity error Note 1 | ILE | 10-bit resolution | 2.4 V ≤ V _{DD} ≤ 5.5 V | | | ±4.0 | LSB |
| Differential linearity error Note 1 | DLE | 10-bit resolution | 2.4 V ≤ V _{DD} ≤ 5.5 V | | | ±2.0 | LSB |
| Analog input voltage | V _{AIN} | ANI0 to ANI14 | | 0 | | V _{DD} | V |
| | | ANI16 to ANI20 | | 0 | | EV _{DD0} | V |
| | | Internal reference voltage (2.4 V ≤ V _{DD} ≤ 5.5 V, HS (high-speed main) mode) | | V _{BGR} Note 3 | | | V |
| | | Temperature sensor output voltage (2.4 V ≤ V _{DD} ≤ 5.5 V, HS (high-speed main) mode) | | V _{TMPS25} Note 3 | | | V |

Note 1. Excludes quantization error (±1/2 LSB).

Note 2. This value is indicated as a ratio (% FSR) to the full-scale value.

Note 3. Refer to 3.6.2 Temperature sensor characteristics/internal reference voltage characteristic.

(4) When reference voltage (+) = Internal reference voltage (ADREFP1 = 1, ADREFP0 = 0), reference voltage (-) = AVREFM/ANI1 (ADREFM = 1), target pin: ANI0, ANI2 to ANI14, ANI16 to ANI20

(TA = -40 to +105°C, 2.4 V ≤ VDD ≤ 5.5 V, 1.6 V ≤ EVDD = EVDD1 ≤ VDD, VSS = EVSS0 = EVSS1 = 0 V,

Reference voltage (+) = VBGR Note 3, Reference voltage (-) = AVREFM = 0 V Note 4, HS (high-speed main) mode)

| Parameter | Symbol | Conditions | | MIN. | TYP. | MAX. | Unit |
|-------------------------------------|--------|------------------|---------------------|------|------|-------------|-------|
| Resolution | RES | | | 8 | | | bit |
| Conversion time | tCONV | 8-bit resolution | 2.4 V ≤ VDD ≤ 5.5 V | 17 | | 39 | μs |
| Zero-scale error Notes 1, 2 | Ezs | 8-bit resolution | 2.4 V ≤ VDD ≤ 5.5 V | | | ±0.60 | % FSR |
| Integral linearity error Note 1 | ILE | 8-bit resolution | 2.4 V ≤ VDD ≤ 5.5 V | | | ±2.0 | LSB |
| Differential linearity error Note 1 | DLE | 8-bit resolution | 2.4 V ≤ VDD ≤ 5.5 V | | | ±1.0 | LSB |
| Analog input voltage | VAIN | | | 0 | | VBGR Note 3 | V |

Note 1. Excludes quantization error (±1/2 LSB).

Note 2. This value is indicated as a ratio (% FSR) to the full-scale value.

Note 3. Refer to 3.6.2 Temperature sensor characteristics/internal reference voltage characteristic.

Note 4. When reference voltage (-) = VSS, the MAX. values are as follows.

Zero-scale error: Add ±0.35%FSR to the MAX. value when reference voltage (-) = AVREFM.

Integral linearity error: Add ±0.5 LSB to the MAX. value when reference voltage (-) = AVREFM.

Differential linearity error: Add ±0.2 LSB to the MAX. value when reference voltage (-) = AVREFM.

3.6.2 Temperature sensor characteristics/internal reference voltage characteristic

($T_A = -40$ to $+105^\circ\text{C}$, $2.4\text{ V} \leq V_{DD} \leq 5.5\text{ V}$, $V_{SS} = EV_{SS0} = EV_{SS1} = 0\text{ V}$, HS (high-speed main) mode)

| Parameter | Symbol | Conditions | MIN. | TYP. | MAX. | Unit |
|-----------------------------------|--------------|---|------|------|------|----------------------------|
| Temperature sensor output voltage | V_{TMPS25} | Setting ADS register = 80H, $T_A = +25^\circ\text{C}$ | | 1.05 | | V |
| Internal reference voltage | V_{BGR} | Setting ADS register = 81H | 1.38 | 1.45 | 1.5 | V |
| Temperature coefficient | F_{VTMPS} | Temperature sensor that depends on the temperature | | -3.6 | | $\text{mV}/^\circ\text{C}$ |
| Operation stabilization wait time | t_{AMP} | | 5 | | | μs |

3.6.3 D/A converter characteristics

($T_A = -40$ to $+105^\circ\text{C}$, $2.4\text{ V} \leq EV_{SS0} = EV_{SS1} \leq V_{DD} \leq 5.5\text{ V}$, $V_{SS} = EV_{SS0} = EV_{SS1} = 0\text{ V}$)

| Parameter | Symbol | Conditions | | MIN. | TYP. | MAX. | Unit |
|---------------|-----------|-------------------------------|--|------|------|-----------|---------------|
| Resolution | RES | | | | | 8 | bit |
| Overall error | AINL | $R_{load} = 4\text{ M}\Omega$ | $2.4\text{ V} \leq V_{DD} \leq 5.5\text{ V}$ | | | ± 2.5 | LSB |
| | | $R_{load} = 8\text{ M}\Omega$ | $2.4\text{ V} \leq V_{DD} \leq 5.5\text{ V}$ | | | ± 2.5 | LSB |
| Settling time | t_{SET} | $C_{load} = 20\text{ pF}$ | $2.7\text{ V} \leq V_{DD} \leq 5.5\text{ V}$ | | | 3 | μs |
| | | | $2.4\text{ V} \leq V_{DD} < 2.7\text{ V}$ | | | 6 | μs |

3.6.4 Comparator

(TA = -40 to +105°C, 2.4 V ≤ EVDD0 = EVDD1 ≤ VDD ≤ 5.5 V, VSS = EVSS0 = EVSS1 = 0 V)

| Parameter | Symbol | Conditions | MIN. | TYP. | MAX. | Unit | |
|--|--------|--|--|----------|-------------|------|----|
| Input voltage range | Ivref | | 0 | | EVDD0 - 1.4 | V | |
| | Ivcmp | | -0.3 | | EVDD0 + 0.3 | V | |
| Output delay | td | VDD = 3.0 V Input slew rate > 50 mV/μs | Comparator high-speed mode, standard mode | | | 1.2 | μs |
| | | | Comparator high-speed mode, window mode | | | 2.0 | μs |
| | | | Comparator low-speed mode, standard mode | | 3.0 | 5.0 | μs |
| High-electric-potential reference voltage | VTW+ | Comparator high-speed mode, window mode | | 0.76 VDD | | V | |
| Low-electric-potential reference voltage | VTW- | Comparator high-speed mode, window mode | | 0.24 VDD | | V | |
| Operation stabilization wait time | tcMP | | 100 | | | μs | |
| Internal reference voltage Note | VBGR | 2.4 V ≤ VDD ≤ 5.5 V, HS (high-speed main) mode | 1.38 | 1.45 | 1.50 | V | |

Note Not usable in sub-clock operation or STOP mode.

3.6.5 POR circuit characteristics

(TA = -40 to +105°C, VSS = 0 V)

| Parameter | Symbol | Conditions | MIN. | TYP. | MAX. | Unit |
|-------------------------------|--------|---|------|------|------|------|
| Power on/down reset threshold | VPOR | Voltage threshold on VDD rising | 1.45 | 1.51 | 1.57 | V |
| | VPDR | Voltage threshold on VDD falling Note 1 | 1.44 | 1.50 | 1.56 | V |
| Minimum pulse width Note 2 | TPW | | 300 | | | μs |

Note 1. However, when the operating voltage falls while the LVD is off, enter STOP mode, or enable the reset status using the external reset pin before the voltage falls below the operating voltage range shown in 3.4 AC Characteristics.

Note 2. Minimum time required for a POR reset when VDD exceeds below VPDR. This is also the minimum time required for a POR reset from when VDD exceeds below 0.7 V to when VDD exceeds VPOR while STOP mode is entered or the main system clock is stopped through setting bit 0 (HIOSTOP) and bit 7 (MSTOP) in the clock operation status control register (CSC).

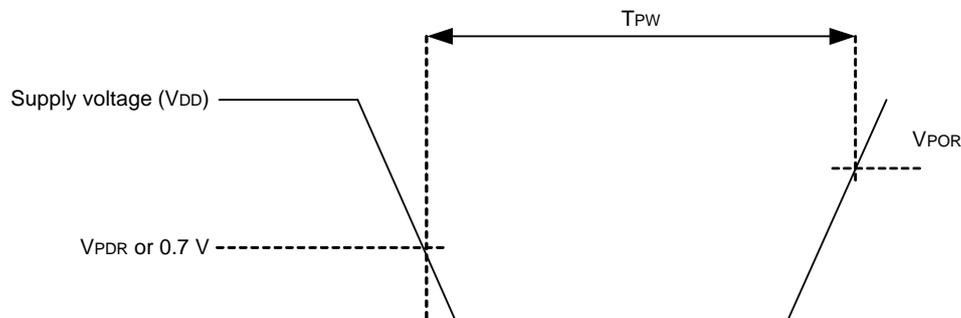

3.6.6 LVD circuit characteristics

(1) Reset Mode and Interrupt Mode

(TA = -40 to +105°C, VPDR ≤ VDD ≤ 5.5 V, VSS = 0 V)

| Parameter | | Symbol | Conditions | MIN. | TYP. | MAX. | Unit | | |
|-----------------------------|----------------------|----------------------|--------------|------|------|------|------|-----|----|
| Voltage detection threshold | Supply voltage level | VLVD0 | Rising edge | 3.90 | 4.06 | 4.22 | V | | |
| | | | Falling edge | 3.83 | 3.98 | 4.13 | V | | |
| | | VLVD1 | Rising edge | 3.60 | 3.75 | 3.90 | V | | |
| | | | Falling edge | 3.53 | 3.67 | 3.81 | V | | |
| | | VLVD2 | Rising edge | 3.01 | 3.13 | 3.25 | V | | |
| | | | Falling edge | 2.94 | 3.06 | 3.18 | V | | |
| | | VLVD3 | Rising edge | 2.90 | 3.02 | 3.14 | V | | |
| | | | Falling edge | 2.85 | 2.96 | 3.07 | V | | |
| | | VLVD4 | Rising edge | 2.81 | 2.92 | 3.03 | V | | |
| | | | Falling edge | 2.75 | 2.86 | 2.97 | V | | |
| | | VLVD5 | Rising edge | 2.70 | 2.81 | 2.92 | V | | |
| | | | Falling edge | 2.64 | 2.75 | 2.86 | V | | |
| | | VLVD6 | Rising edge | 2.61 | 2.71 | 2.81 | V | | |
| | | | Falling edge | 2.55 | 2.65 | 2.75 | V | | |
| | | VLVD7 | Rising edge | 2.51 | 2.61 | 2.71 | V | | |
| | | | Falling edge | 2.45 | 2.55 | 2.65 | V | | |
| | | Minimum pulse width | | tlw | | 300 | | | μs |
| | | Detection delay time | | | | | | 300 | μs |

(2) Interrupt & Reset Mode**(TA = -40 to +105°C, VPDR ≤ VDD ≤ 5.5 V, VSS = 0 V)**

| Parameter | Symbol | Conditions | MIN. | TYP. | MAX. | Unit | |
|-----------------------------|--------|--|------------------------------|------|------|------|---|
| Voltage detection threshold | VLVDD0 | VPOC2, VPOC1, VPOC0 = 0, 1, 1, falling reset voltage | 2.64 | 2.75 | 2.86 | V | |
| | VLVDD1 | LVIS1, LVIS0 = 1, 0 | Rising release reset voltage | 2.81 | 2.92 | 3.03 | V |
| | | | Falling interrupt voltage | 2.75 | 2.86 | 2.97 | V |
| | VLVDD2 | LVIS1, LVIS0 = 0, 1 | Rising release reset voltage | 2.90 | 3.02 | 3.14 | V |
| | | | Falling interrupt voltage | 2.85 | 2.96 | 3.07 | V |
| | VLVDD3 | LVIS1, LVIS0 = 0, 0 | Rising release reset voltage | 3.90 | 4.06 | 4.22 | V |
| | | | Falling interrupt voltage | 3.83 | 3.98 | 4.13 | V |

3.6.7 Power supply voltage rising slope characteristics**(TA = -40 to +105°C, VSS = 0 V)**

| Parameter | Symbol | Conditions | MIN. | TYP. | MAX. | Unit |
|-----------------------------------|--------|------------|------|------|------|------|
| Power supply voltage rising slope | SVDD | | | | 54 | V/ms |

Caution Make sure to keep the internal reset state by the LVD circuit or an external reset until VDD reaches the operating voltage range shown in 3.4 AC Characteristics.

3.7 RAM Data Retention Characteristics

(TA = -40 to +105°C, VSS = 0V)

| Parameter | Symbol | Conditions | MIN. | TYP. | MAX. | Unit |
|-------------------------------|--------|------------|-----------|------|------|------|
| Data retention supply voltage | VDDDR | | 1.44 Note | | 5.5 | V |

Note The value depends on the POR detection voltage. When the voltage drops, the RAM data is retained before a POR reset is effected, but RAM data is not retained when a POR reset is effected.

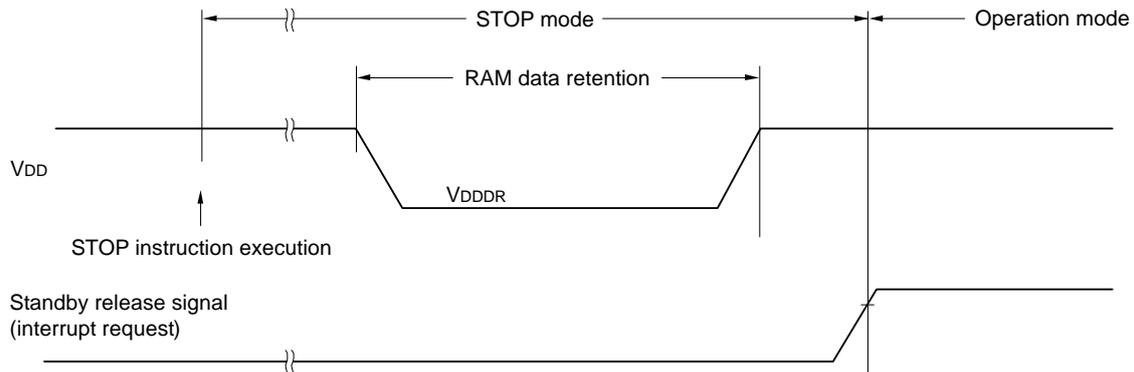

3.8 Flash Memory Programming Characteristics

(TA = -40 to +105°C, 2.4 V ≤ VDD ≤ 5.5 V, VSS = 0 V)

| Parameter | Symbol | Conditions | MIN. | TYP. | MAX. | Unit |
|--|-------------------|---|---------|-----------|------|-------|
| System clock frequency | fCLK | 2.4 V ≤ VDD ≤ 5.5 V | 1 | | 32 | MHz |
| Number of code flash rewrites Notes 1, 2, 3 | C _{erwr} | Retained for 20 years TA = 85°C Note 4 | 1,000 | | | Times |
| Number of data flash rewrites Notes 1, 2, 3 | | Retained for 1 year TA = 25°C | | 1,000,000 | | |
| | | Retained for 5 years TA = 85°C Note 4 | 100,000 | | | |
| | | Retained for 20 years TA = 85°C Note 4 | 10,000 | | | |

- Note 1.** 1 erase + 1 write after the erase is regarded as 1 rewrite. The retaining years are until next rewrite after the rewrite.
- Note 2.** When using flash memory programmer and Renesas Electronics self-programming library
- Note 3.** These are the characteristics of the flash memory and the results obtained from reliability testing by Renesas Electronics Corporation.
- Note 4.** This temperature is the average value at which data are retained.

3.9 Dedicated Flash Memory Programmer Communication (UART)

(TA = -40 to +105°C, 2.4 V ≤ EVDD0 = EVDD1 ≤ VDD ≤ 5.5 V, VSS = EVSS0 = EVSS1 = 0 V)

| Parameter | Symbol | Conditions | MIN. | TYP. | MAX. | Unit |
|---------------|--------|---------------------------|---------|------|-----------|------|
| Transfer rate | | During serial programming | 115,200 | | 1,000,000 | bps |

3.10 Timing of Entry to Flash Memory Programming Modes

(TA = -40 to +105°C, 2.4 V ≤ EVDD0 = EVDD1 ≤ VDD ≤ 5.5 V, VSS = EVSS0 = EVSS1 = 0 V)

| Parameter | Symbol | Conditions | MIN. | TYP. | MAX. | Unit |
|---|---------|--|------|------|------|------|
| How long from when an external reset ends until the initial communication settings are specified | tsuINIT | POR and LVD reset must end before the external reset ends. | | | 100 | ms |
| How long from when the TOOL0 pin is placed at the low level until an external reset ends | tsu | POR and LVD reset must end before the external reset ends. | 10 | | | μs |
| How long the TOOL0 pin must be kept at the low level after an external reset ends (excluding the processing time of the firmware to control the flash memory) | tHD | POR and LVD reset must end before the external reset ends. | 1 | | | ms |

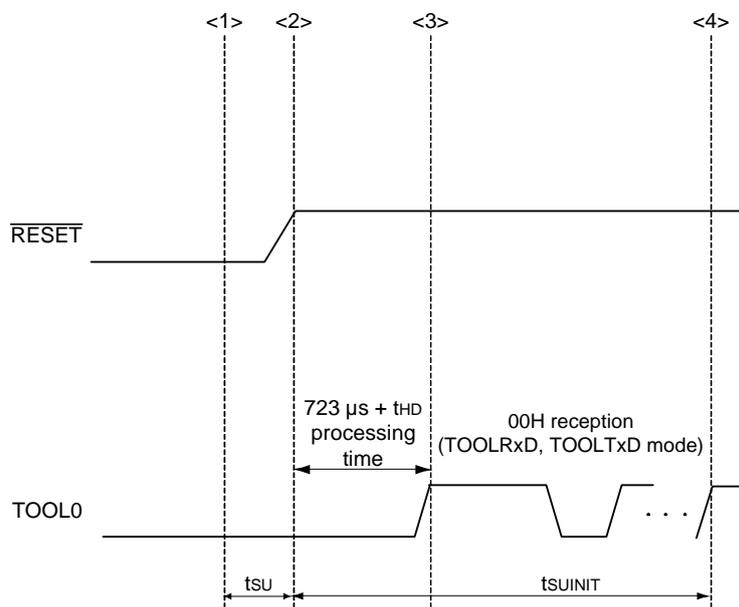

- <1> The low level is input to the TOOL0 pin.
- <2> The external reset ends (POR and LVD reset must end before the external reset ends).
- <3> The TOOL0 pin is set to the high level.
- <4> Setting of the flash memory programming mode by UART reception and complete the baud rate setting.

Remark tsuINIT: The segment shows that it is necessary to finish specifying the initial communication settings within 100 ms from when the external resets end.

tsu: How long from when the TOOL0 pin is placed at the low level until a pin reset ends

tHD: How long to keep the TOOL0 pin at the low level from when the external resets end (excluding the processing time of the firmware to control the flash memory)

4. PACKAGE DRAWINGS

<R> 4.1 30-pin Package

| | | | |
|---------------------|--------------|----------------|-----------------|
| JEITA Package Code | RENESAS Code | Previous Code | MASS (TYP.) [g] |
| P-LSSOP30-0300-0.65 | PLSP0030JB-B | S30MC-65-5A4-3 | 0.18 |

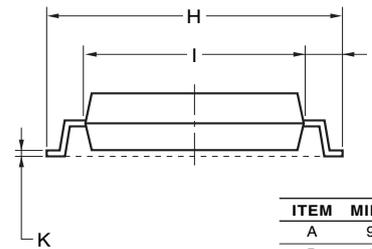
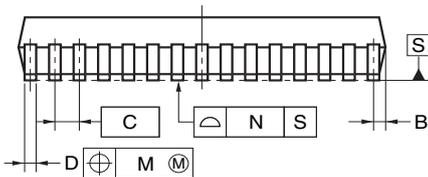
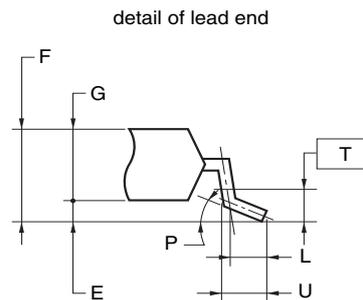
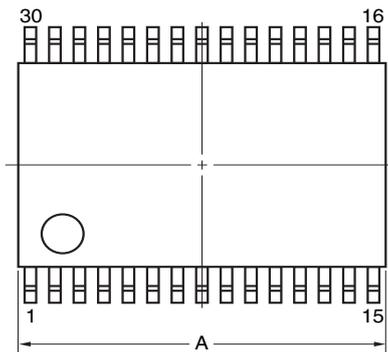

NOTE
Each lead centerline is located within 0.13 mm of its true position (T.P.) at maximum material condition.

| ITEM | MILLIMETERS |
|------|--|
| A | 9.85±0.15 |
| B | 0.45 MAX. |
| C | 0.65 (T.P.) |
| D | 0.24 ^{+0.08} _{-0.07} |
| E | 0.1±0.05 |
| F | 1.3±0.1 |
| G | 1.2 |
| H | 8.1±0.2 |
| I | 6.1±0.2 |
| J | 1.0±0.2 |
| K | 0.17±0.03 |
| L | 0.5 |
| M | 0.13 |
| N | 0.10 |
| P | 3° ^{+5°} _{-3°} |
| T | 0.25 |
| U | 0.6±0.15 |

©2012 Renesas Electronics Corporation. All rights reserved.

<R> 4.2 32-pin Package

| | | | |
|--------------------|--------------|----------------|-----------------|
| JEITA Package Code | RENESAS Code | Previous Code | MASS (TYP.) [g] |
| P-HWQFN32-5x5-0.50 | PWQN0032KB-A | P32K8-50-3B4-4 | 0.06 |

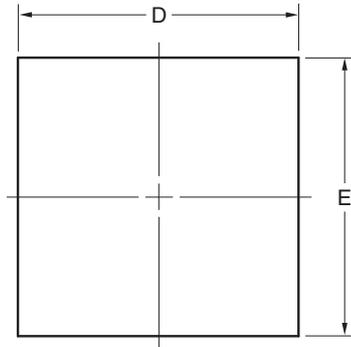

DETAIL OF (A) PART

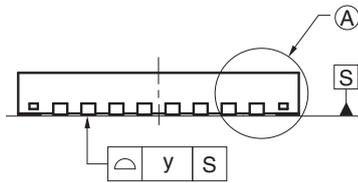
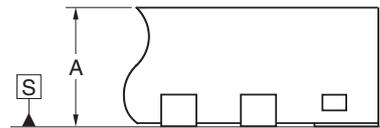

| Reference Symbol | Dimension in Millimeters | | |
|------------------|--------------------------|------|------|
| | Min | Nom | Max |
| D | 4.95 | 5.00 | 5.05 |
| E | 4.95 | 5.00 | 5.05 |
| A | 0.70 | 0.75 | 0.80 |
| b | 0.18 | 0.25 | 0.30 |
| e | — | 0.50 | — |
| Lp | 0.30 | 0.40 | 0.50 |
| x | — | — | 0.05 |
| y | — | — | 0.05 |

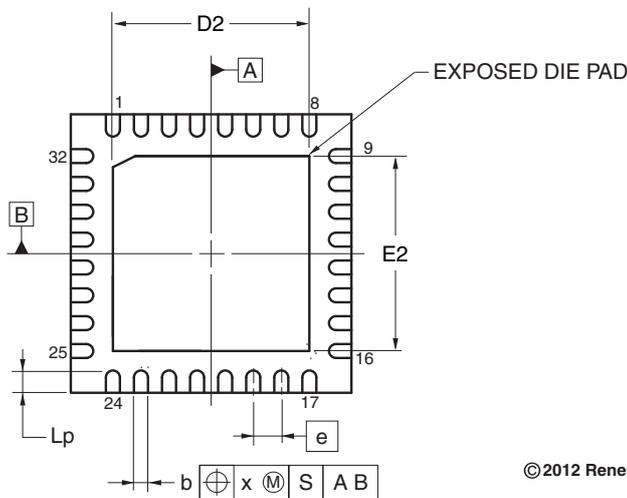

| ITEM | A | D2 | | | E2 | | |
|----------------------------|---|------|------|------|------|------|------|
| | | MIN | NOM | MAX | MIN | NOM | MAX |
| EXPOSED DIE PAD VARIATIONS | | 3.45 | 3.50 | 3.55 | 3.45 | 3.50 | 3.55 |

© 2012 Renesas Electronics Corporation. All rights reserved.

<R>

| | | |
|---------------------|--------------|---------------|
| JEITA Package code | RENESAS code | MASS(TYP.)[g] |
| P-HWQFN032-5x5-0.50 | PWQN0032KE-A | 0.06 |

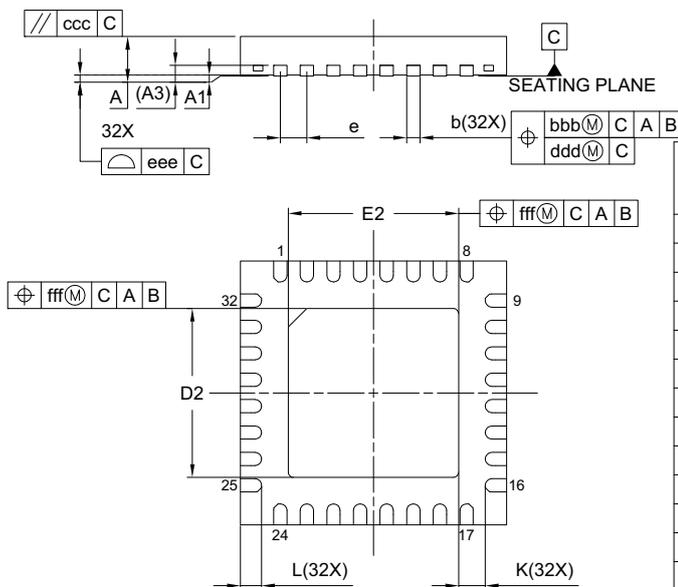
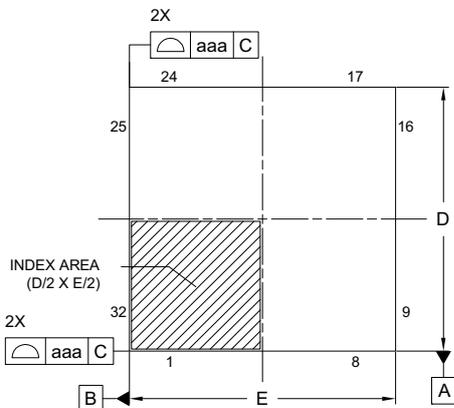

| Reference Symbol | Dimension in Millimeters | | |
|------------------|--------------------------|------|------|
| | Min. | Nom. | Max. |
| A | — | — | 0.80 |
| A ₁ | 0.00 | 0.02 | 0.05 |
| A ₂ | 0.203 REF. | | |
| b | 0.18 | 0.25 | 0.30 |
| D | 5.00 BSC | | |
| E | 5.00 BSC | | |
| e | 0.50 BSC | | |
| L | 0.35 | 0.40 | 0.45 |
| K | 0.20 | — | — |
| D ₂ | 3.15 | 3.20 | 3.25 |
| E ₂ | 3.15 | 3.20 | 3.25 |
| aaa | 0.15 | | |
| bbb | 0.10 | | |
| ccc | 0.10 | | |
| ddd | 0.05 | | |
| eee | 0.08 | | |
| fff | 0.10 | | |

<R>

| | | | |
|--------------------|--------------|----------------|-----------------|
| JEITA Package Code | RENESAS Code | Previous Code | MASS (TYP.) [g] |
| P-LQFP32-7x7-0.80 | PLQP0032GB-A | P32GA-80-GBT-1 | 0.2 |

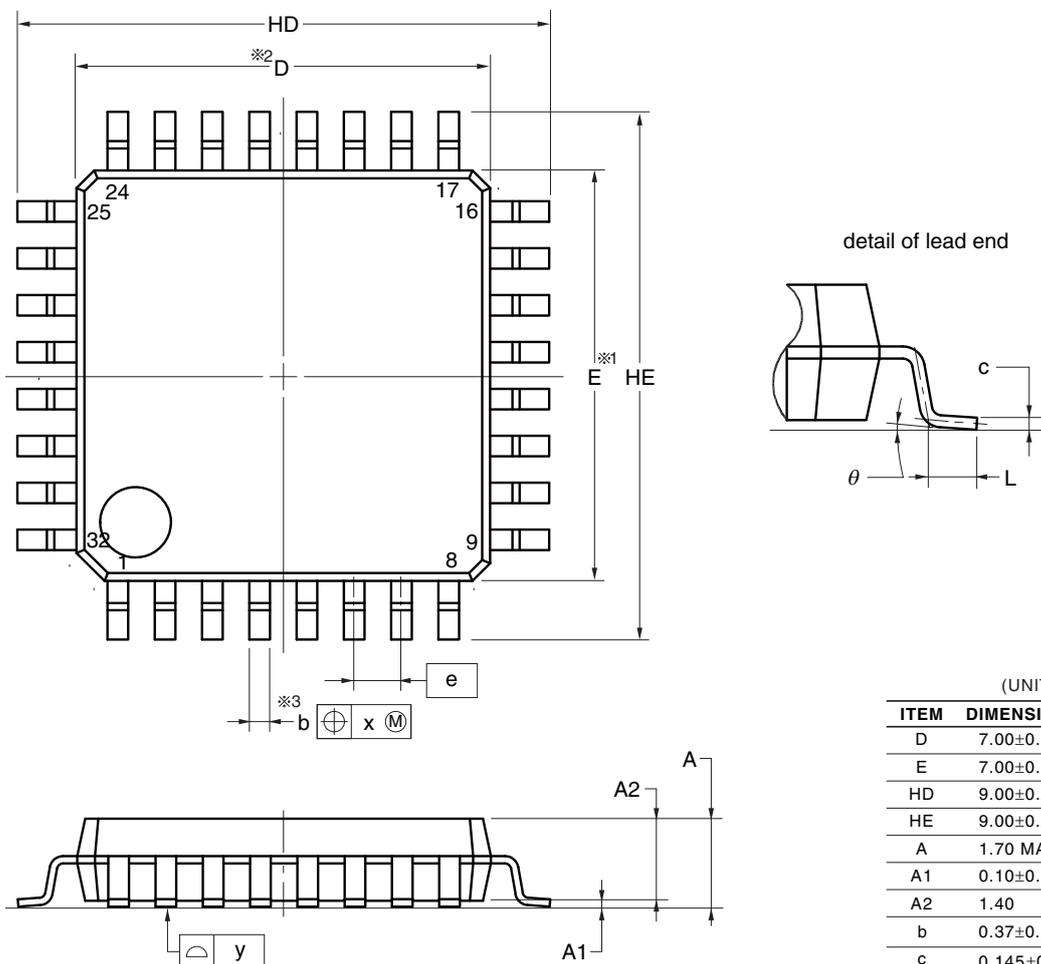

(UNIT:mm)

| ITEM | DIMENSIONS |
|----------|-------------|
| D | 7.00±0.10 |
| E | 7.00±0.10 |
| HD | 9.00±0.20 |
| HE | 9.00±0.20 |
| A | 1.70 MAX. |
| A1 | 0.10±0.10 |
| A2 | 1.40 |
| b | 0.37±0.05 |
| c | 0.145±0.055 |
| L | 0.50±0.20 |
| θ | 0° to 8° |
| e | 0.80 |
| x | 0.20 |
| y | 0.10 |

NOTE

1. Dimensions “ $\times 1$ ” and “ $\times 2$ ” do not include mold flash.
2. Dimension “ $\times 3$ ” does not include trim offset.

© 2012 Renesas Electronics Corporation. All rights reserved.

<R> 4.3 36-pin Package

| | | | |
|--------------------|--------------|----------------|-----------------|
| JEITA Package Code | RENESAS Code | Previous Code | MASS (TYP.) [g] |
| P-WFLGA36-4x4-0.50 | PWLG0036KA-A | P36FC-50-AA4-2 | 0.023 |

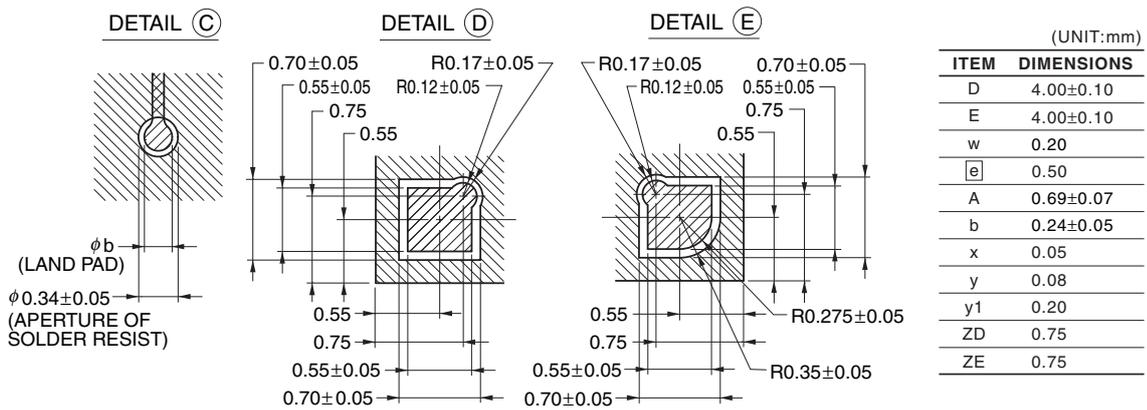
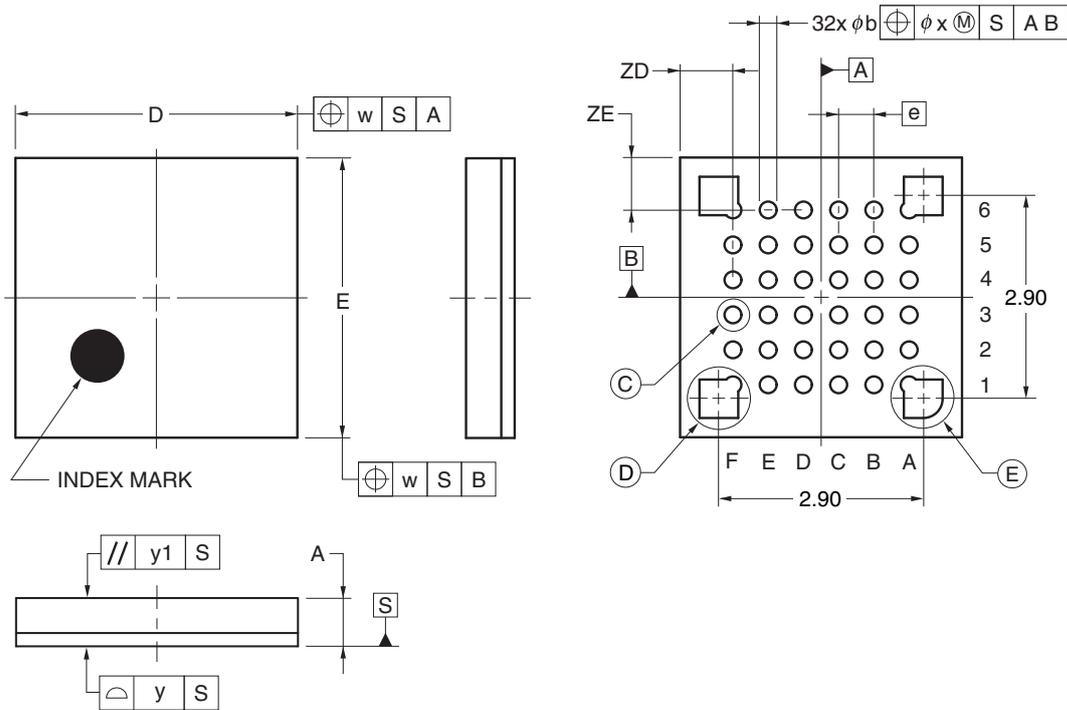

©2012 Renesas Electronics Corporation. All rights reserved.

<R> 4.4 40-pin Package

| | | | |
|--------------------|--------------|----------------|-----------------|
| JEITA Package Code | RENESAS Code | Previous Code | MASS (TYP.) [g] |
| P-HWQFN40-6x6-0.50 | PWQN0040KC-A | P40K8-50-4B4-4 | 0.09 |

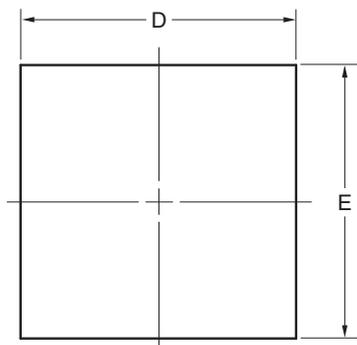

DETAIL OF (A) PART

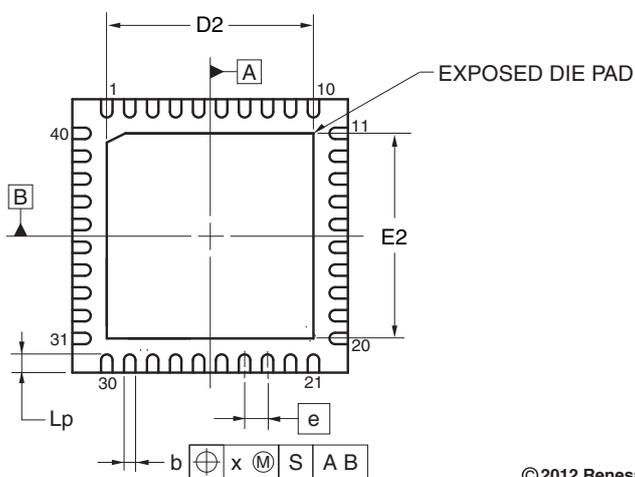
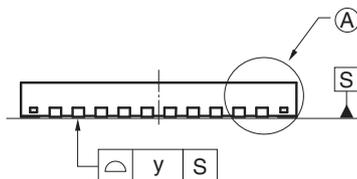
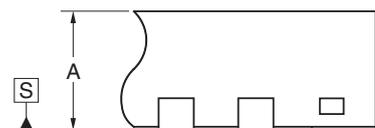

| Reference Symbol | Dimension in Millimeters | | |
|------------------|--------------------------|------|------|
| | Min | Nom | Max |
| D | 5.95 | 6.00 | 6.05 |
| E | 5.95 | 6.00 | 6.05 |
| A | 0.70 | 0.75 | 0.80 |
| b | 0.18 | 0.25 | 0.30 |
| e | — | 0.50 | — |
| Lp | 0.30 | 0.40 | 0.50 |
| x | — | — | 0.05 |
| y | — | — | 0.05 |

| ITEM | A | D2 | | | E2 | | |
|----------------------------|---|------|------|------|------|------|------|
| | | MIN | NOM | MAX | MIN | NOM | MAX |
| EXPOSED DIE PAD VARIATIONS | | 4.45 | 4.50 | 4.55 | 4.45 | 4.50 | 4.55 |

©2012 Renesas Electronics Corporation. All rights reserved.

<R> 4.5 44-pin Package

| | | | |
|---------------------|--------------|----------------|-----------------|
| JEITA Package Code | RENESAS Code | Previous Code | MASS (TYP.) [g] |
| P-LQFP44-10x10-0.80 | PLQP0044GC-A | P44GB-80-UES-2 | 0.36 |

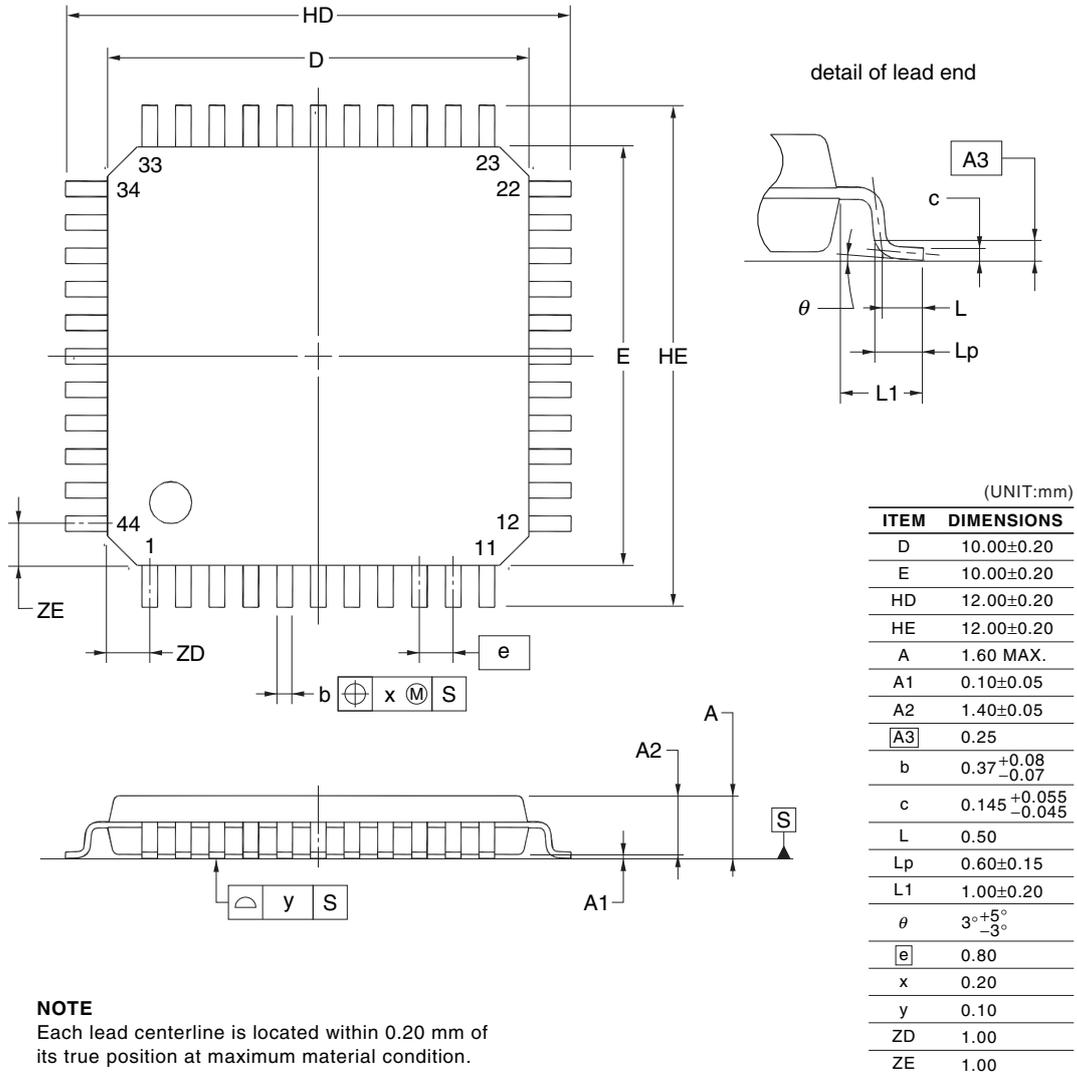

NOTE
Each lead centerline is located within 0.20 mm of its true position at maximum material condition.

©2012 Renesas Electronics Corporation. All rights reserved.

<R>

| | | | |
|---------------------|--------------|---------------|------------|
| JEITA Package Code | RENESAS Code | Previous Code | MASS[Typ.] |
| P-LQFP44-10x10-0.80 | PLQP0044GC-D | — | 0.36g |

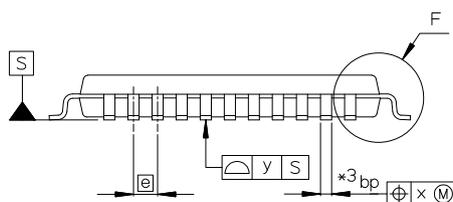
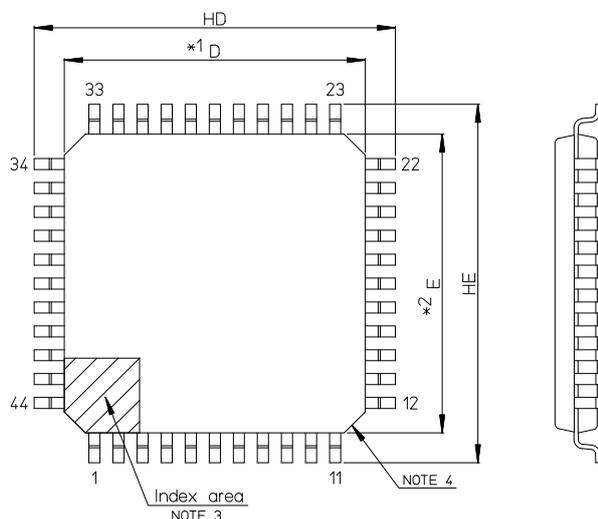

- NOTE)
1. DIMENSIONS *1" AND *2" DO NOT INCLUDE MOLD FLASH.
 2. DIMENSION *3" DOES NOT INCLUDE TRIM OFFSET.
 3. PIN 1 VISUAL INDEX FEATURE MAY VARY, BUT MUST BE LOCATED WITHIN THE HATCHED AREA.
 4. CHAMFERS AT CORNERS ARE OPTIONAL; SIZE MAY VARY.

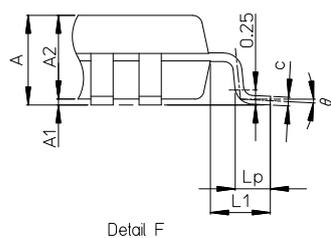

| Reference Symbol | Dimension in Millimeters | | |
|------------------|--------------------------|------|------|
| | Min | Nom | Max |
| D | 9.8 | 10.0 | 10.2 |
| E | 9.8 | 10.0 | 10.2 |
| A2 | — | 1.4 | — |
| HD | 11.8 | 12.0 | 12.2 |
| HE | 11.8 | 12.0 | 12.2 |
| A | — | — | 1.6 |
| A1 | 0.05 | — | 0.15 |
| bp | 0.22 | 0.37 | 0.45 |
| c | 0.09 | — | 0.20 |
| θ | 0° | 3.5° | 8° |
| e | — | 0.80 | — |
| x | — | — | 0.20 |
| y | — | — | 0.10 |
| Lp | 0.45 | 0.6 | 0.75 |
| L1 | — | 1.0 | — |

<R> 4.6 48-pin Package

| | | | |
|--------------------|--------------|----------------|-----------------|
| JEITA Package Code | RENESAS Code | Previous Code | MASS (TYP.) [g] |
| P-LFQFP48-7x7-0.50 | PLQP0048KF-A | P48GA-50-8EU-1 | 0.16 |

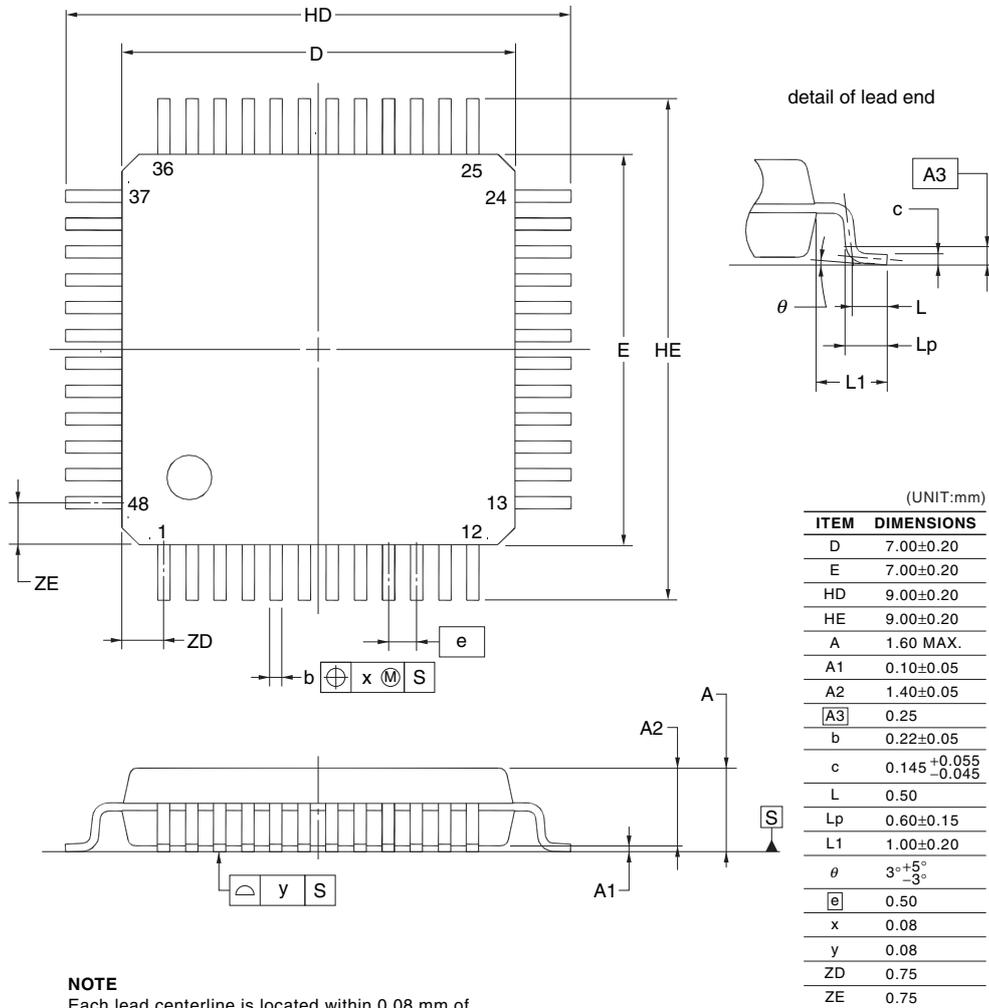

NOTE
Each lead centerline is located within 0.08 mm of its true position at maximum material condition.

©2012 Renesas Electronics Corporation. All rights reserved.

<R>

| JEITA Package Code | RENESAS Code | Previous Code | MASS (Typ) [g] |
|--------------------|--------------|---------------|----------------|
| P-LFQFP48-7x7-0.50 | PLQP0048KB-B | — | 0.2 |

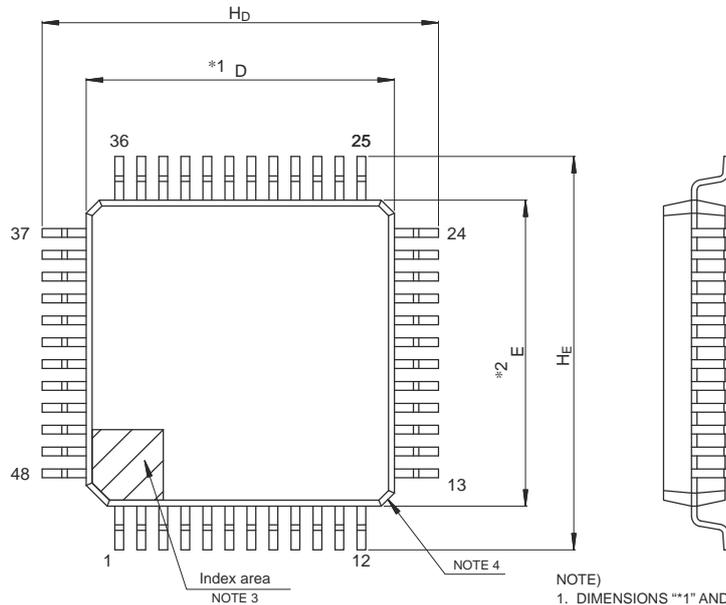

Unit: mm

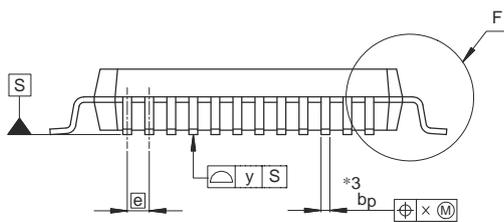

- NOTE)
1. DIMENSIONS "*"1" AND "*"2" DO NOT INCLUDE MOLD FLASH.
 2. DIMENSION "*"3" DOES NOT INCLUDE TRIM OFFSET.
 3. PIN 1 VISUAL INDEX FEATURE MAY VARY, BUT MUST BE LOCATED WITHIN THE HATCHED AREA.
 4. CHAMFERS AT CORNERS ARE OPTIONAL, SIZE MAY VARY.

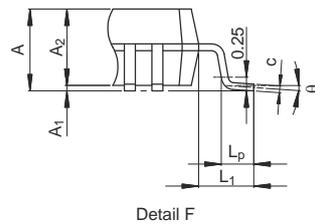

Detail F

| Reference Symbol | Dimensions in millimeters | | |
|------------------|---------------------------|------|------|
| | Min | Nom | Max |
| D | 6.9 | 7.0 | 7.1 |
| E | 6.9 | 7.0 | 7.1 |
| A ₂ | — | 1.4 | — |
| H _D | 8.8 | 9.0 | 9.2 |
| H _E | 8.8 | 9.0 | 9.2 |
| A | — | — | 1.7 |
| A ₁ | 0.05 | — | 0.15 |
| b _p | 0.17 | 0.20 | 0.27 |
| c | 0.09 | — | 0.20 |
| θ | 0° | 3.5° | 8° |
| e | — | 0.5 | — |
| x | — | — | 0.08 |
| y | — | — | 0.08 |
| L _p | 0.45 | 0.6 | 0.75 |
| L ₁ | — | 1.0 | — |

© 2015 Renesas Electronics Corporation. All rights reserved.

<R>

| | | | |
|--------------------|--------------|---------------------------|-----------------|
| JEITA Package Code | RENESAS Code | Previous Code | MASS (TYP.) [g] |
| P-HWQFN48-7x7-0.50 | PWQN0048KB-A | 48PJN-A P48K8-50-5B4-5 | 0.13 |

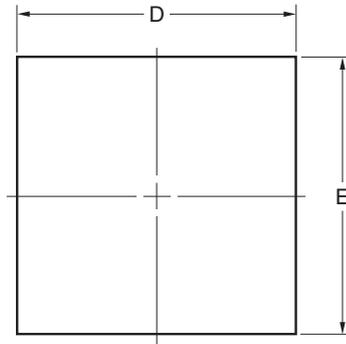

DETAIL OF (A) PART

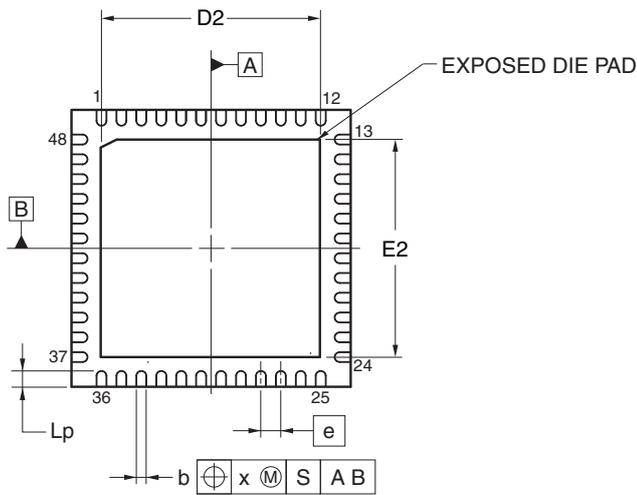
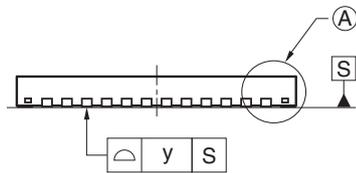
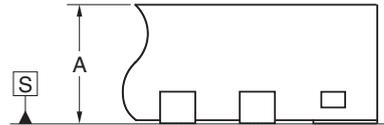

| Reference Symbol | Dimension in Millimeters | | |
|------------------|--------------------------|------|------|
| | Min | Nom | Max |
| D | 6.95 | 7.00 | 7.05 |
| E | 6.95 | 7.00 | 7.05 |
| A | 0.70 | 0.75 | 0.80 |
| b | 0.18 | 0.25 | 0.30 |
| e | — | 0.50 | — |
| Lp | 0.30 | 0.40 | 0.50 |
| x | — | — | 0.05 |
| y | — | — | 0.05 |

| ITEM | A | D2 | | | E2 | | |
|----------------------------|---|------|------|------|------|------|------|
| | | MIN | NOM | MAX | MIN | NOM | MAX |
| EXPOSED DIE PAD VARIATIONS | | 5.45 | 5.50 | 5.55 | 5.45 | 5.50 | 5.55 |

©2012 Renesas Electronics Corporation. All rights reserved.

<R> 4.7 52-pin Package

| | | | |
|---------------------|--------------|----------------|-----------------|
| JEITA Package Code | RENESAS Code | Previous Code | MASS (TYP.) [g] |
| P-LQFP52-10x10-0.65 | PLQP0052JA-A | P52GB-65-GBS-1 | 0.3 |

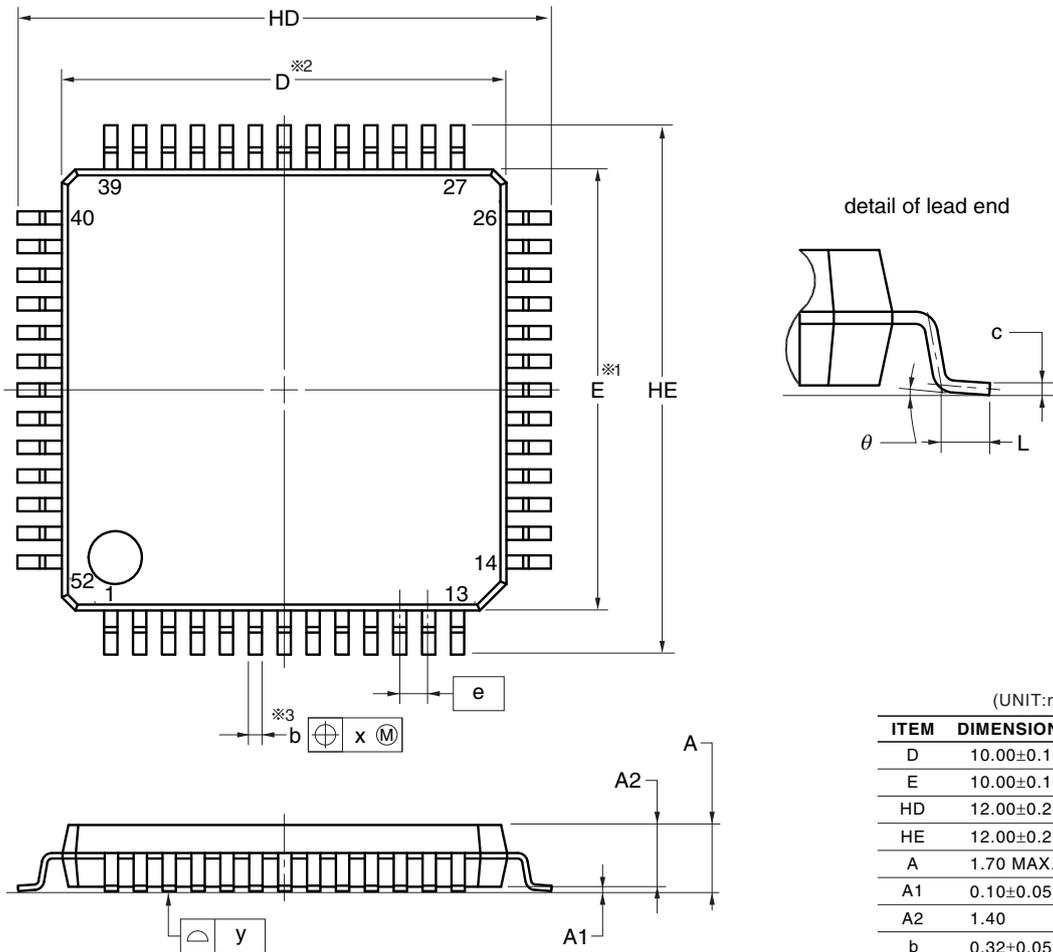

(UNIT:mm)

| ITEM | DIMENSIONS |
|------|-------------|
| D | 10.00±0.10 |
| E | 10.00±0.10 |
| HD | 12.00±0.20 |
| HE | 12.00±0.20 |
| A | 1.70 MAX. |
| A1 | 0.10±0.05 |
| A2 | 1.40 |
| b | 0.32±0.05 |
| c | 0.145±0.055 |
| L | 0.50±0.15 |
| θ | 0° to 8° |
| e | 0.65 |
| x | 0.13 |
| y | 0.10 |

- NOTE**
1. Dimensions “*1” and “*2” do not include mold flash.
 2. Dimension “*3” does not include trim offset.

© 2012 Renesas Electronics Corporation. All rights reserved.

<R> 4.8 64-pin Package

| | | | |
|---------------------|--------------|----------------|-----------------|
| JEITA Package Code | RENESAS Code | Previous Code | MASS (TYP.) [g] |
| P-LQFP64-12x12-0.65 | PLQP0064JA-A | P64GK-65-UET-2 | 0.51 |

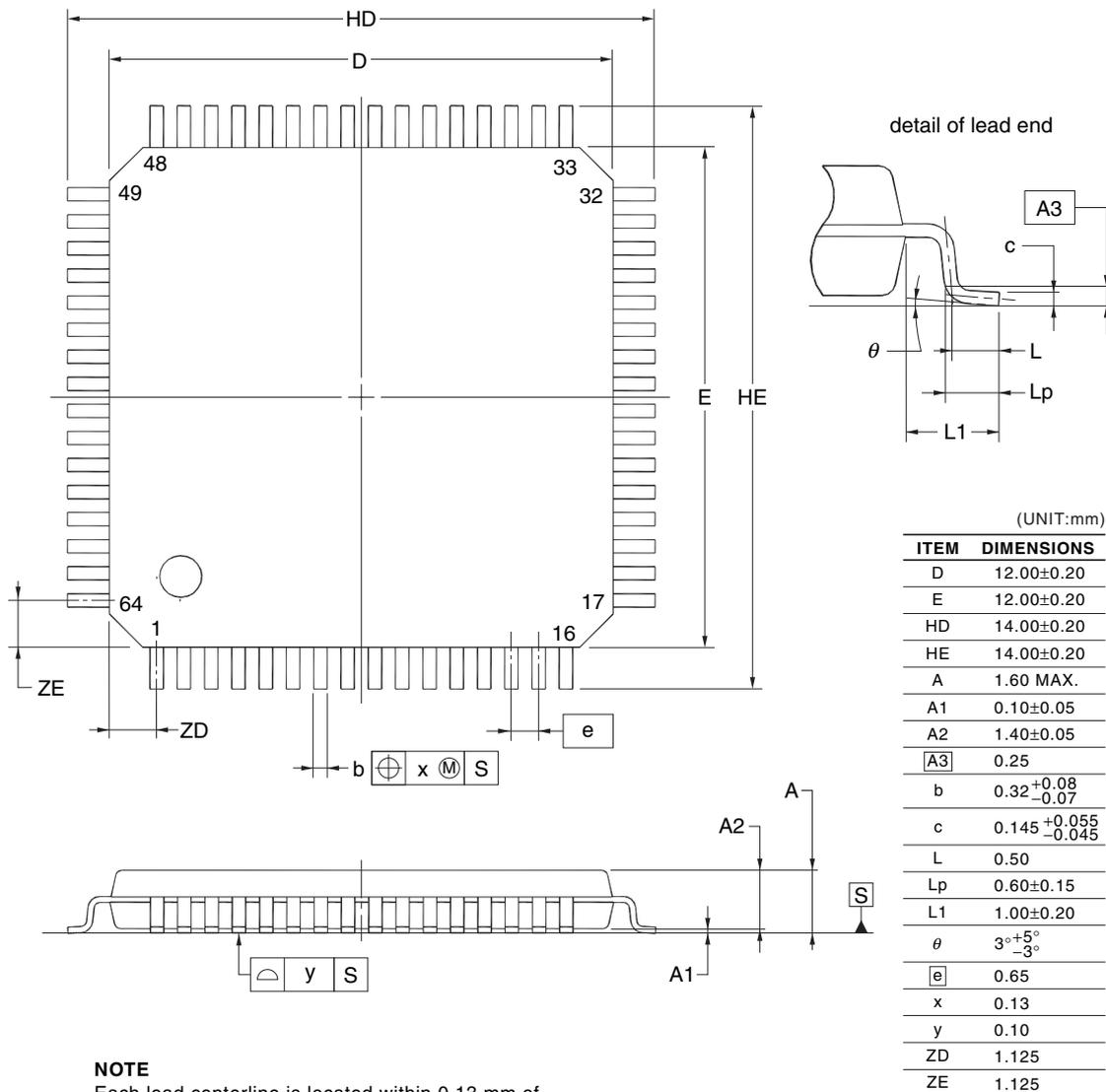

NOTE
Each lead centerline is located within 0.13 mm of its true position at maximum material condition.

©2012 Renesas Electronics Corporation. All rights reserved.

<R>

| JEITA Package Code | RENESAS Code | Previous Code | MASS (Typ) [g] |
|----------------------|--------------|---------------|----------------|
| P-LFQFP64-10x10-0.50 | PLQP0064KB-C | — | 0.3 |

Unit: mm

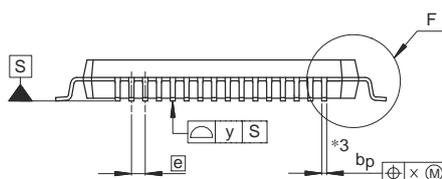
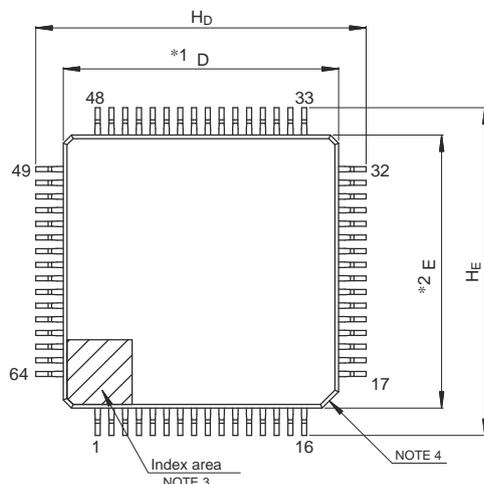

- NOTE)
1. DIMENSIONS $*1$ AND $*2$ DO NOT INCLUDE MOLD FLASH.
 2. DIMENSION $*3$ DOES NOT INCLUDE TRIM OFFSET.
 3. PIN 1 VISUAL INDEX FEATURE MAY VARY, BUT MUST BE LOCATED WITHIN THE HATCHED AREA.
 4. CHAMFERS AT CORNERS ARE OPTIONAL, SIZE MAY VARY.

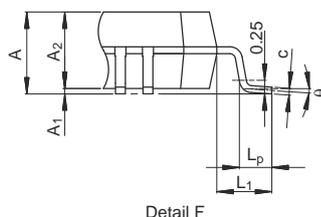

Detail F

| Reference Symbol | Dimensions in millimeters | | |
|------------------|---------------------------|------|------|
| | Min | Nom | Max |
| D | 9.9 | 10.0 | 10.1 |
| E | 9.9 | 10.0 | 10.1 |
| A_2 | — | 1.4 | — |
| H_D | 11.8 | 12.0 | 12.2 |
| H_E | 11.8 | 12.0 | 12.2 |
| A | — | — | 1.7 |
| A_1 | 0.05 | — | 0.15 |
| b_p | 0.15 | 0.20 | 0.27 |
| c | 0.09 | — | 0.20 |
| θ | 0° | 3.5° | 8° |
| e | — | 0.5 | — |
| x | — | — | 0.08 |
| y | — | — | 0.08 |
| L_p | 0.45 | 0.6 | 0.75 |
| L_1 | — | 1.0 | — |

© 2015 Renesas Electronics Corporation. All rights reserved.

<R>

| | | | |
|----------------------|--------------|----------------|-----------------|
| JEITA Package Code | RENESAS Code | Previous Code | MASS (TYP.) [g] |
| P-LFQFP64-10x10-0.50 | PLQP0064KF-A | P64GB-50-UEU-2 | 0.35 |

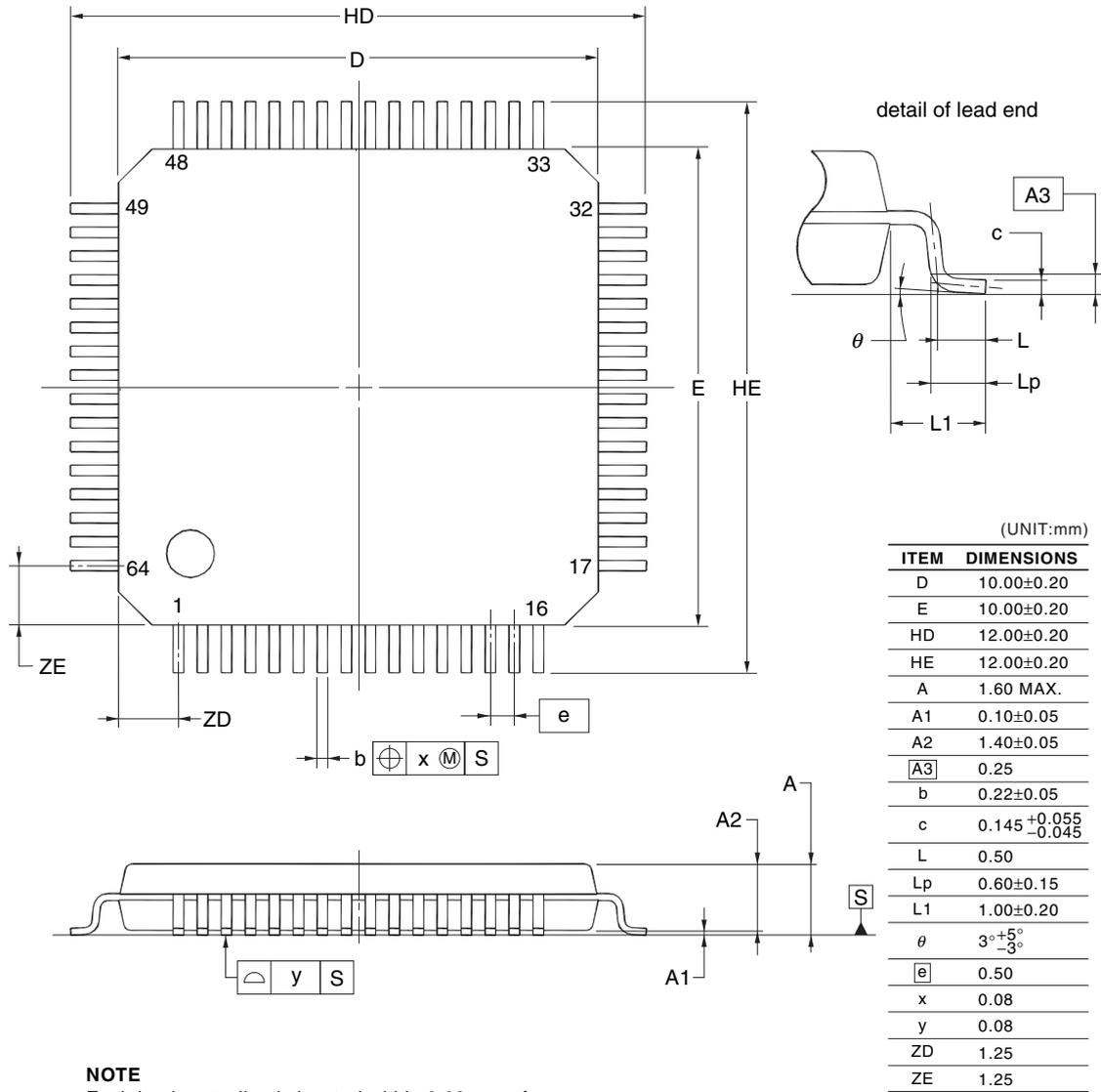

NOTE
Each lead centerline is located within 0.08 mm of its true position at maximum material condition.

©2012 Renesas Electronics Corporation. All rights reserved.

<R>

| | | | |
|--------------------|--------------|---------------|-----------------|
| JEITA Package Code | RENESAS Code | Previous Code | MASS (TYP.) [g] |
| P-WFLGA64-5x5-0.50 | PWLG0064KA-A | P64FC-50-AN5 | 0.037 |

64-PIN PLASTIC FLGA (5x5)

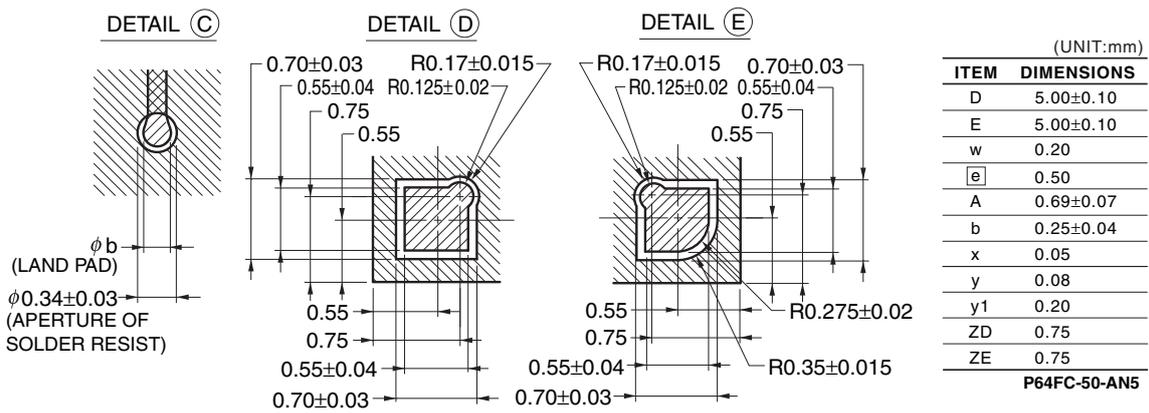
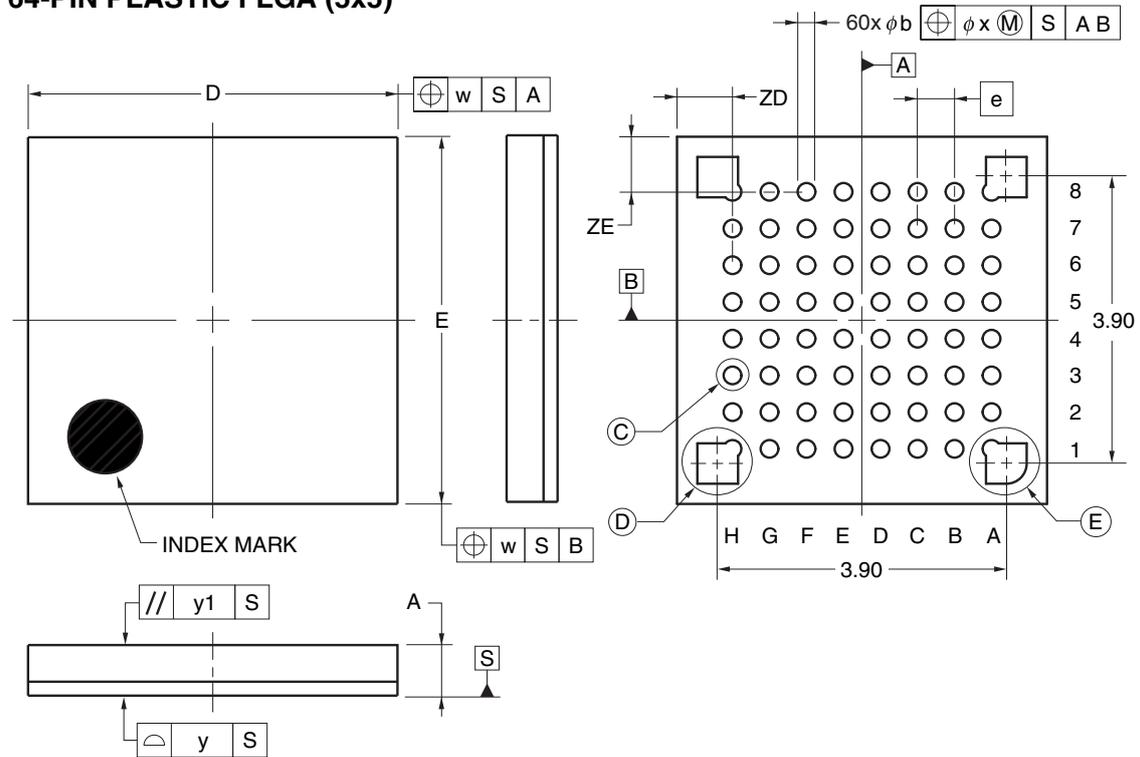

© 2011 Renesas Electronics Corporation. All rights reserved.

<R>

| | | | |
|---------------------|--------------|----------------|----------------|
| JEITA Package Code | RENESAS Code | Previous Code | MASS (TYP) [g] |
| P-LQFP64-14x14-0.80 | PLQP0064GA-A | P64GC-80-GBW-1 | 0.7 |

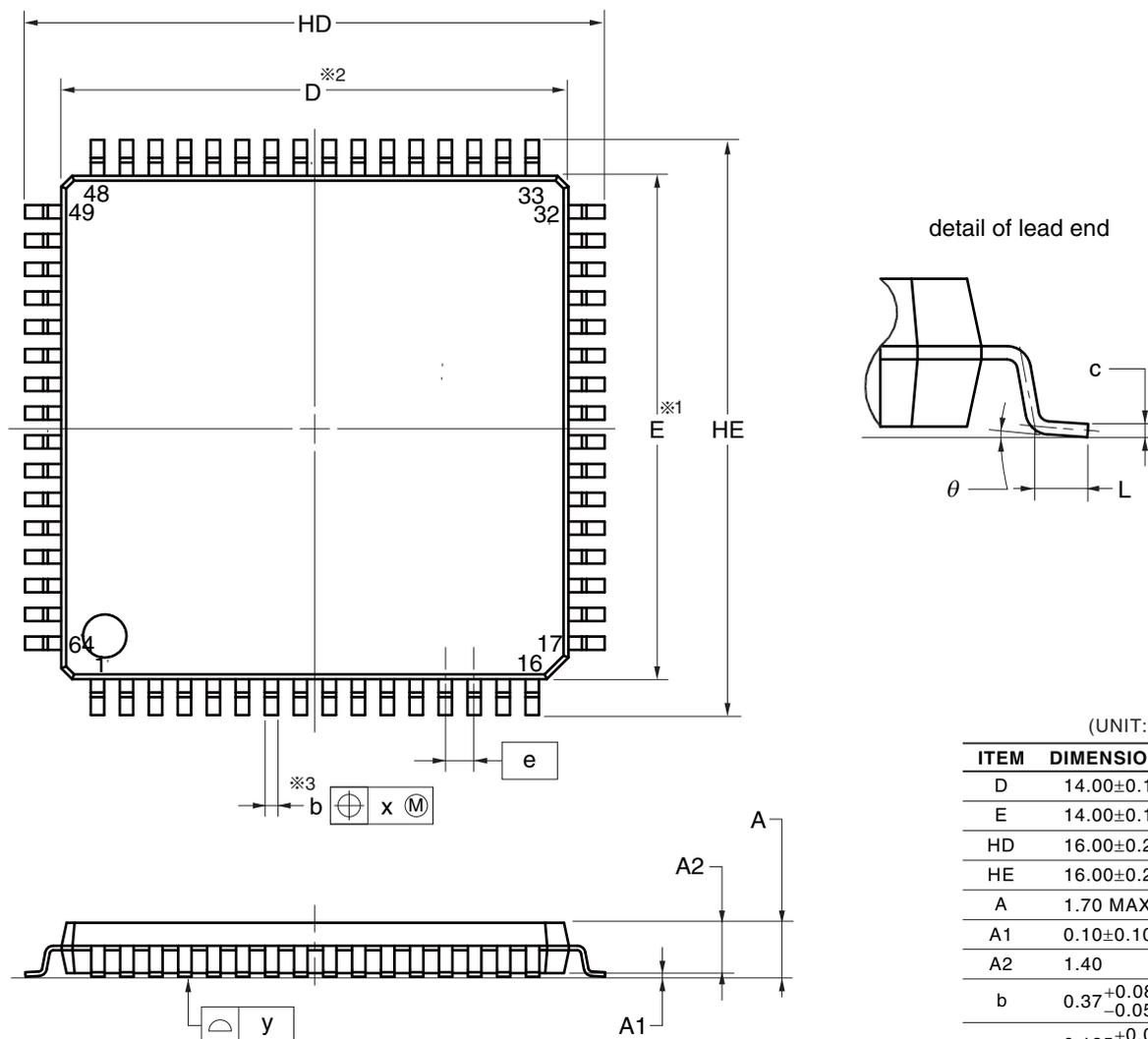

(UNIT:mm)

| ITEM | DIMENSIONS |
|----------|---|
| D | 14.00±0.10 |
| E | 14.00±0.10 |
| HD | 16.00±0.20 |
| HE | 16.00±0.20 |
| A | 1.70 MAX. |
| A1 | 0.10±0.10 |
| A2 | 1.40 |
| b | 0.37 ^{+0.08} _{-0.05} |
| c | 0.125 ^{+0.05} _{-0.02} |
| L | 0.50±0.20 |
| θ | 0° to 8° |
| e | 0.80 |
| x | 0.20 |
| y | 0.10 |

NOTE

1. Dimensions “ $\times 1$ ” and “ $\times 2$ ” do not include mold flash.
2. Dimension “ $\times 3$ ” does not include trim offset.

© 2012 Renesas Electronics Corporation. All rights reserved.

<R> 4.9 80-pin Package

| | | | |
|----------------------|--------------|----------------|-----------------|
| JEITA Package Code | RENESAS Code | Previous Code | MASS (TYP.) [g] |
| P-LFQFP80-12x12-0.50 | PLQP0080KE-A | P80GK-50-8EU-2 | 0.53 |

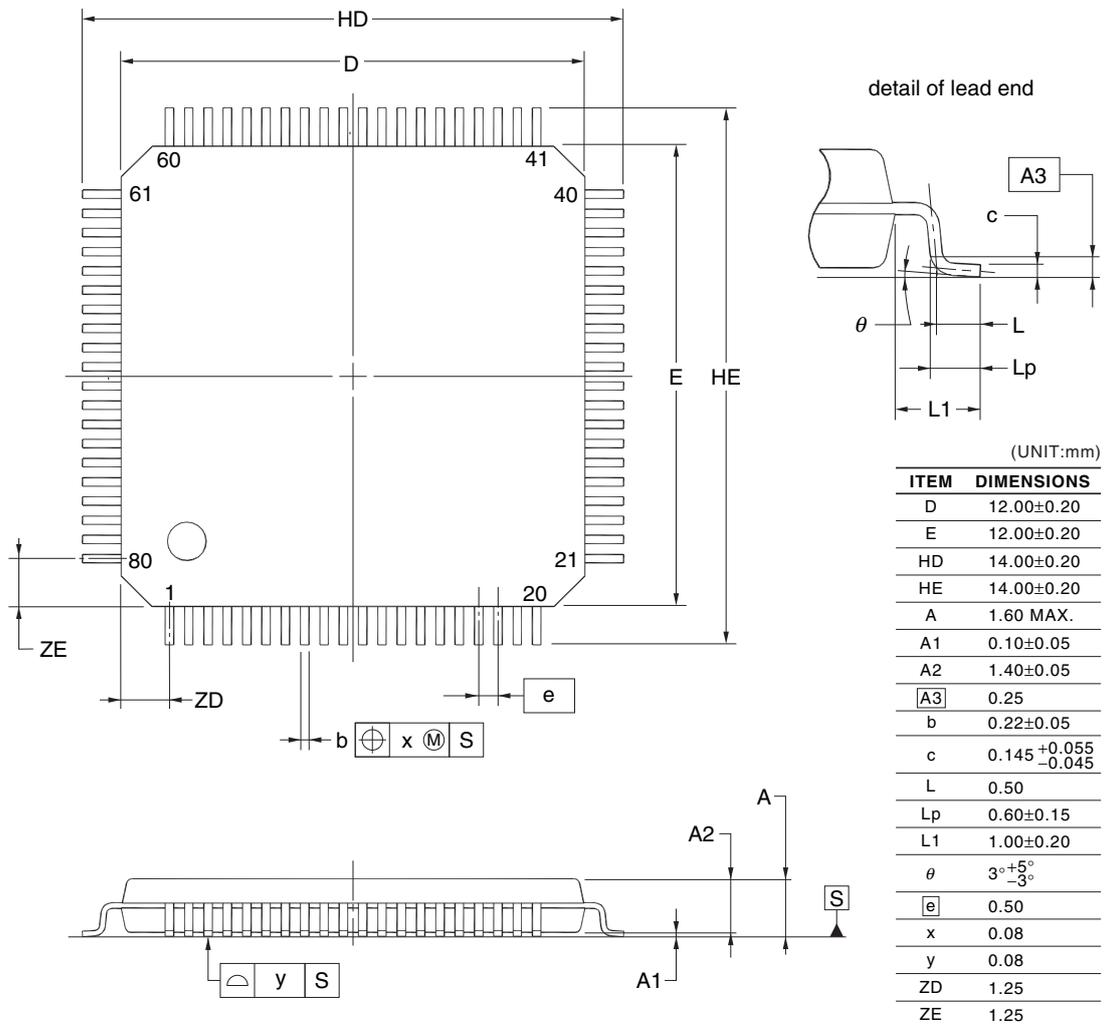

NOTE
Each lead centerline is located within 0.08 mm of its true position at maximum material condition.

©2012 Renesas Electronics Corporation. All rights reserved.

<R>

| JEITA Package Code | RENESAS Code | Previous Code | MASS (Typ) [g] |
|----------------------|--------------|---------------|----------------|
| P-LFQFP80-12x12-0.50 | PLQP0080KB-B | — | 0.5 |

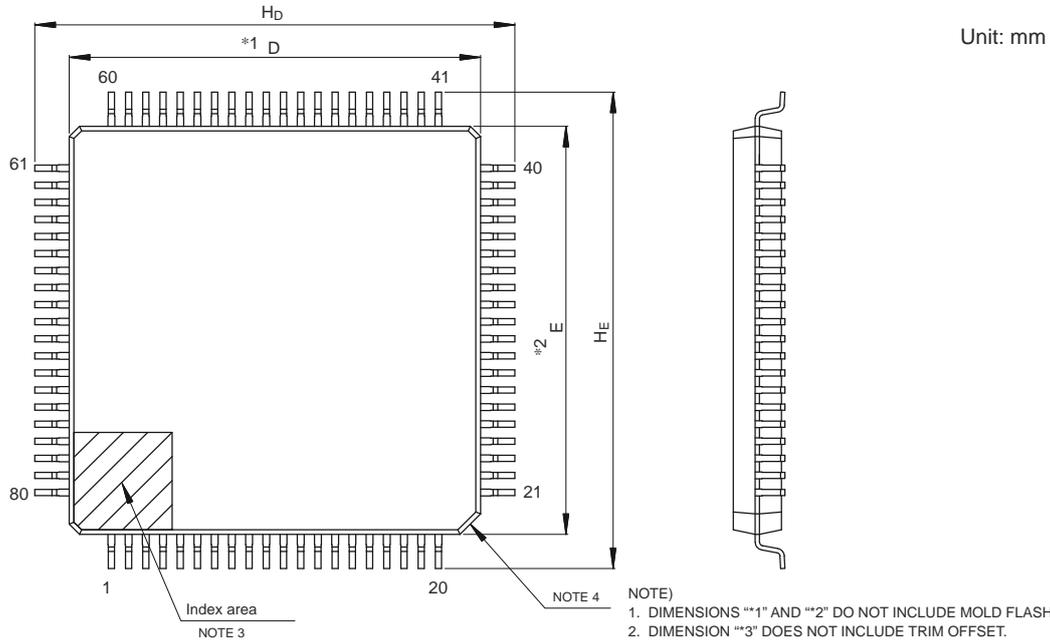

- NOTE)
1. DIMENSIONS "1" AND "2" DO NOT INCLUDE MOLD FLASH.
 2. DIMENSION "3" DOES NOT INCLUDE TRIM OFFSET.
 3. PIN 1 VISUAL INDEX FEATURE MAY VARY, BUT MUST BE LOCATED WITHIN THE HATCHED AREA.
 4. CHAMFERS AT CORNERS ARE OPTIONAL, SIZE MAY VARY.

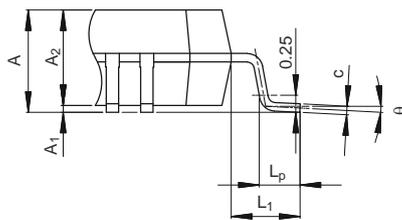
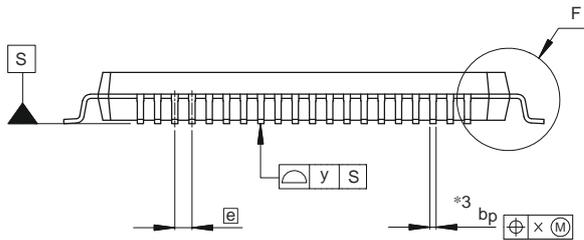

Detail F

| Reference Symbol | Dimensions in millimeters | | |
|------------------|---------------------------|------|------|
| | Min | Nom | Max |
| D | 11.9 | 12.0 | 12.1 |
| E | 11.9 | 12.0 | 12.1 |
| A ₂ | — | 1.4 | — |
| H _D | 13.8 | 14.0 | 14.2 |
| H _E | 13.8 | 14.0 | 14.2 |
| A | — | — | 1.7 |
| A ₁ | 0.05 | — | 0.15 |
| b _p | 0.15 | 0.20 | 0.27 |
| c | 0.09 | — | 0.20 |
| θ | 0° | 3.5° | 8° |
| e | — | 0.5 | — |
| x | — | — | 0.08 |
| y | — | — | 0.08 |
| L _p | 0.45 | 0.6 | 0.75 |
| L ₁ | — | 1.0 | — |

© 2017 Renesas Electronics Corporation. All rights reserved.

<R>

| | | | |
|---------------------|--------------|----------------|-----------------|
| JEITA Package Code | RENESAS Code | Previous Code | MASS (TYP.) [g] |
| P-LQFP80-14x14-0.65 | PLQP0080JB-E | P80GC-65-UBT-2 | 0.69 |

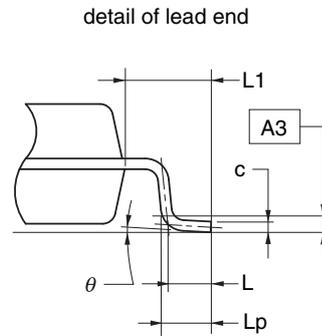
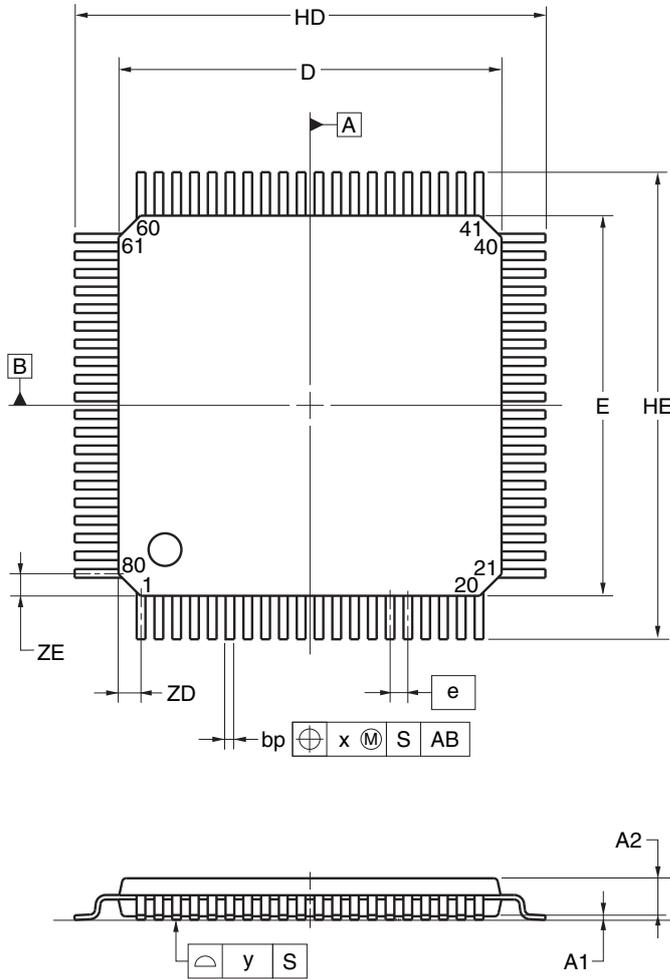

| Reference Symbol | Dimension in Millimeters | | |
|------------------|--------------------------|-------|-------|
| | Min | Nom | Max |
| D | 13.80 | 14.00 | 14.20 |
| E | 13.80 | 14.00 | 14.20 |
| HD | 17.00 | 17.20 | 17.40 |
| HE | 17.00 | 17.20 | 17.40 |
| A | — | — | 1.70 |
| A1 | 0.05 | 0.125 | 0.20 |
| A2 | 1.35 | 1.40 | 1.45 |
| A3 | — | 0.25 | — |
| bp | 0.26 | 0.32 | 0.38 |
| c | 0.10 | 0.145 | 0.20 |
| L | — | 0.80 | — |
| Lp | 0.736 | 0.886 | 1.036 |
| L1 | 1.40 | 1.60 | 1.80 |
| θ | 0° | 3° | 8° |
| e | — | 0.65 | — |
| x | — | — | 0.13 |
| y | — | — | 0.10 |
| ZD | — | 0.825 | — |
| ZE | — | 0.825 | — |

© 2012 Renesas Electronics Corporation. All rights reserved.

<R> 4.10 100-pin Package

| | | | |
|-----------------------|--------------|-----------------|-----------------|
| JEITA Package Code | RENESAS Code | Previous Code | MASS (TYP.) [g] |
| P-LFQFP100-14x14-0.50 | PLQP0100KE-A | P100GC-50-GBR-1 | 0.69 |

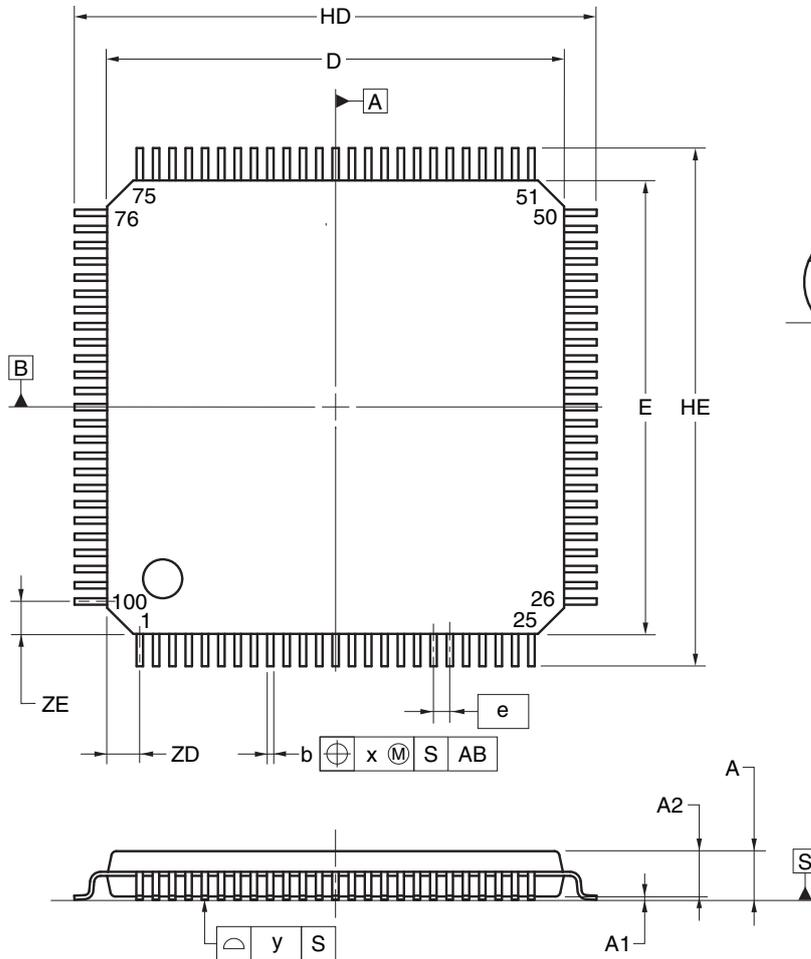

detail of lead end

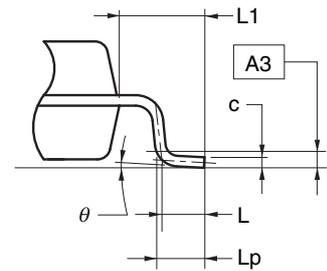

(UNIT:mm)

| ITEM | DIMENSIONS |
|------|---|
| D | 14.00±0.20 |
| E | 14.00±0.20 |
| HD | 16.00±0.20 |
| HE | 16.00±0.20 |
| A | 1.60 MAX. |
| A1 | 0.10±0.05 |
| A2 | 1.40±0.05 |
| A3 | 0.25 |
| b | 0.22±0.05 |
| c | 0.145 ^{+0.055} _{-0.045} |
| L | 0.50 |
| Lp | 0.60±0.15 |
| L1 | 1.00±0.20 |
| θ | 3° ^{+5°} _{-3°} |
| e | 0.50 |
| x | 0.08 |
| y | 0.08 |
| ZD | 1.00 |
| ZE | 1.00 |

©2012 Renesas Electronics Corporation. All rights reserved.

<R>

| JEITA Package Code | RENESAS Code | Previous Code | MASS (Typ) [g] |
|-----------------------|--------------|---------------|----------------|
| P-LFQFP100-14x14-0.50 | PLQP0100KB-B | — | 0.6 |

Unit: mm

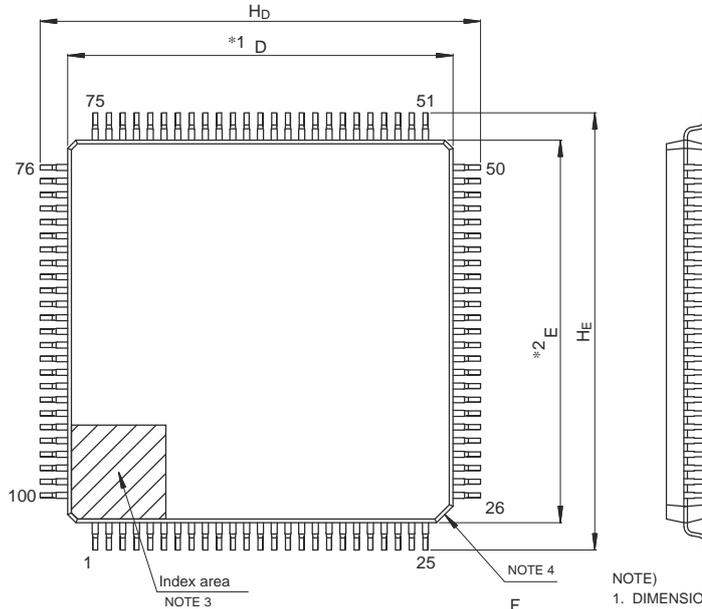

- NOTE)
1. DIMENSIONS "*"1" AND "*"2" DO NOT INCLUDE MOLD FLASH.
 2. DIMENSION "*"3" DOES NOT INCLUDE TRIM OFFSET.
 3. PIN 1 VISUAL INDEX FEATURE MAY VARY, BUT MUST BE LOCATED WITHIN THE HATCHED AREA.
 4. CHAMFERS AT CORNERS ARE OPTIONAL, SIZE MAY VARY.

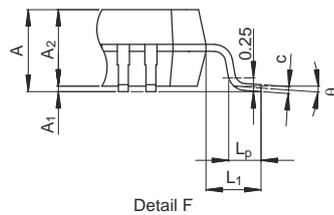
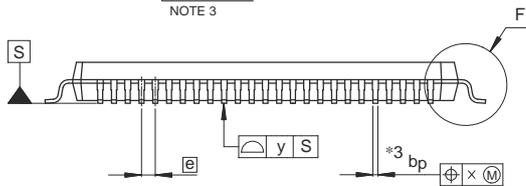

| Reference Symbol | Dimensions in millimeters | | |
|------------------|---------------------------|------|------|
| | Min | Nom | Max |
| D | 13.9 | 14.0 | 14.1 |
| E | 13.9 | 14.0 | 14.1 |
| A ₂ | — | 1.4 | — |
| H _D | 15.8 | 16.0 | 16.2 |
| H _E | 15.8 | 16.0 | 16.2 |
| A | — | — | 1.7 |
| A ₁ | 0.05 | — | 0.15 |
| b _p | 0.15 | 0.20 | 0.27 |
| c | 0.09 | — | 0.20 |
| θ | 0° | 3.5° | 8° |
| e | — | 0.5 | — |
| x | — | — | 0.08 |
| y | — | — | 0.08 |
| L _p | 0.45 | 0.6 | 0.75 |
| L ₁ | — | 1.0 | — |

© 2015 Renesas Electronics Corporation. All rights reserved.

<R>

| | | | |
|----------------------|--------------|-----------------|-----------------|
| JEITA Package Code | RENESAS Code | Previous Code | MASS (TYP.) [g] |
| P-LQFP100-14x20-0.65 | PLQP0100JC-A | P100GF-65-GBN-1 | 0.92 |

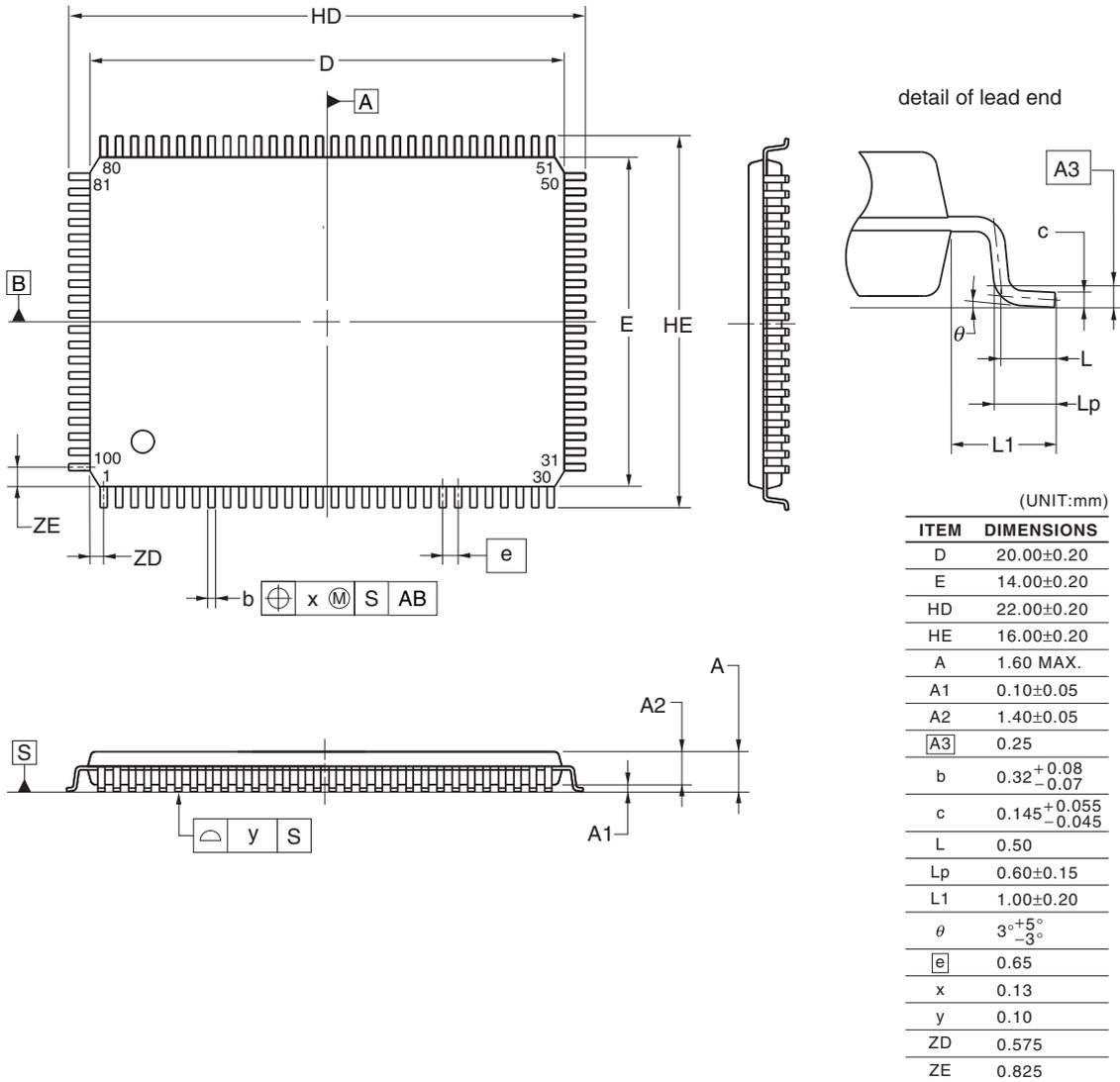

©2012 Renesas Electronics Corporation. All rights reserved.

REVISION HISTORY

RL78/G14 Datasheet

| Rev. | Date | Description | |
|------|---|-------------|--|
| | | Page | Summary |
| 0.01 | Feb 10, 2011 | — | First Edition issued |
| 0.02 | May 01, 2011 | 1 to 2 | 1.1 Features revised |
| | | 3 | 1.2 Ordering Information revised |
| | | 4 to 13 | 1.3 Pin Configuration (Top View) revised |
| | | 14 | 1.4 Pin Identification revised |
| | | 15 to 17 | 1.5.1 30-pin products to 1.5.3 36-pin products revised |
| | | 23 to 26 | 1.6 Outline of Functions revised |
| 0.03 | Jul 28, 2011 | 1 | 1.1 Features revised |
| 1.00 | Feb 21, 2012 | 1 to 40 | 1. OUTLINE revised |
| | | 41 to 97 | 2. ELECTRICAL SPECIFICATIONS added |
| 2.00 | Oct 25, 2013 | 1 | Modification of 1.1 Features |
| | | 3 to 8 | Modification of 1.2 Ordering Information |
| | | 9 to 22 | Modification of package type in 1.3 Pin Configuration (Top View) |
| | | 34 to 43 | Modification of description of subsystem clock in 1.6 Outline of Functions |
| | | 34 to 43 | Modification of description of timer output in 1.6 Outline of Functions |
| | | 34 to 43 | Modification of error of data transfer controller in 1.6 Outline of Functions |
| | | 34 to 43 | Modification of error of event link controller in 1.6 Outline of Functions |
| | | 45, 46 | Modification of description of Tables in 2.1 Absolute Maximum Ratings |
| | | 47 | Modification of Tables, notes, cautions, and remarks in 2.2 Oscillator Characteristics |
| | | 48 | Modification of error of conditions of high level input voltage in 2.3.1 Pin characteristics |
| | | 49 | Modification of error of conditions of low level output voltage in 2.3.1 Pin characteristics |
| | | 53 to 62 | Modification of Notes and Remarks in 2.3.2 Supply current characteristics |
| | | 65, 66 | Addition of Minimum Instruction Execution Time during Main System Clock Operation |
| | | 67 to 69 | Addition of AC Timing Test Points |
| | | 70 to 97 | Addition of LS mode and LV mode characteristics in 2.5.1 Serial array unit |
| | | 98 to 101 | Addition of LS mode and LV mode characteristics in 2.5.2 Serial interface IICA |
| | | 102 to 105 | Addition of characteristics about conversion of internal reference voltage and temperature sensor in 2.6.1 A/D converter characteristics |
| | | 107 | Addition of characteristic in 2.6.4 Comparator |
| | | 107 | Deletion of detection delay in 2.6.5 POR circuit characteristics |
| | | 109 | Modification of 2.6.7 Power supply voltage rising slope characteristics |
| 110 | Modification of 2.7 Data Memory STOP Mode Low Supply Voltage Data Retention Characteristics | | |
| 110 | Addition of characteristic in 2.8 Flash Memory Programming Characteristics | | |
| 111 | Addition of description in 2.10 Timing for Switching Flash Memory Programming Modes | | |

REVISION HISTORY

RL78/G14 Datasheet

| Rev. | Date | Description | |
|------------|--|----------------------------|---|
| | | Page | Summary |
| 2.00 | Oct 25, 2013 | 112 to 169 | Addition of CHAPTER 3 ELECTRICAL SPECIFICATIONS |
| | | 171 to 187 | Modification of 4.1 30-pin products to 4.10 100-pin products |
| 3.00 | Feb 07, 2014 | All | Addition of products with maximum 512 KB flash ROM and 48 KB RAM |
| | | 1 | Modification of 1.1 Features |
| | | 2 | Modification of ROM, RAM capacities and addition of note 3 |
| | | 3 | Modification of Figure 1 - 1 Part Number, Memory Size, and Package of RL78/G14 |
| | | 6 to 8 | Addition of part number |
| | | 15, 16 | Modification of 1.3.6 48-pin products |
| | | 17 | Modification of 1.3.7 52-pin products |
| | | 18, 19 | Modification of 1.3.8 64-pin products |
| | | 20 | Modification of 1.3.9 80-pin products |
| | | 21, 22 | Modification of 1.3.10 100-pin products |
| | | 35, 37, 39, 41, 43, 45, 47 | Modification of operating ambient temperature in 1.6 Outline of Functions |
| | | 42, 43 | Addition of table of 48-pin, 52-pin, 64-pin products (code flash memory 384 KB to 512 KB) |
| | | 46, 47 | Addition of table of 80-pin, 100-pin products (code flash memory 384 KB to 512 KB) |
| | | 65 to 68 | Addition of (3) Flash ROM: 384 to 512 KB of 48- to 100-pin products |
| | | 118 | Modification of 2.7 Data Memory Retention Characteristics |
| | | 137 to 140 | Addition of (3) Flash ROM: 384 to 512 KB of 48- to 100-pin products |
| | | 180 | Modification of 3.7 Data Memory Retention Characteristics |
| | | 189, 190 | Addition and modification of 4.6 48-pin products |
| | | 191 | Modification of 4.7 52-pin products |
| 193 to 195 | Addition and modification of 4.8 64-pin products | | |
| 198, 199 | Addition and modification of 4.9 80-pin products | | |
| 201, 202 | Addition and modification of 4.10 100-pin products | | |
| 3.20 | Jan 05, 2015 | 2 | Deletion of R5F104JK and R5F104JL from the list of ROM and RAM capacities and modification of note |
| | | 6 | Deletion of ordering part numbers of R5F104JK and R5F104JL from 52-pin plastic LQFP package in 1.2 Ordering Information |
| | | 6 to 8 | Deletion of note 2 in 1.2 Ordering Information |
| | | 17 | Deletion of note 2 in 1.3.7 52-pin products |
| | | 36, 39, 42, 45, 48, 50, 52 | Modification of description in 1.6 Outline of Functions |
| | | 46, 48 | Deletion of description of 52-pin in 1.6 Outline of Functions |
| | | 47 | Modification of note of 1.6 Outline of Functions |
| | | 62, 64, 66, 68, 70, 72 | Modification of specifications in 2.3.2 Supply current characteristics |

| | |
|------------------|--------------------|
| REVISION HISTORY | RL78/G14 Datasheet |
|------------------|--------------------|

| Rev. | Date | Description | |
|------|--------------|--|---|
| | | Page | Summary |
| 3.20 | Jan 05, 2015 | 135, 137, 139, 141, 143, 145 | Modification of specifications in 3.3.2 Supply current characteristics |
| | | 197 | Modification of part number in 4.7 52-pin products |
| 3.30 | Aug 12, 2016 | 143, 145 | Addition of maximum values in (3) Flash ROM: 384 to 512 KB of 48- to 100-pin products of 3.3.2 Supply current characteristics |
| 3.31 | Feb 14, 2020 | 3 | Addition of packaging specifications in Figure 1 - 1 Part Number, Memory Size, and Package of RL78/G14 |
| | | 4 to 15 | Addition of ordering part numbers and RENESAS codes in Table 1 - 1 List of Ordering Part Numbers |
| | | 195, 196, 198 to 201, 203, 205 to 207, 209 to 212, 214, 215, 217 | Modification of the titles of the subchapters and deletion of product names in Chapter 4 |
| | | 197 | Addition of figure in 4.2 32-pin Package |
| | | 202 | Addition of figure in 4.5 44-pin Package |
| | | 204 | Modification of figure in 4.6 48-pin Package |
| | | 208 | Modification of figure in 4.8 64-pin Package |
| | | 213 | Modification of figure in 4.9 80-pin Package |
| | | 216 | Modification of figure in 4.10 100-pin Package |

SuperFlash is a registered trademark of Silicon Storage Technology, Inc. in several countries including the United States and Japan.

Caution: This product uses SuperFlash® technology licensed from Silicon Storage Technology, Inc.

All trademarks and registered trademarks are the property of their respective owners.

General Precautions in the Handling of Microprocessing Unit and Microcontroller Unit Products

The following usage notes are applicable to all Microprocessing unit and Microcontroller unit products from Renesas. For detailed usage notes on the products covered by this document, refer to the relevant sections of the document as well as any technical updates that have been issued for the products.

1. Precaution against Electrostatic Discharge (ESD)

A strong electrical field, when exposed to a CMOS device, can cause destruction of the gate oxide and ultimately degrade the device operation. Steps must be taken to stop the generation of static electricity as much as possible, and quickly dissipate it when it occurs. Environmental control must be adequate. When it is dry, a humidifier should be used. This is recommended to avoid using insulators that can easily build up static electricity.

Semiconductor devices must be stored and transported in an anti-static container, static shielding bag or conductive material. All test and measurement tools including work benches and floors must be grounded. The operator must also be grounded using a wrist strap. Semiconductor devices must not be touched with bare hands. Similar precautions must be taken for printed circuit boards with mounted semiconductor devices.

2. Processing at power-on

The state of the product is undefined at the time when power is supplied. The states of internal circuits in the LSI are indeterminate and the states of register settings and pins are undefined at the time when power is supplied. In a finished product where the reset signal is applied to the external reset pin, the states of pins are not guaranteed from the time when power is supplied until the reset process is completed. In a similar way, the states of pins in a product that is reset by an on-chip power-on reset function are not guaranteed from the time when power is supplied until the power reaches the level at which resetting is specified.

3. Input of signal during power-off state

Do not input signals or an I/O pull-up power supply while the device is powered off. The current injection that results from input of such a signal or I/O pull-up power supply may cause malfunction and the abnormal current that passes in the device at this time may cause degradation of internal elements. Follow the guideline for input signal during power-off state as described in your product documentation.

4. Handling of unused pins

Handle unused pins in accordance with the directions given under handling of unused pins in the manual. The input pins of CMOS products are generally in the high-impedance state. In operation with an unused pin in the open-circuit state, extra electromagnetic noise is induced in the vicinity of the LSI, an associated shoot-through current flows internally, and malfunctions occur due to the false recognition of the pin state as an input signal become possible.

5. Clock signals

After applying a reset, only release the reset line after the operating clock signal becomes stable. When switching the clock signal during program execution, wait until the target clock signal is stabilized. When the clock signal is generated with an external resonator or from an external oscillator during a reset, ensure that the reset line is only released after full stabilization of the clock signal. Additionally, when switching to a clock signal produced with an external resonator or by an external oscillator while program execution is in progress, wait until the target clock signal is stable.

6. Voltage application waveform at input pin

Waveform distortion due to input noise or a reflected wave may cause malfunction. If the input of the CMOS device stays in the area between V_{IL} (Max.) and V_{IH} (Min.) due to noise, for example, the device may malfunction. Take care to prevent chattering noise from entering the device when the input level is fixed, and also in the transition period when the input level passes through the area between V_{IL} (Max.) and V_{IH} (Min.).

7. Prohibition of access to reserved addresses

Access to reserved addresses is prohibited. The reserved addresses are provided for possible future expansion of functions. Do not access these addresses as the correct operation of the LSI is not guaranteed.

8. Differences between products

Before changing from one product to another, for example to a product with a different part number, confirm that the change will not lead to problems. The characteristics of a microprocessing unit or microcontroller unit products in the same group but having a different part number might differ in terms of internal memory capacity, layout pattern, and other factors, which can affect the ranges of electrical characteristics, such as characteristic values, operating margins, immunity to noise, and amount of radiated noise. When changing to a product with a different part number, implement a system-evaluation test for the given product.

Notice

1. Descriptions of circuits, software and other related information in this document are provided only to illustrate the operation of semiconductor products and application examples. You are fully responsible for the incorporation or any other use of the circuits, software, and information in the design of your product or system. Renesas Electronics disclaims any and all liability for any losses and damages incurred by you or third parties arising from the use of these circuits, software, or information.
2. Renesas Electronics hereby expressly disclaims any warranties against and liability for infringement or any other claims involving patents, copyrights, or other intellectual property rights of third parties, by or arising from the use of Renesas Electronics products or technical information described in this document, including but not limited to, the product data, drawings, charts, programs, algorithms, and application examples.
3. No license, express, implied or otherwise, is granted hereby under any patents, copyrights or other intellectual property rights of Renesas Electronics or others.
4. You shall not alter, modify, copy, or reverse engineer any Renesas Electronics product, whether in whole or in part. Renesas Electronics disclaims any and all liability for any losses or damages incurred by you or third parties arising from such alteration, modification, copying or reverse engineering.
5. Renesas Electronics products are classified according to the following two quality grades: "Standard" and "High Quality". The intended applications for each Renesas Electronics product depends on the product's quality grade, as indicated below.
"Standard": Computers; office equipment; communications equipment; test and measurement equipment; audio and visual equipment; home electronic appliances; machine tools; personal electronic equipment; industrial robots; etc.
"High Quality": Transportation equipment (automobiles, trains, ships, etc.); traffic control (traffic lights); large-scale communication equipment; key financial terminal systems; safety control equipment; etc.
Unless expressly designated as a high reliability product or a product for harsh environments in a Renesas Electronics data sheet or other Renesas Electronics document, Renesas Electronics products are not intended or authorized for use in products or systems that may pose a direct threat to human life or bodily injury (artificial life support devices or systems; surgical implantations; etc.), or may cause serious property damage (space system; undersea repeaters; nuclear power control systems; aircraft control systems; key plant systems; military equipment; etc.). Renesas Electronics disclaims any and all liability for any damages or losses incurred by you or any third parties arising from the use of any Renesas Electronics product that is inconsistent with any Renesas Electronics data sheet, user's manual or other Renesas Electronics document.
6. When using Renesas Electronics products, refer to the latest product information (data sheets, user's manuals, application notes, "General Notes for Handling and Using Semiconductor Devices" in the reliability handbook, etc.), and ensure that usage conditions are within the ranges specified by Renesas Electronics with respect to maximum ratings, operating power supply voltage range, heat dissipation characteristics, installation, etc. Renesas Electronics disclaims any and all liability for any malfunctions, failure or accident arising out of the use of Renesas Electronics products outside of such specified ranges.
7. Although Renesas Electronics endeavors to improve the quality and reliability of Renesas Electronics products, semiconductor products have specific characteristics, such as the occurrence of failure at a certain rate and malfunctions under certain use conditions. Unless designated as a high reliability product or a product for harsh environments in a Renesas Electronics data sheet or other Renesas Electronics document, Renesas Electronics products are not subject to radiation resistance design. You are responsible for implementing safety measures to guard against the possibility of bodily injury, injury or damage caused by fire, and/or danger to the public in the event of a failure or malfunction of Renesas Electronics products, such as safety design for hardware and software, including but not limited to redundancy, fire control and malfunction prevention, appropriate treatment for aging degradation or any other appropriate measures. Because the evaluation of microcomputer software alone is very difficult and impractical, you are responsible for evaluating the safety of the final products or systems manufactured by you.
8. Please contact a Renesas Electronics sales office for details as to environmental matters such as the environmental compatibility of each Renesas Electronics product. You are responsible for carefully and sufficiently investigating applicable laws and regulations that regulate the inclusion or use of controlled substances, including without limitation, the EU RoHS Directive, and using Renesas Electronics products in compliance with all these applicable laws and regulations. Renesas Electronics disclaims any and all liability for damages or losses occurring as a result of your noncompliance with applicable laws and regulations.
9. Renesas Electronics products and technologies shall not be used for or incorporated into any products or systems whose manufacture, use, or sale is prohibited under any applicable domestic or foreign laws or regulations. You shall comply with any applicable export control laws and regulations promulgated and administered by the governments of any countries asserting jurisdiction over the parties or transactions.
10. It is the responsibility of the buyer or distributor of Renesas Electronics products, or any other party who distributes, disposes of, or otherwise sells or transfers the product to a third party, to notify such third party in advance of the contents and conditions set forth in this document.
11. This document shall not be reprinted, reproduced or duplicated in any form, in whole or in part, without prior written consent of Renesas Electronics.
12. Please contact a Renesas Electronics sales office if you have any questions regarding the information contained in this document or Renesas Electronics products.

(Note 1) "Renesas Electronics" as used in this document means Renesas Electronics Corporation and also includes its directly or indirectly controlled subsidiaries.

(Note 2) "Renesas Electronics product(s)" means any product developed or manufactured by or for Renesas Electronics.

(Rev.4.0-1 November 2017)



SALES OFFICES

Renesas Electronics Corporation

<http://www.renesas.com>

Refer to "<http://www.renesas.com/>" for the latest and detailed information.

Renesas Electronics Corporation

TOYOSU FORESIA, 3-2-24 Toyosu, Koto-ku, Tokyo 135-0061, Japan

Renesas Electronics America Inc. Milpitas Campus

1001 Murphy Ranch Road, Milpitas, CA 95035, U.S.A.

Tel: +1-408-432-8888, Fax: +1-408-434-5351

Renesas Electronics America Inc. San Jose Campus

6024 Silver Creek Valley Road, San Jose, CA 95138, USA

Tel: +1-408-284-8200, Fax: +1-408-284-2775

Renesas Electronics Canada Limited

9251 Yonge Street, Suite 8309 Richmond Hill, Ontario Canada L4C 9T3

Tel: +1-905-237-2004

Renesas Electronics Europe GmbH

Arcadiastrasse 10, 40472 Düsseldorf, Germany

Tel: +49-211-6503-0, Fax: +49-211-6503-1327

Renesas Electronics (China) Co., Ltd.

Room 101-T01, Floor 1, Building 7, Yard No. 7, 8th Street, Shangdi, Haidian District, Beijing 100085, China

Tel: +86-10-8235-1155, Fax: +86-10-8235-7679

Renesas Electronics (Shanghai) Co., Ltd.

Unit 301, Tower A, Central Towers, 555 Langao Road, Putuo District, Shanghai 200333, China

Tel: +86-21-2226-0888, Fax: +86-21-2226-0999

Renesas Electronics Hong Kong Limited

Unit 1601-1611, 16/F., Tower 2, Grand Century Place, 193 Prince Edward Road West, Mongkok, Kowloon, Hong Kong

Tel: +852-2265-6688, Fax: +852 2886-9022

Renesas Electronics Taiwan Co., Ltd.

13F, No. 363, Fu Shing North Road, Taipei 10543, Taiwan

Tel: +886-2-8175-9600, Fax: +886 2-8175-9670

Renesas Electronics Singapore Pte. Ltd.

80 Bendemeer Road, #06-02 Singapore 339949

Tel: +65-6213-0200, Fax: +65-6213-0300

Renesas Electronics Malaysia Sdn.Bhd.

Unit No 3A-1 Level 3A Tower 8 UOA Business Park, No 1 Jalan Pengerutcara U1/51A, Seksyen U1, 40150 Shah Alam, Selangor, Malaysia

Tel: +60-3-5022-1288, Fax: +60-3-5022-1290

Renesas Electronics India Pvt. Ltd.

No.777C, 100 Feet Road, HAL 2nd Stage, Indiranagar, Bangalore 560 038, India

Tel: +91-80-67208700

Renesas Electronics Korea Co., Ltd.

17F, KAMCO Yangjae Tower, 262, Gangnam-daero, Gangnam-gu, Seoul, 06265 Korea

Tel: +82-2-558-3737, Fax: +82-2-558-5338

Mouser Electronics

Authorized Distributor

Click to View Pricing, Inventory, Delivery & Lifecycle Information:

Renesas Electronics:

[R5F104AFASP#X0](#) [R5F104BCANA#W0](#) [R5F104FJAFP#X0](#) [R5F104GAAFB#V0](#) [R5F104MKGFA#30](#)
[R5F104LKAFa#50](#) [R5F104GEGFB#V0](#) [R5F104MHAFa#X0](#) [R5F104EDGNA#U0](#) [R5F104PKAFa#30](#)
[R5F104LFALa#U0](#) [R5F104MGAFa#V0](#) [R5F104LCAFP#V0](#) [R5F104LLAFB#50](#) [R5F104MGDFB#V0](#)
[R5F104LEAFP#V0](#) [R5F104GGAFB#X0](#) [R5F104BGANA#W0](#) [R5F104EFANA#U0](#) [R5F104GDADF#V0](#)
[R5F104LDALa#U0](#) [R5F104LFAFP#V0](#) [R5F104LCALa#U0](#) [R5F104FAAFP#V0](#) [R5F104GCANA#W0](#)
[R5F104JGAFa#V0](#) [R5F104LCAFB#V0](#) [R5F104PKAFB#30](#) [R5F104GDANA#U0](#) [R5F104GLAFB#50](#)
[R5F104BEGNa#U0](#) [R5F104CDALa#U0](#) [R5F104GCAFB#V0](#) [R5F104GLANA#U0](#) [R5F104BDANA#U0](#)
[R5F104CEALa#U0](#) [R5F104GJAFB#V0](#) [R5F104GKAFB#50](#) [R5F104JJAFa#V0](#) [R5F104BFGNa#U0](#)
[R5F104MLAFB#50](#) [R5F104EDGNA#W0](#) [R5F104MLGFB#30](#) [R5F104ADASP#V0](#) [R5F104AFASP#V0](#)
[R5F104AGASP#V0](#) [R5F104MJAFa#V0](#) [R5F104PFAFB#V0](#) [R5F104MJAFB#V0](#) [R5F104PHAFa#V0](#)
[R5F104BCGFP#V0](#) [R5F104ACASP#X0](#) [R5F104LHAFa#V0](#) [R5F104MHAFa#V0](#) [R5F104MLAFa#30](#)
[R5F104PFAFa#V0](#) [R5F104PJAFa#V0](#) [R5F104MHAFB#V0](#) [R5F104MJAFa#X0](#) [R5F104MKAFa#30](#)
[R5F104MKAFB#30](#) [R5F104PGAFa#V0](#) [R5F104PLAFa#30](#) [R5F104PLAFB#30](#) [R5F104JFAFa#V0](#)
[R5F104JEAFa#V0](#) [R5F104JJAFa#X0](#) [R5F104LEALa#U0](#) [R5F104LJALa#U0](#) [R5F104LLAFa#50](#) [R5F104LEAFB#V0](#)
[R5F104JGGFa#V0](#) [R5F104LDAFB#V0](#) [R5F104LJAFa#V0](#) [R5F104MGAFB#V0](#) [R5F104LLALa#W0](#)
[R5F104GCDFB#V0](#) [R5F104LKALa#W0](#) [R5F104LHAFB#V0](#) [R5F104PGAFB#V0](#) [R5F104PJAFB#X0](#)
[R5F104MKGFA#50](#) [R5F104LDAFA#V0](#) [R5F104LJAFP#V0](#) [R5F104LLAFa#30](#) [R5F104LHAFP#V0](#)
[R5F104GJANA#U0](#) [R5F104GKAFB#30](#) [R5F104BDAFP#V0](#) [R5F104GGANA#U0](#) [R5F104LKALa#U0](#)
[R5F104LLAFB#30](#) [R5F104MFAFa#V0](#) [R5F104JDFAFa#V0](#) [R5F104GHANA#U0](#) [R5F104JCAFa#X0](#)
[R5F104LDALa#W0](#) [R5F104LKAFa#30](#) [R5F104JGGFa#30](#) [R5F104LEAFa#V0](#)

Компания «Океан Электроники» предлагает заключение долгосрочных отношений при поставках импортных электронных компонентов на взаимовыгодных условиях!

Наши преимущества:

- Поставка оригинальных импортных электронных компонентов напрямую с производств Америки, Европы и Азии, а так же с крупнейших складов мира;
- Широкая линейка поставок активных и пассивных импортных электронных компонентов (более 30 млн. наименований);
- Поставка сложных, дефицитных, либо снятых с производства позиций;
- Оперативные сроки поставки под заказ (от 5 рабочих дней);
- Экспресс доставка в любую точку России;
- Помощь Конструкторского Отдела и консультации квалифицированных инженеров;
- Техническая поддержка проекта, помощь в подборе аналогов, поставка прототипов;
- Поставка электронных компонентов под контролем ВП;
- Система менеджмента качества сертифицирована по Международному стандарту ISO 9001;
- При необходимости вся продукция военного и аэрокосмического назначения проходит испытания и сертификацию в лаборатории (по согласованию с заказчиком);
- Поставка специализированных компонентов военного и аэрокосмического уровня качества (Xilinx, Altera, Analog Devices, Intersil, Interpoint, Microsemi, Actel, Aeroflex, Peregrine, VPT, Syfer, Eurofarad, Texas Instruments, MS Kennedy, Miteq, Cobham, E2V, MA-COM, Hittite, Mini-Circuits, General Dynamics и др.);

Компания «Океан Электроники» является официальным дистрибьютором и эксклюзивным представителем в России одного из крупнейших производителей разъемов военного и аэрокосмического назначения «JONHON», а так же официальным дистрибьютором и эксклюзивным представителем в России производителя высокотехнологичных и надежных решений для передачи СВЧ сигналов «FORSTAR».



JONHON

«JONHON» (основан в 1970 г.)

Разъемы специального, военного и аэрокосмического назначения:

(Применяются в военной, авиационной, аэрокосмической, морской, железнодорожной, горно- и нефтедобывающей отраслях промышленности)

«FORSTAR» (основан в 1998 г.)

ВЧ соединители, коаксиальные кабели, кабельные сборки и микроволновые компоненты:

(Применяются в телекоммуникациях гражданского и специального назначения, в средствах связи, РЛС, а так же военной, авиационной и аэрокосмической отраслях промышленности).



Телефон: 8 (812) 309-75-97 (многоканальный)

Факс: 8 (812) 320-03-32

Электронная почта: ocean@oceanchips.ru

Web: <http://oceanchips.ru/>

Адрес: 198099, г. Санкт-Петербург, ул. Калинина, д. 2, корп. 4, лит. А