

Ultra High Precision Foil Wraparound Surface Mount Chip Resistor with TCR of ± 0.05 ppm/°C and Power Coefficient of 5 ppm at Rated Power and Load Life Stability of ± 0.005 % (50 ppm)



Top View
(for date code print specification please refer to table 2)

INTRODUCTION

VSMP Series is the industry's first device to provide high rated power and excellent load life stability along with extremely low TCR — all in one resistor.

One of the most important parameters influencing stability is the Temperature Coefficient of Resistance (TCR). Although the TCR of foil resistors is considered extremely low, this characteristic has been further refined over the years. The VSMP Series utilizes ultra high precision Bulk Metal® Z-Foil. The Z-Foil technology provides a significant reduction of the resistive element's sensitivity to ambient temperature variations (TCR) and to self heating when power is applied (Power Coefficient of Resistance, or PCR). Along with the inherently low PCR and TCR, Z-Foil technology also provides remarkably improved load life stability, low noise and tight tolerances.

The VSMP resistor has a full wraparound termination which assures secure contact during the manufacturing process, as well as providing stability during multiple thermal cyclings.

Vishay Foil Resistors' (VFR) application engineering department is available to advise and make recommendations. For non-standard technical requirements and special applications, please contact VFR using the e-mail address in the footer below.

TABLE 1 - TOLERANCE AND TCR VS. RESISTANCE VALUE (1)

(- 55 °C to + 125 °C, + 25 °C Ref.)

| RESISTANCE VALUE (Ω) | TOLERANCE (%) | TYPICAL TCR AND MAX. SPREAD (ppm/°C) |
|----------------------|---------------|--------------------------------------|
| 250 to 125K | ± 0.01 | ± 0.2 ± 1.8 |
| 100 to < 250 | ± 0.02 | ± 0.2 ± 1.8 |
| 50 to < 100 | ± 0.05 | ± 0.2 ± 2.8 |
| 25 to < 50 | ± 0.1 | ± 0.2 ± 3.8 |
| 10 to < 25 | ± 0.25 | ± 0.2 ± 3.8 |
| 5 to < 10 | ± 0.5 | ± 0.2 ± 7.8 |

Note

(1) For tighter performances and non-standard values lower than 5 Ω and above 125K, please contact VFR's application engineering using the e-mail addresses in the footer below

FEATURES

- Temperature coefficient of resistance (TCR):
0.05 ppm/°C typical (0 °C to + 60 °C)
0.2 ppm/°C typical (- 55 °C to + 125 °C, + 25 °C ref.)
- Resistance tolerance: to ± 0.01 %
- Power coefficient "ΔR due to self heating":
5 ppm at rated power
- Power rating: to 750 mW at + 70 °C (see table 3)
- **Load life stability: to ± 0.005 % at 70 °C, 2000 h at rated power**
- Resistance range: 5 Ω to 125 kΩ (for lower or higher values, please contact us)
- Vishay Foil resistors are not restricted to standard values, we can supply specific "as required" values at no extra cost or delivery (e.g. 1K2345 vs. 1K)
- Thermal stabilization time < 1 s (nominal value achieved within 10 ppm of steady state value)
- **Electrostatic discharge (ESD) at least to 25 kV**
- Short time overload: ≤ 0.005 %
- Non inductive, non capacitive design
- Rise time: 1 ns effectively no ringing
- Current noise: 0.010 μV_{RMS}/V of applied voltage (< - 40 dB)
- Voltage coefficient < 0.1 ppm/V
- Non inductive: < 0.08 μH
- Non hot spot design
- Terminal finishes available: lead (Pb)-free, tin/lead alloy
- Matched sets are available on request
- Prototype quantities available in just 5 working days or sooner. For more information, please contact foil@vishaypg.com



RoHS*
COMPLIANT

FIGURE 1 - POWER DERATING CURVE

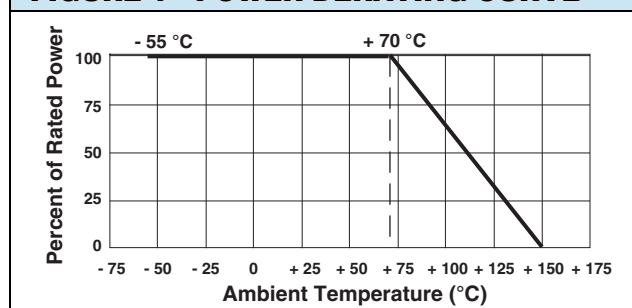

* Pb containing terminations are not RoHS compliant; exemptions may apply

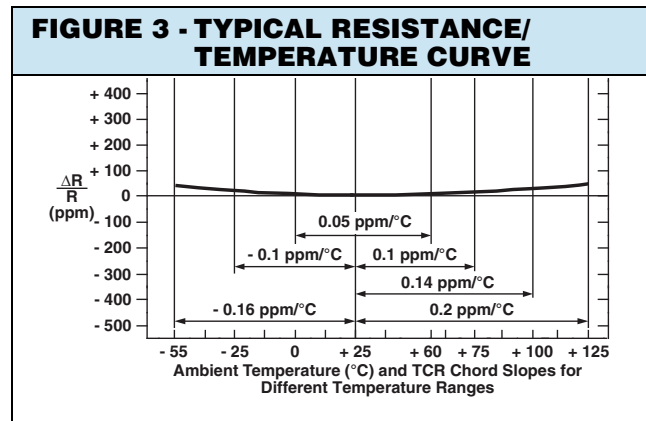
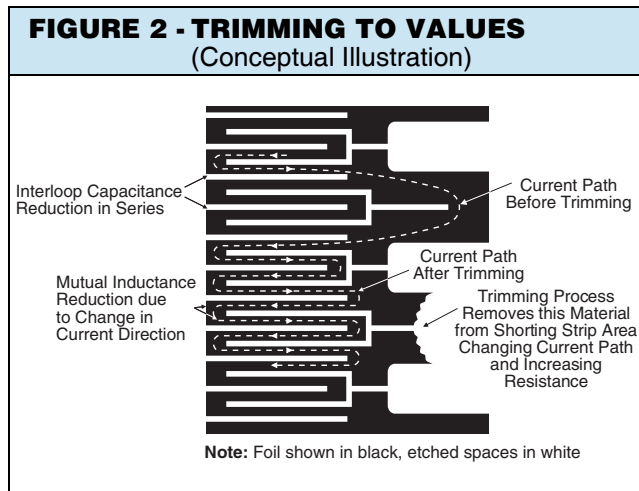

Note

- The TCR values for $< 100 \Omega$ are influenced by the termination composition and result in deviation from this curve

TABLE 2 - DIMENSIONS AND LAND PATTERN in Inches (Millimeters)

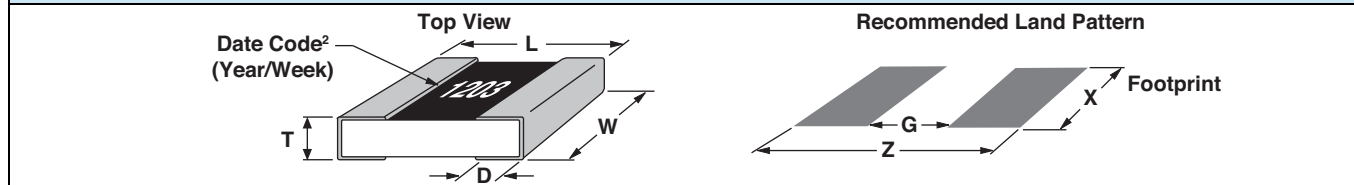

| CHIP SIZE | L ± 0.005 (0.13) | W ± 0.005 (0.13) | THICKNESS MAXIMUM | D ± 0.005 (0.13) | Z ⁽¹⁾ | G ⁽¹⁾ | X ⁽¹⁾ |
|-----------|-------------------------|-------------------------|----------------------|-------------------------|------------------|------------------|------------------|
| 0603 | 0.063 (1.60) | 0.032 (0.81) | 0.025 (0.64) | 0.011 (0.28) | 0.102 (2.59) | 0.031 (0.78) | 0.031 (0.78) |
| 0805 | 0.080 (2.03) | 0.050 (1.27) | 0.025 (0.64) | 0.015 (0.38) | 0.122 (3.10) | 0.028 (0.71) | 0.050 (1.27) |
| 1206 | 0.126 (3.20) | 0.062 (1.57) | 0.025 (0.64) | 0.020 (0.51) | 0.175 (4.45) | 0.059 (1.50) | 0.071 (1.80) |
| 1506 | 0.150 (3.81) | 0.062 (1.57) | 0.025 (0.64) | 0.020 (0.51) | 0.199 (5.05) | 0.083 (2.11) | 0.071 (1.80) |
| 2010 | 0.198 (5.03) | 0.097 (2.46) | 0.025 (0.64) | 0.025 (0.64) | 0.247 (6.27) | 0.115 (2.92) | 0.103 (2.62) |
| 2018 | 0.204 (5.18) | 0.184 (4.67) | 0.025 (0.64) | 0.018 (0.46) | 0.248 (6.3) | 0.146 (3.71) | 0.184 (4.67) |
| 2512 | 0.249 (6.32) | 0.127 (3.23) | 0.025 (0.64) | 0.032 (0.81) | 0.291 (7.39) | 0.150 (3.81) | 0.127 (3.23) |

Note

(1) Land Pattern Dimensions are per IPC-7351A

(2) The date code printing applies to all resistor sizes except for 0603

TABLE 3 - SPECIFICATIONS

| CHIP SIZE | RATED POWER (mW) at + 70 °C | MAX. WORKING VOLTAGE ($\leq \sqrt{P \times R}$) | RESISTANCE RANGE (Ω)* | MAXIMUM WEIGHT (mg) |
|-----------|-----------------------------|---|--------------------------------|---------------------|
| 0603 | 100 | 20 V | 100 to 4K | 3 |
| 0805 | 200 | 40 V | 5 to 8K | 6 |
| 1206 | 300 | 87 V | 5 to 25K | 11 |
| 1506 | 300 | 95 V | 5 to 30K | 12 |
| 2010 | 500 | 187 V | 5 to 70K | 27 |
| 2018 | 750 | 122 V | 5 to 20K | 40 |
| 2512 | 750 | 220 V | 5 to 125K | 40 |

* For non standard values please contact VFR's application engineering using the e-mail addresses in the footer below.

TABLE 4 - LOAD LIFE STABILITY
(+ 70 °C for 2000 h)

| CHIP SIZE | MAXIMUM ΔR LIMITS |
|------------|---|
| 0603 | ± 0.005 % at 50 mW ± 0.01 % at 100 mW |
| 0805 | ± 0.005 % at 100 mW ± 0.01 % at 200 mW |
| 1206, 1506 | ± 0.005 % at 150 mW ± 0.01 % at 300 mW |
| 2010 | ± 0.005 % at 200 mW ± 0.01 % at 500 mW |
| 2018 | ± 0.005 % at 500 mW ± 0.01 % at 750 mW |
| 2512 | ± 0.005 % at 500 mW ± 0.01 % at 750 mW |

TABLE 5 - PERFORMANCES

| TEST OR CONDITIONS | MIL-PRF-55342 CHARACTERISTIC E ΔR LIMITS | TYPICAL ΔR LIMITS | MAXIMUM ΔR LIMITS ⁽¹⁾ |
|--|--|---------------------------|--|
| Thermal Shock, 100 x (- 65 °C to + 150 °C) | ± 0.1 % | ± 0.005 % (50 ppm) | ± 0.01 % (100 ppm) |
| Low Temperature Operation, - 65 °C, 45 min at P _{nom} | ± 0.1 % | ± 0.005 % (50 ppm) | ± 0.01 % (100 ppm) |
| Short Time Overload, 6.25 x Rated Power, 5 s | ± 0.1 % | ± 0.005 % (50 ppm) | ± 0.01 % (100 ppm) |
| High Temperature Exposure, + 150 °C, 100 h | ± 0.1 % | ± 0.01 % (100 ppm) | ± 0.02 % (200 ppm) |
| Resistance to Soldering Heat | ± 0.2 % | ± 0.005 % (50 ppm) | ± 0.01 % (100 ppm) |
| Moisture Resistance | ± 0.2 % | ± 0.005 % (50 ppm) | ± 0.02 % (200 ppm) |
| Load Life Stability + 70 °C for 2000 h at Rated Power | ± 0.5 % | ± 0.005 % (50 ppm) | ± 0.01 % (100 ppm) |

Note

(1) As shown + 0.01 Ω to allow for measurement errors at low values

FIGURE 4 - RECOMMENDED MOUNTING

Notes

- (1) IR and vapor phase reflow are recommended.
- (2) Avoid the use of cleaning agents which could attack epoxy resins, which form part of the resistor construction
- (3) Vacuum pick up is recommended for handling
- (4) In case of using soldering iron, precaution measures should be taken to avoid damaging the resistor

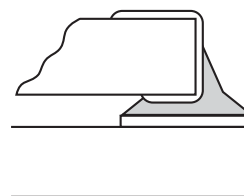
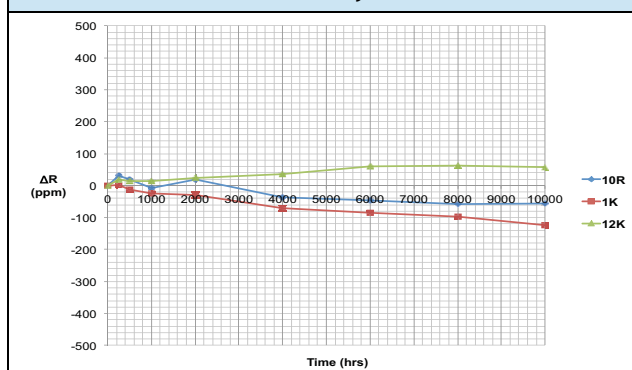

FIGURE 5 - VSMP0603 100 CYCLE THERMAL SHOCK - 65 °C TO 150 °C, 10 UNITS EACH VALUE



FIGURE 6 - LOAD LIFE TEST FOR 10,000 HRS @0.3W, +70°C; VSMP 1206, N=40



CRYOGENIC TEST

Different expansion/contraction rates of composite materials in resistors may induce discontinuities during temperature excursions that are not evident at temperature extremes, making an unreliable resistor appear normal. A good resistor must also return to its initial value with no resistance drift. In this demo, a VFR VSMP0805 precision resistor is monitored through the range of +25°C, down to -196°C and back up to +25°C. Results confirm the VSMP0805 exhibits only 5 ppm/°C TCR, experiences no discontinuities, and returns to its exact same starting value, showing absolutely no change in resistance (< 1 ppm measurement accuracy).

FIGURE 7 - PRECISION RESISTOR IN CRYOGENIC CONDITIONS - ONLY 5 PPM/°C (PRODUCT DEMO)



PULSE TEST

TEST DESCRIPTION

All parts are baked at +125°C for 1 hour and allowed to cool at room temperature for 1 hour, prior to testing. By using an electrolytic 0.01µF capacitor charged to 1200 VDC, a single pulse was performed on 30 units of 1206, 10 kΩ of Surface Mount Vishay Foil resistor and Thin Film resistor. The units were allowed time to cool down, after which the resistance measurements were taken and displayed in ppm deviation from the initial reading.

TEST RESULTS



FIGURE 9 - PULSE TEST RESULTS AT 1200 VDC*

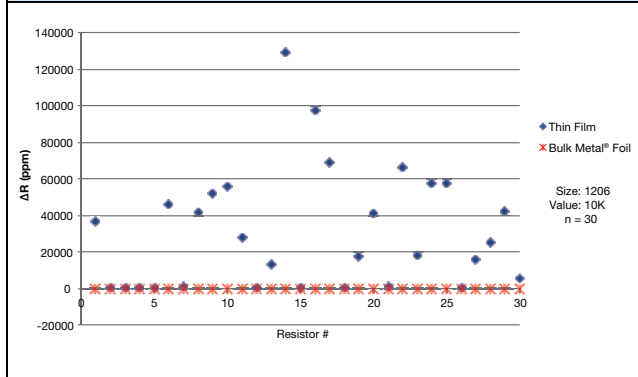

* Note: Average of 30 units yielded deviation of 30,723 ppm of the Thin Film vs. -14 ppm for the Bulk Metal® Foil

ELECTROSTATIC DISCHARGE (ESD)

ESD can be categorized into three types of damages:

Parametric Failure - occurs when the ESD event alters one or more device parameters (resistance in the case of resistors), causing it to shift from its required tolerance. This failure does not directly pertain to functionality; thus a parametric failure may be present while the device is still functional.

Catastrophic Damage - occurs when the ESD event causes the device to immediately stop functioning. This may occur after one or a number of ESD events with diverse causes, such as human body discharge or the mere presence of an electrostatic field.

Latent Damage - occurs when the ESD event causes moderate damage to the device, which is not noticeable, as the device appears to be functioning correctly. However, the load life of the device has been dramatically reduced, and further degradation caused by operating stresses may cause the device to fail during service. Latent damage is the source for greatest concern, since it is very difficult to detect by re-measurement or by visual inspection, because damage may have occurred under the external coating.

TEST DESCRIPTION

By using an electrolytic 500 pF capacitor charged up to 4500 V, pulses were performed on 10 units of 1206, 10 kΩ of three different Surface Mount Chip Resistors technologies, with an initial voltage spike of 2500 V (Figure 10). The units were allowed time to cool down, after which the resistance measurements were taken and displayed in ppm deviation from the initial readings. Readings were then taken in 500 V increments up to 4500 V.

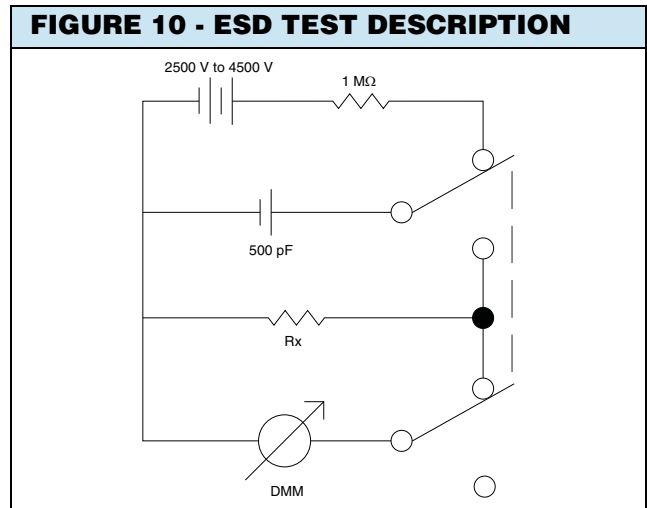

TABLE 6 - ESD TEST RESULTS (AVERAGE OF 10 UNITS)

| VOLTS | ΔR (%) | | |
|-------|------------|-----------|--------|
| | THICK FILM | THIN FILM | FOIL |
| 2500 | -2.7 | 97 | <0.005 |
| 3000 | -4.2 | 366 | <0.005 |
| 3500 | -6.2 | OPEN | <0.005 |
| 4000 | -7.4 | OPEN | <0.005 |
| 4500 | -8.6 | OPEN | <0.005 |

TABLE 7- GLOBAL PART NUMBER INFORMATION (1)

NEW GLOBAL PART NUMBER: Y162612K7560T9R (preferred part number format)



FOR EXAMPLE: ABOVE GLOBAL ORDER Y1626 12K7560 T 9 R:

TYPE: VSMP1506
VALUES: 12.7560 $k\Omega$
ABSOLUTE TOLERANCE: 0.01 %
TERMINATION: lead (Pb)-free
PACKAGING: tape and reel

HISTORICAL PART NUMBER: VSMP1506 12K756 TCR0.2 T S T (will continue to be used)

| VSMP1506 | 12K756 | TCR0.2 | T | S | T |
|--|------------------|---------------------|--|------------------------------------|--------------------------------------|
| MODEL | RESISTANCE VALUE | TCR CHARACTERISTICS | TOLERANCE | TERMINATION | PACKAGING |
| VSMP0603 VSMP0805 VSMP1206 VSMP1506 VSMP2010 VSMP2018 VSMP2512 | 12.756 $k\Omega$ | | T = $\pm 0.01\%$ Q = $\pm 0.02\%$ A = $\pm 0.05\%$ B = $\pm 0.10\%$ C = $\pm 0.25\%$ D = $\pm 0.5\%$ F = $\pm 1.0\%$ | S = lead (Pb)-free B = tin/lead | T = tape and reel W = waffle pack |

Note

(1) For non-standard requests, please contact application engineering.

PRECISION CENTER

Precision centers are located around the world to provide local, short run, quick delivery of Vishay Bulk Metal® Foil resistors. Unique to Vishay Foil Resistors (VFR) is the ability to provide any value to any tolerance. The precision centers can ship small quantities in five days or less.

Why do we have authorized local manufacturing or precision centers?

Because we have no standard values and each resistor is trimmed to the precise value ordered. The unique chain of Precision Centers brings these precise values as close as possible to the circuit designers in the shortest time possible.

For your local Precision Center please click [here](#).

Disclaimer

ALL PRODUCTS, PRODUCT SPECIFICATIONS AND DATA ARE SUBJECT TO CHANGE WITHOUT NOTICE.

Vishay Precision Group, Inc., its affiliates, agents, and employees, and all persons acting on its or their behalf (collectively, "Vishay Precision Group"), disclaim any and all liability for any errors, inaccuracies or incompleteness contained herein or in any other disclosure relating to any product.

The product specifications do not expand or otherwise modify Vishay Precision Group's terms and conditions of purchase, including but not limited to, the warranty expressed therein.

Vishay Precision Group makes no warranty, representation or guarantee other than as set forth in the terms and conditions of purchase. **To the maximum extent permitted by applicable law, Vishay Precision Group disclaims (i) any and all liability arising out of the application or use of any product, (ii) any and all liability, including without limitation special, consequential or incidental damages, and (iii) any and all implied warranties, including warranties of fitness for particular purpose, non-infringement and merchantability.**

Information provided in datasheets and/or specifications may vary from actual results in different applications and performance may vary over time. Statements regarding the suitability of products for certain types of applications are based on Vishay Precision Group's knowledge of typical requirements that are often placed on Vishay Precision Group products. It is the customer's responsibility to validate that a particular product with the properties described in the product specification is suitable for use in a particular application.

No license, express, implied, or otherwise, to any intellectual property rights is granted by this document, or by any conduct of Vishay Precision Group.

The products shown herein are not designed for use in life-saving or life-sustaining applications unless otherwise expressly indicated. Customers using or selling Vishay Precision Group products not expressly indicated for use in such applications do so entirely at their own risk and agree to fully indemnify Vishay Precision Group for any damages arising or resulting from such use or sale. Please contact authorized Vishay Precision Group personnel to obtain written terms and conditions regarding products designed for such applications.

Product names and markings noted herein may be trademarks of their respective owners.

Компания «Океан Электроники» предлагает заключение долгосрочных отношений при поставках импортных электронных компонентов на взаимовыгодных условиях!

Наши преимущества:

- Поставка оригинальных импортных электронных компонентов напрямую с производств Америки, Европы и Азии, а так же с крупнейших складов мира;
- Широкая линейка поставок активных и пассивных импортных электронных компонентов (более 30 млн. наименований);
- Поставка сложных, дефицитных, либо снятых с производства позиций;
- Оперативные сроки поставки под заказ (от 5 рабочих дней);
- Экспресс доставка в любую точку России;
- Помощь Конструкторского Отдела и консультации квалифицированных инженеров;
- Техническая поддержка проекта, помощь в подборе аналогов, поставка прототипов;
- Поставка электронных компонентов под контролем ВП;
- Система менеджмента качества сертифицирована по Международному стандарту ISO 9001;
- При необходимости вся продукция военного и аэрокосмического назначения проходит испытания и сертификацию в лаборатории (по согласованию с заказчиком);
- Поставка специализированных компонентов военного и аэрокосмического уровня качества (Xilinx, Altera, Analog Devices, Intersil, Interpoint, Microsemi, Actel, Aeroflex, Peregrine, VPT, Syfer, Eurofarad, Texas Instruments, MS Kennedy, Miteq, Cobham, E2V, MA-COM, Hittite, Mini-Circuits, General Dynamics и др.);

Компания «Океан Электроники» является официальным дистрибьютором и эксклюзивным представителем в России одного из крупнейших производителей разъемов военного и аэрокосмического назначения «**JONHON**», а так же официальным дистрибьютором и эксклюзивным представителем в России производителя высокотехнологичных и надежных решений для передачи СВЧ сигналов «**FORSTAR**».



JONHON

«**JONHON**» (основан в 1970 г.)

Разъемы специального, военного и аэрокосмического назначения:

(Применяются в военной, авиационной, аэрокосмической, морской, железнодорожной, горно- и нефтедобывающей отраслях промышленности)

«**FORSTAR**» (основан в 1998 г.)

ВЧ соединители, коаксиальные кабели, кабельные сборки и микроволновые компоненты:

(Применяются в телекоммуникациях гражданского и специального назначения, в средствах связи, РЛС, а так же военной, авиационной и аэрокосмической отраслях промышленности).



Телефон: 8 (812) 309-75-97 (многоканальный)

Факс: 8 (812) 320-03-32

Электронная почта: ocean@oceanchips.ru

Web: <http://oceanchips.ru/>

Адрес: 198099, г. Санкт-Петербург, ул. Калинина, д. 2, корп. 4, лит. А