

STELLA-A

Type II and III beam for street lighting.
Compatible with up to 23 mm LES size COBs.
Variant with black frame.

TECHNICAL SPECIFICATIONS:

Dimensions	Ø 90.0 mm
Height	22 mm
Fastening	screw
ROHS compliant	yes ⓘ

MATERIAL SPECIFICATIONS:

Component	Type	Material	Colour	Finish
STELLA-A	Single lens	Silicone	clear	
STELLA-FRAME	Holder	PA66	black	



ORDERING INFORMATION:

Component		Qty in box	MOQ	MPQ	Box weight (kg)
FN13323_STELLA-A	Single lens	100	50	10	6.6
» Box size:					

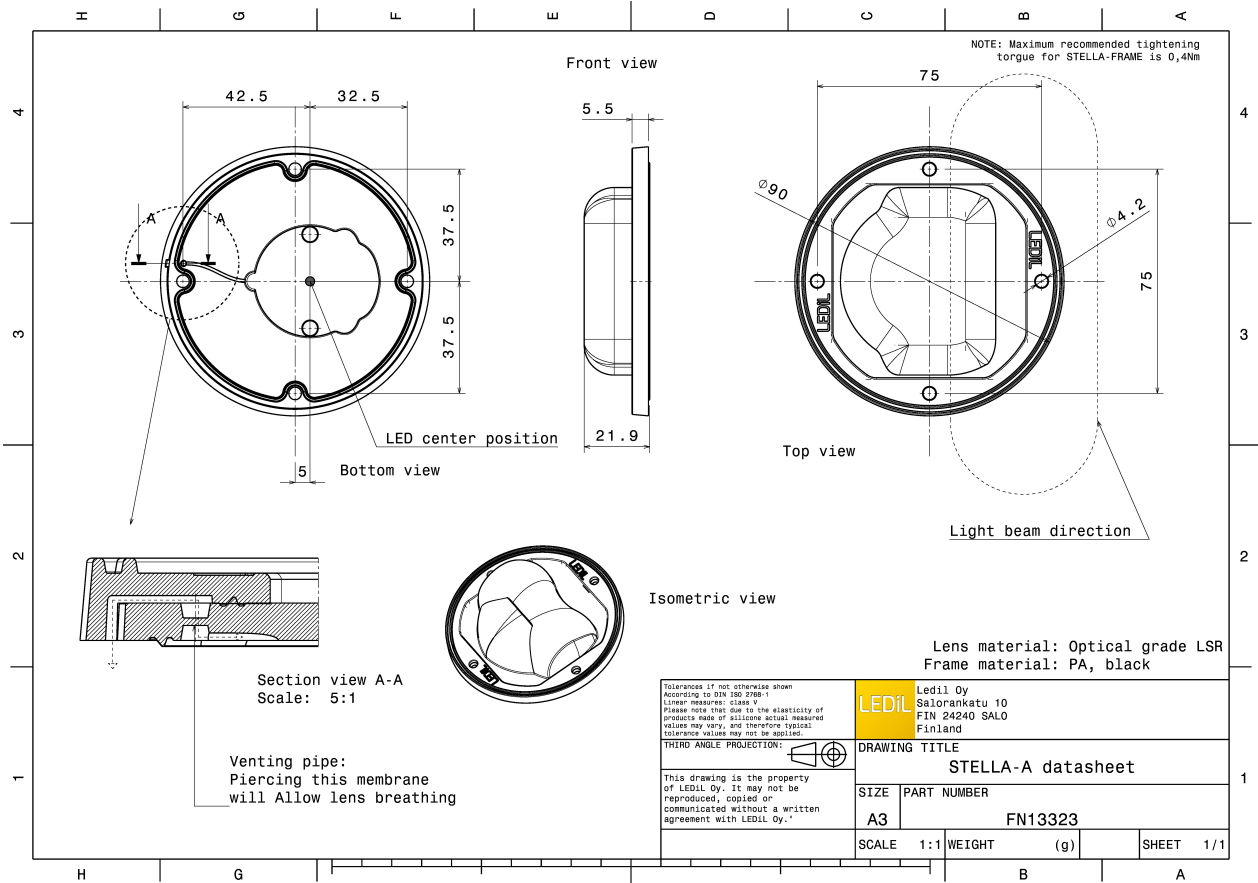

PHOTOMETRIC DATA (MEASURED):

<p>bridgelux.</p> <p>LED V15 Gen6</p> <p>FWHM Asymmetric</p> <p>Efficiency 91 %</p> <p>Peak intensity 0.6 cd/lm</p> <p>LEDs/each optic 1</p> <p>Light colour White</p> <p>Required components:</p>	
<p>bridgelux.</p> <p>LED V18 Gen7</p> <p>FWHM Asymmetric</p> <p>Efficiency 85 %</p> <p>Peak intensity 0.4 cd/lm</p> <p>LEDs/each optic 1</p> <p>Light colour White</p> <p>Required components:</p>	
<p>bridgelux.</p> <p>LED VERO13</p> <p>FWHM Asymmetric</p> <p>Efficiency 92 %</p> <p>Peak intensity 0.7 cd/lm</p> <p>LEDs/each optic 1</p> <p>Light colour White</p> <p>Required components:</p>	
<p>bridgelux.</p> <p>LED VERO18</p> <p>FWHM Asymmetric</p> <p>Efficiency 92 %</p> <p>Peak intensity 0.5 cd/lm</p> <p>LEDs/each optic 1</p> <p>Light colour White</p> <p>Required components:</p>	

PHOTOMETRIC DATA (MEASURED):

CITIZEN

LED CLL03x/CLU03x
 FWHM Asymmetric
 Efficiency 92 %
 Peak intensity 0.6 cd/lm
 LEDs/each optic 1
 Light colour White
 Required components:
 Bender Wirth: 433 Typ L1

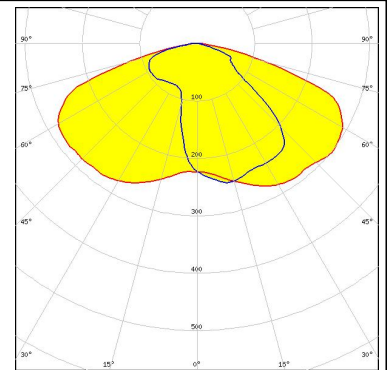
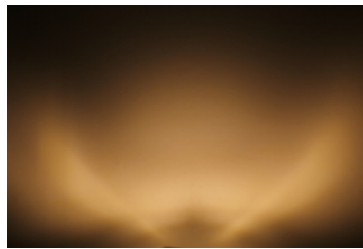

CITIZEN

LED CLU700/701/702
 FWHM Asymmetric
 Efficiency 89 %
 Peak intensity 1.4 cd/lm
 LEDs/each optic 1
 Light colour White
 Required components:
 Bender Wirth: 434 Typ L1

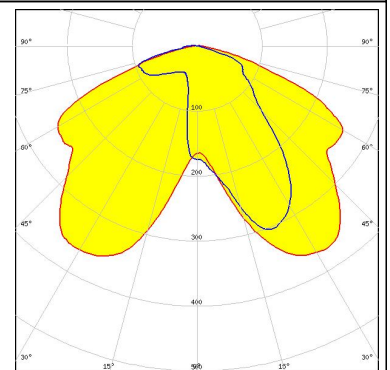
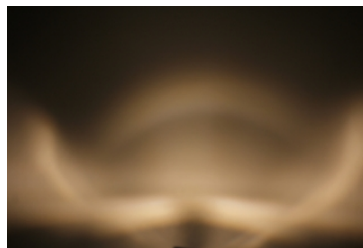

CITIZEN

LED CLU710/711
 FWHM Asymmetric
 Efficiency 89 %
 Peak intensity 1 cd/lm
 LEDs/each optic 1
 Light colour White
 Required components:

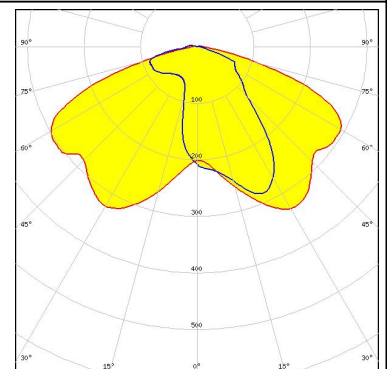

CITIZEN

LED CLU720/721
 FWHM Asymmetric
 Efficiency 91 %
 Peak intensity 0.8 cd/lm
 LEDs/each optic 1
 Light colour White
 Required components:
 Bender Wirth: 433 Typ L1

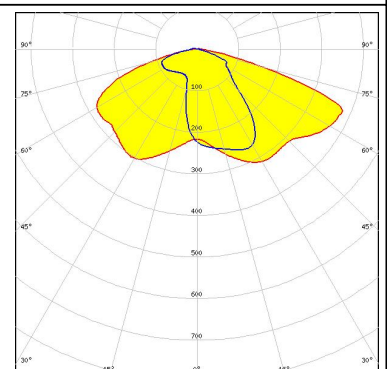
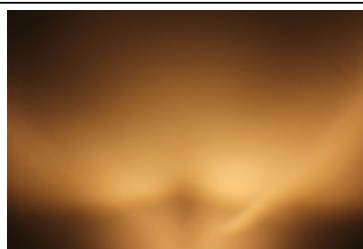

PHOTOMETRIC DATA (MEASURED):

CITIZEN

LED CLU720/721
 FWHM Asymmetric
 Efficiency %
 Peak intensity 0.7 cd/lm
 LEDs/each optic 1
 Light colour White
 Required components:

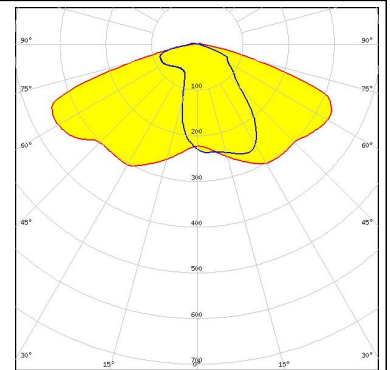

CREE

LED CXA/B 15xx
 FWHM Asymmetric
 Efficiency 92 %
 Peak intensity 0.9 cd/lm
 LEDs/each optic 1
 Light colour White
 Required components:
 Bender Wirth: 441 Typ L1

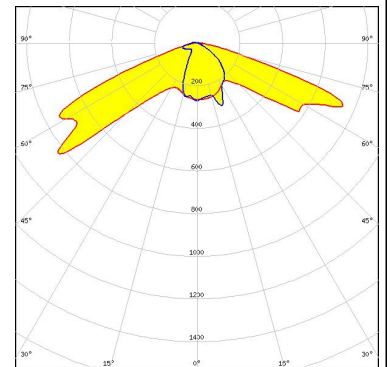
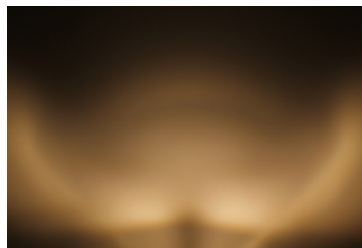

CREE

LED CXA/B 15xx
 FWHM Asymmetric
 Efficiency 89 %
 Peak intensity 1 cd/lm
 LEDs/each optic 1
 Light colour White
 Required components:
 C14305_STELLA-CLAMP-CXA15-18

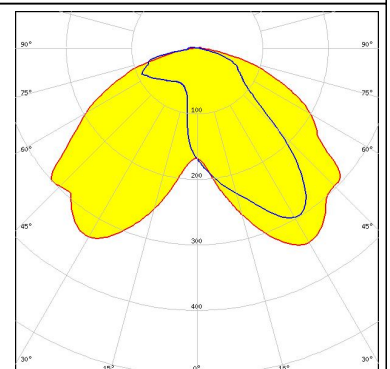

CREE

LED CXA/B 15xx
 FWHM Asymmetric
 Efficiency 92 %
 Peak intensity 1.1 cd/lm
 LEDs/each optic 1
 Light colour White
 Required components:

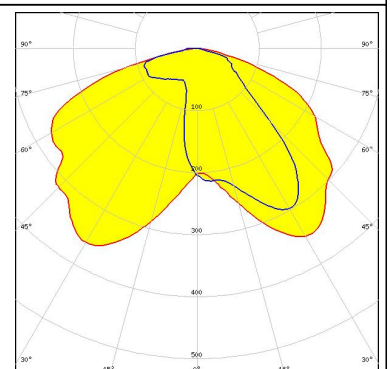

PHOTOMETRIC DATA (MEASURED):

CREE

LED CXA/B 1816 & CXA/B 1820 & CXA 1850
 FWHM Asymmetric
 Efficiency 87 %
 Peak intensity 0.7 cd/lm
 LEDs/each optic 1
 Light colour White
 Required components:

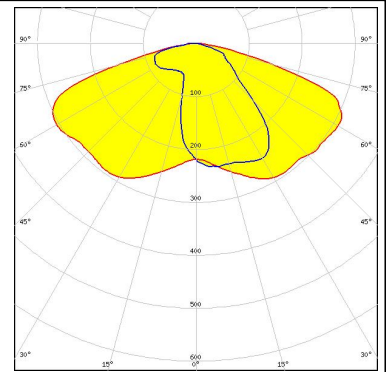

CREE

LED CXA/B 1816 & CXA/B 1820 & CXA 1850
 FWHM Asymmetric
 Efficiency 92 %
 Peak intensity 0.7 cd/lm
 LEDs/each optic 1
 Light colour White
 Required components:
 C14305_STELLA-CLAMP-CXA15-18

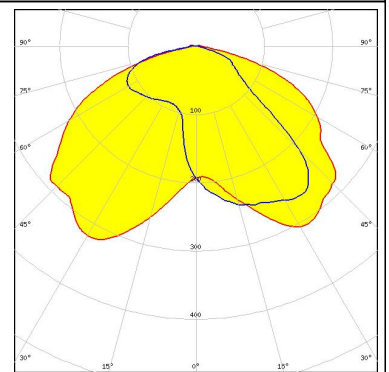

CREE

LED CXA/B 1816 & CXA/B 1820 & CXA 1850
 FWHM Asymmetric
 Efficiency 89 %
 Peak intensity 0.7 cd/lm
 LEDs/each optic 1
 Light colour White
 Required components:
 Bender Wirth: 437 Typ L1

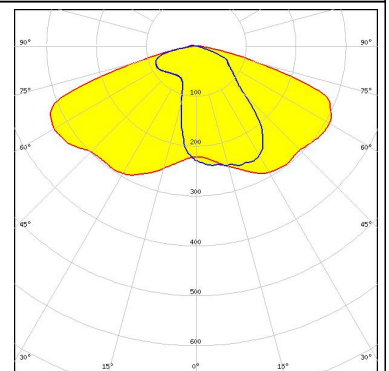

CREE

LED CXA/B 1816 & CXA/B 1820 & CXA 1850
 FWHM Asymmetric
 Efficiency 87 %
 Peak intensity 0.6 cd/lm
 LEDs/each optic 1
 Light colour White
 Required components:

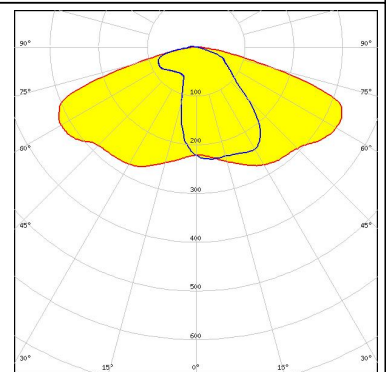

PHOTOMETRIC DATA (MEASURED):



LED CXA/B 25xx
 FWHM Asymmetric
 Efficiency 93 %
 Peak intensity 0.5 cd/lm
 LEDs/each optic 1
 Light colour White
 Required components:

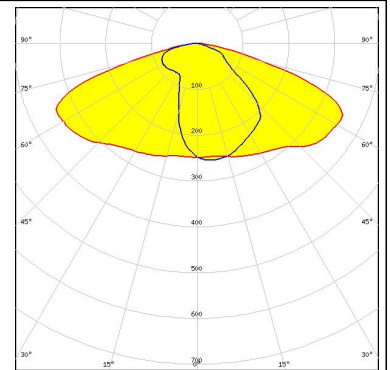

LED LUXEON CoB 1202/1203
 FWHM Asymmetric
 Efficiency 88 %
 Peak intensity 0.9 cd/lm
 LEDs/each optic 1
 Light colour White
 Required components:
 Bender Wirth: 438 Typ L1

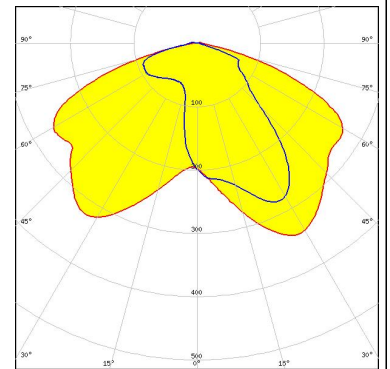

LED LUXEON CoB 1208
 FWHM Asymmetric
 Efficiency %
 Peak intensity 0.3 cd/lm
 LEDs/each optic 1
 Light colour White
 Required components:

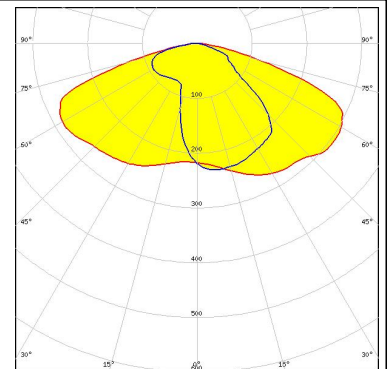

LED CxM-14 (19x19)
 FWHM Asymmetric
 Efficiency 90 %
 Peak intensity 0.6 cd/lm
 LEDs/each optic 1
 Light colour White
 Required components:

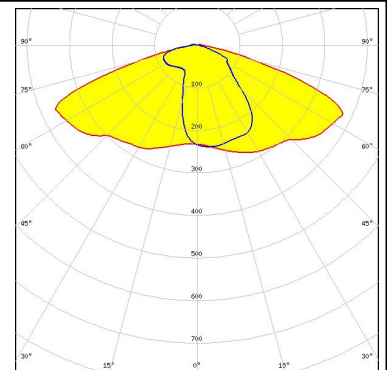

PHOTOMETRIC DATA (MEASURED):



LED CxM-18 (21.5x21.5)
 FWHM Asymmetric
 Efficiency 89 %
 Peak intensity 0.5 cd/lm
 LEDs/each optic 1
 Light colour White
 Required components:

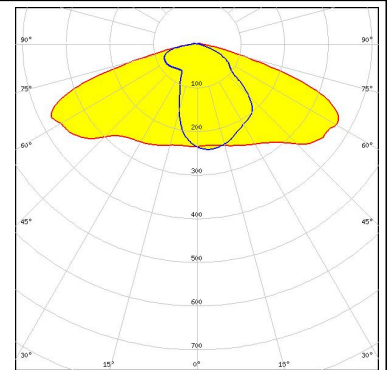

LED COB J-Type
 FWHM Asymmetric
 Efficiency 87 %
 Peak intensity 0.5 cd/lm
 LEDs/each optic 1
 Light colour White
 Required components:

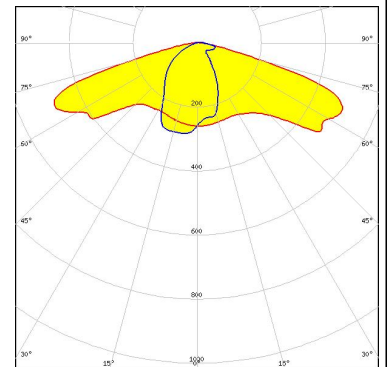

LED COB L-Type (LES 11)
 FWHM Asymmetric
 Efficiency 89 %
 Peak intensity 0.7 cd/lm
 LEDs/each optic 1
 Light colour White
 Required components:
 Bender Wirth: 438 Typ L1

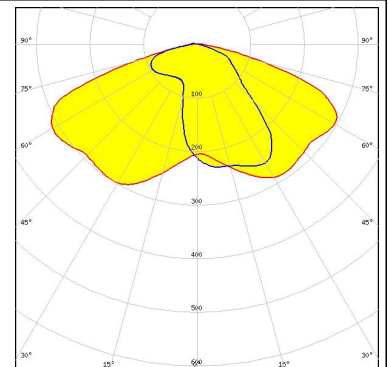

LED COB L-Type (LES 9)
 FWHM Asymmetric
 Efficiency 90 %
 Peak intensity 0.9 cd/lm
 LEDs/each optic 1
 Light colour White
 Required components:
 Bender Wirth: 438 Typ L1

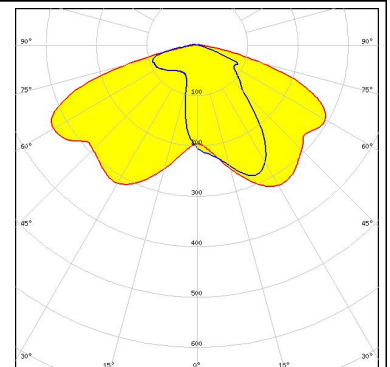

PHOTOMETRIC DATA (MEASURED):

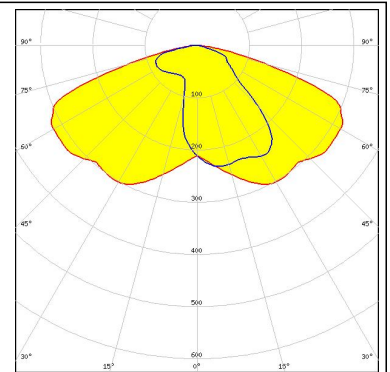
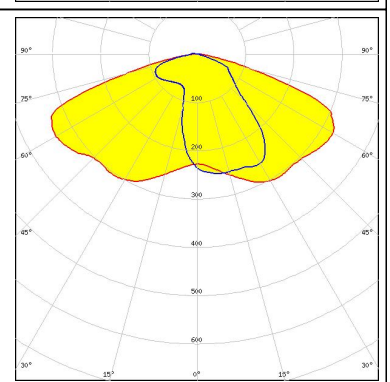
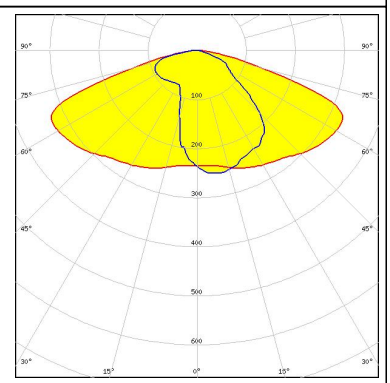
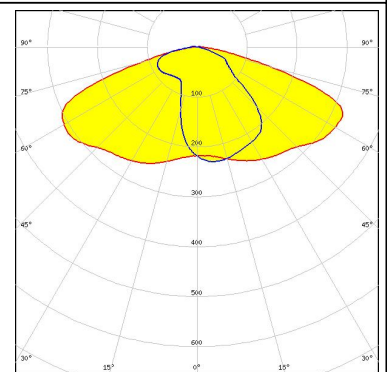
<p>OSRAM Opto Semiconductors</p> <p>LED Soleriq S13 FWHM Asymmetric Efficiency 91 % Peak intensity 0.7 cd/lm LEDs/each optic 1 Light colour White Required components:</p>	
<p>OSRAM Opto Semiconductors</p> <p>LED Soleriq S13 FWHM Asymmetric Efficiency 92 % Peak intensity 0.7 cd/lm LEDs/each optic 1 Light colour White Required components: Bender Wirth: 437 Typ L1</p>	
<p>OSRAM Opto Semiconductors</p> <p>LED Soleriq S19 FWHM Asymmetric Efficiency 90 % Peak intensity 0.5 cd/lm LEDs/each optic 1 Light colour White Required components:</p>	
<p>SAMSUNG</p> <p>LED LC016D / LC019D / LC026D / LC033D FWHM Asymmetric Efficiency 87 % Peak intensity 0.5 cd/lm LEDs/each optic 1 Light colour White Required components:</p>	

PHOTOMETRIC DATA (MEASURED):

SHARP

LED Mega Zenigata (GW6DME)
FWHM Asymmetric
Efficiency 90 %
Peak intensity 0.6 cd/lm
LEDs/each optic 1
Light colour White
Required components:

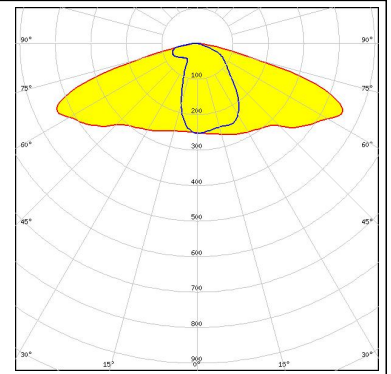

PHOTOMETRIC DATA (SIMULATED):

bridgelux.

LED	V10 Gen7
FWHM	Asymmetric
Efficiency	89 %
Peak intensity	0.6 cd/lm
LEDs/each optic	1
Light colour	White
Required components:	
	Bender Wirth: 486 Typ L1

bridgelux.

LED	V13 Gen7
FWHM	Asymmetric
Efficiency	89 %
Peak intensity	0.6 cd/lm
LEDs/each optic	1
Light colour	White
Required components:	
	Bender Wirth: 477 Typ L1

CITIZEN

LED	CLL02x/CLU02x (LES10)
FWHM	Asymmetric
Efficiency	91 %
Peak intensity	0.7 cd/lm
LEDs/each optic	1
Light colour	White
Required components:	

CITIZEN

LED	CLL03x/CLU03x
FWHM	Asymmetric
Efficiency	90 %
Peak intensity	0.5 cd/lm
LEDs/each optic	1
Light colour	White
Required components:	

GENERAL INFORMATION:

NOTE: The typical beam angle will be changed by different color, chip size and chip position tolerance. The typical total beam angle is the full angle measured where the luminous intensity is half of the peak value.

Due to use of high power COB's with this product, special attention to proper thermal design is highly recommended. LEDiL has no liability for direct, indirect or consecutive damages arising from the LEDiL products being used outside of the recommended temperature range.

MATERIALS:

As part of our continuous research and improvement processes, and to ensure the best possible quality and availability of our products, LEDiL reserves the right to change material grades without notice.

PRODUCT DATA USER AGREEMENT AND DISCLAIMER:

The measured data in the provided downloadable LEDiL Product Datasheets and Mechanical 2D-Drawings is rounded and provided as reference for planning. LEDiL Oy's optical specifications have been verified by conducting performance testing of the products in accordance with the company's quality system. The reported data are averaged results of multiple measurements with typical variation. LEDiL Oy reserves the right to without prior notification make changes and improvements to its products.

LEDiL Oy assumes neither warranty, nor guarantee nor any other liability of any kind for the contents and correctness of the provided data. The provided data has been generated with highest diligence but the provided data may in reality not represent the complete possible variation range of all intrinsic parameters. Therefore, in certain cases a deviation from the provided data could occur.

LEDiL Oy reserves the right to undertake technical changes of its products without further notification which could lead to changes in the provided data. LEDiL Oy assumes no liability of any kind for the possible deviation from any provided data or any other damage resulting from the usage of the provided data.

The user agrees to this disclaimer and user agreement with the download or usage of the provided files.

LEDiL Oy

Joensuunkatu 13
FI-24240 SALO
Finland

LEDiL Inc.

228 West Page Street
Suite D
Sycamore IL 60178
USA

Local sales and technical support

[www.ledil.com/
where_to_buy](http://www.ledil.com/where_to_buy)

Shipping locations

Salo, Finland
Hong Kong, China

Distribution Partners

[www.ledil.com/
where_to_buy](http://www.ledil.com/where_to_buy)

Компания «Океан Электроники» предлагает заключение долгосрочных отношений при поставках импортных электронных компонентов на взаимовыгодных условиях!

Наши преимущества:

- Поставка оригинальных импортных электронных компонентов напрямую с производств Америки, Европы и Азии, а так же с крупнейших складов мира;
- Широкая линейка поставок активных и пассивных импортных электронных компонентов (более 30 млн. наименований);
- Поставка сложных, дефицитных, либо снятых с производства позиций;
- Оперативные сроки поставки под заказ (от 5 рабочих дней);
- Экспресс доставка в любую точку России;
- Помощь Конструкторского Отдела и консультации квалифицированных инженеров;
- Техническая поддержка проекта, помощь в подборе аналогов, поставка прототипов;
- Поставка электронных компонентов под контролем ВП;
- Система менеджмента качества сертифицирована по Международному стандарту ISO 9001;
- При необходимости вся продукция военного и аэрокосмического назначения проходит испытания и сертификацию в лаборатории (по согласованию с заказчиком);
- Поставка специализированных компонентов военного и аэрокосмического уровня качества (Xilinx, Altera, Analog Devices, Intersil, Interpoint, Microsemi, Actel, Aeroflex, Peregrine, VPT, Syfer, Eurofarad, Texas Instruments, MS Kennedy, Miteq, Cobham, E2V, MA-COM, Hittite, Mini-Circuits, General Dynamics и др.);

Компания «Океан Электроники» является официальным дистрибьютором и эксклюзивным представителем в России одного из крупнейших производителей разъемов военного и аэрокосмического назначения «JONHON», а так же официальным дистрибьютором и эксклюзивным представителем в России производителя высокотехнологичных и надежных решений для передачи СВЧ сигналов «FORSTAR».



JONHON

«JONHON» (основан в 1970 г.)

Разъемы специального, военного и аэрокосмического назначения:

(Применяются в военной, авиационной, аэрокосмической, морской, железнодорожной, горно- и нефтедобывающей отраслях промышленности)

«FORSTAR» (основан в 1998 г.)

ВЧ соединители, коаксиальные кабели, кабельные сборки и микроволновые компоненты:

(Применяются в телекоммуникациях гражданского и специального назначения, в средствах связи, РЛС, а так же военной, авиационной и аэрокосмической отраслях промышленности).



Телефон: 8 (812) 309-75-97 (многоканальный)

Факс: 8 (812) 320-03-32

Электронная почта: ocean@oceanchips.ru

Web: <http://oceanchips.ru/>

Адрес: 198099, г. Санкт-Петербург, ул. Калинина, д. 2, корп. 4, лит. А