

## 50 $\Omega$ ultra thin balun with integrated harmonic filter / conjugate match balun to nRF51822-CTAA/CTAC in WLCSP

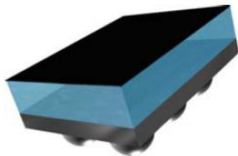

Flip-Chip (5 bumps) package

Pin coordinates

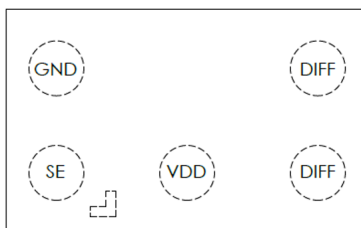

Top view

**Product status**

BALF-NRF01J5

### Features

- 50  $\Omega$  nominal input / conjugate match to Nordic Semiconductor chips nRF51822 WLCSP
- Low insertion loss
- Low amplitude imbalance
- Low phase imbalance
- Small footprint: < 1.2 mm<sup>2</sup>
- Extra low profile < 350  $\mu$ m after reflow
- High RF performance
- RF BOM and area reduction

### Applications

- 2.45 GHz impedance matched balun filter
- Optimized for Nordic's chip set nRF51822-CTAA, CTAC
- Wearable applications

### Description

This device is an ultraminiature extra thin balun that integrates matching network and harmonics filter.

Matching impedance has been customized for the nRF51822-CTAA and CTAC WLCSP Nordic Semiconductor circuits.

Based on IPD technology on high resistivity silicium it optimizes the RF performance.

The BALF-NRF01J5 has been tested and approved by Nordic Semiconductor.

STMicroelectronics qualified this product intended to be used in System in Package module based on standard reliability procedure. For more details, please contact ST representatives.

It is the responsibility of the customer to perform qualification reliability verifications as it is related to customer specific application / mission profile and module design / process.

# 1 Characteristics

**Table 1. Absolute ratings (limiting values)**

Symbol	Parameter	Value			Unit
		Min.	Typ.	Max.	
$P_{IN}$	Input power $RF_{IN}$		-	20	dBm
$V_{ESD}$	ESD ratings human body model (JESD22-A114-C), all I/O one at a time while others connected to GND	2000	-		V
	ESD ratings charge device model (JESD22-C101-C)	500	-		
	ESD ratings machine model, all I/O	200	-		
$T_{OP}$	Operating temperature	-40	-	+85	°C

**Table 2. Impedances ( $T_{amb} = 25\text{ °C}$ )**

Symbol	Parameter	Value			Unit
		Min.	Typ.	Max.	
$Z_{OUT}$	Nominal differential output impedance	-	matched	-	$\Omega$
$Z_{IN}$	Nominal input impedance	-	50	-	$\Omega$

**Table 3. RF performances ( $T_{amb} = 25\text{ °C}$ )**

Symbol	Parameter	Value			Unit
		Min.	Typ.	Max.	
f	Frequency range (bandwidth)	2400		2540	MHz
$I_L$	Insertion loss in bandwidth		2.2	2.4	dB
$R_L$	Return loss in bandwidth	9	12		dB
$\phi_{imb}$	Phase imbalance	-7.2	7	7.2	°
Aimb	Amplitude imbalance	-0.5	0.3	0.5	dB
2f0	2nd harmonic S21 attenuation		12	13.5	dB
3f0	3rd harmonic S21 attenuation		24	25	dB

## 1.1 On-board measurements

**Figure 1. Transmission ( $T_{amb} = 25\text{ °C}$ )**

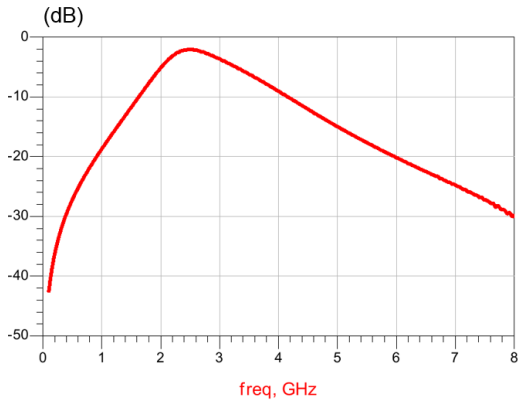

**Figure 2. Insertion loss ( $T_{amb} = 25\text{ °C}$ )**

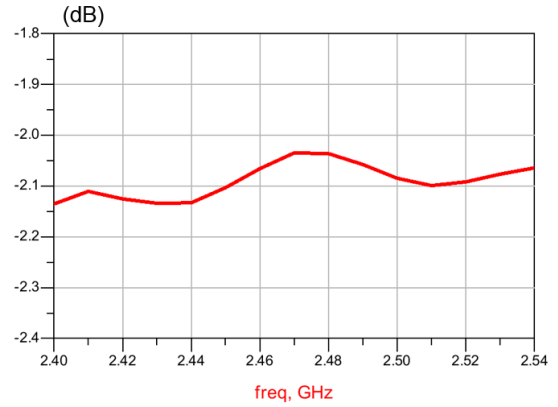

**Figure 3. Return loss on SE port ( $T_{amb} = 25\text{ °C}$ )**

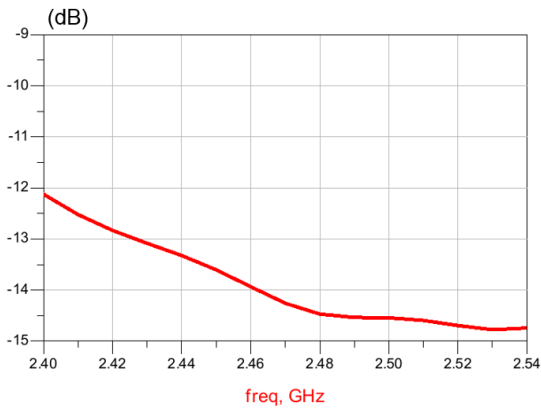

**Figure 4. Return loss on DIFF port ( $T_{amb} = 25\text{ °C}$ )**

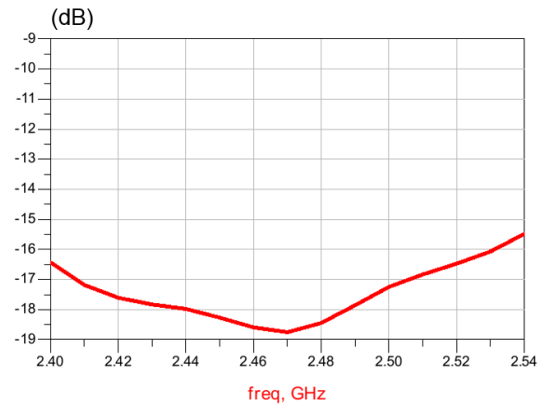

**Figure 5. Amplitude imbalance ( $T_{amb} = 25\text{ °C}$ )**

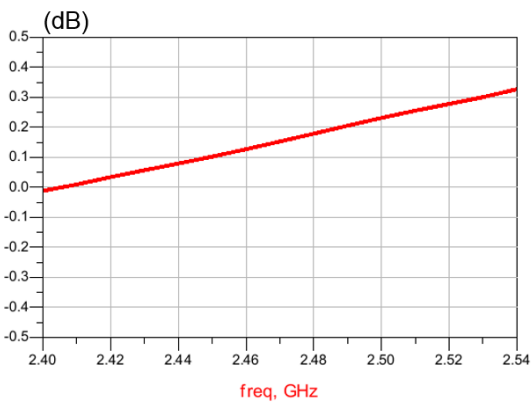

**Figure 6. Phase imbalance ( $T_{amb} = 25\text{ °C}$ )**

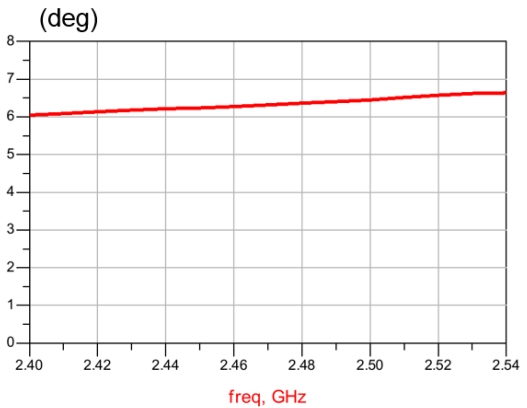

## 2 Package information

In order to meet environmental requirements, ST offers these devices in different grades of ECOPACK® packages, depending on their level of environmental compliance. ECOPACK® specifications, grade definitions and product status are available at: [www.st.com](http://www.st.com). ECOPACK® is an ST trademark.

### 2.1 Ultra thin Flip-Chip 5 bumps package information

- Epoxy meets UL94, V0
- Lead-free package

**Figure 7. Ultra thin Flip-Chip 5 bumps package outline**

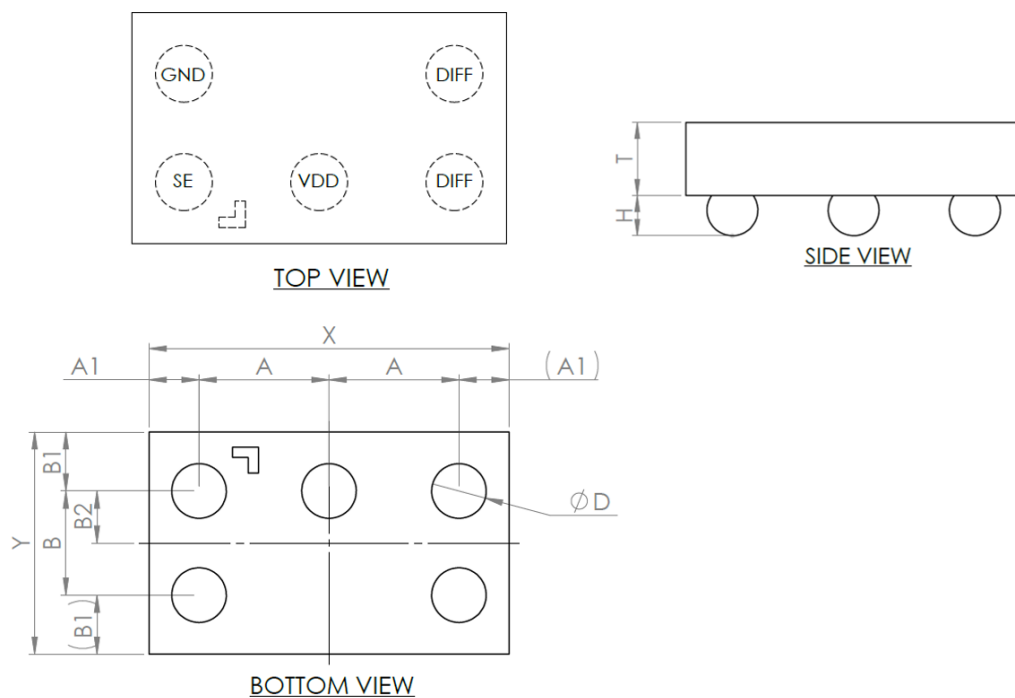

**Table 4. Ultra thin Flip-Chip 5 bumps package mechanical data**

Parameter	Description	Min.	Typ.	Max.	Unit
X	X dimension of the die	1315	1345	1375	µm
Y	Y dimension of the die	785	815	845	
A	X pitch		500		
B	Y pitch		400		
A1	Distance from bump to edge of die on X axis		172.5		
B1	Distance from bump to edge of die on Y axis		207.5		
B2	Distance from bump to center of die on Y axis		200		
D	Bump diameter	202	227	252	
T	Substrate thickness	190	200	210	
H	Bump height	117	142	167	

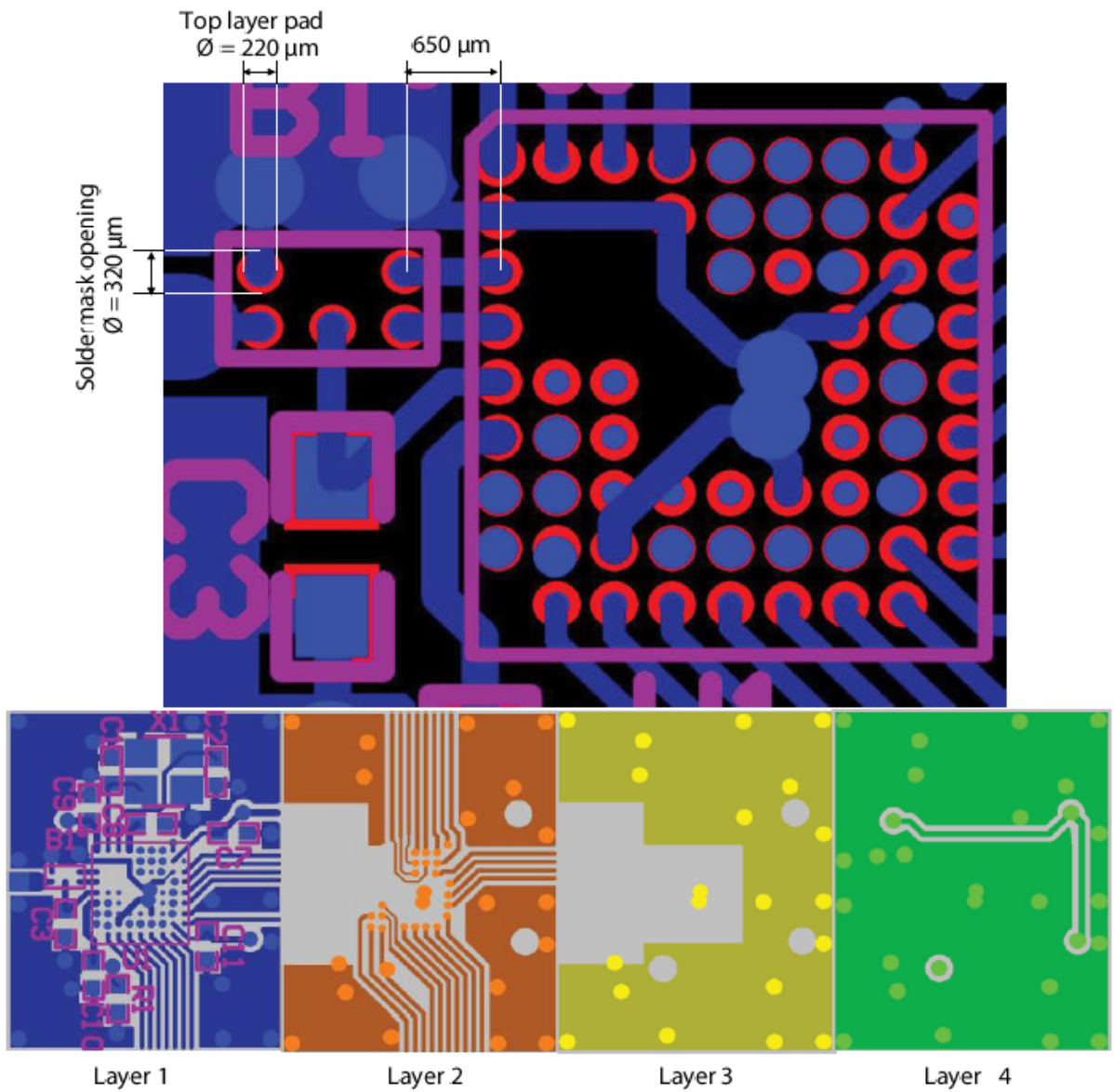
**Figure 8. Recommended land pattern**

*Note:* Screenprinting, stencil windows 290 x 290 x 100  $\mu\text{m}^3$  (coeff 0.725)

*Note:* to achieve minimum component height after PCB reflow, the below recommendations must be followed : in assembly process, a flux must be used, not a solder paste

Figure 9. PCB stack-up recommendation

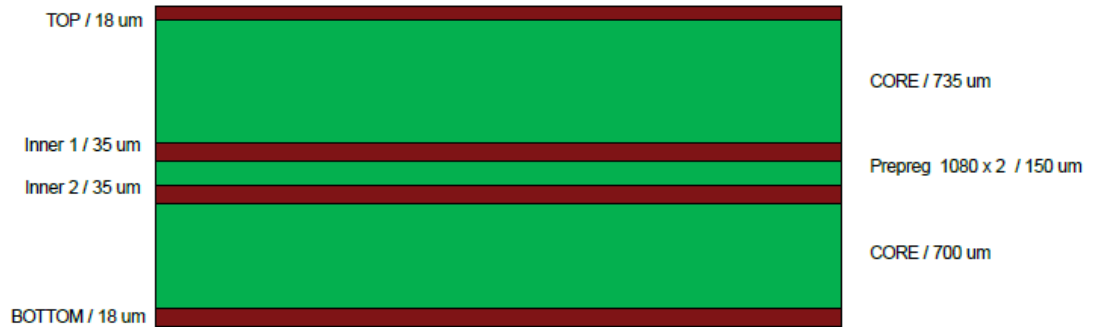

## 2.2 Flip-chip 5 bumps packing information

Figure 10. Marking

Dot, ST logo  
 □ ECOPACK grade  
 xx = marking  
 z = manufacturing location  
 yww = datecode

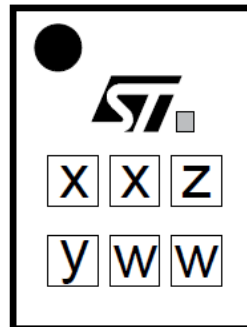

Note: More packing information is available in the application note:

- AN2348 Flip-Chip: "Package description and recommendations for use"

Figure 11. Footprint - non solder mask defined

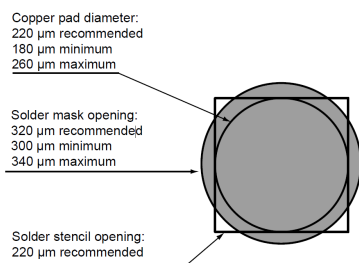
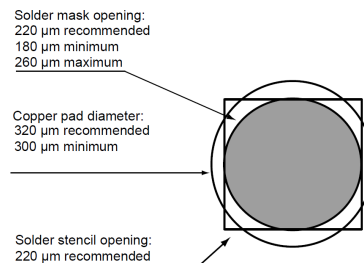

Figure 12. Footprint - solder mask defined



### 3 Ordering information

**Table 5. Ordering information**

Order code	Marking	Package	Weight	Base qty.	Delivery mode
BALF-NRF01J5	TL	Flip-Chip 5 bumps	0.631 mg	5000	Tape and reel

## Revision history

**Table 6. Document revision history**

Date	Revision	Changes
20-Jun-2017	1	Initial release.
22-Feb-2018	2	Updated Description and Table 4. Ultra thin Flip-Chip 5 bumps package mechanical data.
04-Apr-018	3	Updated <a href="#">Table 4. Ultra thin Flip-Chip 5 bumps package mechanical data.</a>



**IMPORTANT NOTICE – PLEASE READ CAREFULLY**

STMicroelectronics NV and its subsidiaries (“ST”) reserve the right to make changes, corrections, enhancements, modifications, and improvements to ST products and/or to this document at any time without notice. Purchasers should obtain the latest relevant information on ST products before placing orders. ST products are sold pursuant to ST’s terms and conditions of sale in place at the time of order acknowledgement.

Purchasers are solely responsible for the choice, selection, and use of ST products and ST assumes no liability for application assistance or the design of Purchasers’ products.

No license, express or implied, to any intellectual property right is granted by ST herein.

Resale of ST products with provisions different from the information set forth herein shall void any warranty granted by ST for such product.

ST and the ST logo are trademarks of ST. All other product or service names are the property of their respective owners.

Information in this document supersedes and replaces information previously supplied in any prior versions of this document.

© 2018 STMicroelectronics – All rights reserved

Компания «Океан Электроники» предлагает заключение долгосрочных отношений при поставках импортных электронных компонентов на взаимовыгодных условиях!

Наши преимущества:

- Поставка оригинальных импортных электронных компонентов напрямую с производств Америки, Европы и Азии, а так же с крупнейших складов мира;
- Широкая линейка поставок активных и пассивных импортных электронных компонентов (более 30 млн. наименований);
- Поставка сложных, дефицитных, либо снятых с производства позиций;
- Оперативные сроки поставки под заказ (от 5 рабочих дней);
- Экспресс доставка в любую точку России;
- Помощь Конструкторского Отдела и консультации квалифицированных инженеров;
- Техническая поддержка проекта, помощь в подборе аналогов, поставка прототипов;
- Поставка электронных компонентов под контролем ВП;
- Система менеджмента качества сертифицирована по Международному стандарту ISO 9001;
- При необходимости вся продукция военного и аэрокосмического назначения проходит испытания и сертификацию в лаборатории (по согласованию с заказчиком);
- Поставка специализированных компонентов военного и аэрокосмического уровня качества (Xilinx, Altera, Analog Devices, Intersil, Interpoint, Microsemi, Actel, Aeroflex, Peregrine, VPT, Syfer, Eurofarad, Texas Instruments, MS Kennedy, Miteq, Cobham, E2V, MA-COM, Hittite, Mini-Circuits, General Dynamics и др.);

Компания «Океан Электроники» является официальным дистрибьютором и эксклюзивным представителем в России одного из крупнейших производителей разъемов военного и аэрокосмического назначения «JONHON», а так же официальным дистрибьютором и эксклюзивным представителем в России производителя высокотехнологичных и надежных решений для передачи СВЧ сигналов «FORSTAR».



## JONHON

«JONHON» (основан в 1970 г.)

Разъемы специального, военного и аэрокосмического назначения:

(Применяются в военной, авиационной, аэрокосмической, морской, железнодорожной, горно- и нефтедобывающей отраслях промышленности)

«FORSTAR» (основан в 1998 г.)

ВЧ соединители, коаксиальные кабели, кабельные сборки и микроволновые компоненты:

(Применяются в телекоммуникациях гражданского и специального назначения, в средствах связи, РЛС, а так же военной, авиационной и аэрокосмической отраслях промышленности).



Телефон: 8 (812) 309-75-97 (многоканальный)

Факс: 8 (812) 320-03-32

Электронная почта: [ocean@oceanchips.ru](mailto:ocean@oceanchips.ru)

Web: <http://oceanchips.ru/>

Адрес: 198099, г. Санкт-Петербург, ул. Калинина, д. 2, корп. 4, лит. А