

LOC		DIST		REVISIONS			
P	LTN	DESCRIPTION	DATE	DWN	APVD		
	H4	ADDED DASH NUMBER -33	25FEB2013	CZ	SZ		

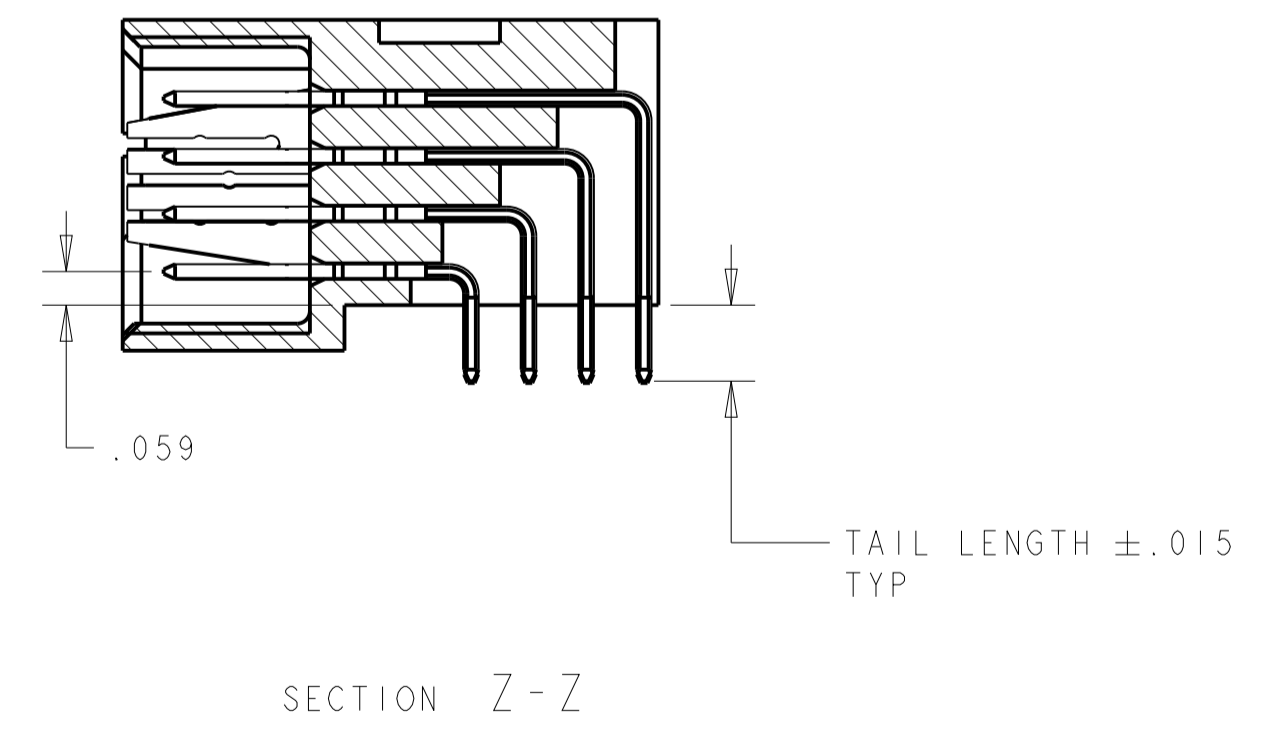
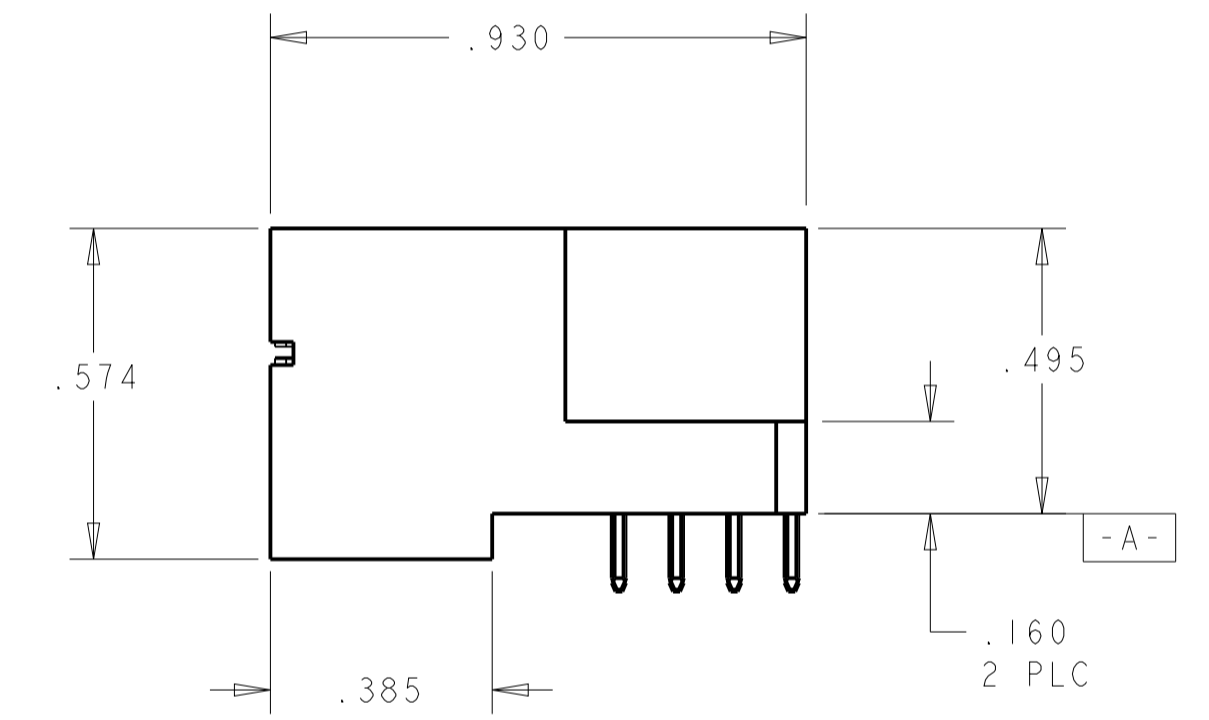
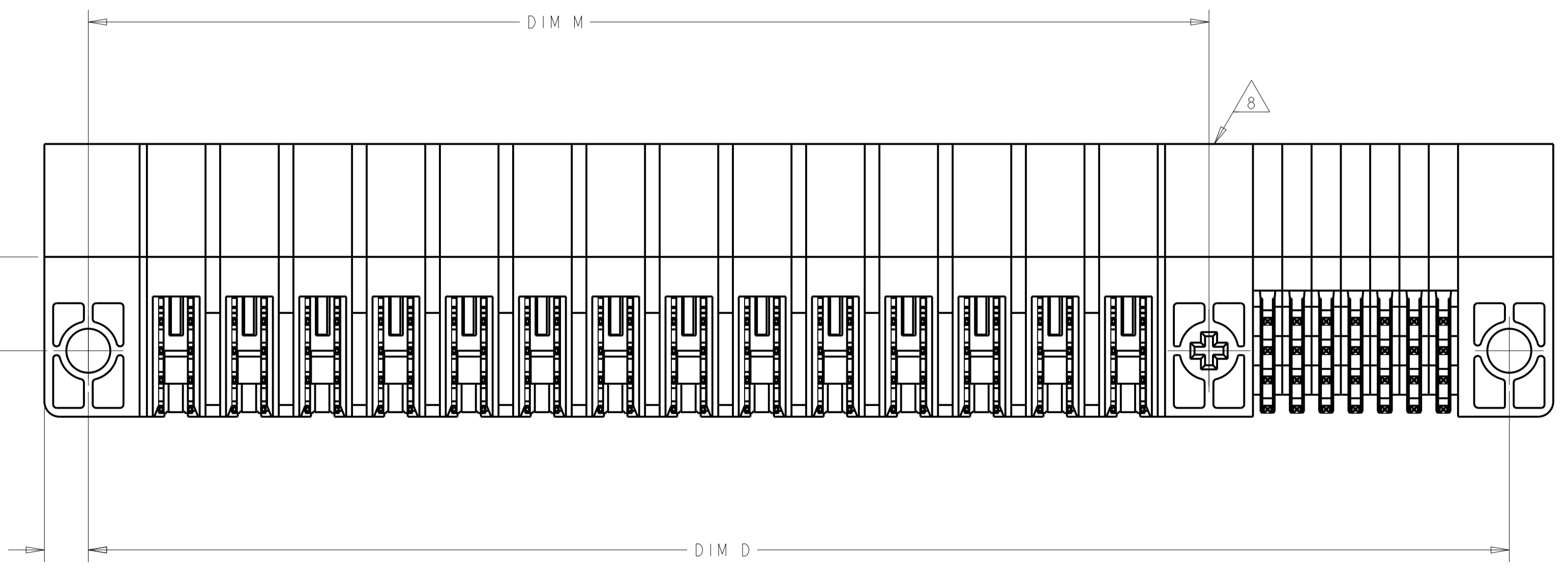
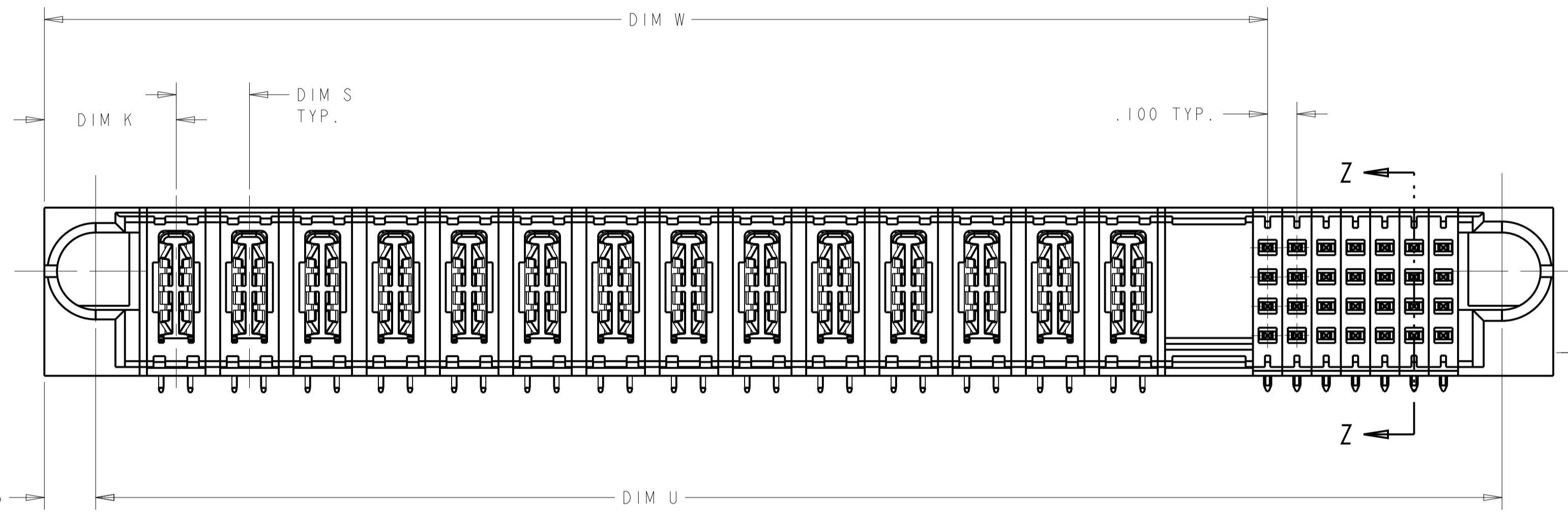
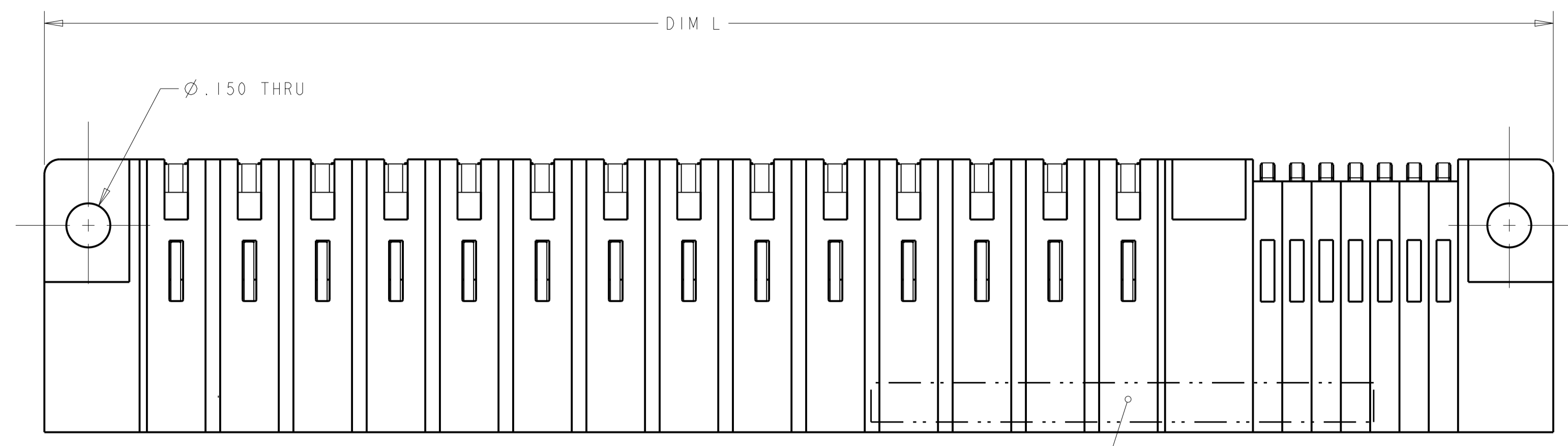

THIS DRAWING IS A CONTROLLED DOCUMENT.		DWN R. GRZYBOWSKI CHK M. PERCHERKE	24JAN05	TE Connectivity RIGHT ANGLE SOLDER HEADER ASSEMBLY MULTI-BEAM XL	
DIMENSIONS: INCHES		TOLERANCES UNLESS OTHERWISE SPECIFIED:			
0 PLC $\pm .01$ 1 PLC $\pm .01$ 2 PLC $\pm .01$ 3 PLC $\pm .005$ 4 PLC $\pm .002$ ANGLES $\pm .020$		0 PLC $\pm .01$ 1 PLC $\pm .01$ 2 PLC $\pm .01$ 3 PLC $\pm .005$ 4 PLC $\pm .002$ ANGLES $\pm .020$		PRODUCT SPEC	108-1973
MATERIAL		FINISH		APPLICATION SPEC	114-13038
				WEIGHT	1.14-13038
CUSTOMER DRAWING		SCALE		SIZE	A100779C=6450332
		4:1		RESTRICTED TO	
		SHEET		REV	H6
		13		OF	13

LOC	DIST	REVISIONS			
		REV	DATE	BY	APPD
ES	00				

- 1 "AMP", PART NUMBER, AND DATECODE TO BE MARKED IN AREA SHOWN.
- 2 MATERIAL: HOUSING - GLASS FILLED HIGH TEMP THERMO PLASTIC, UL94 V-0
SIGNAL CONTACT - COPPER ALLOY
POWER CONTACT - HIGH CONDUCTIVITY COPPER ALLOY
- 3 CONTACT PLATING: NOBLE METAL PLATING ON CONTACT FUNCTIONAL AREA OF POWER AND SIGNAL CONTACTS
- 4 MECHANICAL CONNECTOR KEEP OUT ZONE.
- 5 DATUM AND BASIC DIMENSIONS ESTABLISHED BY CUSTOMER.
- 6 PCB - HOLE DIAMETERS ARE FINISHED HOLE SIZE.
- 7 PCB - .0453±.0010 DRILLED HOLES PLATED WITH .0003 MIN Sn OVER .001 TO .003 Cu PLATING TO ACHIEVE A .040 DIAMETER HOLE.
- 8 OPTIONAL CENTER MODULE
- 9 NOT RELEASED FOR PRODUCTION
- 10 VARIABLE DIMENSIONS SHOWN ON TABLE

DIM U	DIM S	DIM W	DIM D	DIM M	DIM L	DIM K	DESCRIPTION	PART NUMBER
1.900	.250	1.375	1.950	-	2.250	.450	4P + 24S	3-6450332-4
2.825	△	2.300	2.875	-	3.175	.475	3ACP + 4P + 24S	3-6450332-3
1.600	.250	1.375	1.650	-	1.950	.450	4P + 12S	3-6450332-2
2.825	△	2.300	2.875	-	3.175	.475	3ACP + 4P + 24S	3-6450332-1
3.225	△	2.675	3.275	-	3.575	.525	9P + 24S	3-6450332-0
2.700	△	2.275	2.750	-	3.050	.450	4ACP+3P+20S	1-6450332-9
3.225	△	2.675	3.275	-	3.575	.525	3ACP+6P+24S	2-6450332-8
1.650	.200	1.225	1.700	-	2.000	.450	4P + 20S	2-6450332-6
1.800	△	1.275	1.850	-	2.150	.450	4P + 24S	2-6450332-5
2.900	.250	2.375	2.950	-	3.250	.450	8P + 24S	2-6450332-4
3.225	△	2.675	3.275	-	3.575	.525	3ACP+6P+24S	2-6450332-3
2.150	.250	1.625	2.200	-	2.500	.450	5P + 24S	2-6450332-0
3.225	△	2.675	3.275	-	3.575	.525	3ACP+6P+24S	6450332-9
3.875	△	3.550	3.925	-	4.225	.475	1ACP + 9P + 16S	1-6450332-8
2.300	.250	1.875	2.350	-	2.650	.450	6P+20S	1-6450332-7
3.875	△	3.550	3.925	-	4.225	.475	3ACP+9P+16S	1-6450332-6
5.100	△	2.375	5.150	-	5.450	.450	8P + 112S	1-6450332-4
3.800	△	3.175	3.850	-	4.150	.450	12P + 28S	1-6450332-3
2.275	△	2.050	2.325	-	2.625	.450	5P + 24S	1-6450332-2
1.400	.250	.875	1.450	-	1.750	.450	2P + 24S	6450332-8
1.100	-	.575	1.150	-	1.450	.425	1P + 24S	6450332-6
4.425	.250	3.875	4.475	-	4.775	.450	14P + 24S	6450332-5
2.675	.250	2.125	2.725	-	3.025	.450	7P + 24S	6450332-4
2.925	.250	2.375	2.975	-	3.275	.450	8P + 24S	6450332-3
4.500	.250	3.875	4.550	-	4.850	.450	14P + 28S	6450332-2

THIS DRAWING IS A CONTROLLED DOCUMENT.

OWN: R. GRZYBOWSKI 24JAN05
CHK: M. PERCHERKE 24JAN05
APPD: M. PERCHERKE

STE TE Connectivity

NAME: RIGHT ANGLE SOLDER HEADER ASSEMBLY MULTI-BEAM XL

PRODUCT SPEC: 108-1973
APPLICATION SPEC: 114-13038

SIZE: A1 CAGE CODE: 6450332 DRAWING NO: 100779

RESTRICTED TO: -

MATERIAL: - FINISH: - WEIGHT: -

CUSTOMER DRAWING SCALE: 4:1 SHEET 2 OF 13 REV: H6

LOC	DIST	REVISIONS			
ES	00	REV	DATE	BY	APPV
		1			
		2			

ASSY PART NUMBER	ROWS	POWER														SIGNAL						
		P1	P2	P3	P4	P5	P6	P7	P8	P9	P10	P11	P12	P13	P14	1	2	3	4	5	6	7
6450332-2	D C B A	PM	PM	PM	PM	PM	PM	PM	PM	PM	PM	PM	PM	PM	E	E	E	E	E	E	E	E
14P + 28S															F	F	F	F	F	F	F	F
															G	G	G	G	G	G	G	G
															S	S	S	S	S	H	H	H

PART NUMBER	ROWS	POWER								SIGNAL					
		P1	P2	P3	P4	P5	P6	P7	P8	1	2	3	4	5	6
6450332-3	D C B A	PM	PM	PM	PM	PM	PM	PM	PM	J	J	J	J	E	E
8P + 24S										K	K	K	K	F	F
										N	N	N	N	G	G
										S	S	S	S	H	H

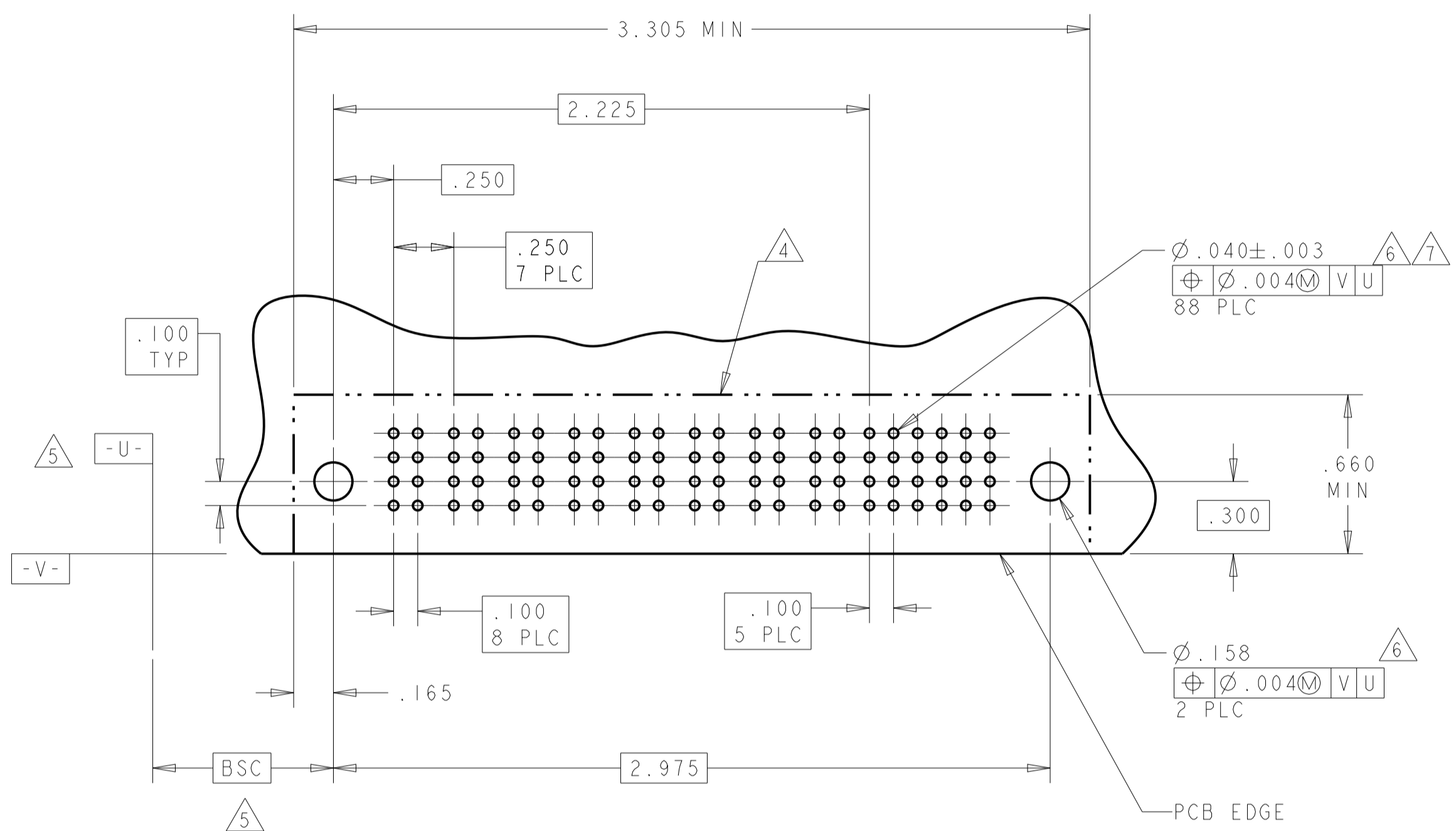
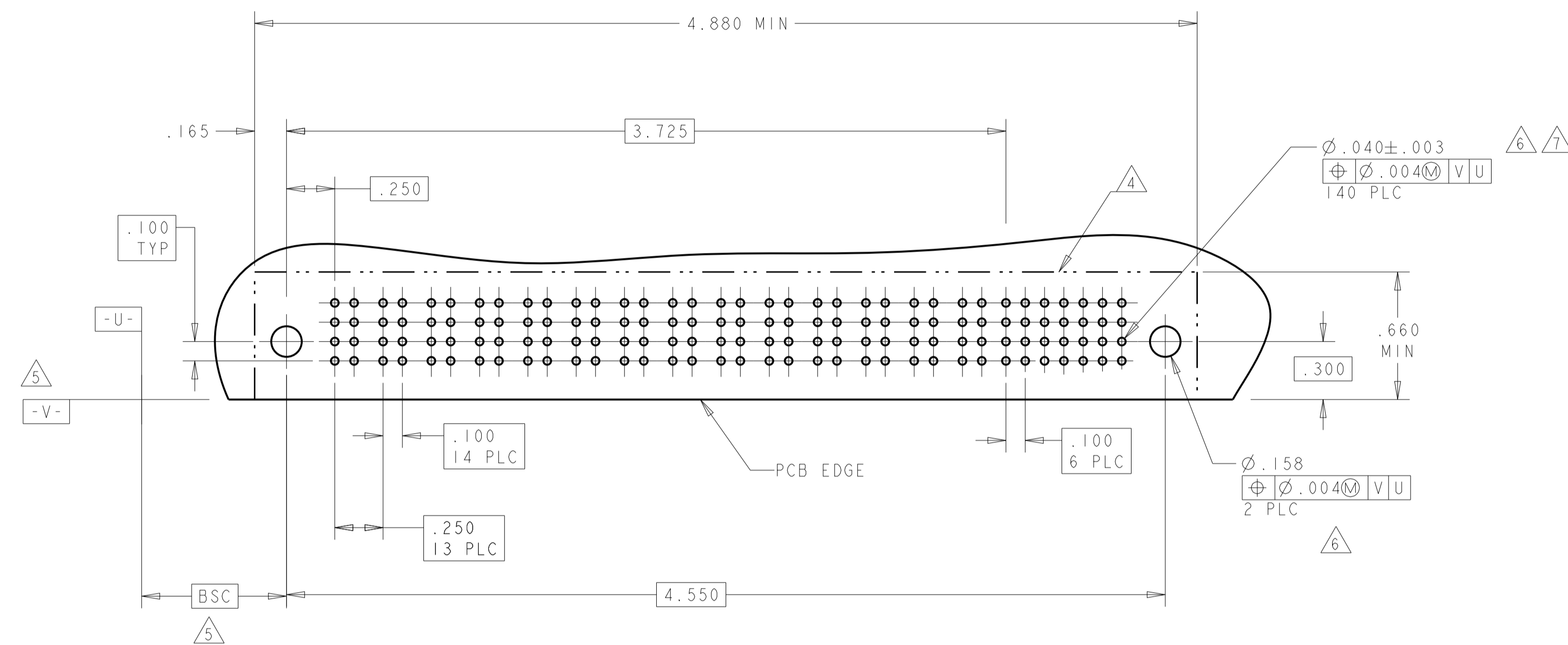

PART NUMBER	ROWS	POWER							SIGNAL					
		P1	P2	P3	P4	P5	P6	P7	1	2	3	4	5	6
6450332-4	D C B A	PM	PM	PM	PM	PM	PM	PM	J	J	E	J	J	J
7P + 24S									K	K	K	K	K	K
									N	N	N	N	N	N
									S	S	S	S	S	S

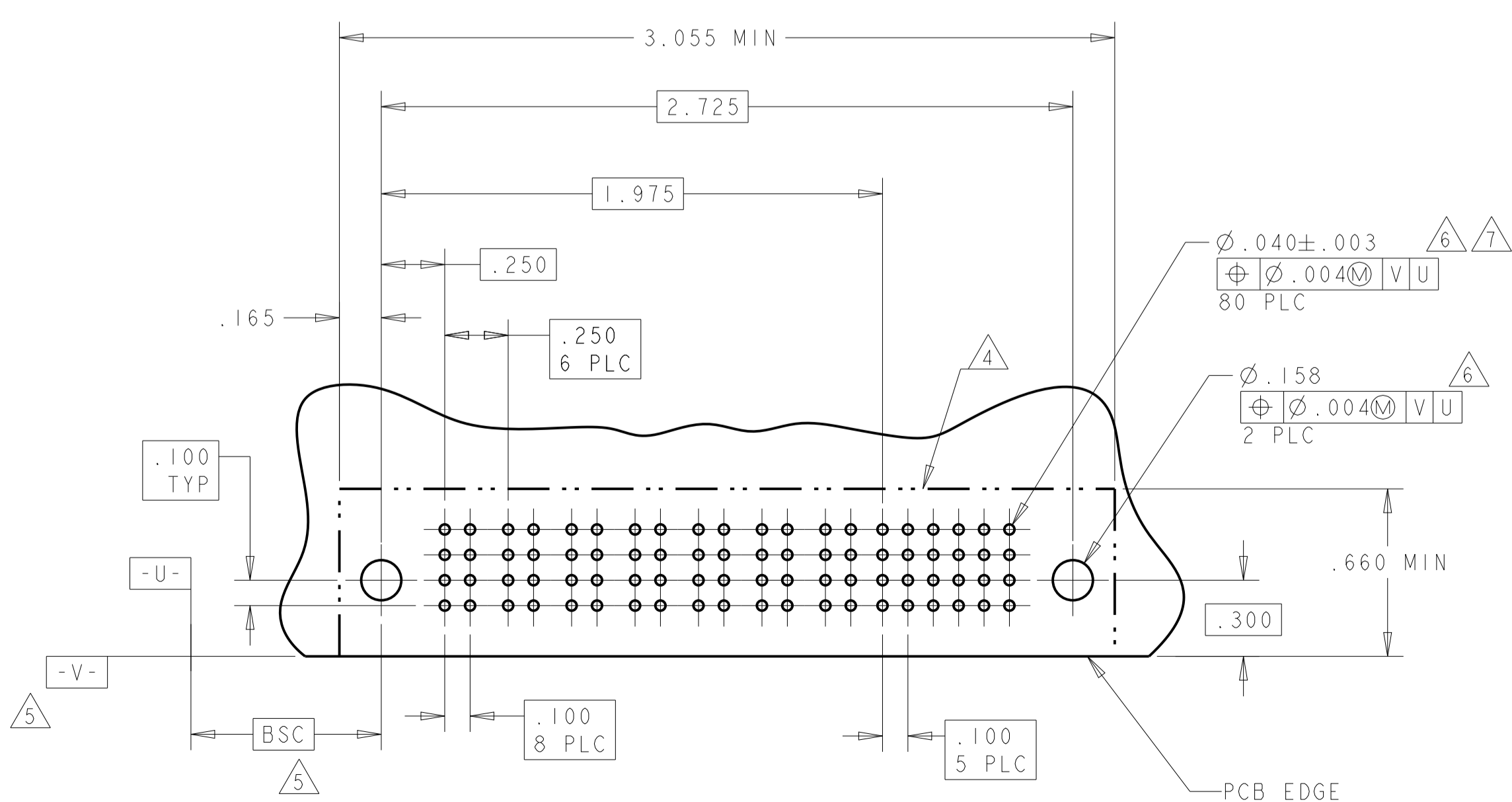

CODE	MATING SEQUENCE	TAIL LENGTH	ROW
Z	STD	.090	D
Y	STD	.090	C
R	STD	.090	B
O	STD	.090	A
A4	MLBF	.090	D
A3	MLBF	.090	C
A2	MLBF	.090	B
A1	MLBF	.090	A
E	MLBF	.135	D
F	MLBF	.135	C
G	MLBF	.135	B
H	MLBF	.135	A
J	STD	.135	D
K	STD	.135	C
N	STD	.135	B
S	STD	.135	A

CODE	TAIL LENGTH
PA	.090
PM	.135

THIS DRAWING IS A CONTROLLED DOCUMENT. **STE** TE Connectivity

APV: M. PERCHERKE
 PRODUCT SPEC: 108-1973
 APPLICATION SPEC: 114-13038
 WEIGHT: A100779
 SCALE: 4:1 SHEET 3 OF 13 REV: H6

RIGHT ANGLE SOLDER HEADER ASSEMBLY MULTI-BEAM XL

LOC	DIST	REV	DATE	BY	APPV
ES	00				

REVISIONS		DATE	BY	APPV
1	SEE SHEET 1			

PART NUMBER	ROWS	POWER														SIGNAL					
		P1	P2	P3	P4	P5	P6	P7	P8	P9	P10	P11	P12	P13	P14	1	2	3	4	5	6
6450332-5	D C B A	PM	PM	PM	PM	PM	PM	PM	PM	PM	PM	PM	PM	PM	PM	E	E	E	E	E	E
		PM	PM	PM	PM	PM	PM	PM	PM	PM	PM	PM	PM	PM	PM	F	F	F	F	F	F
		PM	PM	PM	PM	PM	PM	PM	PM	PM	PM	PM	PM	PM	PM	G	G	G	G	G	G
		PM	PM	PM	PM	PM	PM	PM	PM	PM	PM	PM	PM	PM	PM	H	H	S	S	H	H
14P + 24S																					

PART NUMBER	ROWS	POWER					SIGNAL							
		P1	P2	P3	P4	P5	1	2	3	4	5	6		
1-6450332-2	D C B A	PM	PM	PM	PM	PM								
		PM	PM	PM	PM	PM								
		PM	PM	PM	PM	PM								
		PM	PM	PM	PM	PM								
5P + 24S														

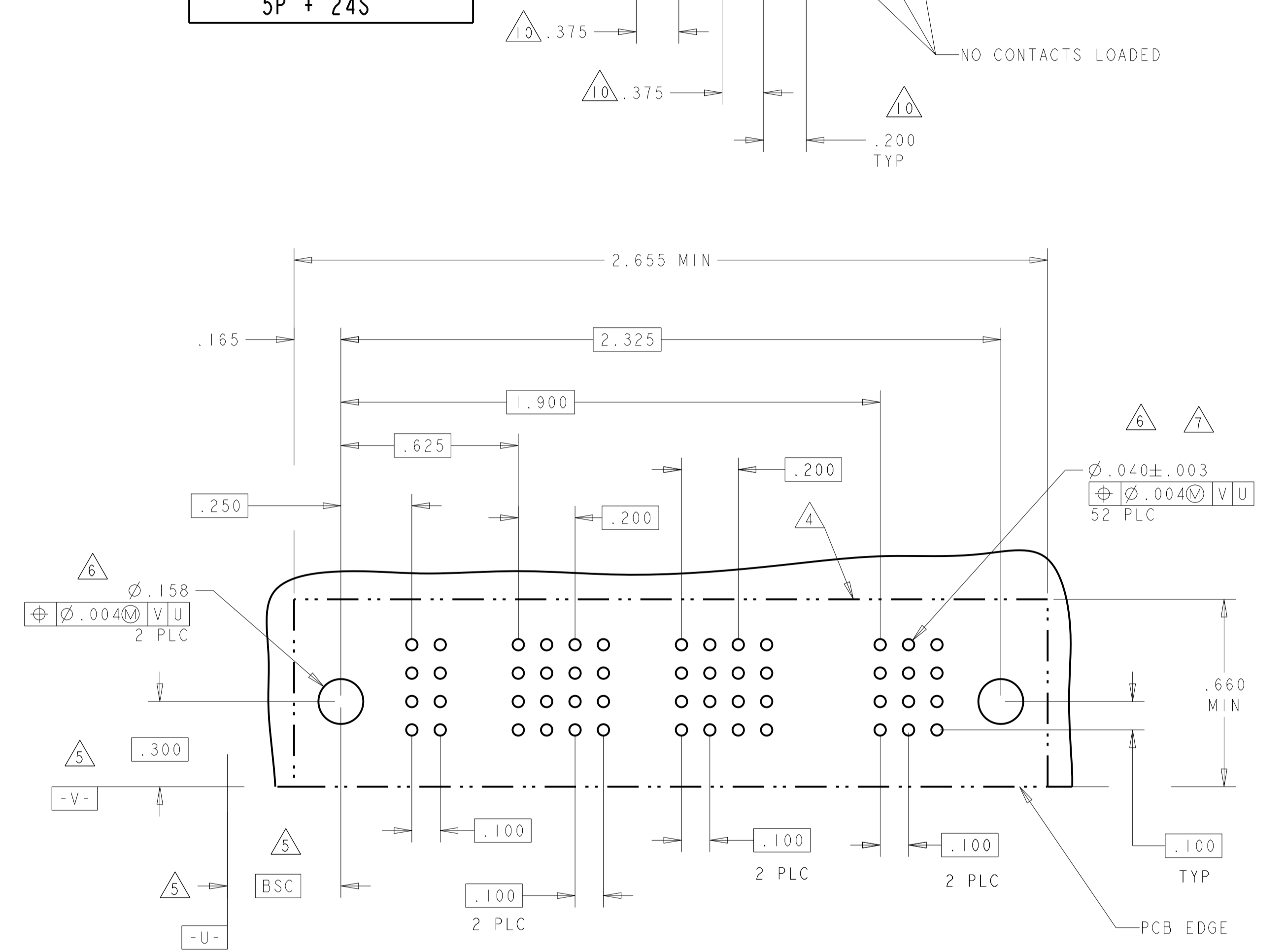
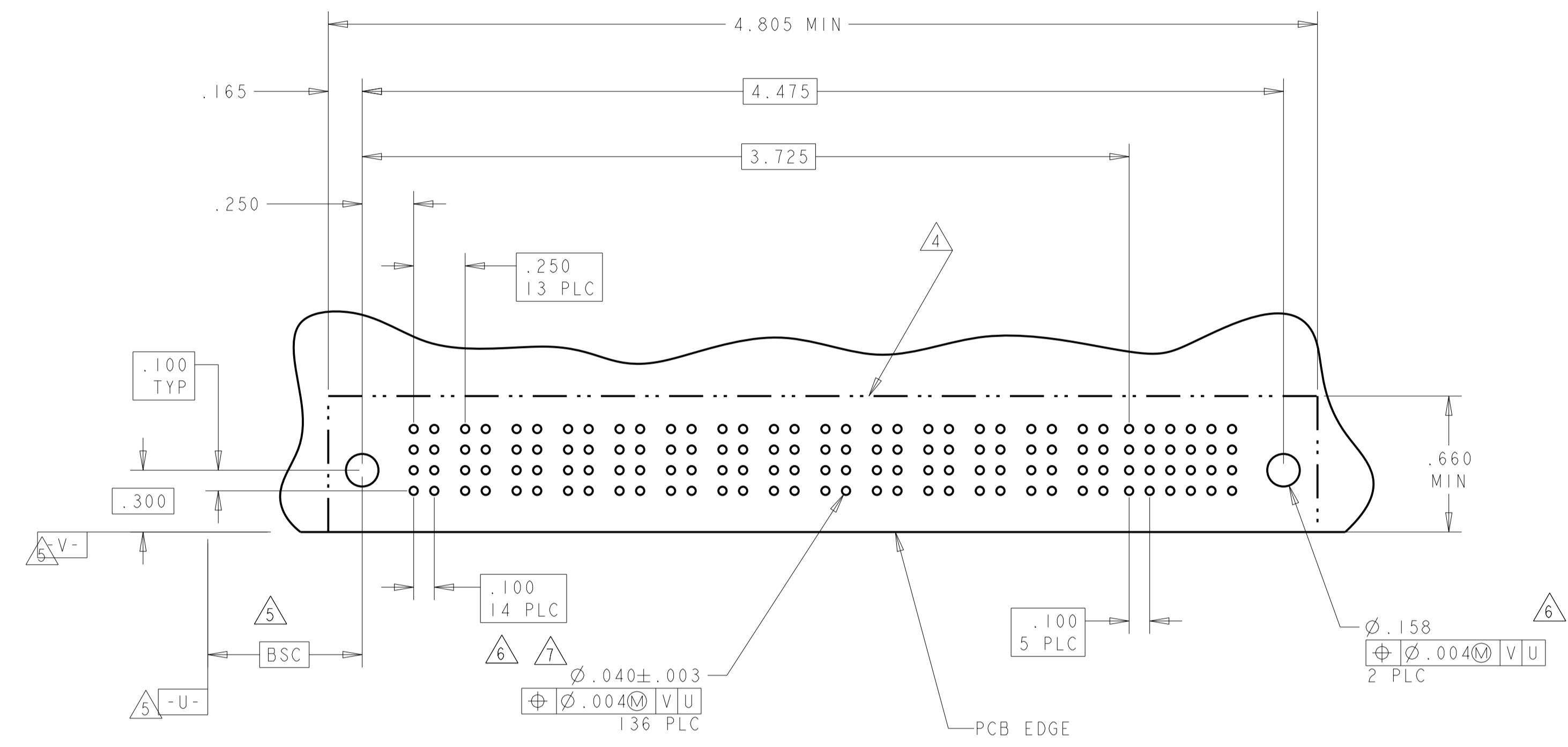

PART NUMBER	ROWS	POWER		SIGNAL					
		PI	1	2	3	4	5	6	
6450332-6	D C B A	PM	E	E	E	E	E	J	
		PM	F	F	F	F	F	F	
		PM	G	G	G	G	G	G	
		PM	H	H	H	H	H	H	
1P + 24S									

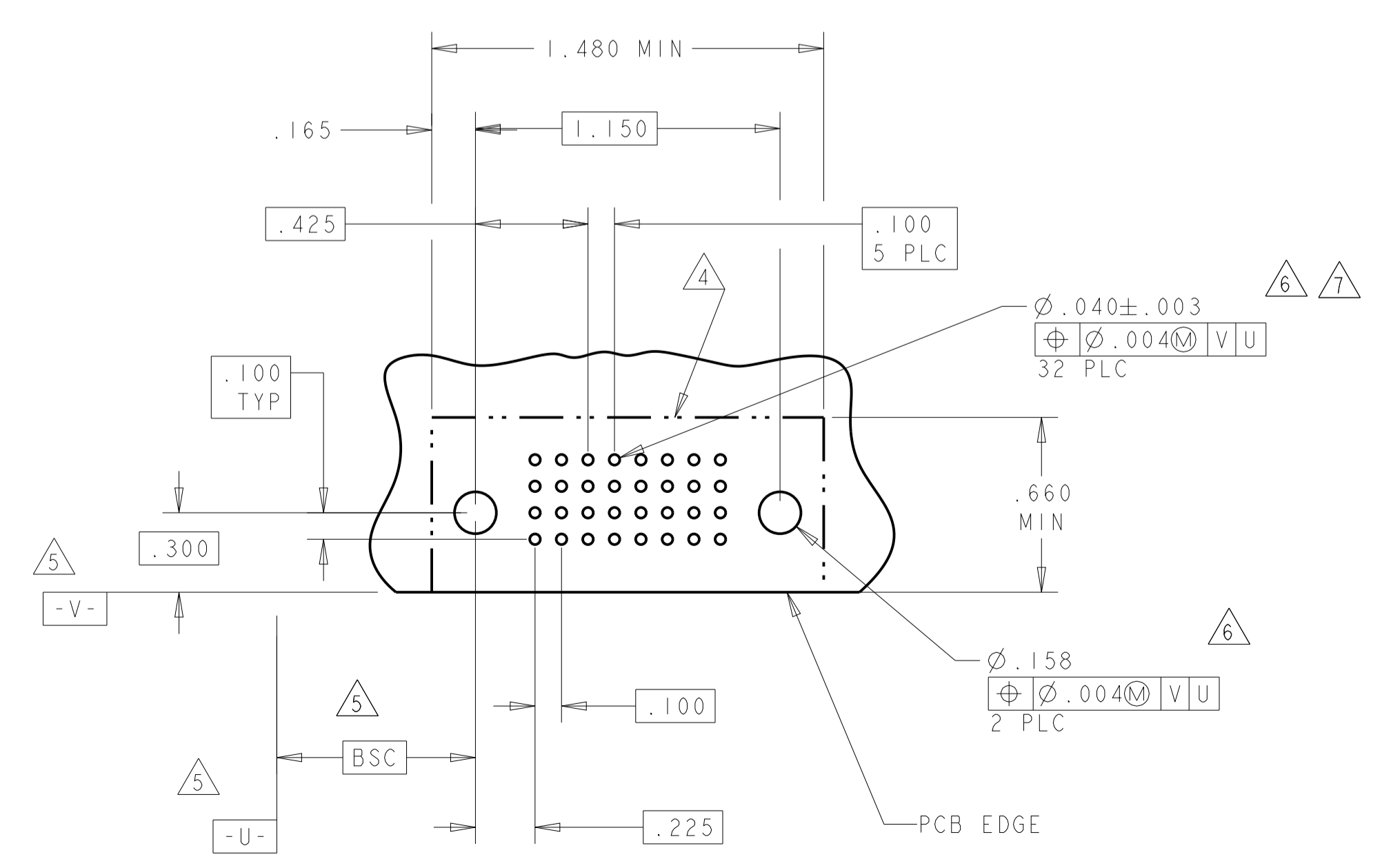

THIS DRAWING IS A CONTROLLED DOCUMENT. OWN: R. GRZYBOWSKI 24JAN05
 CHK: M. PERCHERKE 24JAN05
 APV: M. PERCHERKE

STE TE Connectivity

NAME: RIGHT ANGLE SOLDER HEADER ASSEMBLY MULTI-BEAM XL

PRODUCT SPEC: 108-1973
 APPLICATION SPEC: 114-13038

SIZE: 114-13038
 WEIGHT: -

MATERIAL: -
 FINISH: -

CUSTOMER DRAWING

SCALE: 4:1 SHEET 4 OF 13 REV: H6

LOC	DIST	REVISIONS			
		REV	DATE	BY	APPV
ES	00	1			
		SEE SHEET 1			

PART NUMBER	ROWS	POWER												SIGNAL							
		P1	P2	P3	P4	P5	P6	P7	P8	P9	P10	P11	P12	1	2	3	4	5	6	7	
1-6450332-3	D C B A													J				J	J	J	
		PM	PM	PM	PM	PM	PM	PM	PM	PM	PM	PM	PM	K				K	K	K	
															N				N	N	N
															S				S	S	S

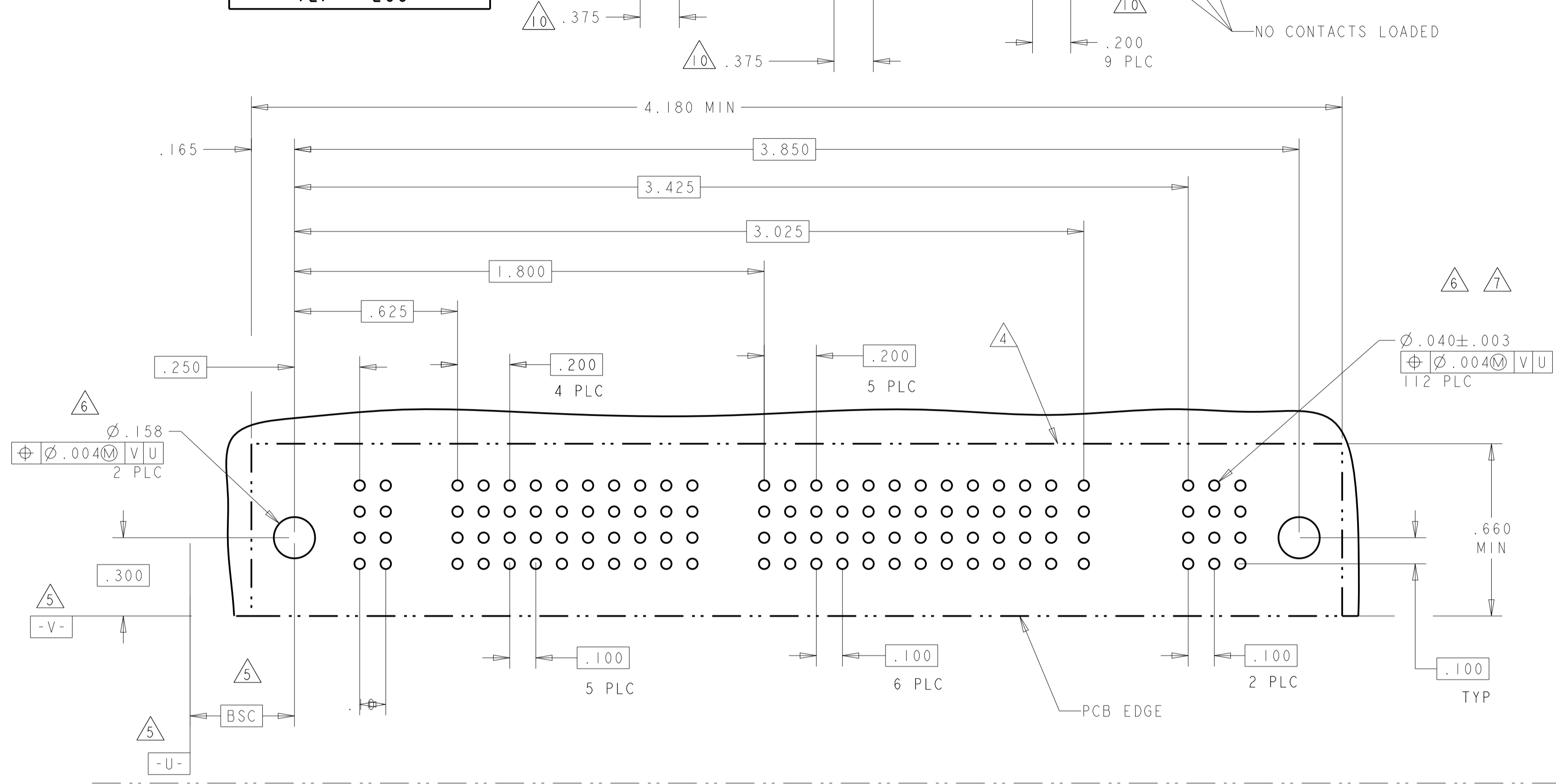

PART NUMBER	ROWS	POWER								SIGNAL																														
		P1	P2	P3	P4	P5	P6	P7	P8	1	2	3	4	5	6	7	8	9	10	11	12	13	14	15	16	17	18	19	20	21	22	23	24	25	26	27	28			
1-6450332-4	D C B A									J				J	J	J	J	J	J	J	J	J	J	J	J	J	J	J	J	J	J	J	J	J	J	J	J	J		
		PM	PM	PM	PM	PM	PM	PM	PM	K				K	K	K	K	K	K	K	K	K	K	K	K	K	K	K	K	K	K	K	K	K	K	K	K	K		
										N				N	N	N	N	N	N	N	N	N	N	N	N	N	N	N	N	N	N	N	N	N	N	N	N	N	N	N
										S				S	S	S	S	S	S	S	S	S	S	S	S	S	S	S	S	S	S	S	S	S	S	S	S	S	S	S

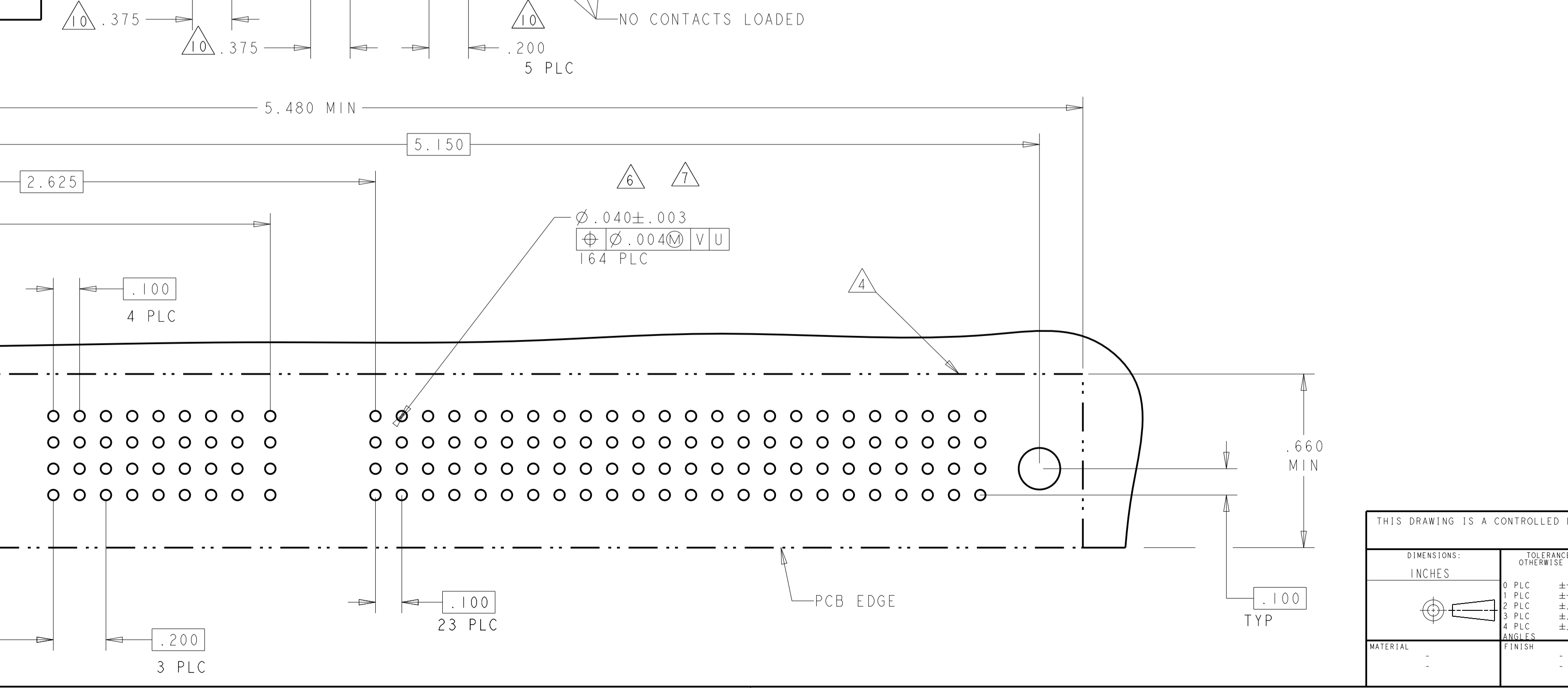

THIS DRAWING IS A CONTROLLED DOCUMENT.

OWN: R. GRZYBOWSKI 24JAN05
CHK: M. PERCHERKE 24JAN05
APPV: M. PERCHERKE

TE Connectivity
TE

NAME: RIGHT ANGLE SOLDER HEADER ASSEMBLY MULTI-BEAM XL
PRODUCT SPEC: 108-1973
APPLICATION SPEC: 114-13038
WEIGHT: -
SCALE: 4:1 SHEET 5 OF 13 REV: H6

CAGE CODE: A100779 C=6450332
CUSTOMER DRAWING

LOC		DIST		REVISIONS				
ES	00	P	LTN	DESCRIPTION	DATE	DMN	APVD	
		-		SEE SHEET 1				

PART NUMBER	ROWS	POWER												SIGNAL			
		P1	P2	P3	P4	P5	P6	P7	P8	P9	P10	P11	P12	1	2	3	4
I-6450332-6	D C B A	PM	PM	PM	PM	PM	PM	PM	PM	PM	PM	PM	PM	J	J	J	J
		PM	PM	PM	PM	PM	PM	PM	PM	PM	PM	PM	PM	K	K	K	K
		PM	PM	PM	PM	PM	PM	PM	PM	PM	PM	PM	PM	N	N	N	N
		PM	PM	PM	PM	PM	PM	PM	PM	PM	PM	PM	PM	S	S	S	H
3ACP + 9P + 16S																	

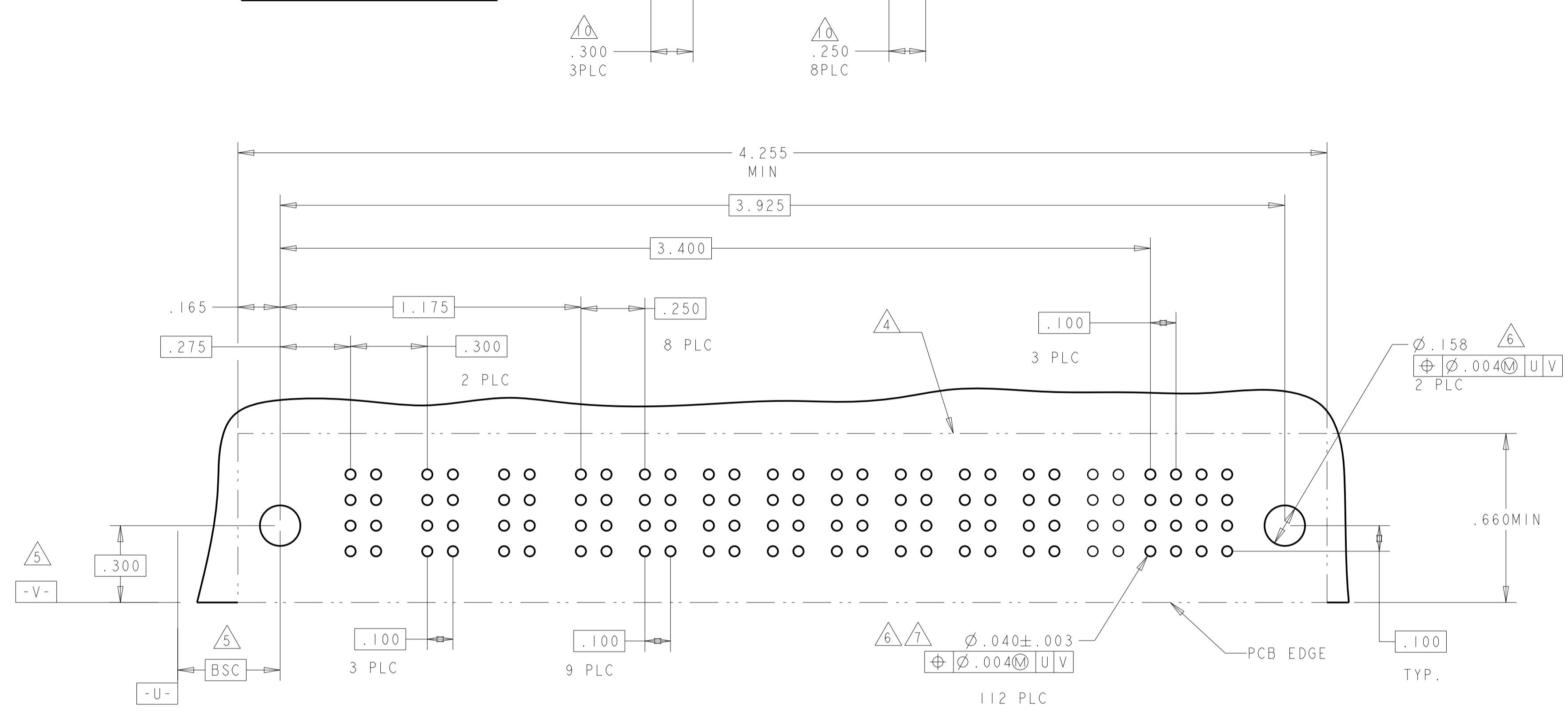

PART NUMBER	ROWS	POWER						SIGNAL				
		P1	P2	P3	P4	P5	P6	1	2	3	4	5
I-6450332-7	D C B A	PM	PM	PM	PM	PM	PM	J	J	J	J	J
		PM	PM	PM	PM	PM	PM	K	K	K	K	K
		PM	PM	PM	PM	PM	PM	N	N	N	N	N
		PM	PM	PM	PM	PM	PM	H	S	S	S	S
6P + 20S												

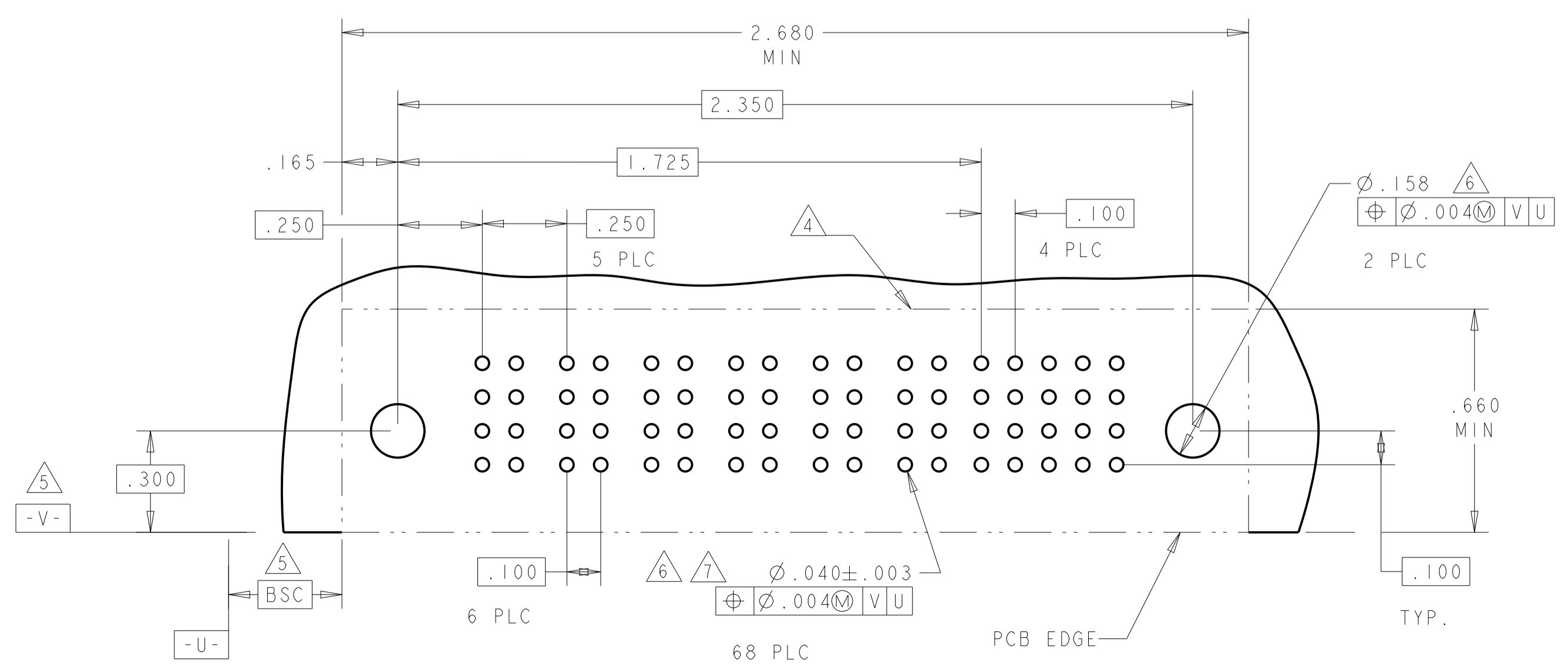

(B1) ADD SHEET 5 OF 6

THIS DRAWING IS A CONTROLLED DOCUMENT.		DMN: R. GRZYBOWSKI 24JAN05	TE Connectivity
DIMENSIONS: INCHES		CHK: M. PERCHERKE 24JAN05	
		APVD: M. PERCHERKE	NAME: RIGHT ANGLE SOLDER HEADER ASSEMBLY MULTI-BEAM XL
TOLERANCES UNLESS OTHERWISE SPECIFIED:		PRODUCT SPEC: 108-1973	SIZE: A100779
0 PLC ±.01		APPLICATION SPEC: 114-13038	CAGE CODE: 6450332
1 PLC ±.01		WEIGHT: -	RESTRICTED TO: -
2 PLC ±.01		CUSTOMER DRAWING	SCALE: 4:1
3 PLC ±.005		SCALE: 4:1	SHEET 6 OF 13
4 PLC ±.002		SCALE: 4:1	REV: H6
ANGLES ±.020			

LOC		DIST		REVISIONS				
ES	00	P	LTN	DESCRIPTION	DATE	DMN	APVD	
		-		SEE SHEET 1				

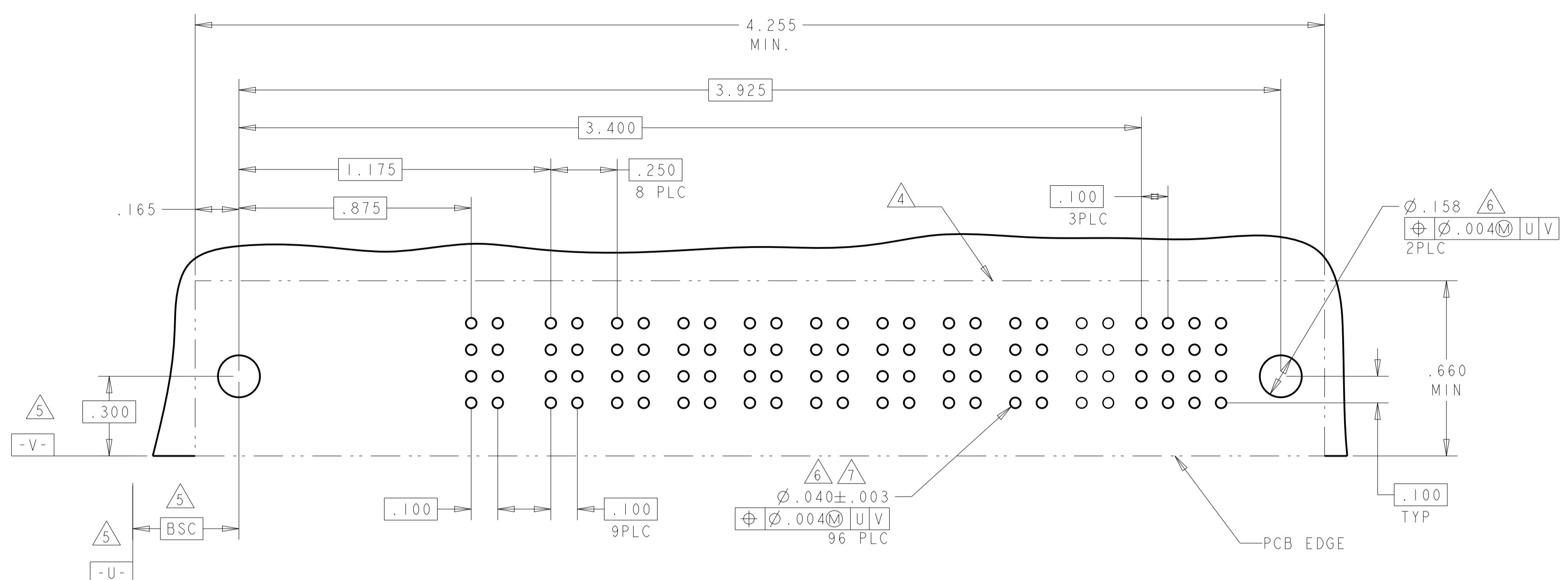

PART NUMBER	ROWS	POWER										SIGNAL					
		P1	P2	P3	P4	P5	P6	P7	P8	P9	P10	P11	P12	1	2	3	4
1-6450332-8	D													J	J	J	J
	C													K	K	K	K
	B													N	N	N	N
A														S	S	S	H
IACP + 9P + 16S																	

PART NUMBER	ROWS	POWER								SIGNAL						
		P1	P2	P3	P4	P5	P6	P7	P8	P9	1	2	3	4	5	6
6450332-9	D	PM	PM	PM	PM	PM	PM	PM	PM		J	E	J	J	J	E
	C										K	K	K	K	F	F
	B										N	N	N	N	G	G
	A										S	S	S	S	H	S
3ACP + 6P + 24S																

PART NUMBER	ROWS	POWER								SIGNAL						
		P1	P2	P3	P4	P5	P6	P7	P8	P9	1	2	3	4	5	6
2-6450332-3	D	PM	PM	PM	PM	PM	PM	PM	PM		E	E	E	E	E	E
	C										K	F	F	F	F	F
	B										N	G	G	G	G	G
	A										H	H	H	H	H	S
3ACP + 6P + 24S																

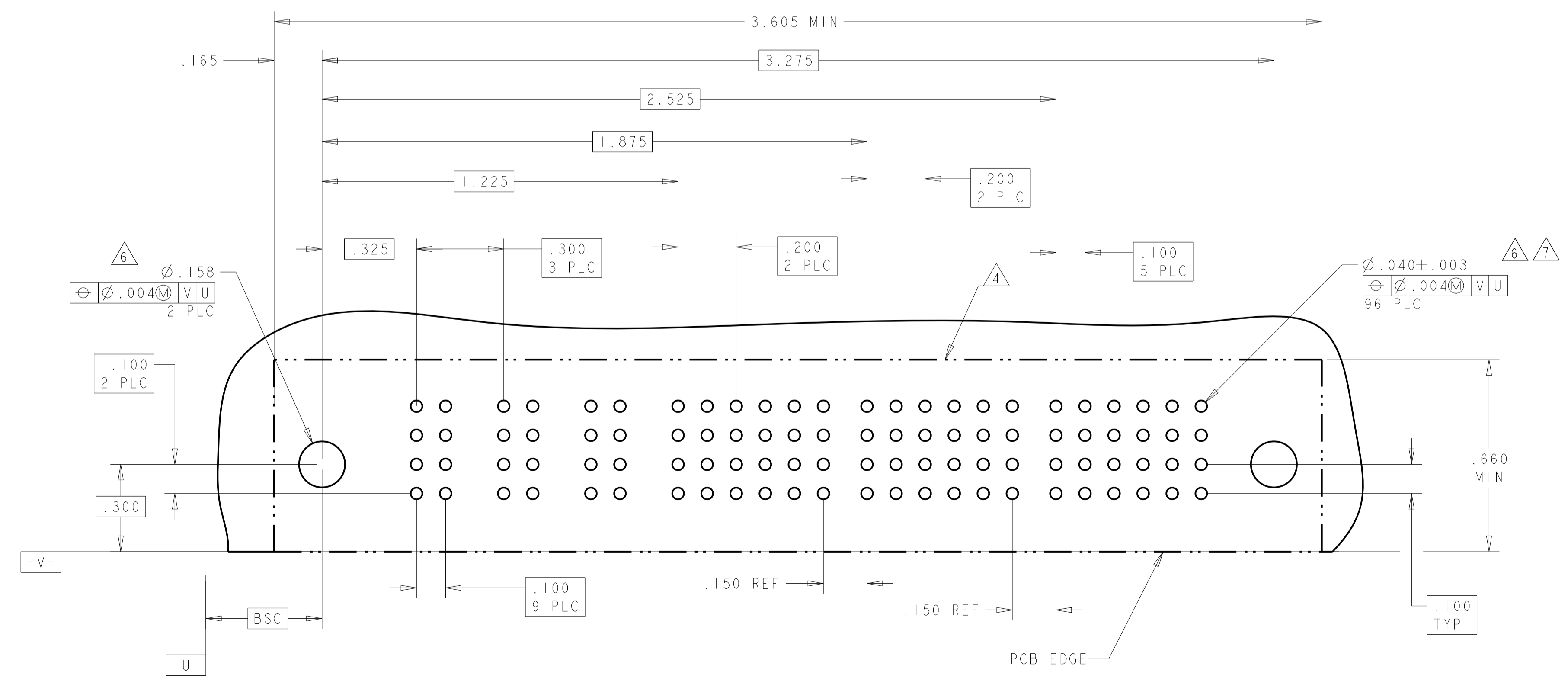
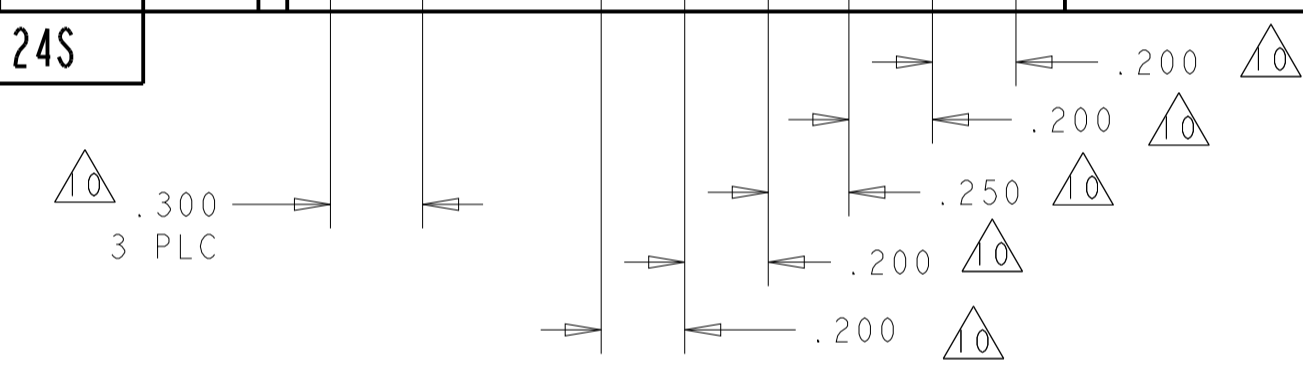

PART NUMBER 6450332-9 & 2-6450332-3 PCB LAYOUT

THIS DRAWING IS A CONTROLLED DOCUMENT.

DIMENSIONS: INCHES	TOLERANCES UNLESS OTHERWISE SPECIFIED:	OWN: R. GRZYBOWSKI 24JAN05	CHK: M. PERCHERKE 24JAN05	APVD: M. PERCHERKE	NAME: RIGHT ANGLE SOLDER HEADER ASSEMBLY MULTI-BEAM XL
MATERIAL:	FINISH:	PRODUCT SPEC: 108-1973	APPLICATION SPEC:	SIZE: 114-13038	RESTRICTED TO:
CUSTOMER DRAWING		SCALE: 4:1	SHEET: 7 OF 13	REV: H6	

LOC	DIST	REV	DATE	BY	APPV
ES	00				

REVISIONS		DATE	BY	APPV
1	SEE SHEET 1			

PART NUMBER	ROWS	POWER					SIGNAL					
		P1	P2	P3	P4	P5	1	2	3	4	5	6
2-6450332-0	D	PM	PM	PM	PM	PM	E	E	E	E	E	E
	C						K	F	F	F	F	F
	B						N	G	G	G	G	G
	A						H	H	H	H	H	S
5P + 24S												

PART NUMBER	ROWS	POWER		SIGNAL					
		P1	P2	1	2	3	4	5	6
6450332-8	D	PM	PM	J	J	J	J	J	J
	C			K	F	K	K	K	K
	B			N	N	N	N	N	N
	A			S	S	S	S	S	S
2P + 24S									

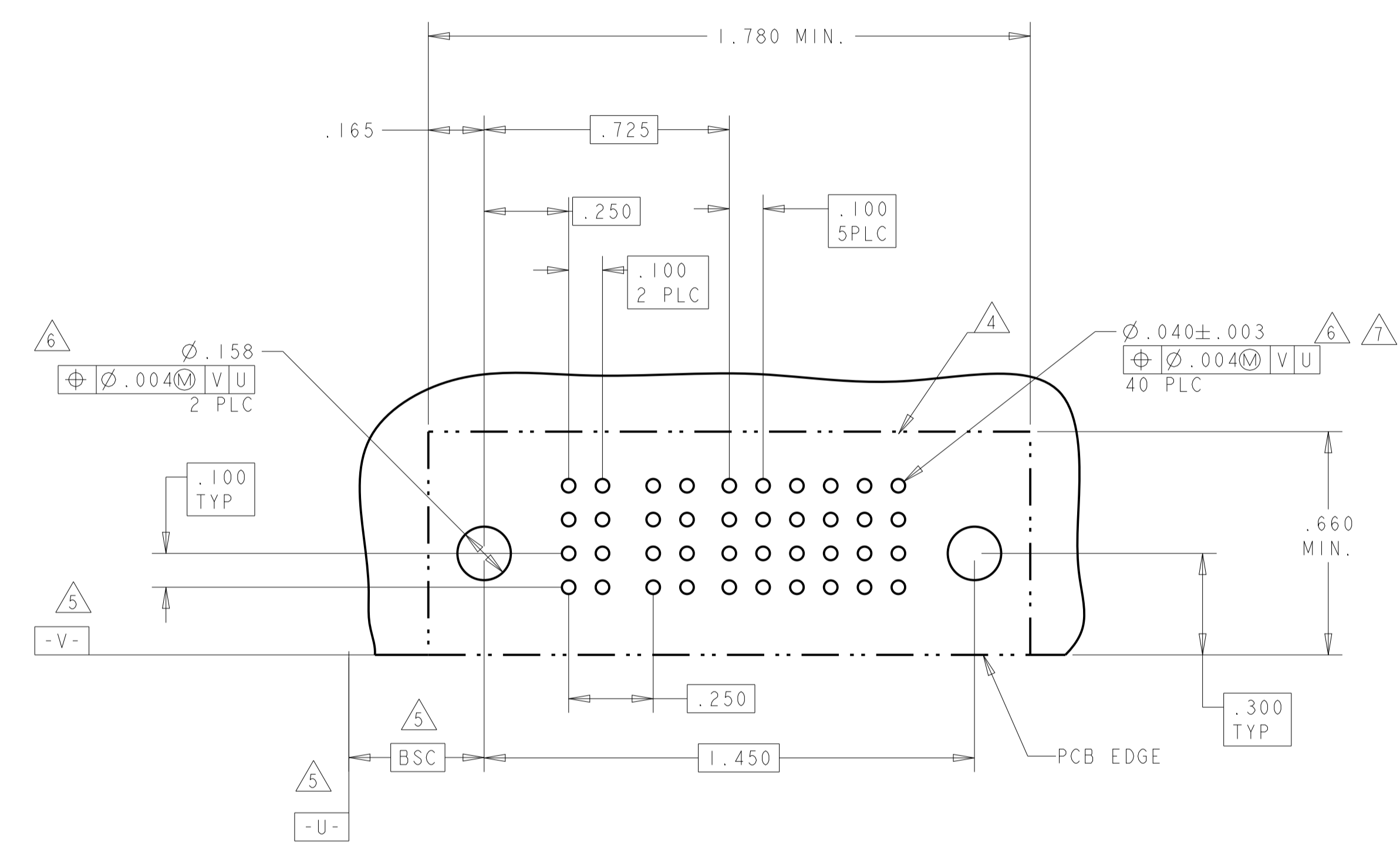
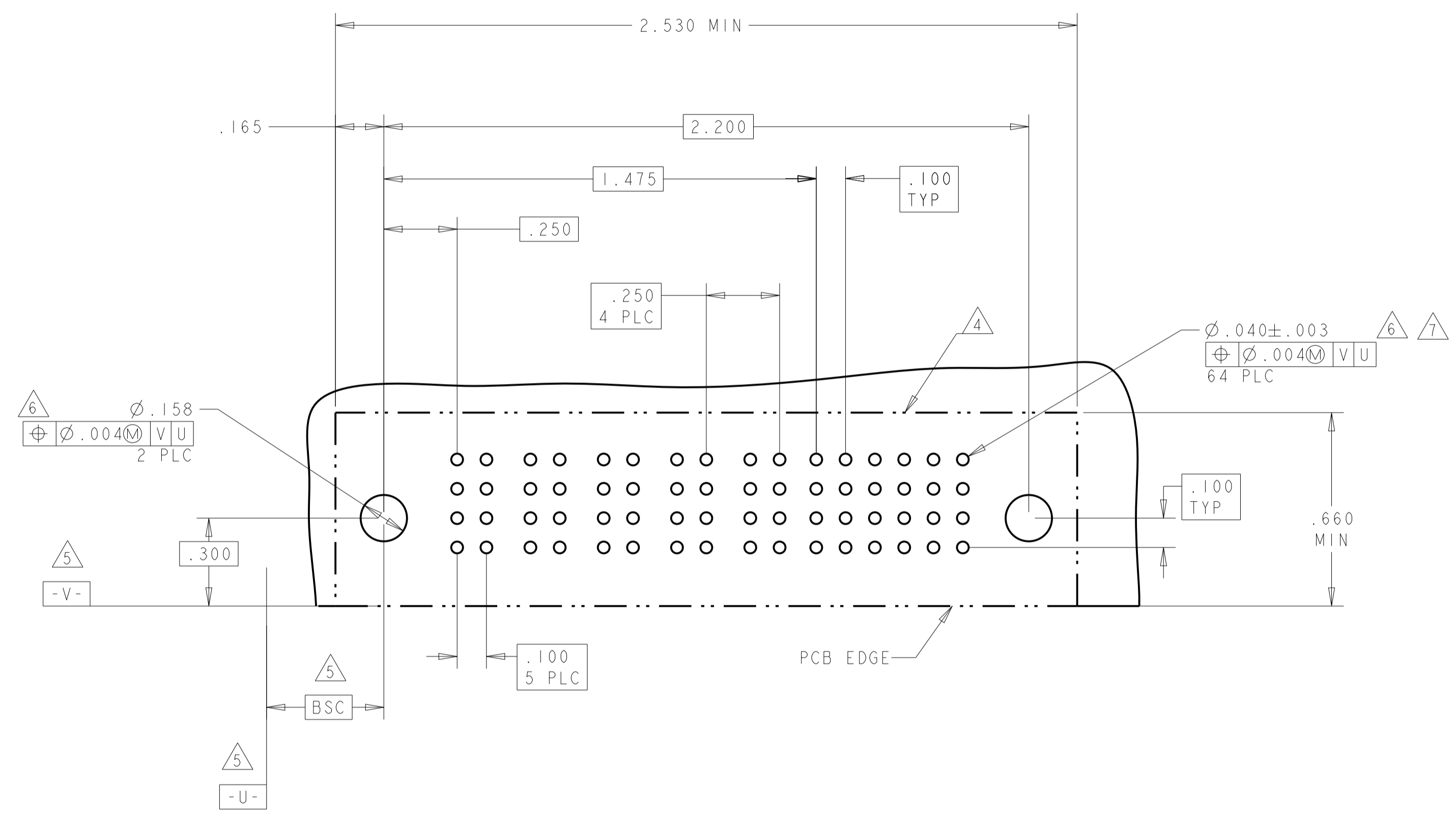

THIS DRAWING IS A CONTROLLED DOCUMENT.

OWN: R. GRZYBOWSKI 24JAN05
 CHK: M. PERCHERKE 24JAN05
 APVD: M. PERCHERKE

STE TE Connectivity

NAME: RIGHT ANGLE SOLDER HEADER ASSEMBLY MULTI-BEAM XL

PRODUCT SPEC: 108-1973
 APPLICATION SPEC: 114-13038

SIZE: A1
 CAGE CODE: 100779
 DRAWING NO: 6450332

MATERIAL: -
 FINISH: -

WEIGHT: -

CUSTOMER DRAWING

SCALE: 4:1
 SHEET: 8 OF 13
 REV: H6

LOC	DIST	REV	DATE	BY	APPV
ES	00				

PART NUMBER	ROWS	POWER								SIGNAL					
		P1	P2	P3	P4	P5	P6	P7	P8	1	2	3	4	5	6
2-6450332-4	D C B A	PM	PM	PM	PM	PM	PM	PM	PM	J	J	J	J	E	E
		PM	PM	PM	PM	PM	PM	PM	PM	K	K	K	K	F	F
		PM	PM	PM	PM	PM	PM	PM	PM	N	N	N	N	G	G
8P + 24S									S	S	S	S	H	H	

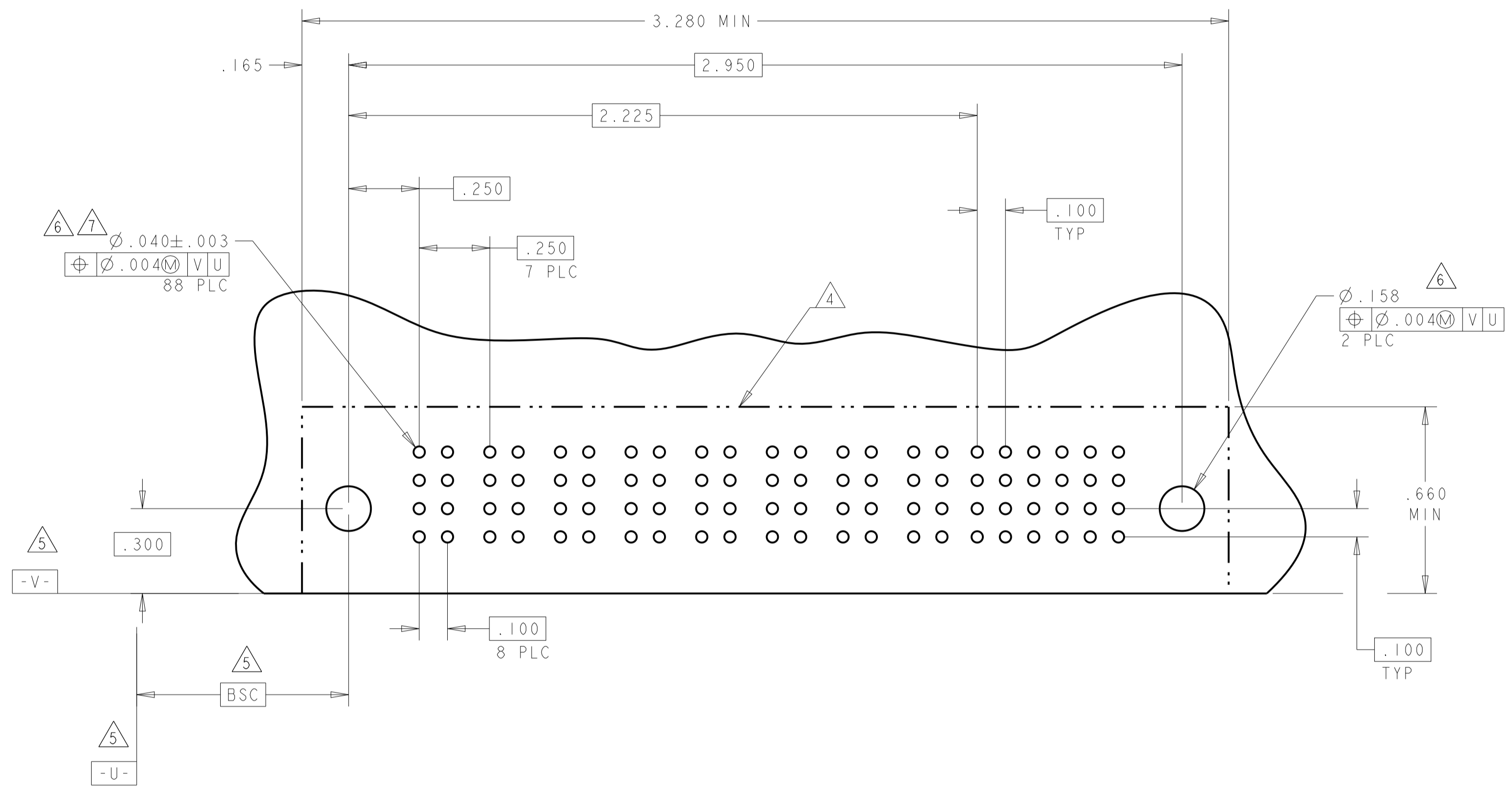

PART NUMBER	ROWS	POWER				SIGNAL					
		P1	P2	P3	P4	1	2	3	4	5	6
2-6450332-5	D C B A	PM	PM	PM	PM	E	E	E	E	E	E
		PM	PM	PM	PM	K	F	F	F	F	F
		PM	PM	PM	PM	N	G	G	G	G	G
4P + 24S						H	H	H	H	H	S

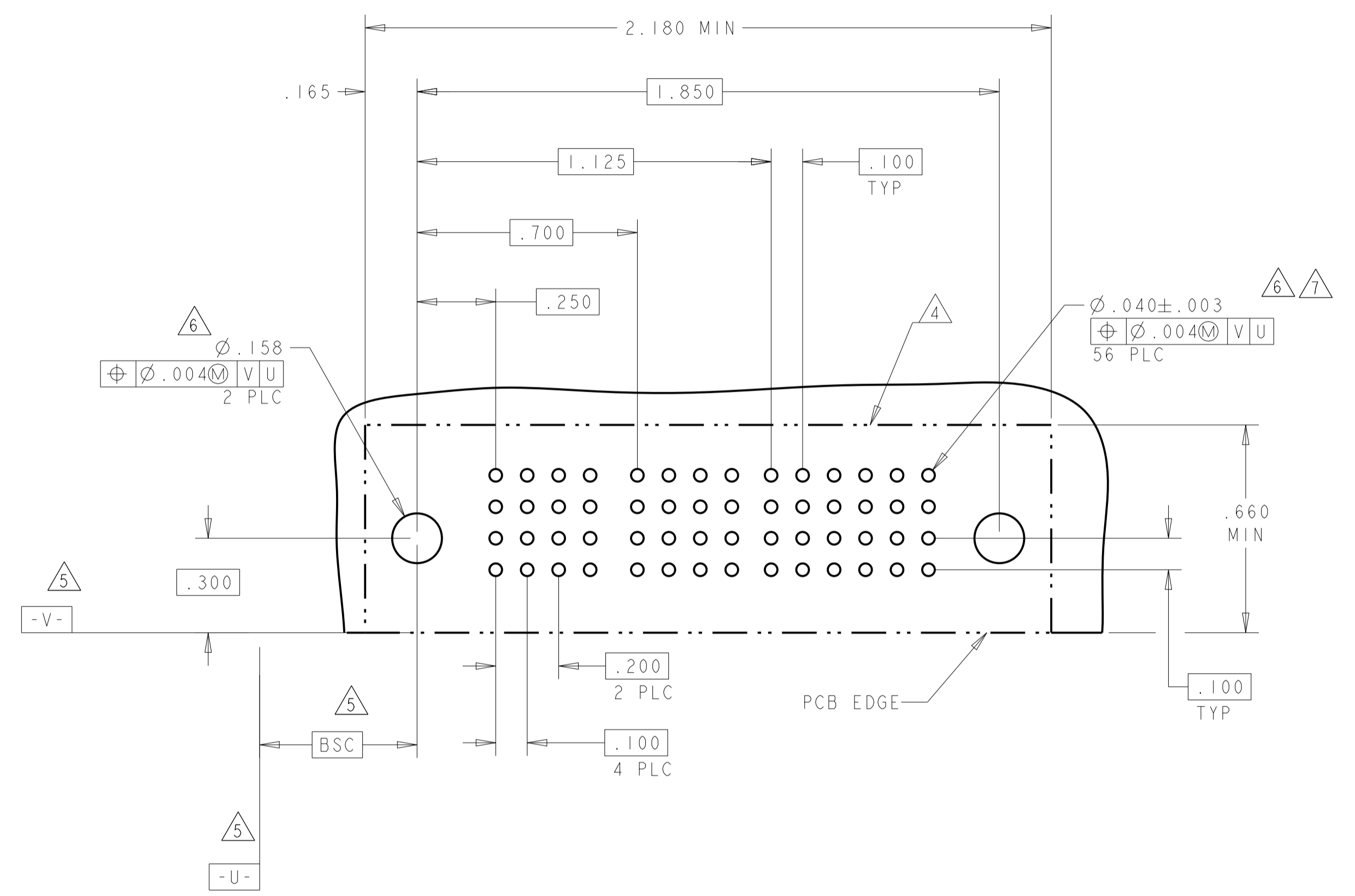

THIS DRAWING IS A CONTROLLED DOCUMENT.

DIMENSIONS: INCHES	TOLERANCES UNLESS OTHERWISE SPECIFIED: 0 PLC ±.01 2 PLC ±.01 3 PLC ±.01 4 PLC ±.005 5 PLC ±.002 ANGLES ±.020	FINISH	FINISH
-----------------------	--	--------	--------

OWN: R. GRZYBOWSKI 24JAN05	CHK: M. PERCHERKE 24JAN05	APVD: M. PERCHERKE	NAME: RIGHT ANGLE SOLDER HEADER ASSEMBLY MULTI-BEAM XL
PRODUCT SPEC: 108-1973		APPLICATION SPEC: 114-13038	
MATERIAL: -		WEIGHT: -	
CUSTOMER DRAWING		SCALE: 4:1 SHEET 9 OF 13 REV: H6	

STE TE Connectivity

LOC		DIST		REVISIONS			
P	LTN	DESCRIPTION	DATE	DMN	APVD		
ES	00	SEE SHEET 1					

PART NUMBER	ROWS	POWER				SIGNAL				
		P1	P2	P3	P4	1	2	3	4	5
2-6450332-6	D	PM	PM	PM	PM	J	J	J	J	J
	C					K	K	K	K	K
	B					N	N	N	N	N
A	H	H	H	H	H					

4P + 20S

PART NUMBER	ROWS	POWER									SIGNAL					
		P1	P2	P3	P4	P5	P6	P7	P8	P9	1	2	3	4	5	6
2-6450332-8	D	PM	PM	PM	PM	PM	PM	PM	PM	PM	E	E	E	E	E	E
	C										K	F	F	F	F	F
	B										N	G	G	G	G	G
A	H	H	H	H	H	H	S									

3ACP + 6P + 24S

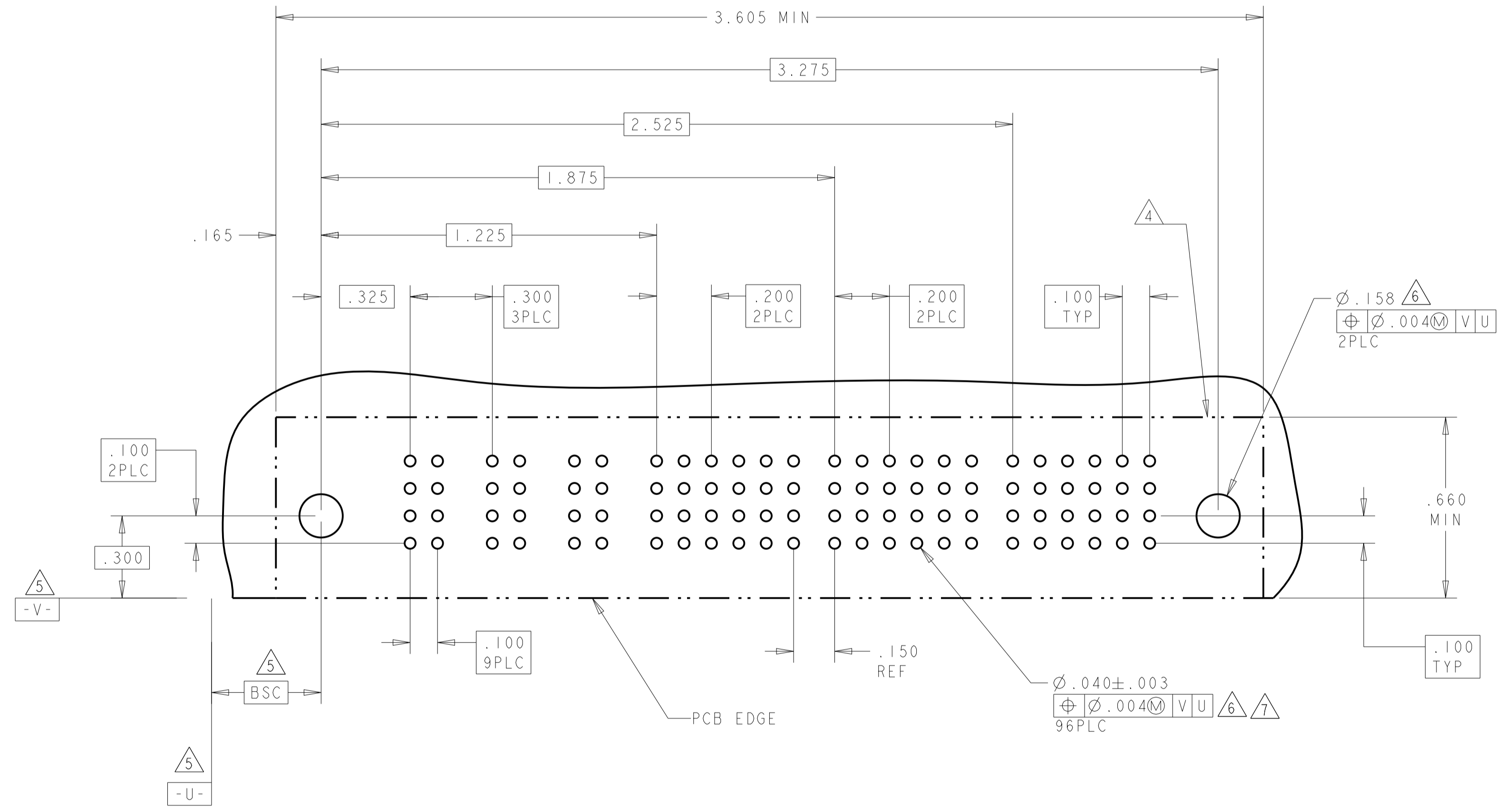
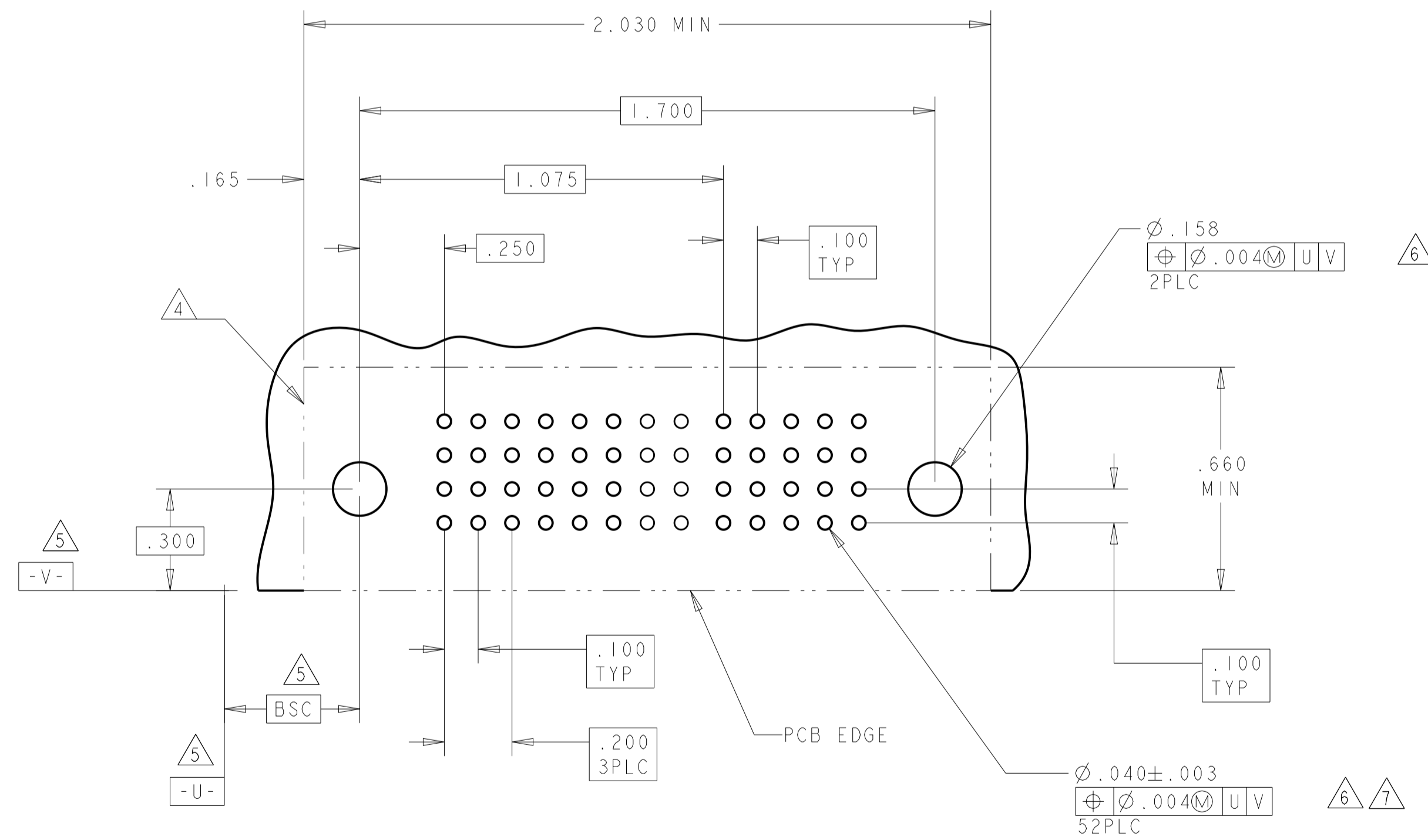

THIS DRAWING IS A CONTROLLED DOCUMENT.		DMN R. GRZYBOWSKI 24JAN05	STE TE Connectivity	
DIMENSIONS: INCHES	TOLERANCES UNLESS OTHERWISE SPECIFIED:	CHK M. PERCHERKE 24JAN05	NAME RIGHT ANGLE SOLDER HEADER ASSEMBLY MULTI-BEAM XL	RESTRICTED TO
	0 PLC ±.01 1 PLC ±.01 2 PLC ±.01 3 PLC ±.005 4 PLC ±.002 ANGLES ±.020	APVD M. PERCHERKE	PRODUCT SPEC 108-1973	SIZE A1100779
MATERIAL	FINISH	APPLICATION SPEC 114-13038	WEIGHT	CAGE CODE C=6450332
CUSTOMER DRAWING		SCALE 4:1	SHEET 10	OF 13

LOC	DIST	REVISIONS			
		REV	DATE	BY	APPV
ES	00	-	-	-	-
		SEE SHEET 1			

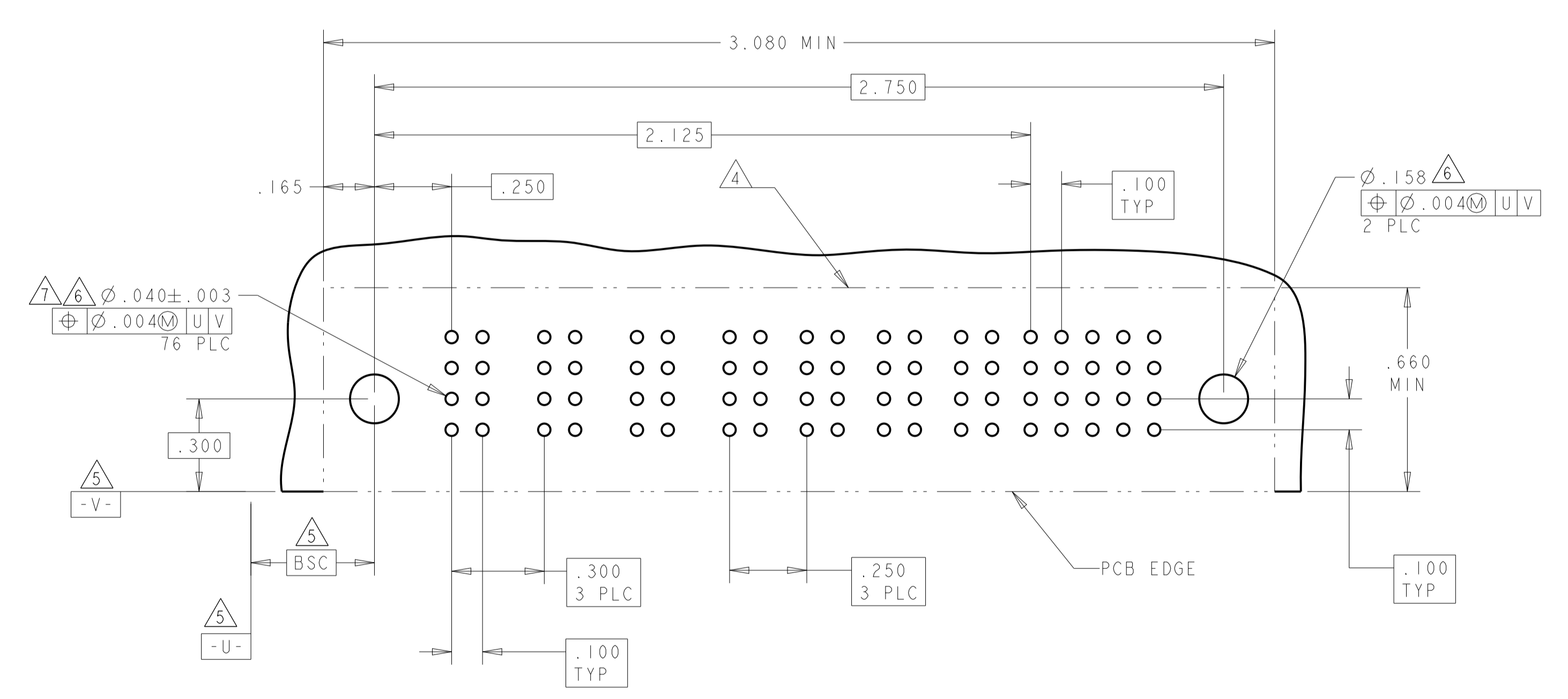
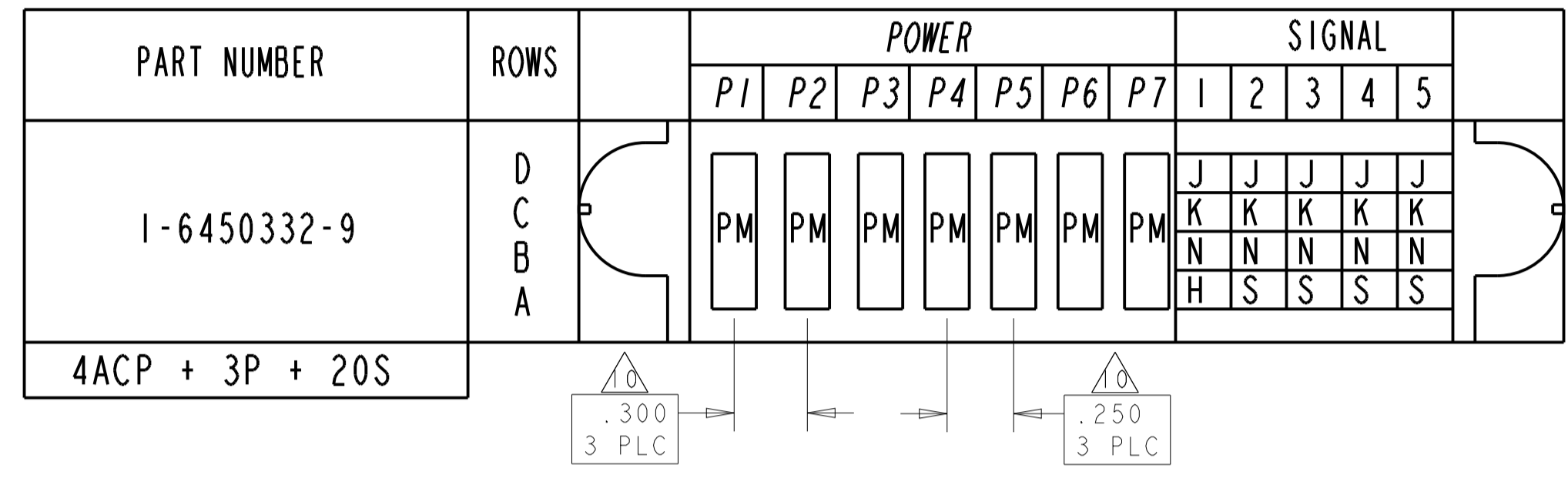

THIS DRAWING IS A CONTROLLED DOCUMENT.		OWN B. GRZYBOWSKI	24JAN05	TE Connectivity
DIMENSIONS: INCHES		CHK M. PERCHERKE	24JAN05	
		TOLERANCES UNLESS OTHERWISE SPECIFIED:		NAME RIGHT ANGLE SOLDER HEADER ASSEMBLY MULTI-BEAM XL
0 PLC ±. 1 PLC ±.01 2 PLC ±.01 3 PLC ±.005 4 PLC ±.0020 ANGLES ±.2°		APVD M. PERCHERKE	-	PRODUCT SPEC 108-1973
MATERIAL		FINISH		APPLICATION SPEC 114-13038
		WEIGHT		SIZE A100779
		CUSTOMER DRAWING		CAGE CODE 6450332
		SCALE 4:1		SHEET 11 OF 13
				REV H6

LOC		DIST		REVISIONS			
ES	00	P	LTM	DESCRIPTION	DATE	OWN	APVD
				SEE SHEET 1			

PART NUMBER	ROWS	POWER							SIGNAL						
		P1	P2	P3	P4	P5	P6	P7	P8	P9	1	2	3	4	5
3-6450332-0	D C B A	PM	PM	PM	PM	PM	PM	PM	PM	J	J	J	J	J	J
										K	K	K	K	K	K
										N	N	N	N	N	N
										S	S	S	S	S	S

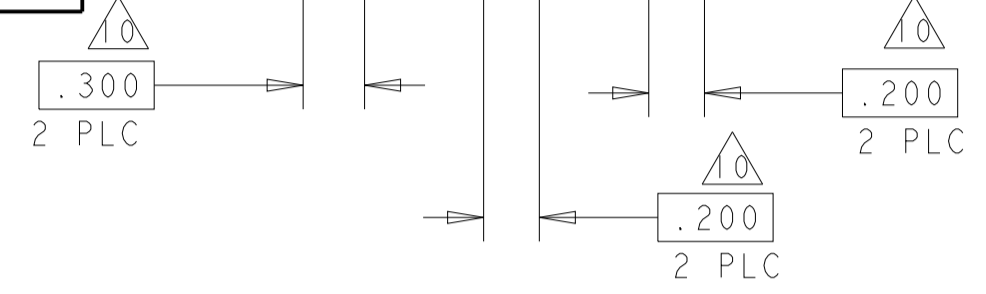

PART NUMBER	ROWS	POWER							SIGNAL					
		P1	P2	P3	P4	P5	P6	P7	1	2	3	4	5	6
3-6450332-1	D C B A	PM	PM	PM	PM	PM	PM	PM	J	J	J	J	J	J
									K	K	K	K	K	K
									N	N	N	N	N	N
									H	S	S	S	S	S

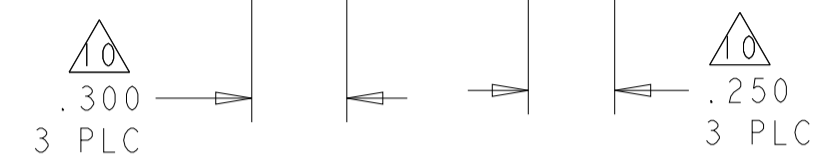

PART NUMBER	ROWS	POWER							SIGNAL					
		P1	P2	P3	P4	P5	P6	P7	1	2	3	4	5	6
3-6450332-3	D C B A	PM	PM	PM	PM	PM	PM	PM	E	E	J	J	J	E
									K	F	F	F	K	F
									N	G	G	G	N	G
									S	H	S	S	H	H

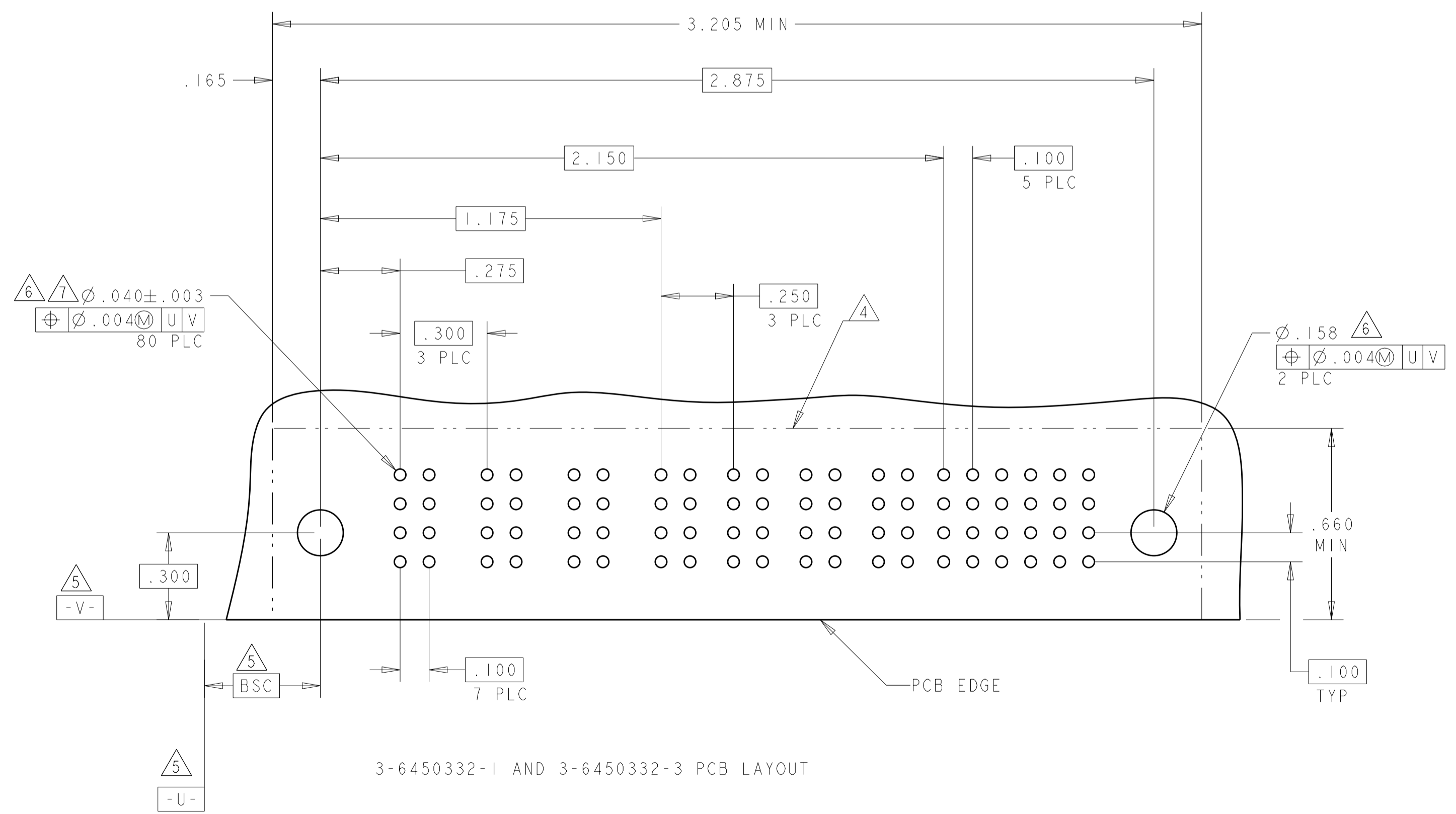
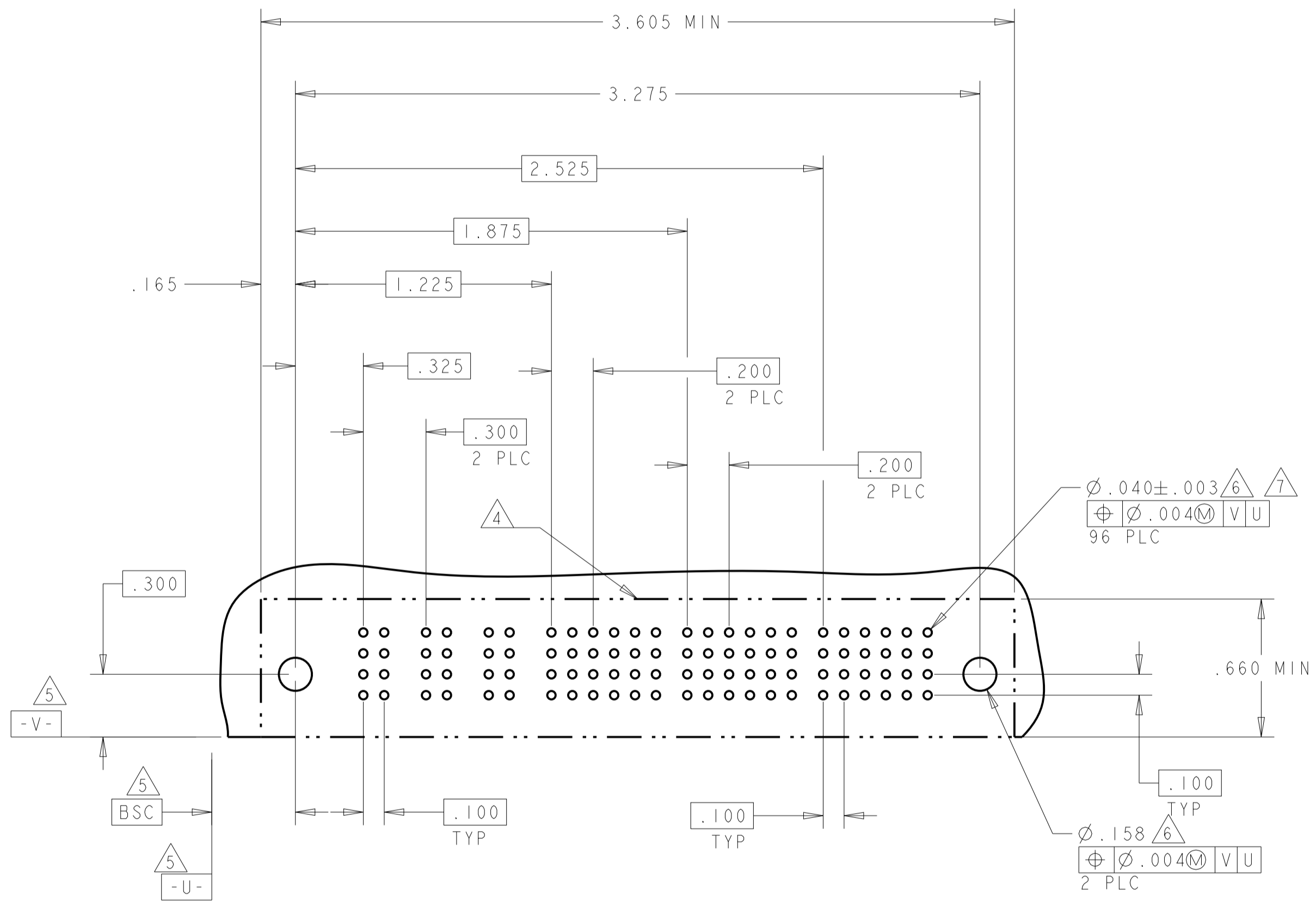
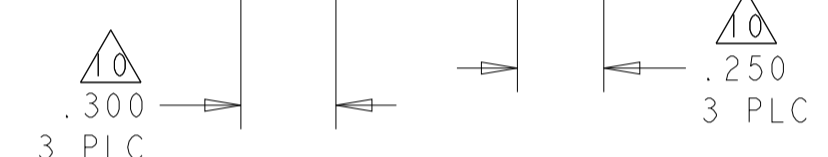

3-6450332-1 AND 3-6450332-3 PCB LAYOUT

THIS DRAWING IS A CONTROLLED DOCUMENT.		OWN: R. GRZYBOWSKI 24JAN05	TE Connectivity
DIMENSIONS: INCHES		CHK: M. PERCHERKE 24JAN05	
TOLERANCES UNLESS OTHERWISE SPECIFIED:		APVD: M. PERCHERKE	NAME: RIGHT ANGLE SOLDER HEADER ASSEMBLY MULTI-BEAM XL
0 PLC ±.01		PRODUCT SPEC: 108-1973	SIZE: CAGE CODE DRAWING NO: A100779
1 PLC ±.01		APPLICATION SPEC: 114-13038	RESTRICTED TO: -
2 PLC ±.01		WEIGHT: -	SCALE: 4:1
3 PLC ±.005		CUSTOMER DRAWING	SHEET 12 OF 13
4 PLC ±.002			REV: H6
ANGLES ±.0020			
FINISH: -			

LOC		DIST		REVISIONS			
ES	00	P	LTH	DESCRIPTION	DATE	DWN	APVD
-	-	-	-	SEE SHEET 1	-	-	-

PART NUMBER	ROWS	POWER				SIGNAL		
		P1	P2	P3	P4	1	2	3
3-6450332-2	D C B A	PM	PM	PM	PM	J K N S	E F N S	J F N S
4P + 12S								

PART NUMBER	ROWS	POWER				SIGNAL					
		P1	P2	P3	P4	1	2	3	4	5	6
3-6450332-4	D C B A	PM	PM	PM	PM	E K N S	E F G H	J F G S	J F G S	J K N S	E F G H
4P + 24S											

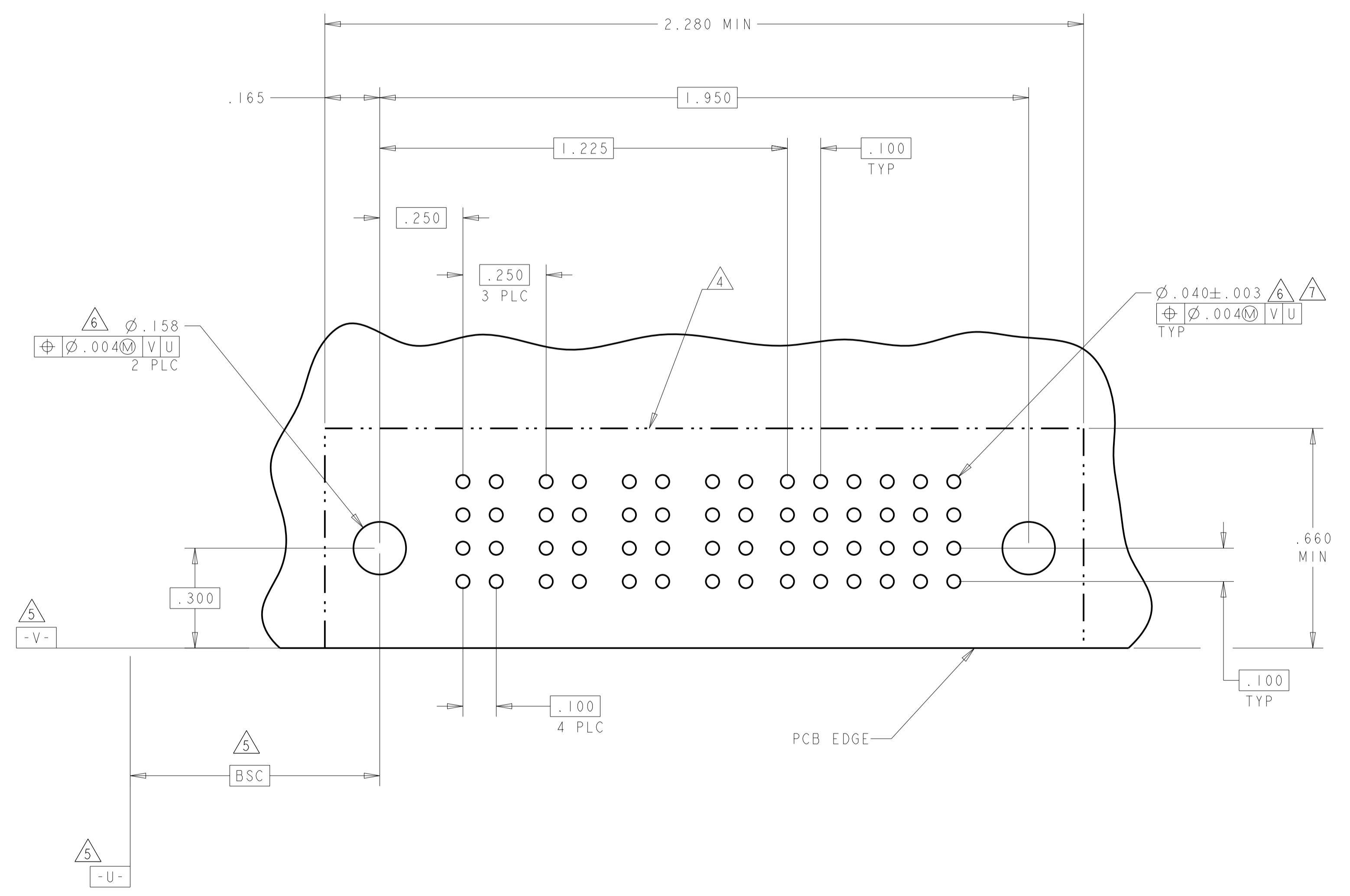
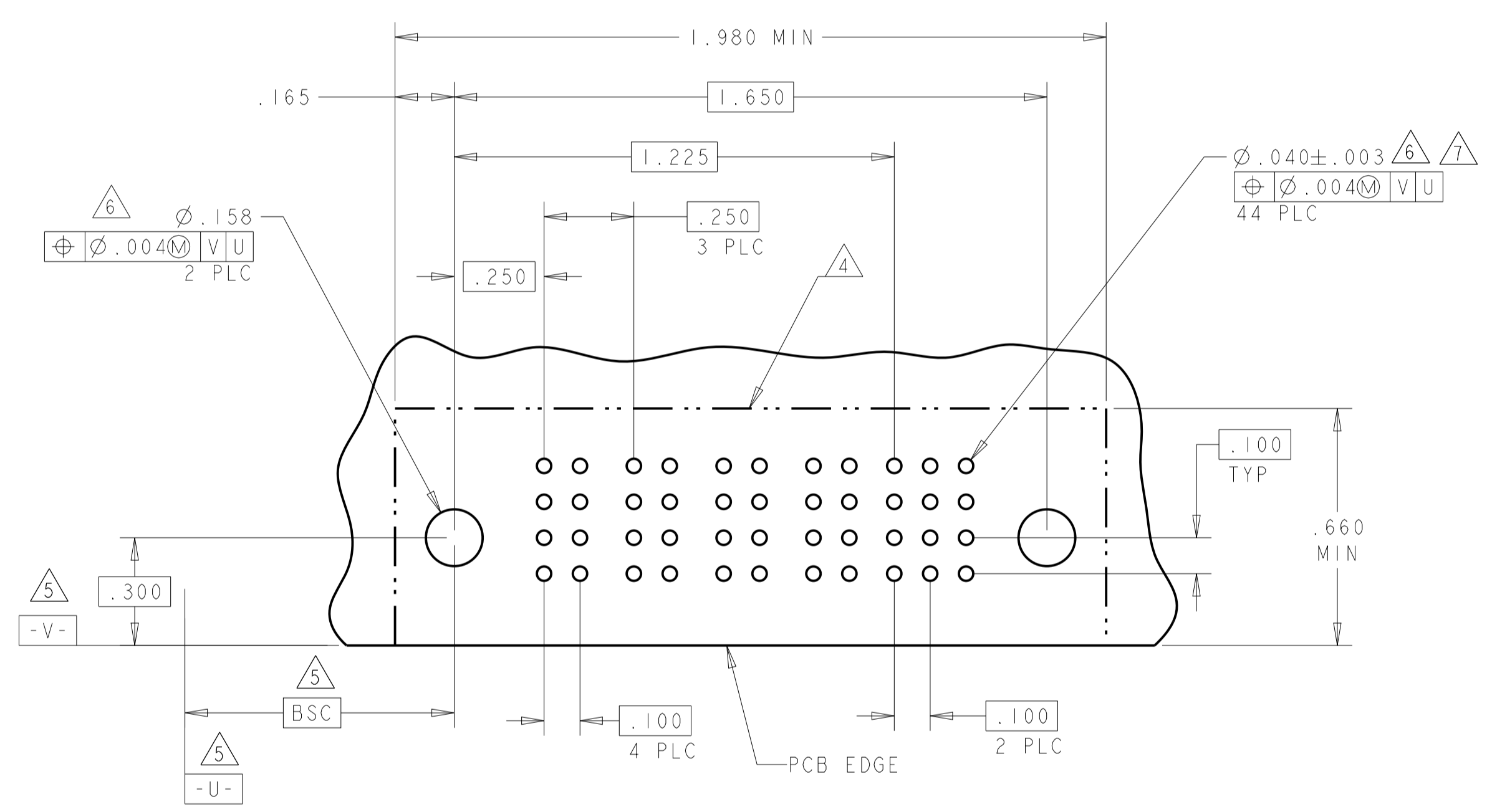

THIS DRAWING IS A CONTROLLED DOCUMENT.

DIMENSIONS: INCHES	TOLERANCES UNLESS OTHERWISE SPECIFIED: 0 PLC ±. 1 PLC ±.01 2 PLC ±.01 3 PLC ±.005 4 PLC ±.0020 ANGLES ±.020	DWN R. GRZYBOWSKI 24JAN05	CHK M. PERCHERKE 24JAN05	APVD M. PERCHERKE	NAME RIGHT ANGLE SOLDER HEADER ASSEMBLY MULTI-BEAM XL
MATERIAL	FINISH	PRODUCT SPEC 108-1973	APPLICATION SPEC 114-13038	WEIGHT	SIZE A100779
CUSTOMER DRAWING		SCALE 4:1		SHEET 13 OF 13	

STE TE Connectivity

Компания «Океан Электроники» предлагает заключение долгосрочных отношений при поставках импортных электронных компонентов на взаимовыгодных условиях!

Наши преимущества:

- Поставка оригинальных импортных электронных компонентов напрямую с производств Америки, Европы и Азии, а так же с крупнейших складов мира;
- Широкая линейка поставок активных и пассивных импортных электронных компонентов (более 30 млн. наименований);
- Поставка сложных, дефицитных, либо снятых с производства позиций;
- Оперативные сроки поставки под заказ (от 5 рабочих дней);
- Экспресс доставка в любую точку России;
- Помощь Конструкторского Отдела и консультации квалифицированных инженеров;
- Техническая поддержка проекта, помощь в подборе аналогов, поставка прототипов;
- Поставка электронных компонентов под контролем ВП;
- Система менеджмента качества сертифицирована по Международному стандарту ISO 9001;
- При необходимости вся продукция военного и аэрокосмического назначения проходит испытания и сертификацию в лаборатории (по согласованию с заказчиком);
- Поставка специализированных компонентов военного и аэрокосмического уровня качества (Xilinx, Altera, Analog Devices, Intersil, Interpoint, Microsemi, Actel, Aeroflex, Peregrine, VPT, Syfer, Eurofarad, Texas Instruments, MS Kennedy, Miteq, Cobham, E2V, MA-COM, Hittite, Mini-Circuits, General Dynamics и др.);

Компания «Океан Электроники» является официальным дистрибьютором и эксклюзивным представителем в России одного из крупнейших производителей разъемов военного и аэрокосмического назначения «JONHON», а так же официальным дистрибьютором и эксклюзивным представителем в России производителя высокотехнологичных и надежных решений для передачи СВЧ сигналов «FORSTAR».



JONHON

«JONHON» (основан в 1970 г.)

Разъемы специального, военного и аэрокосмического назначения:

(Применяются в военной, авиационной, аэрокосмической, морской, железнодорожной, горно- и нефтедобывающей отраслях промышленности)

«FORSTAR» (основан в 1998 г.)

ВЧ соединители, коаксиальные кабели, кабельные сборки и микроволновые компоненты:

(Применяются в телекоммуникациях гражданского и специального назначения, в средствах связи, РЛС, а так же военной, авиационной и аэрокосмической отраслях промышленности).



Телефон: 8 (812) 309-75-97 (многоканальный)

Факс: 8 (812) 320-03-32

Электронная почта: ocean@oceanchips.ru

Web: <http://oceanchips.ru/>

Адрес: 198099, г. Санкт-Петербург, ул. Калинина, д. 2, корп. 4, лит. А