

Interface Technology and Switching Devices

2013/2014

7





PCB connection technology and electronics housing

- PCB terminal blocks and plug-in connectors
- Electronics housing



Connection technology for field devices

- Plug-in connectors
- Cables and connectors



Modular terminal blocks

- Modular terminal blocks



Sensor/actuator cabling and industrial plug-in connectors

- Sensor/actuator cabling
- Cables and connectors
- Plug-in connectors



Marking systems, tools, and mounting material

- Marking and labeling
- Tools
- Installation and mounting material



Surge protection and power supply units

- Lightning monitoring system
- Surge protection and interference filters
- Power supply units and UPS
- Protective devices



Interface technology and switching devices



Control technology, I/O systems and automation infrastructure

- Ethernet networks • Functional safety • HMIs and industrial PCs • I/O systems
- Industrial lighting and signaling • Industrial communication technology
- Fieldbus components and systems • Wireless data communication
- Process infrastructure • Software • Controllers

Table of contents

| | | |
|---|---|------------|
| Complete overview | | 2 |
| Electronic switching devices and motor control |  | 7 |
| Measurement and control technology |  | 53 |
| Monitoring |  | 193 |
| Relay modules |  | 265 |
| System cabling for controllers |  | 417 |
| Technical information/index | | 566 |

Complete overview

Product range overview

Electronic switchgear and motor control



Motor management

Page 12



Hybrid motor starters

Page 18



Solid-state contactors

Page 38



IP67 motor starters

Page 48

Measurement and control technology



Digital displays

Page 150



Ex i isolating amplifiers with functional safety

Page 152



Multiplexers for HART signals

Page 186



Ex i 2-conductor field devices

Page 187

Monitoring



Compressed air meters

Page 208



Current transformers

Page 212



Test disconnect terminal blocks
See Catalog 3



Current transducers, current protectors

Page 229



Compact monitoring relays

Page 250



Multifunctional monitoring relays

Page 252



Ultra-narrow timer relays

Page 258



Multifunctional timer relays

Page 260

Measurement and control technology



Frequency inverters

Page 50



Highly compact isolating amplifiers

Page 64



Isolating amplifiers with functional safety

Page 100



Isolating amplifiers, special designs

Page 130



Shield fast connection and test plugs

Page 191



Controllers
See Catalog 8

Monitoring



Energy meters

Page 200



Complete packages for data logging

Page 206



Voltage transducers, AC and DC

Page 236



PV system monitoring

Page 134



Residual current monitoring

Page 244



Components for E-Mobility

Page 247



Special function modules

Page 262



Lightning current measuring system
See Catalog 6



HMIs
See Catalog 8



Signal towers
See Catalog 8

Complete overview

Product range overview

Relay modules



RIFLINE complete

Page 276



PLC series

Page 322



PR series

Page 372

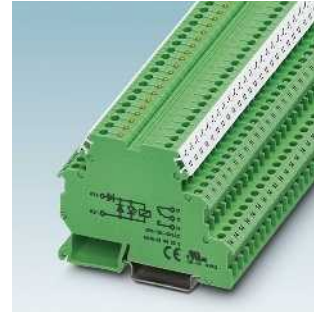

DEK series

Page 397

System cabling for controllers



Front adapters

Page 424



Termination boards

Page 470



V8 adapters

Page 369



System cables

Page 500



Multi-channel relay modules

Page 550



Safety devices
See Catalog 8



Monitoring relays

Page 250



Timer relays

Page 258



Universal interface modules

Page 524



Potential distributors

Page 548



Electronic switchgear and motor control

Switching devices for starting, reversing, and protecting electric motors are some of the most frequently used components in automation technology. These are often designed redundantly for safety-sensitive applications. When it comes to reducing installation time and space requirements, CONTACTRON hybrid motor starters are the state-of-the-art alternative.

This is because CONTACTRON hybrid motor starters combine up to 4 functions in a single device. Integration in popular fieldbus systems is implemented using the SmartWire-DT™ wiring system.

For protection of the entire system, the product range now includes the electronic motor manager (EMM). In addition to typical measured values such as voltage and current, the behavior of the system is monitored and protected by means of real power measurement. The process data in all popular fieldbus systems can be supplied via gateways and evaluated by a controller.

Product range overview

| Product overview | 8 |
|---|----|
| Electronic motor management | 10 |
| 3-phase hybrid motor starters | 16 |
| Hybrid motor starters with short-circuit protection | 29 |
| Hybrid motor starters with SmartWire-DT™ support | 31 |
| 3-phase solid-state reversing contactors | 38 |
| 3-phase solid-state contactors | 40 |
| Solid-state reversing contactor for DC motors | 44 |
| Single-phase solid-state contactors | 46 |
| IP67 motor starters | 48 |
| IP20 frequency inverters | 50 |

Product overview

Motor management



Electronic motor management
Page 12



Gateways
Page 14



Software
Page 15



Reversing load relays with soft starter
Page 42

Solid-state contactors



3-phase solid-state reversing contactors
Page 38



3-phase solid-state contactors
Page 40



Solid-state reversing contactor for
DC motors
Page 44



Single-phase solid-state contactors
Page 46

Frequency inverters



Inline frequency inverters for the
control cabinet
Page 50

Hybrid motor starters



3-phase hybrid motor starters Page 18



3-phase hybrid motor starters with short-circuit protection Page 29



Hybrid motor starters with SmartWire-DT™ support Page 31



Accessories Page 36

IP67 motor starters



PROFINET motor starters Page 48



Stainless steel base, IP67 protection Page 49

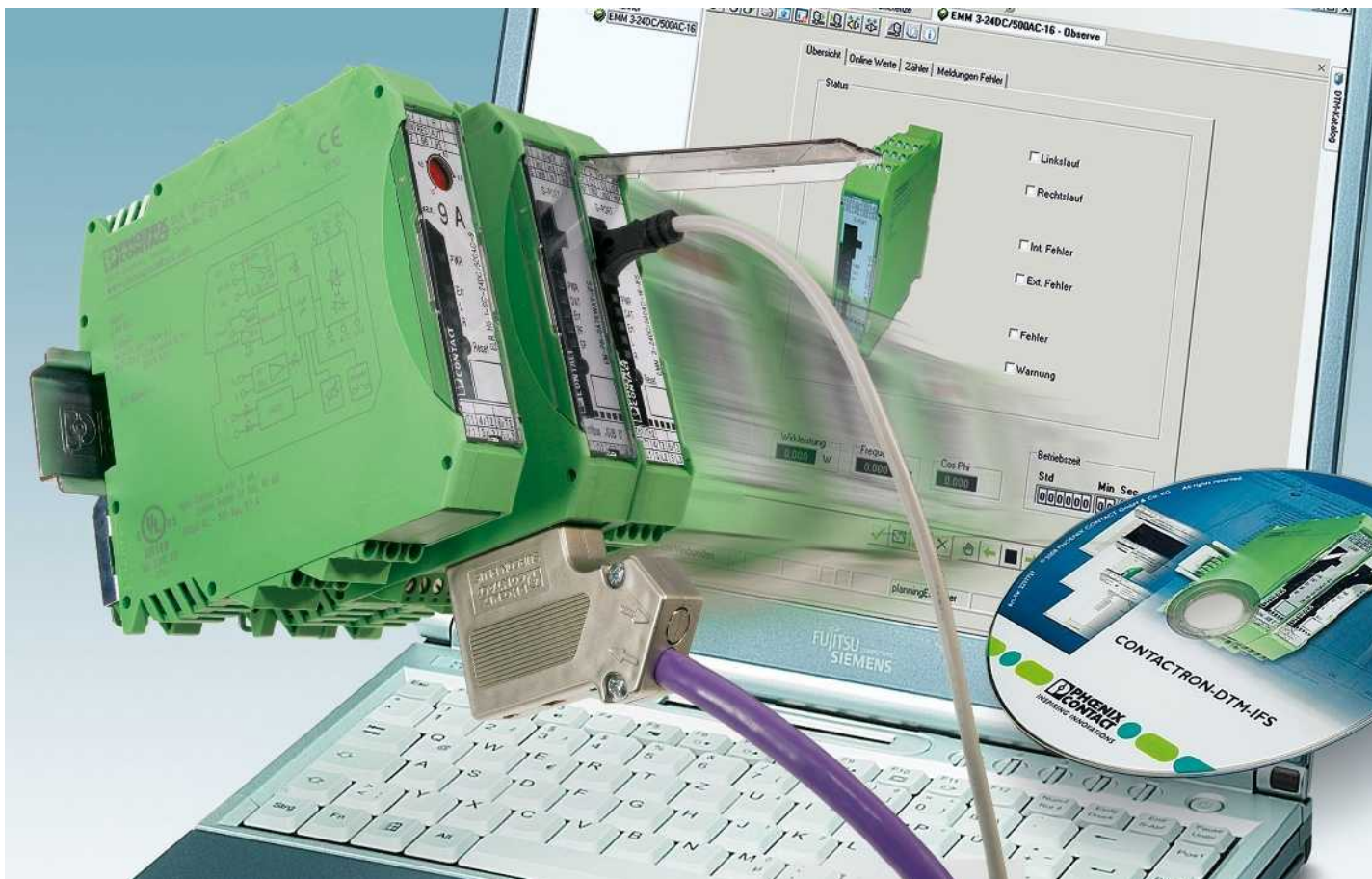

Electronic motor management (EMM)

The electronic motor management modules offer all the advantages of modern real power monitoring.

ELR-MM modules combine fast, wear-free electronic reversing load relays with modern measurement and evaluation electronics. EMM offers the same functionality for all performance classes, only without a power section.

Power within limits

Monitoring is based on freely parameterizable switching and signaling thresholds for overload and underload detection. Identical or separate settings can be made for the thresholds relating to the two directions of rotation. Parameterization relies on the real power consumed (calculated from three currents, voltages, and the phase angle), thereby offering a much more precise basis than if only the current is taken into consideration, as it is independent of voltage fluctuations and drive load. If a switching threshold is exceeded or not reached, the ELR-MM or EMM initiates an emergency shutdown of the motor immediately (or after an adjustable “delay time”). In addition, a message can be sent via an output.

This state can only be deactivated via a defined reset. If the effective power consumed is determined as being above or below the message thresholds, all that occurs is that a check-back is returned for the duration for which the module was addressed.

In addition, signals are generated by the module for the recognition of the direction of rotation. Asymmetry and phase failures are detected and signaled.

Permanent status monitoring with high scanning rates and the fast semiconductor switch enable complete system protection, including motor protection.

Without any extra wiring - and with just a single device - pumps, actuating drives, fans, and tools are monitored for proper functioning, contamination (filter or similar), and wear. The adjustable “inrush suppression” time can be used to mask out the switching operation from the monitoring process.



Protection against dry running, blocking, and cavitation, warning thresholds to indicate filter contamination.



Protection against blocking, warning thresholds for bearing wear and other cases that trigger overload.



Protection against blocking and broken tools, warning thresholds for tool and bearing wear.



In the case of motor-driven pumps, the lower performance threshold provides reliable protection against hazardous dry running.



Forced shutdown of the drive can be delayed by the “delay time”. This prevents forced shutdown in the event of air bubbles.



Tooling machines are monitored and protected in a similar way when drilling, milling or grinding. If the feed value on a milling machine is set too high, a tool may break in the “worst-case” scenario. The power threshold - parameterized accordingly - can be used to resolve this issue.

Additionally, a message threshold signals tool wear in advance.

Motor management

Electronic motor management

The EMM motor management module (with/without current transformer) for all performance classes monitors and protects 3-phase loads, such as electrical drives.

- Freely parameterizable signaling or switching thresholds
- Digital outputs control external switching elements
- Optional connection to INTERFACE system and PROFIBUS-GATEWAY-IFS via TBUS



Allows the use of external current transformers



With integrated current transformers

Notes:
1) EMC: Class A product, see page 571

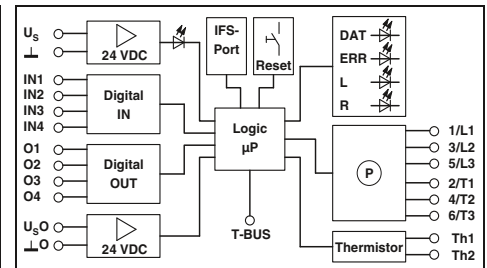
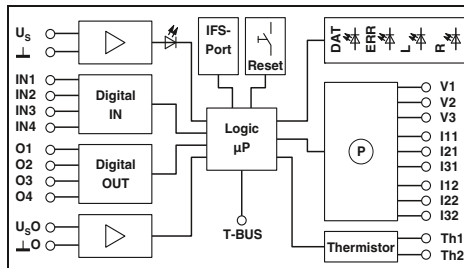

| Technical data | |
|--|--|
| Input data | |
| Rated control supply voltage U_s | 24 V DC 230 V AC |
| Rated control supply voltage range with reference to U_s | 0.8 ... 1.25 0.4 ... 1.1 |
| Rated control supply current I_s at U_s | 25 mA 10 mA |
| Input data of digital inputs | EMM 3- 24DC/500AC-IFS ¹⁾ EMM 3-230AC/500AC-IFS ¹⁾ |
| Number of inputs | 4 (IN1 - IN4) 4 (IN1 - IN4) |
| Rated actuating voltage U_c | 24 V DC 230 V AC |
| Rated actuating current I_c | 3.3 mA 3.5 mA |
| Power measurement | |
| Voltage measuring input | 42 V AC ... 575 V AC 42 V AC ... 575 V AC |
| Nominal current, voltage measuring input | < 0.5 mA < 0.5 mA |
| Current measuring input | 5 A Secondary external converter 5 A Secondary external converter |
| Output power of the converter | > 1.25 VA > 1.25 VA |
| Internal resistance EMM | 0.02 Ω 0.02 Ω |
| Output data for confirmation contacts | |
| O1 - O4 in the case of 1 signal | 24 V DC (semiconductor output) / 500 mA 230 V AC (relay output/500 mA) / 500 mA |
| General data | |
| Rated insulation voltage | 500 V |
| Rated surge voltage | 6 kV/safe isolation 6 kV/safe isolation |
| Ambient temperature (operation) | -25°C ... 70°C |
| Standards/regulations | EN 60947 / EN 60947-4-2 |
| EMC regulations | EN 61000-6-2 / EN 61000-6-3 / EN 61000-6-4 |
| Degree of protection according to IEC 60529/ EN 60529 | IP20 |
| Mounting position | Vertical (horizontal DIN rail) |
| Screw connection solid / stranded / AWG | 0.14 - 2.5 mm ² / 0.14 - 2.5 mm ² / 26 - 12 |
| Dimensions | 22.5 mm / 99 mm / 114.5 mm |

| Technical data | |
|--|--|
| Input data | |
| Rated control supply voltage U_s | 24 V DC 230 V AC |
| Rated control supply voltage range with reference to U_s | 0.8 ... 1.25 0.4 ... 1.1 |
| Rated control supply current I_s at U_s | 25 mA 10 mA |
| Input data of digital inputs | EMM 3- 24DC/500AC-IFS ¹⁾ EMM 3-230AC/500AC-IFS ¹⁾ |
| Number of inputs | 4 (IN1 - IN4) 4 (IN1 - IN4) |
| Rated actuating voltage U_c | 24 V DC 230 V AC |
| Rated actuating current I_c | 3.3 mA 3.5 mA |
| Power measurement | |
| Voltage measuring input | - - |
| Nominal current, voltage measuring input | - - |
| Current measuring input | max. 16 A max. 16 A |
| Output power of the converter | - - |
| Internal resistance EMM | - - |
| Output data for confirmation contacts | |
| O1 - O4 in the case of 1 signal | 24 V DC (semiconductor output) / 500 mA 230 V AC (relay output/500 mA) / 500 mA |
| General data | |
| Rated insulation voltage | 500 V |
| Rated surge voltage | 6 kV/safe isolation 6 kV/safe isolation |
| Ambient temperature (operation) | -25°C ... 70°C |
| Standards/regulations | EN 60947 / EN 60947-4-2 |
| EMC regulations | EN 61000-6-2 / EN 61000-6-3 / EN 61000-6-4 |
| Degree of protection according to IEC 60529/ EN 60529 | IP20 |
| Mounting position | Vertical (horizontal DIN rail) |
| Screw connection solid / stranded / AWG | 0.14 - 2.5 mm ² / 0.14 - 2.5 mm ² / 26 - 12 |
| Dimensions | 22.5 mm / 99 mm / 114.5 mm |

| Ordering data | |
|-------------------------------------|----------------|
| Description | |
| Electronic motor management | |
| EMM 3- 24DC/500AC-IFS ¹⁾ | 2297497 1 |
| EMM 3-230AC/500AC-IFS ¹⁾ | 2297507 1 |

| Ordering data | |
|--|----------------|
| Description | |
| Electronic motor management | |
| EMM 3- 24DC/500AC-16-IFS ¹⁾ | 2297523 1 |
| EMM 3-230AC/500AC-16-IFS ¹⁾ | 2297536 1 |

| Accessories | |
|---|---|
| Programming adapter for configuring modules with S-PORT interface | IFS-USB-PROG-ADAPTER ¹⁾ 2811271 1 |
| DIN rail connector | ME 22,5 TBUS 1,5/ 5-ST-3,81 GN 2707437 50 |
| Voltage transducer for 690 V, for EMM 3-.../500AC-IFS, comprising 3 modular terminal blocks and cover | UT 4-MTD-R/CVC 690/SET 2901667 1 |
| Multi-functional memory block for the INTERFACE system | |
| - Flat design | IFS-CONFSTICK ¹⁾ 2986122 1 |
| - Tall design | IFS-CONFSTICK-L 2901103 1 |
| Mini COMBICON connectors | |
| - Socket contact | MC 1,5/ 5-ST-3,81 1803604 50 |
| - Pin contact | IMC 1,5/ 5-ST-3,81 1857919 50 |

| Accessories | |
|---|---|
| Programming adapter for configuring modules with S-PORT interface | IFS-USB-PROG-ADAPTER ¹⁾ 2811271 1 |
| DIN rail connector | ME 22,5 TBUS 1,5/ 5-ST-3,81 GN 2707437 50 |
| Voltage transducer for 690 V, for EMM 3-.../500AC-IFS, comprising 3 modular terminal blocks and cover | UT 4-MTD-R/CVC 690/SET 2901667 1 |
| Multi-functional memory block for the INTERFACE system | |
| - Flat design | IFS-CONFSTICK ¹⁾ 2986122 1 |
| - Tall design | IFS-CONFSTICK-L 2901103 1 |
| Mini COMBICON connectors | |
| - Socket contact | MC 1,5/ 5-ST-3,81 1803604 50 |
| - Pin contact | IMC 1,5/ 5-ST-3,81 1857919 50 |

Electronic motor management

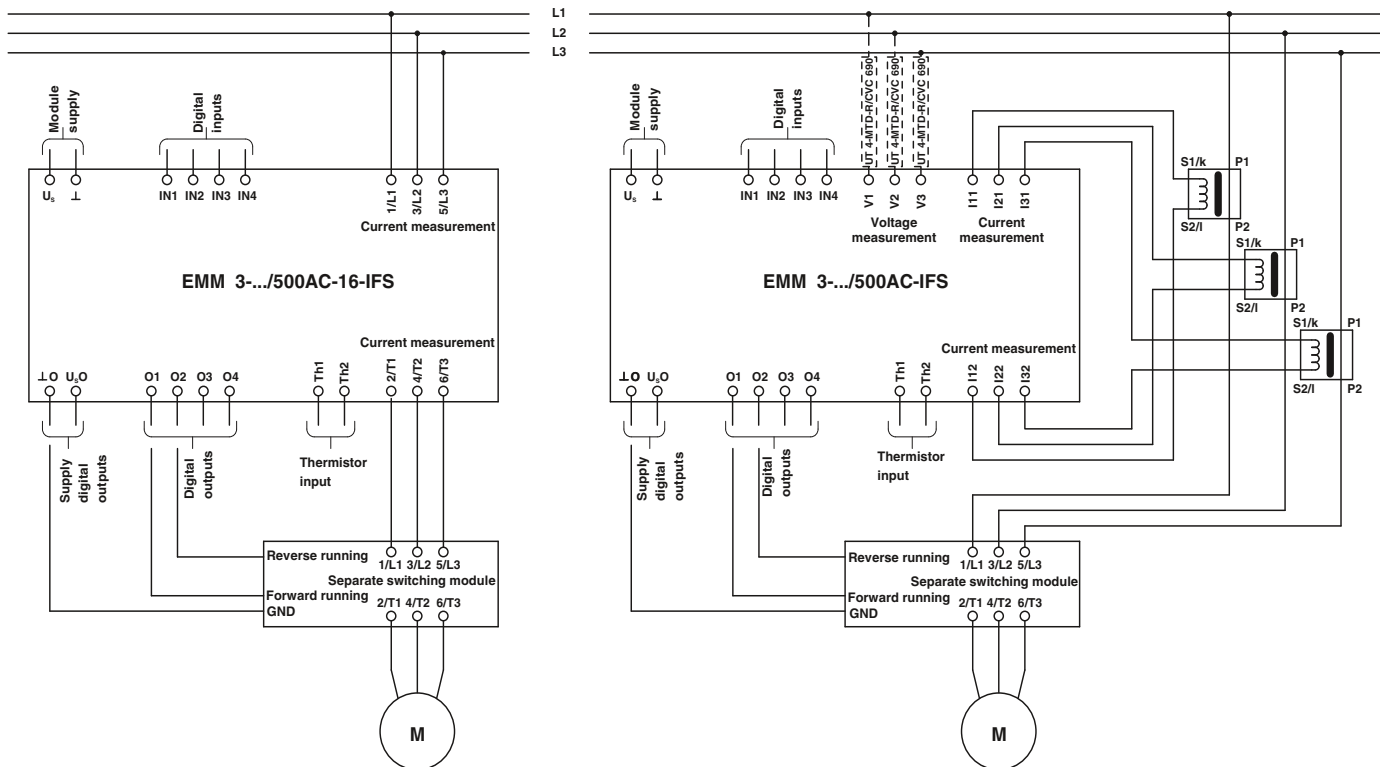

The electronic motor management modules offer all the advantages of modern effective power monitoring. Every 6.6 ms, the effective power of a drive system or of any other 3-phase consumer is calculated from three currents, voltages and the phase angle. Currents of up to 16 A can be directly acquired and currents >16 A are supplied via external converters. Digital outputs can be used to control separate mechanical or electronic switching elements that adopt the actual switching of the load. In this configuration, the EMM reliably protects connected loads – irrespective of their power consumption – against overload and underload, and provides permanent status monitoring.

Up to 8 freely parameterizable switching, message thresholds and up to four freely configurable inputs and outputs enable the protection of electrical drives and the system.

The EMM modules can record the following data:

- Apparent effective and reactive power
- Currents and voltages
- Phase angle
- Switching-cycle and operating-hours
- Power meter.

Additional Functions:

- Adjustable bimetal function class 5-30
- Thermistor monitor
- Recording measured values
- PROFIBUS connection via TBUS
- Pre-configured motor exits such as reversing starters, star delta starters, etc.

The EMM modules can be used to record complete "curves that can be used for system documentation.

The operating modes forward and reversing running, reverse and limit switch operation (with integrated restart inhibit) switch actuating and regulating drives, pumps etc. and also check for wear.

Current transformer

The external converters should be selected with a secondary nominal current of 5 A. The primary current is determined by the current consumption of the consumer (refer to connection diagram). For suitable current transformers, see catalog INTERFACE.

DIN rail connector TBUS

The **TBUS** (Order No. 2707437) can be used to supply several EMMs with 24 V DC or to couple up to 31 EMMs (for example) to the PROFIBUS-GATEWAY-IFS.

Switching element

Depending on the particular requirement of the application, either an electro-mechanical contactor or reversing contactor combination, or a semiconductor contactor or a solid-state reversing contactor is to be used for the actual task of switching the load. These switching elements are controlled via the digital outputs of the EMM modules.

Motor management

IFS gateways for electronic motor management modules

EM...GATEWAY-IFS for connecting EMM...IFS modules to popular bus systems: PROFIBUS DP, Modbus, Modbus TCP, DeviceNet™, and CANopen®.

- Communication via T-BUS with up to 31 EMM...IFS modules
- Equipped with freely parameterizable digital inputs and outputs
- Digital switching outputs for direct control of EMM...IFS (forward/reverse running)

Notes:

1) EMC: Class A product, see page 571



Technical data

| | |
|--|--|
| Input data | |
| Operating voltage U_B | 24 V DC -20 % ... +25 % |
| Nominal input current at U_{IN} | 85 mA |
| Input circuit | Polarity protection, surge protection |
| Digital inputs | |
| Input voltage | 24 V DC $\pm 20\%$ |
| Nominal input current at U_{IN} | 3 mA |
| Input circuit | Polarity protection, surge protection |
| Digital outputs | |
| Maximum switching voltage | 23 V DC ($U_B - U_{resid.}$ of the output) |
| Max. switching current | 500 mA |
| Residual voltage | 1 V |
| Output protection | Parallel protection against polarity reversal, pay attention to the fuse |
| IFS interface | |
| Connection method | TBUS |
| General data | |
| Test voltage data interface/power supply | 1.5 kV |
| Ambient temperature (operation) | -35°C ... 50°C |
| Nominal operating mode | 100% operating factor |
| Standards/regulations | EN 50178 |
| Degree of protection | IP20 |
| Mounting position/mounting | Any / - |
| Connection data solid / stranded / AWG | 0.2 ... 2.5 mm ² / 0.2 ... 2.5 mm ² / 24 - 12 |
| Dimensions | 22.5 mm / 99 mm / 114.5 mm |

Ordering data

| Description | Type | Order No. | Pcs. / Pkt. |
|---|---------------------------------|-----------|-------------|
| IFS gateways for electronic motor management modules | | | |
| PROFIBUS DP | EM-PB-GATEWAY-IFS ¹⁾ | 2297620 | 1 |
| RS-232 | EM-RS232-GATEWAY-IFS | 2901526 | 1 |
| RS-485 | EM-RS485-GATEWAY-IFS | 2901527 | 1 |
| Modbus TCP | EM-MODBUS-GATEWAY-IFS | 2901528 | 1 |
| DeviceNet™ | EM-DNET-GATEWAY-IFS | 2901529 | 1 |
| CANopen® | EM-CAN-GATEWAY-IFS | 2901504 | 1 |

Accessories

| | | | |
|--|------------------------------------|---------|----|
| Programming adapter for configuring modules with S-PORT interface | IFS-USB-PROG-ADAPTER ¹⁾ | 2811271 | 1 |
| DIN rail connector | ME 22,5 TBUS 1,5/ 5-ST-3,81 GN | 2707437 | 50 |
| Mini COMBICON connectors | | | |
| - Socket contact | MC 1,5/ 5-ST-3,81 | 1803604 | 50 |
| - Pin contact | IMC 1,5/ 5-ST-3,81 | 1857919 | 50 |

Device Type Manager (DTM) for motor management modules

EMM...IFS

- CONTACTRON-DTM-IFS, programming adapter, and user manual on CD available as configuration package
- Also available as USB programming adapter even individually
- CONTACTRON-DTM-IFS also available free of charge as a separate download from www.phoenixcontact.com



Notes:

1) EMC: Class A product, see page 571

| Ordering data | | |
|---|-----------|-------------|
| Type | Order No. | Pcs. / Pkt. |
| Configuration package for the EMM...IFS, comprising CONTACTRON-DTM-IFS, USB programming adapter, and user manual on CD | | |
| MM-CONF-SET | 2297992 | 1 |
| Accessories | | |
| Programming adapter for configuring modules with S-PORT interface | | |
| IFS-USB-PROG-ADAPTER ¹⁾ | 2811271 | 1 |



Hybrid motor starters for controlling 3-phase asynchronous motors combine up to four functions in one device as required. These include forward running, reverse running with optional reversing function including load wiring. The locking circuit for the reversing function is also integrated and certified as a single electronic reversing starter according to UL 508a and the new UL 60947-1. Furthermore, the devices protect the motor by means of an integrated motor protection relay with automatic and remote reset function. The implemented safety function according to Performance Level e (PL e) of EN ISO 13849-1 provides the emergency stop requirement. A PDT confirmation contact provides information regarding the availability of the device, and the motor state. This means that in the event of motor control without an error message the integrated current measurement and symmetry scanning ensures that the motor is turning. Even with these numerous functions, the hybrid motor starter is just 22.5 mm wide.

Short-circuit-proof hybrid motor starters with integrated protective devices, for mounting on 35 mm DIN rails and 60 mm busbar systems and connection to popular bus systems via SmartWire-DT™ complete the product portfolio.



Hybrid motor starters with up to four functions in one device: forward running, reverse running, motor protection, and emergency stop.



Short-circuit-proof hybrid motor starters with integrated fuses for mounting on 35 mm DIN rails and 60 mm busbar systems.



Connection of hybrid motor starters in a bus system via SmartWire-DT™. Gateways are provided for the main bus systems: PROFIBUS, Modbus TCB, EtherNet/IP™, and CANopen®.



The uniform design of the control side enables the combination of short-circuit-proof hybrid motor starters with SmartWire-DT™ adapters for integration in a bus system.

Hybrid motor starters

"4 in 1" hybrid motor starter with reversing function, motor protection, and emergency stop

These 3-phase "4 in 1" hybrid motor starters combine four functions in one device: right contactor, left contactor, motor protection relay, and emergency stop up to category 3.

Offer the following advantages:

- 22.5 mm wide
- They save wiring
- Bi-metal function can be set up to 9 A
- Long service life
- Space-saving
- 3-phase loop bridging

Safety level according to:

- IEC 61508-1: SIL3
- ISO 13849: PL e



For reversing 3~ AC motors up to 550 V AC/3 x 0.6 A



For reversing 3~ AC motors up to 550 V AC/3 x 2 A

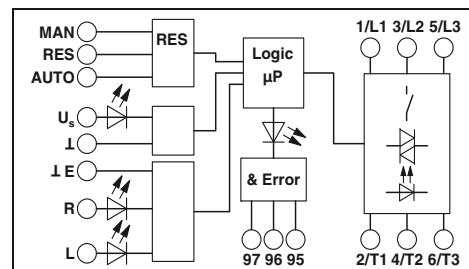
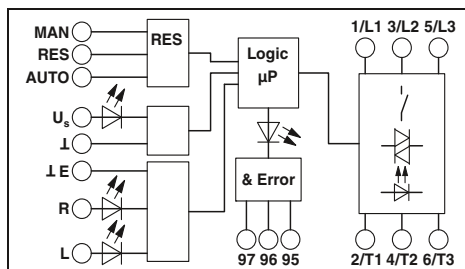

| |
|--|
| Notes: |
| Type of housing: Polyamide PA non-reinforced, color: green. |
| Marking systems and mounting material See Catalog 5 |

Technical data

| | | |
|--|---|--|
| Input data | | |
| Rated control supply voltage U_s | 24 V DC | 230 V AC (50/60 Hz) |
| Rated control supply voltage range with reference to U_s | 0.8 ... 1.25 | 0.4 ... 1.1 |
| Rated control supply current I_s at U_s | 40 mA | 4 mA |
| Rated actuating voltage U_c R/L | 24 V DC | 230 V AC |
| Rated actuating voltage range with reference to U_c | 0.8 ... 1.25 | 0.4 ... 1.1 |
| Rated actuating current I_c at U_c | 5 mA | 7 mA |
| Input circuit | Protection against polarity reversal, Surge protection | Surge protection |
| Operating voltage / status / error indicator | Green LED / Yellow LED / Red LED | |
| Output data load side | | |
| Output voltage range | 42 V AC ... 550 V AC | 42 V AC ... 550 V AC |
| Load current | max. 600 mA (see derating curve) | max. 600 mA (see derating curve) |
| Surge current | 100 A (t = 10 ms) | 100 A (t = 10 ms) |
| Min. load current | 75 mA | 75 mA |
| Residual voltage | < 0.2 V | < 0.2 V |
| Output protection | Surge protection | |
| General data | | |
| Rated insulation voltage | 500 V | |
| Rated surge voltage | 6 kV/safe isolation | 6 kV/safe isolation |
| Ambient temperature (operation) | -25°C ... 70°C | |
| Electrical service life | 3 x 10 ⁷ cycles | |
| Standards/regulations | DIN EN 50178 / EN 60947 | |
| Mounting position | Vertical (horizontal DIN rail) | |
| Mounting | Can be aligned with spacing = 20 mm | |
| Connection data solid / stranded / AWG | 0.14 - 2.5 mm ² / 0.14 - 2.5 mm ² / 26 - 14 | |
| Dimensions | 22.5 mm / 99 mm / 114.5 mm | |
| Safety data | | |
| EC-type examination certificate according to ATEX | Ex II (2) G, Ex II (2) D PTB 07 ATEX 3145 | Ex II (2) G, Ex II (2) D PTB 07 ATEX 3145 |

| | | |
|--|---|--|
| Technical data | | |
| Rated control supply voltage U_s | 24 V DC | 230 V AC (50/60 Hz) |
| Rated control supply voltage range with reference to U_s | 0.8 ... 1.25 | 0.4 ... 1.1 |
| Rated control supply current I_s at U_s | 40 mA | 4 mA |
| Rated actuating voltage U_c R/L | 24 V DC | 230 V AC |
| Rated actuating voltage range with reference to U_c | 0.8 ... 1.25 | 0.4 ... 1.1 |
| Rated actuating current I_c at U_c | 5 mA | 7 mA |
| Input circuit | Protection against polarity reversal, Surge protection | Surge protection |
| Operating voltage / status / error indicator | Green LED / Yellow LED / Red LED | |
| Output data load side | | |
| Output voltage range | 42 V AC ... 550 V AC | 42 V AC ... 550 V AC |
| Load current | max. 2.4 A (see derating curve) | max. 2.4 A (see derating curve) |
| Surge current | 100 A (t = 10 ms) | 100 A (t = 10 ms) |
| Min. load current | 180 mA | 180 mA |
| Residual voltage | < 0.3 V | < 0.3 V |
| Output protection | Surge protection | |
| General data | | |
| Rated insulation voltage | 500 V | |
| Rated surge voltage | 6 kV/safe isolation | 6 kV/safe isolation |
| Ambient temperature (operation) | -25°C ... 70°C | |
| Electrical service life | 3 x 10 ⁷ cycles | |
| Standards/regulations | DIN EN 50178 / EN 60947 | |
| Mounting position | Vertical (horizontal DIN rail) | |
| Mounting | Can be aligned with spacing = 20 mm | |
| Connection data solid / stranded / AWG | 0.14 - 2.5 mm ² / 0.14 - 2.5 mm ² / 26 - 14 | |
| Dimensions | 22.5 mm / 99 mm / 114.5 mm | |
| Safety data | | |
| EC-type examination certificate according to ATEX | Ex II (2) G, Ex II (2) D PTB 07 ATEX 3145 | Ex II (2) G, Ex II (2) D PTB 07 ATEX 3145 |

Technical data

| | | |
|--|---|--|
| Input data | | |
| Rated control supply voltage U_s | 24 V DC | 230 V AC (50/60 Hz) |
| Rated control supply voltage range with reference to U_s | 0.8 ... 1.25 | 0.4 ... 1.1 |
| Rated control supply current I_s at U_s | 40 mA | 4 mA |
| Rated actuating voltage U_c R/L | 24 V DC | 230 V AC |
| Rated actuating voltage range with reference to U_c | 0.8 ... 1.25 | 0.4 ... 1.1 |
| Rated actuating current I_c at U_c | 5 mA | 7 mA |
| Input circuit | Protection against polarity reversal, Surge protection | Surge protection |
| Operating voltage / status / error indicator | Green LED / Yellow LED / Red LED | |
| Output data load side | | |
| Output voltage range | 42 V AC ... 550 V AC | 42 V AC ... 550 V AC |
| Load current | max. 2.4 A (see derating curve) | max. 2.4 A (see derating curve) |
| Surge current | 100 A (t = 10 ms) | 100 A (t = 10 ms) |
| Min. load current | 180 mA | 180 mA |
| Residual voltage | < 0.3 V | < 0.3 V |
| Output protection | Surge protection | |
| General data | | |
| Rated insulation voltage | 500 V | |
| Rated surge voltage | 6 kV/safe isolation | 6 kV/safe isolation |
| Ambient temperature (operation) | -25°C ... 70°C | |
| Electrical service life | 3 x 10 ⁷ cycles | |
| Standards/regulations | DIN EN 50178 / EN 60947 | |
| Mounting position | Vertical (horizontal DIN rail) | |
| Mounting | Can be aligned with spacing = 20 mm | |
| Connection data solid / stranded / AWG | 0.14 - 2.5 mm ² / 0.14 - 2.5 mm ² / 26 - 14 | |
| Dimensions | 22.5 mm / 99 mm / 114.5 mm | |
| Safety data | | |
| EC-type examination certificate according to ATEX | Ex II (2) G, Ex II (2) D PTB 07 ATEX 3145 | Ex II (2) G, Ex II (2) D PTB 07 ATEX 3145 |

Ordering data

| | | |
|---|-------------------------------|---------|
| Description | | |
| "4 in 1" hybrid motor starter, incl. right contactor, left contactor, motor protection relay, and emergency stop | | |
| Screw connection | ELR H5-IES-SC- 24DC/500AC-0,6 | 2900582 |
| Push-in connection | ELR H5-IES-PT-24DC/500AC-0,6 | 2903902 |
| Screw connection | ELR H5-IES-SC-230AC/500AC-0,6 | 2900692 |
| "4 in 1" hybrid motor starter, incl. right contactor, left contactor, motor protection relay, and emergency stop, terminals L1, L2, L3 and T1, T2, T3 rotated | | |

| | | |
|-------------|------------------|--------------------|
| Type | Order No. | Pcs. / Pkt. |
| | | |
| | | |
| | | |
| | | |
| | | |

Ordering data

| | | |
|---|-----------------------------|---------|
| Description | | |
| "4 in 1" hybrid motor starter, incl. right contactor, left contactor, motor protection relay, and emergency stop | | |
| Screw connection | ELR H5-IES-SC- 24DC/500AC-2 | 2900414 |
| Push-in connection | ELR H5-IES-PT-24DC/500AC-2 | 2903904 |
| Screw connection | ELR H5-IES-SC-230AC/500AC-2 | 2900420 |
| "4 in 1" hybrid motor starter, incl. right contactor, left contactor, motor protection relay, and emergency stop, terminals L1, L2, L3 and T1, T2, T3 rotated | | |
| | | |
| | | |
| | | |
| | | |
| | | |
| | | |



For reversing 3~ AC motors up to 550 V AC/3 x 9 A

CB Ex: Ex



Technical data

24 V DC 230 V AC (50/60 Hz)
0.8 ... 1.25 0.4 ... 1.1

40 mA 4 mA
24 V DC 230 V AC
0.8 ... 1.25 0.4 ... 1.1

5 mA 7 mA
Protection against polarity reversal, Surge protection
Surge protection

Green LED / Yellow LED / Red LED

42 V AC ... 550 V AC 42 V AC ... 550 V AC
max. 9 A max. 9 A
(see derating curve) (see derating curve)

100 A (t = 10 ms) 100 A (t = 10 ms)
1.5 A 1.5 A
< 0.5 V < 0.5 V
Surge protection

500 V 6 kV/safe isolation 6 kV/safe isolation
-25°C ... 70°C
3 x 10⁷ cycles
DIN EN 50178 / EN 60947
Vertical (horizontal DIN rail)
Can be aligned with spacing = 20 mm
0.14 - 2.5 mm² / 0.14 - 2.5 mm² / 26 - 14
22.5 mm / 99 mm / 114.5 mm

Ex II (2) G, Ex II (2) D Ex II (2) G, Ex II (2) D
PTB 07 ATEX 3145 PTB 07 ATEX 3145

Ordering data

| Type | Order No. | Pcs. / Pkt. |
|-----------------------------|-----------|-------------|
| ELR H5-IES-SC- 24DC/500AC-9 | 2900421 | 1 |
| ELR H5-IES-PT-24DC/500AC-9 | 2903906 | 1 |
| ELR H5-IES-SC-230AC/500AC-9 | 2900422 | 1 |
| ELR W3- 24DC/500AC- 9I | 2297057 | 1 |
| ELR W3-230AC/500AC- 9I | 2297060 | 1 |

Conventional structure Main current path reversing contactor according to category 3

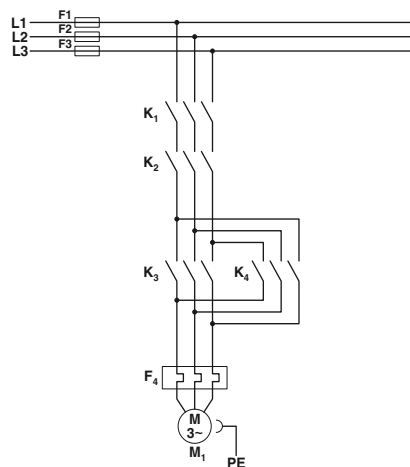

K1 + K2 = Emergency stop contactor
K3 = Left contactor
K4 = Right contactor
F4 = Motor protection relay

Structure with CONTACTRON Main and control current path for "4 in 1" hybrid motor starter with reversing function according to category 3

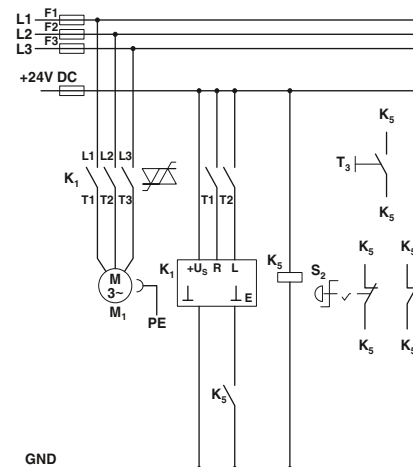

K1 = "4 in 1" hybrid motor starter with reversing function
K5 = PSR SCP-24DC.../Safety relay
T1 = Left, T2 = Right, T3 = Reset
S2 = Emergency stop

Conventional structure Control current path reversing contactor according to category 3

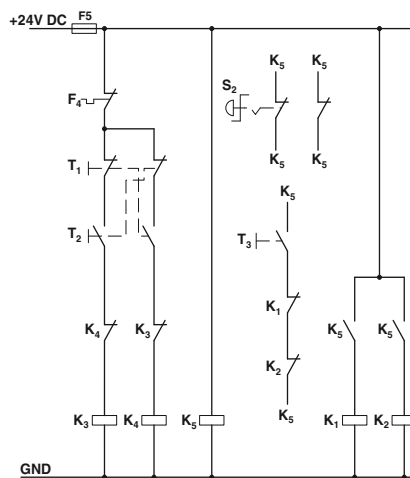

K1 + K2 = Emergency stop contactor
K3 = Left contactor
K4 = Right contactor
K5 = PSR SCP-24DC.../Safety relay
T1 = Left, T2 = Right, T3 = Reset
S2 = Emergency stop
F4 = Motor protection relay

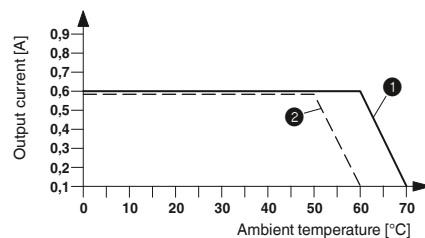

Derating curve ELR H5-IES-SC-230AC/500AC-0,6 100% operating time

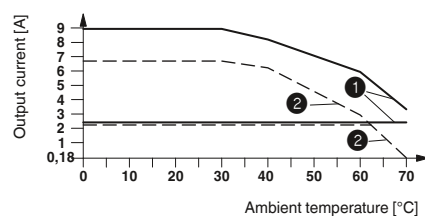

Derating curve ELR H5-IES-SC-24DC/500AC-2 and ELR H5-IES-SC-24DC/500AC-9 100% operating time

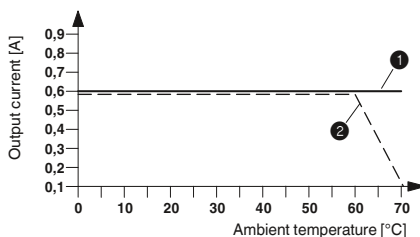

Derating curve ELR H5-IES-SC-24DC/500AC-0,6 100% operating time

1 Aligned with > 20 mm spacing
2 Aligned without spacing

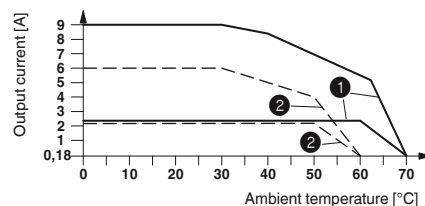

Derating curve ELR H5-IES-SC-230AC/500AC-2 and ELR H5-IES-SC-230AC/500AC-9 100% operating time

Electronic switchgear and motor control

Hybrid motor starters

"3 in 1" hybrid motor starter with motor protection and emergency stop

These 3-phase "3 in 1" hybrid motor starters combine three functions in one device: right contactor, motor protection relay, and emergency stop up to category 3.

Offer the following advantages:

- 22.5 mm wide
- They save wiring
- Bi-metal function can be set up to 9 A
- Long service life
- Space-saving
- 3-phase loop bridging
- Safety level according to:
 - IEC 61508-1: SIL3
 - ISO 13849: PL e



For starting 3~ AC motors up to 550 V AC/3 x 0.6 A



For starting 3~ AC motors up to 550 V AC/3 x 2 A



| Notes: | |
|---------------------------------------|--|
| Type of housing: | Polyamide PA non-reinforced, color: green. |
| Marking systems and mounting material | See Catalog 5 |

| Technical data | |
|--|--|
| Rated control supply voltage U_s | 24 V DC / 230 V AC (50/60 Hz) |
| Rated control supply voltage range with reference to U_s | 0.8 ... 1.25 / 0.4 ... 1.1 |
| Rated control supply current I_s at U_s | 40 mA / 4 mA |
| Rated actuation voltage U_c ON | 24 V DC / 230 V AC |
| Rated actuating voltage range with reference to U_c | 0.8 ... 1.25 / 0.4 ... 1.1 |
| Rated actuating current I_c at U_c | 5 mA / 7 mA |
| Input circuit | Protection against polarity reversal, Surge protection |
| Operating voltage / status / error indicator | Green LED / Yellow LED / Red LED |
| Output data load side | |
| Output voltage range | 42 V AC ... 550 V AC / 42 V AC ... 550 V AC |
| Load current | max. 600 mA / max. 600 mA (see derating curve) |
| Surge current | 100 A (t = 10 ms) / 100 A (t = 10 ms) |
| Min. load current | 75 mA / 75 mA |
| Residual voltage | < 0.2 V / < 0.2 V |
| Output protection | Surge protection |
| General data | |
| Rated insulation voltage | 500 V |
| Rated surge voltage | 6 kV/safe isolation / 6 kV/safe isolation |
| Ambient temperature (operation) | -25°C ... 70°C |
| Electrical service life | 3 x 10 ⁷ cycles |
| Standards/regulations | DIN EN 50178 / EN 60947 |
| Mounting position | Vertical (horizontal DIN rail) |
| Mounting | Can be aligned with spacing = 20 mm |
| Connection data solid / stranded / AWG | 0.14 - 2.5 mm ² / 0.14 - 2.5 mm ² / 26 - 14 |
| Dimensions | 22.5 mm / 99 mm / 114.5 mm |
| Safety data | <div style="display: flex; justify-content: space-around;"> Ex II (2) G, Ex II (2) D PTB 07 ATEX 3145 Ex II (2) G, Ex II (2) D PTB 07 ATEX 3145 </div> |

| Technical data | |
|--|--|
| Rated control supply voltage U_s | 24 V DC / 230 V AC (50/60 Hz) |
| Rated control supply voltage range with reference to U_s | 0.8 ... 1.25 / 0.4 ... 1.1 |
| Rated control supply current I_s at U_s | 40 mA / 4 mA |
| Rated actuation voltage U_c ON | 24 V DC / 230 V AC |
| Rated actuating voltage range with reference to U_c | 0.8 ... 1.25 / 0.4 ... 1.1 |
| Rated actuating current I_c at U_c | 5 mA / 7 mA |
| Input circuit | Protection against polarity reversal, Surge protection |
| Operating voltage / status / error indicator | Green LED / Yellow LED / Red LED |
| Output data load side | |
| Output voltage range | 42 V AC ... 550 V AC / 42 V AC ... 550 V AC |
| Load current | max. 2.4 A / max. 2.4 A (see derating curve) |
| Surge current | 100 A (t = 10 ms) / 100 A (t = 10 ms) |
| Min. load current | 180 mA / 180 mA |
| Residual voltage | < 0.3 V / < 0.3 V |
| Output protection | Surge protection |
| General data | |
| Rated insulation voltage | 500 V |
| Rated surge voltage | 6 kV/safe isolation / 6 kV/safe isolation |
| Ambient temperature (operation) | -25°C ... 70°C |
| Electrical service life | 3 x 10 ⁷ cycles |
| Standards/regulations | DIN EN 50178 / EN 60947 |
| Mounting position | Vertical (horizontal DIN rail) |
| Mounting | Can be aligned with spacing = 20 mm |
| Connection data solid / stranded / AWG | 0.14 - 2.5 mm ² / 0.14 - 2.5 mm ² / 26 - 14 |
| Dimensions | 22.5 mm / 99 mm / 114.5 mm |
| Safety data | <div style="display: flex; justify-content: space-around;"> Ex II (2) G, Ex II (2) D PTB 07 ATEX 3145 Ex II (2) G, Ex II (2) D PTB 07 ATEX 3145 </div> |

| Ordering data | | |
|-------------------------------|-----------|-------------|
| Type | Order No. | Pcs. / Pkt. |
| ELR H3-IES-SC- 24DC/500AC-0,6 | 2900566 | 1 |
| ELR H3-IES-PT-24DC/500AC-0,6 | 2903914 | 1 |
| ELR H3-IES-SC-230AC/500AC-0,6 | 2900689 | 1 |

| Ordering data | | |
|-----------------------------|-----------|-------------|
| Type | Order No. | Pcs. / Pkt. |
| ELR H3-IES-SC- 24DC/500AC-2 | 2900567 | 1 |
| ELR H3-IES-PT-24DC/500AC-2 | 2903916 | 1 |
| ELR H3-IES-SC-230AC/500AC-2 | 2900568 | 1 |

| Description |
|--|
| "3 in 1" hybrid motor starter, incl. right contactor, motor protection relay, and emergency stop |
| Screw connection |
| Push-in connection |
| Screw connection |



For starting 3~ AC motors up to 550 V AC/3 x 9 A

CB Ex: Ex

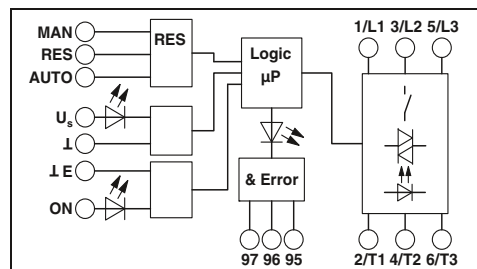
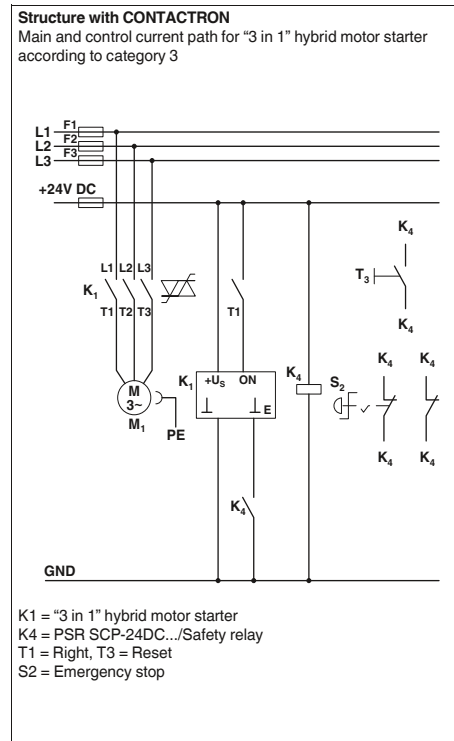
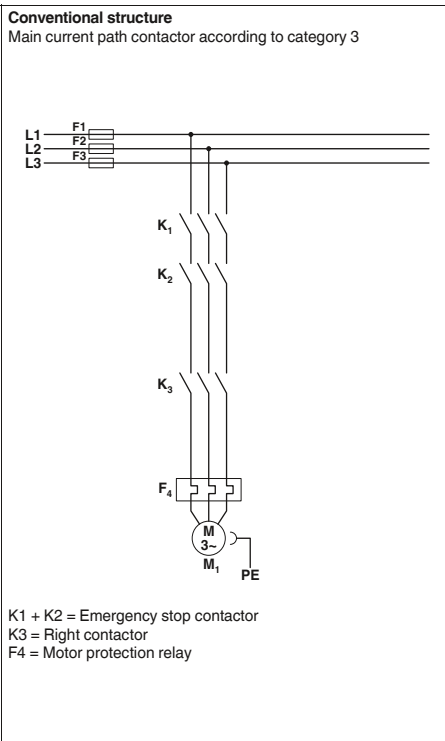

Technical data

| | |
|---|---|
| 24 V DC 0.8 ... 1.25 | 230 V AC (50/60 Hz) 0.4 ... 1.1 |
| 40 mA 24 V DC 0.8 ... 1.25 | 4 mA 230 V AC 0.4 ... 1.1 |
| 5 mA Protection against polarity reversal, Surge protection | 7 mA Surge protection |
| Green LED / Yellow LED / Red LED | |
| 42 V AC ... 550 V AC max. 9 A (see derating curve) | 42 V AC ... 550 V AC max. 9 A (see derating curve) |
| 100 A (t = 10 ms) 1.5 A < 0.5 V Surge protection | 100 A (t = 10 ms) 1.5 A < 0.5 V Surge protection |
| 500 V 6 kV/safe isolation -25°C ... 70°C 3 x 10 ⁷ cycles DIN EN 50178 / EN 60947 Vertical (horizontal DIN rail) Can be aligned with spacing = 20 mm 0.14 - 2.5 mm ² / 0.14 - 2.5 mm ² / 26 - 14 22.5 mm / 99 mm / 114.5 mm | 6 kV/safe isolation |
| Ex II (2) G, Ex II (2) D PTB 07 ATEX 3145 | Ex II (2) G, Ex II (2) D PTB 07 ATEX 3145 |

Ordering data

| Type | Order No. | Pcs. / Pkt. |
|-----------------------------|-----------|-------------|
| ELR H3-IES-SC- 24DC/500AC-9 | 2900569 | 1 |
| ELR H3-IES-PT-24DC/500AC-9 | 2903918 | 1 |
| ELR H3-IES-SC-230AC/500AC-9 | 2900570 | 1 |

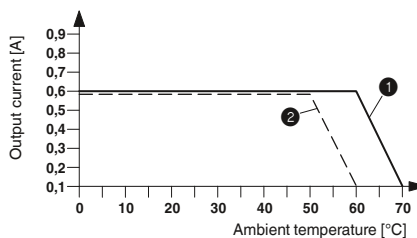
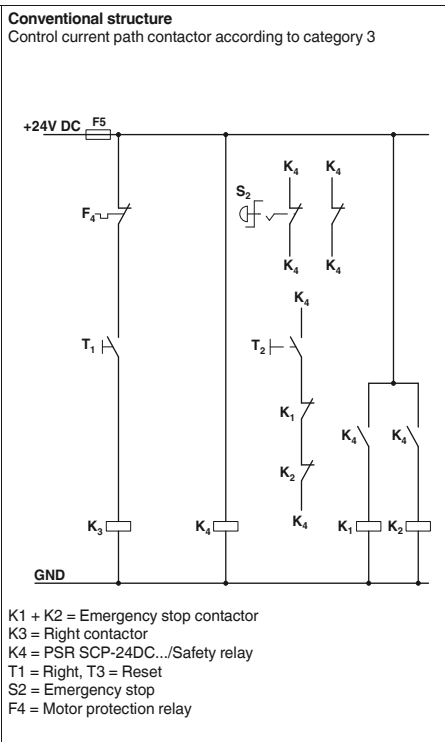

Derating curve ELR H3-IES-SC-230AC/500AC-0,6
100% operating time

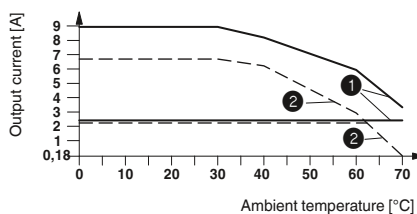

Derating curve ELR H3-IES-SC-24DC/500AC-2 and
ELR H3-IES-SC-24DC/500AC-9
100% operating time

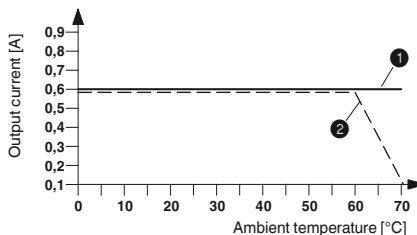

Derating curve ELR H3-IES-SC-24DC/500AC-0,6
100% operating time

- ① Aligned with > 20 mm spacing
- ② Aligned without spacing

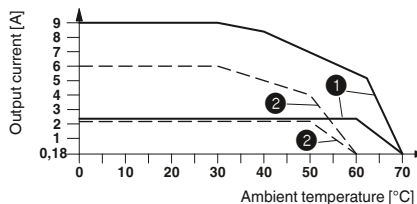

Derating curve ELR H3-IES-SC-230AC/500AC-2 and
ELR H3-IES-SC-230AC/500AC-9
100% operating time

Hybrid motor starters

"3 in 1" hybrid motor starter with reversing function and motor protection

These 3-phase "3 in 1" hybrid motor starters combine three functions in one device: right contactor, left contactor, and motor protection relay.

Offer the following advantages:

- 22.5 mm wide
- They save wiring
- Bi-metal function can be set up to 9 A
- Long service life
- Space-saving
- 3-phase loop bridging



For starting 3~ AC motors up to 550 V AC/3 x 0.6 A



For starting 3~ AC motors up to 550 V AC/3 x 2 A

| |
|--|
| Notes: |
| Type of housing: Polyamide PA non-reinforced, color: green. |
| Marking systems and mounting material See Catalog 5 |

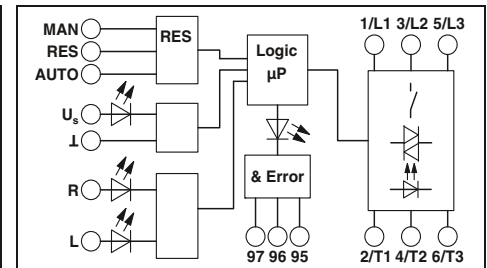
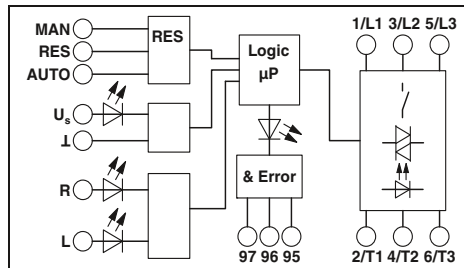

| Input data | |
|--|---|
| Rated control supply voltage U_s | 24 V DC |
| Rated control supply voltage range with reference to U_s | 0.8 ... 1.25 |
| Rated control supply current I_s at U_s | 40 mA |
| Rated actuation voltage U_c ON | 24 V DC |
| Rated actuating voltage range with reference to U_c | 0.8 ... 1.25 |
| Rated actuating current I_c at U_c | 5 mA |
| Input circuit | Protection against polarity reversal, Surge protection |
| Operating voltage / status / error indicator | Green LED / Yellow LED / Red LED |
| Output data load side | |
| Output voltage range | 42 V AC ... 550 V AC |
| Load current | max. 600 mA (see derating curve) |
| Surge current | 100 A (t = 10 ms) |
| Min. load current | 75 mA |
| Residual voltage | < 0.2 V |
| Output protection | Surge protection |
| General data | |
| Rated insulation voltage | 500 V |
| Rated surge voltage | 6 kV/safe isolation |
| Ambient temperature (operation) | -25°C ... 70°C |
| Electrical service life | 3 x 10 ⁷ cycles |
| Standards/regulations | DIN EN 50178 / EN 60947 |
| Mounting position | Vertical (horizontal DIN rail) |
| Mounting | Can be aligned with spacing = 20 mm |
| Screw connection solid / stranded / AWG | 0.14 - 2.5 mm ² / 0.14 - 2.5 mm ² / 26 - 14 |
| Dimensions | 22.5 mm / 99 mm / 114.5 mm |

| Technical data | |
|--|---|
| Rated control supply voltage U_s | 230 V AC (50/60 Hz) |
| Rated control supply voltage range with reference to U_s | 0.4 ... 1.1 |
| Rated control supply current I_s at U_s | 4 mA |
| Rated actuation voltage U_c ON | 230 V AC |
| Rated actuating voltage range with reference to U_c | 0.4 ... 1.1 |
| Rated actuating current I_c at U_c | 7 mA |
| Input circuit | Surge protection |
| Operating voltage / status / error indicator | Green LED / Yellow LED / Red LED |
| Output data load side | |
| Output voltage range | 42 V AC ... 550 V AC |
| Load current | max. 600 mA (see derating curve) |
| Surge current | 100 A (t = 10 ms) |
| Min. load current | 75 mA |
| Residual voltage | < 0.2 V |
| Output protection | Surge protection |
| General data | |
| Rated insulation voltage | 500 V |
| Rated surge voltage | 6 kV/safe isolation |
| Ambient temperature (operation) | -25°C ... 70°C |
| Electrical service life | 3 x 10 ⁷ cycles |
| Standards/regulations | DIN EN 50178 / EN 60947 |
| Mounting position | Vertical (horizontal DIN rail) |
| Mounting | Can be aligned with spacing = 20 mm |
| Screw connection solid / stranded / AWG | 0.14 - 2.5 mm ² / 0.14 - 2.5 mm ² / 26 - 14 |
| Dimensions | 22.5 mm / 99 mm / 114.5 mm |

| Technical data | |
|--|---|
| Rated control supply voltage U_s | 230 V AC (50/60 Hz) |
| Rated control supply voltage range with reference to U_s | 0.4 ... 1.1 |
| Rated control supply current I_s at U_s | 40 mA |
| Rated actuation voltage U_c ON | 230 V AC |
| Rated actuating voltage range with reference to U_c | 0.4 ... 1.1 |
| Rated actuating current I_c at U_c | 7 mA |
| Input circuit | Protection against polarity reversal, Surge protection |
| Operating voltage / status / error indicator | Green LED / Yellow LED / Red LED |
| Output data load side | |
| Output voltage range | 42 V AC ... 550 V AC |
| Load current | max. 2.4 A (see derating curve) |
| Surge current | 100 A (t = 10 ms) |
| Min. load current | 180 mA |
| Residual voltage | < 0.3 V |
| Output protection | Surge protection |
| General data | |
| Rated insulation voltage | 500 V |
| Rated surge voltage | 6 kV/safe isolation |
| Ambient temperature (operation) | -25°C ... 70°C |
| Electrical service life | 3 x 10 ⁷ cycles |
| Standards/regulations | DIN EN 50178 / EN 60947 |
| Mounting position | Vertical (horizontal DIN rail) |
| Mounting | Can be aligned with spacing = 20 mm |
| Screw connection solid / stranded / AWG | 0.14 - 2.5 mm ² / 0.14 - 2.5 mm ² / 26 - 14 |
| Dimensions | 22.5 mm / 99 mm / 114.5 mm |

| Ordering data | |
|--|------------------|
| Description | |
| "3 in 1" hybrid motor starter, incl. right contactor, left contactor, and motor protection relay | |
| Type | Order No. |
| ELR H5-I-SC- 24DC/500AC-0,6 | 2900573 |
| ELR H5-I-SC-230AC/500AC-0,6 | 2900691 |

| Ordering data | |
|---------------------------|------------------|
| Type | Order No. |
| ELR H5-I-SC- 24DC/500AC-2 | 2900574 |
| ELR H5-I-SC-230AC/500AC-2 | 2900575 |

| Ordering data | |
|---------------------------|------------------|
| Type | Order No. |
| ELR H5-I-SC- 24DC/500AC-2 | 2900574 |
| ELR H5-I-SC-230AC/500AC-2 | 2900575 |



For starting 3~ AC motors up to 550 V AC/3 x 9 A



Technical data

24 V DC 0.8 ... 1.25 230 V AC (50/60 Hz) 0.4 ... 1.1

40 mA 24 V DC 0.8 ... 1.25 4 mA 230 V AC 0.4 ... 1.1

5 mA Protection against polarity reversal, Surge protection 7 mA Surge protection

Green LED / Yellow LED / Red LED

42 V AC ... 550 V AC max. 9 A (see derating curve) 42 V AC ... 550 V AC max. 9 A (see derating curve)

100 A (t = 10 ms) 1.5 A < 0.5 V Surge protection 100 A (t = 10 ms) 1.5 A < 0.5 V

500 V 6 kV/safe isolation -25°C ... 70°C 3 x 10⁷ cycles DIN EN 50178 / EN 60947 Vertical (horizontal DIN rail) Can be aligned with spacing = 20 mm 0.14 - 2.5 mm² / 0.14 - 2.5 mm² / 26 - 14 22.5 mm / 99 mm / 114.5 mm

Ordering data

| Type | Order No. | Pcs. / Pkt. |
|---------------------------|-----------|-------------|
| ELR H5-I-SC- 24DC/500AC-9 | 2900576 | 1 |
| ELR H5-I-SC-230AC/500AC-9 | 2900578 | 1 |

Conventional structure Main current path contactor according to category 3

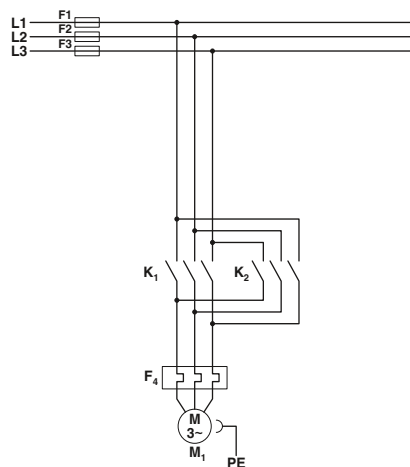

K1 = Left contactor
K2 = Right contactor
F4 = Motor protection relay

Conventional structure Control current path contactor according to category 3

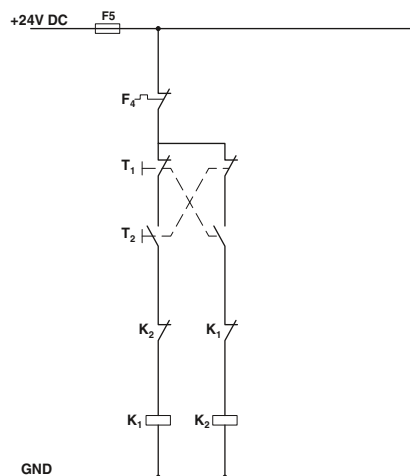

K1 = Left contactor
K2 = Right contactor
T1 = Right, T2 = Left, T3 = Reset
F4 = Motor protection relay

Structure with CONTACTRON Main and control current path for "3 in 1" hybrid motor starter according to category 3

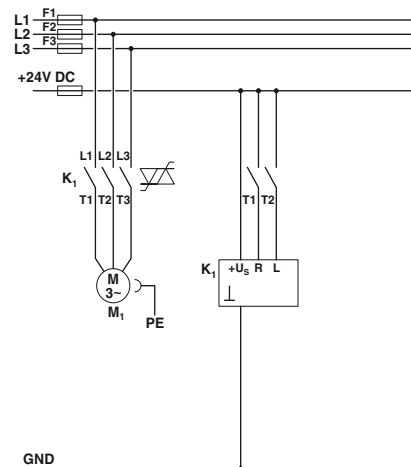

K1 = "3 in 1" hybrid motor starter
T1 = Right, T2 = Left, T3 = Reset

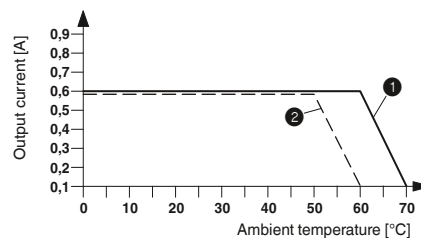

Derating curve ELR H5-I-SC-230AC/500AC-0,6 100% operating time

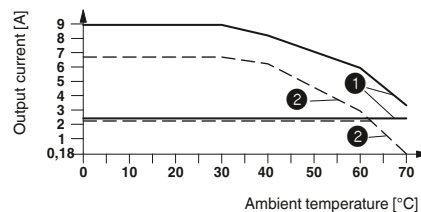

Derating curve ELR H5-I-SC-24DC/500AC-2 and ELR H5-I-SC-24DC/500AC-99 100% operating time

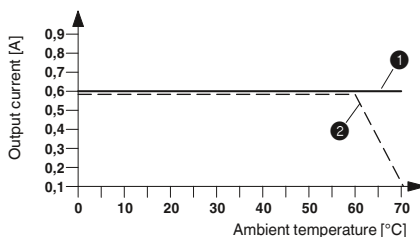

Derating curve ELR H5-I-SC-24DC/500AC-0,6 100% operating time

- ① Aligned with > 20 mm spacing
- ② Aligned without spacing

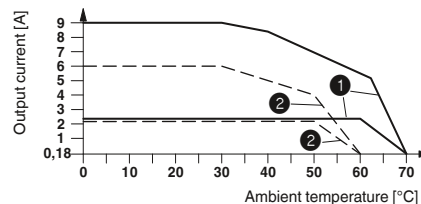

Derating curve ELR H5-I-SC-230AC/500AC-2 and ELR H5-I-SC-230AC/500AC-9 100% operating time

Hybrid motor starters

"2 in 1" hybrid motor starter with motor protection

These 3-phase "2 in 1" hybrid motor starters combine two functions in one device: right contactor and motor protection.

The devices offer the following advantages:

- 22.5 mm wide
- They save wiring
- Bi-metal function can be set up to 9 A
- Low-wear switching
- Long service life
- Space-saving
- 3-phase loop bridging



For starting 3~ AC motors up to 550 V AC/3 x 0.6 A



For starting 3~ AC motors up to 550 V AC/3 x 2 A

| |
|--|
| Notes: |
| Type of housing: Polyamide PA non-reinforced, color: green. |
| Marking systems and mounting material See Catalog 5 |



| Input data | |
|--|---|
| Rated control supply voltage U_s | 24 V DC |
| Rated control supply voltage range with reference to U_s | 0.8 ... 1.25 |
| Rated control supply current I_s at U_s | 40 mA |
| Rated actuation voltage U_c ON | 24 V DC |
| Rated actuating voltage range with reference to U_c | 0.8 ... 1.25 |
| Rated actuating current I_c at U_c | 5 mA |
| Input circuit | Protection against polarity reversal, Surge protection |
| Operating voltage / status / error indicator | Green LED / Yellow LED / Red LED |
| Output data load side | |
| Output voltage range | 42 V AC ... 550 V AC |
| Load current | max. 600 mA (see derating curve) |
| Surge current | 100 A (t = 10 ms) |
| Min. load current | 75 mA |
| Residual voltage | < 0.2 V |
| Output protection | Surge protection |
| General data | |
| Rated insulation voltage | 500 V |
| Rated surge voltage | 6 kV/safe isolation |
| Ambient temperature (operation) | -25°C ... 70°C |
| Electrical service life | 3 x 10 ⁷ cycles |
| Standards/regulations | DIN EN 50178 / EN 60947 |
| Mounting position | Vertical (horizontal DIN rail) |
| Mounting | Can be aligned with spacing = 20 mm |
| Screw connection solid / stranded / AWG | 0.14 - 2.5 mm ² / 0.14 - 2.5 mm ² / 26 - 14 |
| Dimensions | 22.5 mm / 99 mm / 114.5 mm |

Technical data

| | | |
|--|--|---------------------|
| Rated control supply voltage U_s | 24 V DC | 230 V AC (50/60 Hz) |
| Rated control supply voltage range with reference to U_s | 0.8 ... 1.25 | 0.4 ... 1.1 |
| Rated control supply current I_s at U_s | 40 mA | 4 mA |
| Rated actuation voltage U_c ON | 24 V DC | 230 V AC |
| Rated actuating voltage range with reference to U_c | 0.8 ... 1.25 | 0.4 ... 1.1 |
| Rated actuating current I_c at U_c | 5 mA | 7 mA |
| Input circuit | Protection against polarity reversal, Surge protection | Surge protection |
| Operating voltage / status / error indicator | Green LED / Yellow LED / Red LED | |

| | | |
|-----------------------|----------------------------------|----------------------------------|
| Output data load side | 42 V AC ... 550 V AC | 42 V AC ... 550 V AC |
| Output voltage range | max. 600 mA (see derating curve) | max. 600 mA (see derating curve) |
| Load current | max. 600 mA (see derating curve) | max. 600 mA (see derating curve) |
| Surge current | 100 A (t = 10 ms) | 100 A (t = 10 ms) |
| Min. load current | 75 mA | 75 mA |
| Residual voltage | < 0.2 V | < 0.2 V |
| Output protection | Surge protection | Surge protection |

| | | |
|---|---|---|
| Rated insulation voltage | 500 V | 500 V |
| Rated surge voltage | 6 kV/safe isolation | 6 kV/safe isolation |
| Ambient temperature (operation) | -25°C ... 70°C | -25°C ... 70°C |
| Electrical service life | 3 x 10 ⁷ cycles | 3 x 10 ⁷ cycles |
| Standards/regulations | DIN EN 50178 / EN 60947 | DIN EN 50178 / EN 60947 |
| Mounting position | Vertical (horizontal DIN rail) | Vertical (horizontal DIN rail) |
| Mounting | Can be aligned with spacing = 20 mm | Can be aligned with spacing = 20 mm |
| Screw connection solid / stranded / AWG | 0.14 - 2.5 mm ² / 0.14 - 2.5 mm ² / 26 - 14 | 0.14 - 2.5 mm ² / 0.14 - 2.5 mm ² / 26 - 14 |
| Dimensions | 22.5 mm / 99 mm / 114.5 mm | 22.5 mm / 99 mm / 114.5 mm |

Technical data

| | | |
|--|--|---------------------|
| Rated control supply voltage U_s | 24 V DC | 230 V AC (50/60 Hz) |
| Rated control supply voltage range with reference to U_s | 0.8 ... 1.25 | 0.4 ... 1.1 |
| Rated control supply current I_s at U_s | 40 mA | 4 mA |
| Rated actuation voltage U_c ON | 24 V DC | 230 V AC |
| Rated actuating voltage range with reference to U_c | 0.8 ... 1.25 | 0.4 ... 1.1 |
| Rated actuating current I_c at U_c | 5 mA | 7 mA |
| Input circuit | Protection against polarity reversal, Surge protection | Surge protection |
| Operating voltage / status / error indicator | Green LED / Yellow LED / Red LED | |

| | | |
|-----------------------|---------------------------------|---------------------------------|
| Output data load side | 42 V AC ... 550 V AC | 42 V AC ... 550 V AC |
| Output voltage range | max. 2.4 A (see derating curve) | max. 2.4 A (see derating curve) |
| Load current | max. 2.4 A (see derating curve) | max. 2.4 A (see derating curve) |
| Surge current | 100 A (t = 10 ms) | 100 A (t = 10 ms) |
| Min. load current | 180 mA | 180 mA |
| Residual voltage | < 0.3 V | < 0.3 V |
| Output protection | Surge protection | Surge protection |

| | | |
|---|---|---|
| Rated insulation voltage | 500 V | 500 V |
| Rated surge voltage | 6 kV/safe isolation | 6 kV/safe isolation |
| Ambient temperature (operation) | -25°C ... 70°C | -25°C ... 70°C |
| Electrical service life | 3 x 10 ⁷ cycles | 3 x 10 ⁷ cycles |
| Standards/regulations | DIN EN 50178 / EN 60947 | DIN EN 50178 / EN 60947 |
| Mounting position | Vertical (horizontal DIN rail) | Vertical (horizontal DIN rail) |
| Mounting | Can be aligned with spacing = 20 mm | Can be aligned with spacing = 20 mm |
| Screw connection solid / stranded / AWG | 0.14 - 2.5 mm ² / 0.14 - 2.5 mm ² / 26 - 14 | 0.14 - 2.5 mm ² / 0.14 - 2.5 mm ² / 26 - 14 |
| Dimensions | 22.5 mm / 99 mm / 114.5 mm | 22.5 mm / 99 mm / 114.5 mm |

Ordering data

| Type | Order No. | Pcs. / Pkt. |
|-----------------------------|-----------|-------------|
| ELR H3-I-SC- 24DC/500AC-0,6 | 2900542 | 1 |
| ELR H3-I-SC-230AC/500AC-0,6 | 2900685 | 1 |

Ordering data

| Type | Order No. | Pcs. / Pkt. |
|---------------------------|-----------|-------------|
| ELR H3-I-SC- 24DC/500AC-2 | 2900543 | 1 |
| ELR H3-I-SC-230AC/500AC-2 | 2900544 | 1 |

| Description |
|---|
| "2 in 1" hybrid motor starter, incl. right contactor and motor protection relay |



For starting 3~ AC motors
up to 550 V AC/3 x 9 A

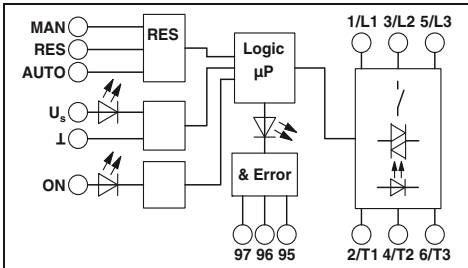

Technical data

24 V DC 0.8 ... 1.25 230 V AC (50/60 Hz) 0.4 ... 1.1

40 mA 24 V DC 0.8 ... 1.25 4 mA 230 V AC 0.4 ... 1.1

5 mA Protection against polarity reversal, Surge protection 7 mA Surge protection

Green LED / Yellow LED / Red LED

42 V AC ... 550 V AC max. 9 A (see derating curve) 42 V AC ... 550 V AC max. 9 A (see derating curve)

100 A (t = 10 ms) 1.5 A < 0.5 V 100 A (t = 10 ms) 1.5 A < 0.5 V

Surge protection

500 V 6 kV/safe isolation -25°C ... 70°C 3 x 10⁷ cycles 6 kV/safe isolation

DIN EN 50178 / EN 60947 Vertical (horizontal DIN rail) Can be aligned with spacing = 20 mm 0.14 - 2.5 mm² / 0.14 - 2.5 mm² / 26 - 14 22.5 mm / 99 mm / 114.5 mm

Ordering data

| Type | Order No. | Pcs. / Pkt. |
|---------------------------|-----------|-------------|
| ELR H3-I-SC- 24DC/500AC-9 | 2900545 | 1 |
| ELR H3-I-SC-230AC/500AC-9 | 2900546 | 1 |

Conventional structure
Main current path reversing contactor according to category 3

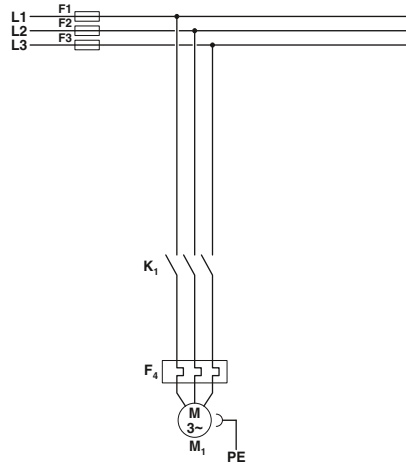

K1 = Right contactor
F4 = Motor protection relay

Conventional structure
Control current path contactor according to category 3

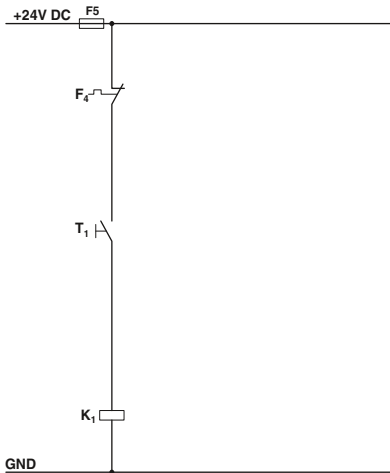

K1 = Right contactor
T1 = Right, T3 = Reset
F4 = Motor protection relay

Structure with CONTACTRON
Main and control current path for "2 in 1" hybrid motor starter according to category 3

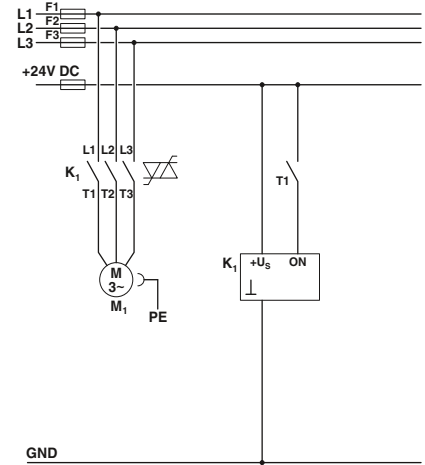

K1 = "2 in 1" hybrid motor starter
T1 = Right, T3 = Reset

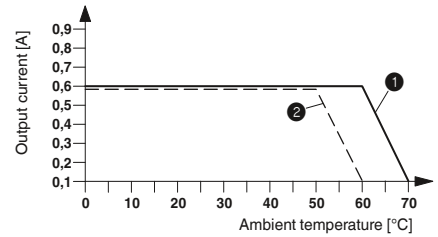

Derating curve ELR H3-I-SC-230AC/500AC-0,6
100% operating time

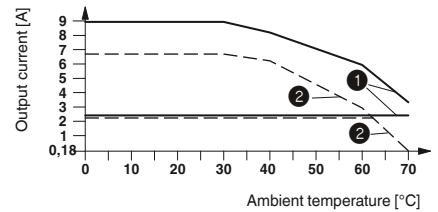

Derating curve ELR H3-I-SC-24DC/500AC-2 and
ELR H3-I-SC-24DC/500AC-9
100% operating time

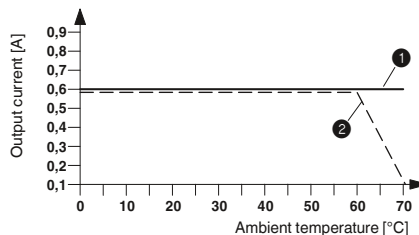

Derating curve ELR H3-I-SC-24DC/500AC-0,6
100% operating time

- ① Aligned with > 20 mm spacing
- ② Aligned without spacing

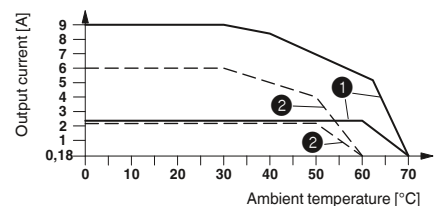

Derating curve ELR H3-I-SC-230AC/500AC-2 and
ELR H3-I-SC-230AC/500AC-9
100% operating time

Hybrid motor starters

"2 in 1" hybrid motor starter with reversing function

3-phase hybrid motor starter for reversing three-phase induction motors

The devices offer the following advantages:

- 22.5 mm wide
- They save wiring
- Up to 9 A
- Low-wear switching
- Long service life
- Space-saving
- 3-phase loop bridging

| Notes: |
|--|
| Type of housing: Polyamide PA non-reinforced, color: green. |
| Marking systems and mounting material See Catalog 5 |



For reversing 3~ AC motors
up to 550 V AC/3 x 9 A

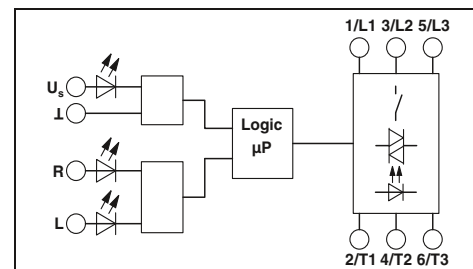

Technical data

| Input data | 24 V DC | 230 V AC (50/60 Hz) |
|--|---|----------------------|
| Rated control supply voltage U_s | 24 V DC | 230 V AC |
| Rated control supply voltage range with reference to U_s | 0.8 ... 1.25 | 0.4 ... 1.1 |
| Rated control supply current I_s at U_s | 40 mA | 4 mA |
| Rated actuating voltage U_c R/L | 24 V DC | 230 V AC |
| Rated actuating voltage range with reference to U_c | 0.8 ... 1.25 | 0.4 ... 1.1 |
| Rated actuating current I_c at U_c | 5 mA | 7 mA |
| Input circuit | Protection against polarity reversal, Surge protection | Surge protection |
| Operating voltage / status / error indicator | Green LED / Yellow LED / Red LED | |
| Output data load side | 42 V AC ... 550 V AC | 42 V AC ... 550 V AC |
| Output voltage range | max. 9 A | max. 9 A |
| Load current | (see derating curve) | (see derating curve) |
| Surge current | 100 A (t = 10 ms) | 100 A (t = 10 ms) |
| Minimum load current | 0 A | 0 A |
| Residual voltage | < 0.5 V | < 0.5 V |
| Output protection | Surge protection | |
| General data | 500 V | 6 kV/safe isolation |
| Rated insulation voltage | 6 kV/safe isolation | 6 kV/safe isolation |
| Rated surge voltage | -25°C ... 70°C | |
| Ambient temperature (operation) | 3 x 10 ⁷ cycles | |
| Electrical service life | DIN EN 50178 / EN 60947 | |
| Standards/regulations | Vertical (horizontal DIN rail) | |
| Mounting position | Can be aligned with spacing = 20 mm | |
| Mounting | 0.14 - 2.5 mm ² / 0.14 - 2.5 mm ² / 26 - 14 | |
| Screw connection solid / stranded / AWG | 22.5 mm / 99 mm / 114.5 mm | |
| Dimensions | W / H / D | |
| Description | "2 in 1" hybrid motor starter, incl. right contactor and left contactor | |

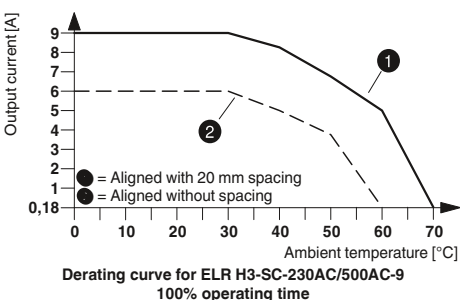
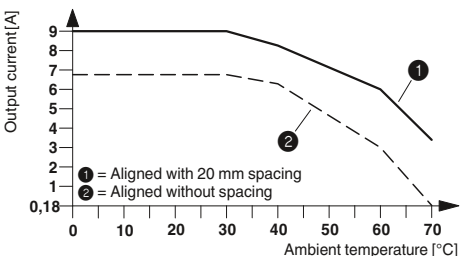

Ordering data

| Type | Order No. | Pcs. / Pkt. |
|-------------------------|-----------|-------------|
| ELR H5-SC- 24DC/500AC-9 | 2900538 | 1 |
| ELR H5-SC-230AC/500AC-9 | 2900539 | 1 |

“1 in 1” hybrid motor starter

3-phase hybrid motor starter for starting three-phase induction motors

The devices offer the following advantages:

- 22.5 mm wide
- Low-wear switching
- Up to 9 A
- Long service life
- Space-saving
- 3-phase loop bridging

| |
|--|
| Notes: |
| Type of housing: Polyamide PA non-reinforced, color: green. |
| Marking systems and mounting material See Catalog 5 |



For starting 3~ AC motors up to 550 V AC/3 x 9 A

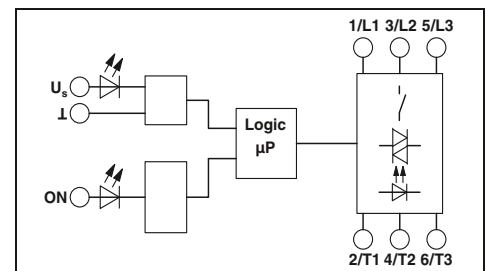

Technical data

| | | |
|--|---|----------------------------------|
| Input data | | |
| Rated control supply voltage U_s | 24 V DC | 230 V AC (50/60 Hz) |
| Rated control supply voltage range with reference to U_s | 0.8 ... 1.25 | 0.4 ... 1.1 |
| Rated control supply current I_s at U_s | 40 mA | 4 mA |
| Rated actuation voltage U_c ON | 24 V DC | 230 V AC |
| Rated actuating voltage range with reference to U_c | 0.8 ... 1.25 | 0.4 ... 1.1 |
| Rated actuating current I_c at U_c | 5 mA | 7 mA |
| Input circuit | Protection against polarity reversal, Surge protection | Surge protection |
| Operating voltage / status / error indicator | Green LED / Yellow LED / Red LED | |
| Output data load side | | |
| Output voltage range | 42 V AC ... 550 V AC | 42 V AC ... 550 V AC |
| Load current | max. 9 A (see derating curve) | max. 9 A (see derating curve) |
| Surge current | 100 A (t = 10 ms) | 100 A (t = 10 ms) |
| Minimum load current | 0 A | 0 A |
| Residual voltage | < 0.5 V | < 0.5 V |
| Output protection | Surge protection | |
| General data | | |
| Rated insulation voltage | 500 V | |
| Rated surge voltage | 6 kV/safe isolation | 6 kV/safe isolation |
| Ambient temperature (operation) | -25°C ... 70°C | |
| Electrical service life | 3 x 10 ⁷ cycles | |
| Standards/regulations | DIN EN 50178 / EN 60947 | |
| Mounting | Can be aligned with spacing = 20 mm | |
| Screw connection solid / stranded / AWG | 0.14 - 2.5 mm ² / 0.14 - 2.5 mm ² / 26 - 14 | |
| Dimensions | 22.5 mm / 99 mm / 114.5 mm | W / H / D |
| Description | “1 in 1” hybrid motor starter, incl. right contactor | |

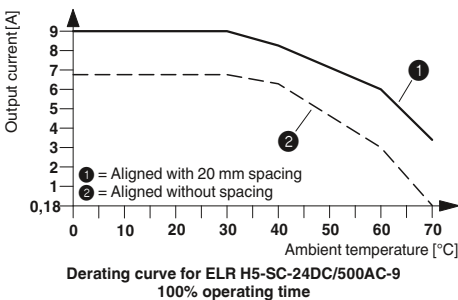

Ordering data

| Type | Order No. | Pcs. / Pkt. |
|-------------------------|-----------|-------------|
| ELR H3-SC- 24DC/500AC-9 | 2900530 | 1 |
| ELR H3-SC-230AC/500AC-9 | 2900531 | 1 |

CONTACTRON hybrid motor starters with short-circuit protection



These short-circuit-proof 3-phase “4 in 1” hybrid motor starters for mounting on 30 mm DIN rails or 60 mm busbars combine four functions in one device: right contactor, left contactor, motor protection relay, and emergency stop up to category 3.

Offer the following advantages:

- 22.5 mm wide
- Bi-metal function can be set up to 9 A
- Long service life
- Space-saving
- They save wiring
- 3-phase loop bridging
- Plug-in motor output terminal block
- Coordination type 2 according to IEC/EN 60947-4-2

Input data

Rated control supply voltage U_s
Rated control supply voltage range with reference to U_s

Rated control supply current I_s at U_s
Rated actuating voltage U_c R/L
Rated actuating voltage range with reference to U_c

Rated actuating current I_c at U_c
Input circuit
Operating voltage / status / error indicator

Output data load side

Output voltage range
Load current

Minimum load current
Residual voltage
Output protection

General data

Rated insulation voltage
Rated surge voltage
Ambient temperature (operation)
Electrical service life
Standards/regulations

Mounting position
Mounting
Screw connection solid / stranded / AWG
Dimensions

W / H / D

Description

Short-circuit-proof hybrid motor starters

Hybrid motor starters
DIN rail adapter
Power rail adapter, 160 mm
Power rail adapter, 200 mm

Set consisting of short-circuit-proof hybrid motor starter and DIN rail adapter

Fuse

Coordination type 2 to 10 kA/500 V
Coordination type 2 to 5 kA/400 V
Coordination type 1 to 30 kA/500 V



For reversing 3~ AC motors up to 550 V AC/3 x 0.6 A



For reversing 3~ AC motors up to 550 V AC/3 x 2.4 A



For reversing 3~ AC motors up to 550 V AC/3 x 9 A

Ex:

Ex:

Ex:

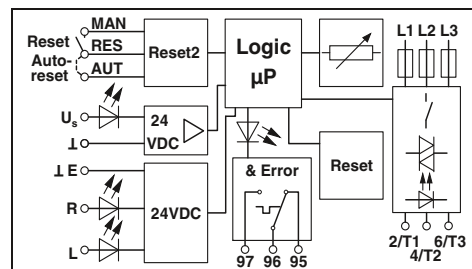
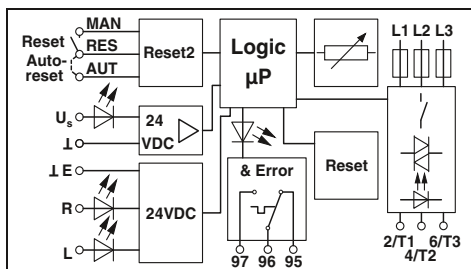
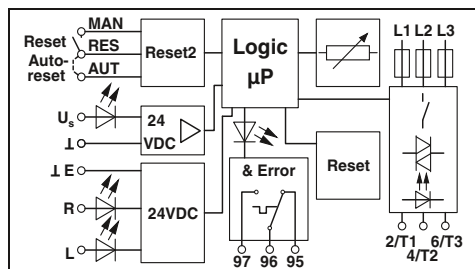

Technical data

Technical data

Technical data

24 V DC
0.8 ... 1.25

40 mA
24 V DC
0.8 ... 1.25

5 mA
Protection against polarity reversal, Surge protection
Green LED / Yellow LED / Red LED

42 V AC ... 550 V AC
max. 600 mA

75 mA
< 0.3 V
Surge protection, short-circuit protection

500 V
6 kV/safe isolation
-25°C ... 70°C
3 x 10⁷ cycles
DIN EN 50178 / EN 60947
Vertical (horizontal DIN rail)
Can be aligned with spacing = 20 mm
0.14 - 2.5 mm² / 0.14 - 2.5 mm² / 26 - 14
22.5 mm / 160 mm / 114.5 mm

24 V DC
0.8 ... 1.25

40 mA
24 V DC
0.8 ... 1.25

5 mA
Protection against polarity reversal, Surge protection
Green LED / Yellow LED / Red LED

42 V AC ... 550 V AC
max. 2.4 A

180 mA
< 0.4 V
Surge protection, short-circuit protection

500 V
6 kV/safe isolation
-25°C ... 70°C
3 x 10⁷ cycles
DIN EN 50178 / EN 60947
Vertical (horizontal DIN rail)
Can be aligned with spacing = 20 mm
0.14 - 2.5 mm² / 0.14 - 2.5 mm² / 26 - 14
22.5 mm / 160 mm / 114.5 mm

24 V DC
0.8 ... 1.25

40 mA
24 V DC
0.8 ... 1.25

5 mA
Protection against polarity reversal, Surge protection
Green LED / Yellow LED / Red LED

42 V AC ... 550 V AC
max. 9 A

1.5 A
< 0.6 V
Surge protection, short-circuit protection

500 V
6 kV/safe isolation
-25°C ... 70°C
3 x 10⁷ cycles
DIN EN 50178 / EN 60947
Vertical (horizontal DIN rail)
Can be aligned with spacing = 20 mm
0.14 - 2.5 mm² / 0.14 - 2.5 mm² / 26 - 14
22.5 mm / 160 mm / 114.5 mm

Ordering data

Ordering data

Ordering data

| Type | Order No. | Pcs. / Pkt. |
|----------------------------|-----------|-------------|
| ELR H51-IESSC-24DC500AC-06 | 2902746 | 1 |
| EM RD-ADAPTER | 2902747 | 1 |
| EM RI-ADAPTER COMPACT | 2902748 | 1 |
| EM RI-ADAPTER CLASSIC | 2902831 | 1 |
| ELR H51-0.6-DIN-RAIL-SET | 2902952 | 1 |

| Type | Order No. | Pcs. / Pkt. |
|---------------------------|-----------|-------------|
| ELR H51-IESSC-24DC500AC-2 | 2902744 | 1 |
| EM RD-ADAPTER | 2902747 | 1 |
| EM RI-ADAPTER COMPACT | 2902748 | 1 |
| EM RI-ADAPTER CLASSIC | 2902831 | 1 |
| ELR H51-2.4-DIN-RAIL-SET | 2902953 | 1 |

| Type | Order No. | Pcs. / Pkt. |
|---------------------------|-----------|-------------|
| ELR H51-IESSC-24DC500AC-9 | 2902745 | 1 |
| EM RD-ADAPTER | 2902747 | 1 |
| EM RI-ADAPTER COMPACT | 2902748 | 1 |
| EM RI-ADAPTER CLASSIC | 2902831 | 1 |
| ELR H51-9-DIN-RAIL-SET | 2902954 | 1 |

Accessories

Accessories

Accessories

| Type | Order No. | Pcs. / Pkt. |
|-------------------|-----------|-------------|
| FUSE-10X38-16A-GR | 2903126 | 10 |
| FUSE-10X38-20A-GR | 2903384 | 10 |
| FUSE-10X38-30A-MR | 2903119 | 10 |

| Type | Order No. | Pcs. / Pkt. |
|-------------------|-----------|-------------|
| FUSE-10X38-16A-GR | 2903126 | 10 |
| FUSE-10X38-20A-GR | 2903384 | 10 |
| FUSE-10X38-30A-MR | 2903119 | 10 |

| Type | Order No. | Pcs. / Pkt. |
|-------------------|-----------|-------------|
| FUSE-10X38-16A-GR | 2903126 | 10 |
| FUSE-10X38-20A-GR | 2903384 | 10 |
| FUSE-10X38-30A-MR | 2903119 | 10 |

Hybrid motor starters

CONTACTRON hybrid motor starters with SmartWire-DT™ support

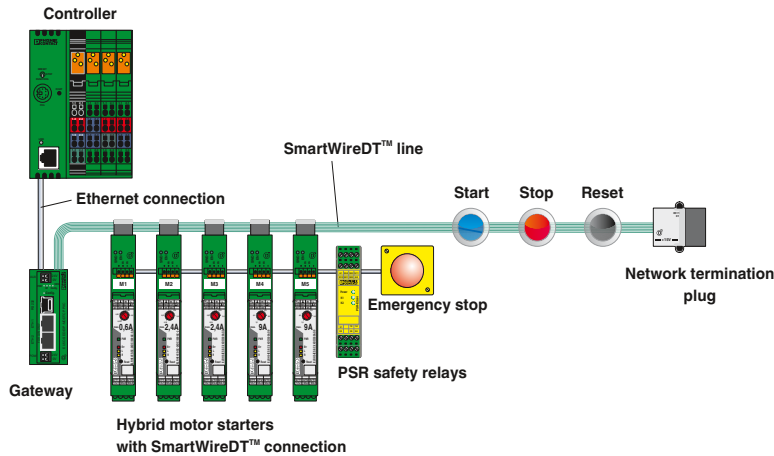

Switch and reverse motors safely and reliably with CONTACTRON compact hybrid motor starters. The CONTACTRON “4 in 1” combines all the functions of a conventional reversing contactor circuit in a single device – for motors up to 4 kW, with a design width of just 22.5 mm.

The SmartWire-DT™ communication system makes the complex cabling of the control and signal levels easier and clearer. You can also combine the hybrid motor starters with standard fieldbus systems.

The hybrid motor starters, as well as the command and signaling devices, are directly connected to the controller with SmartWire-DT™ via a gateway. Safe shutdown is implemented with a PSR safety relay. Thanks to SmartWire-DT™, the amount of wiring is significantly reduced. You benefit from clearly arranged and compact control cabinets.

Notes:

Switching device technical data

You can download the **SmartWire-DT™ Assist** software for easy creation of SmartWire-DT™ networks free of charge at www.phoenixcontact.com

SmartWire-DT™ is a registered trademark of Eaton Corporation.

Input data

Rated control supply voltage U_S
Rated control supply voltage range with reference to U_S

Rated control supply current I_S at U_S
Rated actuating voltage U_C R/L
Rated actuating voltage range with reference to U_C

Rated actuating current I_C at U_C
Input circuit
Operating voltage / status / error indicator

Output data load side

Output voltage range
Load current

Surge current
Minimum load current
Residual voltage
Output protection

General data

Rated insulation voltage
Rated surge voltage
Ambient temperature (operation)
Electrical service life
Standards/regulations
Mounting position
Mounting
Screw connection solid / stranded / AWG
Dimensions (including adapter) W / H / D

Safety data

EC-type examination certificate according to ATEX

Description

Reversing starter + emergency stop + motor protection + SmartWire-DT™ adapter as a set



Reversing starter + emergency stop + motor protection + SmartWire-DT™ adapter, as a set
550 V AC/3 x 0.6 A

Reversing starter + emergency stop + motor protection + SmartWire-DT™ adapter, as a set
550 V AC/3 x 2.4 A

Reversing starter + emergency stop + motor protection + SmartWire-DT™ adapter, as a set
550 V AC/3 x 9 A

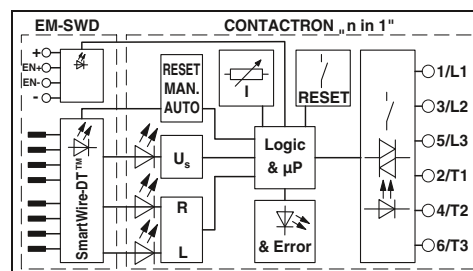
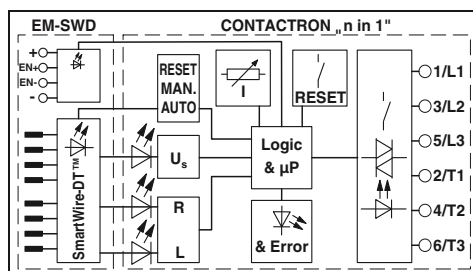

Technical data

24 V DC
0.8 ... 1.25

40 mA
24 V DC
0.8 ... 1.25

5 mA
Protection against polarity reversal, Surge protection
Green LED / Yellow LED / Red LED

42 V AC ... 550 V AC
max. 600 mA (see derating curve)

100 A (t = 10 ms)
75 mA
< 0.2 V
Surge protection

500 V
6 kV/safe isolation
-25°C ... 70°C
3 x 10⁷ cycles
DIN EN 50178 / EN 60947
Vertical (horizontal DIN rail)
Can be aligned with spacing = 20 mm
0.14 - 2.5 mm² / 0.14 - 2.5 mm² / 26 - 14
22.5 mm / 165 mm / 114.5 mm

Ex II (2) G, Ex II (2) D
PTB 07 ATEX 3145

Technical data

24 V DC
0.8 ... 1.25

40 mA
24 V DC
0.8 ... 1.25

5 mA
Protection against polarity reversal, Surge protection
Green LED / Yellow LED / Red LED

42 V AC ... 550 V AC
max. 2.4 A (see derating curve)

100 A (t = 10 ms)
180 mA
< 0.3 V
Surge protection

500 V
6 kV/safe isolation
-25°C ... 70°C
3 x 10⁷ cycles
DIN EN 50178 / EN 60947
Vertical (horizontal DIN rail)
Can be aligned with spacing = 20 mm
0.14 - 2.5 mm² / 0.14 - 2.5 mm² / 26 - 14
22.5 mm / 165 mm / 114.5 mm

Ex II (2) G, Ex II (2) D
PTB 07 ATEX 3145

Technical data

24 V DC
0.8 ... 1.25

40 mA
24 V DC
0.8 ... 1.25

5 mA
Protection against polarity reversal, Surge protection
Green LED / Yellow LED / Red LED

42 V AC ... 550 V AC
max. 9 A (see derating curve)

100 A (t = 10 ms)
1.5 A
< 0.5 V
Surge protection

500 V
6 kV/safe isolation
-25°C ... 70°C
3 x 10⁷ cycles
DIN EN 50178 / EN 60947
Vertical (horizontal DIN rail)
Can be aligned with spacing = 20 mm
0.14 - 2.5 mm² / 0.14 - 2.5 mm² / 26 - 14
22.5 mm / 165 mm / 114.5 mm

Ex II (2) G, Ex II (2) D
PTB 07 ATEX 3145

Ordering data

| Type | Order No. | Pcs. / Pkt. |
|-----------------------------|-----------|-------------|
| ELR H5-IES-SC-SWD/500AC-0,6 | 2903116 | 1 |

Ordering data

| Type | Order No. | Pcs. / Pkt. |
|---------------------------|-----------|-------------|
| ELR H5-IES-SC-SWD/500AC-2 | 2903117 | 1 |

Ordering data

| Type | Order No. | Pcs. / Pkt. |
|---------------------------|-----------|-------------|
| ELR H5-IES-SC-SWD/500AC-9 | 2903118 | 1 |

SmartWire-DT™ accessories

With the “EM SWD-ADAPTER” SmartWire-DT™ adapter for the CONTACTRON 24 V DC “n in 1” devices, the device concerned can be seamlessly integrated into the fieldbus environment using SmartWire-DT™. Corresponding gateways are available for the following bus systems:

- PROFIBUS-DP
- CANopen
- Modbus TCP/Ethernet IP



SmartWire DT adapter

| Technical data | |
|---|---|
| Input data | |
| Supply voltage U_{AUX} | - |
| Rated current I_{AUX} | - |
| Supply voltage U_{POW} | - |
| Rated current I_{POW} | - |
| Input data | |
| Description | Enable input |
| Input voltage | 24 V DC |
| Input current | 5 mA |
| Output data | |
| Description | - |
| Output supply | - |
| Output current | - |
| SmartWire-DT interface | |
| Connection method | Pin strip, 8-pos. |
| Data rate | 125 kBd / 250 kBd |
| Current consumption I_{AUX} | 120 mA |
| Current consumption I_{POW} | 25 mA |
| General data | |
| Ambient temperature (operation) | -25°C ... 55°C |
| Standards/regulations | IEC 60947-1 / EN 60947-1 |
| Degree of protection according to IEC 60529/ EN 60529 | IP20 |
| Mounting position | Any |
| Mounting | On CONTACTRON hybrid motor starter |
| Connection data solid / stranded / AWG | 0.14 - 1 mm ² / 0.14 - 1 mm ² / 26 - 18 |
| Dimensions | 22.5 mm / 165 mm / 114.5 mm |

| Ordering data | | | |
|--|-----------------------|-----------|-------------|
| Description | Type | Order No. | Pcs. / Pkt. |
| SmartWire-DT™ adapter | EM SWD-ADAPTER | 2902776 | 1 |
| Gateways | | | |
| CANopen® | | | |
| PROFIBUS | | | |
| Ethernet | | | |
| I/O modules | | | |
| Digital, 4 inputs, 4 outputs | | | |
| Digital, 4 inputs | | | |
| Digital, 8 outputs | | | |
| Analog, 2 inputs, 2 outputs | | | |
| Power feed module for supplying further SmartWire-DT™ devices | | | |



Gateways



Input/output modules



Power feed



| Technical data | |
|---|---|
| - | - |
| 24 V DC -15% ... +20% | - |
| 3 A | - |
| 24 V DC -15% ... +20% | - |
| 700 mA | - |
| - | - |
| - | - |
| - | - |
| - | - |
| - | - |
| Pin strip, 8-pos. 125 kBd / 250 kBd | - |
| - | - |
| - | - |
| -25°C ... 55°C | - |
| EN 50178 | - |
| IP20 | - |
| Any | - |
| - | - |
| 0.2 - 1.5 mm ² / 0.2 - 1.5 mm ² / 24 - 16 | - |
| 35 mm / 90 mm / 127 mm | - |

| Technical data | |
|---|--|
| - | - |
| - | - |
| - | - |
| - | - |
| - | - |
| - | - |
| Digital inputs | Analog inputs |
| 24 V DC | - |
| Typ. 4 mA | - |
| - | - |
| - | - |
| Digital outputs | Analog outputs |
| 24 V DC -15% ... +20% | - |
| Typ. 500 mA | - |
| - | - |
| - | - |
| Pin strip, 8-pos. 125 kBd / 250 kBd | Pin strip, 8-pos. 125 kBd / 250 kBd |
| - | - |
| - | - |
| - | - |
| - | - |
| EN 50178 | - |
| IP20 | - |
| Any | - |
| - | - |
| 0.2 - 1.5 mm ² / 0.2 - 1.5 mm ² / 24 - 16 | - |
| 35 mm / 90 mm / 101 mm | - |

| Technical data | |
|---|---|
| - | - |
| 24 V DC -15% ... +20% | - |
| 3 A | - |
| 24 V DC -15% ... +20% | - |
| 700 mA | - |
| - | - |
| - | - |
| - | - |
| - | - |
| - | - |
| Pin strip, 8-pos. 125 kBd / 250 kBd | - |
| - | - |
| - | - |
| - | - |
| - | - |
| EN 50178 | - |
| IP20 | - |
| Any | - |
| - | - |
| 0.2 - 1.5 mm ² / 0.2 - 1.5 mm ² / 24 - 16 | - |
| 35 mm / 90 mm / 124 mm | - |

| Ordering data | | |
|-------------------------|-----------|-------------|
| Type | Order No. | Pcs. / Pkt. |
| EU5C-SWD-CAN PXC | 2903098 | 1 |
| EU5C-SWD-DP PXC | 2903100 | 1 |
| EU5C-SWD-EIP-MODTCP PXC | 2903244 | 1 |

| Ordering data | | |
|-------------------|-----------|-------------|
| Type | Order No. | Pcs. / Pkt. |
| EU5E-SWD-4D4D PXC | 2903101 | 1 |
| EU5E-SWD-4DX PXC | 2903102 | 1 |
| EU5E-SWD-X8D PXC | 2903103 | 1 |
| EU5E-SWD-2A2A PXC | 2903104 | 1 |

| Ordering data | | |
|--------------------|-----------|-------------|
| Type | Order No. | Pcs. / Pkt. |
| EU5C-SWD-PF2-1 PXC | 2903113 | 1 |

Hybrid motor starters

SmartWire-DT™ accessories



Plug tools



Flat-ribbon cable, 8-pos.

| | | Ordering data | | | Ordering data | | |
|---|-------|----------------|-----------|-------------|---------------------|-----------|-------------|
| Description | Color | Type | Order No. | Pcs. / Pkt. | Type | Order No. | Pcs. / Pkt. |
| Pliers for device plugs | | SWD4-CRP-1 PXC | 2903110 | 1 | | | |
| Pliers for flat plugs | | SWD4-CRP-2 PXC | 2903114 | 1 | | | |
| Flat-ribbon cable, 8-pos., 100 m | | | | | SWD4-100LF-8-24 PXC | 2903111 | 1 |
| Flat-ribbon cable, assembled with 2 flat plugs, 8-pos., 3 m | | | | | SWD4-3LF8-24-2S PXC | 2903112 | 1 |

SmartWire-DT™ accessories

Accessories for SmartWire-DT™ and SmartWire-DT™ devices for connecting digital and analog input and output signals.



Plug and coupler



Programming adapter

| | | Ordering data | | | Ordering data | | |
|-------------------------------|-------|------------------|-----------|-------------|------------------------|-----------|-------------|
| Description | Color | Type | Order No. | Pcs. / Pkt. | Type | Order No. | Pcs. / Pkt. |
| Plug and coupling | | | | | | | |
| Network dummy plug | | SWD4-RC8-10 PXC | 2903106 | 1 | | | |
| Device plug, 8-pos. | | SWD4-8SF2-5 PXC | 2903107 | 10 | | | |
| Flat plug, 8-pos. | | SWD4-8MF2 PXC | 2903108 | 10 | | | |
| Coupling for 8-pos. flat plug | | SWD4-8SFF2-5 PXC | 2903109 | 1 | | | |
| Programming adapter | | | | | | | |
| | | | | | EU4A-RJ45-USB-CAB1 PXC | 2903465 | 1 |

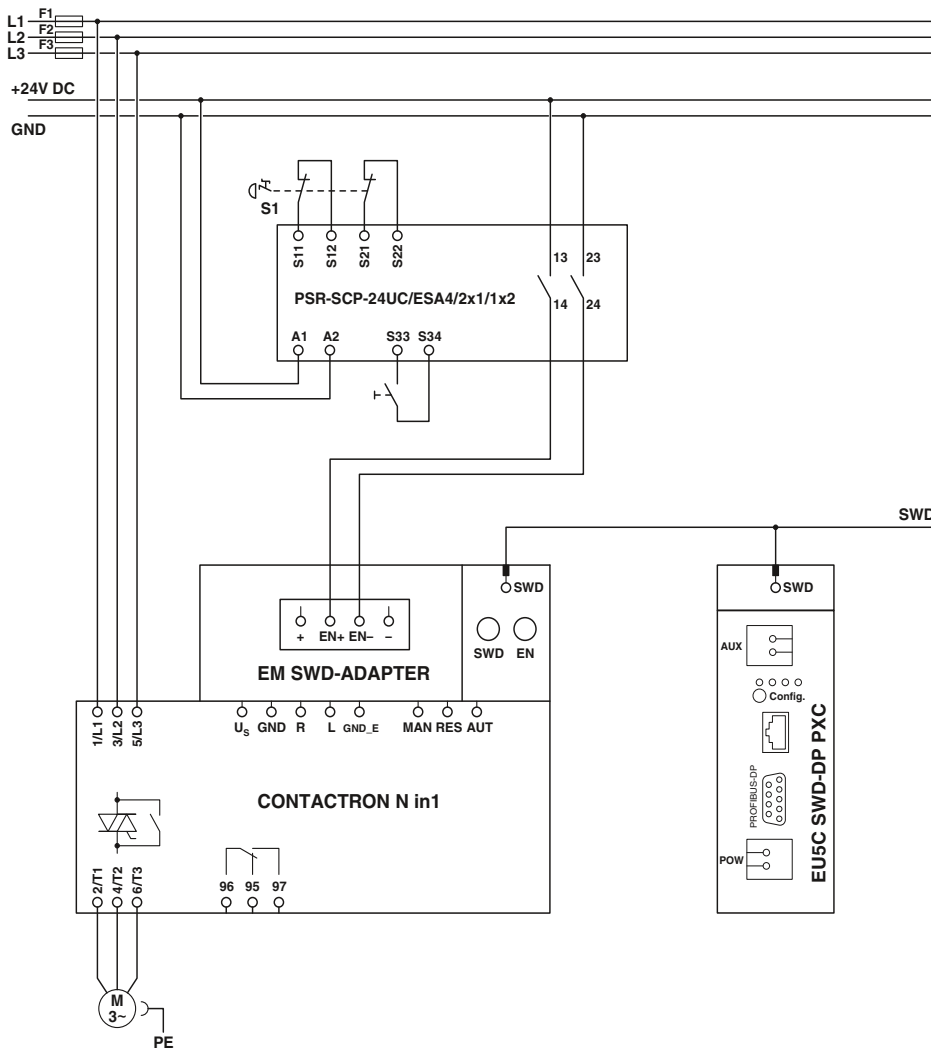

Emergency stop wiring example (two-channel)

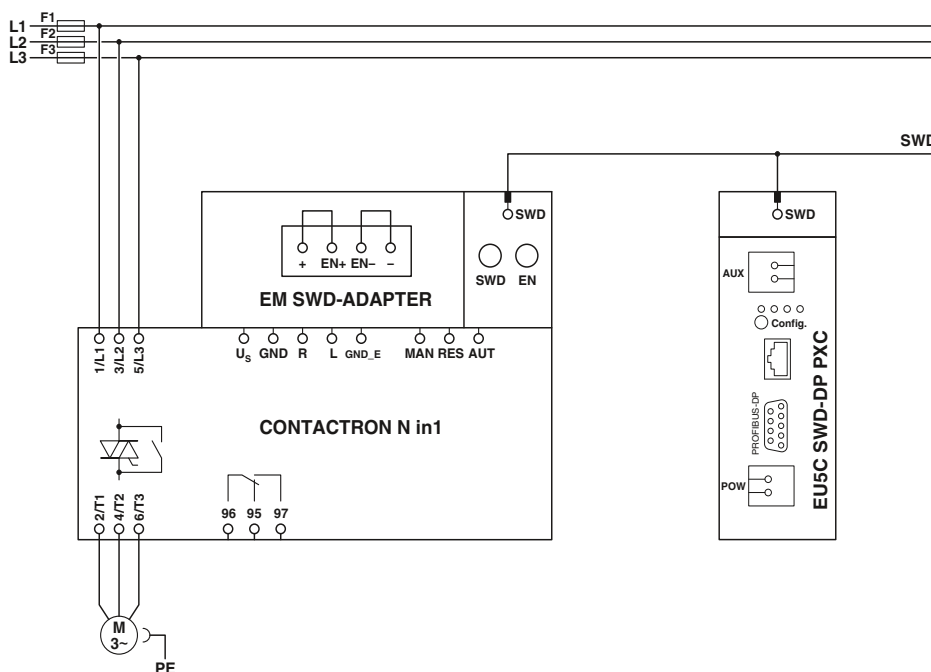

Wiring example without emergency stop

Intended use
The SmartWire-DT™ adapter is approved exclusively for use in conjunction with the following CONTACTRON hybrid motor starters. If other switching devices are used, correct operation, in particular of the safety function, cannot be ensured.

Motor protection and safe shutdown

| | |
|---------|------------------------------|
| 2900582 | ELR H5-IES-SC-24DC/500AC-0,6 |
| 2900414 | ELR H5-IES-SC-24DC/500AC-2 |
| 2900421 | ELR H5-IES-SC-24DC/500AC-9 |
| 2900566 | ELR H3-IES-SC-24DC/500AC-0,6 |
| 2900567 | ELR H3-IES-SC-24DC/500AC-2 |
| 2900569 | ELR H3-IES-SC-24DC/500AC-9 |
| 2297031 | ELR W3- 24DC/500AC-2I |
| 2297057 | ELR W3- 24DC/500AC-9I |
| 2902952 | ELR H51-0,6-DINRAIL-SET |
| 2902953 | ELR H51-2,4-DINRAIL-SET |
| 2902954 | ELR H51-9-DINRAIL-SET |
| 2902746 | ELR H51-IESSC-24DC500AC-06 |
| 2902744 | ELR H51-IESSC-24DC500AC-2 |
| 2902745 | ELR H51-IESSC-24DC500AC-9 |

Motor protection only

| | |
|---------|----------------------------|
| 2900573 | ELR H5-I-SC-24DC/500AC-0,6 |
| 2900574 | ELR H5-I-SC-24DC/500AC-2 |
| 2900576 | ELR H5-I-SC-24DC/500AC-9 |
| 2900542 | ELR H3-I-SC-24DC/500AC-0,6 |
| 2900543 | ELR H3-I-SC-24DC/500AC-2 |
| 2900545 | ELR H3-I-SC-24DC/500AC-9 |

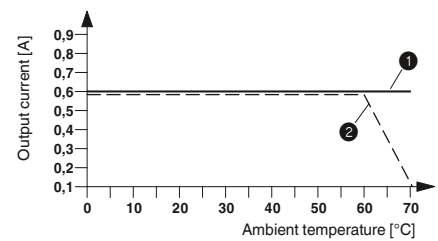

Derating curve for ELR H5-IES-SC-SWD/500AC-0,6
100% operating time

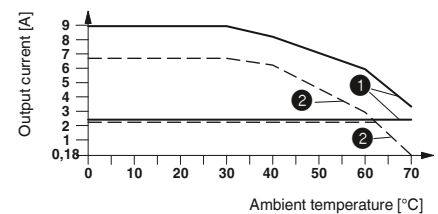

Derating curve for ELR H5-IES-SC-SWD/500AC-2 and
ELR H5-IES-SC-SWD/500AC-9
100% operating time

- ① Aligned with > 20 mm spacing
- ② Aligned without spacing

CONTACTRON bridge

The flexible CONTACTRON loop bridge (BRIDGE-...) simplifies the supply and looping through of phases L1, L2, and L3. It is available in 2- to 10-way versions for modules in the CONTACTRON family with 22.5 mm housing width.

Features of the 3-phase loop bridge:

- Saves considerable wiring
- Suitable for CONTACTRON series
 - ELR H3...
 - ELR H5...
 - ELR (W)3...
 - EMM...IFS
- Bridging of 2 to 10 devices with maximum module spacing of 22.5 mm
- Up to 575 V AC/3 x 25 A
- Additional bridge versions available on request



0.3 m connecting cable with ferrules

| General data | | Technical data | | |
|--------------------------|--|---------------------|-----------|-------------|
| Nominal voltage U_N | | 575 V AC | | |
| Nominal current at U_N | | 25 A | | |
| Cross section | | 2.5 mm ² | | |
| Description | | Ordering data | | |
| 3-phase loop bridge | | Type | Order No. | Pcs. / Pkt. |
| 2-way | | BRIDGE- 2 | 2900746 | 1 |
| 3-way | | BRIDGE- 3 | 2900747 | 1 |
| 4-way | | BRIDGE- 4 | 2900748 | 1 |
| 5-way | | BRIDGE- 5 | 2900749 | 1 |
| 6-way | | BRIDGE- 6 | 2900750 | 1 |
| 7-way | | BRIDGE- 7 | 2900751 | 1 |
| 8-way | | BRIDGE- 8 | 2900752 | 1 |
| 9-way | | BRIDGE- 9 | 2900753 | 1 |
| 10-way | | BRIDGE-10 | 2900754 | 1 |



N



3 m connecting cable
without ferrules

Technical data

575 V AC
25 A
2.5 mm²

Ordering data

| Type | Order No. | Pcs. / Pkt. |
|--------------|-----------|-------------|
| BRIDGE- 2-3M | 2901543 | 1 |
| BRIDGE- 3-3M | 2901656 | 1 |
| BRIDGE- 4-3M | 2901659 | 1 |
| BRIDGE- 5-3M | 2901545 | 1 |
| BRIDGE- 6-3M | 2901697 | 1 |
| BRIDGE- 7-3M | 2901698 | 1 |
| BRIDGE- 8-3M | 2901700 | 1 |
| BRIDGE- 9-3M | 2901701 | 1 |
| BRIDGE-10-3M | 2901702 | 1 |

Solid-state contactors

Three-phase solid-state reversing contactors

The three-phase solid-state reversing contactor with an integrated locking circuit and load wiring are intended for applications such as control valves, slides, separating filters, ship steering gears, etc. The scope of performance ranges from 575 V AC/3 x 2 A to 575 V AC/3 x 37 A.

Advantages of three-phase solid-state reversing contactors:

- Noise-free and wear-free switching
- Integrated protective circuit
- Stable and short switching times
- Long service life
- High switching frequency
- Integrated locking and load wiring
- Thermal fuse optional

| Notes: |
|---|
| Type of insulation housing: ELR W 3...2, ELR W 3...9 Polyamide PA non-reinforced, color: green |
| ELR W 3...16, ELR W 3...37 Polyester PBT non-reinforced, color: green |
| Marking systems and mounting material See Catalog 5 |



For reversing 3~ AC motors up to 575 V AC/3 x 2 A

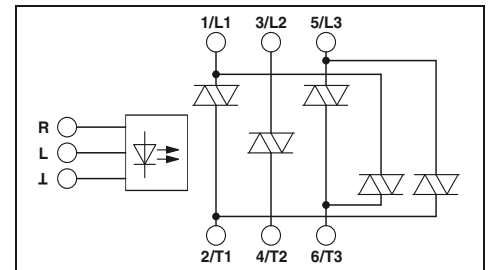

Technical data

| | |
|---|---|
| Input data | |
| Rated actuating voltage U_c R/L | 24 V DC |
| Rated actuating voltage range with reference to U_c | 0.8 ... 1.25 |
| Rated actuating current I_c at U_c | 12.7 mA |
| Input circuit | 11.2 mA |
| Operating voltage / status / error indicator | Protection against polarity reversal, Surge protection |
| Output data load side | - / Yellow LED / Red LED |
| Output voltage range | 48 V AC ... 575 V AC |
| Periodic peak reverse voltage | 1200 V |
| Load current | max. 2 A (see derating curve) |
| Surge current | 200 A (t = 10 ms) |
| Minimum load current | 100 mA |
| Residual voltage | < 1.5 V |
| Leakage current | 6 mA |
| Maximum load value $I^2 \times t$ (t = 10 ms) | 250 A ² s |
| Output protection | RCV circuit |
| General data | |
| Rated insulation voltage | 500 V |
| Rated surge voltage | 6 kV/basic isolation |
| Reversing frequency | max. 10 Hz |
| Switching frequency | max. 5 Hz |
| Ambient temperature (operation) | -25°C ... 70°C |
| Standards/regulations | DIN EN 50178 / EN 60947 |
| Power station requirements | DWR 1300 / ZXX01/DD/7080.8d |
| Degree of protection according to IEC 60529/ EN 60529 | IP20 |
| Mounting position | Vertical (horizontal DIN rail) |
| Mounting | Can be aligned with spacing = 20 mm |
| Screw connection solid / stranded / AWG | 0.14 - 2.5 mm ² / 0.14 - 2.5 mm ² / 26 - 12 |
| - Control side | 0.14 - 2.5 mm ² / 0.14 - 2.5 mm ² / 26 - 12 |
| - Load side | 40 mm / 99 mm / 114.5 mm |
| Dimensions | W / H / D |

| | |
|------------------|---|
| 230 V AC | 48 V AC ... 575 V AC |
| 0.4 ... 1.1 | 1200 V |
| 11.2 mA | max. 2 A (see derating curve) |
| Surge protection | max. 2 A (see derating curve) |
| | 200 A (t = 10 ms) |
| | 100 mA |
| | < 1.5 V |
| | 6 mA |
| | 250 A ² s |
| | RCV circuit |
| | 500 V |
| | 6 kV/basic isolation |
| | max. 10 Hz |
| | max. 5 Hz |
| | -25°C ... 70°C |
| | DIN EN 50178 / EN 60947 |
| | DWR 1300 / ZXX01/DD/7080.8d |
| | IP20 |
| | Vertical (horizontal DIN rail) |
| | Can be aligned with spacing = 20 mm |
| | 0.14 - 2.5 mm ² / 0.14 - 2.5 mm ² / 26 - 12 |
| | 0.14 - 2.5 mm ² / 0.14 - 2.5 mm ² / 26 - 12 |
| | 40 mm / 99 mm / 114.5 mm |

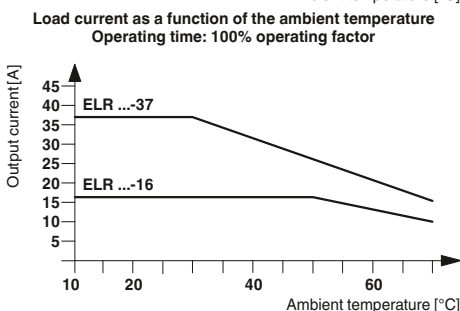
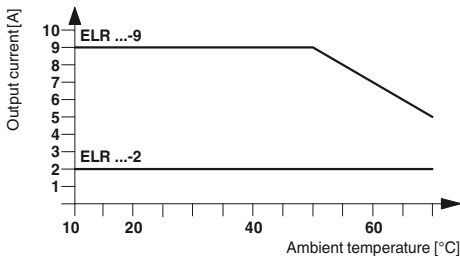

| | |
|--------------|--|
| Description | 3-phase solid-state reversing contactor |
| Thermal fuse | |

| Ordering data | | |
|-----------------------|-----------|-------------|
| Type | Order No. | Pcs. / Pkt. |
| ELR W3- 24DC/500AC- 2 | 2297293 | 1 |
| ELR W3-230AC/500AC- 2 | 2297303 | 1 |

| Accessories | | |
|--------------------|---------|---|
| THERMAL FUSE TF104 | 2900796 | 1 |

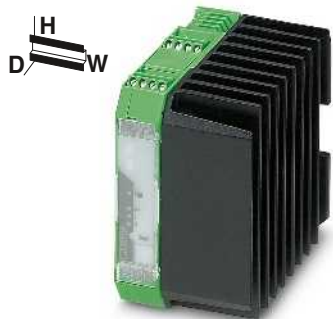

For reversing 3~ AC motors up to 575 V AC/3 x 9 A



For reversing 3~ AC motors up to 575 V AC/3 x 16 A



For reversing 3~ AC motors up to 575 V AC/3 x 37 A

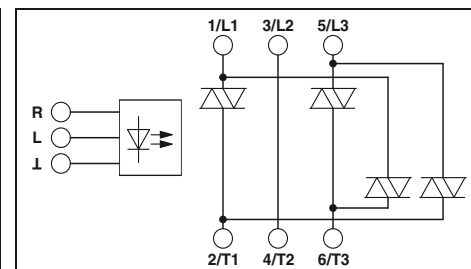
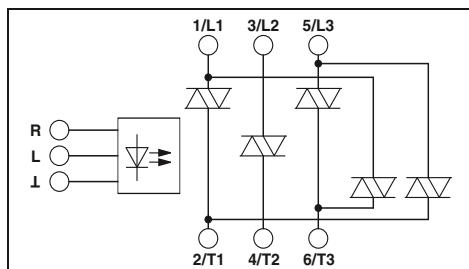

Technical data

Technical data

Technical data

| | |
|---|-------------------------|
| 24 V DC 0.8 ... 1.25 | 230 V AC 0.4 ... 1.1 |
| 12.7 mA | 11.2 mA |
| Protection against polarity reversal, Surge protection | Surge protection |
| - / Yellow LED / Red LED | |

| | |
|---|-------------------------|
| 24 V DC 0.8 ... 1.25 | 230 V AC 0.4 ... 1.1 |
| 12.7 mA | 11.2 mA |
| Protection against polarity reversal, Surge protection | Surge protection |
| - / Yellow LED / Red LED | |

| | |
|---|-------------------------|
| 24 V DC 0.8 ... 1.25 | 230 V AC 0.4 ... 1.1 |
| 12.7 mA | 11.2 mA |
| Protection against polarity reversal, Surge protection | Surge protection |
| - / Yellow LED / Red LED | |

| | |
|--|--|
| 48 V AC ... 575 V AC 1200 V max. 9 A (see derating curve) | 48 V AC ... 575 V AC 1200 V max. 9 A (see derating curve) |
| 300 A (t = 10 ms) 100 mA < 1.5 V 6 mA 580 A ² s | 300 A (t = 10 ms) 100 mA < 1.5 V 6 mA 580 A ² s |
| RCV circuit | |

| | |
|--|--|
| 48 V AC ... 575 V AC 1200 V max. 16 A (see derating curve) | 48 V AC ... 575 V AC 1200 V max. 16 A (see derating curve) |
| 300 A (t = 10 ms) 100 mA < 1.5 V 6 mA 580 A ² s | 300 A (t = 10 ms) 100 mA < 1.5 V 6 mA 580 A ² s |
| RCV circuit | |

| | |
|--|--|
| 48 V AC ... 575 V AC 1200 V max. 37 A (see derating curve) | 48 V AC ... 575 V AC 1200 V max. 37 A (see derating curve) |
| 1300 A (t = 10 ms) 200 mA < 1.5 V 6 mA 9000 A ² s | 1300 A (t = 10 ms) 200 mA < 1.5 V 6 mA 9000 A ² s |
| RCV circuit | |

| | |
|---|--|
| 500 V 6 kV/basic isolation max. 10 Hz max. 5 Hz -25°C ... 70°C DIN EN 50178 / EN 60947 DWR 1300 / ZXX01/DD/7080.8d IP20 Vertical (horizontal DIN rail) Can be aligned with spacing = 20 mm | 500 V 6 kV/basic isolation max. 2 Hz max. 1 Hz -25°C ... 70°C DIN EN 50178 / EN 60947 DWR 1300 / ZXX01/DD/7080.8d IP20 Vertical (horizontal DIN rail) Can be aligned with spacing = 40 mm |
| 0.14 - 2.5 mm ² / 0.14 - 2.5 mm ² / 26 - 12 0.14 - 2.5 mm ² / 0.14 - 2.5 mm ² / 26 - 12 67.5 mm / 99 mm / 114.5 mm | 0.2 - 4 mm ² / 0.2 - 2.5 mm ² / 24 - 12 0.5 - 16 mm ² / 0.5 - 16 mm ² / 20 - 6 147.5 mm / 99 mm / 114.5 mm |

| | |
|---|--|
| 500 V 6 kV/basic isolation max. 10 Hz max. 5 Hz -25°C ... 70°C DIN EN 50178 / EN 60947 DWR 1300 / ZXX01/DD/7080.8d IP20 Vertical (horizontal DIN rail) Can be aligned with spacing = 40 mm | 500 V 6 kV/basic isolation max. 2 Hz max. 1 Hz -25°C ... 70°C DIN EN 50178 / EN 60947 DWR 1300 / ZXX01/DD/7080.8d IP20 Vertical (horizontal DIN rail) Can be aligned with spacing = 40 mm |
| 0.2 - 4 mm ² / 0.2 - 2.5 mm ² / 24 - 12 0.5 - 16 mm ² / 0.5 - 16 mm ² / 20 - 6 147.5 mm / 99 mm / 114.5 mm | 0.2 - 4 mm ² / 0.2 - 2.5 mm ² / 24 - 12 0.5 - 16 mm ² / 0.5 - 16 mm ² / 20 - 6 147.5 mm / 99 mm / 114.5 mm |

| | |
|---|--|
| 500 V 6 kV/basic isolation max. 10 Hz max. 5 Hz -25°C ... 70°C DIN EN 50178 / EN 60947 DWR 1300 / ZXX01/DD/7080.8d IP20 Vertical (horizontal DIN rail) Can be aligned with spacing = 40 mm | 500 V 6 kV/basic isolation max. 2 Hz max. 1 Hz -25°C ... 70°C DIN EN 50178 / EN 60947 DWR 1300 / ZXX01/DD/7080.8d IP20 Vertical (horizontal DIN rail) Can be aligned with spacing = 40 mm |
| 0.2 - 4 mm ² / 0.2 - 2.5 mm ² / 24 - 12 0.5 - 16 mm ² / 0.5 - 16 mm ² / 20 - 6 147.5 mm / 99 mm / 114.5 mm | 0.2 - 4 mm ² / 0.2 - 2.5 mm ² / 24 - 12 0.5 - 16 mm ² / 0.5 - 16 mm ² / 20 - 6 147.5 mm / 99 mm / 114.5 mm |

Ordering data

Ordering data

Ordering data

| Type | Order No. | Pcs. / Pkt. |
|-----------------------|-----------|-------------|
| ELR W3- 24DC/500AC- 9 | 2297316 | 1 |
| ELR W3-230AC/500AC- 9 | 2297329 | 1 |

| Type | Order No. | Pcs. / Pkt. |
|-----------------------|-----------|-------------|
| ELR W3- 24DC/500AC-16 | 2297332 | 1 |
| ELR W3-230AC/500AC-16 | 2297345 | 1 |

| Type | Order No. | Pcs. / Pkt. |
|-------------------------|-----------|-------------|
| ELR W2+1- 24DC/500AC-37 | 2297374 | 1 |
| ELR W2+1-230AC/500AC-37 | 2297387 | 1 |

| Accessories | | |
|--------------------|---------|---|
| THERMAL FUSE TF104 | 2900796 | 1 |

| Accessories | | |
|--------------------|---------|---|
| THERMAL FUSE TF104 | 2900796 | 1 |

| Accessories | | |
|--------------------|---------|---|
| THERMAL FUSE TF104 | 2900796 | 1 |

Solid-state contactors

Three-phase semiconductor contactor

Motors of mixers, machine tools, conveying systems, pumps, and fans up to 575 V AC/3 x 37 A (equivalent to 1 kW to 18.5 kW) can be controlled using the CONTACTRON three-phase semiconductor contactors.

Advantages of three-phase semiconductor contactors:

- Noise-free and wear-free switching
- Integrated protective circuit
- Stable and short switching times
- Long service life
- High switching frequency
- Thermal fuse optional

| Notes: |
|---|
| Type of insulation housing: ELR 3...2, ELR 3...9 Polyamide PA non-reinforced, color: green |
| ELR 3...16, ELR 3...37 Polyester PBT non-reinforced, color: green |
| Marking systems and mounting material See Catalog 5 |

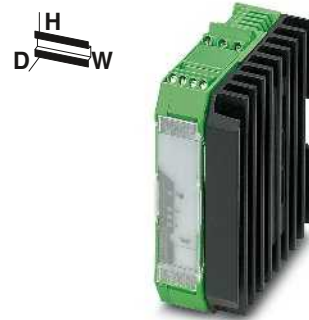

For switching 3~ AC motors up to 575 V AC/3 x 2 A

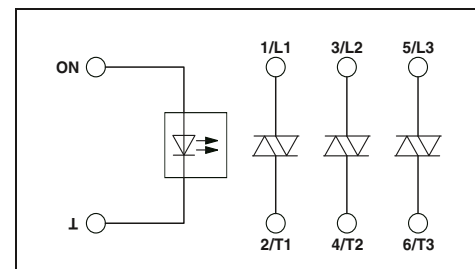

| Input data | | |
|---|---|----------------------------------|
| Rated actuating voltage U_C ON | 24 V DC | 230 V AC |
| Rated actuating voltage range with reference to U_C | 0.8 ... 1.25 | 0.4 ... 1.1 |
| Rated actuating current I_C at U_C | 8.3 mA | 12.5 mA |
| Input circuit | Protection against polarity reversal, Surge protection | Surge protection |
| Operating voltage / status / error indicator | - / Yellow LED / Red LED | |
| Output data load side | | |
| Output voltage range | 48 V AC ... 575 V AC | 48 V AC ... 575 V AC |
| Periodic peak reverse voltage | 1200 V | 1200 V |
| Load current | max. 2 A (see derating curve) | max. 2 A (see derating curve) |
| Surge current | 200 A (t = 10 ms) | 200 A (t = 10 ms) |
| Minimum load current | 100 mA | 100 mA |
| Residual voltage | < 1.5 V | < 1.5 V |
| Leakage current | 6 mA | 6 mA |
| Maximum load value $I^2 \times t$ (t = 10 ms) | 250 A ² s | 250 A ² s |
| Output protection | RCV circuit | |
| General data | | |
| Rated insulation voltage | 500 V | |
| Rated surge voltage | 6 kV/basic isolation | 6 kV/basic isolation |
| Switching frequency | max. 10 Hz | max. 1 Hz |
| Ambient temperature (operation) | -25°C ... 70°C | |
| Standards/regulations | DIN EN 50178 / EN 60947 | |
| Power station requirements | DWR 1300 / ZXX01/DD/7080.8d | |
| Degree of protection according to IEC 60529/ EN 60529 | IP20 | |
| Mounting position | Vertical (horizontal DIN rail) | |
| Mounting | Can be aligned with spacing = 20 mm | |
| Screw connection solid / stranded / AWG | 0.14 - 2.5 mm ² / 0.14 - 2.5 mm ² / 26 - 12 | |
| - Control side | 0.14 - 2.5 mm ² / 0.14 - 2.5 mm ² / 26 - 12 | |
| - Load side | 40 mm / 99 mm / 114.5 mm | |
| Dimensions | W / H / D | |

Technical data

| Technical data | | |
|---|---|----------------------------------|
| Rated actuating voltage U_C ON | 24 V DC | 230 V AC |
| Rated actuating voltage range with reference to U_C | 0.8 ... 1.25 | 0.4 ... 1.1 |
| Rated actuating current I_C at U_C | 8.3 mA | 12.5 mA |
| Input circuit | Protection against polarity reversal, Surge protection | Surge protection |
| Operating voltage / status / error indicator | - / Yellow LED / Red LED | |
| Output data load side | | |
| Output voltage range | 48 V AC ... 575 V AC | 48 V AC ... 575 V AC |
| Periodic peak reverse voltage | 1200 V | 1200 V |
| Load current | max. 2 A (see derating curve) | max. 2 A (see derating curve) |
| Surge current | 200 A (t = 10 ms) | 200 A (t = 10 ms) |
| Minimum load current | 100 mA | 100 mA |
| Residual voltage | < 1.5 V | < 1.5 V |
| Leakage current | 6 mA | 6 mA |
| Maximum load value $I^2 \times t$ (t = 10 ms) | 250 A ² s | 250 A ² s |
| Output protection | RCV circuit | |
| General data | | |
| Rated insulation voltage | 500 V | |
| Rated surge voltage | 6 kV/basic isolation | 6 kV/basic isolation |
| Switching frequency | max. 10 Hz | max. 1 Hz |
| Ambient temperature (operation) | -25°C ... 70°C | |
| Standards/regulations | DIN EN 50178 / EN 60947 | |
| Power station requirements | DWR 1300 / ZXX01/DD/7080.8d | |
| Degree of protection according to IEC 60529/ EN 60529 | IP20 | |
| Mounting position | Vertical (horizontal DIN rail) | |
| Mounting | Can be aligned with spacing = 20 mm | |
| Screw connection solid / stranded / AWG | 0.14 - 2.5 mm ² / 0.14 - 2.5 mm ² / 26 - 12 | |
| - Control side | 0.14 - 2.5 mm ² / 0.14 - 2.5 mm ² / 26 - 12 | |
| - Load side | 40 mm / 99 mm / 114.5 mm | |
| Dimensions | W / H / D | |

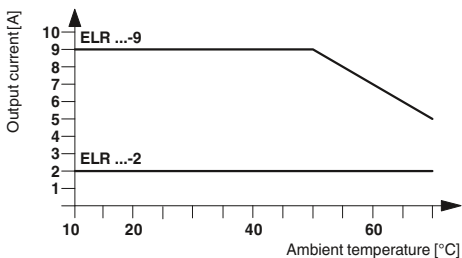

Load current as a function of the ambient temperature
Operating time: 100% operating factor

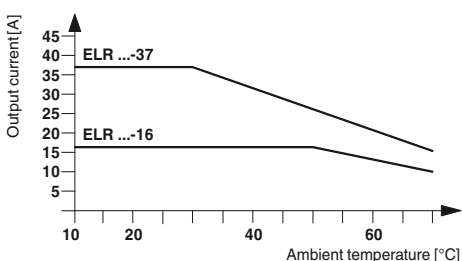

Load current as a function of the ambient temperature
Operating time: 100% operating factor

| Description |
|-------------------------------------|
| Three-phase semiconductor contactor |

Thermal fuse

Ordering data

| Type | Order No. | Pcs. / Pkt. |
|----------------------|-----------|-------------|
| ELR 3- 24DC/500AC- 2 | 2297196 | 1 |
| ELR 3-230AC/500AC- 2 | 2297206 | 1 |

Accessories

| Accessories | Order No. | Pcs. / Pkt. |
|--------------------|-----------|-------------|
| THERMAL FUSE TF104 | 2900796 | 1 |

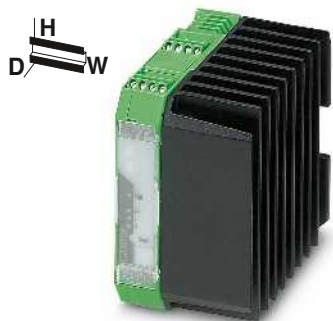

For switching 3~ AC motors up to 575 V AC/3 x 9 A



For switching 3~ AC motors up to 575 V AC/3 x 16 A



For switching 3~ AC motors up to 575 V AC/3 x 37 A

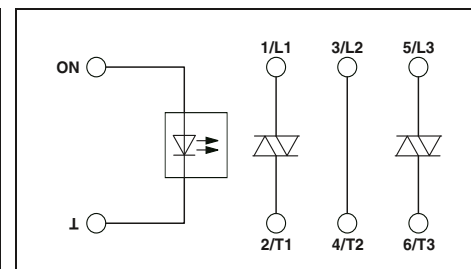
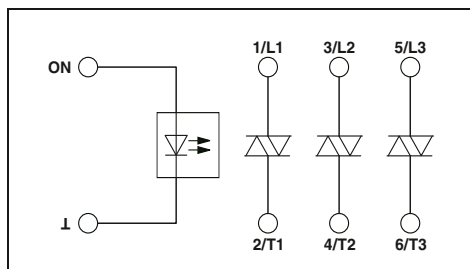

Technical data

| | |
|---|-------------------------|
| 24 V DC 0.8 ... 1.25 | 230 V AC 0.4 ... 1.1 |
| 8.3 mA | 12.5 mA |
| Protection against polarity reversal, Surge protection | Surge protection |
| - / Yellow LED / Red LED | |

| | |
|--|--|
| 48 V AC ... 575 V AC 1200 V max. 9 A (see derating curve) | 48 V AC ... 575 V AC 1200 V max. 9 A (see derating curve) |
|--|--|

| | |
|----------------------|----------------------|
| 300 A (t = 10 ms) | 300 A (t = 10 ms) |
| 100 mA | 100 mA |
| < 1.5 V | < 1.5 V |
| 6 mA | 6 mA |
| 580 A ² s | 580 A ² s |
| RCV circuit | |

| | |
|-------|---|
| 500 V | 6 kV/basic isolation max. 10 Hz -25°C ... 70°C DIN EN 50178 / EN 60947 DWR 1300 / ZXX01/DD/7080.8d IP20 Vertical (horizontal DIN rail) Can be aligned with spacing = 20 mm |
|-------|---|

| | |
|---|---|
| 0.14 - 2.5 mm ² / 0.14 - 2.5 mm ² / 26 - 12 | 0.14 - 2.5 mm ² / 0.14 - 2.5 mm ² / 26 - 12 |
| 67.5 mm / 99 mm / 114.5 mm | |

Ordering data

| Type | Order No. | Pcs. / Pkt. |
|---------------------|-----------|-------------|
| ELR 3-24DC/500AC-9 | 2297219 | 1 |
| ELR 3-230AC/500AC-9 | 2297222 | 1 |

Accessories

| | | |
|--------------------|---------|---|
| THERMAL FUSE TF104 | 2900796 | 1 |
|--------------------|---------|---|

Technical data

| | |
|---|-------------------------|
| 24 V DC 0.8 ... 1.25 | 230 V AC 0.4 ... 1.1 |
| 8.3 mA | 12.5 mA |
| Protection against polarity reversal, Surge protection | Surge protection |
| - / Yellow LED / Red LED | |

| | |
|---|---|
| 48 V AC ... 575 V AC 1200 V max. 16 A (see derating curve) | 48 V AC ... 575 V AC 1200 V max. 16 A (see derating curve) |
|---|---|

| | |
|----------------------|----------------------|
| 300 A (t = 10 ms) | 300 A (t = 10 ms) |
| 100 mA | 100 mA |
| < 1.5 V | < 1.5 V |
| 6 mA | 6 mA |
| 580 A ² s | 580 A ² s |
| RCV circuit | |

| | |
|-------|---|
| 500 V | 6 kV/basic isolation max. 10 Hz -25°C ... 70°C DIN EN 50178 / EN 60947 DWR 1300 / ZXX01/DD/7080.8d IP20 Vertical (horizontal DIN rail) Can be aligned with spacing = 40 mm |
|-------|---|

| | |
|---|--|
| 0.2 - 4 mm ² / 0.2 - 2.5 mm ² / 24 - 12 | 0.5 - 16 mm ² / 0.5 - 16 mm ² / 20 - 6 |
| 147.5 mm / 99 mm / 114.5 mm | |

Ordering data

| Type | Order No. | Pcs. / Pkt. |
|----------------------|-----------|-------------|
| ELR 3-24DC/500AC-16 | 2297235 | 1 |
| ELR 3-230AC/500AC-16 | 2297248 | 1 |

Accessories

| | | |
|--------------------|---------|---|
| THERMAL FUSE TF104 | 2900796 | 1 |
|--------------------|---------|---|

Technical data

| | |
|---|-------------------------|
| 24 V DC 0.8 ... 1.25 | 230 V AC 0.4 ... 1.1 |
| 8.3 mA | 12.5 mA |
| Protection against polarity reversal, Surge protection | Surge protection |
| - / Yellow LED / Red LED | |

| | |
|---|---|
| 48 V AC ... 575 V AC 1200 V max. 37 A (see derating curve) | 48 V AC ... 575 V AC 1200 V max. 37 A (see derating curve) |
|---|---|

| | |
|-----------------------|-----------------------|
| 1300 A (t = 10 ms) | 1300 A (t = 10 ms) |
| 200 mA | 200 mA |
| < 1.5 V | < 1.5 V |
| 6 mA | 6 mA |
| 9000 A ² s | 9000 A ² s |
| RCV circuit | |

| | |
|-------|---|
| 500 V | 6 kV/basic isolation max. 10 Hz -25°C ... 70°C DIN EN 50178 / EN 60947 DWR 1300 / ZXX01/DD/7080.8d IP20 Vertical (horizontal DIN rail) Can be aligned with spacing = 40 mm |
|-------|---|

| | |
|---|--|
| 0.2 - 4 mm ² / 0.2 - 2.5 mm ² / 24 - 12 | 0.5 - 16 mm ² / 0.5 - 16 mm ² / 20 - 6 |
| 147.5 mm / 99 mm / 114.5 mm | |

Ordering data

| Type | Order No. | Pcs. / Pkt. |
|------------------------|-----------|-------------|
| ELR 2+1-24DC/500AC-37 | 2297277 | 1 |
| ELR 2+1-230AC/500AC-37 | 2297280 | 1 |

Accessories

| | | |
|--------------------|---------|---|
| THERMAL FUSE TF104 | 2900796 | 1 |
|--------------------|---------|---|

Solid-state contactors

Electronic reversing load relay, with integrated soft switch

The ELR W 3/9-400 S soft switch can be used to increase the service life of a 3-phase induction motor.

- Parameterization is performed directly on the device via display and keyboard
- Friction time
- Torque, start
- Start time
- Stop time
- Torque, stop
- Braking time
- Braking torque
- Drive can be controlled locally via keyboard

| Notes: |
|--|
| Type of housing: Polycarbonate PC, color: green. |
| Marking systems and mounting material See Catalog 5 |
| 1) EMC: Class A product, see page 571 |

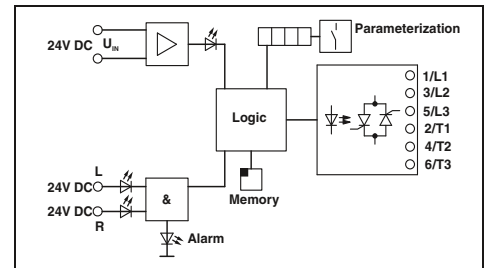

Technical data

| | |
|---|---|
| Input data | |
| Supply nominal voltage U_{VN} | 24 V DC |
| Supply voltage range with reference to U_{VN} | 0.8 ... 1.2 |
| Quiescent current | 85 mA |
| Control voltage U_{ST} right/left | 24 V DC |
| Control voltage range in reference to U_{ST} | 0.8 ... 1.2 |
| Typ. input current at U_N | 5 mA |
| Input circuit | Protection against polarity reversal, Surge protection |
| Operating voltage / status / error indicator | Green LED / Yellow LED / Red LED |
| Output data load side | |
| Maximum switching voltage | 440 V AC (L1/T1) 440 V AC (L2/T2) 440 V AC (L3/T3) 110 V AC ... 433 V AC |
| Output voltage range | 1000 V |
| Periodic peak reverse voltage | < 8 A (IL1, at 20°C Tu, see derating) |
| Load current | < 8 A (IL2, at 20°C Tu, see derating) < 8 A (IL3, at 20°C Tu, see derating) 230 A (tp = 10 ms, at 25°C) 150 mA |
| Surge current | Typ. 1.5 V (For IL) |
| Minimum load current | 5 mA (IL1, in switched-off state) |
| Residual voltage | RC element, surge protection |
| Leakage current | |
| Output protection | |
| General data | |
| Test voltage input/output | 2.5 kV |
| Ambient temperature (operation) | -20°C ... 60°C |
| Standards/regulations | DIN EN 50178 / Safe isolation |
| Power station requirements | DWR 1300 / ZX01/DD/7080.8d |
| EMC regulations | EN 61000-6-2 / EN 61000-6-4 |
| Degree of protection according to IEC 60529/ EN 60529 | IP20 |
| Mounting position | Vertical (horizontal DIN rail) |
| Mounting | Can be aligned with > 20 mm spacing |
| Screw connection solid / stranded / AWG | 0.2 - 6 mm ² / 0.2 - 4 mm ² / 24 - 10 |
| Dimensions | 62 mm / 94 mm / 122 mm |

| | |
|---|---|
| Technical data | |
| Supply nominal voltage U_{VN} | 24 V DC |
| Supply voltage range with reference to U_{VN} | 0.8 ... 1.2 |
| Quiescent current | 85 mA |
| Control voltage U_{ST} right/left | 24 V DC |
| Control voltage range in reference to U_{ST} | 0.8 ... 1.2 |
| Typ. input current at U_N | 5 mA |
| Input circuit | Protection against polarity reversal, Surge protection |
| Operating voltage / status / error indicator | Green LED / Yellow LED / Red LED |
| Output data load side | |
| Maximum switching voltage | 440 V AC (L1/T1) 440 V AC (L2/T2) 440 V AC (L3/T3) 110 V AC ... 433 V AC |
| Output voltage range | 1000 V |
| Periodic peak reverse voltage | < 8 A (IL1, at 20°C Tu, see derating) |
| Load current | < 8 A (IL2, at 20°C Tu, see derating) < 8 A (IL3, at 20°C Tu, see derating) 230 A (tp = 10 ms, at 25°C) 150 mA |
| Surge current | Typ. 1.5 V (For IL) |
| Minimum load current | 5 mA (IL1, in switched-off state) |
| Residual voltage | RC element, surge protection |
| Leakage current | |
| Output protection | |
| General data | |
| Test voltage input/output | 2.5 kV |
| Ambient temperature (operation) | -20°C ... 60°C |
| Standards/regulations | DIN EN 50178 / Safe isolation |
| Power station requirements | DWR 1300 / ZX01/DD/7080.8d |
| EMC regulations | EN 61000-6-2 / EN 61000-6-4 |
| Degree of protection according to IEC 60529/ EN 60529 | IP20 |
| Mounting position | Vertical (horizontal DIN rail) |
| Mounting | Can be aligned with > 20 mm spacing |
| Screw connection solid / stranded / AWG | 0.2 - 6 mm ² / 0.2 - 4 mm ² / 24 - 10 |
| Dimensions | 62 mm / 94 mm / 122 mm |

Ordering data

| |
|--|
| Description |
| Electronic reversing load relay, with an integrated soft switch |

| Type | Order No. | Pcs. / Pkt. |
|-------------------------------|-----------|-------------|
| ELR W3/ 9-400 S ¹⁾ | 2963569 | 1 |

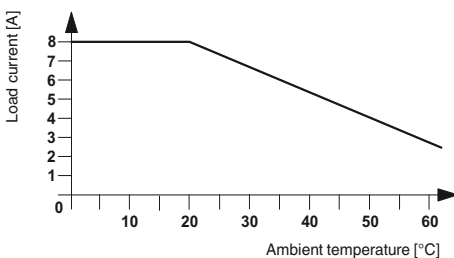

Load current as a function of the ambient temperature
Operating time: 100% operating factor

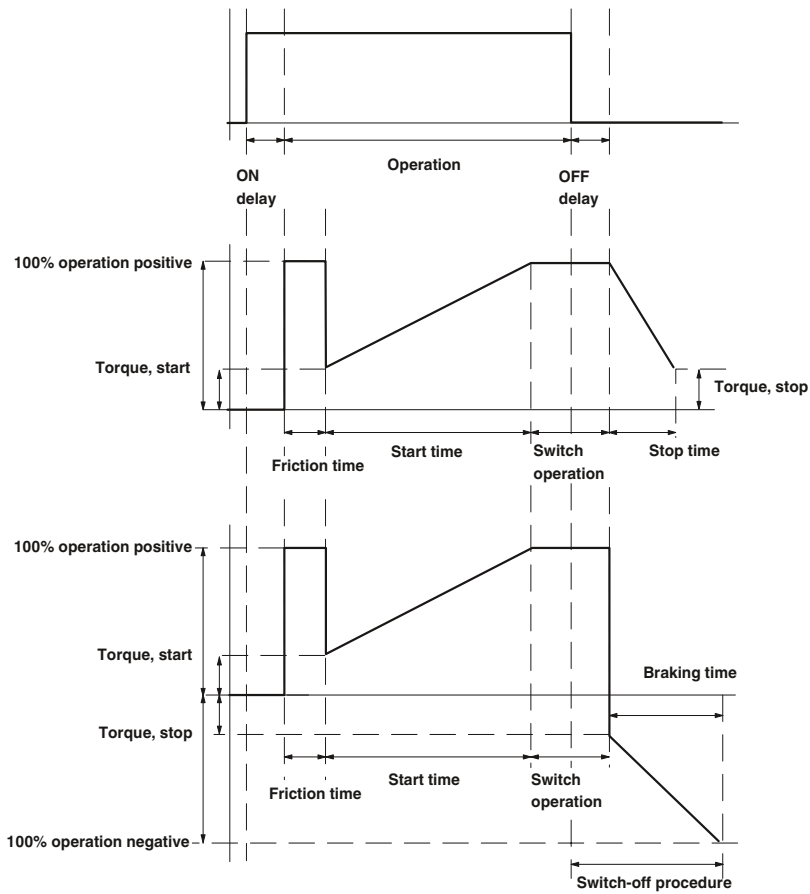

The figure shows the control of the reversing load relay with a soft starter and the operation of a three-phase current load.

Solid-state contactors

Electronic reversing load relay for DC motors

The ELR-DC electronic reversing load relay allows mechanically commutated DC motors to be switched. They reverse and reduce the speed of DC motors up to 24 V/6 A in a wear-free manner. A short-circuit, surge-voltage, and overload-proof output guarantees reliable use in the plant.

If a 24 V DC signal is applied to the “left” input, the ELR-DC is interconnected so that the output supplies the motor with voltage. If the “right” input is triggered, the polarity of the voltage is inverted on the output. By triggering both inputs, i.e., “right” and “left”, the motor is short-circuited internally via the ELR-DC and reduces the speed.

Thanks to the internal interlocking circuit and load wiring, wiring expense is reduced to a minimum.

| Notes: |
|--|
| Type of housing: Polycarbonate PC, color: green. |
| Marking systems and mounting material See Catalog 5 |
| PWM = Pulse Width Modulation |
| 1) EMC: Class A product, see page 571 |



Application example

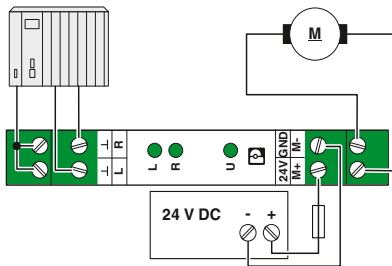

Status table

| Input | | Output | |
|-------|------|-----------------|-----------------|
| Right | Left | M + | M - |
| 0 | 0 | High resistance | High resistance |
| 1 | 0 | +24 V | GND |
| 0 | 1 | GND | +24 V |
| 1 | 1 | GND | GND |

Load current depending on ambient temperature

Operating time: 100% OT



- ① Single device
- ② Aligned without spacing

| | |
|------------------------------|--|
| Input data | Control voltage U_{ST} right/left Control voltage range in reference to U_{ST} Typ. input current at U_N Input circuit Operating voltage / status / error indicator |
| PWM option | Maximum clock frequency of the PWM at the control inputs |
| Output data load side | Pulse width repetition rate of the PWM Output voltage range Load current |
| Quiescent current | Current limitation at short-circuits Output protection Operating voltage / status / error indicator |
| General data | Test voltage input/output Ambient temperature (operation) Nominal operating mode Standards/regulations Degree of protection according to IEC 60529/ EN 60529 Mounting position Screw connection solid / stranded / AWG Dimensions |

| Technical data | |
|--|--|
| 24 V DC 0.8 ... 1.2 3 mA | 24 V DC 0.8 ... 1.2 3 mA |
| Protection against polarity reversal, Surge protection Green LED / LED yellow, forward running (R), LED yellow, reverse running (L) / - | |
| 1000 Hz | 1000 Hz |
| 0% ... 100% | 0% ... 100% |
| 10 V DC ... 30 V DC 2 A (Mounted in rows with zero spacing) | 10 V DC ... 30 V DC 6 A (see derating curve) |
| Approx. 7 mA (When switched off) 15 A | Approx. 7 mA (When switched off) 20 A |
| Protection against polarity reversal, Surge protection Green LED / - / - | |
| 2.5 kV AC -20°C ... 60°C 100% operating factor EN 50178 / Basic insulation IP20 Vertical (horizontal DIN rail) 0.2 - 6 mm ² / 0.2 - 4 mm ² / 24 - 10 12.5 mm / 99 mm / 114.5 mm | |

| | | |
|--------------------|--|--|
| Description | 3-phase solid-state reversing contactor, for controlling DC motors | |
|--------------------|--|--|

| Ordering data | | |
|------------------------------|-----------|-------------|
| Type | Order No. | Pcs. / Pkt. |
| ELR W1/ 2-24DC ¹⁾ | 2963598 | 1 |
| ELR W1/ 6-24DC ¹⁾ | 2982090 | 1 |



For switching 1~ AC motors up to 660 V AC/30 A



For switching 1~ AC motors up to 660 V AC/50 A



Technical data

| | |
|--------------------|----------------------|
| 4 V DC ... 32 V DC | 24 V AC ... 275 V AC |
| Approx. 12 mA | Approx. 17 mA |
| ≥ 4 V DC | ≥ 22 V AC |
| ≤ 1 V DC | ≤ 6 V AC |
| 25 Hz | 6 Hz |
| Green LED / - / - | |

| | |
|---------------------------------|---------------------------------|
| 42 V AC ... 660 V AC (45/65 Hz) | 42 V AC ... 660 V AC (45/65 Hz) |
| 1200 V | 1200 V |
| 30 A (see derating curve) | 30 A (see derating curve) |
| 400 A (t = 10 ms) | 400 A (t = 10 ms) |
| 150 mA | 150 mA |
| < 1.6 V | < 1.6 V |
| < 3 mA (In off state) | < 3 mA (In off state) |
| 0.5 | 0.5 |
| 1800 A ² s | 1800 A ² s |
| RCV circuit | |

4 kV_{rms}
 -30°C ... 70°C
 EN 61000-4-2 / EN 61000-4-3 / EN 61000-4-4 / EN 61000-4-5 / EN 61000-4-6 / EN 55011 / Basic insulation

Vertical (horizontal DIN rail)
 Can be aligned with ≥ 22.5 mm spacing

0.5 - 2.5 mm² / 0.5 - 2.5 mm² / 20 - 14
 0.5 - 4 mm² / 0.5 - 4 mm² / 20 - 12
 22.5 mm / 103 mm / 103 mm

Ordering data

| Type | Order No. | Pcs. / Pkt. |
|----------------------|-----------|-------------|
| ELR 1- 24DC/600AC-30 | 2297154 | 1 |
| ELR 1-230AC/600AC-30 | 2297167 | 1 |



Technical data

| | |
|--------------------|----------------------|
| 4 V DC ... 32 V DC | 24 V AC ... 275 V AC |
| Approx. 12 mA | Approx. 17 mA |
| ≥ 4 V DC | ≥ 22 V AC |
| ≤ 1 V DC | ≤ 6 V AC |
| 25 Hz | 6 Hz |
| Green LED / - / - | |

| | |
|---------------------------------|---------------------------------|
| 42 V AC ... 660 V AC (45/65 Hz) | 42 V AC ... 660 V AC (45/65 Hz) |
| 1200 V | 1200 V |
| 50 A (see derating curve) | 50 A (see derating curve) |
| 1900 A (t = 10 ms) | 1900 A (t = 10 ms) |
| 150 mA | 150 mA |
| < 1.6 V | < 1.6 V |
| < 3 mA (In off state) | < 3 mA (In off state) |
| 0.5 | 0.5 |
| 18,000 A ² s | 18,000 A ² s |
| RCV circuit | |

4 kV_{rms}
 -30°C ... 70°C
 EN 61000-4-2 / EN 61000-4-3 / EN 61000-4-4 / EN 61000-4-5 / EN 61000-4-6 / EN 55011 / Basic insulation

Vertical (horizontal DIN rail)
 Can be aligned with ≥ 22.5 mm spacing

0.5 - 4 mm² / 0.5 - 4 mm² / 20 - 12
 4 - 25 mm² / 4 - 25 mm² / 12 - 3
 45 mm / 103 mm / 103 mm

Ordering data

| Type | Order No. | Pcs. / Pkt. |
|----------------------|-----------|-------------|
| ELR 1- 24DC/600AC-50 | 2297170 | 1 |
| ELR 1-230AC/600AC-50 | 2297183 | 1 |

Inline frequency inverters for the control cabinet are the compact solution for extending your Easy Automation solution to include electronic speed regulation for asynchronous motors. The devices seamlessly integrate into the Inline system and have IP20 protection. Depending on the drive task, you can select frequency inverters from various performance classes, up to a maximum of 4 kW. In order to connect to the Inline system via the Fieldline local bus, you just need the IB IL 24 FLM-PAC Inline module. The Inline frequency inverter can be connected to a Phoenix Contact controller via the Inline module.

Additional features:

- Maximum motor power
0.75 kW, 1.5 kW, 2.2 kW, and 4.0 kW
- 3 x 400 V mains input (±15%) 50/60 Hz
- DTM for parameterization and diagnostics
- 8 freely programmable parameter records
- PTC evaluation for
2.2 kW and 4.0 kW versions
- Integrated line filter
- U/f linear and U/f square operating modes
- S-ramp function
- Motor protection function (I^2t)
- Connection of a braking resistor
- DC braking
- Evaluation of the temperature switch in the motor
- Voltage boost
- 1 x analog input, 1 x analog output,
1 x relay output

Notes:

1) EMC: Class A product, see page 571



0.75 kW

N

| Technical data | | | |
|--|--|-----------|-------------|
| Interface | | | |
| Name | Fieldline local bus | | |
| Connection method | 9-pos. D-SUB plug/socket | | |
| Power supply for module electronics | | | |
| Supply voltage | 24 V DC ±15% | | |
| Supply voltage range | 20.4 V DC ... 27.6 V DC ±15% | | |
| Digital inputs | | | |
| Number of inputs | 5 | | |
| Connection method | COMBICON | | |
| Connection method | Spring-cage connection | | |
| Digital outputs | | | |
| Number of outputs | 1 | | |
| Connection method | COMBICON | | |
| Connection method | Spring-cage connection | | |
| Motor starter, output | | | |
| Connection method | PCB terminal block | | |
| Nominal current range | 2.6 A (Short-term peak current, 1.5 times the nominal current for 30 s; permissible continuous current, 1.2 times the nominal current range) | | |
| Frequency range | 0 Hz ... 400 Hz | | |
| Nominal motor power | 0.75 kW | | |
| Tripping class | 5.6 A OC tripping current | | |
| General data | | | |
| Weight | 1400 g | | |
| Degree of protection | IP20 | | |
| Width | 86.8 mm | | |
| Height | 184 mm | | |
| Depth | 132.9 mm | | |
| Ordering data | | | |
| Description | Type | Order No. | Pcs. / Pkt. |
| Inline frequency inverters for the control cabinet | VFD 5007 IL IB | 2701054 | 1 |
| Accessories | | | |
| Inline Modular branch terminal for coupling one Fieldline Modular M8 local bus at the end of an Inline station | IB IL 24 FLM-PAC ¹⁾ | 2736903 | 1 |
| Remote bus cable, highly stranded, 3 x 2 x 0.25 mm ² | IBS RBC/F-T/ | 2740151 | 1 |



Frequency inverter for a max. motor power of up to 1.5 kW



Frequency inverter for a max. motor power of up to 2.2 kW



Frequency inverter for a max. motor power of up to 4.0 kW

| Technical data |
|--|
| Fieldline local bus 9-pos. D-SUB plug/socket |
| 24 V DC $\pm 15\%$ 20.4 V DC ... 27.6 V DC $\pm 15\%$ |
| 5 COMBICON Spring-cage connection |
| 1 COMBICON Spring-cage connection |
| PCB terminal block 4.1 A (Short-term peak current, 1.5 times the nominal current for 30 s; permissible continuous current, 1.2 times the nominal current range) |
| 0 Hz ... 400 Hz 1.5 kW 8.8 A OC tripping current |
| 1400 g IP20 86.8 mm 184 mm 132.9 mm |

| Technical data |
|--|
| Fieldline local bus 9-pos. D-SUB plug/socket |
| 24 V DC $\pm 15\%$ 20.4 V DC ... 27.6 V DC $\pm 15\%$ |
| 5 COMBICON Spring-cage connection |
| 1 COMBICON Spring-cage connection |
| PCB terminal block 5.8 A (Short-term peak current, 1.5 times the nominal current for 30 s; permissible continuous current, 1.2 times the nominal current range) |
| 0 Hz ... 400 Hz 2.2 kW 12.5 A OC tripping current |
| 2006 g IP20 114 mm 184 mm 153 mm |

| Technical data |
|--|
| Fieldline local bus 9-pos. D-SUB plug/socket |
| 24 V DC $\pm 15\%$ 20.4 V DC ... 27.6 V DC $\pm 15\%$ |
| 5 COMBICON Spring-cage connection |
| 1 COMBICON Spring-cage connection |
| PCB terminal block 9.1 A (Short-term peak current, 1.5 times the nominal current for 30 s; permissible continuous current, 1.2 times the nominal current range) |
| 0 Hz ... 400 Hz 4 kW 21 A OC tripping current |
| 2006 g IP20 114 mm 184 mm 153 mm |

| Ordering data | | |
|----------------|-----------|-------------|
| Type | Order No. | Pcs. / Pkt. |
| VFD 5015 IL IB | 2701055 | 1 |

| Ordering data | | |
|----------------|-----------|-------------|
| Type | Order No. | Pcs. / Pkt. |
| VFD 5022 IL IB | 2701057 | 1 |

| Ordering data | | |
|----------------|-----------|-------------|
| Type | Order No. | Pcs. / Pkt. |
| VFD 5040 IL IB | 2701058 | 1 |

| Accessories | | |
|--------------------------------|-----------|-------------|
| Type | Order No. | Pcs. / Pkt. |
| IB IL 24 FLM-PAC ¹⁾ | 2736903 | 1 |
| IBS RBC/F-T/ | 2740151 | 1 |

| Accessories | | |
|--------------------------------|-----------|-------------|
| Type | Order No. | Pcs. / Pkt. |
| IB IL 24 FLM-PAC ¹⁾ | 2736903 | 1 |
| IBS RBC/F-T/ | 2740151 | 1 |

| Accessories | | |
|--------------------------------|-----------|-------------|
| Type | Order No. | Pcs. / Pkt. |
| IB IL 24 FLM-PAC ¹⁾ | 2736903 | 1 |
| IBS RBC/F-T/ | 2740151 | 1 |

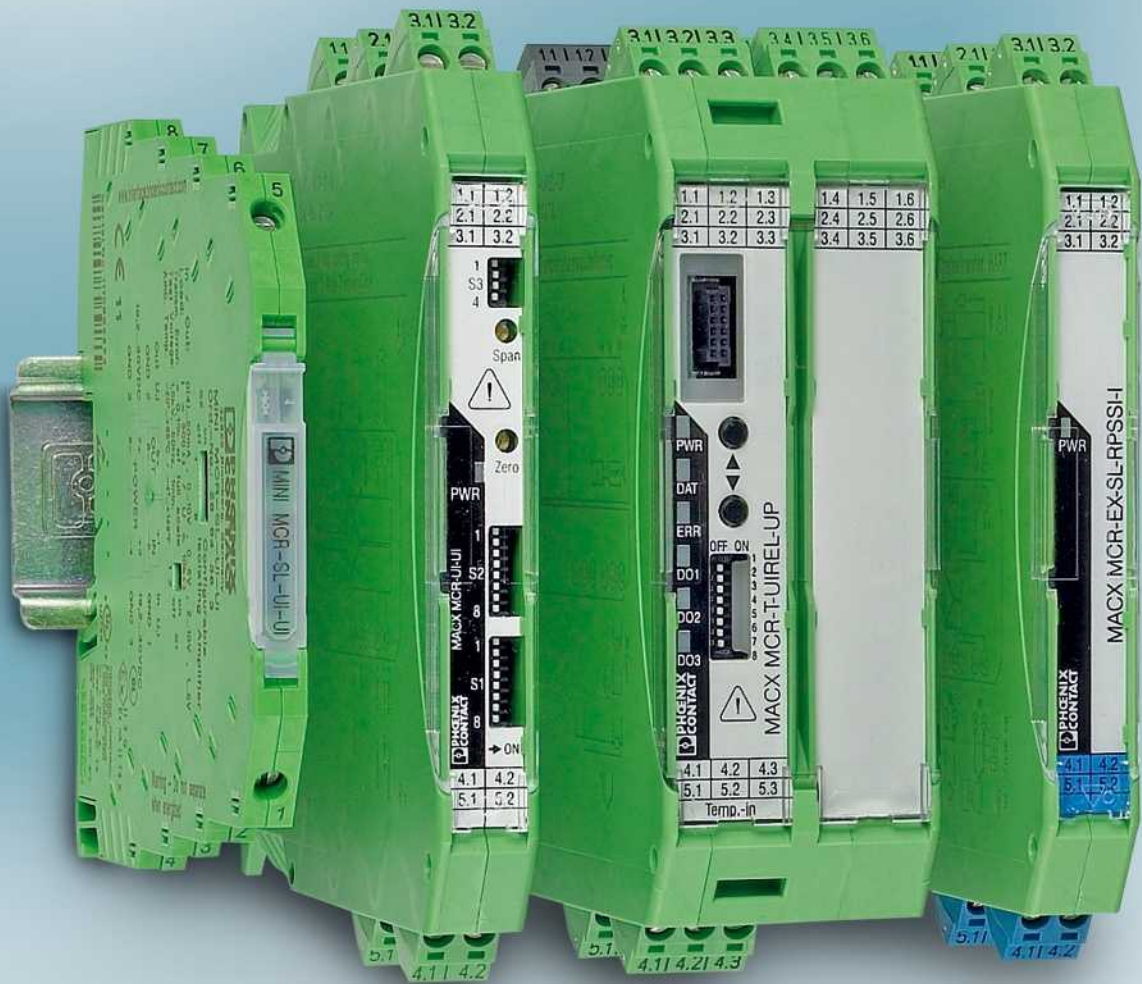

Measurement and control technology

The modular analog converters for measurement and control technology prevent analog signals from being distorted by disturbance variables. With accurate conversion, isolation, filtering or amplification of analog signals, they secure and increase transmission quality and therefore the quality of closed-loop control circuits.

We offer the following product ranges:

Highly compact isolating amplifiers – MINI Analog

- For significant space savings and efficiency
- Design width of just 6.2 mm
- System cabling and multiplexer solutions
- 3-way electrical isolation

Isolating amplifiers with SIL functional safety – MACX Analog

- For maximum signal safety
- Consistent SIL certification
- Safe 3-way electrical isolation

Isolating amplifiers, special types, and digital displays – MCR Analog

- For special applications in signal processing
- Electrical isolation
- Record and convert temperatures directly in the field

Ex i isolating amplifiers with SIL functional safety – MACX Analog Ex

- For intrinsically safe circuits in the Ex area
- Maximum explosion protection for all Ex zones and gas groups
- Design width of just 12.5 mm for all single- and two-channel devices
- Safe 3-way electrical isolation

Product range overview

| | |
|---|------------|
| Product overview | 54 |
| Selection guide for isolating amplifiers | 56 |
| Basics | 58 |
| Highly compact isolating amplifiers – MINI Analog | 64 |
| Analog IN/Analog OUT | 66 |
| Temperature | 76 |
| Frequency | 82 |
| Potentiometers | 84 |
| Limit values | 85 |
| Digital IN | 86 |
| Accessories | 87 |
| Isolating amplifiers with SIL functional safety – MACX Analog | 100 |
| Analog IN/Analog OUT | 102 |
| Temperature potentiometers/limit values | 110 |
| Digital IN | 120 |
| Accessories | 126 |
| Isolating amplifiers, special designs, and digital displays – MCR Analog | 130 |
| Analog IN/Analog OUT | 131 |
| Temperature potentiometers/limit values | 136 |
| Frequency | 144 |
| Limit values | 146 |
| Accessories | 149 |
| Digital displays | 150 |
| EX i isolating amplifiers with SIL functional safety – MACX Analog Ex | 152 |
| Analog IN | 160 |
| Analog OUT | 164 |
| Temperature | 165 |
| Digital IN | 172 |
| Digital OUT | 179 |
| Accessories | 182 |
| Multiplexers for HART signals | 186 |
| Ex i 2-conductor field devices | 187 |
| Accessories | 190 |

Highly compact isolating amplifiers



MINI Analog

Page 64



Supply components, feed-through terminal blocks, marking material

Page 88



System cabling, termination carriers

Page 92



Surge protection

Page 98

Digital displays



For standard signals, setpoint adjusters

Page 150

Ex i isolating amplifiers with functional safety



MACX Analog Ex

Page 152



Supply components, marking material

Page 182



System cabling, termination carriers

Page 184

Energy and power measuring technology



EMpro energy meters

Page 200



EMpro special function and communication modules

Page 202



PSK data logger kits

Page 206



PSK compressed air meters

Page 208



Current protectors, AC

Page 235



Voltage transducers

Page 236



SOLARCHECK PV string monitoring

Page 134



EMD-BL compact monitoring relays

Page 250

Isolating amplifiers with functional safety



MACX Analog Page 100



Supply components, marking material Page 126



System cabling, termination carriers Page 128

**Isolating amplifiers
Special designs**



MCR Analog Page 130

Multiplexers



Multiplexers for HART signals Page 186

Ex i 2-cond. field devices



Ex i 2-conductor field devices Page 187

Accessories



Shield fast connection Page 191



Test plugs Page 191

Current transformers



PACT current transformers Page 212

Test disconnect terminal blocks

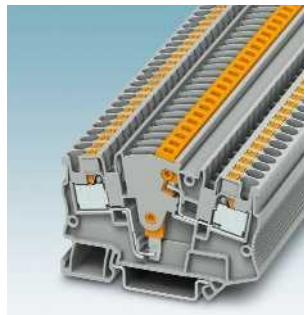

Test disconnect terminal blocks See Catalog 3

Current and voltage measuring technology



Current transducers, AC/DC Page 229



Current transducers, AC Page 232



EMD multifunctional monitoring relays Page 252

Controllers



Controllers See Catalog 8

Surge protection



Surge protection for measurement and control technology See Catalog 6



Highly compact isolating amplifiers -
MINI Analog

| | | Page |
|-------------------------------|---|---------|
| Analog IN/Analog OUT | | |
| 3-way isolating amplifiers | Configurable | From 66 |
| | Fixed signal combinations | 71 |
| 4-way signal duplicators | Configurable | 72 |
| 3-way repeater power supplies | 1-channel | 73 |
| | Signal duplicators | |
| | 2-channel | |
| 2-way passive isolators | Supplied by an input loop | 74 |
| | Supplied by an output loop | 75 |
| 3-way output isolators | Fixed signal combinations | |
| Digital displays | Standard signals | |
| | Setpoint adjuster | |
| Temperature | | |
| Temperature transducers | | |
| | Universal | |
| | Universal, supplied by an output loop | |
| | For resistance thermometers (RTD) | 76 |
| | For resistance thermometers (RTD), passive | |
| | For Pt 100 | From 77 |
| | For Pt 100, supplied by an output loop | 79 |
| | For thermocouples | 80 |
| | For thermocouples, type J and K | 81 |
| Temperature head transmitters | Universal, supplied by an output loop | |
| | Pt 100, supplied by an output loop | |
| Frequency | | |
| Frequency transducers | | |
| | Universal | 82 |
| Analog frequency transducers | | |
| | | 83 |
| Potentiometer/resistor | | |
| Potipotentiometers | | |
| | | 84 |
| Setpoint potentiometers | | |
| Limit values | | |
| Threshold value switches | | |
| | Standard analog signals, universal | |
| | Standard analog signals | 85 |
| | Temperature | |
| Digital IN | | |
| Isolation amplifiers | | |
| | NAMUR sensors, floating contacts | 86 |
| | NAMUR sensors, floating contacts, 2-channel | |
| | NAMUR sensors, floating contacts, wide range | |
| | NAMUR sensors on NAM | |
| Digital OUT | | |
| Solenoid drivers | | |
| | Loop-powered | |
| | With line fault detection | |
| Accessories | | |
| Configuration | | |
| | Configuration software | |
| | Cables | 119 |
| | Display unit and operator interface, removable | |
| | Holder module for display unit and operator interface | |
| Constant voltage source | Constant voltage source | 87 |
| Setpoint potentiometers | | |
| System cabling | System components | 94 |
| | 1:1 feed-through terminal block | 88 |
| | Termination carriers | 97 |
| | Analog multiplexers | 95 |
| | Multiplexers for HART signals | |
| Multiplexers | | |
| Supply components | Power terminal block/error message modules/ T-Connectors/system power supply | From 89 |
| Marking material | | 88 |
| Surge protection | | 98 |
| Shield fast connection | | 191 |
| Test plugs | | |
| Resistance circuit | For line fault detection | 183 |



Isolating amplifiers with functional safety - MACX Analog



Special types of isolating amplifiers and digital displays



Ex i isolating amplifiers with functional safety - MACX Analog Ex

| Page | Page | Page |
|----------|------|----------|
| From 102 | 131 | 160 |
| 106 | 132 | 160 |
| 107 | | 161 |
| | | 162 |
| | 134 | |
| 109 | | 164 |
| | 150 | |
| | 151 | |
| From 114 | 136 | From 168 |
| 110 | 140 | 187 |
| | | 165 |
| | 138 | |
| 112 | 141 | 166 |
| | | |
| | 142 | 188 |
| | 143 | 189 |
| | | |
| | 144 | |
| | | |
| From 114 | | From 168 |
| | 148 | |
| | | |
| 116 | 146 | 170 |
| | 147 | |
| | 139 | |
| | 146 | |
| | | |
| 120 | | 172 |
| 124 | | 176 |
| 122 | | 174 |
| 125 | | 177 |
| 123 | | 175 |
| | | 178 |
| | | |
| | | From 179 |
| | | 179 |
| | | |
| | 149 | 149 |
| 119 | 149 | 149 |
| 118 | | |
| 118 | | |
| | | |
| | 148 | |
| | | |
| 129 | | 184 |
| | | |
| | | 186 |
| From 126 | | 126 |
| 127 | | 127 |
| | | |
| 191 | 191 | 191 |
| 191 | | 191 |
| 183 | | 183 |

Input

Maximum input signal

The maximum input signal describes the value achieved before any damage occurs to the module and the signal generator. If these values are exceeded, suppresser diodes can be triggered to short circuit this input when a surge voltage is detected. The transmission range of the analog signals is located exclusively within the specified input ranges.

Input resistance

The input resistance of an isolating amplifier or measuring transducer is determined in such a way as to ensure that the input signal is loaded only slightly. This results in a low-resistance input for current inputs and a high-resistance input for voltage inputs.

Voltage drop

In the case of passive isolators, the input voltage drop occurs as a result of the voltage drop of the operational load and the auxiliary power requirements of the module. The greater the auxiliary power requirements of the passive isolator, the smaller the operational output load is allowed to be. Low auxiliary power requirements are regarded as an indicator of device quality.

Common mode rejection

In the case of isolating amplifiers, operational amplifiers are used internally for transmission purposes. In theory, operational amplifiers should display ideal transmission and amplification behavior. However, it is a different matter in practice. When both input voltages are changed in the same direction, i.e., exactly the same voltage to ground is applied to both input terminal blocks, this leads to an unintended output signal. Theoretically, if the operational amplifier is ideal, no output signal should appear since the differential input signal is "0 V". Common mode rejection indicates the factor (in dB) by which the common input voltage at both inputs is amplified to a lesser extent than the difference in voltage between the two inputs.

Analog output

Maximum output signal

If the devices operate without fault conditions, an overload at the input cannot cause greater values than this maximum to occur at the output.

Zero/span adjustment

When the zero point is set, the zero point of an analog output is adjusted and set in relation to the input signal.

When the "amplification" span is set, the analog output is adjusted in relation to the input signal. In this case, the output characteristic is increased or decreased by an amplification factor.

Load

The load on the output side indicates the load-carrying capacity of a measuring transducer or an isolating amplifier. Current outputs can usually drive a maximum of 500 Ω , voltage outputs can be loaded with a minimum of up to 10 k Ω .

Residual ripple/ripple

A superimposed ripple can appear on the output signal due to signal conditioning required by the circuit. The residual ripple is indicated in mV_{pp} or mV_{rms}.

Open circuit response

With some measuring transducers, the input signal is permanently monitored for possible open circuits in the signal cable. If the signal exceeds or falls below a tolerance limit, an open circuit is detected and a defined output signal is sent. With programmable devices, the output signals can be freely selected.

Digital output

Relays

Many of the products with a relay output that are shown in the catalog feature hard gold-plated relay contact material. The voltage range has an important role to play in terms of how this contact material can be used. Up to 50 mA can be transmitted with voltage ranges of up to 30 V AC/36 V DC. Even very small currents are transmitted perfectly. If the aforementioned voltage range is exceeded and values of 250 V AC/DC are processed, currents of up to 2 A can flow. However, in this case the subsequent transmission of small currents can no longer be guaranteed.

Transistor

A PNP transistor switching output can be used to transmit 24 V DC switching signals up to approximately 100 mA.

General data

Supply voltage

The product range includes DC and AC power supply units for specific products. There is a standard power supply unit available in the form of a 24 V DC version that operates within a voltage range of 20 ... 30 V DC. For other supply voltages, please refer to the technical data.

Current consumption

The value specified here describes the auxiliary power requirements of the devices. It also includes the output current and, where applicable, the switching output load.

Transmission errors

The transmission precision is a gauge of the quality of a measuring transducer. It is the deviation from the ideal transmission characteristic curve and includes linearity, span, and offset errors.

Non-linearity

Non-linearity is the deviation from the ideal transmission precision without including span and offset errors.

The non-linearity of a signal makes it possible to evaluate the course from zero to end point. Normally, the linearity errors are expressed as a percentage that indicates the extent of deviation from the ideal transmission characteristic curve.

Temperature coefficient

The temperature coefficient provides an assessment of the extent to which precision deviates when the ambient temperature around an isolating amplifier or measuring transducer changes. In most cases this is specified as a percentage. An alternative definition is ppm/K (parts per million/Kelvin). Example:

250 ppm/K = 0.025%/K.

Limit frequency

Isolating amplifiers are basically designed to transmit DC signals. However, signal changes call for a dynamic form of behavior so that small AC quantities (normally: 30 Hz) can also be transmitted. This is achieved by defining a limit frequency. At the same time, a low limit frequency can be used to suppress higher-frequency AC components.

Step response

The step response indicates the response time of the output signal when an input signal step occurs (10 ... 90%). The step response is inversely proportional to the limit frequency. This means that the response time decreases as the limit frequency increases.

Test voltage

The test voltage indicates the dielectric strength of an isolated distance and is determined by type tests. In this test, a 50 Hz voltage is applied for one minute; it describes the value achieved before a disruptive discharge is able to move to another potential level in the device.

Safe isolation

“Safe isolation” is defined as protection against hazardous shock currents. When module specifications are provided in accordance with EN 61010, a distinction is made between faultless operation and operation under fault conditions. Nominal supply voltages of 30 V AC/60 V DC are deemed valid for faultless operation.

Ambient temperature range

The temperature limits specified here relate exclusively to operation. These limits do not apply to storage and transport. It is here where the temperature limits of the materials used are the decisive factor. If the devices are outside of the specified temperature range during assembly, they must be brought back within the specified temperature range prior to system startup. It is important to make sure that no condensation occurs during this process.

Protective circuit

In order to protect the measurement and control modules against surge voltages, suppressor diodes are connected upstream of the signal and supply paths. These diodes behave in a similar manner to conventional Zener diodes, except for the fact that suppressor diodes have faster response times and a higher maximum current.

Information on directives and standards

When carrying out further processing of non-independent items of equipment (components), the applicable regulations pertaining to installation must be observed.

The relevant device-specific regulations also apply with regard to installation in devices.
(Standards applicable at the time of going to print)

| Directives | EU | International |
|---|-------------------|--------------------|
| EMC Directive (electromagnetic compatibility) | 2004/108/EC | - |
| Low Voltage Directive (LVD) | 2006/95/EC | - |
| Ex Directive (ATEX) | 94/9/EC | - |
| Product standards | | |
| Electronic equipment for use in power installations | EN 50178:1997 | - |
| Safety requirements for electrical equipment for measurement, control and laboratory use - Part 1: General requirements | EN 61010-1:2001 | IEC 61010-1:2004 |
| Programmable controllers - Part 2: Equipment requirements and tests | EN 61131-2:2007 | IEC 61131-2:2007 |
| EMC | | |
| EMC - Part 6-2: Generic standards - Immunity for industrial environments | EN 61000-6-2:2005 | IEC 61000-6-2:2005 |
| EMC - Part 6-4: Generic standards - Emission standard for industrial environments | EN 61000-6-4:2007 | IEC 61000-6-4:2006 |
| Electrical equipment for measurement, control and laboratory use EMC requirements | EN 61326-1:2006 | IEC 61326-1:2005 |
| ATEX | | |
| Electrical apparatus for explosive gas atmospheres - Part 0: General requirements | EN 60079-0:2006 | IEC 60079-0:2007 |
| Explosive atmospheres - Part 11: Equipment protection by intrinsic safety "i" | EN 60079-11:2007 | IEC 60079-11:2006 |
| Electrical apparatus for explosive gas atmospheres - Part 15: Construction, test and marking of type of protection "n" electrical apparatus | EN 60079-15:2005 | IEC 60079-15:2005 |
| Environmental tests | | |
| Environmental testing - Part 2-1: Tests - Test A: Cold | EN 60068-2-1:2007 | IEC 60068-2-1:2007 |
| Environmental testing - Part 2-2: Tests - Test B: Dry heat | EN 60068-2-2:2007 | IEC 60068-2-2:2007 |
| Environmental testing - Part 2-6: Tests - Test Fc: Vibration (sinusoidal) | EN 60068-2-6:2008 | IEC 60068-2-6:2008 |

Active isolation

3-way isolation



In the case of modules with this isolation method, all components that are connected to the input, output or power supply are protected against interference from each other. All three directions (input, output, and power supply) are electrically isolated from one another accordingly.

The 3-way isolation provides electrical isolation between the measurement sensor and the controller as well as between the controller and the actuator.

On the input side, the modules need active signals. On the output side, they provide a filtered and amplified signal.

Input isolation



In the case of modules with this isolation method, the electronics connected on the output side (e.g., the controller) are to be protected from interference from the field. For this reason, only the input is electrically isolated from the output and the power supply that are at the same potential.

On the input side, the modules need active signals (e.g., from measurement sensors). On the output side, they provide a filtered and amplified signal (e.g., from the controller).

Repeater power supply



Repeater power supplies use the signal input side not only for measured value acquisition, but also to provide the necessary power to the passive measurement sensors connected on the input side.

On the output side, they provide a filtered and amplified signal (e.g., from the controller).

The isolation method used by these modules is input isolation.

Passive isolation

Passive isolation, supplied on the input side



The modules draw the power needed for signal transmission and electrical isolation from the active input circuit. On the output side, a conditioned current signal is provided to the controller or to actuators.

This passive isolation allows signal conditioning (interruption of ground loops) and filtering without an additional power supply.

Passive isolation, supplied on the output side (loop-powered)



The modules draw the power needed for signal transmission and electrical isolation from the active output circuit, ideally from a PLC input board that supplies power.

On the output side, the loop-powered modules operate with a 4 ... 20 mA standard signal. On the input side, the passive isolator processes active signals.

When this isolation method is used, it is important to make sure that the active signal source connected on the output side (e.g., an active PLC input board) is able to supply the passive isolator with power, as well as operate its load.

Applications

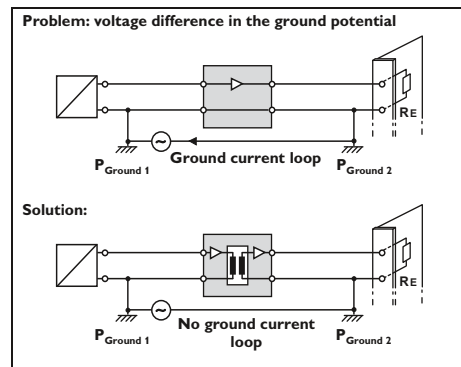
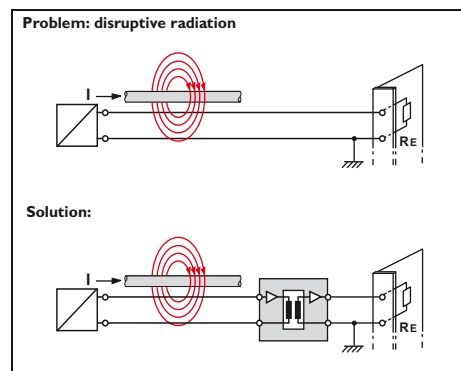

Resistance thermometers

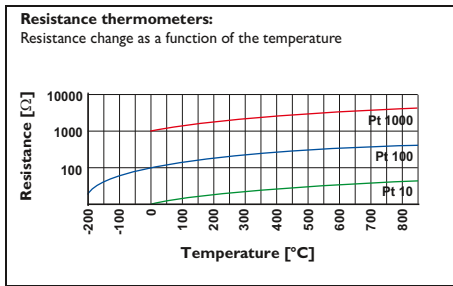

Resistance thermometers (e.g., Pt 100, Ni 1000) change their resistance value depending on the temperature. The MCR temperature transducers detect this change and convert it into a proportional analog signal.

To avoid unwanted self-heating of the sensor, the constant measured current used is kept as low as possible (MCR-T-UI... → 250 μ A).

Two-conductor connection technology

The resistance thermometer is connected to the MCR measuring transducer using a two-core cable. Please note that the supply cable resistances are added to the measured resistance and consequently distort the result.



A distance of 10 m should not be exceeded.

Example: a 50 m long copper cable with a cross section of 0.5 mm² has a specific resistance of 3.4 Ω . A Pt 100 sensor has a resistance change of 0.384 Ω per 1 K temperature change. This corresponds to an error of 8.8°C.

Three-conductor connection technology

Three-conductor technology is normally used to minimize the effect of cable resistances. An additional cable is connected to the resistance thermometer, so that the latter can be measured using two measuring circuits, one of which acts as a reference. In this way, it is possible to compensate for the cable resistance.



Identical cable lengths and an identical ambient temperature are essential here.

Since this is more or less the case in the majority of applications, three-conductor technology is the most commonly encountered today. Line compensation is not necessary.

Four-conductor connection technology

Four-conductor connection technology is an ideal connection technology for resistance thermometers.

The measurement result is affected neither by cable resistances nor by their temperature-dependent fluctuations. The voltage drop on the supply and return lines can therefore be measured and compensated for separately. Line compensation is not necessary.

Thermocouples

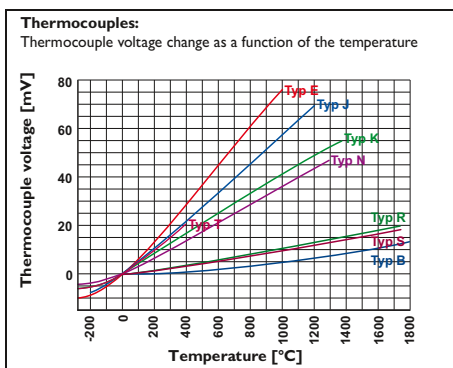

In contrast to resistance thermometers, thermocouples are active sources that generate a voltage in the microvolt range. The temperature difference measured between the measurement junction and the cold junction is converted into an absolute temperature with the help of cold junction compensation.

Operating principle:

If different metals are joined together, a thermal voltage is produced in the metal atoms as a result of the different binding energies of the electrons. This voltage is dependent firstly on the metals themselves and secondly on the temperature.

If the same temperature prevails at the measuring junction (ϑ_1) and the cold junction (ϑ_2), no current will flow because the generated partial voltages cancel each other out. However, if the temperatures at the measuring junction and the cold junction are different, different voltages are produced. These voltages do not completely cancel each other out, and so current flows.

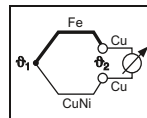

A thermocouple therefore always measures only one temperature difference. This is derived from the difference between the thermal voltages at the measuring junction and at the cold junction.

The voltage produced by the thermoelectric effect is very low; only a few microvolts per Kelvin.

Example: if a type J thermocouple (Fe-CuNi) is connected to a copper terminal block, thermal voltages with opposite polarity will be generated (at the iron-copper and copper-constantan transitions) and cancel each other out.

Therefore, only the difference in the thermal voltages between constantan (Cu-Ni) and iron is of relevance.

A role is also played by the temperature at the terminal point. If it is known, the temperature at the measuring junction can be derived by adding the thermal voltage measured at the same junction.

The MCR temperature transducers for thermocouples therefore detect the temperature at the terminal points and compensate this value, which is also referred to as the reference junction or the cold junction.

This process is sometimes called cold junction compensation.

Digital displays

Use of the freely programmable characteristic curve

The freely programmable characteristic curve, i.e., the assignment of the displayed value to the input value, is important in process applications for indicating flow rates or liquid levels.

The purpose of level measurements is very often not to determine how much liquid is still inside the tank, but rather to establish how much has been drawn out of it. In this case, the characteristic curve can simply be inverted in order to display the required value.

Parameterization of the characteristic curve using interpolation points

With non-linear input signals, the received analog values can be assigned to the value to be displayed by means of a programmable characteristic curve. This curve can consist of up to 24 interpolation points. This allows flow sensors with a non-linear characteristic curve to be adapted, for instance. The analog signal digital displays in the Function Line additionally feature a summing function which - to take a typical example from bottling technology - allows you to switch over at the touch of a button from the instantaneous value (= flow rate in

l/min) to the total flow integrated in the background, which can be displayed in any unit. This saves space and money, because there is no need for a second digital display.

Limit values can also be called at the touch of a button. Limit values 1 and 2 can be assigned to either the actual value or the cumulative value. If the latter value is exceeded, one of the two output relays is activated.

Other applications include indicating liquid levels, pressures, and temperatures. With servo motors, the analog output signals (0 ... 10 V) generated by the tachometer can be supplied to the input of the digital display in order to indicate the motor speed.

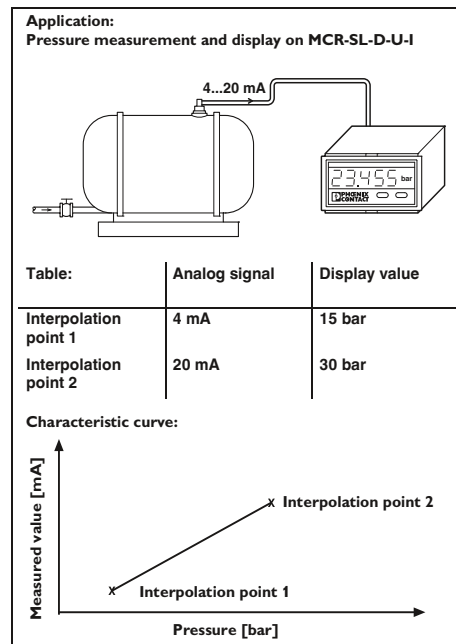

Switching behavior of relay or transistor outputs:

A different kind of switching behavior can be defined for each relay or each transistor when it reaches a preset switching point.

All the possible settings for the switching behavior are shown and explained in the list:

- The first two options include hysteresis, i.e., the behavior of the relay depends on the direction from which a switching point is reached.
- For the remaining options, with the exception of the last two ("on" and "off"), a switching tolerance is taken into account to prevent the relay contact from "chattering". The relay is not switched until the switching point plus switching tolerance has been reached.

- In the "on" state, the relay is permanently picked up. It only responds if there is an open circuit and it has been set to drop out when this happens.
- In the "off" state, the relay only responds if there is an open circuit and it has been set to pick up when this happens.

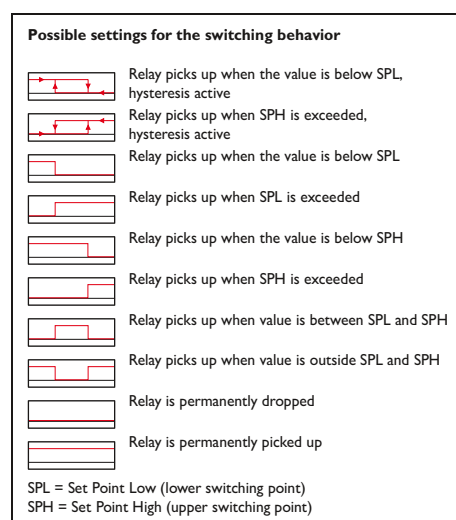

Non-intrinsically safe signal transmission in potentially explosive areas

Electrical equipment operated in systems with potentially explosive areas is subject to different usage requirements, depending on the application.

For example, electrical equipment could be used in the following locations when analog signals are being transmitted:

- Sensors and actuators can be located in zone 0, zone 1 or zone 2.
- Signal transmitters can be located in zone 1, zone 2 or the safe area.
- The controller, e.g., PLC, is in the safe area.

For examples of the kinds of electrical devices that can be installed for the purpose of transmitting signals, please see the figure.

Devices must be designed to offer a suitable protection type if they are to be used in zone 2. The MINI Analog and MACX Analog ranges are designed to provide protection type “n” for this purpose and must be installed in zone 2 in suitable and approved housing (EN 60079-15 and

EN 60079-0) with IP54 protection minimum.

Example:

A sensor/actuator with protection type “n” can be connected to an isolator from the MINI Analog or MACX Analog ranges in zone 2.

When selecting suitable devices for zone 2, it must be ensured that the electrical data of the sensors/actuators is not exceeded.

If the sensors/actuators are mounted in explosion-proof housing or if they have their own explosion-proof housing, they can also be installed in zone 1.

Installation requirements

The figure shows a range of options for installing electrical devices in areas with a danger of gas explosions. Special requirements regarding the configuration, selection, and installation of electrical systems in areas with a danger of gas explosions can be found in EN 60079-14.

In the 2008 edition, the relevant contents of EN 61241-14 were incorporated in EN 60079-14.

EN 61241-14 must still be observed when installing electrical equipment in areas containing combustible dust. Other important factors when it comes to running systems in potentially explosive areas are inspection, maintenance, and repairs. Stipulations regarding these matters can be found in EN 60079-17 and EN 60079-19.

Installation of electrical devices for signal transmission



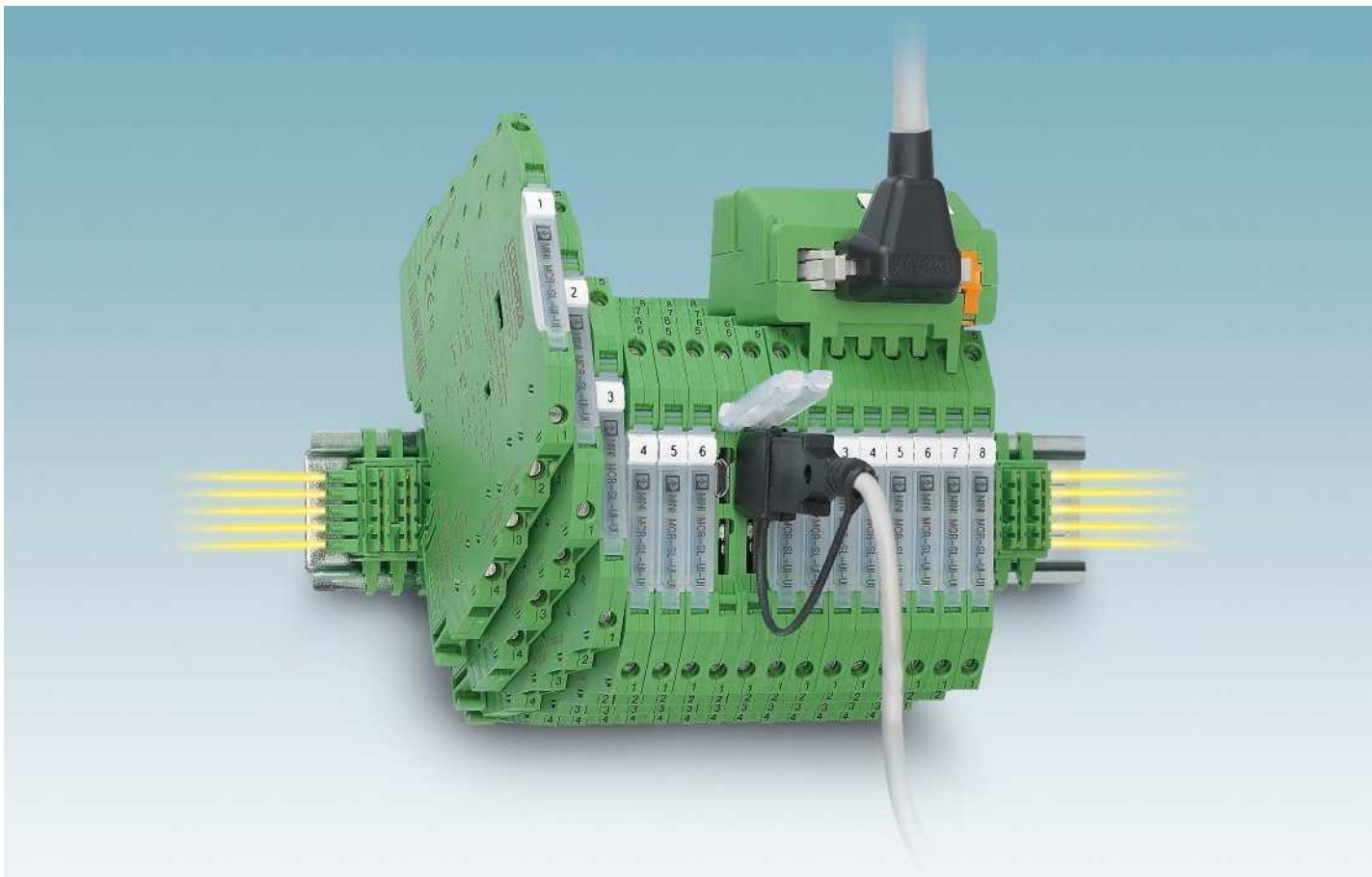

Highly compact and efficient

MINI Analog isolating amplifiers isolate, convert, filter, and amplify your analog signals – with a design width of just 6.2 mm.

The isolating amplifiers from the MINI Analog range offer the full spectrum of analog signal conditioning. They are therefore extremely efficient with regard to saving costs, space, and energy.

The comprehensive approval package means that they can be used in a variety of areas.

Choose the right MINI Analog isolating amplifier for your application:

Analog IN/OUT

- Universal and standard 3-way isolating amplifiers
- 3-way repeater power supplies
- 4-way signal duplicators
- 2-way passive isolators
- Output loop-powered isolators

Temperature

- Universal measuring transducers for resistance thermometers and thermocouples
- Active measuring transducers for Pt 100 and thermocouples
- Output loop-powered Pt 100 measuring transducers

Frequency

- Frequency transducer up to 80 kHz
- Analog frequency transducers

Potentiometer/resistor

- Potentiometer measuring transducers with automatic potentiometer detection

Limit values

- Threshold value switches with PDT relay

Digital IN

- NAMUR isolating amplifiers with relay output

Accessories

- Supply components
- Fault monitoring module
- System cabling
- Marking material
- Surge protection

Fault monitoring

Fault monitoring is a modular solution for convenient error evaluation in multi-channel applications.

Depending on the module type, the following errors can be indicated by means of a group error message:

- Overrange
- Underrange
- Open circuit
- Short circuit
- Module error

It is also possible to detect and indicate the failure of a supply voltage at the power terminal block.

The modularity is characterized by the ability to freely adjust error evaluation, both on the device side and in the evaluation module.

Fault monitoring is compatible with and can be used for the following isolating amplifier ranges:

- MINI Analog
- MACX Analog



Space savings of up to 65%

– Compared to other isolating amplifiers on the market with design widths up to 17.5 mm.

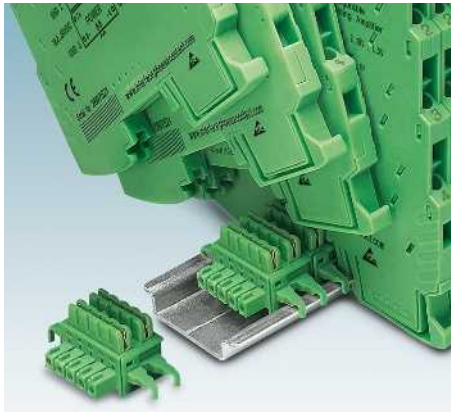

Fault monitoring and power bridging

– The DIN rail connector simplifies supply and enables group error monitoring.



Clearly arranged wiring

– Eight connections, with a choice of screw or spring-cage terminal blocks.



Low power consumption

– The resulting minimal self-heating results in a long service life and a high degree of operational reliability.



High operational reliability

– 3-way electrical isolation increases the operational reliability against system disturbances.



Easy configuration

– Can be configured easily via DIP switches or software, for extended functionality and monitoring.



Reduction in analog inputs on controllers

– The MINI Analog multiplexer reduces up to eight analog signals to a single 4 ... 20 mA signal.



Time-saving system cabling

– Plug and play – for eight channels on the isolating amplifier and controller side.



Fast and error-free signal connection

– Compact termination carriers connect MINI Analog devices to the automation system – plug and play and hot-swappable.

Analog IN / Analog OUT 3-way isolating amplifier

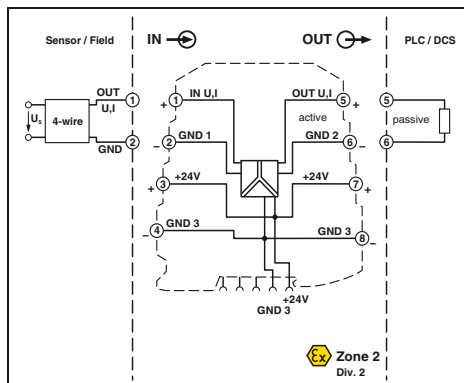

Ex n



Configurable, up to 36 signal combinations



Housing width 6.2 mm

- Highly compact isolating amplifier for electrical isolation, conversion, amplification, and filtering of standard analog signals
- Up to 36 signal combinations can be configured using DIP switches
- 3-way isolation
- Low power consumption
- Power supply possible through the foot element (T-Connector)
- Standard configuration:
0 ... 10 V input, 0 ... 20 mA output

| Notes: |
|--|
| To order a product with an order configuration, enter the required configuration by referring to the adjacent order key. |
| Information about power bridging, system cabling, and marking components can be found starting at page 88 |
| 1) EMC: Class A product, see page 571 |

| Input data |
|---|
| Input signal |
| Input resistance |
| Output data |
| Output signal |
| Maximum output signal |
| No-load voltage |
| Short-circuit current |
| Load R_B |
| Ripple |
| General data |
| Supply voltage U_B |
| Nominal supply voltage |
| Current consumption |
| Power consumption |
| Maximum transmission error |
| Temperature coefficient |
| Limit frequency (3 dB) |
| Step response (10 - 90%) |
| Electrical isolation |
| Test voltage, input/output/supply |
| Degree of protection |
| Ambient temperature (operation) |
| Mounting |
| Housing material |
| Dimensions W / H / D |
| Screw connection solid / stranded / AWG |
| Spring-cage connection (solid/stranded/AWG) |
| Conformance / approvals |
| Conformance |
| ATEX |
| UL, USA / Canada |
| GL |

| Technical data | |
|---|---|
| U input | I input |
| 0 ... 5 V / 1 ... 5 V | 0 ... 20 mA / 4 ... 20 mA |
| 0 ... 10 V / 2 ... 10 V | |
| Approx. 100 kΩ | Approx. 50 Ω |
| U output | I output |
| 0 ... 5 V / 1 ... 5 V | 0 ... 20 mA / 4 ... 20 mA |
| 0 ... 10 V / 2 ... 10 V | |
| Approx. 12.5 V | 28 mA |
| | Approx. 12.5 V |
| Approx. 22 mA | |
| ≥ 10 kΩ | < 500 Ω (at 20 mA) |
| < 20 mV _{pp} (at 10 kΩ) | < 20 mV _{pp} (at 500 Ω) |
| U output | I output |
| 19.2 V DC ... 30 V DC | |
| 24 V DC | |
| < 9 mA (Voltage output, at 24 V DC incl. load) | < 19 mA (Current output, at 24 V DC incl. load) |
| < 200 mW (Voltage output) | < 450 mW (Current output) |
| ≤ 0.1% (of final value) | |
| < 0.01%/K, typ. < 0.002%/K | |
| Approx. 100 Hz | |
| Approx. 3.2 ms | |
| Basic insulation according to EN 61010 | |
| 1.5 kV (50 Hz, 1 min.) | |
| IP20 | |
| -20°C ... 65°C | |
| Any | |
| PBT | |
| 6.2 / 93.1 / 102.5 mm | |
| 0.2 ... 2.5 mm ² / 0.2 ... 2.5 mm ² / 26 - 12 | |
| 0.2 ... 2.5 mm ² / 0.2 ... 2.5 mm ² / 24 - 12 | |
| Conformance / approvals | |
| CE-compliant | |
| Ex II 3 G Ex nA IIC T4 Gc X | |
| UL 508 Recognized | |
| Class I, Div. 2, Groups A, B, C, D T5 | |
| GL EMC 2 D | |

| Description | |
|--|-------------------|
| MCR 3-way isolating amplifier , for electrical isolation of analog signals, | |
| Order configuration | Screw connection |
| Order configuration | Spring-cage conn. |
| Standard configuration | Screw connection |
| Standard configuration | Spring-cage conn. |

| Ordering data | | |
|---------------------------------------|-----------|-------------|
| Type | Order No. | Pcs. / Pkt. |
| MINI MCR-SL-UI-UI ¹⁾ | 2864383 | 1 |
| MINI MCR-SL-UI-UI-SP ¹⁾ | 2864710 | 1 |
| MINI MCR-SL-UI-UI-NC ¹⁾ | 2864150 | 1 |
| MINI MCR-SL-UI-UI-SP-NC ¹⁾ | 2864163 | 1 |

Order key MINI MCR-SL-UI-UI (Standard configuration entered as example)

| Order No. | Input | Output | Factory calibration certificate |
|---------------------------|---|--|--|
| 2864383 | IN03 | OUT01 | NONE |
| 2864383 ≙ ...-UI-UI | IN01 ≙ 0...20 mA IN02 ≙ 4...20 mA IN03 ≙ 0...10 V | OUT01 ≙ 0...20 mA OUT02 ≙ 4...20 mA OUT03 ≙ 0...10 V | NONE ≙ Without factory YES ≙ With factory calibration certificate (fee) |
| 2864710 ≙ ...-UI-UI-SP | IN04 ≙ 2...10 V IN05 ≙ 0...5 V IN06 ≙ 1...5 V | OUT04 ≙ 2...10 V OUT05 ≙ 0...5 V OUT06 ≙ 1...5 V | YESPLUS ≙ Factory calibration certificate with 5 measuring points (fee) |

Combination table for input and output signals

| Input | Output | DIP switch SW 2 | | | | | | DIP switch SW 1 | |
|-----------|-----------|-----------------|-------|-------|-------|-------|-------|-----------------|-------|
| | | DIP 1 | DIP 2 | DIP 3 | DIP 4 | DIP 5 | DIP 6 | DIP 1 | DIP 2 |
| 0 - 10 V | 0 - 20 mA | OFF | OFF | OFF | OFF | OFF | OFF | OFF | OFF |
| | 4 - 20 mA | OFF | OFF | OFF | OFF | OFF | ON | OFF | OFF |
| | 0 - 10 V | ON | OFF | ON | OFF | OFF | OFF | OFF | OFF |
| | 2 - 10 V | ON | OFF | ON | OFF | OFF | ON | OFF | OFF |
| | 0 - 5 V | ON | ON | OFF | OFF | OFF | OFF | OFF | OFF |
| | 1 - 5 V | ON | ON | OFF | OFF | OFF | ON | OFF | OFF |
| 2 - 10 V | 0 - 20 mA | OFF | OFF | OFF | ON | ON | OFF | OFF | OFF |
| | 4 - 20 mA | OFF | OFF | OFF | OFF | OFF | OFF | OFF | OFF |
| | 0 - 10 V | ON | OFF | ON | ON | ON | OFF | OFF | OFF |
| | 2 - 10 V | ON | OFF | ON | OFF | OFF | OFF | OFF | OFF |
| | 0 - 5 V | ON | ON | OFF | ON | ON | OFF | OFF | OFF |
| | 1 - 5 V | ON | ON | OFF | OFF | OFF | OFF | OFF | OFF |
| 0 - 5 V | 0 - 20 mA | OFF | OFF | OFF | OFF | OFF | OFF | ON | OFF |
| | 4 - 20 mA | OFF | OFF | OFF | OFF | OFF | ON | ON | OFF |
| | 0 - 10 V | ON | OFF | ON | OFF | OFF | OFF | ON | OFF |
| | 2 - 10 V | ON | OFF | ON | OFF | OFF | ON | ON | OFF |
| | 0 - 5 V | ON | ON | OFF | OFF | OFF | OFF | ON | OFF |
| | 1 - 5 V | ON | ON | OFF | OFF | OFF | ON | ON | OFF |
| 1 - 5 V | 0 - 20 mA | OFF | OFF | OFF | ON | ON | OFF | ON | OFF |
| | 4 - 20 mA | OFF | OFF | OFF | OFF | OFF | OFF | ON | OFF |
| | 0 - 10 V | ON | OFF | ON | ON | ON | OFF | ON | OFF |
| | 2 - 10 V | ON | OFF | ON | OFF | OFF | OFF | ON | OFF |
| | 0 - 5 V | ON | ON | OFF | ON | ON | OFF | ON | OFF |
| | 1 - 5 V | ON | ON | OFF | OFF | OFF | OFF | ON | OFF |
| 0 - 20 mA | 0 - 20 mA | OFF | OFF | OFF | OFF | OFF | OFF | OFF | ON |
| | 4 - 20 mA | OFF | OFF | OFF | OFF | OFF | ON | OFF | ON |
| | 0 - 10 V | ON | OFF | ON | OFF | OFF | OFF | OFF | ON |
| | 2 - 10 V | ON | OFF | ON | OFF | OFF | ON | OFF | ON |
| | 0 - 5 V | ON | ON | OFF | OFF | OFF | OFF | OFF | ON |
| | 1 - 5 V | ON | ON | OFF | OFF | OFF | ON | OFF | ON |
| 4 - 20 mA | 0 - 20 mA | OFF | OFF | OFF | ON | ON | OFF | OFF | ON |
| | 4 - 20 mA | OFF | OFF | OFF | OFF | OFF | OFF | OFF | ON |
| | 0 - 10 V | ON | OFF | ON | ON | ON | OFF | OFF | ON |
| | 2 - 10 V | ON | OFF | ON | OFF | OFF | OFF | OFF | ON |
| | 0 - 5 V | ON | ON | OFF | ON | ON | OFF | OFF | ON |
| | 1 - 5 V | ON | ON | OFF | OFF | OFF | OFF | OFF | ON |

Application example: Level measurement



Analog IN / Analog OUT
3-way isolating amplifier



Ex n



Configurable, for shunt measurements



Ex: Ex

Housing width 6.2 mm

- Highly compact isolating amplifier for electrical isolation, conversion, amplification, and filtering of mV signals to create standard analog signals
- Ideal for converting signals in the case of shunt measurements
- Up to 280 signal combinations can be configured using DIP switches
- 3-way isolation
- Low power consumption
- Power supply possible through the foot element (T-Connector)
- Standard configuration:
0 ... 50 mV input, 0 ... 20 mA output

| |
|--|
| Notes: |
| To order a product with an order configuration, enter the required configuration by referring to the adjacent order key. |
| Information about power bridging, system cabling, and marking components can be found starting at page 88 |
| 1) EMC: Class A product, see page 571 |

| | |
|--------------------------------|---|
| Input data | Input signal (can be configured using DIP switches) Maximum input signal Input resistance |
| Output data | Output signal (configurable using the DIP switch) |
| General data | Maximum output signal Load R _B Ripple |
| General data | Supply voltage U _B Nominal supply voltage Power consumption Maximum transmission error Temperature coefficient Limit frequency (3 dB) Step response (10 - 90%) Electrical isolation Test voltage, input/output/supply Degree of protection Ambient temperature (operation) Mounting Housing material Dimensions W / H / D Screw connection solid / stranded / AWG Spring-cage connection (solid/stranded/AWG) |
| Conformance / approvals | Conformance ATEX UL, USA / Canada GL |

| Technical data | |
|--|---------------------------|
| 0 ... 50 mV | |
| Approx. 30 V DC | |
| Approx. 10 kΩ | |
| U output | I output |
| 0 ... 5 V / 1 ... 5 V | 0 ... 20 mA / 4 ... 20 mA |
| 0 ... 10 V / 2 ... 10 V | |
| -5 ... 5 V / -10 ... 10 V | |
| (The bi-polar output can be used only for bi-polar input signals.) | |

| | |
|----------------------------------|----------------------------------|
| 12.5 V | 28 mA |
| ≥ 10 kΩ | < 500 Ω (at 20 mA) |
| < 20 mV _{pp} (at 10 kΩ) | < 20 mV _{pp} (at 500 Ω) |

| |
|---|
| 19.2 V DC ... 30 V DC |
| 24 V DC |
| < 450 mW (Current output) |
| ≤ 0.2% |
| < 0.01%/K, typ. < 0.002%/K (100 Hz / 30 Hz switchable) |
| 3.5 ms (At 100 Hz) |
| Basic insulation according to EN 61010 |
| 1.5 kV (50 Hz, 1 min.) |
| IP20 |
| -20°C ... 65°C |
| Any |
| PBT |
| 6.2 / 93.1 / 102.5 mm |
| 0.2 ... 2.5 mm ² / 0.2 ... 2.5 mm ² / 26 - 12 |
| 0.2 ... 2.5 mm ² / 0.2 ... 2.5 mm ² / 24 - 12 |

| |
|---|
| CE-compliant |
| Ex II 3 G Ex nA IIC T4 Gc X |
| UL 508 Recognized |
| Class I, Div. 2, Groups A, B, C, D T5 applied for |
| GL EMC 2 D |

| |
|--|
| Description |
| MCR 3-way isolating amplifier , for realization of mV voltages in standard signals, Order configuration Screw connection Order configuration Spring-cage conn. Standard configuration Screw connection Standard configuration Spring-cage conn. |

| Ordering data | | |
|--|-----------|-------------|
| Type | Order No. | Pcs. / Pkt. |
| MINI MCR-SL-SHUNT-UI | 2810858 | 1 |
| MINI MCR-SL-SHUNT-UI-SP | 2810874 | 1 |
| MINI MCR-SL-SHUNT-UI-NC ¹⁾ | 2810780 | 1 |
| MINI MCR-SL-SHUNT-UI-SP-NC ¹⁾ | 2810793 | 1 |

Order key MINI MCR-SL-SHUNT-UI-... (standard configuration entered as an example)

| Order No. | Input | | | | Output | Limit frequency | Factory calibration certificate FCC |
|--------------------------|--|--|--|--|--|----------------------------|---|
| 2810858 | IN40 | | | | OUT01 | 100 | NONE |
| 2810858 ≙ ...SHUNT-UI | IN40 ≙ 0...50 mV IN24 ≙ 0...60 mV IN41 ≙ 0...75 mV IN42 ≙ 0...80 mV IN25 ≙ 0...100 mV IN43 ≙ 0...120 mV IN44 ≙ 0...150 mV IN26 ≙ 0...200 mV IN45 ≙ 0...240 mV IN27 ≙ 0...300 mV | IN28 ≙ 0...500 mV IN46 ≙ 0...600 mV IN47 ≙ 0...750 mV IN48 ≙ 0...800 mV IN29 ≙ 0...1.0 V IN49 ≙ 0...1.2 V IN50 ≙ 0...1.5 V IN30 ≙ 0...2.0 V IN51 ≙ 0...2.4 V IN52 ≙ 0...3.0 V | IN53 ≙ -50...+50 mV IN13 ≙ -60...+60 mV IN54 ≙ -75...+75 mV IN55 ≙ -80...+80 mV IN14 ≙ -100...+100 mV IN56 ≙ -120...+120 mV IN57 ≙ -150...+150 mV IN15 ≙ -200...+200 mV IN58 ≙ -240...+240 mV IN16 ≙ -300...+300 mV | IN17 ≙ -500...+500 mV IN59 ≙ -600...+600 mV IN60 ≙ -750...+750 mV IN61 ≙ -800...+800 mV IN18 ≙ -1.0...+1.0 V IN62 ≙ -1.2...+1.2 V IN63 ≙ -1.5...+1.5 V IN19 ≙ -2.0...+2.0 V IN64 ≙ -2.4...+2.4 V IN65 ≙ -3.0...+3.0 V | OUT01 ≙ 0...20 mA OUT02 ≙ 4...20 mA OUT03 ≙ 0...10 V OUT04 ≙ 2...10 V OUT05 ≙ 0...5 V OUT06 ≙ 1...5 V OUT13 ≙ -5...+5 V OUT14 ≙ -10...+10 V | 30 ≙ 30 Hz 100 ≙ 100 Hz | NONE ≙ without FCC YES ≙ with FCC (a fee is charged) YESPLUS ≙ Factory calibration certificate with 5 measuring points (a fee is charged) |

Note:
A bipolar output (-5...+5 V, -10...+10 V) can only be used for a bipolar input signal.

Combination table for input and output signals

| Input | Voltage output | | | | | | Current output | |
|---------------|----------------|----------|----------|-----------|---------|---------|----------------|-----------|
| | -10...+10 V | 0...10 V | 2...10 V | -5...+5 V | 0...5 V | 1...5 V | 0...20 mA | 4...20 mA |
| 0...50 mV | | x | | | | x | x | x |
| 0...60 mV | | x | x | | | x | x | x |
| 0...75 mV | | x | x | | | x | x | x |
| 0...80 mV | | x | x | | | x | x | x |
| 0...100 mV | | x | x | | | x | x | x |
| 0...120 mV | | x | x | | | x | x | x |
| 0...150 mV | | x | x | | | x | x | x |
| 0...200 mV | | x | x | | | x | x | x |
| 0...240 mV | | x | x | | | x | x | x |
| 0...300 mV | | x | x | | | x | x | x |
| 0...500 mV | | x | x | | | x | x | x |
| 0...600 mV | | x | x | | | x | x | x |
| 0...750 mV | | x | x | | | x | x | x |
| 0...800 mV | | x | x | | | x | x | x |
| 0...1 V | | x | x | | | x | x | x |
| 0...1.2 V | | x | x | | | x | x | x |
| 0...1.5 V | | x | x | | | x | x | x |
| 0...2 V | | x | x | | | x | x | x |
| 0...2.4 V | | x | x | | | x | x | x |
| 0...3 V | | x | x | | | x | x | x |
| -50...50 mV | x | x | x | x | x | x | x | x |
| -60...60 mV | x | x | x | x | x | x | x | x |
| -75...75 mV | x | x | x | x | x | x | x | x |
| -80...80 mV | x | x | x | x | x | x | x | x |
| -100...100 mV | x | x | x | x | x | x | x | x |
| -120...120 mV | x | x | x | x | x | x | x | x |
| -150...150 mV | x | x | x | x | x | x | x | x |
| -200...200 mV | x | x | x | x | x | x | x | x |
| -240...240 mV | x | x | x | x | x | x | x | x |
| -300...300 mV | x | x | x | x | x | x | x | x |
| -500...500 mV | x | x | x | x | x | x | x | x |
| -600...600 mV | x | x | x | x | x | x | x | x |
| -750...750 mV | x | x | x | x | x | x | x | x |
| -800...800 mV | x | x | x | x | x | x | x | x |
| -1...1 V | x | x | x | x | x | x | x | x |
| -1.2...1.2 V | x | x | x | x | x | x | x | x |
| -1.5...1.5 V | x | x | x | x | x | x | x | x |
| -2...2 V | x | x | x | x | x | x | x | x |
| -2.4...2.4 V | x | x | x | x | x | x | x | x |
| -3...3 V | x | x | x | x | x | x | x | x |

Application example: Monitoring of loading and unloading currents

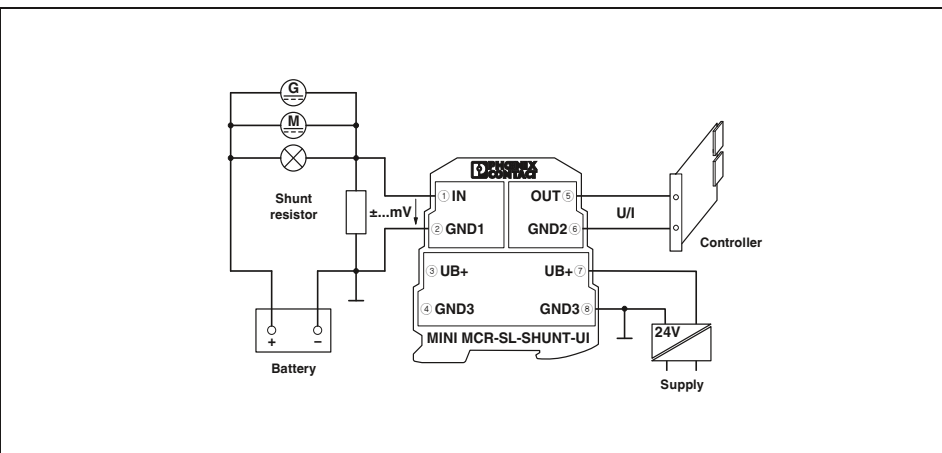

Analog IN / Analog OUT
3-way isolating amplifier

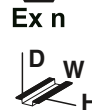
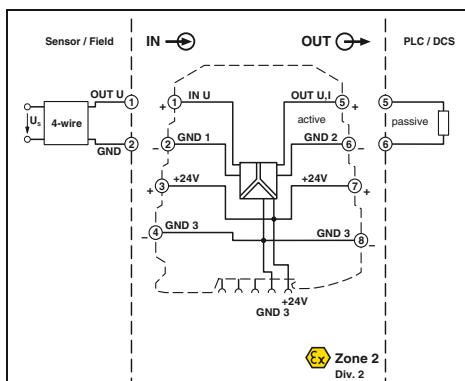
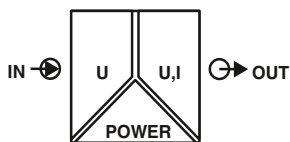

Configurable,
for 0 ... 24 V / 0 ... 30 V input signals

Housing width 6.2 mm

- Highly compact isolating amplifier for electrical isolation, conversion, amplification, and filtering of 24 V or 30 V DC signals to create standard analog signals
- Up to 12 signal combinations can be configured using DIP switches
- 3-way isolation
- Low power consumption
- Power supply possible through the foot element (T-Connector)
- Standard configuration:
0 ... 30 V input, 0 ... 20 mA output

Notes:
To order a product with an order configuration, please enter the desired configuration by referring to the order key; see below.
Information about power bridging, system cabling, and marking components can be found starting at page 88
1) EMC: Class A product, see page 571

| | |
|--------------------------------|--|
| Input data | Input signal Input resistance |
| Output data | Output signal (configurable using the DIP switch) |
| General data | Supply voltage U_B Power consumption Maximum transmission error Temperature coefficient Limit frequency (3 dB) Step response (10 - 90%) Electrical isolation Test voltage, input/output/supply Ambient temperature (operation) Housing material Dimensions W / H / D Screw connection solid / stranded / AWG Spring-cage connection (solid/stranded/AWG) |
| Conformance / approvals | Conformance ATEX UL, USA / Canada GL |

| Technical data | |
|--|---|
| 0 ... 24 V / 0 ... 30 V Approx. 125 k Ω (0 ... 24 V) | |
| U output 0 ... 5 V / 1 ... 5 V 0 ... 10 V / 2 ... 10 V ≤ 12.5 V | I output 0 ... 20 mA / 4 ... 20 mA 28 mA ≤ 12.5 V |
| ≤ 22 mA > 10 k Ω < 20 mV _{pp} (at 10 k Ω) | < 500 Ω (at 20 mA) < 20 mV _{pp} (at 500 Ω) |
| 19.2 V DC ... 30 V DC < 450 mW < 0.1% (of final value) < 0.01%/K, typ. < 0.002%/K Approx. 100 Hz Approx. 3.5 ms Basic insulation according to EN 61010 1.5 kV (50 Hz, 1 min.) -20°C ... 65°C PBT 6.2 / 93.1 / 102.5 mm 0.2 ... 2.5 mm ² / 0.2 ... 2.5 mm ² / 26 - 12 0.2 ... 2.5 mm ² / 0.2 ... 2.5 mm ² / 24 - 12 | CE-compliant Ex n II 3 G Ex nA IIC T4 Gc X UL 508 Recognized Class I, Div. 2, Groups A, B, C, D T5 GL EMC 2 D |

| Description | Type | Order No. | Pcs. / Pkt. |
|---|-------------------|--|-------------|
| MINI 3-way isolating amplifier , for electrical isolation of analog signals, | | | |
| Order configuration | Screw connection | MINI MCR-SL-U-UI¹⁾ | 2864053 |
| Order configuration | Spring-cage conn. | MINI MCR-SL-U-UI-SP¹⁾ | 2811213 |
| Standard configuration | Screw connection | MINI MCR-SL-U-UI-NC¹⁾ | 2865007 |
| Standard configuration | Spring-cage conn. | MINI MCR-SL-U-UI-SP-NC¹⁾ | 2810078 |

| Ordering data | | | |
|---|-------------------|--|-------------|
| Description | Type | Order No. | Pcs. / Pkt. |
| MINI 3-way isolating amplifier , for electrical isolation of analog signals, | | | |
| Order configuration | Screw connection | MINI MCR-SL-U-UI¹⁾ | 2864053 |
| Order configuration | Spring-cage conn. | MINI MCR-SL-U-UI-SP¹⁾ | 2811213 |
| Standard configuration | Screw connection | MINI MCR-SL-U-UI-NC¹⁾ | 2865007 |
| Standard configuration | Spring-cage conn. | MINI MCR-SL-U-UI-SP-NC¹⁾ | 2810078 |

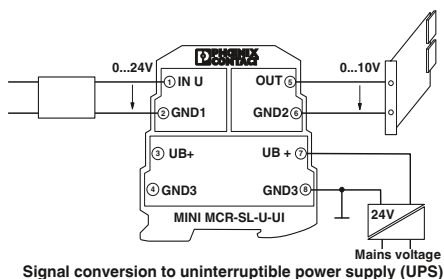

Order key MINI MCR-SL-U-UI (standard configuration entered as example)

| Order No. | Input | Output |
|-------------------------------|--|--|
| 2864053 | IN39 | OUT01 |
| 2864053 $\hat{=}$...-U-UI | IN38 $\hat{=}$ 0...24 V IN39 $\hat{=}$ 0...30 V | OUT01 $\hat{=}$ 0...20 mA OUT02 $\hat{=}$ 4...20 mA OUT03 $\hat{=}$ 0...10 V OUT04 $\hat{=}$ 2...10 V OUT05 $\hat{=}$ 0...5 V OUT06 $\hat{=}$ 1...5 V |
| 2811213 $\hat{=}$...-U-UI-SP | | |

Analog IN / Analog OUT
3-way isolating amplifier

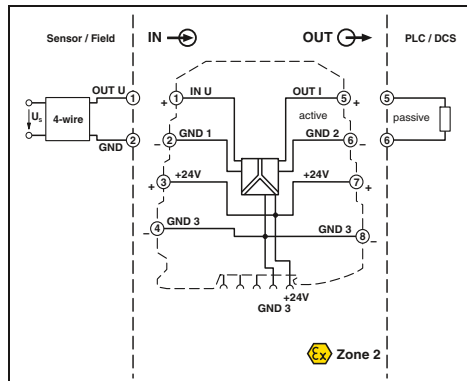
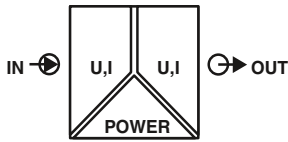

With fixed signal combinations



- Highly compact isolating amplifier for electrical isolation, conversion, amplification, and filtering of standard analog signals
- Fixed signal combinations
- Entry-level alternative to configurable isolating amplifiers
- 3-way isolation
- Low power consumption
- Power supply possible through the foot element (T-Connector)

Notes:

Information about power bridging, system cabling, and marking components can be found starting at page 88

1) EMC: Class A product, see page 571

| | | |
|---|---|----------------------------------|
| Input data | U input | I input |
| Input resistance | Approx. 100 kΩ | Approx. 50 Ω |
| Output data | U output | I output |
| Maximum output signal | 12.5 V | 28 mA |
| No-load voltage | | Approx. 12.5 V |
| Short-circuit current | Approx. 2 mA | |
| Load R _B | ≥ 10 kΩ | ≤ 500 Ω |
| Ripple | < 20 mV _{pp} (at 10 kΩ) | < 20 mV _{pp} (at 500 Ω) |
| General data | 19.2 V DC ... 30 V DC | |
| Supply voltage U _B | 24 V DC | |
| Nominal supply voltage | < 20 mA | |
| Current consumption | ≤ 0.1% (of final value) | |
| Maximum transmission error | < 0.01%/K, typ. < 0.002%/K | |
| Temperature coefficient | Approx. 100 Hz | |
| Limit frequency (3 dB) | Approx. 3.5 ms | |
| Step response (10 - 90%) | IP20 | |
| Degree of protection | Basic insulation according to EN 61010 | |
| Electrical isolation | 1.5 kV (50 Hz, 1 min.) | |
| Test voltage, input/output/supply | -20°C ... 65°C | |
| Ambient temperature (operation) | PBT | |
| Housing material | 6.2 / 93.1 / 102.5 mm | |
| Dimensions W / H / D | 0.2 ... 2.5 mm ² / 0.2 ... 2.5 mm ² / 26 - 12 | |
| Screw connection solid / stranded / AWG | 0.2 ... 2.5 mm ² / 0.2 ... 2.5 mm ² / 24 - 12 | |
| Spring-cage connection (solid/stranded/AWG) | | |
| Conformance / approvals | CE-compliant | |
| Conformance | Ex II 3 G Ex nA IIC T4 Gc X | |
| ATEX | UL 508 Recognized | |
| UL, USA / Canada | Class I, Div. 2, Groups A, B, C, D T5 applied for | |
| GL | GL EMC 2 D | |

| Technical data | | |
|---|---|--|
| U input | I input | |
| Approx. 100 kΩ | Approx. 50 Ω | |
| U output | I output | |
| 12.5 V | 28 mA | |
| Approx. 2 mA | | |
| ≥ 10 kΩ | ≤ 500 Ω | |
| < 20 mV _{pp} (at 10 kΩ) | < 20 mV _{pp} (at 500 Ω) | |
| General data | | |
| Supply voltage U _B | 19.2 V DC ... 30 V DC | |
| Nominal supply voltage | 24 V DC | |
| Current consumption | < 20 mA | |
| Maximum transmission error | ≤ 0.1% (of final value) | |
| Temperature coefficient | < 0.01%/K, typ. < 0.002%/K | |
| Limit frequency (3 dB) | Approx. 100 Hz | |
| Step response (10 - 90%) | Approx. 3.5 ms | |
| Degree of protection | IP20 | |
| Electrical isolation | Basic insulation according to EN 61010 | |
| Test voltage, input/output/supply | 1.5 kV (50 Hz, 1 min.) | |
| Ambient temperature (operation) | -20°C ... 65°C | |
| Housing material | PBT | |
| Dimensions W / H / D | 6.2 / 93.1 / 102.5 mm | |
| Screw connection solid / stranded / AWG | 0.2 ... 2.5 mm ² / 0.2 ... 2.5 mm ² / 26 - 12 | |
| Spring-cage connection (solid/stranded/AWG) | 0.2 ... 2.5 mm ² / 0.2 ... 2.5 mm ² / 24 - 12 | |
| Conformance / approvals | | |
| Conformance | CE-compliant | |
| ATEX | Ex II 3 G Ex nA IIC T4 Gc X | |
| UL, USA / Canada | UL 508 Recognized | |
| GL | Class I, Div. 2, Groups A, B, C, D T5 applied for | |
| | GL EMC 2 D | |

| Description | Input signal | Output signal |
|--|--------------|---------------|
| MCR 3-way isolating amplifier , for electrical isolation of analog signals, | | |
| Screw connection | 0 ... 10 V | 0 ... 20 mA |
| Spring-cage conn. | 0 ... 10 V | 0 ... 20 mA |
| Screw connection | 0 ... 10 V | 4 ... 20 mA |
| Spring-cage conn. | 0 ... 10 V | 4 ... 20 mA |
| Screw connection | 0 ... 20 mA | 0 ... 10 V |
| Spring-cage conn. | 0 ... 20 mA | 0 ... 10 V |
| Screw connection | 4 ... 20 mA | 0 ... 10 V |
| Spring-cage conn. | 4 ... 20 mA | 0 ... 10 V |
| Screw connection | 0 ... 20 mA | 0 ... 20 mA |
| Spring-cage conn. | 4 ... 20 mA | 4 ... 20 mA |
| Screw connection | 0 ... 10 V | 0 ... 10 V |
| Spring-cage conn. | -10 ... 10 V | -10 ... 10 V |
| Screw connection | 0 ... 10 V | 0 ... 10 V |
| Spring-cage conn. | -10 ... 10 V | -10 ... 10 V |

| Ordering data | | |
|------------------------------------|-----------|-------------|
| Type | Order No. | Pcs. / Pkt. |
| MINI MCR-SL-U-I-0 ¹⁾ | 2813512 | 1 |
| MINI MCR-SL-U-I-0-SP ¹⁾ | 2813570 | 1 |
| MINI MCR-SL-U-I-4 ¹⁾ | 2813525 | 1 |
| MINI MCR-SL-U-I-4-SP ¹⁾ | 2813583 | 1 |
| MINI MCR-SL-I-U-0 ¹⁾ | 2813541 | 1 |
| MINI MCR-SL-I-U-0-SP ¹⁾ | 2813554 | 1 |
| MINI MCR-SL-I-U-4 ¹⁾ | 2813538 | 1 |
| MINI MCR-SL-I-U-4-SP ¹⁾ | 2813567 | 1 |
| MINI MCR-SL-I-I ¹⁾ | 2864406 | 1 |
| MINI MCR-SL-I-I-SP ¹⁾ | 2864723 | 1 |
| MINI MCR-SL-U-U ¹⁾ | 2864684 | 1 |
| MINI MCR-SL-U-U-SP ¹⁾ | 2864697 | 1 |

Analog IN/Analog OUT signal duplicators

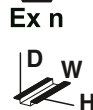
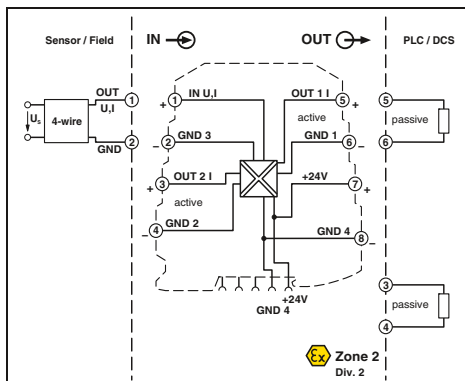
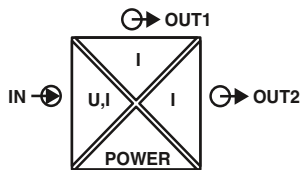

Configurable, with two current output signals

CE, RoHS, REACH
 Ex: (n) (A) (Ex)
 Housing width 6.2 mm

- Highly compact isolating amplifier for electrical isolation, conversion, amplification, filtering, and duplication of standard analog signals
- Duplication of a standard analog signal on two current outputs
- Up to 8 signal combinations can be configured using DIP switches
- 4-way isolation
- Power supply possible through the foot element (T-Connector)
- Standard configuration:
 Input: 0 ... 10 V, output 1: 0 ... 20 mA, output 2: 0 ... 20 mA

Notes:

To order a product with an order configuration, please enter the desired configuration by referring to the order key; see below.

Information about power bridging, system cabling, and marking components can be found starting at page 88

1) EMC: Class A product, see page 571

| | |
|--------------------------------|--|
| Input data | Input signal Maximum input signal Input resistance |
| Output data | Output signal (configurable using the DIP switch) Maximum output signal No-load voltage Load R_B Ripple |
| General data | Supply voltage U_B Current consumption Power consumption Maximum transmission error Temperature coefficient Limit frequency (3 dB) Step response (0 - 99%) Electrical isolation Test voltage, input/output/supply Ambient temperature (operation) Housing material Dimensions W / H / D Screw connection solid / stranded / AWG Spring-cage connection (solid/stranded/AWG) |
| Conformance / approvals | Conformance ATEX UL, USA / Canada |
| GL | GL |

| Technical data | |
|---|---------------------------|
| U input | I input |
| 0 ... 10 V / 1 ... 5 V | 0 ... 20 mA / 4 ... 20 mA |
| 30 V | 50 mA |
| Approx. 100 kΩ | Approx. 50 Ω |
| 2x ; 0 ... 20 mA / 4 ... 20 mA | |
| 22 mA | |
| 9 V | |
| ≤ 250 Ω (at 20 mA) | |
| < 20 mV _{PP} (at 250 Ω) | |
| 19.2 V DC ... 30 V DC | |
| < 30 mA (at 24 V DC incl. load) | |
| < 600 mW | |
| ≤ 0.2% (of final value), typ. < 0.1% | |
| < 0.01%/K, typ. < 0.004%/K | |
| Approx. 35 Hz | |
| Approx. 10 ms | |
| Basic insulation according to EN 61010 | |
| 1.5 kV (50 Hz, 1 min.) | |
| -20°C ... 60°C | |
| PBT | |
| 6.2 / 93.1 / 102.5 mm | |
| 0.2 ... 2.5 mm ² / 0.2 ... 2.5 mm ² / 26 - 12 | |
| 0.2 ... 2.5 mm ² / 0.2 ... 2.5 mm ² / 24 - 12 | |
| CE-compliant | |
| (Ex) II 3 G Ex nA IIC T4 Gc X | |
| UL 508 Recognized | |
| Class I, Div. 2, Groups A, B, C, D T5 | |
| GL EMC 2 D | |

| Description | Type |
|---|-------------------|
| MCR signal duplicator , for duplication and electrical isolation of analog signals | |
| Order configuration | Screw connection |
| Order configuration | Spring-cage conn. |
| Standard configuration | Screw connection |
| Standard configuration | Spring-cage conn. |

| Ordering data | | |
|---------------------------------------|-----------|-------------|
| Type | Order No. | Pcs. / Pkt. |
| MINI MCR-SL-UI-2I ¹⁾ | 2864794 | 1 |
| MINI MCR-SL-UI-2I-SP ¹⁾ | 2864804 | 1 |
| MINI MCR-SL-UI-2I-NC ¹⁾ | 2864176 | 1 |
| MINI MCR-SL-UI-2I-SP-NC ¹⁾ | 2864189 | 1 |

Order key for MINI MCR-SL-UI-2I (standard configuration entered as an example)

| Order No. | Input | Output combination ¹⁾ | Behavior of the analog outputs | Factory calibration certificate (FCC) |
|------------------------|---|----------------------------------|---------------------------------------|---|
| 2864794 | IN03 | A | 0 | NONE |
| 2864794 ≙ ...-UI-2I | IN01 ≙ 0...20 mA IN02 ≙ 4...20 mA IN03 ≙ 0...10 V IN06 ≙ 1...5 V | A B C | 0 ≙ Analog behavior 1 ≙ Limitation | NONE ≙ without FCC YES ≙ with FCC (a fee is charged) YESPLUS ≙ FCC with 5 measuring points (a fee is charged) |
| 2864804 ≙ ...-UI-2I-SP | | | | |

Explanation for output combination:

| | Output 1 | Output 2 |
|---|-----------|-----------|
| A | 0...20 mA | 0...20 mA |
| B | 0...20 mA | 4...20 mA |
| C | 4...20 mA | 4...20 mA |

¹⁾ For explanations, see adjacent text on the right; for further details, see data sheet: www.phoenixcontact.net/products

Analog IN / Analog OUT
repeater power supplies

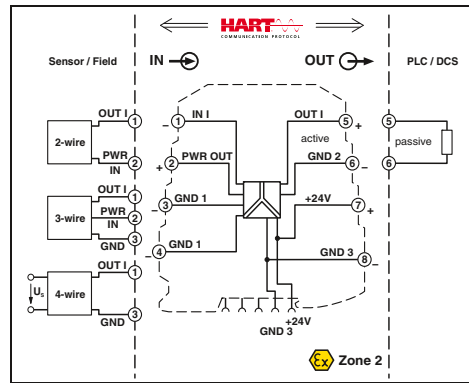

Optionally available with HART transmission



Housing width 6.2 mm

- Highly compact repeater power supplies for electrical isolation, amplification, and filtering of standard analog signals
- Supply of 2-conductor and passive 3-conductor sensors
- Can also be used as an isolator without supply
- 3-way isolation
- Alternatively bidirectional HART transmission
- Power supply possible through the foot element (T-Connector)

Notes:

Information about power bridging, system cabling, and marking components can be found starting at page 73

1) EMC: Class A product, see page 571

Input data

Input signal
Input resistance
Transmitter supply voltage

Output data

Output signal
Maximum output signal
No-load voltage
Load R_B
Ripple

General data

Supply voltage U_B
Nominal supply voltage
Current consumption
Power consumption

Maximum transmission error

Temperature coefficient
Limit frequency (3 dB)
Communication

Step response (10 - 90%)

Electrical isolation
Test voltage, input/output/supply
Degree of protection
Ambient temperature (operation)
Mounting
Housing material
Dimensions W / H / D
Screw connection solid / stranded / AWG

Spring-cage connection (solid/stranded/AWG)

Conformance / approvals

Conformance
ATEX
UL, USA / Canada

GL

Technical data

| MINI MCR-SL-RPSS-I-I1) | MINI MCR-SL-RPS-I-I1) |
|--|--|
| 0 ... 20 mA, isolator operation / 4 ... 20 mA | 0 ... 20 mA, isolator operation / 4 ... 20 mA |
| Approx. 50 Ω 16.5 V | Approx. 50 Ω 14.7 V DC ... 25.5 V DC (U_B - max. 4.5 V for load 0 mA ... 20 mA) |
| 0 ... 20 mA / 4 ... 20 mA 21 mA | 0 ... 20 mA / 4 ... 20 mA 28 mA |
| Approx. 12.5 V $\leq 500 \Omega$ (at I = 20 mA) $< 20 \text{ mV}_{\text{rms}}$ (at 500 Ω) | Approx. 12.5 V $\leq 500 \Omega$ (at I = 20 mA) $< 20 \text{ mV}_{\text{rms}}$ (at 500 Ω) |
| 20.4 V DC ... 30 V DC 24 V DC | 19.2 V DC ... 30 V DC 24 V DC |
| $< 900 \text{ mW}$ (at 24 V DC and in repeater power supply operation) | $< 900 \text{ mW}$ (at 24 V DC and in repeater power supply operation) |
| $\leq 0.2\%$ (of final value), typ. $\leq 0.1\%$ (of final value) | $\leq 0.2\%$ (of final value), typ. $\leq 0.1\%$ (of final value) |
| $< 0.005\%/K$, typ. $< 0.002\%/K$ 175 Hz (typ.) HART specification in both operating modes (RPSS isolator / RPSS repeater power supply) | $< 0.01\%/K$, typ. $< 0.002\%/K$ Approx. 100 Hz - |
| $< 2 \text{ ms}$ (typ.) Basic insulation according to EN 61010 | Approx. 3.5 ms 1.5 kV (50 Hz, 1 min.) IP20 -20°C ... 60°C |
| 1.5 kV (50 Hz, 1 min.) IP20 -20°C ... 60°C | 1.5 kV (50 Hz, 1 min.) IP20 -20°C ... 60°C |
| Any PBT 6.2 / 93.1 / 102.5 mm 0.2 ... 2.5 mm ² / 0.2 ... 2.5 mm ² / 26 - 12 | Any PBT 6.2 / 93.1 / 102.5 mm 0.2 ... 2.5 mm ² / 0.2 ... 2.5 mm ² / 24 - 12 |
| 0.2 ... 2.5 mm ² / 0.2 ... 2.5 mm ² / 24 - 12 | |
| CE-compliant Ex II 3 G Ex nA IIC T4 Gc X UL 508 Recognized applied for Class I, Div. 2, Groups A, B, C, D T5 applied for GL EMC 2 D | CE-compliant Ex II 3 G Ex nA IIC T4 Gc X UL 508 Recognized Class I, Div. 2, Groups A, B, C, D T5 GL EMC 2 D |

Ordering data

Description

MCR repeater power supplies

| | |
|---------------------|-------------------|
| with HART® protocol | Screw connection |
| with HART® protocol | Spring-cage conn. |
| | Screw connection |
| | Spring-cage conn. |

| Type | Order No. | Pcs. / Pkt. |
|---------------------------|-----------|-------------|
| MINI MCR-SL-RPSS-I-I1) | 2864079 | 1 |
| MINI MCR-SL-RPSS-I-I-SP1) | 2810230 | 1 |
| MINI MCR-SL-RPS-I-I1) | 2864422 | 1 |
| MINI MCR-SL-RPS-I-I-SP1) | 2864752 | 1 |

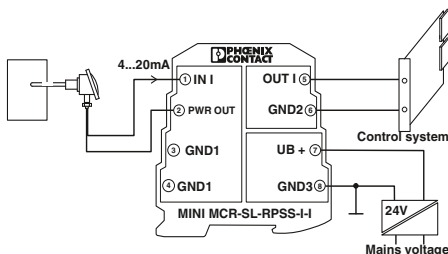

Repeater power supply operation with a passive sensor

Analog IN/Analog OUT
loop-powered isolator



Configurable,
up to 74 signal combinations,
loop-powered

Applied for:
cUL / UL
Housing width 6.2 mm

- Highly compact isolating amplifier for electrical isolation, conversion, and filtering of standard analog signals
- Supplied by an output loop
- Does not require any additional auxiliary voltage
- Up to 74 signal combinations can be configured using DIP switches
- Voltage input from mV voltages right up to 30 volts
- Current input from 2 mA right up to 40 mA
- 2-way isolation
- Standard configuration:
Input 2...10 V, output 4...20 mA

Input data
Input signal (configurable using the DIP switch)

Maximum input signal

Input resistance

Output data
Output signal
Maximum output signal
Load R_B
Ripple

General data
Supply voltage U_B
Current consumption
Power consumption
Maximum transmission error
Temperature coefficient
ZERO / SPAN adjustment
Limit frequency (3 dB)
Step response (10 - 90%)
Electrical isolation

Test voltage input/output
Degree of protection
Ambient temperature (operation)
Mounting
Housing material
Dimensions W / H / D
Screw connection solid / stranded / AWG
Spring-cage connection (solid/stranded/AWG)
Conformance / approvals
Conformance
ATEX
UL, USA / Canada

Technical data
U input
I input
2 ... 10 V, additional areas can be configured, see table

< 40 V
< 50 mA
(Dielectric strength up to 30 V)

Approx. 100 k Ω (At ≤ 1 V,
otherwise approximately 1 M Ω)
 $\leq 50 \Omega$

4 ... 20 mA
35 mA
 $((U_B - 8 \text{ V}) / 22 \text{ mA})$
< 20 mV_{PP} (at 500 Ω)

8 V DC ... 30 V DC
< 3.5 mA (without signal current)
28 mW (without signal)
< 0.1% (of final value)
0.01%/K, typ. 0.005%/K
 $\pm 2\% / \pm 2\%$
Approx. 30 Hz
Approx. 16 ms
Basic insulation according to EN 61010
1.5 kV (50 Hz, 1 min.)
IP20
-25°C ... 70°C
Any
PBT
6.2 / 93.1 / 102.5 mm
0.2 ... 2.5 mm² / 0.2 ... 2.5 mm² / 26 - 12
0.2 ... 2.5 mm² / 0.2 ... 2.5 mm² / 24 - 12

CE-compliant
Ex II 3 G Ex nA IIC T4 Gc X
UL 508 Recognized
Class I, Div. 2, Groups A, B, C, D T5

Notes:
Other input signals that have not been listed can be provided on request.
Information on components for power bridging, system cabling, and marking can be found in the INTERFACE catalog or at www.phoenixcontact.net/products
1) EMC: Class A product, see page 571

Ordering data

| Description | Type | Order No. | Pcs. / Pkt. |
|----------------------------------|---|-----------|-------------|
| MCR loop-powered isolator | | | |
| Screw connection | MINI MCR-SL-UI-I-LP-NC ¹⁾ | 2902829 | 1 |
| Spring-cage conn. | MINI MCR-SL-UI-I-LP-SP-NC ¹⁾ | 2902830 | 1 |

Possible input signal ranges (configurable via DIP switch)

| | | | | | | | |
|------------|-----------|------------|------------|-------------|------------|--------------|---------------|
| 0...40 mA | 0...30 V | 0...10 V | 2...10 V | 0...1000 mV | ± 30 V | ± 10 V | ± 1000 mV |
| 0...30 mA | 0...25 V | 0...7.5 V | | 0...750 mV | ± 25 V | ± 7.5 V | ± 750 mV |
| 0...20 mA | 4...20 mA | 0...20 V | 0...5 V | 1...5 V | 0...500 mV | ± 20 V | ± 5 V |
| 0...12 mA | | 0...15 V | 0...3 V | | 0...300 mV | ± 15 V | ± 3 V |
| 0...10 mA | 2...10 mA | 0...12.5 V | 0...2.5 V | | 0...250 mV | ± 12.5 V | ± 2.5 V |
| 0...8 mA | | 0...12 V | 0...2 V | | 0...200 mV | ± 12 V | ± 2 V |
| 0...7.5 mA | | | 0...1.5 V | | 0...150 mV | ± 1.5 V | ± 150 mV |
| 0...6 mA | | | 0...1.25 V | | 0...125 mV | ± 1.25 V | ± 125 mV |
| 0...5 mA | 1...5 mA | | 0...1.2 V | | 0...120 mV | ± 1.2 V | ± 120 mV |
| 0...4 mA | | | | | 0...100 mV | | ± 100 mV |
| 0...3 mA | | | | | 0...75 mV | | ± 75 mV |
| 0...2.5 mA | | | | | 0...60 mV | | ± 60 mV |
| 0...2 mA | | | | | 0...50 mV | | ± 50 mV |

Temperature
Temperature transducers
for resistance thermometers

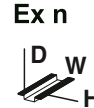
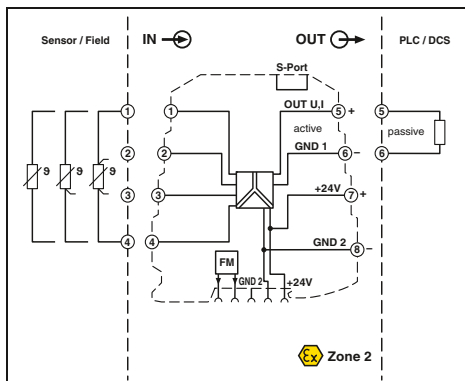
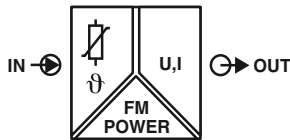

Universal measuring transducer for resistance thermometers

Housing width 6.2 mm

Technical data

| |
|---|
| Input data |
| Input signal (can be configured using DIP switches) |
| Temperature range |
| Measuring range span |
| Linear resistance measuring range |
| Output data |
| Output signal |
| Maximum output signal |
| Load R_B |
| Ripple |
| General data |
| Supply voltage U_B |
| Current consumption |
| Power consumption |
| Transmission error |
| Temperature coefficient |
| Step response (0 - 99%) |
| Electrical isolation |
| Test voltage, input/output/supply |
| Ambient temperature (operation) |
| Housing material |
| Dimensions W / H / D |
| Screw connection solid / stranded / AWG |
| Spring-cage connection (solid/stranded/AWG) |
| Conformance / approvals |
| Conformance |
| ATEX |
| UL, USA / Canada |
| GL |

| | |
|--|----------------------------------|
| Pt, Ni, Cu sensors : 2, 3, 4-conductor | |
| -200°C ... 850°C (Range depending on the sensor type) | |
| min. 50 K | |
| 0 Ω ... 4000 Ω (Minimum measuring span: 10% of the selected measuring range) | |
| U output | I output |
| 0 ... 5 V / 1 ... 5 V | 0 ... 20 mA / 4 ... 20 mA |
| 0 ... 10 V / 10 ... 0 V | 20 ... 0 mA / 20 ... 4 mA |
| Approx. 12.3 V | 24.6 mA |
| 10 kΩ | 500 Ω (at 20 mA) |
| < 20 mV _{pp} | < 20 mV _{pp} (at 500 Ω) |
| 9,6 V DC ... 30 V DC | |
| < 27 mA (at 24 V DC) | |
| ≤ 700 mW (at $I_{OUT} = 20$ mA, 9,6 V DC, load 500 Ω) | |
| 0.1% * 350 K / set measuring range; 0.1% > 350 K (Pt/Ni) 0.3% * 200 K / set measuring range; 0.3% > 200 K (Cu) | |
| 0.01%/K | |
| Typ. 200 ms (2-conductor) | |
| Typ. 500 ms (3-conductor) | |
| Typ. 500 ms (4-conductor) | |
| Basic insulation according to EN 61010 | |
| 1.5 kV (50 Hz, 1 min.) | |
| -20°C ... 65°C | |
| PBT | |
| 6.2 / 93.1 / 102.5 mm | |
| 0.2 ... 2.5 mm ² / 0.2 ... 2.5 mm ² / 26 - 12 | |
| 0.2 ... 2.5 mm ² / 0.2 ... 2.5 mm ² / 24 - 12 | |
| CE-compliant | |
| Ex II 3 G Ex nA IIC T4 Gc X | |
| UL 508 Recognized applied for Class I, Div. 2, Groups A, B, C, D T5 applied for GL applied for | |

- Universal temperature transducer for electrical isolation, conversion, amplification, and filtering of resistance thermometers and remote resistance-type sensors
- High level of accuracy over the entire measuring range
- For 2-, 3- or 4-conductor sensors according to IEC 751, JIS, GOST
- Configurable via DIP switches and software
- Software available free of charge on the Internet
- Power supply possible through the foot element (T-Connector)
- Supports fault monitoring
- Standard configuration: Pt 100 sensor IEC 751; 3-conductor; -50 ... 150°C; 4 ... 20 mA output; error evaluation according to NE43 (downscale); fault monitoring contact responds on any error

| |
|--|
| Notes: |
| The configuration software can be downloaded from the Internet: www.phoenixcontact.net/products |
| For information on the programming adapter, refer to page 119 |
| Information about power bridging, system cabling, and marking components can be found starting at page 88 |
| 1) EMC: Class A product, see page 571 |

| | |
|--|-------------------|
| Description | |
| Temperature transducers for resistance thermometers | |
| Standard configuration | Screw connection |
| Standard configuration | Spring-cage conn. |

Programming adapter for configuring modules with S-PORT interface

Ordering data

| Type | Order No. | Pcs. / Pkt. |
|-------------------------------------|-----------|-------------|
| MINI MCR-RTD-UI-NC ¹⁾ | 2902849 | 1 |
| MINI MCR-RTD-UI-SP-NC ¹⁾ | 2902850 | 1 |

Accessories

| | | |
|------------------------------------|---------|---|
| IFS-USB-PROG-ADAPTER ¹⁾ | 2811271 | 1 |
|------------------------------------|---------|---|

| Sensor type | Standard | Measuring range | Smallest measuring range span |
|-------------|---|-------------------|-------------------------------|
| Pt100 | IEC 751 = GOST 6651-2009 ($\alpha = 0.00385$) | -200°C ... +850°C | 50 K |
| Pt200 | IEC 751 = GOST 6651-2009 ($\alpha = 0.00385$) | -200°C ... +850°C | 50 K |
| Pt500 | IEC 751 = GOST 6651-2009 ($\alpha = 0.00385$) | -200°C ... +850°C | 50 K |
| Pt1000 | IEC 751 = GOST 6651-2009 ($\alpha = 0.00385$) | -200°C ... +850°C | 50 K |
| Pt100 | GOST 6651-2009 ($\alpha = 0.00391$) | -200°C ... +850°C | 50 K |
| Pt1000 | GOST 6651-2009 ($\alpha = 0.00391$) | -200°C ... +850°C | 50 K |
| Pt100 | JIS C1604-1997 | -200°C ... +850°C | 50 K |
| Pt1000 | JIS C1604-1997 | -200°C ... +850°C | 50 K |
| Ni100 | DIN 43760 | -60°C ... +250°C | 50 K |
| Ni1000 | DIN 43760 | -60°C ... +250°C | 50 K |
| Cu50 | GOST 6651-2009 ($\alpha = 1.428$) | -180°C ... +200°C | 50 K |
| Cu100 | GOST 6651-2009 ($\alpha = 1.428$) | -180°C ... +200°C | 50 K |
| Cu53 | GOST 6651-2009 ($\alpha = 1.426$) | -50°C ... +180°C | 50 K |

Temperature

Temperature transducer for Pt 100

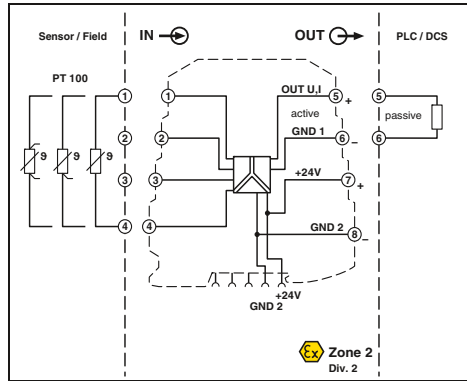

Configurable, for a temperature measuring range of -50°C ... +200°C



Housing width 6.2 mm

Technical data

| | |
|---|----------------------------------|
| Pt 100 (IEC 60751/EN 60751) : 2, 3, 4-conductor | |
| -50°C ... 200°C (configurable) | |
| min. 50 K | |
| U output | I output |
| 0 ... 5 V / 1 ... 5 V | 0 ... 20 mA / 4 ... 20 mA |
| 0 ... 10 V / 10 ... 0 V | 20 ... 0 mA / 20 ... 4 mA |
| Approx. 12.5 V | 23 mA |
| > 10 kΩ | < 500 Ω (at 20 mA) |
| < 20 mV _{pp} (at 10 kΩ) | < 20 mV _{pp} (at 500 Ω) |

| |
|---|
| 19.2 V DC ... 30 V DC |
| < 21 mA (at 24 V DC) |
| < 500 mW |
| ≤ 0.25% ; ((50 K / Δ Temp) + 0.05)% |
| < 0.02%/K |
| < 200 ms |
| Basic insulation according to EN 61010 |
| 1.5 kV (50 Hz, 1 min.) |
| -20°C ... 65°C |
| PBT |
| 6.2 / 93.1 / 102.5 mm |
| 0.2 ... 2.5 mm ² / 0.2 ... 2.5 mm ² / 26 - 12 |
| 0.2 ... 2.5 mm ² / 0.2 ... 2.5 mm ² / 24 - 12 |

CE-compliant
 Ex II 3 G Ex nA IIC T4 Gc X
 UL 508 Recognized
 Class I, Div. 2, Groups A, B, C, D T5
 GL EMC 2 D

Ordering data

| Type | Order No. | Pcs. / Pkt. |
|--|-----------|-------------|
| MINI MCR-SL-PT100-UI-200 | 2864309 | 1 |
| MINI MCR-SL-PT100-UI-200-SP ¹⁾ | 2864192 | 1 |
| MINI MCR-SL-PT100-UI-200-NC ¹⁾ | 2864370 | 1 |
| MINI MCR-SL-PT100-UI-200-SP-NC ¹⁾ | 2864202 | 1 |

- Highly compact temperature transducer for electrical isolation, conversion, amplification, and filtering of Pt 100 signals to create standard signals
- Optimized temperature measuring range of -50°C to +200°C for increased accuracy
- For 2-, 3- or 4-conductor Pt 100 sensors according to IEC 60751
- Input and output signals can be configured via DIP switches
- 3-way isolation
- Error signaling via diagnostic LED and analog signal
- Power supply possible through the foot element (T-Connector)

Notes:

To order a product with an order configuration, please enter the desired configuration by referring to the order key; see below.

Information about power bridging, system cabling, and marking components can be found starting at page 88

1) EMC: Class A product, see page 571

Input data

Input signal (can be configured using DIP switches)
 Temperature range
 Measuring range span

Output data

Output signal

Maximum output signal
 Load R_B
 Ripple

General data

Supply voltage U_B
 Current consumption
 Power consumption
 Transmission error for the full/set measurement range
 Temperature coefficient
 Step response (0 - 99%)
 Electrical isolation
 Test voltage, input/output/supply
 Ambient temperature (operation)
 Housing material
 Dimensions W / H / D
 Screw connection solid / stranded / AWG
 Spring-cage connection (solid/stranded/AWG)

Conformance / approvals

Conformance
 ATEX
 UL, USA / Canada

GL

Description

MCR temperature measuring transducer, for Pt 100 temperature sensors

| | |
|---------------------|-------------------|
| Order configuration | Screw connection |
| Order configuration | Spring-cage conn. |
| Unconfigured | Screw connection |
| Unconfigured | Spring-cage conn. |

Order key for MINI MCR-SL-PT100-UI-200 (standard configuration entered as an example)

| Order No. | Connection technology | Measuring range [°C] | | Output | Failure information ¹⁾ | Factory calibration certificate (FCC) |
|----------------------------------|------------------------------------|--------------------------|---------------------------------------|--|-----------------------------------|--|
| | | Start | End | | | |
| 2864309 | 3 | 0 | 100 | OUT01 | A | NONE |
| 2864309 ≙ ...-PT100-UI-200 | 2 ≙ 2-conductor 3 ≙ 3-conductor | 0 -5 -10 -15 | Range (increment) 0...200 (5 K) | OUT01 ≙ 0...20 mA OUT02 ≙ 4...20 mA OUT03 ≙ 0...10 V OUT05 ≙ 0...5 V OUT06 ≙ 1...5 V OUT07 ≙ 20...0 mA OUT08 ≙ 20...4 mA OUT09 ≙ 10...0 V | A B C D | NONE ≙ without FCC YES ≙ with FCC (a fee is charged) |
| 2864192 ≙ ...-PT100-UI-200-SP | 4 ≙ 4-conductor | -20 -30 -40 -50 | | | | YESPLUS ≙ FCC with 5 measuring points (a fee is charged) |

Failure information (depends on the output signal range):

| | Overrange | | | Open circuit | | |
|---|-----------|-----------|----------|--------------|-----------|----------|
| | 0...20 mA | 4...20 mA | 0...10 V | 0...20 mA | 4...20 mA | 0...10 V |
| A | 20.5 mA | 20.5 mA | 10.25 V | 21 mA | 21 mA | 10.5 V |
| B | 20.5 mA | 20.5 mA | 10.25 V | 21 mA | 21 mA | 10.5 V |
| C | 20 mA | 20 mA | 10 V | 21 mA | 21 mA | 10.5 V |
| D | 20 mA | 20 mA | 10 V | 0 mA | 4 mA | 0 V |

| | Underrange | | | Short circuit | | |
|---|------------|-----------|----------|---------------|-----------|----------|
| | 0...20 mA | 4...20 mA | 0...10 V | 0...20 mA | 4...20 mA | 0...10 V |
| A | 0 mA | 4 mA | 0 V | 0 mA | 4 mA | 0 V |
| B | 0 mA | 3.5 mA | 0 V | 0 mA | 3 mA | 0 V |
| C | 0 mA | 4 mA | 0 V | 21 mA | 21 mA | 10.5 V |
| D | 0 mA | 4 mA | 0 V | 0 mA | 4 mA | 0 V |

¹⁾ For explanations, see adjacent text on the right; for further details, see data sheet: www.phoenixcontact.net/products

Temperature

Temperature transducer for Pt 100

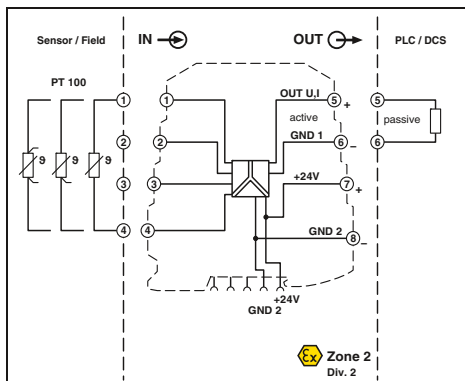
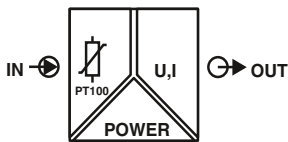

Ex n



Configurable, for a temperature measuring range of -150°C ... +850°C



Housing width 6.2 mm

- Highly compact temperature transducer for electrical isolation, conversion, amplification, and filtering of Pt 100 signals to create standard signals
- Temperature measuring range of -150°C to +850°C
- For 2-, 3- or 4-conductor Pt 100 sensors according to IEC 60751
- Input and output signals can be configured via DIP switches
- 3-way isolation
- Error signaling via diagnostic LED and analog signal
- Power supply possible through the foot element (T-Connector)

Notes:
 To order a product with an order configuration, please enter the desired configuration by referring to the order key; see below.
 Information about power bridging, system cabling, and marking components can be found starting at page 88
 1) EMC: Class A product, see page 571

| | |
|--------------------------------|--|
| Input data | Input signal (can be configured using DIP switches) Temperature range Measuring range span |
| Output data | Output signal (configurable using the DIP switch) |
| General data | Maximum output signal Load R _B Ripple Supply voltage U _B Current consumption Power consumption Transmission error for the full/set measurement range |
| Temperature coefficient | Temperature coefficient Step response (0 - 99%) Electrical isolation Test voltage, input/output/supply Ambient temperature (operation) Housing material Dimensions W / H / D Screw connection solid / stranded / AWG Spring-cage connection (solid/stranded/AWG) |
| Conformance / approvals | Conformance / approvals ATEX UL, USA / Canada GL |

| | |
|---|----------------------------------|
| Technical data | |
| Pt 100 (IEC 60751/EN 60751) : 2, 3, 4-conductor -150°C ... 850°C (configurable) min. 50 K | |
| U output | I output |
| 0 ... 5 V / 1 ... 5 V | 0 ... 20 mA / 4 ... 20 mA |
| 0 ... 10 V / 10 ... 0 V | 20 ... 0 mA / 20 ... 4 mA |
| Approx. 12.5 V | 23 mA |
| ≥ 10 kΩ | < 500 Ω (at 20 mA) |
| < 20 mV _{pp} (at 10 kΩ) | < 20 mV _{pp} (at 500 Ω) |
| 19.2 V DC ... 30 V DC < 21 mA (at 24 V DC) < 500 mW ≤ 0.2% ; ((100 K / set measurement range [K]) + 0.1%) | |
| < 0.02%/K < 160 ms Basic insulation according to EN 61010 1.5 kV (50 Hz, 1 min.) -20°C ... 65°C PBT 6.2 / 93.1 / 102.5 mm 0.2 ... 2.5 mm ² / 0.2 ... 2.5 mm ² / 26 - 12 0.2 ... 2.5 mm ² / 0.2 ... 2.5 mm ² / 24 - 12 | |
| CE-compliant Ex II 3 G Ex nA IIC T4 Gc X UL 508 Recognized Class I, Div. 2, Groups A, B, C, D T5 GL EMC 2 D | |

| | |
|--|-------------------|
| Description | |
| MINI MCR temperature measuring transducer, for Pt 100 temperature sensors | |
| Order configuration | Screw connection |
| Order configuration | Spring-cage conn. |
| Unconfigured | Screw connection |
| Unconfigured | Spring-cage conn. |

| | | |
|--|------------------|--------------------|
| Ordering data | | |
| Type | Order No. | Pcs. / Pkt. |
| MINI MCR-SL-PT100-UI ¹⁾ | 2864435 | 1 |
| MINI MCR-SL-PT100-UI-SP | 2864736 | 1 |
| MINI MCR-SL-PT100-UI-NC ¹⁾ | 2864273 | 1 |
| MINI MCR-SL-PT100-UI-SP-NC ¹⁾ | 2864286 | 1 |

Order key for MINI MCR-SL-PT100-UI (standard configuration entered as an example)

| Order No. | Connection technology | Measuring range [°C] Start End | Output | Failure information ¹⁾ | Factory calibration certificate (FCC) |
|-----------------------------|------------------------------------|--|---|-----------------------------------|--|
| 2864435 | 3 | 0 100 | OUT01 | A | NONE |
| 2864435 ≙ ...PT100-UI | 2 ≙ 2-conductor 3 ≙ 3-conductor | 0 -10 -20 -30 0...100 (5 K) | OUT01 ≙ 0...20 mA OUT02 ≙ 4...20 mA OUT03 ≙ 0...10 V OUT05 ≙ 0...5 V | A B C D | NONE ≙ without FCC YES ≙ with FCC (a fee is charged) |
| 2864736 ≙ ...PT100-UI-SP | 4 ≙ 4-conductor | -40 -50 -100 -150 110...300 (10 K) 320...700 (20 K) 750...850 (50 K) | OUT06 ≙ 1...5 V OUT07 ≙ 20...0 mA OUT08 ≙ 20...4 mA OUT09 ≙ 10...0 V | | YESPLUS ≙ FCC with 5 measuring points (a fee is charged) |

| | | | | | | |
|---|-----------|----------|----------------------|-----------|----------|--|
| Failure information (depends on the output signal range): | | | | | | |
| Overrange | | | Open circuit | | | |
| 0...20 mA | 4...20 mA | 0...10 V | 0...20 mA | 4...20 mA | 0...10 V | |
| A 20.5 mA | 20.5 mA | 10.25 V | 21 mA | 21 mA | 10.5 V | |
| B 20.5 mA | 20.5 mA | 10.25 V | 21 mA | 21 mA | 10.5 V | |
| C 20 mA | 20 mA | 10 V | 21 mA | 21 mA | 10.5 V | |
| D 20 mA | 20 mA | 10 V | 0 mA | 4 mA | 0 V | |
| Underrange | | | Short circuit | | | |
| 0...20 mA | 4...20 mA | 0...10 V | 0...20 mA | 4...20 mA | 0...10 V | |
| A 0 mA | 4 mA | 0 V | 0 mA | 4 mA | 0 V | |
| B 0 mA | 3.5 mA | 0 V | 0 mA | 3 mA | 0 V | |
| C 0 mA | 4 mA | 0 V | 21 mA | 21 mA | 10.5 V | |
| D 0 mA | 4 mA | 0 V | 0 mA | 4 mA | 0 V | |

¹⁾ For explanations, see adjacent text on the right; for further details, see data sheet: www.phoenixcontact.net/products

Temperature
Temperature transducer for Pt 100

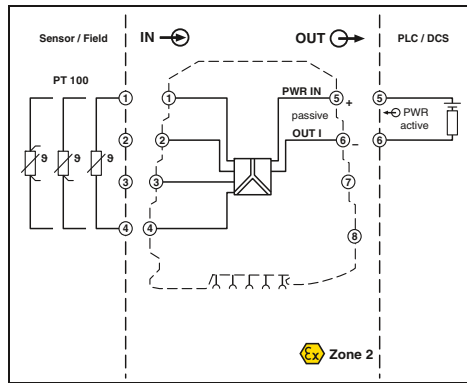
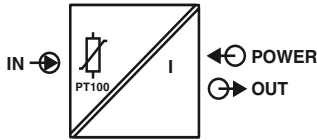

Configurable, for a temperature measuring range of -150°C ... +300°C, loop-powered



Housing width 6.2 mm

Technical data

Pt 100 (IEC 60751/EN 60751) : 2, 3, 4-conductor
-150°C ... 300°C (configurable)
min. 50 K

4 ... 20 mA / 20 ... 4 mA
23 mA
((U_{supply} - 12 V) / 22 mA)
< 20 mV_{pp} (at 500 Ω)

12 V DC ... 30 V DC
< 3.5 mA (without signal current)
< 42 mW (without signal current)
≤ 0.25% ; ((90 K / set measuring range [K]) + 0.05%)

< 0.02%/K
< 200 ms
Basic insulation according to EN 61010
1.5 kV (50 Hz, 1 min.)
IP20
-20°C ... 65°C
Any
PBT
6.2 / 93.1 / 102.5 mm
0.2 ... 2.5 mm² / 0.2 ... 2.5 mm² / 26 - 12
0.2 ... 2.5 mm² / 0.2 ... 2.5 mm² / 24 - 12

CE-compliant
Ex II 3 G Ex nA IIC T4 Gc X
UL 508 Recognized
Class I, Div. 2, Groups A, B, C, D T5 applied for

Ordering data

Input data
Input signal (can be configured using DIP switches)
Temperature range
Measuring range span

Output data
Output signal
Maximum output signal
Load R_B
Ripple

General data
Supply voltage U_B
Current consumption
Power consumption
Transmission error for the full/set measurement range

Temperature coefficient
Step response (0 - 99%)
Electrical isolation
Test voltage, input/output/supply
Degree of protection
Ambient temperature (operation)
Mounting
Housing material
Dimensions W / H / D
Screw connection solid / stranded / AWG
Spring-cage connection (solid/stranded/AWG)

Conformance / approvals
Conformance
ATEX
UL, USA / Canada

- Highly compact loop-powered temperature transducer for electrical isolation, conversion, amplification, and filtering of Pt 100 signals to create standard signals
- Supplied by an output loop
- Does not require any additional auxiliary voltage
- Temperature measuring range of -150°C to +300°C
- 2-, 3- or 4-conductor Pt 100 sensors
- Input signals can be configured via DIP switches
- 2-way isolation
- Error signaling via diagnostic LED and analog signal

Notes:
To order a product with an order configuration, please enter the desired configuration by referring to the order key; see below.
Information about power bridging, system cabling, and marking components can be found starting at page 88
1) EMC: Class A product, see page 571

| Description | Type | Order No. | Pcs. / Pkt. |
|--|--|----------------|-------------|
| MCR temperature measuring transducer , for Pt 100 temperature sensors, loop-powered | | | |
| Order configuration Screw connection | MINI MCR-SL-PT100-LP | 2810298 | 1 |
| Order configuration Spring-cage conn. | MINI MCR-SL-PT100-LP-SP | 2810382 | 1 |
| Unconfigured Screw connection | MINI MCR-SL-PT100-LP-NC¹⁾ | 2810308 | 1 |
| Unconfigured Spring-cage conn. | MINI MCR-SL-PT100-LP-NC-SP¹⁾ | 2810395 | 1 |

Order key for MINI MCR-SL-PT100-LP (standard configuration entered as an example)

| Order No. | Connection technology | Measuring range [°C] Start End | Output | Failure information ¹⁾ | Factory calibration certificate (FCC) |
|------------------------------|------------------------------------|--|---|-----------------------------------|--|
| 2810298 | 3 | 0 100 | OUT02 | 1 | NONE |
| 2810298 ≙ ...-PT100-LP | 2 ≙ 2-conductor 3 ≙ 3-conductor | 0 -10 -20 -30 -40 -50 -100 -150 | Range (increment) OUT02 ≙ 4...20 mA OUT08 ≙ 20...4 mA | 1 2 3 4 | NONE ≙ without FCC YES ≙ with FCC (a fee is charged) |
| 2810382 ≙ ...-PT100-LP-SP | 4 ≙ 4-conductor | 0...300 (5 K) | | | YESPLUS ≙ FCC with 5 measuring points (a fee is charged) |

| | Failure information | |
|---|---------------------|----------------|
| | Overrange | Open circuit |
| 1 | - | Start of range |
| 2 | 21.5 mA | 21.5 mA |
| 3 | 3.5 mA | 3.5 mA |
| 4 | 21.5 mA | 21.5 mA |
| | Failure information | |
| | Underrange | Short circuit |
| 1 | - | Start of range |
| 2 | 21.5 mA | 21.5 mA |
| 3 | 3.5 mA | 3.5 mA |
| 4 | 3.5 mA | 3.5 mA |

¹⁾ For explanations, see adjacent text on the right; for further details, see data sheet: www.phoenixcontact.net/products

Temperature
Temperature transducers for
thermocouples

N

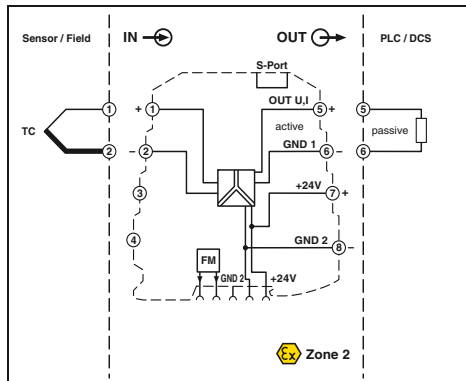
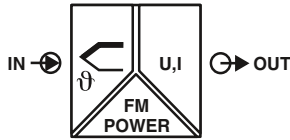

Universal measuring transducer for thermocouples

Housing width 6.2 mm

Highly compact temperature transducer for electrical isolation, conversion, amplification, and filtering of thermocouple signals.

- For thermocouples according to IEC 584 and GOST
- Internal cold junction compensation
- Configurable via DIP switches and software
- Software available free of charge on the Internet
- Power supply possible through the foot element (T-Connector)
- Supports fault monitoring
- Standard configuration: TC sensor type J IEC 584 TC; cold junction compensation "ON"; -200 ... 1200°C; 4 ... 20 mA output; error evaluation according to NE43 (downscale); fault monitoring contact responds on any error.

| Notes: |
|--|
| For information on the programming adapter, refer to page 119 |
| The configuration software can be downloaded from the Internet: www.phoenixcontact.net/products |
| Information about power bridging, system cabling, and marking components can be found starting at page 88 |
| 1) EMC: Class A product, see page 571 |

| Input data |
|---|
| Input signal (can be configured using DIP switches) |
| Temperature range |
| Measuring range span |
| Output data |
| Output signal (configurable using the DIP switch) |
| Maximum output signal |
| No-load voltage |
| Short-circuit current |
| Load R_B |
| Ripple |
| General data |
| Supply voltage U_B |
| Current consumption |
| Power consumption |
| Transmission error |
| Cold junction errors |
| Temperature coefficient |
| Step response (0 - 99%) |
| Electrical isolation |
| Test voltage, input/output/supply |
| Ambient temperature (operation) |
| Housing material |
| Dimensions W / H / D |
| Screw connection solid / stranded / AWG |
| Conformance / approvals |
| Conformance |
| ATEX |
| UL, USA / Canada |
| GL |

| Technical data | |
|--|---|
| B, E, J, K, N, R, S, T, L, U, A-1, A-2, A-3, M, L | |
| -250°C ... 2500°C (Range depending on the sensor type) | |
| min. 50 K | |
| U output | I output |
| 0 ... 5 V / 1 ... 5 V | 0 ... 20 mA / 4 ... 20 mA |
| 0 ... 10 V / 10 ... 0 V | 20 ... 0 mA / 20 ... 4 mA |
| Approx. 12.3 V | 24.6 mA |
| $\geq 10 \text{ k}\Omega$ | $< 500 \Omega$ (at 20 mA) |
| $< 20 \text{ mV}_{PP}$ | $< 20 \text{ mV}_{PP}$ (at 500 Ω) |
| 9.6 V DC ... 30 V DC | |
| $< 27 \text{ mA}$ (at 24 V DC) | |
| $\leq 700 \text{ mW}$ (at $I_{OUT} = 20 \text{ mA}$, 9.6 V DC, load 500 Ω) | |
| 0.1% * 600 K / set measuring range; 0.1% > 600 K (E, J, K, N, T, L, U, M, Gost, L Gost) 0.2% * 600 K / set measuring range; 0.2% > 600 K (B, R, S, A1, A2, A3) | |
| $< 3 \text{ K}$ (typ. $< 2 \text{ K}$) | |
| $\leq 0.01\%/K$ | |
| Typ. 400 ms | |
| Basic insulation according to EN 61010 | |
| 1.5 kV (50 Hz, 1 min.) | |
| -20°C ... 65°C | |
| PBT | |
| 6.2 / 93.1 / 102.5 mm | |
| 0.2 ... 2.5 mm ² / 0.2 ... 2.5 mm ² / 26 - 12 | |
| CE-compliant | |
| Ex II 3 G Ex nA IIC T4 Gc X | |
| UL 508 Recognized applied for Class I, Div. 2, Groups A, B, C, D T5 applied for GL applied for | |

| Description |
|--|
| Universal temperature transducer for thermocouples |
| Standard configuration Screw connection |
| Programming adapter for configuring modules with S-PORT interface |

| Ordering data | | |
|------------------------------------|-----------|-------------|
| Type | Order No. | Pcs. / Pkt. |
| MINI MCR-TC-UI-NC ¹⁾ | 2902851 | 1 |
| Accessories | | |
| IFS-USB-PROG-ADAPTER ¹⁾ | 2811271 | 1 |

| Sensor type | Standard | Measuring range |
|-------------|-----------|--------------------|
| B | IEC 584-1 | +500°C ... +1820°C |
| E | IEC 584-1 | -230°C ... +1000°C |
| J | IEC 584-1 | -210°C ... +1200°C |
| K | IEC 584-1 | -250°C ... +1372°C |
| N | IEC 584-1 | -200°C ... +1300°C |
| R | IEC 584-1 | -50°C ... +1768°C |
| S | IEC 584-1 | -50°C ... +1768°C |
| T | IEC 584-1 | -200°C ... +400°C |

| Sensor type | Standard | Measuring range |
|---|------------|-------------------|
| L | DIN 43710 | -200°C ... +900°C |
| U | DIN 43710 | -200°C ... +600°C |
| A-1 | GOST 8.585 | 0°C ... +2500°C |
| A-2 | GOST 8.585 | 0°C ... +1800°C |
| A-3 | GOST 8.585 | 0°C ... +1800°C |
| M | GOST 8.585 | -200°C ... +100°C |
| L | GOST 8.585 | -200°C ... +800°C |
| Customer-specific characteristic curves | | |

Temperature
Temperature transducer for
J- and K-type thermocouples



Configurable, for a temperature measuring range of -150°C ... +1350°C



Housing width 6.2 mm

- Highly compact temperature transducer for electrical isolation, conversion, amplification, and filtering of thermocouple signals to create standard signals
- Temperature measuring range of -150°C to +1350°C
- For J and K thermocouples according to IEC 584-1
- Internal cold junction compensation
- Input and output signals can be configured via DIP switches
- 3-way isolation
- Error signaling via diagnostic LED and analog signal
- Power supply possible through the foot element (T-Connector)

Notes:
 To order a product with an order configuration, please enter the desired configuration by referring to the order key; see below.
 Information about power bridging, system cabling, and marking components can be found starting at page 88
 1) EMC: Class A product, see page 571

| | |
|--|--|
| Input data | Input signal (can be configured using DIP switches) |
| Temperature range | |
| Measuring range span | |
| Output data | Output signal (configurable using the DIP switch) |
| Maximum output signal | No-load voltage Short-circuit current Load R _B Ripple |
| General data | Supply voltage U _B Current consumption Power consumption Transmission error for the full/set measurement range |
| Cold junction errors | Temperature coefficient Step response (0 - 99%) Electrical isolation |
| Test voltage, input/output/supply | Ambient temperature (operation) Housing material Dimensions W / H / D Screw connection solid / stranded / AWG |
| Conformance / approvals | Conformance ATEX UL, USA / Canada |
| GL | |

| Technical data | |
|---|---|
| Thermocouples type J, K (IEC 584-1) | |
| Typ J: -150°C ... 1200°C (configurable) Typ K: -150°C ... 1350°C min. 50 K | |
| U output | I output |
| 0 ... 5 V / 1 ... 5 V 0 ... 10 V / 10 ... 0 V Approx. 12.5 V | 0 ... 20 mA / 4 ... 20 mA 20 ... 0 mA / 20 ... 4 mA 23 mA Approx. 12.5 V |
| Approx. 10 mA ≥ 10 kΩ < 20 mV _{pp} (at 10 kΩ) | < 500 Ω (at 20 mA) < 20 mV _{pp} (at 500 Ω) |
| 19.2 V DC ... 30 V DC < 25 mA (at 24 V DC) < 500 mW ≤ 0.2% ; ((150 K / set measurement range [K]) + 0.1%) | |
| < 3 K (typ. < 2 K) < 0.02%/K < 30 ms Basic insulation according to EN 61010 1.5 kV (50 Hz, 1 min.) -20°C ... 65°C PBT 6.2 / 93.1 / 102.5 mm 0.2 ... 2.5 mm ² / 0.2 ... 2.5 mm ² / 26 - 12 | |
| CE-compliant Ex II 3 G Ex nA IIC T4 Gc X UL 508 Recognized Class I, Div. 2, Groups A, B, C, D T5 GL EMC 2 D | |

| | | |
|----------------------------|--|--|
| Description | MCR temperature measuring transducer, for thermocouples | |
| Order configuration | Screw connection | MINI MCR-SL-TC-UI¹⁾ |
| Unconfigured | Screw connection | MINI MCR-SL-TC-UI-NC¹⁾ |

| Ordering data | | |
|--|------------------|--------------------|
| Type | Order No. | Pcs. / Pkt. |
| MINI MCR-SL-TC-UI¹⁾ | 2864448 | 1 |
| MINI MCR-SL-TC-UI-NC¹⁾ | 2864299 | 1 |

Order key for MINI MCR-SL-TC-UI (standard configuration entered as an example)

| Order No. | Sensor type | Measuring range [°C] | Output | Failure information ¹⁾ | Factory calibration certificate (FCC) |
|----------------|-------------|----------------------|--------------------|-----------------------------------|--|
| 2864448 | J | 0 | 1000 | OUT01 | NONE |
| | J ≙ Type J | 0 | Range (increment) | OUT01 ≙ 0...20 mA | NONE ≙ without FCC |
| | K ≙ Type K | -10 | | OUT02 ≙ 4...20 mA | YES ≙ with FCC (a fee is charged) |
| | | -20 | | OUT03 ≙ 0...10 V | |
| | | -30 | | OUT04 ≙ 0...5 V | |
| | | -40 | 0 ... 300 (10 K) | OUT05 ≙ 1...5 V | YESPLUS ≙ FCC with 5 measuring points (a fee is charged) |
| | | -50 | 320 ... 700 (20 K) | OUT06 ≙ 20...0 mA | |
| | | -100 | 750...1350 (50 K) | OUT07 ≙ 20...4 mA | |
| | | -150 | | OUT08 ≙ 10...0 V | |
| | | | | OUT09 ≙ 10...0 V | |

| | | | | | |
|---|-----------|---------------------|-----------|-----------|----------|
| Failure information (depends on the output signal range): | | | | | |
| Overrange | | Open circuit | | | |
| 0...20 mA | 4...20 mA | 0...10 V | 0...20 mA | 4...20 mA | 0...10 V |
| A 20.5 mA | 20.5 mA | 10.25 V | 21 mA | 21 mA | 10.5 V |
| B 20.5 mA | 20.5 mA | 10.25 V | 21 mA | 21 mA | 10.5 V |
| C 20 mA | 20 mA | 10 V | 21 mA | 21 mA | 10.5 V |
| D 20 mA | 20 mA | 10 V | 0 mA | 4 mA | 0 V |
| Underrange | | | | | |
| 0...20 mA | 4...20 mA | 0...10 V | | | |
| A 0 mA | 4 mA | 0 V | | | |
| B 0 mA | 3.5 mA | 0 V | | | |
| C 0 mA | 4 mA | 0 V | | | |
| D 0 mA | 4 mA | 0 V | | | |

¹⁾ For explanations, see adjacent text on the right; for further details, see data sheet: www.phoenixcontact.net/products

Frequency
Frequency transducers
For up to 80 kHz

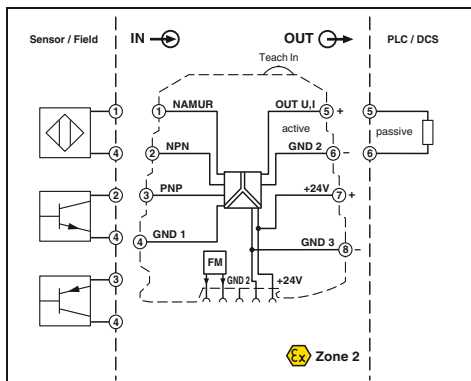
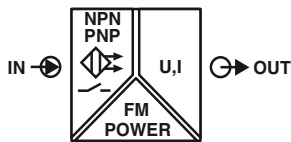

Ex n



Frequency transducer for up to 80 kHz

Configurable 3-way isolated frequency transducer.

- Suitable for the connection of NAMUR proximity sensors (IEC 60947-5-6 and EN 50227) as well as for sensors with NPN and PNP outputs that generate a frequency signal
- The device is configured via DIP switches
- Frequency range is freely adjustable via a press/slide button ("teach-in wheel")
- Supports fault monitoring
- Standard configuration: NAMUR sensor; mean-value generation "OFF"; 0.002 Hz ... 20 kHz frequency range; 4 ... 20 mA output; error evaluation NE43 (downscale); fault monitoring contact responds on any error

Notes:

Information about power bridging, system cabling, and marking components can be found starting at page 88

1) EMC: Class A product, see page 571

| | |
|---|---|
| Input data | Input sources |
| Frequency measuring range | |
| Maximum input signal | |
| Output data | Output signal |
| Maximum output signal | |
| Load R_B | |
| Ripple | |
| General data | Supply voltage U_B Power consumption |
| Transmission error of the full measuring span | |
| Temperature coefficient | |
| Step response (0 - 99%) | |
| Electrical isolation | |
| Test voltage, input/output/supply | |
| Degree of protection | |
| Ambient temperature (operation) | |
| Mounting | |
| Housing material | |
| Dimensions W / H / D | |
| Screw connection solid / stranded / AWG | |
| Spring-cage connection (solid/stranded/AWG) | |
| Conformance / approvals | |
| Conformance | |
| ATEX | |
| UL, USA / Canada | |
| GL | |

Housing width 6.2 mm

| Technical data | |
|--|---|
| NPN/PNP transistor outputs NAMUR initiators Floating relay contact (dry contact) 0.002 Hz ... 20 kHz (DIP switch) 0.002 Hz ... 80 kHz (Teach-in wheel) 30 V (incl. DC voltage) | |
| U output | I output |
| 0 ... 5 V / 1 ... 5 V | 0 ... 20 mA / 4 ... 20 mA |
| 0 ... 10 V / 10 ... 0 V | 20 ... 0 mA / 20 ... 4 mA |
| Approx. 12.3 V | 24.6 mA |
| $\geq 10 \text{ k}\Omega$ | 500 Ω (at 20 mA) |
| $< 20 \text{ mV}_{PP}$ | $< 20 \text{ mV}_{PP}$ (at 500 Ω) |
| 9.6 V DC ... 30 V DC $< 800 \text{ mW}$ (at $I_{OUT} = 20 \text{ mA}$, 9.6 V DC, load 500 Ω) | |
| 0.1% 0.01%/K $< 35 \text{ ms}$ (At $f > 500 \text{ Hz}$) Basic insulation according to EN 61010 1.5 kV (50 Hz, 1 min.) IP20 -20°C ... 65°C Any PBT 6.2 / 93.1 / 102.5 mm 0.2 ... 2.5 mm ² / 0.2 ... 2.5 mm ² / 26 - 12 0.2 ... 2.5 mm ² / 0.2 ... 2.5 mm ² / 24 - 12 | |
| CE-compliant Ex II 3 G Ex nA IIC T4 Gc X UL 508 Recognized applied for Class I, Div. 2, Groups A, B, C, D T5 applied for GL applied for | |

| Description | |
|----------------------------------|-------------------|
| MCR frequency transducers | |
| Standard configuration | Screw connection |
| Standard configuration | Spring-cage conn. |

| Ordering data | | |
|--------------------------------------|-----------|-------------|
| Type | Order No. | Pcs. / Pkt. |
| MINI MCR-SL-F-UI-NC ¹⁾ | 2902832 | 1 |
| MINI MCR-SL-F-UI-SP-NC ¹⁾ | 2902833 | 1 |

Frequency
Analog-frequency transducer

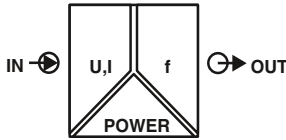

Configurable, frequency and PWM output



Housing width 6.2 mm

- Highly compact analog-to-frequency transducer for electrical isolation, amplification, conversion, and filtering of standard signals to create frequencies or PWM signals
- Configurable interference filter
- Input and output signals can be configured via DIP switches
- 3-way isolation
- Error signaling via diagnostic LED and analog signal
- Power supply possible through the foot element (T-Connector)
- PWM output of 5 ... 95%

Notes:
Information about power bridging, system cabling, and marking components can be found starting at page 88
1) EMC: Class A product, see page 571

| | |
|---|--|
| Input data | Input signal (configurable using the DIP switch) |
| Maximum input signal | |
| Input resistance | |
| Output data | Output signal (can be configured using DIP switches) |
| Minimum load | |
| Maximum load current | |
| Maximum switching voltage | |
| Overrange/underrange | |
| Protective circuit | |
| General data | |
| Supply voltage U_B | 19.2 V DC ... 30 V DC |
| Nominal supply voltage | 24 V DC |
| Current consumption | < 10 mA (at 24 V DC) |
| Power consumption | < 200 mW |
| Maximum transmission error | $\leq 0.1\%$ (> 7 kHz $\leq 0.2\%$) |
| Temperature coefficient | < 0.02%/K |
| Step response (0 - 99%) | < 15 ms (+ (1/f) smallest filter) < 1 s (+ (1/f) largest filter) |
| Electrical isolation | |
| Test voltage, input/output/supply | Basic insulation according to EN 61010 1.5 kV (50 Hz, 1 min.) |
| Degree of protection | IP20 |
| Ambient temperature (operation) | -20°C ... 65°C |
| Mounting | Any |
| Housing material | PBT |
| Dimensions W / H / D | 6.2 / 93.1 / 102.5 mm |
| Screw connection solid / stranded / AWG | 0.2 ... 2.5 mm ² / 0.2 ... 2.5 mm ² / 26 - 12 |
| Spring-cage connection (solid/stranded/AWG) | 0.2 ... 2.5 mm ² / 0.2 ... 2.5 mm ² / 24 - 12 |
| Conformance / approvals | |
| Conformance | CE-compliant |
| ATEX | Ex II 3 G Ex nA IIC T4 Gc X |
| UL, USA / Canada | UL 508 Recognized Class I, Div. 2, Groups A, B, C, D T5 applied for GL EMC 2 D |
| GL | |

Technical data

| | | | |
|-------------------------|--|-------------------|-------------------------------------|
| U input | 0 ... 5 V / 1 ... 5 V | I input | 0 ... 20 mA / 4 ... 20 mA |
| | 0 ... 10 V / 2 ... 10 V | | 0 ... 10 mA / 2 ... 10 mA - |
| | 30 V DC | | 100 mA |
| | Approx. 110 kΩ | | Approx. 50 Ω |
| Frequency output | | PWM output | |
| | 0 Hz ... 10 kHz / 0 Hz ... 5 kHz | | 7.8 kHz (10 bit) / 3.9 kHz (10 bit) |
| | 0 Hz ... 2.5 kHz / 0 Hz ... 1 kHz | | 1.9 kHz (12 bit) / 977 Hz (12 bit) |
| | 0 Hz ... 500 Hz / 0 Hz ... 250 Hz | | 488 Hz (14 bit) / 244 Hz (14 bit) |
| | 0 Hz ... 100 Hz / 0 Hz ... 50 Hz | | 122 Hz (16 bit) / 61 Hz (16 bit) |
| | 4 mA $\leq (U_L / R_L) \leq 20$ mA | | 12 mA $\leq (U_L / R_L) \leq 20$ mA |
| | 20 mA | | |
| | 30 V | | |
| | Can be set (via DIP switch) | | |
| | Short-circuit protection, polarity reversal protection | | |

| | |
|---------------------------------|---------------------------------------|
| Description | Screw connection Spring-cage conn. |
| MCR frequency transducer | |

Ordering data

| Type | Order No. | Pcs. / Pkt. |
|-----------------------------------|-----------|-------------|
| MINI MCR-SL-UI-F ¹⁾ | 2864082 | 1 |
| MINI MCR-SL-UI-F-SP ¹⁾ | 2810243 | 1 |

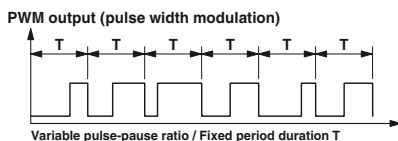
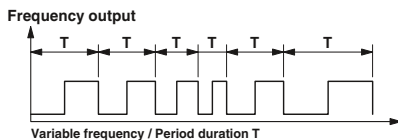

Potentiometer Potiposition transducer

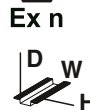

Configurable,
automatic potentiometer detection



Housing width 6.2 mm

- Highly compact potiposition transducer for electrical isolation, conversion, amplification, and filtering of potentiometer signals to create standard signals
- Automatic potentiometer detection without manual adjustment
- For potentiometers from 100 Ω to 100 kΩ
- Configurable measuring range and output signals
- A potentiometer sub-range can be linearized via the “teach-in” switch on the device
- Input and output signals can be configured via DIP switches
- 3-way isolation
- Error signaling via diagnostic LED and analog signal
- Power supply possible through the foot element (T-Connector)

Notes:
Information about power bridging, system cabling, and marking components can be found starting at page 88
1) EMC: Class A product, see page 571

| Input data | |
|---|--|
| Potentiometer | |
| Reference voltage source | |
| Output data | |
| Output signal | |
| Maximum output signal | |
| No-load voltage | |
| Short-circuit current | |
| Load R_B | |
| Ripple | |
| Behavior in the event of a sensor error | |
| General data | |
| Supply voltage U_B | |
| Nominal supply voltage | |
| Current consumption | |
| Power consumption | |
| Maximum transmission error | |
| Temperature coefficient | |
| Step response (0 - 99%) | |
| Electrical isolation | |
| Test voltage, input/output/supply | |
| Degree of protection | |
| Ambient temperature (operation) | |
| Mounting | |
| Housing material | |
| Dimensions W / H / D | |
| Screw connection solid / stranded / AWG | |
| Spring-cage connection (solid/stranded/AWG) | |
| Conformance / approvals | |
| Conformance | |
| ATEX | |
| UL, USA / Canada | |
| GL | |

| Technical data | | |
|---|--|----------------------------------|
| 100 Ω ... 100 kΩ | | |
| < 3.6 V | | |
| U output | | I output |
| 0 ... 5 V / 1 ... 5 V | | 0 ... 20 mA / 4 ... 20 mA |
| 0 ... 10 V / 10 ... 0 V | | 20 ... 0 mA / 20 ... 4 mA |
| 12.5 V | | 23 mA |
| | | Approx. 12.5 V |
| Approx. 10 mA | | |
| > 10 kΩ | | < 500 Ω (20 mA) |
| < 20 mV _{pp} (at 10 kΩ) | | < 20 mV _{pp} (at 500 Ω) |
| 0% ... 105% (configurable) | | |
| General data | | |
| 19.2 V DC ... 30 V DC | | |
| 24 V DC | | |
| < 25 mA (at 24 V DC) | | |
| < 500 mW | | |
| < 0.2% | | |
| < 0.02%/K | | |
| < 30 ms | | |
| Basic insulation according to EN 61010 | | |
| 1.5 kV (50 Hz, 1 min.) | | |
| IP20 | | |
| -20°C ... 65°C | | |
| Any | | |
| PBT | | |
| 6.2 / 93.1 / 102.5 mm | | |
| 0.2 ... 2.5 mm ² / 0.2 ... 2.5 mm ² / 26 - 12 | | |
| 0.2 ... 2.5 mm ² / 0.2 ... 2.5 mm ² / 24 - 12 | | |
| Conformance | | |
| CE-compliant | | |
| Ex II 3 G Ex nA IIC T4 Gc X | | |
| UL 508 Recognized | | |
| Class I, Div. 2, Groups A, B, C, D T5 applied for | | |
| GL EMC 2 D | | |

| Description | |
|-------------------------------------|-------------------|
| MINI potiposition transducer | |
| | Screw connection |
| | Spring-cage conn. |

| Ordering data | | |
|-----------------------------------|-----------|-------------|
| Type | Order No. | Pcs. / Pkt. |
| MINI MCR-SL-R-UI ¹⁾ | 2864095 | 1 |
| MINI MCR-SL-R-UI-SP ¹⁾ | 2810256 | 1 |

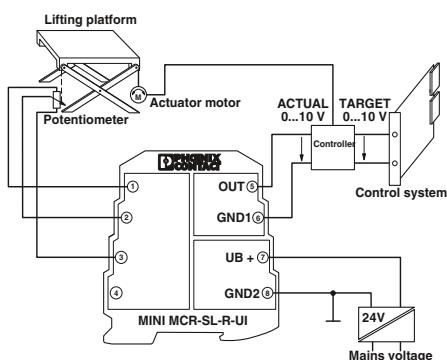

Height adjustment of a lifting platform with setpoint and actual value control

Limit values
Threshold value switch



Ex n



Configurable, with relay PDT output



Housing width 6.2 mm

- Highly compact threshold value switch for switching analog limit values
- Input signal, hysteresis, and delay time can be configured via DIP switches
- Limit value can be freely adjusted via potentiometer on front
- 3-way isolation
- PDT relay at output
- Operating current/quiescent current switchover
- Status and error signaling via two diagnostic LEDs
- Power supply possible through the foot element (T-Connector)

Notes:

Information about power bridging, system cabling, and marking components can be found starting at page 88

1) EMC: Class A product, see page 571

Input data

Input signal (configurable using the DIP switch)
Maximum input signal
Input resistance
Specification of the switching point

Switching output

Relay output
Contact material
Max. switching voltage
Limiting continuous current
Hysteresis (configurable using the DIP switch)
Operating and closed circuit current behavior
Setting range of the response delay (configurable using the DIP switch)

General data

Supply voltage U_B
Nominal supply voltage
Current consumption
Power consumption
Linearity error
Temperature coefficient
Step response (0 - 99%)
Electrical isolation
Test voltage input/power supply
Degree of protection
Ambient temperature (operation)
Mounting
Housing material
Dimensions W / H / D
Screw connection solid / stranded / AWG
Spring-cage connection (solid/stranded/AWG)

Conformance / approvals

Conformance
ATEX
UL, USA / Canada
UL, USA
UL, Canada
GL

Technical data

| U input | I input |
|-----------------------------|-------------|
| 0 ... 10 V | 0 ... 20 mA |
| 30 V | 100 mA |
| > 100 kΩ | 50 Ω |
| With 25-speed potentiometer | |

1 PDT
AgSnO₂, hard gold-plated
250 V AC
2 A
(0.1%; 1%; 2.5%; 5%)
Switchable using DIP switch
0 s ... 10 s (0 s; 1 s; 2 s; 3 s; 4 s; 6 s; 8 s; 10 s)

19.2 V DC ... 30 V DC
24 V DC
< 14 mA (at 24 V DC)
< 330 mW (at 24 V DC)
< 0.05% (of final value)
< 0.02%/K
< 35 ms
Basic insulation according to EN 61010
1.5 kV AC (50 Hz, 1 min.)
IP20
-20°C ... 65°C
Any
PBT
6.2 / 93.1 / 102.5 mm
0.2 ... 2.5 mm² / 0.2 ... 2.5 mm² / 26 - 12
0.2 ... 2.5 mm² / 0.2 ... 2.5 mm² / 24 - 12

CE-compliant
Ex II 3 G Ex nA nC IIC T4 Gc X
UL 508 Recognized
Class I, Zone 2, AEx nC IIC T6
Class I, Zone 2, Ex nC IIC T6
GL EMC 2 D

Ordering data

Description

MCR threshold value switch

Screw connection
Spring-cage conn.

Type

MINI MCR-SL-UI-REL¹⁾
MINI MCR-SL-UI-REL-SP¹⁾

Order No.

2864480
2864493

Pcs. / Pkt.

1
1

Digital IN
NAMUR isolation amplifiers



Ex n

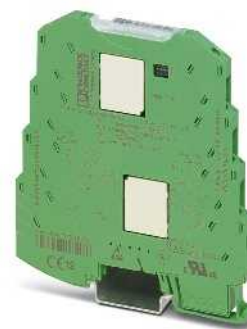

Configurable, for NAMUR sensors and floating contacts



Housing width 6.2 mm

- Highly compact isolation amplifier for electrical isolation, amplification, and duplication of proximity sensor signals
- For proximity sensors in accordance with IEC 60947-5-6 and EN 50227
- Floating contacts and contacts with resistance circuit can be connected
- Input and output signals can be configured via DIP switches
- N/O contacts at output
- Second output can be used as a doubler or error signaling output
- 3-way isolation
- Switchover between operating current and quiescent current (inverted switching behavior)
- Error signaling via diagnostic LED and analog signal
- Power supply possible through the foot element (T-Connector)

Notes:
Information about power bridging, system cabling, and marking components can be found starting at page 88
1) EMC: Class A product, see page 571

| | |
|--------------------------------|--|
| Input data | Input signal |
| Control circuit | No-load voltage Switching points (according to IEC 60947-5-6) |
| Line error detection | |
| Switching output | Relay output Contact material Maximum switching voltage Maximum switching current Minimum contact current Switching frequency |
| General data | Supply voltage U_B Nominal supply voltage Current consumption Power consumption Electrical isolation Test voltage, input/output/supply Degree of protection Ambient temperature (operation) Mounting Housing material Dimensions W / H / D Screw connection solid / stranded / AWG Spring-cage connection (solid/stranded/AWG) |
| Conformance / approvals | Conformance ATEX UL, USA / Canada |
| GL | |

Technical data

| |
|--|
| NAMUR proximity sensors (EN 60947-5-6) Open circuit switch contacts Switch contacts with resistance circuit |
| 8.2 V DC $\pm 10\%$ < 1.2 mA (blocking) > 2.1 mA (conductive) > 6 mA (in the event of a short-circuit) < 0.35 mA (With wire break) |
| 2 N/O contacts Hard gold plated AgNi 250 V AC 2 A 1 mA (for 5 V DC) 0.5 Hz (240 V AC / 30 V DC / 2 A) 10 Hz (without load) |
| 19.2 V DC ... 30 V DC 24 V DC < 25 mA < 600 mW Basic insulation according to EN 61010 1.5 kV (50 Hz, 1 min.) IP20 -20°C ... 65°C Any PBT 6.2 / 93.1 / 102.5 mm 0.2 ... 2.5 mm ² / 0.2 ... 2.5 mm ² / 26 - 12 0.2 ... 2.5 mm ² / 0.2 ... 2.5 mm ² / 24 - 12 |
| CE-compliant Ex II 3 G Ex nA nC IIC T4 Gc X UL 508 Recognized Class I, Div. 2, Groups A, B, C, D T5 applied for GL EMC 2 D |

Ordering data

| Description | Type | Order No. | Pcs. / Pkt. |
|-------------------------------|---------------------------------------|-----------|-------------|
| MCR NAMUR switching amplifier | MINI MCR-SL-NAM-2RNO ¹⁾ | 2864105 | 1 |
| | MINI MCR-SL-NAM-2RNO-SP ¹⁾ | 2810269 | 1 |

Accessories

Constant voltage source



Ex n



Configurable,
output signals 2.5 V / 5 V / 7.5 V / 10 V

Ex: Ex

Applied for: cUL / UL
Housing width 6.2 mm

- Constant voltage source for potentiometers, measuring bridges, encoders
- Highly precise
- Input signal corresponds to power supply
- Input signal and, in turn, the power supply can be provided via the foot element (T-Connector)
- Standard configuration:
Output 10 V DC

Notes:

Information on components for power bridging, system cabling, and marking can be found in the INTERFACE catalog or at www.phoenixcontact.net/products

1) EMC: Class A product, see page 571

| | |
|--|---|
| Input data | |
| Input signal | 9.6 ... 30 V |
| Output data | |
| Output signal (can be configured using DIP switches) | 10 V DC 7.5 V DC 5 V DC 2.5 V DC |

Short-circuit current
Ripple

General data

Supply voltage U_B
Power consumption
Maximum transmission error
Temperature coefficient
Electrical isolation
Test voltage input/output
Degree of protection
Ambient temperature (operation)
Housing material
Dimensions W / H / D
Screw connection solid / stranded / AWG
Spring-cage connection (solid/stranded/AWG)
Conformance / approvals
Conformance
ATEX
UL, USA / Canada

Technical data

9.6 ... 30 V

10 V DC
7.5 V DC
5 V DC
2.5 V DC

Approx. 32 mA
< 20 mV_{PP}

9.6 V DC ... 30 V DC
< 600 mW (at 24 V IN)
≤ 0.1% (of final value)
< 0.01%/K, typ. < 0.002%/K

Basic insulation according to EN 61010
1.5 kV (50 Hz, 1 min.)
IP20
-20°C ... 65°C
PBT
6.2 / 93.1 / 102.5 mm
0.2 ... 2.5 mm² / 0.2 ... 2.5 mm² / 26 - 12
0.2 ... 2.5 mm² / 0.2 ... 2.5 mm² / 24 - 12

CE-compliant
Ex II 3 G Ex nA IIC T4 Gc X
UL 508 Recognized
Class I, Div. 2, Groups A, B, C, D T5

| | |
|------------------------------------|-------------------|
| Description | |
| MCR constant voltage source | |
| With screw connection | Screw connection |
| With spring-cage connection | Spring-cage conn. |

Setpoint potentiometer, to set setpoints individually

Resistance value 4.7 kΩ
Resistance value 10 kΩ

Ordering data

| Type | Order No. | Pcs. / Pkt. |
|---|-----------|-------------|
| MINI MCR-SL-CVS-24-5-10-NC ¹⁾ | 2902822 | 1 |
| MINI MCR-SL-CVS-24-5-10-SP-NC ¹⁾ | 2902823 | 1 |

Accessories

| | | |
|-------------------|---------|----|
| EMG 30-SP- 4K7LIN | 2940252 | 10 |
| EMG 30-SP-10K LIN | 2942124 | 10 |

Accessories

Feed-through terminal blocks

- Feed-through terminal block for 1:1 forwarding of signals in the MINI Analog group
- For plugging gaps in system cabling with the V8 system adapter, e.g., when there are fewer than eight signals
- Used in conjunction with the MINI Analog multiplexer
- For direct mounting in the case of applications without signal conversion and without electrical isolation



Ex n



1:1 connection

| General data | |
|---|---|
| Degree of protection | IP20 |
| Ambient temperature (operation) | -20°C ... 65°C |
| Mounting | Any |
| Housing material | PBT |
| Dimensions W / H / D | 6.2 / 93.1 / 102.5 mm |
| Screw connection solid / stranded / AWG | 0.2 ... 2.5 mm ² / 0.2 ... 2.5 mm ² / 24 - 12 |
| Conformance / approvals | |
| ATEX | Ex II 3 G Ex nA IIC T4 Gc X |
| GL | GL EMC 2 D |

Technical data

| Degree of protection | IP20 |
|---|---|
| Ambient temperature (operation) | -20°C ... 65°C |
| Mounting | Any |
| Housing material | PBT |
| Dimensions W / H / D | 6.2 / 93.1 / 102.5 mm |
| Screw connection solid / stranded / AWG | 0.2 ... 2.5 mm ² / 0.2 ... 2.5 mm ² / 24 - 12 |
| Conformance / approvals | |
| ATEX | Ex II 3 G Ex nA IIC T4 Gc X |
| GL | GL EMC 2 D |

| Description |
|--|
| MINI Analog feed-through terminal block |

Screw connection

Ordering data

| Type | Order No. | Pcs. / Pkt. |
|----------------|-----------|-------------|
| MINI MCR-SL-TB | 2811420 | 1 |

Accessories

Marking material

- Flexible labeling system with pivoting transparent cover and matching insert strips
- Transparent cover that can be snapped onto the module instead of the standard cover
- Insert strips on pre-punched paper sheets
- Marking option for standard cover in the form of ZBF 6 zack marker strip marking labels

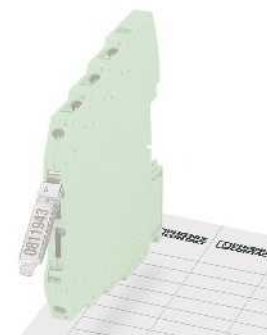

Transparent cover with insert strips

| Description |
|--|
| Fold-up transparent cover , for labeling MINI Analog modules with insert strips |

| |
|---|
| Insert strips , stamped, for transparent cover |
|---|

| |
|---|
| Zack marker strip, flat |
| UniCard sheets , for marker groove |

Ordering data

| Type | Order No. | Pcs. / Pkt. |
|--------------|-----------|-------------|
| MINI MCR-DKL | 2308111 | 10 |

Accessories

| | | |
|--------------------------|---------|----|
| MINI MCR-DKL-LABEL | 2810272 | 10 |
| ZBF 6 (see Catalog 5) | | |
| UC-TMF 6 (see Catalog 5) | | |

Accessories

Power terminals

- For up to 80 MINI Analog modules
- The MINI MCR-SL-PTB-FM(-SP) power terminal block is used to supply the supply voltage to the DIN rail connector
- Monitoring of supplies in combination with the fault monitoring module
- Flexible redundant supply from one or both module sides
- Extended supply voltage range from 0 ... 30 V DC



Power terminal block, can be monitored

Notes:
1) EMC: Class A product, see page 571

| |
|---------------------------------|
| Input data |
| Input voltage range |
| Output data |
| Output voltage |
| Output current |
| General data |
| Ambient temperature (operation) |
| Conformance / approvals |
| Conformance |
| ATEX |
| UL, USA / Canada |
| GL |

| Technical data | |
|---------------------------------|---|
| Input voltage range | 0 V DC ... 30 V DC |
| Output voltage | (Input voltage - 0.8 V) |
| Output current | ≤ 2 A |
| Ambient temperature (operation) | -20°C ... 65°C |
| Conformance / approvals | CE-compliant Ex II 3 G Ex nA IIC T4 Gc X UL 508 Recognized applied for Class I, Div. 2, Groups A, B, C, D T5 applied for GL applied for |

| Description |
|-----------------------------------|
| MINI Analog power terminal blocks |

| Ordering data | | |
|-------------------------------------|-----------|-------------|
| Type | Order No. | Pcs. / Pkt. |
| MINI MCR-SL-PTB-FM ¹⁾ | 2902958 | 1 |
| MINI MCR-SL-PTB-FM-SP ¹⁾ | 2902959 | 1 |

Accessories

Error message modules

- Fault monitoring module for evaluating and reporting group errors from the fault monitoring system.
- Monitoring of supply voltages of MINI MCR-SL-PTB-FM(-SP) power terminal blocks
 - Drawing off the supply is possible
 - The error is reported via an N/C contact
 - Standard configuration: group error detection "ON"; redundancy monitoring "ON"; relay "active"



Group error message and Supply monitoring

Notes:
1) EMC: Class A product, see page 571

| |
|-------------------------------|
| Input data/output data |
| Input signal |
| Output signal |
| Output signal maximum current |
| Switching output |
| Maximum switching voltage |
| Maximum switching current |
| Test voltage input/output |
| Conformance / approvals |
| Conformance |
| ATEX |
| UL, USA / Canada |
| GL |

| Technical data | |
|-------------------------------|--|
| Input signal | 9.6 V DC ... 30 V DC |
| Output signal | 9.6 V DC ... 30 V DC |
| Output signal maximum current | 2 A |
| Switching output | 30 V DC |
| Maximum switching voltage | 50 mA |
| Maximum switching current | 1.5 kV AC (50 Hz, 1 min.) |
| Test voltage input/output | CE-compliant Ex II 3 G Ex nA nC IIC T4 Gc X UL 508 Recognized applied for Class I, Div. 2, Groups A, B, C, D T5 applied for GL applied for |

| Description | |
|-----------------------------------|-------------------|
| MINI Analog error message modules | |
| Standard configuration | Screw connection |
| Standard configuration | Spring-cage conn. |

| Ordering data | | |
|---------------------------------------|-----------|-------------|
| Type | Order No. | Pcs. / Pkt. |
| MINI MCR-SL-FM-RC-NC ¹⁾ | 2902961 | 1 |
| MINI MCR-SL-FM-RC-SP-NC ¹⁾ | 2902962 | 1 |

Accessories

ME 6,2 TBUS... T-Connector

- For bridging the supply voltage
- Reduces wiring costs
- Module can be replaced without interrupting the supply to the remaining modules (hot swap)
- One T-Connector for two MINI Analog modules
- Current carrying capacity of 2 A to MINI Analog modules



For bridging the supply voltage

| Description |
|---|
| DIN rail connector (TBUS) , for bridging the supply voltage, can be snapped onto 35 mm DIN rails as per EN 60715, with UL approval |

| Ordering data | | |
|--------------------------------|-----------|-------------|
| Type | Order No. | Pcs. / Pkt. |
| ME 6,2 TBUS-2 1,5/5-ST-3,81 GN | 2869728 | 10 |

Accessories

Power terminals

- For supplying the supply voltage via the foot element (T-Connector) where DC voltages of up to 30 V are already available
- Option of redundant supply decoupled from diode
- For up to 80 MINI analog modules
- For up to 2 A
- Status and error signaling via diagnostic LEDs



Ex n



Redundant supply for existing 24 V

| Notes: |
|---|
| Recommended fuse for power terminal block: Fuse according to IEC 60127-2/V Nominal current: 2.5 A Characteristics: Slow-blow (e.g., Wickmann 5 x 20 mm/No. 195 - glass fuse) |
| 1) EMC: Class A product, see page 571 |

| |
|---------------------------------|
| Input data |
| Input voltage range |
| Output data |
| Output voltage |
| Output current |
| General data |
| Ambient temperature (operation) |
| Housing material |
| Conformance / approvals |
| Conformance |
| ATEX |
| UL, USA / Canada |
| GL |

| Technical data | |
|---------------------------------|--|
| Input voltage range | 20 V DC ... 30 V DC |
| Output data | (Input voltage - 0.8 V) |
| Output current | ≤ 2 A |
| Ambient temperature (operation) | -20°C ... 65°C |
| Housing material | PBT |
| Conformance | CE-compliant |
| ATEX | Ex II 3 G Ex nA IIC T4 Gc X |
| UL, USA / Canada | UL 508 Recognized Class I, Div. 2, Groups A, B, C, D T5 |
| GL | GL EMC 2 D |

| Description |
|---------------------------------|
| MCR power terminal block |

| Ordering data | | |
|----------------------------------|-----------|-------------|
| Type | Order No. | Pcs. / Pkt. |
| MINI MCR-SL-PTB ¹⁾ | 2864134 | 1 |
| MINI MCR-SL-PTB-SP ¹⁾ | 2864147 | 1 |

Accessories
ME 17,5 TBUS...T-Connector

- For bridging the supply voltage when using a MINI POWER system power supply

Notes:

If the system power supply is used, you need two ME 17,5 TBUS T-Connectors to establish the connection with the ME 6,2 TBUST-Connectors of the MINI Analog system and provide an effective power supply.



For system power supply

| Description |
|---|
| DIN rail connector , for bridging the supply voltage, can be snapped onto 35 mm DIN rails as per EN 60715, with UL approval, two pieces are required per system power supply |

| Ordering data | | |
|--------------------------------|-----------|-------------|
| Type | Order No. | Pcs. / Pkt. |
| ME 17,5 TBUS 1,5/ 5-ST-3,81 GN | 2709561 | 10 |

Accessories
System power supply

- For supplying the supply voltage via the foot element (T-Connector) where AC voltages are available
- 100 ... 240 V AC nominal input voltage range
- 24 V DC output voltage
- For up to 60 MINI Analog modules
- For up to 1.5 A, secondary
- Status and error signaling via diagnostic LEDs



For applications with local voltages of over 100 V

| Description |
|--|
| System power supply unit , primary-switched with zone 2 approval. More information is given in the INTERFACE Power Supply catalog part. |
| System power supply unit , primary-switched (not for zone 2). More information is given in the INTERFACE Power Supply catalog part. |

| Ordering data | | |
|--------------------------------|-----------|-------------|
| Type | Order No. | Pcs. / Pkt. |
| MINI-PS-100-240AC/24DC/1.5/EX | 2866653 | 1 |
| MINI-SYS-PS-100-240AC/24DC/1.5 | 2866983 | 1 |

Accessories

System cabling

A high number of channels enables analog signal transmission across 6 mm in a confined space for many applications. In this kind of context, in particular, it is really important to have access to wiring solutions that avoid errors and are time-efficient, thereby cutting costs.

The MINI Analog system cabling solution allows you to wire up to eight channels quickly, easily, and without errors.

System cabling can take various forms.

System cabling with a front adapter

This includes:

- A 16-pos. FLK cable
- The V8 system adapter for MINI Analog modules
- A front adapter that needs to be specifically selected based on the analog card of the controller

With this solution, all you need to do is connect the components together. There is virtually no wiring effort involved. What's more, it completely rules out wiring errors, as the pre-assembled components ensure correct assignment by virtue of their design.

System cabling without a front adapter

The version that does not require the use of a front adapter is the ideal addition.

This solution involves using a 16-pos. FLK cable with open ends on one side. The open ends are fitted with ferrules and are numbered. This allows you to create a system cabling connection to virtually any module without having to fit a front adapter. The other advantage is that you can implement system cabling on the module side quickly, easily, and without errors.



System cabling with a front adapter

The tables below are designed to serve as a configuration aid. Details of other solutions are available on the Internet or on request.

| Configuration aid for MINI Analog system cabling | | | | |
|--|---|---|---|---|
| Controller | Analog card | Front adapter | FLK cable | V8 system adapter for MINI Analog |
| Siemens SIMATIC S7-300 / ET 200 M | 6ES7-331-7KF02-0AB0 6ES7-331-7KB02-0AB0 6ES7-331-7KB81-0AB0 6ES7-331-7TF00-0AB0 6ES7-332-8TF01-0AB0 | FLKM 16-PA-S300/MINI-MCR (in the catalog on page 454) | FLK 16/EZ-DR/.../KONFEK (non-molded plugs, in the catalog on page 506) | MINI MCR-SL-V8-FLK 16-A (in the catalog on page 94) |
| | 6ES7-331-1KF01-0AB0 (for current signals) | FLKM 16-PA-331-1KF//MINI-MCR (in the catalog on page 455) | | |
| | 6ES7-331-5HF00-0AB0 (for current signals) | FLKM 16-PA-332-5HF//MINI-MCR (in the catalog on page 455) | | |
| | | | | |
| Yokogawa Centum CS 3000 R3 | AAI 141 AAI 143 | Not required | CABLE-40/2/FLK16/.../YUC (non-molded plugs, in the catalog on page 467) | 2 x MINI MCR-SL-V8-FLK 16-A (in the catalog on page 94) |
| Miscellaneous controllers / actuators / sensors | All cards | Not required | CABLE-FLK16/OE/0,14/...M (non-molded plugs, in the catalog on page 502) or alternatively VIP-CAB-FLK16/FR/OE/0,14/...M (molded plugs, in the catalog on page 502) | MINI MCR-SL-V8-FLK 16-A (in the catalog on page 94) |

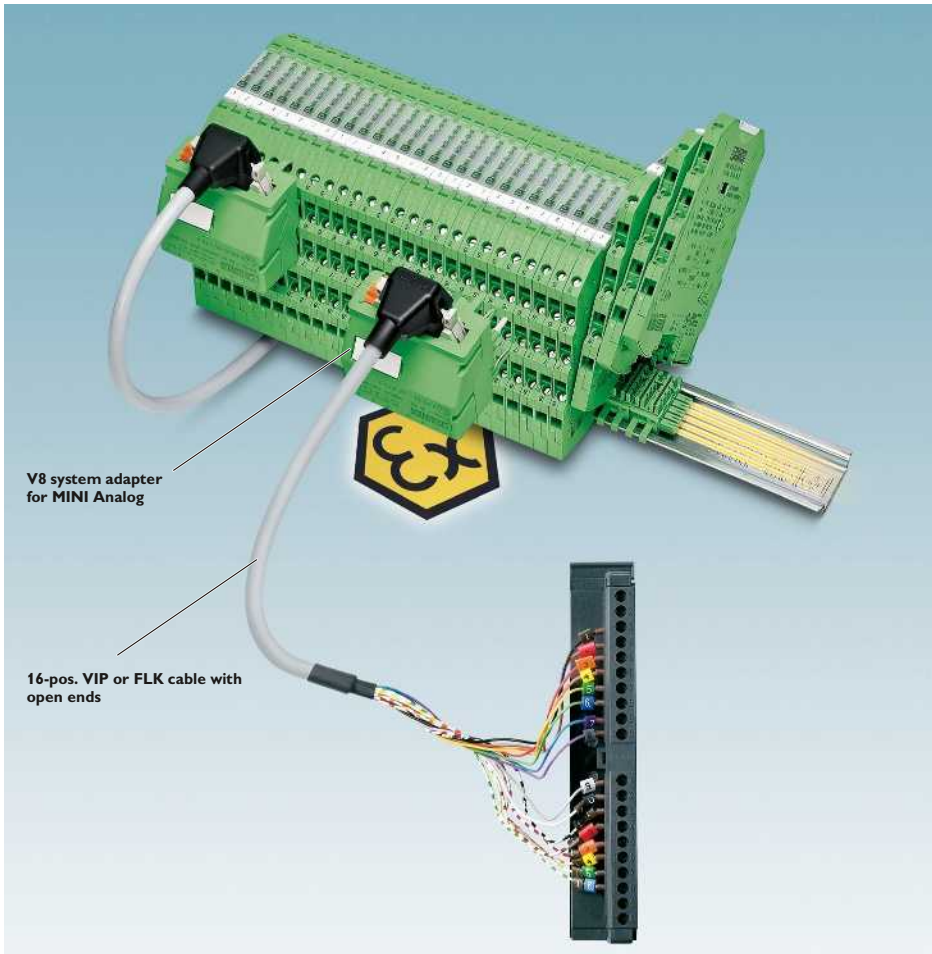

V8 system adapter for MINI Analog

16-pos. VIP or FLK cable with open ends

System cabling without a front adapter

Innovative concept

Thanks to its innovative design concept, the MINI MCR-SL-V8-FLK 16 A MINI Analog system adapter can be used on both the input and output side. Consequently, there is nothing at all to prevent you from using the same components for system cabling on both output and input modules.

Complete flexibility

The proven FLK cable series offers complete flexibility in terms of selection and is the ideal solution for system cabling with a front adapter. The flat and flexible plug connections mean that the products can be easily installed in any analog module.

Increased protection

The new VIP cables with molded FLK plugs offer enhanced protection in harsh industrial environments. If you opt for system cabling without a front adapter, you can enjoy all the advantages of the new VIP cables on the system adapter side.

Addition

If the application demands a form of system cabling with fewer than eight channels, the MINI MCR-SL-TB feed-through terminal block (page 88) represents the perfect addition.



Plug-in connection



Innovative concept



Complete flexibility



Increased protection



Addition

Accessories

MINI Analog system adapter

- Time-saving wiring solution thanks to unique plug-in concept
- System cabling on PLC side
- Plug and play
- For up to eight channels
- Reduces wiring costs and errors



System adapter



Housing width 50.4 mm

Technical data

| | |
|---|--|
| General data | |
| Contact resistance | < 10 mΩ |
| Current carrying capacity | ≤ 1 A |
| Test voltage | 500 V (50 Hz, 1 min. from channel to channel) |
| Vibration resistance | ≤ 0.7 g |
| Surge voltage category / Pollution degree | III / 2 |
| Ambient temperature (operation) | -20°C ... 60°C |
| Housing material | PBT |
| Dimensions W / H / D | 50.4 / 46.2 / 45.5 mm |
| Connection to the signal level | Flat-ribbon cable plug connector according to IEC 60603-13 |
| Insertion/withdrawal cycles (System adapter / FLK 16) | 10 / ≥ 200 |
| Conformance / approvals | |
| ATEX | Ex II 3 G Ex nA IIC T4 Gc X |
| UL, USA / Canada | UL 508 Recognized Class I, Div. 2, Groups A, B, C, D T5 applied for |
| GL | GL EMC 2 D |

Ordering data

| Description | Type | Order No. | Pcs. / Pkt. |
|---|-------------------------|-----------|-------------|
| System adapter , for MINI analog modules with screw connection | MINI MCR-SL-V8-FLK 16-A | 2811268 | 1 |



MINI Analog system cabling

Accessories

MINI Analog multiplexer

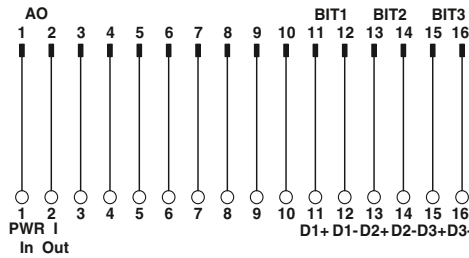

FLK pin strip assignment

- Generates an analog output from up to eight analog input signals – parallel analog signals are transmitted serially via a cable
- The desired number of channels is selected via DIP switches (8, 6, 4 or 2 channels)
- The channel currently switched is indicated as a bit pattern via three digital outputs
- Two clock cycles for execution can be selected via DIP switches (one- or two-second clock)
- Supplied by an output loop
- For 4 ... 20 mA current signals
- Can be easily snapped onto MINI Analog modules with screw connection
- Huge reduction in analog inputs at controllers
- System cabling on the output side using pre-assembled FLK cables with open ends.

Notes:
 For six, four or two channels you will also need the corresponding number of feed-through terminal blocks (i.e., two, four or six).
 1) EMC: Class A product, see page 571

| |
|---|
| Input data |
| Description |
| Can be configured/parameterized |
| Input signal |
| Maximum input signal |
| Switching cycles |
| Output data |
| Output signal |
| Maximum output signal |
| Load R_B |
| Status indication Active input |
| Switching output |
| Maximum switching voltage |
| General data |
| Supply voltage U_B |
| Current consumption |
| Power consumption |
| Maximum transmission error |
| Temperature coefficient |
| Ambient temperature (operation) |
| Housing material |
| Dimensions W / H / D |
| Connection to control level |
| Insertion/withdrawal cycles (System adapter / FLK 16) |
| Conformance / approvals |
| Conformance |
| ATEX |
| UL, USA / Canada |

Ex: Housing width 50.4 mm

| Technical data | |
|---|--|
| 2, 4, 6, or 8-channel (can be switched over) | |
| Via DIP switches | |
| 4 ... 20 mA | |
| < 30 mA | |
| 2 or 1 sec. (can be selected) | |
| 4 ... 20 mA | |
| < 30 mA | |
| $((U_{supply} - 7 V) / I_{max})$ | |
| 1, 2, 3-bit digital output (can be selected) | |
| 3 x PNP optocouplers | |
| 30 V DC | |
| 7 V DC ... 30 V DC (Loop-powered) | |
| < 3.5 mA (without signal current) | |
| < 24 mW (without signal current) | |
| 0.3% (0.1%, typical) | |
| < 0.01%/K | |
| -20°C ... 65°C | |
| PBT | |
| 50.4 / 45.5 / 46.2 mm | |
| Flat-ribbon cable plug connector according to IEC 60603-13 | |
| 10 / ≥ 200 | |
| CE-compliant | |
| II 3 G Ex nA IIC T4 Gc X | |
| UL 508 Recognized applied for Class I, Div. 2, Groups A, B, C, D T5 applied for | |

| Description |
|--|
| Multiplexer for MINI Analog modules with screw connection |

| Ordering data | | |
|---|-----------|-------------|
| Type | Order No. | Pcs. / Pkt. |
| MINI MCR-SL-MUX-V8-FLK 16 ¹⁾ | 2811815 | 1 |

| MINI Analog feed-through terminal block |
|---|
| For round cable with one open end, see "System cabling for controllers" section |
| For round cable with one open end, see "System cabling for controllers" section |

| Accessories | | |
|------------------------------|---------|---|
| MINI MCR-SL-TB | 2811420 | 1 |
| VIP-CAB-FLK16/FR/OE/0,14/... | | |
| CABLE-FLK16/OE/0,14/... | | |

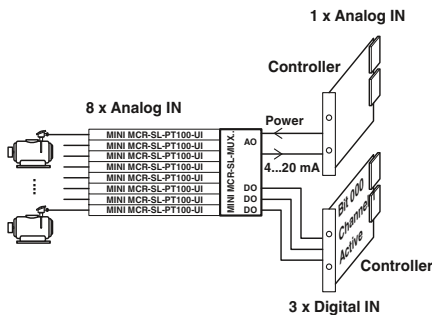

Monitoring of eight motor temperatures with just one analog control input

Termination carrier for MINI Analog isolating amplifier



TC... termination carriers are compact solutions for conveniently and smoothly connecting standard DIN rail isolating amplifiers from the MINI Analog series to input/output cards of automation systems using system cables.

The most compact isolating amplifiers combined with the most compact and flexible module carriers on the market enable you to achieve a hitherto unparalleled packing density in your control cabinet together with professional system cabling.

Compact

- The compact design associated with MINI Analog saves up to 65% of space in the control cabinet

Robust and reliable

- Stable, vibration-resistant aluminum carrier device profile
- PCB is completely decoupled from isolating amplifiers
- PCB without active electronics
- Redundant supply via separate DIN rail module
- Horizontal or vertical DIN rail mounting

Flexible

- Profile sections without pitch markings
- Quick and safe module connection with plug-in cable sets
- Horizontal or vertical DIN rail mounting
- Can be flexibly adapted to suit any controller or higher-level control system
- Solutions tailored to your requirements on request
- Available pre-assembled with modules and wired, or for self-assembly



Select standard DIN rail device



Select module carrier



Select controller-specific front adapter and system cable



Solutions are also available for MACX Analog, MACX Analog Ex, and Safety

Termination carrier for MINI Analog isolating amplifier

The **TC-D37SUB-ADIO16-M-P-UNI** universal termination carrier is a compact solution which connects isolating amplifiers from the MINI Analog series to input/output cards of automation systems.

The **TC-D37SUB-AIO16-M-PS-UNI** termination carrier version also enables the coupling and decoupling of HART signals.

- Connection of up to 16 channels
- Can be universally connected, thanks to 37-pos. D-SUB cable with open ends. This enables flexible connection to automation systems
- Redundant power supply, decoupled from diode via separate MINI MCR-PTB power module and MINI MCR-SL-TB feed-through terminal block

Notes:
Contact us: together, we can develop optimum solutions for your automation system with the termination carrier for MINI Analog.
1) EMC: Class A product, see page 571



| General data | |
|---|---|
| Connection to the control system level | D-SUB pin strip |
| Number of positions | 37 |
| Maximum operating voltage | < 50 V DC (Per signal/channel) |
| Maximum permissible current | 1 A (Signal/channel) |
| Rated insulation voltage | 50 V |
| Surge voltage category | II |
| Pollution degree | 2 |
| Rated surge voltage | 0.5 kV |
| Air and creepage distances | DIN EN 50178 (Basic insulation) |
| Degree of protection | IP20 |
| Ambient temperature range | -40°C ... 80°C (Please observe module specifications) |
| Shock | 15g, according to IEC 60068-2-27 |
| Vibration (operation) | 2g, according to IEC 60068-2-6 |
| Inflammability class according to UL 94 | V0 |
| Dimensions W / H / D | 136 / 170 / 160 mm |
| Power supply via power module | |
| Input voltage range | 19.2 V DC ... 30 V DC |
| Redundant supply | yes, decoupled from diodes |
| Polarization and surge protection | Yes |
| Fuse | 2.5 A Slow-blow |
| Status indication | 2 x red LED (error) 1 x green LED (PWR) |

Housing width 136 mm

| Technical data | |
|---|---|
| D-SUB pin strip | 37 |
| Maximum operating voltage | < 50 V DC (Per signal/channel) |
| Maximum permissible current | 1 A (Signal/channel) |
| Rated insulation voltage | 50 V |
| Surge voltage category | II |
| Pollution degree | 2 |
| Rated surge voltage | 0.5 kV |
| Air and creepage distances | DIN EN 50178 (Basic insulation) |
| Degree of protection | IP20 |
| Ambient temperature range | -40°C ... 80°C (Please observe module specifications) |
| Shock | 15g, according to IEC 60068-2-27 |
| Vibration (operation) | 2g, according to IEC 60068-2-6 |
| Inflammability class according to UL 94 | V0 |
| Dimensions W / H / D | 136 / 170 / 160 mm |
| Power supply via power module | |
| Input voltage range | 19.2 V DC ... 30 V DC |
| Redundant supply | yes, decoupled from diodes |
| Polarization and surge protection | Yes |
| Fuse | 2.5 A Slow-blow |
| Status indication | 2 x red LED (error) 1 x green LED (PWR) |

| Description | |
|--|--|
| Module carrier for 16 MINI Analog channels, power and feed-through module | |
| - With connection for MACX MCR-S-MUX HART multiplexer | |

| Ordering data | | |
|--|-----------|-------------|
| Type | Order No. | Pcs. / Pkt. |
| TC-D37SUB-ADIO16-M-P-UNI | 2902933 | 1 |
| TC-D37SUB-AIO16-M-PS-UNI ¹⁾ | 2902934 | 1 |

| Accessories | |
|--|------------------------------------|
| MINI Analog power terminal blocks | MINI MCR-SL-PTB-FM ¹⁾ |
| MINI Analog error message modules | MINI MCR-SL-FM-RC-NC ¹⁾ |
| HART multiplexer, 32-channel, including two 14-wire flat-ribbon cables | MACX MCR-S-MUX |

| Accessories | | |
|------------------------------------|-----------|-------------|
| Accessories | Order No. | Pcs. / Pkt. |
| MINI MCR-SL-PTB-FM ¹⁾ | 2902958 | 1 |
| MINI MCR-SL-FM-RC-NC ¹⁾ | 2902961 | 1 |
| MACX MCR-S-MUX | 2865599 | 1 |



TC-D37SUB-ADIO16-M-P-UNI and TC-D37SUB-AIO16-M-PS-UNI connection scheme

Accessories

Surge protection

LINETRAB LIT

The ideal addition to MINI Analog - the innovative surge protection solution in 6.2 mm housing.

Because the LINETRAB LIT and MINI Analog housing is the same shape, you can benefit from the numerous advantages of system cabling. The advantage of combining MINI Analog and LINETRAB LIT products is that it enables you to set up a space-saving, protected, and optimally coordinated signal chain from the sensor right up to the controller.

The tables below are designed to serve as configuration aids for combining MINI Analog and LINETRAB products.

On the left, you will find a list of the components and combination options for setting up system cabling between MINI Analog and LINETRAB.

For details of system cabling solutions that can be used between MINI Analog and the controller side, please refer to page 92.

For more detailed information on LINETRAB LIT surge protection modules, please see the TRABTECH catalog.

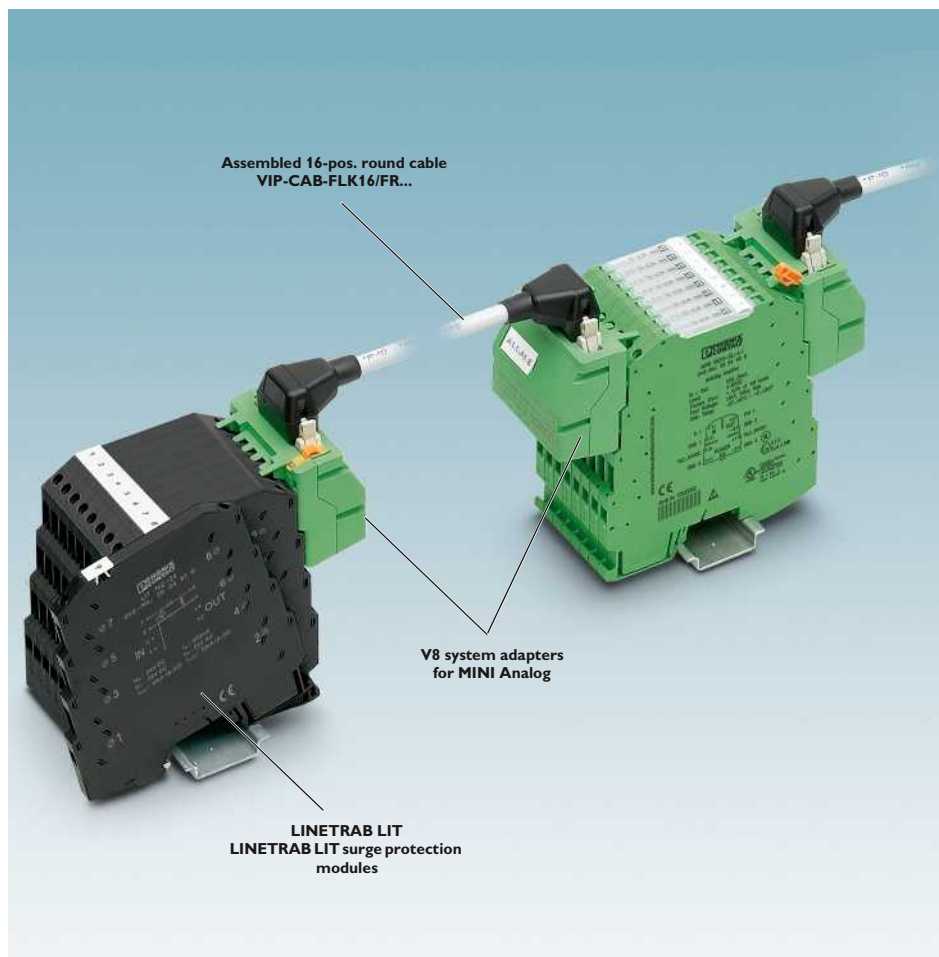

Reliable and systematic measurements - LINETRAB LIT and MINI Analog

Configuration aid for LINETRAB LIT - MINI Analog

Cabling via MINI Analog system adapter (8 modules)

| LINETRAB LIT (surge protection) | | MINI Analog | |
|---------------------------------|-----------|----------------------|-----------|
| Type | Order No. | Type | Order No. |
| LIT 1X2-24 | 2804610 | MINI MCR-SL-UI-UI | 2864383 |
| | | MINI MCR-SL-UI-UI-NC | 2864150 |
| | | MINI MCR-SL-U-UI-NC | 2865007 |
| | | MINI MCR-SL-U-I-0 | 2813512 |
| | | MINI MCR-SL-U-I-4 | 2813525 |
| | | MINI MCR-SL-I-U-0 | 2813541 |
| | | MINI MCR-SL-I-U-4 | 2813538 |
| | | MINI MCR-SL-I-I | 2864406 |
| | | MINI MCR-SL-U-U | 2864684 |
| | | MINI MCR-SL-UI-2I | 2864794 |
| | | MINI MCR-SL-UI-2I-NC | 2864176 |
| | | MINI MCR-SL-RPS-I-I | 2864422 |
| | | MINI MCR-SL-RPSS-I-I | 2864079 |
| | | MINI MCR-SL-1CP-I-I | 2864419 |
| | | MINI MCR-SL-UI-F | 2864082 |
| | | MINI MCR-SL-NAM-2RNO | 2864105 |
| MINI MCR-SL-UI-REL | 2864480 | | |
| MINI MCR-SL-SHUNT-UI | 2810858 | | |
| MINI MCR-SL-SHUNT-UI-NC | 2810780 | | |

Components required for system cabling

| Available 16-pos. VIP... round cables | | | V8 system adapter for MINI Analog |
|---------------------------------------|--------|-----------|--|
| Type | Length | Order No. | Type |
| VIP-CAB-FLK16/FR/FR/0,14/0,5M | 0.5 m | 2900154 | 2 x MINI MCR-SL-V8-FLK 16-A (in the catalog on page 94) |
| VIP-CAB-FLK16/FR/FR/0,14/1,0M | 1.0 m | 2900155 | |
| VIP-CAB-FLK16/FR/FR/0,14/2,0M | 2.0 m | 2900156 | |

VIP... round cables are available in special lengths on request.

VIP system cable

The new VIP cables provide a way of setting up secure and robust connections, even in harsh industrial environments.

Innovative concept

The MINI Analog system adapter does not just support system cabling on the input and output sides. It also allows cabling to be installed with LINETRAB surge protection modules quickly, easily, and without errors.

Increased protection

In addition to all the advantages associated with electrical isolation, filtering, amplification, and the conversion of standard analog signals using MINI Analog, there is now also the option of effective surge protection.

Surge protection

Surge protection is a reliable means of actively preventing and protecting against system damage and downtimes. LINETRAB is able to limit transient surge voltages safely and without affecting the signal - all in a compact device with a design width of just 6.2 mm.



VIP system cable



Innovative concept



Increased protection



Surge protection

Configuration aid for LINETRAB LIT - MINI Analog

Manual cabling

| LINETRAB LIT (surge protection) | | MINI Analog | |
|---|-----------|--------------------------------|-----------|
| Type | Order No. | Type | Order No. |
| LIT 1X2-24 | 2804610 | MINI MCR-SL-UI-UI | 2864383 |
| | | MINI MCR-SL-UI-UI-NC | 2864150 |
| | | MINI MCR-SL-UI-UI-SP | 2864710 |
| | | MINI MCR-SL-UI-UI-SP-NC | 2864163 |
| | | MINI MCR-SL-SHUNT-UI-SP | 2810874 |
| | | MINI MCR-SL-SHUNT-UI-SP-NC | 2810793 |
| | | MINI MCR-SL-U-UI-SP | 2811213 |
| | | MINI MCR-SL-U-UI-SP-NC | 2810078 |
| | | MINI MCR-SL-U-I-0-SP | 2813570 |
| | | MINI MCR-SL-U-I-4-SP | 2813583 |
| | | MINI MCR-SL-I-U-0-SP | 2813554 |
| | | MINI MCR-SL-I-U-4-SP | 2813567 |
| | | MINI MCR-SL-I-I-SP | 2864723 |
| | | MINI MCR-SL-U-U-SP | 2864697 |
| | | MINI MCR-SL-UI-2I-SP | 2864804 |
| | | MINI MCR-SL-UI-2I-SP-NC | 2864189 |
| | | MINI MCR-SL-RPS-I-I-SP | 2864752 |
| | | MINI MCR-SL-RPSS-I-I-SP | 2810230 |
| | | MINI MCR-SL-1CP-I-I-SP | 2864749 |
| | | LIT 2X2-24 | 2804623 |
| MINI MCR-SL-2CP-I-I-SP | 2864781 | | |
| LIT 2-12 (for 2-conductor connection technology) | 2804665 | MINI MCR-SL-PT100-UI-200 | 2864309 |
| | | MINI MCR-SL-PT100-UI-200-NC | 2864370 |
| | | MINI MCR-SL-PT100-UI-200-SP | 2864192 |
| | | MINI MCR-SL-PT100-UI-200-SP-NC | 2864202 |
| | | MINI MCR-SL-PT100-UI | 2864435 |
| | | MINI MCR-SL-PT100-UI-NC | 2864273 |
| | | MINI MCR-SL-PT100-UI-SP | 2864736 |
| | | MINI MCR-SL-PT100-UI-SP-NC | 2864286 |
| | | MINI MCR-SL-PT100-UI-LP | 2810298 |
| | | MINI MCR-SL-PT100-UI-LP-NC | 2810308 |
| | | MINI MCR-SL-PT100-UI-LP-SP | 2810382 |
| | | MINI MCR-SL-PT100-UI-LP-SP-NC | 2810395 |
| LIT 1X2-24 | 2804610 | MINI MCR-SL-UI-F-SP | 2810243 |
| | | MINI MCR-SL-NAM-2RNO-SP | 2810269 |
| | | MINI MCR-SL-UI-REL-SP | 2864493 |
| LIT 4-24 | 2804678 | MINI MCR-SL-R-UI | 2864095 |
| | | MINI MCR-SL-R-UI-SP | 2810256 |



Reliable and safe

MACX Analog - safe and high-performance signal isolating amplifiers. This product range enables you to safely isolate, condition, filter, and amplify all the signals of your system.

In all phases of the product life cycle, the MACX Analog range has been consistently developed and produced according to standards for functional safety. Save planning and operating costs – by combining high signal flexibility with safe isolation and SIL evaluation.

The universal nature of the product range provides you with a solution for all applications using analog signal transmission. You are free to choose between either multi-functional high-end devices or reasonably-priced standard modules with exactly the right functions.

Choose the right MACX Analog isolating amplifier for your application:

Analog IN/OUT

- Configurable 3-way isolating amplifiers
- Repeater power supplies with HART signal transmission for supplying 2-conductor transmitters
- Output isolating amplifiers with HART signal transmission

Temperature

- Universal temperature transducers for resistance thermometers, resistance-type sensors, potentiometers, thermocouples, and mV sources – also with safe limit value relays as an option
- Configurable temperature transducer for resistance thermometers and resistance-type sensors
- Configurable temperature transducer for thermocouples and mV sources

Digital IN

- Isolation amplifiers with input for NAMUR proximity sensor or switch
- Single-channel with PDT or passive transistor output
- Single-channel with double N/O contact output
- Two-channel with one N/O contact output per channel
- Two-channel with one PDT or passive transistor output per channel

Functional safety – from the initial idea to the finished product

Phoenix Contact meets the requirements of functional safety according to IEC 61508 in a standardized development process. Here, all fault avoidance and fault control measures are taken into consideration, from the very development and production

of a device right up to device operation. These measures are audited within the scope of a full assessment by an independent test center.

Phoenix Contact therefore makes a significant contribution to high system safety and availability.



DIN rail connector-compatible

The DIN rail connector enables the modular bridging of the 24 V supply voltage.



Wide-range power supply

The modules featuring a wide-range power supply (...-UP) can be used in all power supply networks the world over without the need for additional power supply units.



Safe and reliable functions

– Consistent SIL certification. This ensures the highest level of reliability and safety for your systems.



Precise transmission and high operational reliability

– Thanks to patented transmission concept



Easy configuration

– Without software via DIP switches on the device front or with the operator interface and display unit.

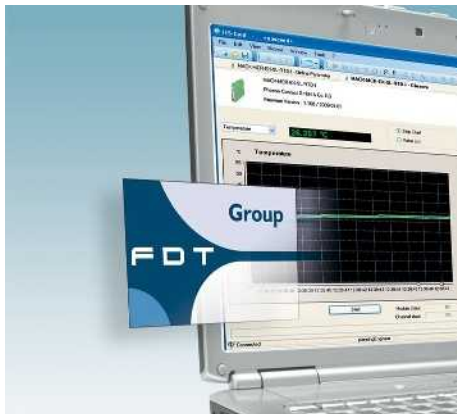

Easy configuration and monitoring

– Either via FDT/DTM or user-friendly stand-alone software – with integrated monitoring function.



Flexible power bridging

– The DIN rail connector simplifies wiring, system expansion or module replacement during operation.



Easy-maintenance connection technology

– Plug-in connection terminal blocks with screw connection or fast push-in technology – coded, with integrated sockets.

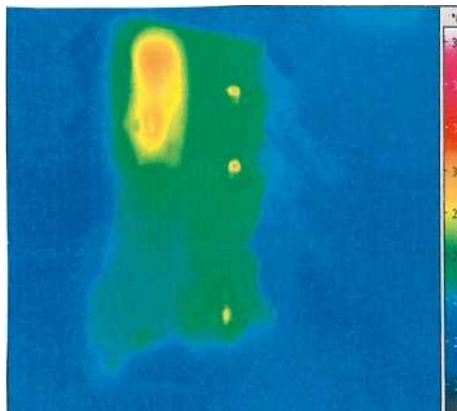

Precise transmission, long service life

– Patented circuit concepts ensure precise signal transmission and minimal self-heating.



Even for the Ex area

– Maximum explosion protection for all Ex zones with the MACX Analog Ex range.



Fast and error-free signal connection

– Compact termination carriers connect MACX Analog devices to the automation system – plug and play.

Analog IN / Analog OUT 3-way isolating amplifier

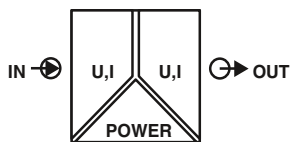

Ex n



SIL IEC 61508



**Universal,
more than 1600 signal combinations**

Functional safety
Ex: // Applied for: cUL / UL
Housing width 12.5 mm

Universal isolating amplifier for operating 4-conductor measuring transducers

- Analog isolating amplifier for isolating, filtering, amplifying, and converting standard analog signals
- Configurable input and output signals, including bipolar current and voltage signals
- 3-way electrical isolation
- Over 1600 signal conversions can be set via DIP switches on the front
- 10 kHz limit frequency for time-critical applications
- Output active or passive
- Plug-in capable screw or spring-cage connection method
- Power supply via DIN rail connector possible
- Status indicator for supply voltage
- Up to SIL 2 according to EN 61508
- Installation in zone 2 permissible

| Notes: |
|---|
| To order a product with an order configuration, enter the required configuration by referring to the adjacent order key. |
| Information about the supply and error evaluation module as well as about the DIN rail connectors and marking material can be found from page 126 |
| 1) EMC: Class A product, see page 571 |

| Input data |
|--|
| Input signal (configurable using the DIP switch) |
| Maximum input signal Input resistance |
| Output data |
| Output signal (configurable using the DIP switch) |
| Load R_B |
| General data |
| Supply voltage U_B Power dissipation Maximum transmission error Temperature coefficient ZERO / SPAN adjustment Limit frequency (3 dB) Step response (10 - 90%) |
| Electrical isolation |
| Degree of protection Ambient temperature (operation) Mounting Housing material Dimensions W / H / D Screw connection solid / stranded / AWG Spring-cage connection (solid/stranded/AWG) Conformance / approvals |
| Conformance ATEX IECEX UL, USA / Canada Functional safety (SIL) GL |

| Technical data | |
|--|--|
| U input | I input |
| 0 ... 10 V, please indicate if different setting when ordering | |
| ± 100 V Approx. 1 M Ω (± 1 V DC ... ± 100 V DC) | ± 100 mA Approx. 10 Ω (± 10 mA DC ... ± 100 mA DC) |
| U output | I output |
| 0 ... 20 mA, please indicate if different setting when ordering | |
| ≥ 1 k Ω (10 V) | ≤ 600 Ω (20 mA; active) (passive: $\leq (U_B - 2$ V) / I_{outmax}) |
| 12 V DC ... 24 V DC (-20% / +25%) < 0.7 W (at 24 V DC / 20 mA) $\leq 0.1\%$ (Compared to the final value) 0.0075%/K $\pm 4\%$ / $\pm 4\%$ 10 kHz (Can be switched to 30 Hz) 35 μ s (at 10 kHz) 11 ms (at 30 Hz) | 2.5 kV (50 Hz, 1 min., test voltage) 300 V _{rms} (Rated insulation voltage, surge voltage category II; pollution degree 2, safe isolation as per EN 61010, EN 50178) |
| IP20 -20°C ... 70°C Any PA 66-FR 12.5 / 99 / 114.5 mm 0.2 ... 2.5 mm ² / 0.2 ... 2.5 mm ² / 24 - 14 0.2 ... 1.5 mm ² / 0.2 ... 1.5 mm ² / 24 - 16 | CE-compliant II 3 G Ex nA IIC T4 Gc Ex nA IIC T4 Gc UL applied for SIL 2 - |

| Description |
|---|
| 3-way isolating amplifier , for electrical isolation of analog signals |
| Order configuration |
| Order configuration |
| Standard configuration |
| Standard configuration |

| Ordering data | | |
|------------------------------------|-----------|-------------|
| Type | Order No. | Pcs. / Pkt. |
| MACX MCR-UI-UI ¹⁾ | 2811284 | 1 |
| MACX MCR-UI-UI-SP ¹⁾ | 2811572 | 1 |
| MACX MCR-UI-UI-NC ¹⁾ | 2811446 | 1 |
| MACX MCR-UI-UI-SP-NC ¹⁾ | 2811556 | 1 |

Isolating amplifiers with SIL functional safety - MACX Analog

Order key for MACX MCR-UI-UI... (standard configuration entered as an example)

| Order No. | Input | Output | Limit frequency | Factory calibration certificate (FCC) | | | |
|------------------------|--|--|--|--|--|----------------------------|---|
| 2811284 | IN03 | OUT01 | 10K | NONE | | | |
| 2811284 ≙ ...-UI-UI | IN40 ≙ 0...50 mV IN24 ≙ 0...60 mV IN41 ≙ 0...75 mV IN25 ≙ 0...100 mV IN43 ≙ 0...120 mV IN44 ≙ 0...150 mV IN26 ≙ 0...200 mV IN27 ≙ 0...300 mV IN28 ≙ 0...500 mV IN66 ≙ 0...1000 mV IN29 ≙ 0...1.0 V IN50 ≙ 0...1.5 V IN30 ≙ 0...2.0 V IN52 ≙ 0...3.0 V IN05 ≙ 0...5 V IN03 ≙ 0...10 V IN67 ≙ 0...15 V IN32 ≙ 0...20 V IN39 ≙ 0...30 V IN68 ≙ 0...50 V IN69 ≙ 0...100 V IN06 ≙ 1...5 V IN04 ≙ 2...10 V | IN53 ≙ -50...+50 mV IN13 ≙ -60...+60 mV IN54 ≙ -75...+75 mV IN14 ≙ -100...+100 mV IN56 ≙ -120...+120 mV IN57 ≙ -150...+150 mV IN15 ≙ -200...+200 mV IN16 ≙ -300...+300 mV IN17 ≙ -500...+500 mV IN78 ≙ -1000...+1000 mV IN18 ≙ -1.0...+1.0 V IN63 ≙ -1.5...+1.5 V IN19 ≙ -2.0...+2.0 V IN65 ≙ -3.0...+3.0 V IN21 ≙ -5...+5 V IN22 ≙ -10...+10 V IN79 ≙ -15...+15 V IN23 ≙ -20...+20 V IN80 ≙ -30...+30 V IN81 ≙ -50...+50 V IN82 ≙ -100...+100 V | IN70 ≙ 0...1.0 mA IN71 ≙ 0...1.5 mA IN72 ≙ 0...2.0 mA IN73 ≙ 0...3.0 mA IN36 ≙ 0...5 mA IN37 ≙ 0...10 mA IN74 ≙ 0...15 mA IN01 ≙ 0...20 mA IN75 ≙ 0...30 mA IN76 ≙ 0...50 mA IN77 ≙ 0...100 mA IN83 ≙ -1.0...+1.0 mA IN84 ≙ -1.5...+1.5 mA IN85 ≙ -2.0...+2.0 mA IN86 ≙ -3.0...+3.0 mA IN33 ≙ -5...+5 mA IN34 ≙ -10...+10 mA IN87 ≙ -15...+15 mA IN35 ≙ -20...+20 mA IN88 ≙ -30...+30 mA IN89 ≙ -50...+50 mA IN90 ≙ -100...+100 mA IN91 ≙ 1...5 mA IN92 ≙ 2...10 mA IN02 ≙ 4...20 mA | OUT19 ≙ 0...2.5 V OUT05 ≙ 0...5 V OUT03 ≙ 0...10 V OUT20 ≙ -2.5...+2.5 V OUT13 ≙ -5...+5 V OUT14 ≙ -10...+10 V OUT24 ≙ 0.5...+2.5 V OUT06 ≙ 1...5 V OUT04 ≙ 2...10 V OUT27 ≙ 2.5...0 V OUT11 ≙ 5...0 V OUT09 ≙ 10...0 V | OUT15 ≙ 0...5 mA OUT16 ≙ 0...10 mA OUT01 ≙ 0...20 mA OUT21 ≙ -5...+5 mA OUT22 ≙ -10...+10 mA OUT23 ≙ -20...+20 mA OUT25 ≙ 1...5 mA OUT26 ≙ 2...10 mA OUT02 ≙ 4...20 mA OUT28 ≙ 5...0 mA OUT29 ≙ 10...0 mA OUT07 ≙ 20...0 mA | 30 ≙ 30 Hz 10K ≙ 10 kHz | NONE ≙ without FCC YES ≙ with FCC (a fee is charged) YESPLUS ≙ FCC with 5 measuring points (a fee is charged) |

Application example: level measurement and active analog input card



Application example: shunt measurement and Inline terminal with passive analog input channels within an Inline station



(Information on automation solutions from Phoenix Contact can be found in Catalog 8 or at www.phoenixcontact.net/products)

Analog IN / Analog OUT
3-way isolating amplifier

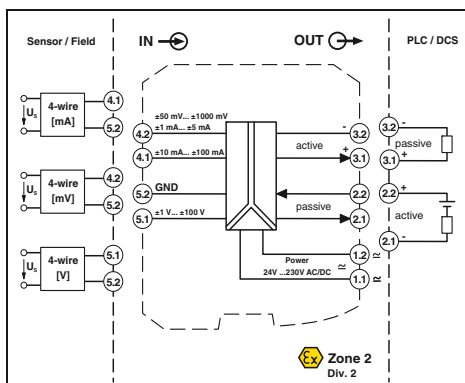

Ex n



Universal, more than 1600 signal combinations,
wide-range power supply



Functional safety

Ex: Ex, Ex, Ex

Housing width 12.5 mm

- Analog isolating amplifier for isolating, filtering, amplifying, and converting standard analog signals
- Configurable input and output signals, including bipolar current and voltage signals
- 3-way electrical isolation
- Over 1600 signal conversions can be set via DIP switches on the front
- Output active or passive
- Plug-in capable screw or spring-cage connection method
- Wide-range power supply: 19.2 ... 253 V AC/DC
- Status indicator for supply voltage
- Up to SIL 2 according to EN 61508
- Installation in zone 2 permissible

Notes:
To order a product with an order configuration, enter the required configuration by referring to the adjacent order key.
1) EMC: Class A product, see page 571

| | |
|---|---|
| Input data | Input signal (configurable using the DIP switch) |
| Maximum input signal | |
| Input resistance | |
| Output data | Output signal (configurable using the DIP switch) |
| Maximum output signal | |
| Load R _B | |
| General data | Supply voltage U _B |
| | Power dissipation |
| Maximum transmission error | |
| Temperature coefficient | |
| ZERO / SPAN adjustment | |
| Electrical isolation | Input/output/power supply |
| Degree of protection | |
| Ambient temperature (operation) | |
| Housing material | |
| Dimensions W / H / D | |
| Screw connection solid / stranded / AWG | |
| Spring-cage connection (solid/stranded/AWG) | |
| Conformance / approvals | |
| Conformance | |
| ATEX | |
| IECEX | |
| UL, USA / Canada | |
| Functional safety (SIL) | |
| GL | |

Technical data

| | |
|--|---|
| U input | I input |
| 0 ... 10 V, please indicate if different setting when ordering | |
| ±100 V | ±100 mA |
| Approx. 1 MΩ | Approx. 10 Ω |
| (±1 V DC ... ±100 V DC) | (±10 mA DC ... ±100 mA DC) |
| U output | I output |
| 0 ... 20 mA, configurable via DIP switches | |
| 15 V | 35 mA |
| ≥ 1 kΩ (10 V) | ≤ 600 Ω (20 mA; active) |
| | (passive: ≤ (U _B -2 V) / I _{outmax}) |
| 24 V ... 230 V AC/DC (-20%/+10%, 50/60 Hz) | |
| < 0.8 W (at 24 V DC / 20 mA) | |
| < 0.9 W (At 230 V AC / 20 mA) | |
| ≤ 0.1% (Compared to the final value) | |
| 0.0075%/K | |
| ±4% / ±4% | |
| 2.5 kV (50 Hz, 1 min., test voltage) | |
| 300 V _{rms} (Rated insulation voltage, surge voltage category II; pollution degree 2, safe isolation as per EN 61010, EN 50178) | |
| IP20 | |
| -20°C ... 70°C | |
| PA 66-FR | |
| 12.5 / 99 / 114.5 mm | |
| 0.2 ... 2.5 mm ² / 0.2 ... 2.5 mm ² / 24 - 14 | |
| 0.2 ... 1.5 mm ² / 0.2 ... 1.5 mm ² / 24 - 16 | |
| CE-compliant | |
| Ex II 3 G Ex nA IIC T4 Gc | |
| Ex nA IIC T4 Gc | |
| - | |
| SIL 2 | |
| - | |

Ordering data

| | | | | |
|--|------------------------|---|------------------|--------------------|
| Description | | Type | Order No. | Pcs. / Pkt. |
| 3-way isolating amplifier , for electrical isolation of analog signals with long-range power supply | | | | |
| Order configuration | Screw connection | MACX MCR-UI-UI-UP¹⁾ | 2811459 | 1 |
| Order configuration | Spring-cage connection | MACX MCR-UI-UI-UP-SP¹⁾ | 2811585 | 1 |
| Standard configuration | Screw connection | MACX MCR-UI-UI-UP-NC¹⁾ | 2811297 | 1 |
| Standard configuration | Spring-cage connection | MACX MCR-UI-UI-UP-SP-NC¹⁾ | 2811569 | 1 |

Isolating amplifiers with SIL functional safety - MACX Analog

Order key for MACX MCR-UI-UI-... (standard configuration entered as an example)

| Order No. | Input | Output | Limit frequency | Factory calibration certificate (FCC) | | | |
|---------------------------|--|--|--|--|--|----------------------------|---|
| 2811459 | IN03 | OUT01 | 10K | NONE | | | |
| 2811459 ≙ ...-UI-UI-UP | IN40 ≙ 0...50 mV IN24 ≙ 0...60 mV IN41 ≙ 0...75 mV IN25 ≙ 0...100 mV IN43 ≙ 0...120 mV IN44 ≙ 0...150 mV IN26 ≙ 0...200 mV IN27 ≙ 0...300 mV IN28 ≙ 0...500 mV IN66 ≙ 0...1000 mV IN29 ≙ 0...1.0 V IN50 ≙ 0...1.5 V IN30 ≙ 0...2.0 V IN52 ≙ 0...3.0 V IN05 ≙ 0...5 V IN03 ≙ 0...10 V IN67 ≙ 0...15 V IN32 ≙ 0...20 V IN39 ≙ 0...30 V IN68 ≙ 0...50 V IN69 ≙ 0...100 V IN06 ≙ 1...5 V IN04 ≙ 2...10 V | IN53 ≙ -50...+50 mV IN13 ≙ -60...+60 mV IN54 ≙ -75...+75 mV IN14 ≙ -100...+100 mV IN56 ≙ -120...+120 mV IN57 ≙ -150...+150 mV IN15 ≙ -200...+200 mV IN16 ≙ -300...+300 mV IN17 ≙ -500...+500 mV IN78 ≙ -1000...+1000 mV IN18 ≙ -1.0...+1.0 V IN63 ≙ -1.5...+1.5 V IN19 ≙ -2.0...+2.0 V IN65 ≙ -3.0...+3.0 V IN21 ≙ -5...+5 V IN22 ≙ -10...+10 V IN79 ≙ -15...+15 V IN23 ≙ -20...+20 V IN80 ≙ -30...+30 V IN81 ≙ -50...+50 V IN82 ≙ -100...+100 V | IN70 ≙ 0...1.0 mA IN71 ≙ 0...1.5 mA IN72 ≙ 0...2.0 mA IN73 ≙ 0...3.0 mA IN36 ≙ 0...5 mA IN37 ≙ 0...10 mA IN74 ≙ 0...15 mA IN01 ≙ 0...20 mA IN75 ≙ 0...30 mA IN76 ≙ 0...50 mA IN77 ≙ 0...100 mA IN83 ≙ -1.0...+1.0 mA IN84 ≙ -1.5...+1.5 mA IN85 ≙ -2.0...+2.0 mA IN86 ≙ -3.0...+3.0 mA IN33 ≙ -5...+5 mA IN34 ≙ -10...+10 mA IN87 ≙ -15...+15 mA IN35 ≙ -20...+20 mA IN88 ≙ -30...+30 mA IN89 ≙ -50...+50 mA IN90 ≙ -100...+100 mA IN91 ≙ 1...5 mA IN92 ≙ 2...10 mA IN02 ≙ 4...20 mA | OUT19 ≙ 0...2.5 V OUT05 ≙ 0...5 V OUT03 ≙ 0...10 V OUT20 ≙ -2.5...+2.5 V OUT13 ≙ -5...+5 V OUT14 ≙ -10...+10 V OUT24 ≙ 0.5...+2.5 V OUT06 ≙ 1...5 V OUT04 ≙ 2...10 V OUT27 ≙ 2.5...0 V OUT11 ≙ 5...0 V OUT09 ≙ 10...0 V | OUT15 ≙ 0...5 mA OUT16 ≙ 0...10 mA OUT01 ≙ 0...20 mA OUT21 ≙ -5...+5 mA OUT22 ≙ -10...+10 mA OUT23 ≙ -20...+20 mA OUT25 ≙ 1...5 mA OUT26 ≙ 2...10 mA OUT02 ≙ 4...20 mA OUT28 ≙ 5...0 mA OUT29 ≙ 10...0 mA OUT07 ≙ 20...0 mA | 30 ≙ 30 Hz 10K ≙ 10 kHz | NONE ≙ without FCC YES ≙ with FCC (a fee is charged) YESPLUS ≙ FCC with 5 measuring points (a fee is charged) |

Application example: level measurement and active analog input card



Application example: shunt measurement and Inline terminal with analog input channels within an Inline station



(Information on automation solutions from Phoenix Contact can be found in Catalog 8 or at www.phoenixcontact.net/products)

Analog IN / Analog OUT
repeater power supplies

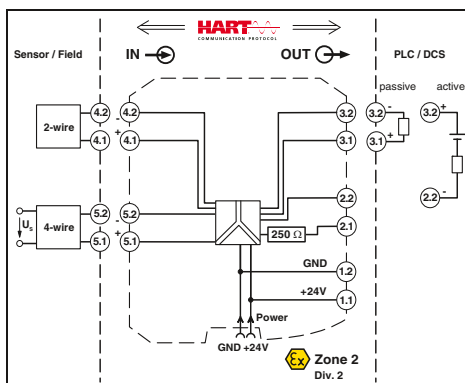

Ex n



Repeater power supply and input isolating amplifier

Functional safety
Ex: Ex
Housing width 12.5 mm

Repeater power supply and input isolating amplifier for the operation of 2-conductor measuring transducers, 4-conductor measuring transducers, and mA current sources

- Input 0/4...20 mA (feeding or non-feeding)
- 0/4...20 mA output (active or passive)
- Bidirectional transmission of digital HART communication signals
- Plug-in capable screw or spring-cage connection method, with integrated sockets for HART communicators
- Terminal point with 250 Ω resistor to increase the HART impedance in the case of low-impedance systems
- 3-way electrical isolation
- Power supply via DIN rail connector possible
- Up to SIL 2 according to EN 61508
- Installation in zone 2 permitted

| Notes: |
|---|
| Information about the supply and error evaluation module as well as about the DIN rail connectors and marking material can be found from page 126 |
| Test plugs for test sockets can be found on page 191 |
| Information on "Plug and play" connection using system cabling can be found from page 128 |
| 1) EMC: Class A product, see page 571 |

| | |
|---|---------------------------|
| Input data | |
| Input signal | |
| Transmitter supply voltage | |
| Voltage drop | |
| Output data | |
| Output signal | |
| Load | |
| Output ripple | |
| General data | |
| Supply voltage range | |
| Current consumption | |
| Power dissipation | |
| Temperature coefficient | |
| Step response (10 - 90%) | |
| Transmission error, typical | |
| Maximum transmission error | |
| Under-/overload range | |
| Electrical isolation | Input/output/power supply |
| Ambient temperature range | |
| Status indication | |
| SMART communication | |
| Signal bandwidth | |
| Protocols supported | |
| Housing material | |
| Dimensions W / H / D | |
| Screw connection solid / stranded / AWG | |
| Spring-cage connection (solid/stranded/AWG) | |
| Conformance / approvals | |
| Conformance | |
| ATEX | |
| UL, USA / Canada | |
| Functional safety (SIL) | |

| Technical data | | |
|--|--------------------|---|
| 0 mA ... 20 mA / 4 mA ... 20 mA | | |
| > 16 V (at 20 mA) | | |
| < 3.5 V (in input isolating amplifier operation) | | |
| 0 mA ... 20 mA (active) | | |
| 4 mA ... 20 mA (active) | | |
| 0 mA ... 20 mA (14 ... 26 V ext. source voltage) | | |
| 4 mA ... 20 mA (14 ... 26 V ext. source voltage) | | |
| < 600 Ω | | |
| < 20 mV _{rms} | | |
| 19.2 V DC ... 30 V DC | | |
| < 60 mA (at 24 V DC) | | |
| < 1.1 W (at 24 V DC / 20 mA) | | |
| < 0.01%/K | | |
| < 600 μs (for 4 mA ... 20 mA step) | | |
| < 0.05% (of final value) | | |
| < 0.1% (of final value) | | |
| as per NE 43 | | |
| 2.5 kV (50 Hz, 1 min., test voltage) | | |
| 300 V _{rms} (Rated insulation voltage, surge voltage category II; pollution degree 2, safe isolation as per EN 61010, EN 50178) | | |
| -20°C ... 60°C (Any mounting position) | | |
| Green LED (supply voltage) | | |
| Yes | | |
| as per HART specifications | | |
| HART | | |
| PA 66-FR | | |
| 12.5 / 99 / 114.5 mm | | |
| 0.2 ... 2.5 mm ² / 0.2 ... 2.5 mm ² / 24 - 14 | | |
| 0.2 ... 1.5 mm ² / 0.2 ... 1.5 mm ² / 24 - 16 | | |
| CE-compliant, additionally EN 61326 | | |
| Ex II 3 G Ex nA IIC T4 Gc X | | |
| UL applied for | | |
| SIL 2 according to EN 61508 | | |
| Ordering data | | |
| Type | Order No. | |
| | Pcs. / Pkt. | |
| MACX MCR-SL-RPSSI-I1) | 2865955 | 1 |
| MACX MCR-SL-RPSSI-I-SP1) | 2924207 | 1 |

| Description |
|---|
| Repeater power supply, with HART® protocol |
| Screw connection |
| Spring-cage conn. |

Analog IN / Analog OUT
repeater power supplies

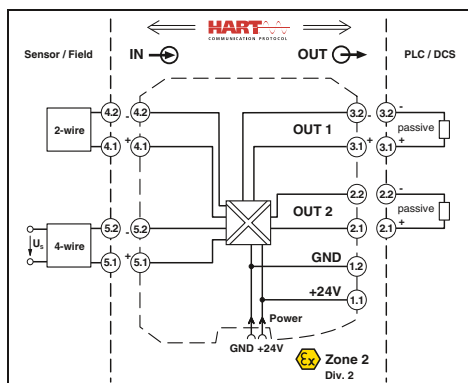
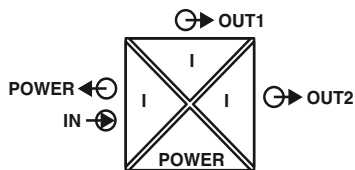

Repeater power supply and input isolating amplifier, with two electrically isolated outputs

Functional safety
Ex:
Housing width 12.5 mm

Repeater power supply and input isolating amplifier for the operation of 2-conductor measuring transducers, 4-conductor measuring transducers, and mA current sources

- Input 0/4...20 mA (feeding or non-feeding)
- Two electrically isolated 0/4 ... 20 mA (active) outputs
- Bidirectional transmission of digital HART communication signals (both outputs)
- Plug-in capable screw or spring-cage connection method, with integrated sockets for HART communicators
- 4-way electrical isolation
- Power supply via DIN rail connector possible
- Up to SIL 2 according to EN 61508
- Installation in zone 2 permitted

| | |
|---|--|
| Input data | |
| Input signal | |
| Transmitter supply voltage | |
| Voltage drop | |
| Output data | |
| Output signal (Per output) | |
| Load | |
| Output ripple | |
| General data | |
| Supply voltage range | |
| Current consumption | |
| Power dissipation | |
| Temperature coefficient | |
| Step response (10 - 90%) | |
| Transmission error, typical | |
| Maximum transmission error | |
| Under-/overload range | |
| Electrical isolation | |
| Input/output/power supply | |
| Ambient temperature range | |
| Status indication | |
| SMART communication (Per output) | |
| Protocols supported | |
| Housing material | |
| Dimensions W / H / D | |
| Screw connection solid / stranded / AWG | |
| Spring-cage connection (solid/stranded/AWG) | |
| Conformance / approvals | |
| Conformance | |
| ATEX | |
| Functional safety (SIL) | |

| Technical data | |
|--|--|
| 4 mA ... 20 mA / 0 mA ... 20 mA | |
| > 21.5 V (at 20 mA) | |
| < 3.9 V (in input isolating amplifier operation) | |
| 0 mA ... 20 mA (active) | |
| 4 mA ... 20 mA (active) | |
| < 450 Ω (at 20 mA) | |
| < 20 mV _{rms} | |
| 19.2 V DC ... 30 V DC (24 V DC (-20% ... +25%)) | |
| < 75 mA (at 24 V DC) | |
| < 1.45 W (at 24 V DC / 20 mA) | |
| < 0.01%/K | |
| < 1.3 ms (for 4 mA ... 20 mA step) | |
| < 0.05% (of final value) | |
| < 0.1% (of final value) | |
| as per NE 43 | |
| 2.5 kV (50 Hz, 1 min., test voltage) | |
| 300 V _{rms} (Rated insulation voltage, surge voltage category II; pollution degree 2, safe isolation as per EN 61010, EN 50178) | |
| 1.5 kV AC (50 Hz, 1 min., test voltage) | |
| -20°C ... 60°C (Any mounting position) | |
| Green LED (PWR supply voltage) | |
| Yes | |
| HART | |
| PA 66-FR | |
| 12.5 / 99 / 114.5 mm | |
| 0.2 ... 2.5 mm ² / 0.2 ... 2.5 mm ² / 24 - 14 | |
| 0.2 ... 1.5 mm ² / 0.2 ... 1.5 mm ² / 24 - 16 | |
| CE-compliant, additionally EN 61326 | |
| II 3 G Ex nA IIC T4 Gc X | |
| SIL 2 according to EN 61508 | |

| |
|---|
| Notes: |
| Information about the supply and error evaluation module as well as about the DIN rail connectors and marking material can be found from page 126 |
| Test plugs for test sockets can be found on page 191 |
| Information on "Plug and play" connection using system cabling can be found from page 128 |
| 1) EMC: Class A product, see page 571 |

| Ordering data | | |
|---------------------------|-----------|-------------|
| Type | Order No. | Pcs. / Pkt. |
| MACX MCR-SL-RPSSI-2I1) | 2924825 | 1 |
| MACX MCR-SL-RPSSI-2I-SP1) | 2924838 | 1 |

| |
|--|
| Description |
| Repeater power supply, with HART® protocol |
| Screw connection |
| Spring-cage conn. |

Analog IN / Analog OUT repeater power supplies

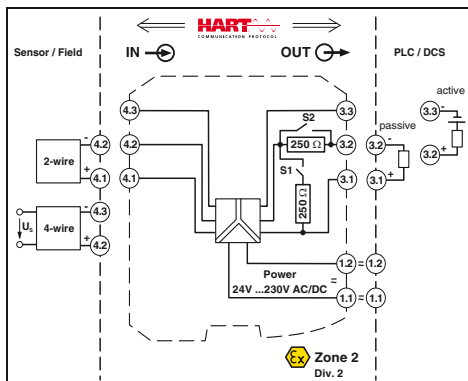

Ex n



Repeater power supply and input isolating amplifier, wide-range power supply

Functional safety

Ex: Ex

Housing width 17.5 mm

Technical data

Repeater power supply and input isolating amplifier for the operation of 2-conductor measuring transducers, 4-conductor measuring transducers, and mA current sources

- Input 0/4...20 mA (feeding or non-feeding)
- Output 0/4...20 mA (active or passive), 0/1...5 V, can be switched via the DIP switch
- Bidirectional transmission of digital HART communication signals
- Plug-in capable screw or spring-cage connection method, with integrated sockets for HART communicators
- 250 Ω resistor that can be activated via DIP switches to increase the HART impedance in the case of low-impedance systems
- 3-way electrical isolation
- Wide-range power supply: 19.2 ... 253 V AC/DC
- Up to SIL 2 according to EN 61508
- Installation in zone 2 permitted

Input data

Input signal
Transmitter supply voltage
Voltage drop

Output data

Output signal

Load

Output ripple

General data

Supply voltage range
Current consumption
Power dissipation
Temperature coefficient
Step response (10 - 90%)
Transmission error, typical
Maximum transmission error
Under-/overload range
Electrical isolation

Input/output/power supply

Ambient temperature range

Status indication

SMART communication

Signal bandwidth

Protocols supported

Housing material

Dimensions W / H / D

Screw connection solid / stranded / AWG

Spring-cage connection (solid/stranded/AWG)

Conformance / approvals

Conformance

ATEX

UL, USA / Canada

Functional safety (SIL)

0 mA ... 20 mA / 4 mA ... 20 mA
> 16 V (at 20 mA)
< 3.5 V (in input isolating amplifier operation)

0 mA ... 20 mA (active)
4 mA ... 20 mA (active)
0 mA ... 20 mA (14 ... 26 V ext. source voltage)
4 mA ... 20 mA (14 ... 26 V ext. source voltage)
0 V ... 5 V (internal resistance, 250 Ω, 0.1%)
1 V ... 5 V (internal resistance, 250 Ω, 0.1%)
< 600 Ω (I output)
< 20 mV_{rms}

24 V ... 230 V AC/DC (-20%/+10%, 50/60 Hz)
< 75 mA (at 24 V DC)
< 1.8 W
< 0.01%/K
< 600 μs (for 4 mA ... 20 mA step)
< 0.05% (of final value)
< 0.1% (of final value)
as per NE 43

2.5 kV (50 Hz, 1 min., test voltage)
300 V_{rms} (Rated insulation voltage, surge voltage category II; pollution degree 2, safe isolation as per EN 61010, EN 50178)

-20°C ... 60°C (Any mounting position)

Green LED (supply voltage)

Yes

as per HART specifications

HART

PA 66-FR

17.5 / 99 / 114.5 mm

0.2 ... 2.5 mm² / 0.2 ... 2.5 mm² / 24 - 14

0.2 ... 1.5 mm² / 0.2 ... 1.5 mm² / 24 - 16

CE-compliant, additionally EN 61326

Ex II 3 G Ex nA IIC T4 Gc X

UL applied for

SIL 2 according to EN 61508

Notes:

Information about the supply and error evaluation module as well as about the DIN rail connectors and marking material can be found from page 126

Test plugs for test sockets can be found on page 191

1) EMC: Class A product, see page 571

Ordering data

Description

Repeater power supply, with HART® protocol

Screw connection
Spring-cage conn.

Type

MACX MCR-SL-RPSSH-UP¹)
MACX MCR-SL-RPSSI-I-UP-SP¹)

Order No.

2865968
2924210

Pcs. / Pkt.

1
1

Analog OUT
output isolating amplifier

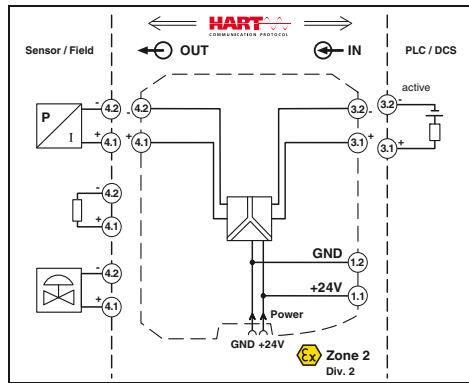
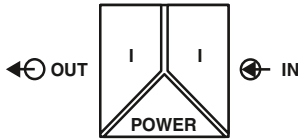

Functional safety
Ex:
Housing width 12.5 mm

Output isolating amplifier for controlling I/P transducers, control valves, and displays

- 0/4 ... 20 mA input
- 0/4 ... 20 mA output
- Bidirectional transmission of digital HART communication signals
- Plug-in capable screw or spring-cage connection method, with integrated sockets for HART communicators
- Line fault detection (LF)
- 3-way electrical isolation
- Power supply via DIN rail connector possible
- Up to SIL 2 according to EN 61508
- Installation in zone 2 permitted

| |
|---|
| Notes: |
| Information about the supply and error evaluation module as well as about the DIN rail connectors and marking material can be found from page 126 |
| Test plugs for test sockets can be found on page 191 |
| Information on "Plug and play" connection using system cabling can be found from page 128 |
| 1) EMC: Class A product, see page 571 |

| | |
|--|--|
| Input data | Input signal Input voltage Input impedance in the event of a cable break at the output |
| Output data | Output signal Load Output ripple |
| General data | Supply voltage range Current consumption Power dissipation Temperature coefficient Step response (10 - 90%) Maximum transmission error Electrical isolation |
| Input/output/power supply | 1.5 kV (50 Hz, 1 min., test voltage) 300 V _{rms} (Rated insulation voltage, surge voltage category II; pollution degree 2, safe isolation as per EN 61010, EN 50178) |
| Ambient temperature range | -20°C ... 60°C (Any mounting position) |
| Humidity | 10% ... 95% (no condensation) |
| SMART communication | Yes |
| Signal bandwidth | as per HART specifications |
| Protocols supported | HART |
| Housing material | PA 66-FR |
| Inflammability class according to UL 94 | V0 |
| Dimensions W / H / D | 12.5 / 99 / 114.5 mm |
| Screw connection solid / stranded / AWG | 0.2 ... 2.5 mm ² / 0.2 ... 2.5 mm ² / 24 - 14 |
| Spring-cage connection (solid/stranded/AWG) | 0.2 ... 1.5 mm ² / 0.2 ... 1.5 mm ² / 24 - 16 |
| Conformance / approvals | CE-compliant, additionally EN 61326 II 3 G Ex nA IIC T4 Gc X SIL 2 according to EN 61508 |
| Conformance | |
| ATEX | |
| Functional safety (SIL) | |

Technical data

| | |
|--|--|
| Input data | 0 mA ... 20 mA / 4 mA ... 20 mA 5.4 V (at 20 mA) > 100 kΩ (if there is a line fault) |
| Output data | 0 mA ... 20 mA / 4 mA ... 20 mA < 800 Ω (at 20 mA) < 20 mV _{rms} |
| General data | 19.2 V DC ... 30 V DC < 46 mA (at 24 V DC / 20 mA) < 1.1 W (at 24 V DC / 20 mA) < 0.01%/K < 140 μs < 0.1% (of final value) |
| Input/output/power supply | 1.5 kV (50 Hz, 1 min., test voltage) 300 V _{rms} (Rated insulation voltage, surge voltage category II; pollution degree 2, safe isolation as per EN 61010, EN 50178) |
| Ambient temperature range | -20°C ... 60°C (Any mounting position) |
| Humidity | 10% ... 95% (no condensation) |
| SMART communication | Yes |
| Signal bandwidth | as per HART specifications |
| Protocols supported | HART |
| Housing material | PA 66-FR |
| Inflammability class according to UL 94 | V0 |
| Dimensions W / H / D | 12.5 / 99 / 114.5 mm |
| Screw connection solid / stranded / AWG | 0.2 ... 2.5 mm ² / 0.2 ... 2.5 mm ² / 24 - 14 |
| Spring-cage connection (solid/stranded/AWG) | 0.2 ... 1.5 mm ² / 0.2 ... 1.5 mm ² / 24 - 16 |
| Conformance / approvals | CE-compliant, additionally EN 61326 II 3 G Ex nA IIC T4 Gc X SIL 2 according to EN 61508 |
| Conformance | |
| ATEX | |
| Functional safety (SIL) | |

Ordering data

| Description | Type | Order No. | Pcs. / Pkt. |
|-----------------------------------|-------------------|--|-------------|
| Output isolating amplifier | | | |
| | Screw connection | MACX MCR-SL-IDS-I¹⁾ | 1 |
| | Spring-cage conn. | MACX MCR-SL-IDS-I-SP¹⁾ | 1 |

Temperature Temperature transducer

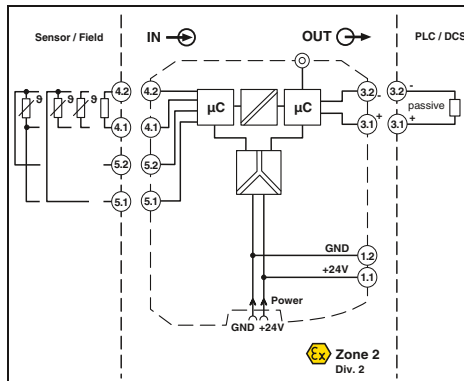
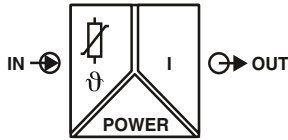

For resistance thermometers and resistance-type sensors



Housing width 12.5 mm

Programmable temperature transducer for operating resistance thermometers and resistance-type sensors. The measured values are converted into a linear 0 ... 20 mA or 4 ... 20 mA signal.

- Input for resistance thermometers and resistance-type sensors
- 0 ... 20 mA or 4 ... 20 mA output
- Configuration via software (FDT/DTM): Sensor type, connection method, measuring range, measuring unit, filter, alarm signal, and output range
- Programming during operation and also voltage-free using IFS-USB-PROG-ADAPTER programming adapter
- Status indicator for supply voltage, cable, sensor, and module errors
- 3-way electrical isolation
- Power supply via DIN rail connector possible
- Up to SIL 2 according to EN 61508
- Installation in zone 2 permitted

Input data

Resistance thermometers
Resistor
Cable resistance
Sensor input current
Measuring range span

Output data

Output signal
Load
Behavior in the event of a sensor error
Output ripple

General data

Supply voltage range
Current consumption
Power dissipation
Temperature coefficient
Step response (0 - 99%)

Transmission error, total

ZERO / SPAN adjustment
Electrical isolation

Input/output/power supply

Ambient temperature range
Humidity
Housing material
Inflammability class according to UL 94
Dimensions W / H / D
Screw connection solid / stranded / AWG
Spring-cage connection (solid/stranded/AWG)

Conformance / approvals

Conformance
ATEX
Functional safety (SIL)

Technical data

Pt, Ni, Cu sensors: 2, 3, 4-conductor
0 Ω ... 2000 Ω
50 Ω per line
(200 µA ... 1 mA)
min. 50 K

0 mA ... 20 mA / 4 mA ... 20 mA

≤ 500 Ω

As per NE 43 or can be freely defined

< 50 µA_{PP}

19.2 V DC ... 30 V DC

< 40 mA (24 V DC)

< 1 W

0.01%/K

Typ. 800 ms (With SIL)

max. 1200 ms (With SIL)

Typ. 700 ms (Without SIL)

max. 1100 ms (Without SIL)

0.05% x 100 [K] / measuring range span [K] + 0.05%

±5% / ±5%

2.5 kV (50 Hz, 1 min., test voltage)

300 V_{ins} (Rated insulation voltage, surge voltage category II; pollution degree 2, safe isolation as per EN 61010, EN 50178)

-20°C ... 60°C (Any mounting position)

5% ... 95% (no condensation)

PA 66-FR

V0

12.5 / 99 / 114.5 mm

0.2 ... 2.5 mm² / 0.2 ... 2.5 mm² / 24 - 14

0.2 ... 1.5 mm² / 0.2 ... 1.5 mm² / 24 - 16

CE-compliant, additionally EN 61326

Ex II 3 G Ex nA ic IIC T4 Gc X

SIL 2 according to EN 61508

Ordering data

| Type | Order No. | Pcs. / Pkt. |
|---------------------------------------|-----------|-------------|
| MACX MCR-SL-RTD-I ¹⁾ | 2865065 | 1 |
| MACX MCR-SL-RTD-I-SP ¹⁾ | 2924317 | 1 |
| MACX MCR-SL-RTD-I-NC ¹⁾ | 2865078 | 1 |
| MACX MCR-SL-RTD-I-SP-NC ¹⁾ | 2924320 | 1 |

Accessories

| | | |
|------------------------------------|---------|---|
| IFS-USB-PROG-ADAPTER ¹⁾ | 2811271 | 1 |
|------------------------------------|---------|---|

| |
|--|
| Notes: |
| To order a product with an order configuration, enter the required configuration by referring to the adjacent order key. |
| The configuration software can be downloaded from the Internet (www.phoenixcontact.net/products). |
| Information about the supply and error evaluation module as well as about the DIN rail connectors and marking material can be found from page 126 |
| For information on the programming adapter, refer to page 119 |
| Test plugs for test sockets can be found on page 191 |
| Information on "Plug and play" connection using system cabling can be found from page 128 |
| 1) EMC: Class A product, see page 571 |

Description

Temperature transducer

| | |
|------------------------|-------------------|
| Order configuration | Screw connection |
| Order configuration | Spring-cage conn. |
| Standard configuration | Screw connection |
| Standard configuration | Spring-cage conn. |

Programming adapter for configuring modules with S-PORT interface

Order key and temperature ranges for MACX-MCR-SL-RTD-I(-SP) temperature transducer

Order key for MACX-MCR-SL-RTD-I(-SP) temperature transducer (standard configuration entered as an example)

| Order No. | Sensor type | Safety integrity level (SIL) | Connection technology | Measuring range: | | Measuring unit | Output range | Filter Oversampling | Filter Moving average value |
|---|--------------|-----------------------------------|---|--------------------------------------|------------|---------------------------|--|---|---|
| | | | | Start | End | | | | |
| 2865065 | PT100 | ON | 3 | 0 | 100 | C | OUT02 | 10 | 1 |
| 2865065 ≙ MACX MCR-SL-RTD-I | see below | ON ≙ active NONE ≙ not active | 2 ≙ 2-conductor 3 ≙ 3-conductor 4 ≙ 4-conductor | see below | see below | C ≙ °C F ≙ °F O ≙ Ω | OUT01 ≙ 0...20 mA OUT02 ≙ 4...20 mA | 1 ≙ 1 value 3 ≙ 3 values 5 ≙ 5 values 7 ≙ 7 values 10 ≙ 10 values 20 ≙ 20 values | 1 ≙ 1 value 2 ≙ 2 values 3 ≙ 3 values 4 ≙ 4 values |
| 2924317 ≙ MACX MCR-SL-RTD-I-SP | | ON only with output range = OUT02 | | | | | | | |
| | | | | Smallest measuring range span | | | | | |
| RES01 ≙ Resistor | | | | 0 | 2000 | Ω | 25 Ω | | |
| PT50 ≙ Pt 50 acc. to IEC 751 | | | | -200 | 850 | °C | 50 K | | |
| PT100 ≙ Pt 100 acc. to IEC 751 | | | | -200 | 850 | °C | 50 K | | |
| PT200 ≙ Pt 200 acc. to IEC 751 | | | | -200 | 850 | °C | 50 K | | |
| PT500 ≙ Pt 500 acc. to IEC 751 | | | | -200 | 850 | °C | 50 K | | |
| PT100S ≙ Pt 100 acc. to Sama RC21-4-1966 | | | | -200 | 600 | °C | 50 K | | |
| PT500S ≙ Pt 500 acc. to Sama RC21-4-1966 | | | | -200 | 600 | °C | 50 K | | |
| NI100DIN ≙ Ni 100 acc. to DIN 43760 | | | | -60 | 250 | °C | 50 K | | |
| NI500DIN ≙ Ni 500 acc. to DIN 43760 | | | | -60 | 250 | °C | 50 K | | |
| CU50 ≙ Cu 50 acc. to GOST 6651-2009 (α = 0.00428) | | | | -50 | 200 | °C | 50 K | | |
| CU53 ≙ Cu 53 acc. to GOST 6651-2009 (α = 0.00426) | | | | -50 | 180 | °C | 50 K | | |

Alarm signal

Short circuit/
overrange

Alarm signal

Sensor break/
underrange

Factory calibration certificate = FCC

| I035 | I215 | NONE | Temperature conversion guide for °C to °F: $T [°F] = \frac{9}{5} T [°C] + 32$ |
|--|--|---|--|
| I000 ≙ 0 mA I035 ≙ 3.5 mA I215 ≙ 21.5 mA I035 only with output range = OUT02 Alarm signals can also be configured individually using software. | I000 ≙ 0 mA I035 ≙ 3.5 mA I215 ≙ 21.5 mA | NONE ≙ without FCC YES ≙ with FCC (a fee is charged) YESPLUS ≙ FCC with 5 measuring points (a fee is charged) | |

Temperature Temperature transducer

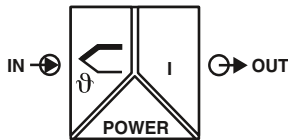

Ex n



For thermocouples and mV sources



Housing width 12.5 mm

Programmable temperature transducer for operating thermocouples and mV sources. The measured values are converted into a linear 0 ... 20 or 4 ... 20 mA signal.

- Input for thermocouples and mV sources
- 0 ... 20 mA or 4 ... 20 mA output
- Configuration via software (FDT/DTM): Sensor type, connection method, measuring range, measuring unit, filter, alarm signal, and output range
- Programming during operation and also voltage-free using IFS-USB-PROG-ADAPTER programming adapter
- Status indicator for supply voltage, cable, sensor, and module errors
- 3-way electrical isolation
- Power supply via DIN rail connector possible
- Up to SIL 2 according to EN 61508
- Installation in zone 2 permitted

| Notes: |
|--|
| To order a product with an order configuration, enter the required configuration by referring to the adjacent order key. |
| The configuration software can be downloaded from the Internet (www.phoenixcontact.net/products). |
| Information about the supply and error evaluation module as well as about the DIN rail connectors and marking material can be found from page 126 |
| For information on the programming adapter, refer to page 119 |
| Information on "Plug and play" connection using system cabling can be found from page 128 |
| 1) EMC: Class A product, see page 571 |

| | |
|--|--|
| Input data | Thermocouple sensors |
| Voltage | -20 mV ... 70 mV |
| Measuring range span | (Min. 50 K for thermocouples, 3 mV for mV sources) |
| Output data | 0 mA ... 20 mA / 4 mA ... 20 mA |
| Output signal | max. 500 Ω |
| Load | As per NE 43 or can be freely defined |
| Behavior in the event of a sensor error | < 50 µA _{pp} |
| Output ripple | |
| General data | |
| Supply voltage range | 19.2 V DC ... 30 V DC |
| Current consumption | < 40 mA (24 V DC) |
| Power dissipation | < 1 W |
| Temperature coefficient | 0.01%/K |
| Step response (0 - 99%) | Typ. 800 ms (With SIL) max. 1200 ms (With SIL) Typ. 700 ms (Without SIL) max. 1100 ms (Without SIL) |
| Transmission error, total | 0.05% x 200 [K]/Measuring range span [K] + 0.05% |
| Cold junction errors | ±1 K |
| ZERO / SPAN adjustment | ±5% / ±5% |
| Electrical isolation | |
| Input/output/power supply | 2.5 kV (50 Hz, 1 min., test voltage) 300 V _{ins} (Rated insulation voltage, surge voltage category II; pollution degree 2, safe isolation as per EN 61010, EN 50178) |
| Ambient temperature range | -20°C ... 60°C (Any mounting position) |
| Humidity | 5% ... 95% (no condensation) |
| Housing material | PA 66-FR |
| Inflammability class according to UL 94 | V0 |
| Dimensions W / H / D | 12.5 / 99 / 114.5 mm |
| Screw connection solid / stranded / AWG | 0.2 ... 2.5 mm ² / 0.2 ... 2.5 mm ² / 24 - 14 |
| Conformance / approvals | |
| Conformance | CE-compliant, additionally EN 61326 |
| ATEX | Ex II 3 G Ex nA ic IIC T4 Gc X |
| Functional safety (SIL) | SIL 2 according to EN 61508 |

| Description | Order configuration | Standard configuration |
|-------------------------------|---------------------|------------------------|
| Temperature transducer | | |
| Order configuration | Screw connection | Screw connection |
| Standard configuration | Screw connection | Screw connection |

| | |
|--|--|
| Programming adapter for configuring modules with S-PORT interface | |
|--|--|

Technical data

E, J, K, N as per IEC / EN 60584, L as per DIN 43760

-20 mV ... 70 mV
(Min. 50 K for thermocouples, 3 mV for mV sources)

0 mA ... 20 mA / 4 mA ... 20 mA

max. 500 Ω

As per NE 43 or can be freely defined

< 50 µA_{pp}

19.2 V DC ... 30 V DC

< 40 mA (24 V DC)

< 1 W

0.01%/K

Typ. 800 ms (With SIL)

max. 1200 ms (With SIL)

Typ. 700 ms (Without SIL)

max. 1100 ms (Without SIL)

0.05% x 200 [K]/Measuring range span [K] + 0.05%

±1 K

±5% / ±5%

2.5 kV (50 Hz, 1 min., test voltage)

300 V_{ins} (Rated insulation voltage, surge voltage category II; pollution degree 2, safe isolation as per EN 61010, EN 50178)

-20°C ... 60°C (Any mounting position)

5% ... 95% (no condensation)

PA 66-FR

V0

12.5 / 99 / 114.5 mm

0.2 ... 2.5 mm² / 0.2 ... 2.5 mm² / 24 - 14

CE-compliant, additionally EN 61326

Ex II 3 G Ex nA ic IIC T4 Gc X

SIL 2 according to EN 61508

Ordering data

| Type | Order No. | Pcs. / Pkt. |
|-------------------------------|-----------|-------------|
| MACX MCR-SL-TC-1'1' | 2924333 | 1 |
| MACX MCR-SL-TC-1-NC'1' | 2924346 | 1 |

Accessories

| | | |
|--------------------------------|---------|---|
| IFS-USB-PROG-ADAPTER'1' | 2811271 | 1 |
|--------------------------------|---------|---|

Order key and temperature ranges for MACX-MCR-SL-TC-I temperature transducer

Order key for MACX-MCR-SL-TC-I temperature transducer (standard configuration entered as an example)

| Order No. | Sensor type | Safety integrity level (SIL) | Cold junction compensation | Measuring range: | | Measuring unit | Output range | Filter Oversampling | Filter Moving average value | |
|-------------------------------------|-------------|---|--|------------------|-----------|----------------------------|--|---|---|--|
| | | | | Start | End | | | | | |
| 2924333 | J | ON | 1 | 0 | 1000 | C | OUT02 | 10 | 1 | |
| MACX MCR-SL-TC-I | see below | ON ≙ active NONE ≙ not active ON only with output range = OUT02 | 1 ≙ switched on 0 ≙ switched off (e.g., for mV voltage measurement) | see below | see below | C ≙ °C F ≙ °F V ≙ mV | OUT01 ≙ 0...20 mA OUT02 ≙ 4...20 mA | 1 ≙ 1 value 3 ≙ 3 values 5 ≙ 5 values 7 ≙ 7 values 10 ≙ 10 values 20 ≙ 20 values | 1 ≙ 1 value 2 ≙ 2 values 3 ≙ 3 values 4 ≙ 4 values | |
| | | | | | | | Smallest measuring range span | | | |
| V03 ≙ Voltage (mV) | | | | -20 | +70 | mV | 3 mV | | | |
| E ≙ acc. to IEC 584-1 (NiCr-CuNi) | | | | -250 | 1000 | °C | 50 K | | | |
| J ≙ acc. to IEC 584-1 (Fe-CuNi) | | | | -210 | 1200 | °C | 50 K | | | |
| K ≙ acc. to IEC 584-1 (NiCr-Ni) | | | | -250 | 1372 | °C | 50 K | | | |
| N ≙ acc. to IEC 584-1 (NiCrSi-NiSi) | | | | -250 | 1300 | °C | 50 K | | | |
| L ≙ acc. to DIN 43760 (Fe-CuNi) | | | | -200 | 900 | °C | 50 K | | | |

Alarm signal

Overrange

Alarm signal

Sensor break/underrange

Factory calibration certificate = FCC

| I035 | I215 | NONE | Temperature conversion guide for °C to °F: |
|--|--|---|--|
| I000 ≙ 0 mA I035 ≙ 3.5 mA I215 ≙ 21.5 mA I035 only with output range = OUT02 Alarm signals can also be configured individually using software. | I000 ≙ 0 mA I035 ≙ 3.5 mA I215 ≙ 21.5 mA | NONE ≙ without FCC YES ≙ with FCC (a fee is charged) YESPLUS ≙ FCC with 5 measuring points (a fee is charged) | $T [°F] = \frac{9}{5} T [°C] + 32$ |

Temperature Temperature transducer



Universal, with switching output,
wide-range power supply

Functional safety
Ex:
Housing width 17.5 mm

Universal temperature transducer with freely configurable properties

- Input for resistance thermometers, thermocouples, resistance-type sensors, potentiometers, and mV sources
- Measure differential temperatures
- Freely programmable input and output
- Option of inverse output signal ranges
- Relay switching output
- Configuration via software (FDT-DTM) or IFS-OP-UNIT operating and display unit
- Programming during operation and also voltage-free using IFS-USB-PROG-ADAPTER programming adapter
- Plug-in capable screw or spring-cage connection method
- Cold junction compensation with separate connector
- Wide-range power supply: 19.2 ... 253 V AC/DC
- Status indicator for supply voltage, cable, sensor, and module errors
- Up to SIL 2 according to EN 61508
- Installation in zone 2 permitted

| | |
|--|---|
| Input data | Resistance thermometers Thermocouple sensors |
| Resistor Potentiometer Voltage | |
| Output data | Output signal |
| Maximum output signal Load R_B Behavior in the event of a sensor error | |
| Switching output | Contact type Contact material Maximum switching voltage Maximum switching current |
| General data | Supply voltage range Power consumption Temperature coefficient Transmission error, total Electrical isolation |
| | Input/output/power supply |
| | Input/output Input/power supply Input/switching output |
| Ambient temperature range Humidity Housing material Inflammability class according to UL 94 Dimensions W / H / D Screw connection solid / stranded / AWG Spring-cage connection (solid/stranded/AWG) | |
| Conformance / approvals | Conformance ATEX IECEX Functional safety (SIL) |

Technical data

| | |
|--|------------------------------------|
| Pt, Ni, Cu sensors: 2, 3, 4-conductor B, E, J, K, N, R, S, T, L, U, CA, DA, A1G, A2G, A3G, MG, LG | |
| 0 Ω ... 50 k Ω 0 Ω ... 50 k Ω -1000 mV ... 1000 mV | |
| U output 4 mA ... 20 mA (in the case of SIL; further free configuration without SIL) | I output |
| ± 11 V ≥ 10 k Ω | 22 mA $\leq 600 \Omega$ (20 mA) |
| According to NE 43 or freely configurable | Relay output |
| 1 PDT AgSnO ₂ , hard gold-plated 30 V AC (30 V DC) 0.5 A (30 V AC) / 1 A (30 V DC) | |
| 24 V ... 230 V AC/DC (-20%/+10%, 50/60 Hz) < 1.5 W 0.01%/K < 0.1% (e.g., for Pt 100, 300 K span, 4 ... 20 mA) | |
| 2.5 kV 1 (50 Hz, 1 min., test voltage) 300 V _{rms} (Rated insulation voltage, surge voltage category II; pollution degree 2, safe isolation as per EN 61010, EN 50178) | |
| 375 V (Peak value in accordance with EN 60079-11) 375 V (Peak value in accordance with EN 60079-11) 375 V (Peak value in accordance with EN 60079-11) -20°C ... 65°C Typ. 5% ... 95% (no condensation) PA 66-FR V0 17.5 / 99 / 114.5 mm 0.2 ... 2.5 mm ² / 0.2 ... 2.5 mm ² / 24 - 14 0.2 ... 1.5 mm ² / 0.2 ... 1.5 mm ² / 24 - 16 | |
| CE-compliant II 3 G Ex nA nC ic IIC T4 Gc X Ex nA nC ic IIC T4 Gc X SIL 2, PL d | |

| |
|--|
| Notes: |
| To order a product with an order configuration, enter the required configuration by referring to the adjacent order key. |
| The configuration software can be downloaded from the Internet (www.phoenixcontact.net/products). |
| Information on the IFS-OP-UNIT operating and display unit and the associated IFS-OP-CRADLE DIN rail cradle can be found on page 118 |
| For information on the programming adapter, refer to page 119 |
| 1) EMC: Class A product, see page 571 |

| | |
|-------------------------------|-------------------|
| Description | |
| Temperature transducer | |
| Standard configuration | Screw connection |
| Standard configuration | Spring-cage conn. |
| Order configuration | Screw connection |
| Order configuration | Spring-cage conn. |

| |
|--|
| Programming adapter for configuring modules with S-PORT interface |
|--|

Ordering data

| Type | Order No. | Pcs. / Pkt. |
|-------------------------------------|-----------|-------------|
| MACX MCR-T-UI-UP ¹⁾ | 2811394 | 1 |
| MACX MCR-T-UI-UP-SP ¹⁾ | 2811860 | 1 |
| MACX MCR-T-UI-UP-C ¹⁾ | 2811873 | 1 |
| MACX MCR-T-UI-UP-SP-C ¹⁾ | 2811970 | 1 |

Accessories

| | | |
|------------------------------------|---------|---|
| IFS-USB-PROG-ADAPTER ¹⁾ | 2811271 | 1 |
|------------------------------------|---------|---|

Isolating amplifiers with SIL functional safety - MACX Analog

Order key for MACX-MCR-T-UI-UP(-SP)-C temperature transducer (standard configuration entered as an example)

| Order No. | Safety integrity level (SIL) | Sensor type | Connection technology | Cold junction compensation | Measuring range: | | Measuring unit | Output range | Factory calibration certificate = FCC |
|------------------------------|----------------------------------|-------------|---|--|------------------|-----------|--|---|---|
| | | | | | Start | End | | | |
| 2811873 | ON | PT100 | 4 | 0 | -50 | 150 | C | OUT02 | NONE |
| 2811873 ≙ MACX MCR-T-UI-UP-C | ON ≙ active NONE ≙ not active | see below | 2 ≙ 2-conductor 3 ≙ 3-conductor 4 ≙ 4-conductor | 0 ≙ off, e.g., with RTD, R, potentiometer, mV 1 ≙ on, e.g., with TC | see below | see below | C ≙ °C F ≙ °F O ≙ Ω P ≙ % V ≙ mV | OUT15 ≙ 0...5 mA OUT16 ≙ 0...10 mA OUT01 ≙ 0...20 mA OUT15 ≙ 0...5 mA OUT25 ≙ 1...5 mA OUT26 ≙ 2...10 mA OUT02 ≙ 4...20 mA OUT05 ≙ 0...5 V OUT03 ≙ 0...10 V OUT06 ≙ 1...5 V OUT04 ≙ 2...10 V OUT13 ≙ -5...+5 V OUT14 ≙ -10...+10 V Others can be freely configured in the software | NONE ≙ without FCC YES ≙ with FCC (a fee is charged) YESPLUS ≙ FCC with 5 measuring points (a fee is charged) |

Resistance thermometers (RTD)
Others can be selected or freely configured in the software.

| | | | | | |
|---------|--|------|-----|----|-------|
| PT100 | ≙ Pt 100 acc. to IEC 751 | -200 | 850 | °C | 20 K |
| PT200 | ≙ Pt 200 acc. to IEC 751 | -200 | 850 | °C | 20 K |
| PT500 | ≙ Pt 500 acc. to IEC 751 | -200 | 850 | °C | 20 K |
| PT1000 | ≙ Pt 1000 acc. to IEC 751 | -200 | 850 | °C | 20 K |
| PT100S | ≙ Pt 100 acc. to Sama RC21-4-1966 | -200 | 850 | °C | 20 K |
| PT1000S | ≙ Pt 1000 acc. to Sama RC21-4-1966 | -200 | 850 | °C | 20 K |
| PT100G | ≙ Pt 100 acc. to GOST 6651-2009 (α = 0.00385) | -200 | 850 | °C | 20 K |
| PT1000G | ≙ Pt 1000 acc. to GOST 6651-2009 (α = 0.00385) | -200 | 850 | °C | 20 K |
| PT100J | ≙ Pt 100 acc. to JIS C1604/1997 | -200 | 850 | °C | 20 K |
| PT1000J | ≙ Pt 1000 acc. to JIS C1604/1997 | -200 | 850 | °C | 20 K |
| NI100 | ≙ Ni 100 acc. to DIN 43760/DIN IEC 60751 | -60 | 250 | °C | 20 K |
| NI1000 | ≙ Ni 1000 acc. to DIN 43760/DIN IEC 60751 | -60 | 250 | °C | 20 K |
| NI100S | ≙ Ni 100 acc. to Sama RC21-4-1966 | -60 | 180 | °C | 20 K |
| NI1000S | ≙ Ni 1000 acc. to Sama RC21-4-1966 | -60 | 180 | °C | 20 K |
| NI1000L | ≙ Ni 1000 (Landis & Gyr) | -50 | 160 | °C | 20 K |
| CU10 | ≙ Cu 10 acc. to Sama RC21-4-1966 | -70 | 500 | °C | 100 K |
| CU50 | ≙ Cu50 acc. to GOST 6651-2009 (α = 0.00428) | -50 | 200 | °C | 100 K |
| CU100 | ≙ Cu100 acc. to GOST 6651-2009 (α = 0.00428) | -50 | 200 | °C | 100 K |
| CU53 | ≙ Cu53 acc. to GOST 6651-2009 (α = 0.00426) | -50 | 180 | °C | 100 K |
| KTY81 | ≙ KTY81-110 (Philips) | -55 | 150 | °C | 20 K |
| KTY84 | ≙ KTY84-130 (Philips) | -40 | 300 | °C | 20 K |

- Other setting options can be configured with the IFS-CONF software:**
- Freely configurable user characteristic curve with 30 interpolation points
 - Output behavior in the event of a short circuit, sensor break or overrange/underrange can be freely configured or set according to NE43 (standard configuration: NE43 upscale)
 - Filter setting (standard configuration: 1)
 - Restart after failsafe (standard configuration: ON)
 - Switching behavior: switching output ? (limit values, times, etc.) (standard configuration: OFF)

Thermocouples (TC)
Others can be selected in the software.

| | | | | | |
|-----|------------------------------------|------|------|----|------|
| B | ≙ acc. to IEC 584-1 (Pt30Rh-Pt6Rh) | 500 | 1820 | °C | 50 K |
| E | ≙ acc. to IEC 584-1 (NiCr-CuNi) | -230 | 1000 | °C | 50 K |
| J | ≙ acc. to IEC 584-1 (Fe-CuNi) | -210 | 1200 | °C | 50 K |
| K | ≙ acc. to IEC 584-1 (NiCr-Ni) | -250 | 1372 | °C | 50 K |
| N | ≙ acc. to IEC 584-1 (NiCrSi-NiSi) | -250 | 1300 | °C | 50 K |
| R | ≙ acc. to IEC 584-1 (Pt13Rh-Pt) | -50 | 1768 | °C | 50 K |
| S | ≙ acc. to IEC 584-1 (Pt10Rh-Pt) | -50 | 1768 | °C | 50 K |
| T | ≙ acc. to IEC 584-1 (Cu-CuNi) | -200 | 400 | °C | 50 K |
| L | ≙ acc. to DIN 43760 (Fe-CuNi) | -200 | 900 | °C | 50 K |
| U | ≙ acc. to DIN 43760 (Cu-CuNi) | -200 | 600 | °C | 50 K |
| CA | ≙ C ASTM JE988 (2002) | 0 | 2315 | °C | 50 K |
| DA | ≙ D ASTM JE988 (2002) | 0 | 2315 | °C | 50 K |
| A1G | ≙ A-1 GOST 8.585-2001 | 0 | 2500 | °C | 50 K |
| A2G | ≙ A-2 GOST 8.585-2001 | 0 | 1800 | °C | 50 K |
| A3G | ≙ A-3 GOST 8.585-2001 | 0 | 1800 | °C | 50 K |
| MG | ≙ M GOST 8.585-2001 | -200 | 100 | °C | 50 K |
| LG | ≙ L GOST 8.585-2001 | -200 | 800 | °C | 50 K |

Remote resistance-type sensors (R) (2, 3, 4-conductor)
Others can be selected in the software.

| | | | | | |
|-------|------------------------|---|-------|---|-------------------------------------|
| RES03 | ≙ 0...150 Ω resistor | 0 | 150 | Ω | 10% of the selected measuring range |
| RES05 | ≙ 0...600 Ω resistor | 0 | 600 | Ω | |
| RES06 | ≙ 0...1200 Ω resistor | 0 | 1200 | Ω | |
| RES09 | ≙ 0...6250 Ω resistor | 0 | 6250 | Ω | |
| RES10 | ≙ 0...12500 Ω resistor | 0 | 12500 | Ω | |
| RES12 | ≙ 0...50000 Ω resistor | 0 | 50000 | Ω | |

Potentiometers (3-conductor)
Others can be selected in the software.

| | | | | | |
|-------|-----------------------------|---|-----|---|-------------------------------------|
| POT03 | ≙ 0...150 Ω potentiometer | 0 | 100 | % | 10% of the selected measuring range |
| POT05 | ≙ 0...600 Ω potentiometer | 0 | 100 | % | |
| POT06 | ≙ 0...1200 Ω potentiometer | 0 | 100 | % | |
| POT09 | ≙ 0...6250 Ω potentiometer | 0 | 100 | % | |
| POT10 | ≙ 0...12500 Ω potentiometer | 0 | 100 | % | |
| POT12 | ≙ 0...50000 Ω potentiometer | 0 | 100 | % | |

Voltage signals (mV)
Others can be selected in the software.

| | | | | | |
|-----|----------------|-------|-------|----|---------------------|
| V04 | ≙ Voltage (mV) | -1000 | +1000 | mV | 10% of nominal span |
|-----|----------------|-------|-------|----|---------------------|

Temperature conversion guide for °C to °F:

$$T [°F] = \frac{9}{5} T [°C] + 32$$

Temperature
Temperature transducer



Universal, with three limit value relays, wide-range power supply

Functional safety
Ex: SIL
Housing width 35 mm

Universal temperature transducer with freely configurable properties

- Input for resistance thermometers, thermocouples, resistance-type sensors, potentiometers, and mV sources
- Measure differential temperatures
- Freely programmable input and output
- Option of inverse output signal ranges
- Three limit value relays, can be used in combination as a safe limit value relay
- Configuration via software (FDT-DTM) or IFS-OP-UNIT operating and display unit
- Programming during operation and also voltage-free using IFS-USB-PROG-ADAPTER programming adapter
- Plug-in capable screw or spring-cage connection method
- Cold junction compensation with separate connector
- Wide-range power supply: 19.2 ... 253 V AC/DC
- Status indicator for supply voltage, cable, sensor, and module errors
- Up to SIL 2 according to EN 61508
- Installation in zone 2 permitted

| | |
|--|---|
| Input data | Resistance thermometers Thermocouple sensors |
| Resistor Potentiometer Voltage | |
| Output data | Output signal |
| Maximum output signal Load R_B Behavior in the event of a sensor error | |
| Switching output | Contact type Contact material Maximum switching voltage Maximum switching current |
| General data | Supply voltage range Power consumption Temperature coefficient Transmission error, total Electrical isolation |
| | Input/output/power supply |
| | Input/output Input/power supply Input/switching output |
| Ambient temperature range Humidity Housing material Inflammability class according to UL 94 Dimensions W / H / D Screw connection solid / stranded / AWG Spring-cage connection (solid/stranded/AWG) | |
| Conformance / approvals | Conformance ATEX IECEX Functional safety (SIL) |

Technical data

| |
|--|
| Pt, Ni, Cu sensors: 2, 3, 4-conductor B, E, J, K, N, R, S, T, L, U, CA, DA, A1G, A2G, A3G, MG, LG |
| 0 Ω ... 50 kΩ 0 Ω ... 50 kΩ -1000 mV ... 1000 mV |
| U output 4 mA ... 20 mA (in the case of SIL; further free configuration without SIL) |
| I output 22 mA ≤ 600 Ω (20 mA) |
| According to NE 43 or freely configurable |
| Relay output 3 PDTs AgSnO ₂ , hard gold-plated 250 V AC (250 V DC) 2 A (250 V AC) / 2 A (28 V DC) |
| 24 V ... 230 V AC/DC (-20%/+10%, 50/60 Hz) < 2.4 W 0.01%/K < 0.1% (e.g., for Pt 100, 300 K span, 4 ... 20 mA) |
| 2.5 kV (50 Hz, 1 min., test voltage) 300 V _{rms} (Rated insulation voltage, surge voltage category II; pollution degree 2, safe isolation as per EN 61010, EN 50178) |
| 375 V (Peak value in accordance with EN 60079-11) 375 V (Peak value in accordance with EN 60079-11) 375 V (Peak value in accordance with EN 60079-11) -20°C ... 65°C Typ. 5% ... 95% (no condensation) PA 66-FR V0 35 / 99 / 114.5 mm 0.2 ... 2.5 mm ² / 0.2 ... 2.5 mm ² / 24 - 14 0.2 ... 1.5 mm ² / 0.2 ... 1.5 mm ² / 24 - 16 |
| CE-compliant II 3 G Ex nA nC ic IIC T4 Gc X Ex nA nC ic IIC T4 Gc X SIL 2, PL d |

| |
|--|
| Notes: |
| To order a product with an order configuration, enter the required configuration by referring to the adjacent order key. |
| The configuration software can be downloaded from the Internet (www.phoenixcontact.net/products). |
| Information on the IFS-OP-UNIT operating and display unit and the associated IFS-OP-CRADLE DIN rail cradle can be found on page 118 |
| For information on the programming adapter, refer to page 119 |
| 1) EMC: Class A product, see page 571 |

| | |
|-------------------------------|-------------------|
| Description | |
| Temperature transducer | |
| Standard configuration | Screw connection |
| Standard configuration | Spring-cage conn. |
| Order configuration | Screw connection |
| Order configuration | Spring-cage conn. |

Ordering data

| Type | Order No. | Pcs. / Pkt. |
|--|-----------|-------------|
| MACX MCR-T-UIREL-UP ¹⁾ | 2811378 | 1 |
| MACX MCR-T-UIREL-UP-SP ¹⁾ | 2811828 | 1 |
| MACX MCR-T-UIREL-UP-C ¹⁾ | 2811514 | 1 |
| MACX MCR-T-UIREL-UP-SP-C ¹⁾ | 2811831 | 1 |

Accessories

| | | |
|------------------------------------|---------|---|
| IFS-USB-PROG-ADAPTER ¹⁾ | 2811271 | 1 |
|------------------------------------|---------|---|

| |
|--|
| Programming adapter for configuring modules with S-PORT interface |
|--|

Isolating amplifiers with SIL functional safety - MACX Analog

Order key for MACX-MCR-T-UIREL-UP(-SP)-C temperature transducer (standard configuration entered as an example)

| Order No. | Safety integrity level (SIL) | Sensor type | Connection technology | Cold junction compensation | Measuring range: | | Measuring unit | Output range | Factory calibration certificate = FCC |
|--|--|--------------------------------------|---|--|------------------|-----------|--|---|---|
| | | | | | Start | End | | | |
| 2811514 | ON | PT100 | 4 | 0 | -50 | 150 | C | OUT02 | NONE |
| 2811514 ≙ MACX MCR-T-UIREL-UP-C | ON ≙ active NONE ≙ not active | see below | 2 ≙ 2-conductor 3 ≙ 3-conductor 4 ≙ 4-conductor | 0 ≙ off, e.g., with RTD, R, potentiometer, mV 1 ≙ on, e.g., with TC | see below | see below | C ≙ °C F ≙ °F O ≙ Ω P ≙ % V ≙ mV | OUT15 ≙ 0...5 mA OUT16 ≙ 0...10 mA OUT01 ≙ 0...20 mA OUT15 ≙ 0...5 mA OUT25 ≙ 1...5 mA OUT26 ≙ 2...10 mA OUT02 ≙ 4...20 mA OUT05 ≙ 0...5 V OUT03 ≙ 0...10 V OUT06 ≙ 1...5 V OUT04 ≙ 2...10 V OUT13 ≙ -5...+5 V OUT14 ≙ -10...+10 V Others can be freely configured in the software | NONE ≙ without FCC YES ≙ with FCC (a fee is charged) YESPLUS ≙ FCC with 5 measuring points (a fee is charged) |
| 2811831 ≙ MACX MCR-T-UIREL-UP-SP-C | ON only with output range = OUT02 | | | | | | | | |
| Resistance thermometers (RTD) Others can be selected or freely configured in the software. | | PT100 ≙ Pt 100 acc. to IEC 751 | | | -200 | 850 | °C | 20 K | Other setting options can be configured with the IFS-CONF software: <ul style="list-style-type: none"> - Freely configurable user characteristic curve with 30 interpolation points - Output behavior in the event of a short circuit, sensor break or overrange/underrange can be freely configured or set according to NE43 (standard configuration: NE43 upscale) - Filter setting (standard configuration: 1) - Restart after failsafe (standard configuration: ON) - Switching behavior: switching output ? (limit values, times, etc.) (standard configuration: OFF) |
| | PT200 ≙ Pt 200 acc. to IEC 751 | | | -200 | 850 | °C | 20 K | | |
| | PT500 ≙ Pt 500 acc. to IEC 751 | | | -200 | 850 | °C | 20 K | | |
| | PT1000 ≙ Pt 1000 acc. to IEC 751 | | | -200 | 850 | °C | 20 K | | |
| | PT100S ≙ Pt 100 acc. to Sama RC21-4-1966 | | | -200 | 850 | °C | 20 K | | |
| | PT1000S ≙ Pt 1000 acc. to Sama RC21-4-1966 | | | -200 | 850 | °C | 20 K | | |
| | PT100G ≙ Pt 100 acc. to GOST 6651-2009 (α = 0.00385) | | | -200 | 850 | °C | 20 K | | |
| | PT1000G ≙ Pt 1000 acc. to GOST 6651-2009 (α = 0.00385) | | | -200 | 850 | °C | 20 K | | |
| | PT100J ≙ Pt 100 acc. to JIS C1604/1997 | | | -200 | 850 | °C | 20 K | | |
| | PT1000J ≙ Pt 1000 acc. to JIS C1604/1997 | | | -200 | 850 | °C | 20 K | | |
| | NI100 ≙ Ni 100 acc. to DIN 43760/DIN IEC 60751 | | | -60 | 250 | °C | 20 K | | |
| | NI1000 ≙ Ni 1000 acc. to DIN 43760/DIN IEC 60751 | | | -60 | 250 | °C | 20 K | | |
| | NI100S ≙ Ni 100 acc. to Sama RC21-4-1966 | | | -60 | 180 | °C | 20 K | | |
| | NI1000S ≙ Ni 1000 acc. to Sama RC21-4-1966 | | | -60 | 180 | °C | 20 K | | |
| | NI1000L ≙ Ni 1000 (Landis & Gyr) | | | -50 | 160 | °C | 20 K | | |
| | CU10 ≙ Cu 10 acc. to Sama RC21-4-1966 | | | -70 | 500 | °C | 100 K | | |
| | CU50 ≙ Cu 50 acc. to GOST 6651-2009 (α = 1.428) | | | -50 | 200 | °C | 100 K | | |
| | CU100 ≙ Cu 100 acc. to GOST 6651-2009 (α = 1.428) | | | -50 | 200 | °C | 100 K | | |
| | CU53 ≙ Cu 53 acc. to GOST 6651-2009 (α = 1.426) | | | -50 | 180 | °C | 100 K | | |
| | KTY81 ≙ KTY81-110 (Philips) | | | -55 | 150 | °C | 20 K | | |
| | KTY84 ≙ KTY84-130 (Philips) | | | -40 | 300 | °C | 20 K | | |
| Thermocouples (TC) Others can be selected in the software. | | B ≙ acc. to IEC 584-1 (Pt30Rh-Pt6Rh) | | | 500 | 1820 | °C | 50 K | |
| | E ≙ acc. to IEC 584-1 (NiCr-CuNi) | | | -230 | 1000 | °C | 50 K | | |
| | J ≙ acc. to IEC 584-1 (Fe-CuNi) | | | -210 | 1200 | °C | 50 K | | |
| | K ≙ acc. to IEC 584-1 (NiCr-Ni) | | | -250 | 1372 | °C | 50 K | | |
| | N ≙ acc. to IEC 584-1 (NiCrSi-NiSi) | | | -250 | 1300 | °C | 50 K | | |
| | R ≙ acc. to IEC 584-1 (Pt13Rh-Pt) | | | -50 | 1768 | °C | 50 K | | |
| | S ≙ acc. to IEC 584-1 (Pt10Rh-Pt) | | | -50 | 1768 | °C | 50 K | | |
| | T ≙ acc. to IEC 584-1 (Cu-CuNi) | | | -200 | 400 | °C | 50 K | | |
| | L ≙ acc. to DIN 43760 (Fe-CuNi) | | | -200 | 900 | °C | 50 K | | |
| | U ≙ acc. to DIN 43760 (Cu-CuNi) | | | -200 | 600 | °C | 50 K | | |
| | CA ≙ C ASTM JE988 (2002) | | | 0 | 2315 | °C | 50 K | | |
| | DA ≙ D ASTM JE988 (2002) | | | 0 | 2315 | °C | 50 K | | |
| | A1G ≙ A-1 GOST 8.585-2001 | | | 0 | 2500 | °C | 50 K | | |
| | A2G ≙ A-2 GOST 8.585-2001 | | | 0 | 1800 | °C | 50 K | | |
| | A3G ≙ A-3 GOST 8.585-2001 | | | 0 | 1800 | °C | 50 K | | |
| | MG ≙ M GOST 8.585-2001 | | | -200 | 100 | °C | 50 K | | |
| | LG ≙ L GOST 8.585-2001 | | | -200 | 800 | °C | 50 K | | |
| Remote resistance-type sensors (R) (2, 3, 4-conductor) Others can be selected in the software. | | RES03 ≙ 0...150 Ω resistor | | | 0 | 150 | Ω | 10% of the selected measuring range | |
| | RES05 ≙ 0...600 Ω resistor | | | 0 | 600 | Ω | | | |
| | RES06 ≙ 0...1200 Ω resistor | | | 0 | 1200 | Ω | | | |
| | RES09 ≙ 0...6250 Ω resistor | | | 0 | 6250 | Ω | | | |
| | RES10 ≙ 0...12500 Ω resistor | | | 0 | 12500 | Ω | | | |
| | RES12 ≙ 0...50000 Ω resistor | | | 0 | 50000 | Ω | | | |
| Potentiometers (3-conductor) Others can be selected in the software. | | POT03 ≙ 0...150 Ω potentiometer | | | 0 | 100 | % | 10% of the selected measuring range | |
| | POT05 ≙ 0...600 Ω potentiometer | | | 0 | 100 | % | | | |
| | POT06 ≙ 0...1200 Ω potentiometer | | | 0 | 100 | % | | | |
| | POT09 ≙ 0...6250 Ω potentiometer | | | 0 | 100 | % | | | |
| | POT10 ≙ 0...12500 Ω potentiometer | | | 0 | 100 | % | | | |
| | POT12 ≙ 0...50000 Ω potentiometer | | | 0 | 100 | % | | | |
| Voltage signals (mV) Others can be selected in the software. | | V04 ≙ Voltage (mV) | | | -1000 | +1000 | mV | 10% of nominal span | |

Temperature conversion guide for °C to °F:

$$T [°F] = \frac{9}{5} T [°C] + 32$$

Accessories

Operating and display unit

- Local display of actual values
- Copy function
- Easy guided operation
- Easy configuration without PC software
- Operating and display unit can be snapped directly onto compatible devices with a housing width of 35 mm
- DIN rail mounting possible for thinner devices in conjunction with cradle unit
- Backlighting
- Installation in zone 2 permissible



Can be snapped directly onto compatible 35 mm devices

Notes:
1) EMC: Class A product, see page 571

| General data | |
|---------------------------|--------------------------------------|
| Ambient temperature range | -20°C ... 65°C (-4°F ... 149°F) |
| Humidity | 90% (at 25°C, no condensation) |
| Housing material | PA 6.6 |
| Dimensions W / H / D | 35 / 99 / 20 mm |
| Connection method | PC side Measuring transducer side |
| Conformance / approvals | |
| Conformance | CE-compliant |
| ATEX | Ex II 3G Ex nA ic IIC T4 Gc X |
| IECEX | Ex nA ic IIC T4 Gc X |

Technical data

| | |
|---------------------------|--------------------------------------|
| Ambient temperature range | -20°C ... 65°C (-4°F ... 149°F) |
| Humidity | 90% (at 25°C, no condensation) |
| Housing material | PA 6.6 |
| Dimensions W / H / D | 35 / 99 / 20 mm |
| Connection method | PC side Measuring transducer side |

| Description |
|-----------------------------------|
| Operating and display unit |

Ordering data

| Type | Order No. | Pcs. / Pkt. |
|---------------------------|-----------|-------------|
| IFS-OP-UNIT ¹⁾ | 2811899 | 1 |

Accessories

Cradle unit

- For snapping onto the DIN rail
- For control cabinet mounting of the operating and display unit

Notes:
1) EMC: Class A product, see page 571



Cradle for operating and display unit

| General data | |
|---------------------------|---|
| Ambient temperature range | -20°C ... 65°C (-4°F ... 149°F) |
| Humidity | 90% (at 25°C, no condensation) |
| Housing material | PA 6.6 |
| Dimensions W / H / D | 35.2 / 29 / 99 mm |
| Connection method | IFS-OP-UNIT operator interface Measuring transducer side |
| Conformance / approvals | |
| Conformance | CE-compliant |
| ATEX | Ex II 3G Ex nA ic IIC T4 Gc X |
| IECEX | Ex nA ic IIC T4 Gc X |

Technical data

| | |
|---------------------------|---|
| Ambient temperature range | -20°C ... 65°C (-4°F ... 149°F) |
| Humidity | 90% (at 25°C, no condensation) |
| Housing material | PA 6.6 |
| Dimensions W / H / D | 35.2 / 29 / 99 mm |
| Connection method | IFS-OP-UNIT operator interface Measuring transducer side |

| Description |
|--|
| Cradle unit , for snapping the operating and display unit onto the DIN rail |

Ordering data

| Type | Order No. | Pcs. / Pkt. |
|-----------------------------|-----------|-------------|
| IFS-OP-CRADLE ¹⁾ | 2811886 | 1 |

Accessories

Programming adapter

The IFS-USB-PROG-ADAPTER programming adapter is used for configuring Phoenix Contact INTERFACE modules with S-PORT interface.

The adapter is used with FDT/DTM software or ANALOG-CONF software. For programming MACX Analog and MINI Analog.



Notes:
1) EMC: Class A product, see page 571

Applied for:
cUL / UL

| Ordering data | | | |
|--|------------------------------------|-----------|-------------|
| Description | Type | Order No. | Pcs. / Pkt. |
| Programming adapter for configuring modules with S-PORT interface | IFS-USB-PROG-ADAPTER ¹⁾ | 2811271 | 1 |

Digital IN
NAMUR isolation amplifiers



Ex n



Functional safety

Ex: Ex

Housing width 12.5 mm



Signal output: PDT relay

NAMUR isolation amplifier for operating proximity sensors and mechanical contacts

- Input for NAMUR proximity sensors (EN 60947-5-6), floating contacts or contacts with resistance circuit
- Relay signal output (PDT)
- Reversible direction of action (operating current or closed-circuit current behavior)
- Line fault detection (LFD), can be activated/deactivated, error message signaled by red flashing LED with de-excitation of output relay
- Power supply and error indication possible via the DIN rail connector
- LED displays for indicating supply voltage, circuit state, and malfunctions to NAMUR NE 44
- 3-way electrical isolation
- Up to SIL 2 according to EN 61508
- Installation in zone 2 permitted

| Notes: |
|---|
| Information about the supply and error evaluation module as well as about the DIN rail connectors and marking material can be found from page 126 |
| Information about resistance circuits is given on page 183 |
| Information on "Plug and play" connection using system cabling can be found from page 128 |
| 1) EMC: Class A product, see page 571 |

| Input data |
|---|
| Input signal |
| No-load voltage |
| Switching points |
| Switching hysteresis |
| Line error detection |
| Switching output |
| Contact type |
| Contact material |
| Maximum switching voltage |
| Maximum switching capacity |
| Recommended minimum load |
| Mechanical service life |
| Switching behavior |
| Maximum switching frequency |
| General data |
| Supply voltage range |
| Current consumption |
| Power dissipation |
| Electrical isolation |
| Input/output/supply, T-Connector |
| Ambient temperature range |
| Humidity |
| Housing material |
| Inflammability class according to UL 94 |
| Dimensions W / H / D |
| Screw connection solid / stranded / AWG |
| Spring-cage connection (solid/stranded/AWG) |
| Conformance / approvals |
| Conformance |
| ATEX |
| Functional safety (SIL) |

| Technical data |
|--|
| NAMUR proximity sensors (EN 60947-5-6) |
| Floating switch contacts |
| Switch contacts with resistance circuit |
| 8 V DC $\pm 10\%$ |
| > 2.1 mA (conductive) / < 1.2 mA (blocking) |
| < 0.2 mA |
| Break 0.05 mA $< I_N < 0.35$ mA |
| Short-circuit $100 \Omega < R_{\text{sensor}} < 360 \Omega$ |
| Relay output |
| 1 PDT |
| AgSnO ₂ , hard gold-plated |
| 250 V AC (2 A) / 120 V DC (0.2 A) / 30 V DC (2 A) |
| 500 VA |
| 5 V / 10 mA |
| 10 ⁷ cycles |
| Can be inverted via slide switch |
| 20 Hz (without load) |
| 19.2 V DC ... 30 V DC |
| 21 mA (24 V DC) |
| < 650 mW |
| 300 V _{rms} (Rated insulation voltage, surge voltage category II; pollution degree 2, safe isolation as per EN 61010, EN 50178) |
| 2.5 kV (50 Hz, 1 min., test voltage) |
| -20°C ... 60°C (Any mounting position) |
| 10% ... 95% (no condensation) |
| PA 66-FR |
| V0 |
| 12.5 / 99 / 114.5 mm |
| 0.2 ... 2.5 mm ² / 0.2 ... 2.5 mm ² / 24 - 14 |
| 0.2 ... 1.5 mm ² / 0.2 ... 1.5 mm ² / 24 - 16 |
| CE-compliant, additionally EN 61326 |
| Ex II 3 G Ex nA nC IIC T4 Gc X |
| SIL 2 according to EN 61508 |

| Description |
|---------------------------|
| NAMUR isolation amplifier |
| Screw connection |
| Spring-cage conn. |

| Ordering data | | |
|------------------------------------|-----------|-------------|
| Type | Order No. | Pcs. / Pkt. |
| MACX MCR-SL-NAM-R ¹⁾ | 2865997 | 1 |
| MACX MCR-SL-NAM-R-SP ¹⁾ | 2924252 | 1 |

Digital IN
NAMUR isolation amplifiers

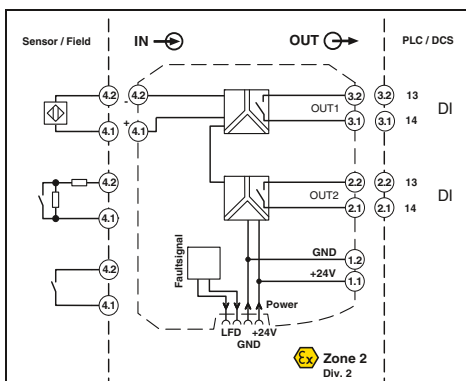
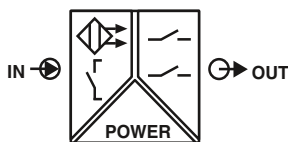

2 signal outputs: N/O contact relay

Functional safety
Ex: Ex n
Housing width 12.5 mm

NAMUR isolation amplifier for operating proximity sensors and mechanical contacts

- Input for NAMUR proximity sensors (EN 60947-5-6), floating contacts or contacts with resistance circuit
- Two relay signal outputs (N/O contact); output 2 can be used as an error message output
- Reversible direction of action (operating current or closed-circuit current behavior)
- Line fault detection (LFD), can be activated/deactivated, error message signaled by red flashing LED with de-excitation of output relay
- Power supply and error indication possible via the DIN rail connector
- LED displays for indicating supply voltage, circuit state, and malfunctions to NAMUR NE 44
- 4-way electrical isolation
- Up to SIL 2 according to EN 61508
- Installation in zone 2 permitted

Input data
Input signal

No-load voltage
Switching points
Switching hysteresis
Line error detection

Switching output

Contact type
Contact material
Maximum switching voltage
Maximum switching capacity
Recommended minimum load
Mechanical service life
Switching behavior
Maximum switching frequency

General data

Supply voltage range
Current consumption
Power dissipation
Electrical isolation

Input/supply, T connector

Output 1/output 2/input, power supply, T connector

Ambient temperature range
Humidity
Housing material
Inflammability class according to UL 94
Dimensions W / H / D
Screw connection solid / stranded / AWG
Spring-cage connection (solid/stranded/AWG)

Conformance / approvals

Conformance
ATEX
Functional safety (SIL)

Technical data

NAMUR proximity sensors (EN 60947-5-6)
Floating switch contacts
Switch contacts with resistance circuit
8 V DC $\pm 10\%$
> 2.1 mA (conductive) / < 1.2 mA (blocking)
< 0.2 mA
Break 0.05 mA < I_N < 0.35 mA
Short-circuit 100 Ω < R_{Sensor} < 360 Ω

Relay output

2 N/O contacts
AgSnO₂, hard gold-plated
250 V AC (2 A) / 120 V DC (0.2 A) / 30 V DC (2 A)
500 VA
5 V / 10 mA
10⁷ cycles
Can be inverted via slide switch
20 Hz (without load)

19.2 V DC ... 30 V DC
30 mA (24 V DC)
< 950 mW

2.5 kV (50 Hz, 1 min., test voltage)
300 V_{rms} (Rated insulation voltage, surge voltage category II; pollution degree 2, safe isolation as per EN 61010, EN 50178)

2.5 kV (50 Hz, 1 min., test voltage)
300 V_{rms} (Rated insulation voltage, surge voltage category III; pollution degree 2, safe isolation as per EN 61010, EN 50178)

-20°C ... 60°C (Any mounting position)
10% ... 95% (no condensation)

PA 66-FR
V0
12.5 / 99 / 114.5 mm
0.2 ... 2.5 mm² / 0.2 ... 2.5 mm² / 24 - 14
0.2 ... 1.5 mm² / 0.2 ... 1.5 mm² / 24 - 16

CE-compliant, additionally EN 61326
Ex II 3 G Ex nA nC IIC T4 Gc X
SIL 2 according to EN 61508

Ordering data

| Description | Type | Order No. | Pcs. / Pkt. |
|---------------------------|--------------------------------------|-----------------------------------|-------------|
| NAMUR isolation amplifier | | | |
| | Screw connection | MACX MCR-SL-NAM-2RO ¹⁾ | 2865010 |
| Spring-cage conn. | MACX MCR-SL-NAM-2RO-SP ¹⁾ | 2924265 | 1 |

Notes:

| |
|---|
| Information about the supply and error evaluation module as well as about the DIN rail connectors and marking material can be found from page 126 |
| Information about resistance circuits is given on page 183 |
| Information on "Plug and play" connection using system cabling can be found from page 128 |
| 1) EMC: Class A product, see page 571 |

Digital IN
NAMUR isolation amplifiers

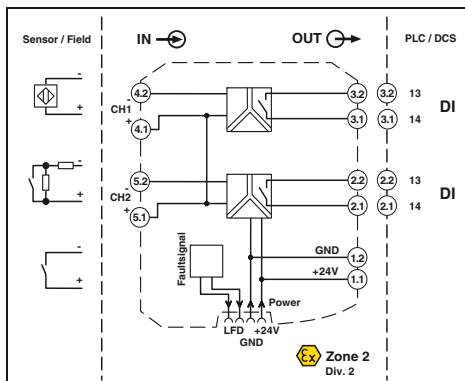

Ex n



Functional safety

Ex: Ex

Housing width 12.5 mm



2-channel, signal output: N/O contact relay

NAMUR isolating amplifier for intrinsically safe operation of proximity sensors and mechanical contacts installed in Ex areas.

- 2-channel
- Input for NAMUR proximity sensors (EN 60947-5-6), floating contacts or contacts with resistance circuit
- Relay signal output (N/O contact)
- Reversible direction of action (operating current or closed-circuit current behavior)
- Line fault detection (LFD), can be activated/deactivated, error message signaled by red flashing LED with de-excitation of output relay
- Power supply and error indication possible via the DIN rail connector
- LED displays for indicating supply voltage, circuit state, and malfunctions to NAMUR NE 44
- 3-way electrical isolation
- Up to SIL 2 according to EN 61508
- Installation in zone 2 permitted

| Notes: |
|---|
| Information about the supply and error evaluation module as well as about the DIN rail connectors and marking material can be found from page 126 |
| Information about resistance circuits is given on page 183 |
| Information on "Plug and play" connection using system cabling can be found from page 128 |
| 1) EMC: Class A product, see page 571 |

Input data

Input signal

- No-load voltage
- Switching points
- Switching hysteresis
- Line error detection

Switching output

- Contact type
- Contact material
- Maximum switching voltage
- Maximum switching capacity
- Recommended minimum load
- Mechanical service life
- Switching behavior
- Maximum switching frequency

General data

- Supply voltage range
- Current consumption
- Power dissipation
- Electrical isolation

Input/supply, T connector

Output 1/output 2/input, power supply, T connector

- Ambient temperature range
- Humidity
- Housing material
- Inflammability class according to UL 94
- Dimensions W / H / D
- Screw connection solid / stranded / AWG
- Spring-cage connection (solid/stranded/AWG)
- Conformance / approvals
- Conformance
- ATEX
- Functional safety (SIL)

Technical data

NAMUR proximity sensors (EN 60947-5-6)
 Floating switch contacts
 Switch contacts with resistance circuit
 8 V DC $\pm 10\%$
 > 2.1 mA (conductive) / < 1.2 mA (blocking)
 < 0.2 mA
 Break 0.05 mA $< I_N < 0.35$ mA
 Short-circuit $100 \Omega < R_{\text{sensor}} < 360 \Omega$
 Relay output
 2 N/O contacts
 AgSnO₂, hard gold-plated
 250 V AC (2 A) / 120 V DC (0.2 A) / 30 V DC (2 A)
 500 VA
 5 V / 10 mA
 10⁷ cycles
 Can be inverted via slide switch
 20 Hz (without load)

19.2 V DC ... 30 V DC
 35 mA (24 V DC)
 < 1 W

2.5 kV (50 Hz, 1 min., test voltage)
 300 V_{rms} (Rated insulation voltage, surge voltage category II; pollution degree 2, safe isolation as per EN 61010, EN 50178)

2.5 kV (50 Hz, 1 min., test voltage)
 300 V_{rms} (Rated insulation voltage, surge voltage category III; pollution degree 2, safe isolation as per EN 61010, EN 50178)

-20°C ... 60°C (Any mounting position)
 5% ... 95% (no condensation)
 PA 66-FR
 V0
 12.5 / 99 / 114.5 mm
 0.2 ... 2.5 mm² / 0.2 ... 2.5 mm² / 24 - 14
 0.2 ... 1.5 mm² / 0.2 ... 1.5 mm² / 24 - 16

CE-compliant, additionally EN 61326
 Ex II 3 G Ex nA nC IIC T4 Gc X
 SIL 2 according to EN 61508

Ordering data

| Type | Order No. | Pcs. / Pkt. |
|-------------------------------------|-----------|-------------|
| MACX MCR-SL-2NAM-RO ¹ | 2865049 | 1 |
| MACX MCR-SL-2NAM-RO-SP ¹ | 2924294 | 1 |

| Description |
|---------------------------|
| NAMUR isolation amplifier |
| Screw connection |
| Spring-cage conn. |

Digital IN
NAMUR isolation amplifiers



2-channel, signal output: PDT relay, wide-range power supply

Functional safety
Ex:
Housing width 17.5 mm

NAMUR isolation amplifier for operating proximity sensors and mechanical contacts

- 2-channel
- Input for NAMUR proximity sensors (EN 60947-5-6), floating contacts or contacts with resistance circuit
- Relay signal output (PDT)
- Reversible direction of action (operating current or closed-circuit current behavior)
- Line fault detection (LFD), can be activated/deactivated, error message signaled by red flashing LED with de-excitation of output relay
- Wide-range power supply: 19.2 ... 253 V AC/DC
- LED displays for indicating supply voltage, circuit state, and malfunctions to NAMUR NE 44
- 3-way electrical isolation
- Up to SIL 2 according to EN 61508
- Installation in zone 2 permitted

Notes:
Information on resistance circuits and marking material can be found on page 183
1) EMC: Class A product, see page 571

| | |
|---|---|
| Input data | Input signal |
| No-load voltage | Switching points |
| Switching hysteresis | Line error detection |
| Switching output | Contact type |
| Contact material | Maximum switching voltage |
| Maximum switching capacity | Recommended minimum load |
| Mechanical service life | Switching behavior |
| Maximum switching frequency | General data |
| Supply voltage range | Current consumption |
| Power dissipation | Electrical isolation |
| Input/power supply | Output 1/output 2/input, power supply |
| Ambient temperature range | Humidity |
| Housing material | Inflammability class according to UL 94 |
| Dimensions W / H / D | Screw connection solid / stranded / AWG |
| Spring-cage connection (solid/stranded/AWG) | Conformance / approvals |
| Conformance | ATEX |
| Functional safety (SIL) | |

Technical data

| |
|---|
| NAMUR proximity sensors (EN 60947-5-6) |
| open circuit switch contacts |
| Switch contacts with resistance circuit |
| 8 V DC ±10% |
| > 2.1 mA (conductive) / < 1.2 mA (blocking) |
| Approx. 0.2 mA |
| Break 0.05 mA < I _N < 0.35 mA |
| Short-circuit 100 Ω < R _{Sensor} < 360 Ω |
| Relay output |
| 2 PDT |
| AgSnO ₂ , hard gold-plated |
| 250 V AC (2 A, 60 Hz) / 120 V DC (0.2 A) / 30 V DC (2 A) |
| 500 VA |
| 5 V / 10 mA |
| 10 ⁷ cycles |
| can be inverted using DIP switch |
| 20 Hz (Load-dependent) |
| 24 V ... 230 V AC/DC (-20% ... +10%, 50 ... 60 Hz) |
| < 80 mA ; < 42 mA (24 V DC) |
| max. 1.3 W |
| 2.5 kV (50 Hz, 1 min., test voltage) |
| 300 V _{rms} (Rated insulation voltage, surge voltage category II; pollution degree 2, safe isolation as per EN 61010, EN 50178) |
| 2.5 kV (50 Hz, 1 min., test voltage) |
| 300 V _{rms} (Rated insulation voltage, surge voltage category III; pollution degree 2, safe isolation as per EN 61010, EN 50178) |
| -20°C ... 60°C |
| 10% ... 95% (no condensation) |
| PA 66-FR |
| V0 |
| 17.5 / 99 / 114.5 mm |
| 0.2 ... 2.5 mm ² / 0.2 ... 2.5 mm ² / 24 - 14 |
| 0.2 ... 1.5 mm ² / 0.2 ... 1.5 mm ² / 24 - 16 |
| CE-compliant, additionally EN 61326 |
| II 3 G Ex nA nC IIC T4 Gc X |
| SIL 2 according to EN 61508 |

Ordering data

| Description | Type | Order No. | Pcs. / Pkt. |
|---------------------------|--|-----------|-------------|
| NAMUR isolation amplifier | MACX MCR-SL-2NAM-R-UP ¹⁾ | 2865052 | 1 |
| | MACX MCR-SL-2NAM-R-UP-SP ¹⁾ | 2924304 | 1 |

Digital IN
NAMUR isolation amplifiers



Ex n



SIL IEC 61508



2 signal outputs: transistor (passive)

Functional safety
Ex: Ex
Housing width 12.5 mm

NAMUR isolation amplifier for operating proximity sensors and mechanical contacts

- Input for NAMUR proximity sensors (EN 60947-5-6), floating contacts or contacts with resistance circuit
- 2 signal outputs: transistor (passive); up to 5 kHz
- Signal output 2 can also be used as a fault signaling output
- Reversible direction of action (operating current or closed-circuit current behavior)
- Line fault detection (LFD), can be activated/deactivated, error message signaled by red flashing LED with inhibiting of transistor output
- Power supply and error indication possible via the DIN rail connector
- LED displays for indicating supply voltage, circuit state, and malfunctions to NAMUR NE 44
- 4-way electrical isolation
- Up to SIL 2 according to EN 61508
- Installation in zone 2 permitted

| | |
|---|----------------------------------|
| Input data | |
| Input signal | |
| No-load voltage | |
| Switching points | |
| Line error detection | |
| Switching output | |
| Maximum switching voltage | |
| Maximum switching current | |
| Drop (ΔU) | |
| Switching behavior | |
| Maximum switching frequency | |
| General data | |
| Supply voltage range | |
| Current consumption | |
| Power dissipation | |
| Electrical isolation | |
| | Input/output/supply, T-Connector |
| | Output 1/output 2 |
| Ambient temperature range | |
| Humidity | |
| Housing material | |
| Inflammability class according to UL 94 | |
| Dimensions W / H / D | |
| Screw connection solid / stranded / AWG | |
| Spring-cage connection (solid/stranded/AWG) | |
| Conformance / approvals | |
| Conformance | |
| ATEX | |
| Functional safety (SIL) | |

Technical data

| |
|--|
| NAMUR proximity sensors (EN 60947-5-6) |
| Floating switch contacts |
| Switch contacts with resistance circuit |
| 8 V DC $\pm 10\%$ |
| > 2.1 mA (conductive) / < 1.2 mA (blocking) |
| Break 0.05 mA $< I_{M1} < 0.35$ mA |
| Short-circuit $100 \Omega < R_{Sensor} < 360 \Omega$ |
| 2 transistor outputs, passive |
| 30 V DC (per output) |
| 50 mA (short-circuit resistant) |
| < 1.4 V |
| can be inverted using DIP switch |
| 5 kHz |
| 19.2 V DC ... 30 V DC |
| < 28 mA (24 V DC) |
| 800 mW |
| 300 V _{rms} (Rated insulation voltage, surge voltage category II; pollution degree 2, safe isolation as per EN 61010, EN 50178) |
| 2.5 kV (50 Hz, 1 min., test voltage) |
| 1 kV (50 Hz, 1 min., test voltage) |
| 50 V _{rms} (Rated insulation voltage, surge voltage category II; pollution degree 2, safe isolation as per EN 61010, EN 50178) |
| -20°C ... 60°C (Any mounting position) |
| 10% ... 95% (no condensation) |
| PA 66-FR |
| V0 |
| 12.5 / 99 / 114.5 mm |
| 0.2 ... 2.5 mm ² / 0.2 ... 2.5 mm ² / 24 - 14 |
| 0.2 ... 1.5 mm ² / 0.2 ... 1.5 mm ² / 24 - 16 |
| CE-compliant, additionally EN 61326 |
| Ex II 3 G Ex nA IIC T4 Gc X |
| SIL 2 according to EN 61508 |

| |
|---|
| Notes: |
| Information about the supply and error evaluation module as well as about the DIN rail connectors and marking material can be found from page 126 |
| Information about resistance circuits is given on page 183 |
| Information on "Plug and play" connection using system cabling can be found from page 128 |
| 1) EMC: Class A product, see page 571 |

| |
|----------------------------------|
| Description |
| NAMUR isolation amplifier |
| Screw connection |
| Spring-cage conn. |

Ordering data

| Type | Order No. | Pcs. / Pkt. |
|--------------------------------------|-----------|-------------|
| MACX MCR-SL-NAM-2T ¹) | 2865023 | 1 |
| MACX MCR-SL-NAM-2T-SP ¹) | 2924278 | 1 |

Digital IN
NAMUR isolation amplifiers

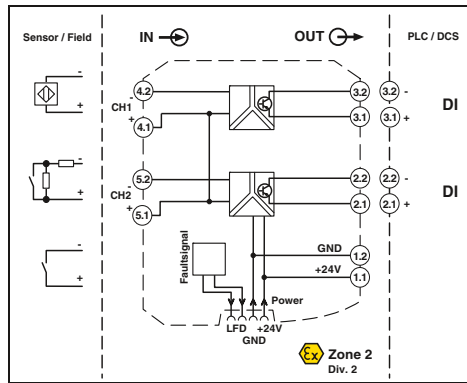

2-channel, signal output transistor (passive)

Functional safety
Ex: Ex n
Housing width 12.5 mm

NAMUR isolation amplifier for operating proximity sensors and mechanical contacts

- 2-channel
- Input for NAMUR proximity sensors (EN 60947-5-6), floating contacts or contacts with resistance circuit
- Signal output transistor (passive); up to 5 kHz
- Reversible direction of action (operating current or closed-circuit current behavior)
- Line fault detection (LFD), can be activated/deactivated, error message signaled by red flashing LED with inhibiting of transistor output
- Power supply and error indication possible via the DIN rail connector
- LED displays for indicating supply voltage, circuit state, and malfunctions to NAMUR NE 44
- 3-way electrical isolation
- Up to SIL 2 according to EN 61508
- Installation in zone 2 permitted

| | |
|---|----------------------------------|
| Input data | |
| Input signal | |
| No-load voltage | |
| Switching points | |
| Line error detection | |
| Switching output | |
| Maximum switching voltage | |
| Maximum switching current | |
| Drop (ΔU) | |
| Switching behavior | |
| Maximum switching frequency | |
| General data | |
| Supply voltage range | |
| Current consumption | |
| Power dissipation | |
| Electrical isolation | |
| | Input/output/supply, T-Connector |
| | Output 1/output 2 |
| Ambient temperature range | |
| Humidity | |
| Housing material | |
| Inflammability class according to UL 94 | |
| Dimensions W / H / D | |
| Screw connection solid / stranded / AWG | |
| Spring-cage connection (solid/stranded/AWG) | |
| Conformance / approvals | |
| Conformance | |
| ATEX | |
| Functional safety (SIL) | |

Technical data

| |
|--|
| NAMUR proximity sensors (EN 60947-5-6) |
| Floating switch contacts |
| Switch contacts with resistance circuit |
| 8 V DC $\pm 10\%$ |
| > 2.1 mA (conductive) / < 1.2 mA (blocking) |
| Break 0.05 mA $< I_{M} < 0.35$ mA |
| Short-circuit $100 \Omega < R_{Sensor} < 360 \Omega$ |
| Transistor output, passive |
| 30 V DC (per output) |
| 50 mA (short-circuit resistant) |
| < 1.4 V |
| can be inverted using DIP switch |
| 5 kHz |
| 19.2 V DC ... 30 V DC |
| < 34 mA (24 V DC) |
| 1000 mW |
| 300 V _{rms} (Rated insulation voltage, surge voltage category II; pollution degree 2, safe isolation as per EN 61010, EN 50178) |
| 2.5 kV (50 Hz, 1 min., test voltage) |
| 1 kV (50 Hz, 1 min., test voltage) |
| 50 V _{rms} (Rated insulation voltage, surge voltage category II; pollution degree 2, safe isolation as per EN 61010, EN 50178) |
| -20°C ... 60°C (Any mounting position) |
| 10% ... 95% (no condensation) |
| PA 66-FR |
| V0 |
| 12.5 / 99 / 114.5 mm |
| 0.2 ... 2.5 mm ² / 0.2 ... 2.5 mm ² / 24 - 14 |
| 0.2 ... 1.5 mm ² / 0.2 ... 1.5 mm ² / 24 - 16 |
| CE-compliant, additionally EN 61326 |
| Ex II 3 G Ex nA IIC T4 Gc X |
| SIL 2 according to EN 61508 |

| |
|---|
| Notes: |
| Information about the supply and error evaluation module as well as about the DIN rail connectors and marking material can be found from page 126 |
| Information about resistance circuits is given on page 183 |
| Information on "Plug and play" connection using system cabling can be found from page 128 |
| 1) EMC: Class A product, see page 571 |

Ordering data

| Description | Type | Order No. | Pcs. / Pkt. |
|----------------------------------|-------------------------------------|-----------|-------------|
| NAMUR isolation amplifier | | | |
| Screw connection | MACX MCR-SL-2NAM-T ¹⁾ | 2865036 | 1 |
| Spring-cage conn. | MACX MCR-SL-2NAM-T-SP ¹⁾ | 2924281 | 1 |

Accessories

Power and error message module

Power and error message module for feeding the 24 V supply voltage to the DIN rail connectors and signaling line faults and power supply failures.

- One-time or redundant supply, decoupled from diode, protected against polarization
- Supply current up to 3.75 A
- Relay output (PDT) and flashing LED for error messages
- Error message in the event of a power supply failure or fuse fault
- Bus cable fault message for MACX MCR-...(2)NAM... devices connected via DIN rail connectors
- Replaceable fuse
- Installation in zone 2 permissible



Ex n



Ex: Ex n IIC T4 Gc X // Applied for: cUL / UL
Housing width 17.5 mm

Technical data

| | |
|---|--|
| Input data | |
| Input signal | |
| Redundant supply | |
| Polarization and surge protection | |
| Output data | |
| Maximum output signal | |
| Output voltage | |
| Switching output | |
| Contact type | |
| Contact material | |
| Maximum switching voltage | |
| General data | |
| Current consumption | |
| Ambient temperature range | |
| Humidity | |
| Fuse | |
| Status indication | |
| Housing material | |
| Inflammability class according to UL 94 | |
| Dimensions W / H / D | |
| Screw connection solid / stranded / AWG | |
| Spring-cage connection (solid/stranded/AWG) | |
| Conformance / approvals | |
| Conformance | |
| ATEX | |
| IECEX | |
| UL, USA / Canada | |

| |
|---|
| 19.2 V DC ... 30 V DC |
| yes, decoupled from diodes |
| Yes |
| 3.75 A |
| (Input voltage - max 0.8 V at 3.75 A) |
| Relay |
| 1 PDT |
| Gold (Au) |
| 50 V AC (2 A) |
| -20°C ... 60°C (Any mounting position) |
| 5% ... 95% (no condensation) |
| 5 A (replaceable), slow-blow 250 V AC |
| 1 x red LED (error) |
| 2 x green LEDs (PWR1 and PWR2) |
| Polyamide (PA 6.6) |
| V0 |
| 17.5 / 99 / 114.5 mm |
| 0.2 ... 2.5 mm ² / 0.2 ... 2.5 mm ² / 24 - 14 |
| 0.2 ... 1.5 mm ² / 0.2 ... 1.5 mm ² / 24 - 16 |

| |
|----------------------|
| CE-compliant |
| Ex n IIC T4 Gc X |
| Ex nA nC IIC T4 Gc X |
| UL 61010 |

Ordering data

| | |
|--|------------------------|
| Description | |
| Supply and error message module , including the relevant DIN rail connector ME 17,5 TBUS 1,5/5-ST-3,81 GN | |
| Screw connection | MACX MCR-PTB |
| Spring-cage conn. | MACX MCR-PTB-SP |

| Type | Order No. | Pcs. / Pkt. |
|-----------------|-----------|-------------|
| MACX MCR-PTB | 2865625 | 1 |
| MACX MCR-PTB-SP | 2924184 | 1 |

Accessories

ME 6,2 TBUS... T-Connector

DIN rail connector (5-pos.) for bridging the supply voltage of 12.5 mm wide MACX analog modules

- Reduces wiring costs
- System can be extended or module replaced even while process is active
- Inter-extendable



| | | Ordering data | | |
|-------------|---|---------------------------------------|----------------|-------------|
| Description | | Type | Order No. | Pcs. / Pkt. |
| | <p>DIN rail connector (TBUS), for bridging the supply voltage, can be snapped onto 35 mm DIN rails as per EN 60715, with UL approval</p> | | | |
| | | ME 6,2 TBUS-2 1,5/5-ST-3,81 GN | 2869728 | 10 |

Accessories

Marking material for device marking

- For device marking inside the control cabinet and in the field
- Self-adhesive with high adhesive strengths
- Large temperature range



| | | Ordering data | | |
|--|--|---------------------------|----------------|-------------|
| Description | Color | Type | Order No. | Pcs. / Pkt. |
| | <p>UniCard, with self-adhesive plastic labels</p> | | | |
| <p>10-part, lettering field size: 11 x 9 mm</p> | | UC-EMLP (11X9) | 0819291 | 10 |
| <p>UniCard, with self-adhesive plastic labels, marked according to customer specifications For ordering details, see Catalog 5 or www.phoenixcontact.net/products</p> | | | | |
| <p>10-part, lettering field size: 11 x 9 mm</p> | | UC-EMLP (11X9) CUS | 0824547 | 1 |

Termination carrier for MACX Analog Ex isolating amplifiers



Select standard DIN rail device



Select module carrier

TC... termination carriers are compact solutions for quickly and smoothly connecting DIN rail devices from the MACX Analog Ex series to input/output cards of automation systems using system cabling.

The termination carriers combine the advantages of modular DIN rail devices with those offered by plug and play rapid cabling solutions to provide a consistent solution for system technology.

Compact

- Saves up to 30% of space due to compact design

Robust and reliable

- Stable, vibration-resistant aluminum carrier device profile
- PCB is completely decoupled from modules
- PCB without active components
- Redundant supply and monitoring in separate DIN rail module

Easy maintenance

- Use of standard DIN rail devices
- Easy access to connection points
- Quick and safe module connection with plug-in and coded cable sets

Flexible

- Horizontal or vertical DIN rail mounting
- Profile section without pitch markings for I/O cards with specific number of channels
- Can be specifically adapted for I/O cards of various automation systems with different system plug types



Select controller-specific front adapter and system cable



Solutions are also available for MINI Analog, MACX Analog Ex, and Safety

Termination carrier for MACX Analog Ex isolating amplifiers

The **TC-D37SUB-ADIO16-EX-P-UNI** universal termination carrier is a compact solution which connects isolating amplifiers from the MACX Analog series to analog or binary input/output cards of automation systems.

The **TC-D37SUB-AIO16-EX-PS-UNI** termination carrier design, when combined with the MACX MCR-S-MUX HART multiplexer, also enables communication between HART-capable field devices and a management system.

- Connection of up to 16 single-channel (Ex i-)isolating amplifiers
- Universal 1:1 signal routing to a 37-pos. D-SUB plug-in connector
- For system cables with D-SUB socket and open ends for universal connection
- Redundant supply and monitoring in separate DIN rail module

Notes:
Contact us: specific termination carrier designs for I/O modules of various automation systems are available, planned or can be implemented according to your specifications.
1) EMC: Class A product, see page 571



Housing width 244 mm

| General data | |
|---|--|
| Connection to the control system level | |
| Number of positions | |
| Maximum operating voltage | |
| Maximum permissible current | |
| Rated insulation voltage | |
| Surge voltage category | |
| Pollution degree | |
| Rated surge voltage | |
| Air and creepage distances | |
| Degree of protection | |
| Ambient temperature range | |
| Shock | |
| Vibration (operation) | |
| Inflammability class according to UL 94 | |
| Dimensions W / H / D | |
| Power supply via power module | |
| Input voltage range | |
| Redundant supply | |
| Polarization and surge protection | |
| Fuse | |
| Status indication | |
| Switching output | |
| Contact material | |
| Maximum switching voltage | |

| Technical data | |
|---|--|
| D-SUB pin strip | |
| 37 | |
| < 50 V DC (Per signal/channel) | |
| 1 A (Signal/channel) | |
| 50 V | |
| II | |
| 2 | |
| 0.5 kV | |
| DIN EN 50178 (Basic insulation) | |
| IP20 | |
| -40°C ... 80°C (Please observe module specifications) | |
| 15g, according to IEC 60068-2-27 | |
| 2g, according to IEC 60068-2-6 | |
| V0 | |
| 244 / 170 / 160 mm | |
| Power supply via power module | |
| 19.2 V DC ... 30 V DC | |
| yes, decoupled from diodes | |
| Yes | |
| 5 A Slow-blow (can be exchanged) | |
| 1 x red LED (error) | |
| 2 x green LEDs (PWR1 and PWR2) | |
| 1 PDT | |
| Au | |
| 50 V DC (0.3 A) / 30 V DC (2 A) / 33 V AC (2 A) | |

| Description | |
|---|--|
| Universal termination carrier for 16 MACX MCR-EX isolators | |
| - With connection for MACX MCR-S-MUX HART multiplexer | |

| Ordering data | | |
|---|----------------|-------------|
| Type | Order No. | Pcs. / Pkt. |
| TC-D37SUB-ADIO16-EX-P-UNI | 2924854 | 1 |
| TC-D37SUB-AIO16-EX-PS-UNI¹⁾ | 2902932 | 1 |

| Supply and error message module | |
|-------------------------------------|--|
| HART multiplexer, 32-channel | |

| Accessories | | |
|------------------------|----------------|----------|
| MACX MCR-PTB | 2865625 | 1 |
| MACX MCR-PTB-SP | 2924184 | 1 |
| MACX MCR-S-MUX | 2865599 | 1 |

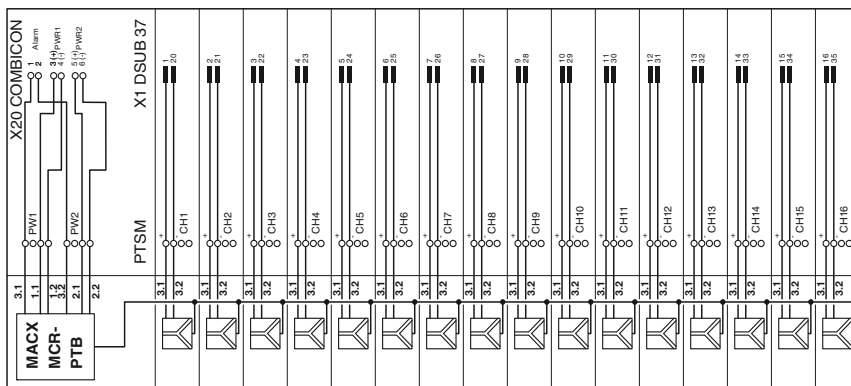

TC-D37SUB-ADIO16-EX-P-UNI and TC-D37SUB-AIO16-EX-PS-UNI connection scheme



Also for special applications

MCR Analog isolating amplifiers and digital displays – for special applications using signal processing.

Isolating amplifiers in the MCR Analog range can be used to record temperatures directly in the field, for example, or to convert digital signals into analog signals. You can monitor your process values using digital displays.

Choose the right MACX Analog isolating amplifier for your application:

Analog IN/Analog OUT

- Configurable signal multipliers to double standard analog signals
- Configurable loop-powered isolators and standard passive isolators for temperature
- Programmable temperature transducers
- Configurable temperature transducers for Pt 100
- Temperature relay for Pt 100
- Programmable loop-powered temperature transducers.

Frequency

- Programmable frequency transducers for frequencies of up to 120 kHz

Limit value switches

- Limit value switches for standard analog signals

Digital displays

- Programmable digital displays for standard signals
- Setpoint adjuster

Your advantages:

- High operational reliability in the event of disturbances, thanks to electrical isolation
- User-friendly wiring, thanks to plug-in connection terminal blocks
- Easy configuration via software, DIP switches or display keypad
- Digital displays can be programmed without software: via the keypad on the front
- The digital displays are easy to read, thanks to the large five-digit display

Analog IN / Analog OUT
3-way isolating amplifier

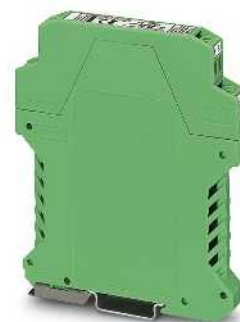
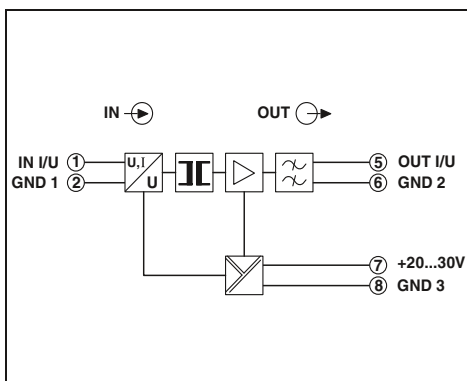
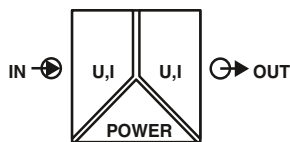

With fixed signal combinations



Housing width 12.5 mm

- Processing standard signals
- Fixed setting of input and output signals
- 3-way isolation

Notes:

1) EMC: Class A product, see page 571

| | |
|--------------------------------|---|
| Input data | Input signal Maximum input signal Input resistance |
| Output data | Output signal Maximum output signal Load R_B Linear transmission range (in reference to the output range end value) |
| General data | Supply voltage U_B Current consumption Maximum transmission error Temperature coefficient Limit frequency (3 dB) Step response (10 - 90%) Test voltage, input/output/supply Ambient temperature (operation) Mounting Housing material Dimensions W / H / D Screw connection solid / stranded / AWG |
| Conformance / approvals | Conformance |

| Technical data | |
|---|---------------------------|
| U input | I input |
| 0 ... 10 V / -10 ... 10 V | 0 ... 20 mA / 4 ... 20 mA |
| 30 V | 50 mA |
| 100 k Ω | 50 Ω |
| U output | I output |
| 0 ... 10 V / -10 ... 10 V | 0 ... 20 mA / 4 ... 20 mA |
| 15 V | 30 mA |
| ≥ 10 k Ω | ≤ 500 Ω |
| 0% ... 105% | -5% ... 105% |
| -110% ... 110% | (Bipolar signals) |
| 20 V DC ... 30 V DC | |
| < 15 mA (without load) | |
| $\leq 0.3\%$ (of final value), typ. < 0.2% (of final value) | |
| < 0.015%/K | |
| 30 Hz | |
| 11 ms | |
| 1.5 kV (50 Hz, 1 min.) | |
| -25°C ... 60°C | |
| Any | |
| Polyamide PA non-reinforced | |
| 12.5 / 99 / 114.5 mm | |
| 0.2 ... 2.5 mm ² / 0.2 ... 2.5 mm ² / 24 - 14 | |
| CE-compliant | |

| Description |
|--|
| MCR 3-way isolating amplifier , for electrical isolation of analog signals, |
| Input signal |
| 0 ... 10 V |
| 4 ... 20 mA |
| 0 ... 10 V, -10 ... 10 V |
| 0 ... 20 mA, 4 ... 20 mA |
| Output signal |
| 4 ... 20 mA |
| 0 ... 10 V |
| 0 ... 10 V, -10 ... 10 V |
| 0 ... 20 mA, 4 ... 20 mA |

| Ordering data | | |
|-------------------------------------|----------------|-------------|
| Type | Order No. | Pcs. / Pkt. |
| MCR-C-U-I- 4-DC¹⁾ | 2814537 | 5 |
| MCR-C-I-U- 4-DC¹⁾ | 2814511 | 5 |
| MCR-C-U-U-DC¹⁾ | 2814469 | 5 |
| MCR-C-I-I-00-DC¹⁾ | 2814508 | 5 |

Analog IN/Analog OUT signal multiplier



With freely configurable input and two outputs



Ex: Housing width 17.5 mm

- 4-way isolation
- Calibrated reversible input and output signals

Notes:
To order a product with an order configuration, enter the required configuration by referring to the adjacent order key.
1) EMC: Class A product, see page 571

| | |
|--------------------------------|---|
| Input data | Input signal |
| Measuring range span | Maximum input signal |
| Input resistance | 200 kΩ |
| Output data | Output signal (configurable using the DIP switch) |
| Maximum output signal | Load R_B |
| General data | Supply voltage U_B |
| | Current consumption |
| | Maximum transmission error |
| | Temperature coefficient |
| | Test voltage, input/output/supply |
| | Degree of protection |
| | Ambient temperature (operation) |
| | Housing material |
| | Dimensions W / H / D |
| | Screw connection solid / stranded / AWG |
| Conformance / approvals | Conformance |
| | UL, USA / Canada |

| Technical data | |
|---|---|
| U input | I input |
| 0 V ... 12 V (freely selectable in 0.1 V steps) | 0 mA ... 24 mA (freely selectable in 0.1 mA steps) |
| min. 4 V | min. 8 mA |
| 30 V | 50 mA |
| 200 kΩ | 50 Ω |
| U output | I output |
| refer to the order key | refer to the order key |
| 15 V | 35 mA |
| ≥ 10 kΩ | ≤ 600 Ω |
| Supply data | |
| 20 V DC ... 30 V DC | |
| < 25 mA | |
| ≤ 0.15% (of final value), typ. 0.05% (of final value) | |
| < 0.015%/K, typ. 0.0075%/K | |
| 1.5 kV (50 Hz, 1 min.) | |
| IP20 | |
| -25°C ... 55°C | |
| Polyamide PA non-reinforced | |
| 17.5 / 99 / 114.5 mm | |
| 0.2 ... 2.5 mm ² / 0.2 ... 2.5 mm ² / 24 - 14 | |
| Conformance | |
| CE-compliant | |
| Class I, Div. 2, Groups A, B, C, D or non-hazardous locations | |

| |
|--|
| Description |
| MCR signal multiplier , for multiplication and electrical isolation of analog signals, Order configuration Standard configuration |

| Ordering data | | |
|--|----------------|-------------|
| Type | Order No. | Pcs. / Pkt. |
| MCR-FL-C-UI-2UI-DCI¹⁾ | 2814854 | 1 |
| MCR-FL-C-UI-2UI-DCI-NC¹⁾ | 2814867 | 1 |

Order key for MCR-FL-C-UI-2UI-DCI (standard configuration entered as an example)

| Order No. | Input signal | Input signal (standard and special signals) | | Output signal (standard signals) | | Factory calibration certificate (FCC) |
|-----------|---------------------------------|--|---|--|--|---|
| | | Initial value | Final value | Output 1 | Output 2 | |
| 2814854 | I I ≙ Current U ≙ Voltage | 0.0 0.0 ≙ 0.0 mA I : freely selectable between 0.0 ... 24.0 mA U : freely selectable between 0.0 ... 12.0 V | 20.0 20.0 ≙ 20.0 mA I : freely selectable between 0.0 ... 24.0 mA U : freely selectable between 0.0 ... 12.0 V | OUT01 OUT01 ≙ 0...20 mA OUT02 ≙ 4...20 mA OUT03 ≙ 0...10 V OUT04 ≙ 2...10 V OUT05 ≙ 0...5 V OUT06 ≙ 1...5 V OUT16 ≙ 0...10 mA | OUT01 OUT01 ≙ 0...20 mA OUT02 ≙ 4...20 mA OUT03 ≙ 0...10 V OUT04 ≙ 2...10 V OUT05 ≙ 0...5 V OUT06 ≙ 1...5 V OUT16 ≙ 0...10 mA | NONE NONE ≙ without FCC YES ≙ with FCC (a fee is charged) YESPLUS ≙ FCC with 5 measuring points (a fee is charged) |

**8.0 mA/4.0 V min. measuring range span
0.1 mA/0.1 V increment**

Ordering examples:

| Order No. | Input signal | Input signal (standard and special signals) | | Output signal (standard signals) | | Factory calibration certificate (FCC) |
|-----------|------------------|---|---------------------|----------------------------------|----------------------------|---------------------------------------|
| | | Initial value | Final value | Output 1 | Output 2 | |
| 2814854 | I I ≙ Current | 5.3 I ≙ 5.3 mA | 13.3 I ≙ 13.3 mA | OUT01 OUT01 ≙ 0...20 mA | OUT01 OUT01 ≙ 0...20 mA | NONE NONE ≙ without FCC |

8.0 mA measuring range span, i.e., order is possible.

| Order No. | Input signal | Input signal (standard and special signals) | | Output signal (standard signals) | | Factory calibration certificate (FCC) |
|-----------|------------------|---|--------------------|----------------------------------|---------------------------|---------------------------------------|
| | | Initial value | Final value | Output 1 | Output 2 | |
| 2814854 | U U ≙ Voltage | 7.8 U ≙ 7.8 V | 11.8 U ≙ 11.8 V | OUT01 OUT01 ≙ 0...20 mA | OUT03 OUT03 ≙ 0...10 V | NONE NONE ≙ without FCC |

4.0 V measuring range span, i.e., order is possible.

Combination table for input and output signals that can be set via DIP switches

| Input | Output 1 | | | | | | Output 2 | | | | | | | |
|-----------|-----------|-----------|-----------|----------|---------|---------|----------|-----------|-----------|-----------|----------|---------|---------|----------|
| | 0...20 mA | 4...20 mA | 0...10 mA | 0...10 V | 0...5 V | 1...5 V | 2...10 V | 0...20 mA | 4...20 mA | 0...10 mA | 0...10 V | 0...5 V | 1...5 V | 2...10 V |
| 0...20 mA | x | x | x | x | x | x | x | x | x | x | x | x | x | x |
| 4...20 mA | x | x | x | x | x | x | x | x | x | x | x | x | x | x |
| 0...10 mA | x | x | x | x | x | x | x | x | x | x | x | x | x | x |
| 2...10 mA | x | x | x | x | x | x | x | x | x | x | x | x | x | x |
| 0...10 V | x | x | x | x | x | x | x | x | x | x | x | x | x | x |
| 2...10 V | x | x | x | x | x | x | x | x | x | x | x | x | x | x |
| 0...5 V | x | x | x | x | x | x | x | x | x | x | x | x | x | x |
| 1...5 V | x | x | x | x | x | x | x | x | x | x | x | x | x | x |

Application example: level measurement with subsequent signal multiplication

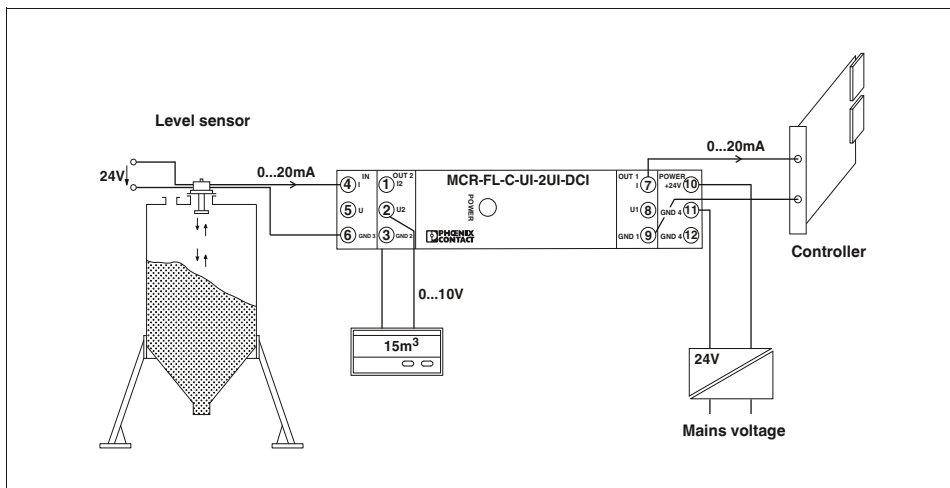

Analog IN / Analog OUT passive isolators



1-channel,
with safe isolation

Housing width 12.5 mm

- Electrical isolation without additional auxiliary power supply
- Current signals 0(4)...20 mA
- Safe isolation

Notes:

When using passive isolators, make sure that the current sourcing voltage of the measuring transducer U_B is sufficient to drive the maximum current of 20 mA via the passive isolator with the voltage drop $U_V = 2.5$ V and the load R_B .

This means:
 $U_B \geq U_E = 2.5$ V + 20 mA \times R_B

Technical data

Input data

Input signal
Voltage drop
Response current
Maximum input current
Maximum input voltage
Input voltage limitation

0 ... 20 mA / 4 ... 20 mA
2.5 V (at I = 20 mA)
< 50 μ A
50 mA (100 mA overload)
30 V (30 V overload)
33 V 5% (with Zener diode)

Output data

Output signal
Maximum output signal
Load R_B

0 ... 20 mA / 4 ... 20 mA
< 50 mA
 $\leq 1375 \Omega$ (at I = 20 mA output signal)

Ripple

< 5 mV (rms)

General data

Maximum transmission error
Additional error per 100 Ω load
Temperature coefficient
Test voltage input/output
Protection against electric shock

$\leq 0.1\%$ (of final value)
0.02% (of measured value / 100 Ω load)
 $\leq 0.002\%/K$ (of measured value / 100 Ω load)
4 kV (50 Hz, 1 min.)

Increased insulation according to DIN EN 61 010 part 1 and safe isolation according to VDE 0100 part 410 along the lines of VDE 0106 part 101 up to 300 V AC/DC for surge voltage category II and pollution degree 2 between all isolated distances.

Ambient temperature (operation)

-10°C ... 70°C

Housing material

Polyamide PA non-reinforced

Dimensions W / H / D

12.5 / 99 / 114.5 mm

Screw connection solid / stranded / AWG

0.2 ... 2.5 mm² / 0.2 ... 2.5 mm² / 24 - 14

Conformance / approvals

CE-compliant

Conformance

Ordering data

Description

MCR passive isolator, for electrical isolation of current signals without auxiliary power

| Type | Order No. | Pcs. / Pkt. |
|------------------------|-----------|-------------|
| MCR-SL-1CLP-I-I-00-4KV | 2814841 | 1 |

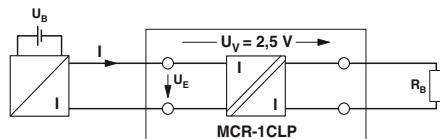

Input voltage in relation to load for $I_A = 20$ mA

The diagram shows input voltage U_i in relation to load R_B taking into account voltage failure U_V .

If the load is known, the minimum voltage the sensor must supply in order to drive the maximum current of 20 mA via the passive isolator and the load can be read on the Y-axis.

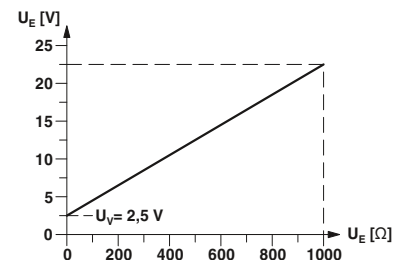

Analog IN / Analog OUT
passive isolators

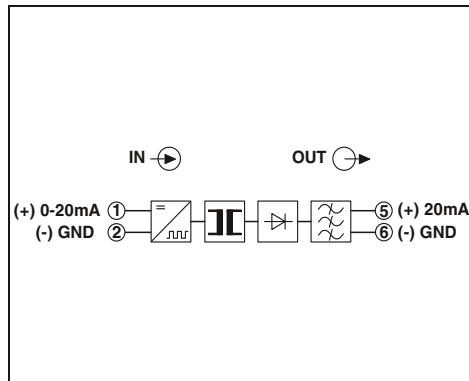
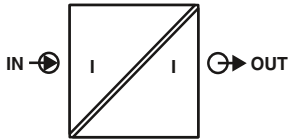

1-, 2- or 4-channel options



- Electrical isolation without additional auxiliary power supply
- Current signals 0(4)...20 mA
- Alternatively 1-, 2- or 4-channel version

Notes:

When using passive isolators, make sure that the current sourcing voltage of the measuring transducer U_B is sufficient to drive the maximum current of 20 mA via the passive isolator with the voltage drop $U_V = 2.5 \text{ V}$ and the load R_B .
This means:
 $U_B \geq U_E = 2.5 \text{ V} + 20 \text{ mA} \times R_B$

Input data

Input signal
Voltage drop
Response current
Maximum input current
Maximum input voltage
Input voltage limitation

Output data

Output signal
Maximum output signal
Load R_B

Ripple

General data

Additional error per 100 Ω load
Temperature coefficient

Test voltage input/output

Ambient temperature (operation)
Housing material
Dimensions H / D
Screw connection solid / stranded / AWG
Conformance / approvals
Conformance

Technical data

0 ... 20 mA / 4 ... 20 mA
2.5 V (at I = 20 mA)
< 50 μA
50 mA (100 mA overload)
30 V (30 V overload)
33 V (with Zener diode)

0 ... 20 mA / 4 ... 20 mA
< 50 mA
 $\leq 1375 \Omega$ (at I = 20 mA output signal)

< 5 mV (rms)

0.02% (of measured value)
 $\leq 0.002\%/K$ (of measured value / 100 Ω load)

510 V (50 Hz, 1 min.)

-10°C ... 70°C
Polyamide PA non-reinforced
99 / 114.5 mm

0.2 ... 2.5 mm² / 0.2 ... 2.5 mm² / 24 - 14

CE-compliant

Ordering data

Description

MCR passive isolator, for electrical isolation of current signals without auxiliary power
1-channel 12.5 mm wide
2-channel 12.5 mm wide
4-channel 22.5 mm wide

Type

MCR-1CLP-I-I-00
MCR-2CLP-I-I-00
MCR-4CLP-I-I-00

Order No.

2814016
2814029
2814045

Pcs. / Pkt.

1
1
1

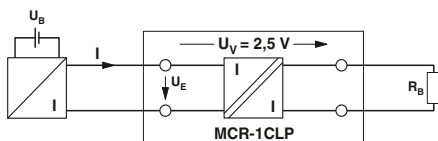

Flow measurement

Magnetic inductive flow sensor

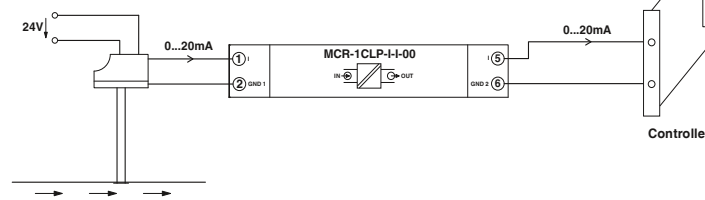

Temperature

Temperature transducer

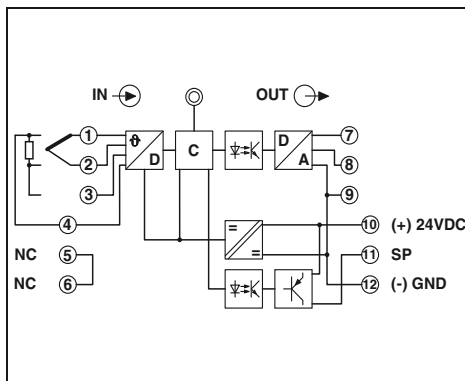
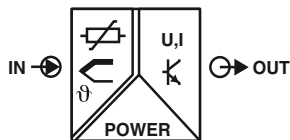

For resistance thermometers, thermocouples, resistance-type sensors, and mV sources

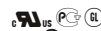

Ex: (UL)

Housing width 17.5 mm

- For resistance thermometers and thermocouples
- Measure differential temperatures
- With transistor switching output
- Freely programmable via MCR/PI-CONF-WIN
- Option of inverse output signal ranges

| Notes: |
|--|
| To order a product with an order configuration, enter the required configuration by referring to the adjacent order key. |
| Further information about the configuration software can be found on page 149 |
| 1) EMC: Class A product, see page 571 |

| Input data |
|--------------------------------------|
| Resistance thermometers |
| Thermocouple sensors |
| Resistor |
| Voltage |
| Temperature range |
| Sensor input current |
| Output data |
| Output signal |
| Maximum output signal |
| D/A resolution |
| Load R_B |
| Ripple |
| Output signal with open circuit |
| Measuring range overrange/underrange |
| Switching output |

| Technical data | |
|--|---------------------------|
| Pt, Ni, Cu sensors : 2, 3, 4-conductor | |
| U, T, L, J, E, K, N, S, R, B, C, W, HK | |
| 0 Ω ... 8000 Ω (freely adjustable, min. measuring range 100 Ω) | |
| -20 mV ... 2400 mV (freely adjustable, minimum measuring range span of 10 mV) (Depending on sensor type used) | |
| 250 μ A (resistance thermometer) | |
| U output | I output |
| 0 ... 5 V / 0 ... 10 V | 0 ... 20 mA / 4 ... 20 mA |
| -5 ... 5 V / -10 ... 10 V | - |
| ± 12 V | 24 mA |
| ± 12 bit | ± 12 bit |
| ≥ 10 k Ω | ≤ 500 Ω |
| < 20 mV _{pp} | |
| -12 V ... 12 V | 0 A ... 24 mA |
| -12 V ... 12 V | 0 A ... 24 mA |
| Transistor output, pnp | |
| Can carry a load of 100 mA, switches supply voltage (not protected against short-circuit); locked in case of order-specific configuration, otherwise freely programmable through MCR/PI-CONF-WIN | |

| General data |
|---|
| Supply voltage U_B |
| Current consumption |
| Maximum transmission error |
| Cold junction errors |
| Temperature coefficient |
| Test voltage input/output |
| Test voltage input/power supply |
| Ambient temperature (operation) |
| Mounting |
| Housing material |
| Dimensions W / H / D |
| Screw connection solid / stranded / AWG |
| Conformance / approvals |
| Conformance |
| UL, USA / Canada |
| GL |

| |
|---|
| 18 V DC ... 30 V DC |
| ≤ 60 mA, typ. 40 mA |
| $\leq 0.1\%$ (of maximum range, ± 6 mV or ± 12 μ A at output) |
| ≤ 3 K, typ. 1.5 K |
| $\leq 0.01\%/K$, typ. 0.005%/K |
| 1 kV (50 Hz, 1 min.) |
| 1 kV (50 Hz, 1 min.) |
| -20°C ... 65°C |
| Any |
| Polyamide PA non-reinforced |
| 17.5 / 99 / 114.5 mm |
| 0.2 ... 2.5 mm ² / 0.2 ... 2.5 mm ² / 24 - 14 |
| CE-compliant |
| Class I, Div. 2, Groups A, B, C, D or non-hazardous locations |
| Germanischer Lloyd |

| Description |
|---|
| MCR temperature measuring transducers , for resistance thermometers and thermocouple sensors, with electrical isolation of input/output and input/supply voltage |
| Order configuration |
| Standard configuration |
| Order configuration, without electrical isolation |
| Standard configuration, without electrical isolation |

| Ordering data | | |
|------------------------------|-----------|-------------|
| Type | Order No. | Pcs. / Pkt. |
| MCR-T-UI-E ¹) | 2814113 | 1 |
| MCR-T-UI-E-NC ¹) | 2814126 | 1 |
| MCR-T-UI ¹) | 2814090 | 1 |
| MCR-T-UI-NC ¹) | 2814100 | 1 |

Order key for MCR-T-UI(-E)... (standard configuration entered as an example)

| Order No. | Sensor type | Input characteristic curve | Connection technology | Measuring range: | | Measuring unit | Output | Output characteristic curve | Factory calibration certificate (FCC) |
|----------------------|--------------------------------|--|--|---------------------------|----------------------------|--|---|-----------------------------|--|
| | | | | Start | End | | | | |
| 2814113 | PT100 | D | 3 | -200.0 | +850.0 | C | OUT02 | N | NONE |
| 2814113 ≙ MCR-T-UI-E | See tables under "Sensor type" | D ≙ DIN S ≙ SAMA (see table) | 2 ≙ 2-conductor 3 ≙ 3-conductor 4 ≙ 4-conductor | for 0 mA (e.g., -200.0°C) | for 20 mA (e.g., +850.0°C) | C ≙ °C F ≙ °F V ≙ mV O ≙ W P ≙ % | OUT01 ≙ 0...20 mA OUT02 ≙ 4...20 mA OUT03 ≙ 0...10 V OUT05 ≙ 0...5 V OUT13 ≙ -5...+5 V OUT14 ≙ -10...+10 V | N ≙ Normal I ≙ Inverse | NONE ≙ without FCC YES ≙ with FCC (a fee is charged) |
| 2814090 ≙ MCR-T-UI | | 0 ≙ for Ni1000 (Landis & Gyr), Cu10, Cu50, Cu53, KTY81-110, thermocouple, resistor, potentiometer, voltage | 0 ≙ for thermocouple, resistor, potentiometer, voltage | | | | | | YESPLUS ≙ FCC with 5 measuring points (a fee is charged) |

Resistance thermometers

| Sensor type 1) | Standard (input characteristic curve) | Measuring range | Smallest measuring range span |
|----------------|---------------------------------------|------------------|-------------------------------|
| PT... | DIN/SAMA | -200°C ... 850°C | 0.4 K |
| NL... | DIN/SAMA | -60°C ... 180°C | 0.4 K |
| Ni1000 | Landis & Gyr | -50°C ... 160°C | 0.4 K |
| CU10 | SAMA | -70°C ... 500°C | 0.4 K |
| CU50 | - | -50°C ... 200°C | 0.4 K |
| CU53 | - | -50°C ... 180°C | 0.4 K |
| KTY81 | Philips | -55°C ... 150°C | 0.4 K |
| KTY84 | - | -40°C ... 300°C | 0.4 K |

Temperature ranges according to IEC 60751/EN 60751 and DIN 43760 SAMA RC 21-4-1966 with 2, 3 or 4-conductor circuit.

1) Note: Pt sensors in increments of 10, 20, ...100 and 100, 200, ...1000, 2000.
KTY81 ≙ KTY81-110.

Other types or characteristic curves available on request.

Thermocouples

| Sensor type | Thermocouple | Measuring range | Smallest measuring range span |
|-------------|--------------|-------------------|-------------------------------|
| U | Cu-CuNi | -200°C ... 600°C | > 1 K |
| T 2) | Cu-CuNi | -200°C ... 400°C | > 1 K |
| L | Fe-CuNi | -200°C ... 900°C | > 1 K |
| J 2) | Fe-CuNi | -210°C ... 1200°C | > 1 K |
| E 2) | NiCr-CuNi | -226°C ... 1000°C | > 1 K |
| K 2) | NiCr-Ni | -200°C ... 1372°C | > 1 K |
| N 2) | NiCrSi-NiSi | -200°C ... 1300°C | > 1 K |
| S 2) | Pt10Rh-Pt | -50°C ... 1768°C | > 4 K |
| R 2) | Pt13Rh-Pt | -50°C ... 1768°C | > 4 K |
| B 2) | Pt30Rh-Pt6Rh | 500°C ... 1820°C | > 10 K |
| C | - | -18°C ... 2316°C | > 4 K |
| W | - | -18°C ... 2316°C | > 4 K |
| HK | - | -200°C ... 800°C | > 1 K |

2) Thermocouples according to IEC 60584/EN 60584.

Other types or characteristic curves available on request.

Resistors, potentiometers, mV voltages

| Sensor type | Input | Measuring range | Smallest measuring range span |
|-------------|---------------------------|------------------------------|-------------------------------|
| RES | Resistor | 0 Ω ... 8000 Ω (2-conductor) | 2 Ω |
| POT | Potentiometer (max. 8 kΩ) | 0 ... 100% (3-conductor) | 0.2% |
| V01 | Voltage | -20 mV ... +2400 mV | 2 mV |

Temperature conversion guide for °C to °F:

$$T [°F] = \frac{9}{5} T [°C] + 32$$

Ordering examples with different input versions:

Resistance thermometer

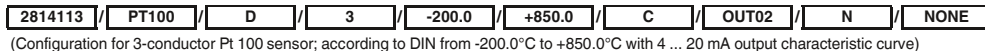

Thermocouple

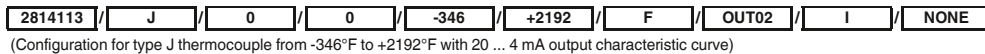

Voltage

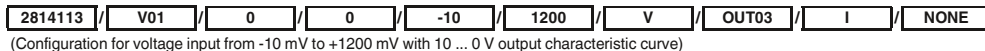

Resistor

(2-conductor connection)

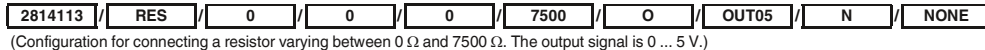

Potentiometer

(3-conductor connection)

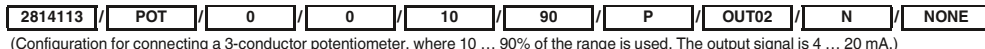

Application examples:

Resistance thermometer: 2-conductor connection technology

Application:
• For short distances (< 10 m)

Please note:
• Cable resistances R_{L1} and R_{L2} are incorporated in the measurement result directly and falsify the result accordingly (example for Pt 100: $0.385 \Omega \pm 1 K$). Compensation of $\pm 5\%$ is possible.

Resistance thermometer: 3-conductor connection technology

Application:
• For long distances between the Pt 100 sensor and the MCR module ($R_{L1}, R_{L2}, R_{L3} \leq 25 \Omega$)

Please note:
• To compensate the cable resistance, all cable resistances must have exactly the same values ($R_{L1} = R_{L2} = R_{L3}$)

Resistance thermometer: 4-conductor connection technology

Application:
• For long distances between the Pt 100 sensor and the MCR module and different cable resistances ($R_{L1} \neq R_{L2} \neq R_{L3} \neq R_{L4}$)

Please note:
• The cable resistance ($R_{L2} + R_{L4}$) must not exceed a value of 50 Ω.

Potentiometer

Application:
• For short distances and gradual changes.

Please note:
• Cable resistances R_{L1} and R_{L2} are incorporated in the measurement result directly and falsify the result accordingly. Compensation of $\pm 5\%$ is possible.

Thermocouple: absolute temperature measurement

Application:
• Connecting a thermocouple or an mV signal.

Note:
• Activate cold junction compensation for the device in the case of thermocouple measurements.

Thermocouple: differential temperature measurement

Application:
• Differential temperature measurement with thermocouples.
• Deactivate cold junction compensation for the device.

Temperature

Temperature transducer



For Pt 100, either voltage or current output

Housing width 17.5 mm

- Temperature range adjustable via DIP switch
- ZERO/SPAN adjustment
- Open circuit detection
- Alternatively with galvanically isolated supply voltage

Notes:
When ordering, you must use the order key to specify the desired configuration.
1) EMC: Class A product, see page 571

| |
|---|
| Input data |
| Resistance thermometers |
| Temperature range |
| Sensor input current |
| Output data |
| Output signal |
| Maximum output signal |
| Load R_B |
| Output signal with open circuit |
| General data |
| Supply voltage U_B |
| Current consumption |
| Maximum transmission error |
| Temperature coefficient |
| ZERO / SPAN adjustment |
| Step response (10 - 90%) |
| Test voltage power supply/signal |
| Ambient temperature (operation) |
| Housing material |
| Dimensions W / H / D |
| Screw connection solid / stranded / AWG |
| Conformance / approvals |
| Conformance |
| UL, USA / Canada |

| Technical data | | | | |
|--|------------------|---------------------------|-------------------|--|
| Pt 100 (IEC 60751/EN 60751) : 2, 3, 4-conductor | | | | |
| 0°C ... 300°C (0 ... 100/150/200/300) / -50°C ... 250°C (-50 ... 50/100/150/250) | | | | |
| Approx. 1 mA | | | | |
| U output | | I output | | |
| 0 ... 10 V | 15 V | 0 ... 20 mA / 4 ... 20 mA | 30 mA | |
| $\geq 10 \text{ k}\Omega$ | $> 11 \text{ V}$ | $\leq 500 \Omega$ | $> 22 \text{ mA}$ | |
| ...-U-DC | ...-I-DC | ...-U | ...-I | |
| 20 ... 30 V DC | 20 ... 30 V DC | 20 ... 30 V DC | 20 ... 30 V DC | |
| 35 mA | 60 mA | 20 mA | 45 mA | |
| $\leq 0.4\%$ (of final value) | | | | |
| $\leq 0.02\%/K$ | | | | |
| $\pm 5\% / \pm 5\%$ | | | | |
| 11 ms | | | | |
| 750 V AC (50 Hz, 1 min.) | | | | |
| -20°C ... 65°C | | | | |
| Polyamide PA non-reinforced | | | | |
| 17.5 / 99 / 114.5 mm | | | | |
| 0.2 ... 2.5 mm ² / 0.2 ... 2.5 mm ² / 24 - 14 | | | | |
| CE-compliant | | | | |
| UL 508 Recognized | | | | |

| |
|--|
| Description |
| MCR temperature measuring transducer , for Pt 100 temperature sensors with 2, 3, 4-conductor technology with electrically isolated supply voltage |
| Output: 0...0.10 V |
| Output: 0...(4)20 mA |
| Output: 0...10 V, without electrical isolation |
| Output: 0...(4)20 mA, without electrical isolation |

| Ordering data | | |
|------------------------------------|----------------|-------------|
| Type | Order No. | Pcs. / Pkt. |
| MCR-PT100-U-DC¹⁾ | 2810311 | 1 |
| MCR-PT100-I-DC¹⁾ | 2810337 | 1 |
| MCR-PT100-U¹⁾ | 2810340 | 1 |
| MCR-PT100-I¹⁾ | 2810353 | 1 |

Order key MCR-PT100-...(DC) (standard configuration entered as example)

| Order No. | Connection method | Temperature range | Output | Factory calibration certificate |
|----------------------------------|-------------------------|-----------------------------|--|---|
| 2810337 | 3 | TR05 | OUT02 | NONE |
| 2810311 $\hat{=}$ MCR-PT100-U-DC | 2 $\hat{=}$ 2-conductor | TR01 $\hat{=}$ -50...+50°C | OUT01 $\hat{=}$ 0...20 mA | NONE $\hat{=}$ Without certificate |
| 2810337 $\hat{=}$ MCR-PT100-I-DC | 3 $\hat{=}$ 3-conductor | TR02 $\hat{=}$ -50...+100°C | OUT02 $\hat{=}$ 4...20 mA | YES $\hat{=}$ With factory calibration certificate (fee) |
| 2810340 $\hat{=}$ MCR-PT100-U | 4 $\hat{=}$ 4-conductor | TR03 $\hat{=}$ -50...+150°C | With the devices: 2810311 MCR-PT100-U-DC 2810340 MCR-PT100-U The output signal is 0...10 V. No details are necessary. | YESPLUS $\hat{=}$ Factory calibration certificate with 5 measuring points (fee) |
| 2810353 $\hat{=}$ MCR-PT100-I | | TR04 $\hat{=}$ -50...+250°C | | |
| | | TR05 $\hat{=}$ 0...100°C | | |
| | | TR06 $\hat{=}$ 0...150°C | | |
| | | TR07 $\hat{=}$ 0...200°C | | |
| | | TR08 $\hat{=}$ 0...300°C | | |

Temperature
Temperature relay

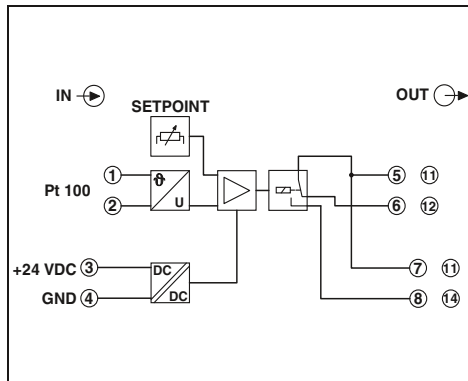

For Pt 100

Housing width 12.5 mm

- Switching point in the temperature range from -100°C ... +700°C freely selectable
- Changeover relay output
- Galvanically isolated
- Adjustable switch hysteresis

Notes:

1) EMC: Class A product, see page 571

Input data

Resistance thermometers
Temperature range
Sensor input current

Switching output

Contact type
Contact material
Maximum switching current

Operate delay time
Off delay time
Switching hysteresis

Error/status indicator

General data

Supply voltage U_B
Current consumption
Linearity error
Setting accuracy
Temperature coefficient
Test voltage, input/output/supply
Ambient temperature (operation)
Mounting
Housing material
Dimensions W / H / D
Screw connection solid / stranded / AWG
Conformance / approvals
Conformance
UL, USA / Canada

Technical data

Pt 100 (IEC 60751/EN 60751) : 2-conductor
-100°C ... 700°C
Approx. 1 mA
Relay output
1 PDT
AgSnO, hard gold-plated
50 mA (for gold layer, 30 V AC/ 36 V DC)
2 A (in case of a destroyed gold layer, 250 V AC)
Approx. 6 ms
Approx. 200 ms
Adjustable using DIP switches (0.5 K, 2 K, 3 K, 5 K)

Red LED (short-circuit/wire break) / Yellow LED (relay active)

20 V DC ... 30 V DC
< 30 mA
< 0.1%
< 1%, typ. < 0.5%
< 0.01%/K, typ. 0.005%/K
1.5 kV (50 Hz, 1 min.)
-20°C ... 65°C
Any
Polyamide PA non-reinforced
12.5 / 99 / 114.5 mm
0.2 ... 2.5 mm² / 0.2 ... 2.5 mm² / 24 - 14

CE-compliant
UL 508 Recognized

Ordering data

Description
MCR temperature relay, for Pt 100 in 2-conductor system

| Type | Order No. | Pcs. / Pkt. |
|-------------------------------|-----------|-------------|
| MCR-SL-PT100-SP ¹⁾ | 2814948 | 1 |

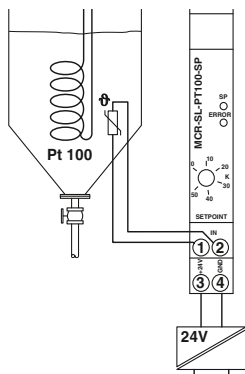

Application example - Temperature control of a heated medium
1 = mains voltage

Temperature

Temperature transducer

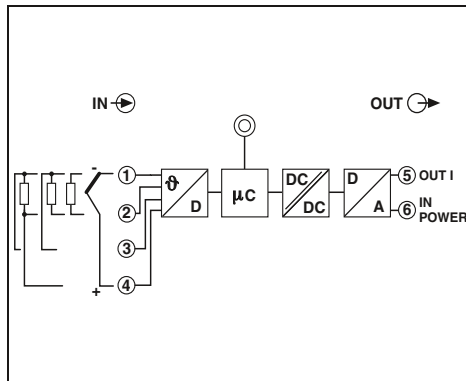
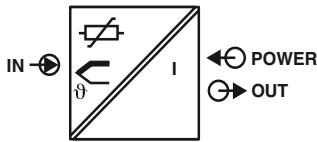

Loop-powered, programmable



Housing width 12.5 mm

- Two-wire transmitter for resistance thermometers, thermocouples, resistance-type, and voltage sensors
- Freely programmable via MCR/PI-CONF-WIN

Notes:
 The devices are supplied with the standard configuration: Pt 100 sensor, measuring range 0 ... 100°C, 3-cond. connection.
 You can implement your own measuring range settings, linearization, and characteristic curve adjustments. For this purpose, you need the MCR-PAC-T-USB programming adapter and the MCR/PI-CONF-WIN configuration software, see page 149

| | |
|---|--|
| Input data | |
| Resistance thermometers | |
| Thermocouple sensors | |
| Resistor | |
| Voltage | |
| Output data | |
| Output signal | |
| Load R_B | |
| Output signal with short-circuit | |
| Output signal with open circuit | |
| Measuring range overrange/underrange | |
| General data | |
| Supply voltage U_B | |
| Current consumption | |
| Transmission error | Resistance thermometers Thermocouple sensors Resistance-type sensors Voltage sensor |
| Step response (10 - 90%) | < 2 s |
| Pickup delay | 4 s |
| Test voltage input/output | 2 kV (50 Hz, 1 min.) |
| Degree of protection | IP20 |
| Ambient temperature (operation) | -40°C ... 85°C |
| Mounting | Any |
| Housing material | Polyamide PA non-reinforced |
| Dimensions W / H / D | 12.5 / 99 / 114.5 mm |
| Screw connection solid / stranded / AWG | 0.2 ... 2.5 mm ² / 0.2 ... 2.5 mm ² / 24 - 14 |
| Conformance / approvals | |
| Conformance | CE-compliant |
| UL, USA / Canada | Class I, Div. 2, Groups A, B, C, D |

Technical data

Pt, Ni (100, 500, 1000);
 minimum measurement range 10 K : 2, 3, 4-conductor
 B, C, D, E, J, K, L, N, R, S, T, U;
 minimum measurement range 50 K/500 K
 (Resistance-type sensor from 10 Ω to 400 Ω and from 10 Ω to 2000 Ω;
 minimum measurement range 10 Ω/100 Ω)

-10 mV ... 100 mV (min. measurement range 5 mV)

4 ... 20 mA / 20 ... 4 mA
 (Max ($V_{\text{supply}} - 12 \text{ V}$) / 0.023 A (current output))

≤ 3.6 mA or ≥ 21 mA (adjustable, not for thermocouples)

≤ 3.6 mA or ≥ 21 mA (adjustable)
 ≤ 20.5 mA / ≥ 3.8 mA (linear increase/decrease)

| |
|--|
| Description |
| MCR temperature measuring transducer, loop-powered |
| for resistance thermometers, thermocouples, resistance-type, and voltage sensors |

Ordering data

| Type | Order No. | Pcs. / Pkt. |
|----------------------|----------------|-------------|
| MCR-FL-T-LP-I | 2864561 | 1 |

Temperature
Temperature transducer

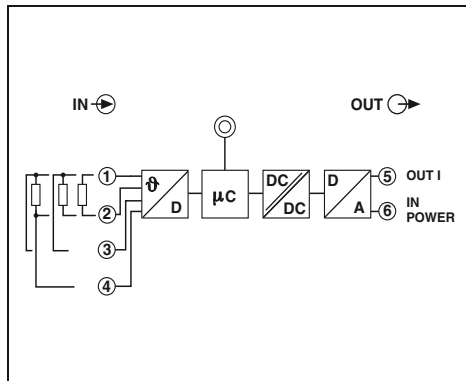
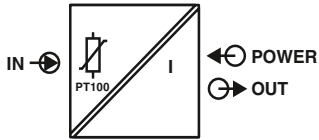

Loop-powered,
programmable



Ex: Housing width 12.5 mm

- Two-wire transmitter for Pt 100 resistance thermometers
- Freely programmable via MCR/PI-CONF-WIN

Notes:

The devices are supplied with the standard configuration: Pt 100 sensor, measuring range 0 ... 100°C, 3-cond. connection.

You can implement your own measuring range settings, linearization, and characteristic curve adjustments. For this purpose, you need the MCR-PAC-T-USB programming adapter and the MCR/PI-CONF-WIN configuration software, see page 149

Input data

Resistance thermometers

Output data

Output signal

Load R_B

Output signal with short-circuit

Output signal with open circuit

Measuring range overrange/underrange

General data

Supply voltage U_B

Current consumption

Transmission error

Step response (10 - 90%)

Pickup delay

Test voltage input/output

Degree of protection

Ambient temperature (operation)

Mounting

Housing material

Dimensions W / H / D

Screw connection solid / stranded / AWG

Conformance / approvals

Conformance

UL, USA / Canada

Resistance thermometers

Technical data

Pt 100 ; minimum measurement range 10 K : 2, 3, 4-conductor

4 ... 20 mA / 20 ... 4 mA
(Max (V_{supply} -12 V) / 0.023 A (current output))

≤ 3.6 mA or ≥ 21 mA (adjustable)

≤ 3.6 mA or ≥ 21 mA (adjustable)

≤ 20.5 mA / ≥ 3.8 mA (linear increase/decrease)

12 V DC ... 35 V DC

< 3.5 mA

0.2 K

< 2 s

4 s

2 kV (50 Hz, 1 min.)

IP20

-40°C ... 85°C

Any

Polyamide PA non-reinforced

12.5 / 99 / 114.5 mm

0.2 ... 2.5 mm² / 0.2 ... 2.5 mm² / 24 - 24

CE-compliant

Class I, Div. 2, Groups A, B, C, D

Ordering data

Description

MCR temperature measuring transducer, loop-powered

for Pt 100 resistance thermometer

Type

MCR-SL-PT100-LP-I

Order No.

2864558

Pcs. / Pkt.

1

Temperature

Temperature head transmitter

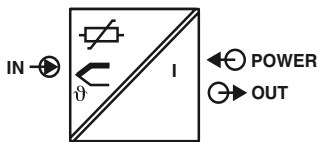

**Loop-powered,
programmable**



- Two-wire transmitter for resistance thermometers, thermocouples, resistance-type, and voltage sensors
- For mounting in the connecting head, form B
- Freely programmable via MCR/PI-CONF-WIN

Notes:
The devices are supplied with the standard configuration: Pt 100 sensor, measuring range 0 ... 100°C, 3-cond. connection.
You can implement your own measuring range settings, linearization, and characteristic curve adjustments. For this purpose, you need the MCR-PAC-T-USB programming adapter and the MCR/PI-CONF-WIN configuration software, see page 149

| | |
|---|--|
| Input data | |
| Resistance thermometers | |
| Thermocouple sensors | |
| Resistor | |
| Voltage | |
| Output data | |
| Output signal | |
| Load R_B | |
| Output signal with short-circuit | |
| Output signal with open circuit | |
| Measuring range overrange/underrange | |
| General data | |
| Supply voltage U_B | |
| Current consumption | |
| Transmission error | Resistance thermometers Thermocouple sensors Resistance-type sensors Voltage sensor |
| Step response (10 - 90%) | |
| Pickup delay | |
| Test voltage input/output | |
| Degree of protection | |
| Ambient temperature (operation) | |
| Mounting | |
| Housing material | |
| Screw connection solid / stranded / AWG | |
| Conformance / approvals | |
| Conformance | |
| UL, USA / Canada | |

| | |
|---|--|
| Technical data | |
| Pt, Ni (100, 500, 1000); minimum measurement range 10 K : 2, 3, 4-conductor B, C, D, E, J, K, L, N, R, S, T, U; minimum measurement range 50 K/500 K (Resistance-type sensor from 10 Ω to 400 Ω and from 10 Ω to 2000 Ω; minimum measurement range 10 Ω/100 Ω) | |
| -10 mV ... 75 mV (min. measurement range 5 mV) | |
| 4 ... 20 mA / 20 ... 4 mA (Max (V _{supply} - 8 V) / 0.025 A (current output)) | |
| ≤ 3.6 mA or ≥ 21 mA (adjustable, not for thermocouples) | |
| ≤ 3.6 mA or ≥ 21 mA (adjustable) ≤ 20.5 mA / ≥ 3.8 mA (linear increase/decrease) | |
| General data | |
| 8 V DC ... 35 V DC | |
| < 3.5 mA | |
| 0.2 K (Pt 100, Ni 100), 0.5 K (Pt 500, Ni 500), 0.3 K (Pt 1000, Ni 1000) | |
| Type 0.5 K (K, J, T, E, L, U), 1.0 K (N, C, D), 2.0 K (S, B, R) | |
| ±0.1 Ω (10...400 Ω), ±1.5 Ω (10...2000 Ω) | |
| ±20 µV (-10...100 mV) | |
| < 2 s | |
| 6 s | |
| 2 kV (50 Hz, 1 min.) | |
| IP00, IP66 (integrated in the connecting head) | |
| -40°C ... 85°C | |
| Any | |
| Polycarbonate, PC | |
| 0.2 ... 1.75 mm ² / 0.2 ... 1.75 mm ² / 24 - 15 | |
| Conformance | |
| CE-compliant | |
| Class I, Div. 2, Groups A, B, C, D | |

| |
|--|
| Description |
| MCR temperature measuring transducer, loop-powered |
| for resistance thermometers, thermocouples, resistance-type, and voltage sensors |

| | | |
|----------------------|------------------|--------------------|
| Ordering data | | |
| Type | Order No. | Pcs. / Pkt. |
| MCR-FL-HT-T-I | 2864529 | 1 |

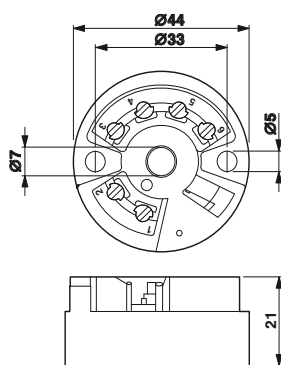

Temperature
Temperature head transmitter

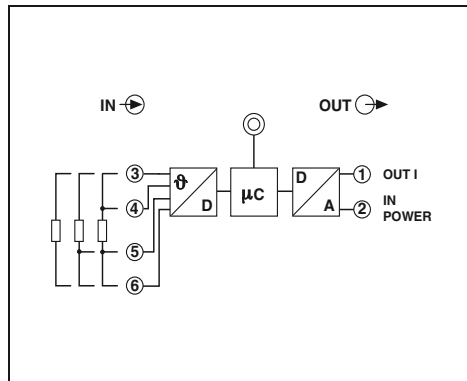

Loop-powered,
programmable



- Two-wire transmitter for Pt 100 resistance thermometers
- For mounting in the connecting head, form B
- Freely programmable via MCR/PI-CONF-WIN

Notes:

The devices are supplied with the standard configuration: Pt 100 sensor, measuring range 0 ... 100°C, 3-cond.connection.

You can implement your own measuring range settings, linearization, and characteristic curve adjustments. For this purpose, you need the MCR-PAC-T-USB programming adapter and the MCR/PI-CONF-WIN configuration software, see page 149

Input data

Resistance thermometers

Output data

Output signal

Load R_B

Output signal with short-circuit

Output signal with open circuit

Measuring range overrange/underrange

General data

Supply voltage U_B

Current consumption

Transmission error

Resistance thermometers

Step response (10 - 90%)

Pickup delay

Degree of protection

Ambient temperature (operation)

Mounting

Housing material

Conformance / approvals

Conformance

UL, USA / Canada

Technical data

Pt 100 ; minimum measurement range 10 K ; 2, 3, 4-conductor

4 ... 20 mA / 20 ... 4 mA

(Max ($V_{supply} - 10 V$) / 0.023 A (current output))

≤ 3.6 mA or ≥ 21 mA (adjustable)

≤ 3.6 mA or ≥ 21 mA (adjustable)

≤ 20.5 mA / ≥ 3.8 mA (linear increase/decrease)

10 V DC ... 35 V DC

< 3.5 mA

0.2 K

< 2 s

4 s

IP00, IP54 (integrated in the connecting head)

-40°C ... 85°C

Any

Polycarbonate, PC

CE-compliant

Class I, Div. 2, Groups A, B, C, D

Ordering data

Description

MCR temperature measuring transducer, loop-powered

for Pt 100 resistance thermometer

Type

MCR-SL-HT-PT 100-I

Order No.

2864516

Pcs. / Pkt.

1

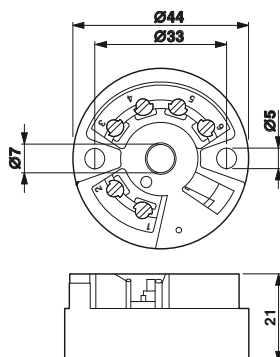

Frequency Frequency transducer

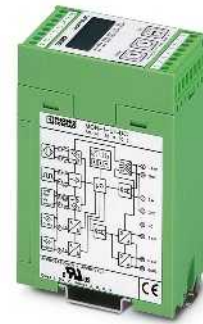
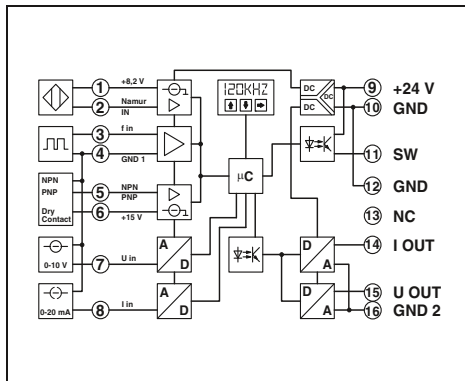
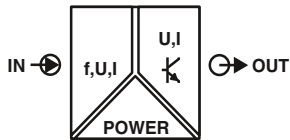

**Programmable,
for frequencies of up to 120 kHz**



Ex: (UL)

Housing width 45 mm

- Frequencies up to 120 kHz
- For NAMUR sensors, floating contacts, frequency generators, and NPN/PNP transistor outputs
- Analog and switching output
- 3-way isolation
- Programmable using membrane keypad or software
- Display of input or output signal

Notes:
Further information about the configuration software can be found on page 149
1) EMC: Class A product, see page 571

| | |
|--------------------------------|---|
| Input data | Frequency range Input sources |
| Transducer supply | Signal level |
| Maximum input signal | Signal form Pulse length Resolution Signal conversion time |
| Input data | Input signal |
| Maximum input signal | Input resistance Resolution |
| Output data | Output signal Maximum output signal Load R_B Ripple |
| Switching output | |
| General data | Supply voltage U_B Current consumption Maximum transmission error Temperature coefficient ZERO / SPAN adjustment Step response (10 - 90%) Test voltage, input/output/supply Ambient temperature (operation) Status indication Operating elements |
| Housing material | Dimensions W / H / D Screw connection solid / stranded / AWG |
| Conformance / approvals | Conformance / approvals |
| Conformance | UL, USA / Canada GL |

Technical data

| | |
|--|---|
| Frequency input | 0.1 Hz ... 120 kHz |
| NPN/PNP transistor outputs | NAMUR initiators Floating relay contact (dry contact) Frequency generator |
| Approx. 15 V DC / max. 25 mA (constant) | 2 V _{pp} (In case of rectangle 0.1 Hz ... 120 kHz) 2 V _{pp} (In case of sine 8 Hz ... 120 kHz) 13 V _{pp} (In case of sine 1 Hz ... 120 kHz) 30 V (incl. DC voltage) |
| Any | ≥ 1 μs > 12 bit ≤ 32 ms |
| Isolating amplifier function | 0 V ... 10 V (freely adjustable) 0 mA ... 20 mA (freely adjustable) |
| 12 V | 24 mA |
| 95 kΩ | 200 Ω |
| 14 bit (full-scale) | 14 bit (full-scale) |
| U output | I output |
| 0 ... 5 V / 0 ... 10 V | 0 ... 20 mA |
| 12.5 V | 25 mA |
| ≥ 500 Ω | ≤ 500 Ω |
| < 20 mV_{pp} | |
| Transistor output, pnp | Switches supply voltage to terminal block SW, can carry a load of 100 mA, not protected against short-circuit |

| | |
|-------------------------------|---|
| 20 V DC ... 30 V DC | < 60 mA (without load, without switching output) ≤ 0.15% (of measured value), typ. 0.1% 0.015%/K, typ. 0.01%/K ±25% / ±25% |
| < 25 ms | < 25 ms |
| 1.5 kV (50 Hz, 1 min.) | -20°C ... 65°C (for specified data) |
| LC display | Membrane keypad with 3 keys and LCD display |
| ASA-PC (V0) | 45 / 75 / 110 mm 0.2 ... 2.5 mm ² / 0.2 ... 2.5 mm ² / 24 - 14 |
| CE-compliant | Class I, Div. 2, Groups A, B, C, D or non-hazardous locations Germanischer Lloyd |

Ordering data

| | |
|--------------------|---|
| Description | MCR frequency measuring transducer , for conversion of frequencies into analog signals 0(4)...20 mA, 0...(5)10 V and their inverse signals |
|--------------------|---|

| | | |
|---------------------------------|------------------|--------------------|
| Type | Order No. | Pcs. / Pkt. |
| MCR-F-UI-DC¹⁾ | 2814605 | 1 |

Connection examples for common frequency transmitters

2-wire DC (mechanical contact)



3-wire DC
• With PNP transistor output



3-wire DC
• PNP transistor with pull-down resistance



2-wire DC NAMUR sensor

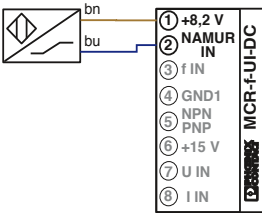

• With NPN transistor output

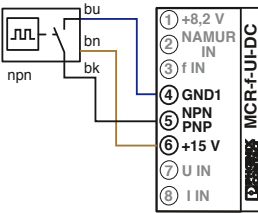

• NPN transistor with pull-up resistance

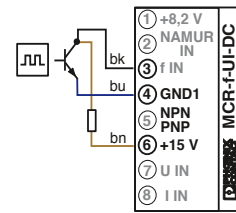

4-wire DC
• With PNP transistor output

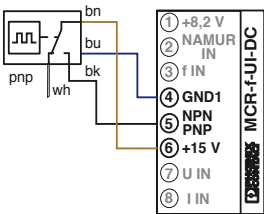

Incremental rotary transducer with push-pull:
• Supply of the external signaling encoder

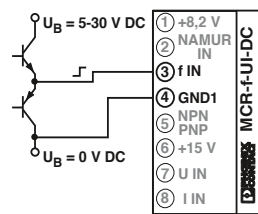

Incremental rotary transducer with HTL logic:
• Supply of the external signaling encoder

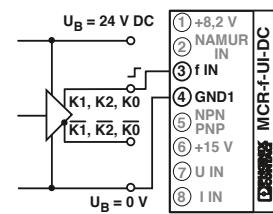

• With NPN transistor output

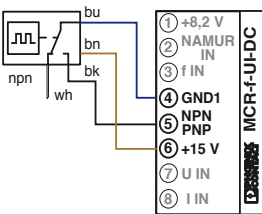

• Supply of the signaling encoder from the module

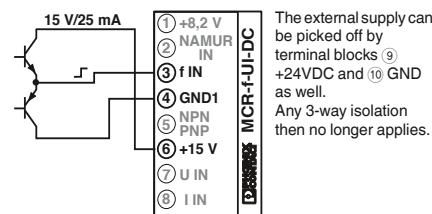

• Supply of the signaling encoder from the module

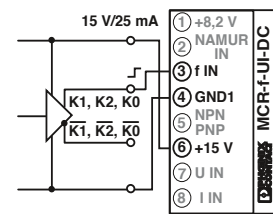

Application examples:

The **MCR-F-UI-DC** frequency transducer converts the pulse signal into an analog standard signal that provides information about the numbers of bottles in filling systems recorded in a defined time unit.

For speed measurements, it is possible to enter the measuring range in revolutions per minute (rpm) and to display the current measured value on the device.

The frequency measuring transducer has an automatic measuring range selection function (autorange) to ensure the best possible resolution. This permits response times to be reduced to a minimum and the measured value is optimally adapted to the input value.



Programmable limit value switch



MCR-PSP-DC



- For thermocouple sensors, resistance thermometers, and linear resistors
- For current or voltage signals
- Four independently adjustable switching thresholds
- With or without electrical isolation of input signals
- Programming via membrane keypad or **MCR-PICONF-WIN** software
- Continuous measured value display



Further information about the configuration software can be found on page 149

1) EMC: Class A product, see page 571

Technical data

Input data

Input sources

Measuring rate

Input resistance

Discontinuous control resolution

Switching output

Contact type

Contact material

Maximum switching voltage

Maximum switching current

Mechanical service life

Response delay

Status indication

General data

Supply voltage U_B

Current consumption

Maximum transmission error

Temperature coefficient

Test voltage input/power supply

Ambient temperature (operation)

Status indication

Mounting

Housing material

Conformance / approvals

Conformance

UL, USA / Canada

Current / voltage

Resistance thermometer 2, 3 or 4-conductor system (according to DIN 43760/DIN IEC 751 or SAMA RC 21-4-1966), e.g., PT sensors, Ni sensors, etc.

Thermocouple sensors (according to DIN IEC 584-1/DIN 43710):

B, E, J, K, L, N, R, S, T, U

Resistance: 0 k Ω ... 8 k Ω (only 2-conductor connection)

Current: -30 mA...+30 mA

Voltage: -30 V...+30 V

2 Hz

50 Ω / 200 k Ω

0.1°C / 0.01 V / 0.01 mA / 0.1 Ω

2 x PDT contact, / 2 switching points each, pick-up/drop-out (can be switched)

AgNi 0,15 + HTV (hard gold-plated)

250 V AC

2 A AC

2 x 10⁷ cycles

0 s ... 2 s (adjustable)

LED display

20 V DC ... 30 V DC

< 60 mA

0.1% (of final value)

\leq 0.01%/K

1 kV AC (50 Hz, 1 min.)

-20°C ... 65°C

5-position 7-segment display and LEDs

Any

ABS

CE-compliant

cULus

Description

MCR threshold value switch, with two relay contacts

With electrically isolated input

| Type | Order No. | Pcs. / Pkt. |
|--------------------------------|----------------|-------------|
| MCR-PSP-DC¹⁾ | 2811925 | 1 |
| MCR-PSP¹⁾ | 2811912 | 1 |

Limit values, threshold value switch

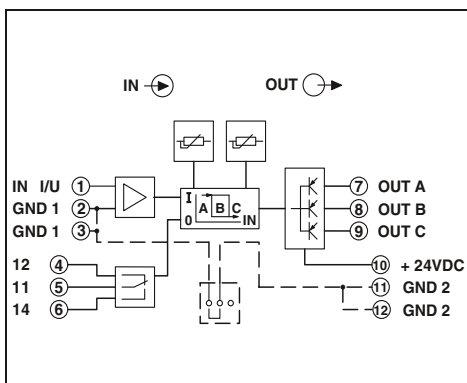
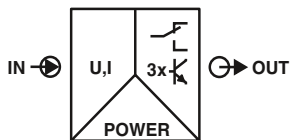

For either standard voltage or standard current signals



Housing width 17.5 mm

- 0 ... 10 V or 0 ... 20 mA input
- Relay/transistor output
- Limit indicator
- Adjustable hysteresis
- Monitoring of three signal statuses

Notes:

1) EMC: Class A product, see page 571

| | |
|--------------------------------|--|
| Input data | Input signal Maximum input signal Input resistance Limit value setting Setting range of the limit value Setting range for the hysteresis |
| Internal hysteresis | |
| Switching output | Number of outputs Output voltage Continuous load current |
| Switching output | Contact type Contact material Maximum switching voltage Maximum switching current Mechanical service life Error/status indicator |
| General data | Supply voltage U_B Current consumption Temperature coefficient Step response (10 - 90%) Ambient temperature (operation) Mounting Housing material Dimensions W / H / D Screw connection solid / stranded / AWG |
| Conformance / approvals | Conformance UL, USA / Canada |

| Technical data | |
|---|---|
| MCR-SWS-U ¹⁾ | MCR-SWS-I ¹⁾ |
| 0 ... 10 V | 0 ... 20 mA / 4 ... 20 mA |
| 11 V | 22 mA |
| $\geq 100 \text{ k}\Omega$ | $\leq 120 \Omega$ |
| Setting potentiometer, scaled 270° potentiometer | |
| 0 V ... 10 V | 0 A ... 20 mA |
| 0.1 V ... 10 V (setting accuracy: $\pm 30 \text{ mV}$) | 0.2 mA ... 20 mA (setting accuracy: $\pm 60 \mu\text{A}$) |
| $\pm 30 \text{ mV}$ (around the lower/upper switching point) | $\pm 60 \mu\text{A}$ (around the lower/upper switching point) |
| Transistor output, pnp | |
| 3 | |
| 20 V DC ... 30 V DC | |
| 100 mA | |
| Relay output | |
| 1 PDT | |
| AgNi 0,15 + HTV (hard gold-plated) | |
| 250 V AC (30 V DC) | |
| 2 A | |
| 10 ⁷ cycles | |
| | |
| 20 V DC ... 30 V DC | |
| Typ. 60 mA | |
| $\leq 0.02\%/K$ | |
| < 25 ms | |
| -20°C ... 65°C | |
| Any | |
| Polyamide PA non-reinforced | |
| 17.5 / 99 / 114.5 mm | |
| 0.2 ... 2.5 mm ² / 0.2 ... 2.5 mm ² / 24 - 14 | |
| | |
| CE-compliant | |
| UL 508 Recognized | |

| |
|--|
| Description |
| MCR threshold value switch , with adjustable hysteresis and relay/transistor output |
| Input: 0...0.10 V |
| Input: 0(4) - 20 mA |

| Ordering data | | |
|-------------------------|-----------|-------------|
| Type | Order No. | Pcs. / Pkt. |
| MCR-SWS-U ¹⁾ | 2766465 | 1 |
| MCR-SWS-I ¹⁾ | 2766478 | 1 |

Setpoint value potentiometer



Housing width 30 mm

– For direct setpoint definition in combination with a constant voltage source

Notes:

1) EMC: Class A product, see page 571

| |
|---|
| Input data |
| Resistance value |
| Linearity |
| Load capacity |
| General data |
| Ambient temperature (operation) |
| Mounting |
| Housing material |
| Dimensions W / H / D |
| Screw connection solid / stranded / AWG |

| Technical data | |
|---|---------------------|
| EMG 30-SP- 4K7LIN | EMG 30-SP-10K LIN |
| 4.7 kΩ ±20% | 10 kΩ ±20% |
| 5% (of final value) | 5% (of final value) |
| 1 W | 0.5 W |
| General data | |
| 0°C ... 40°C | |
| Any | |
| Polycarbonate fiber reinforced PC-F | |
| 30 / 75 / 68 mm | |
| 0.2 ... 4 mm² / 0.2 ... 2.5 mm² / 24 - 14 | |

| |
|---|
| Description |
| Setpoint potentiometer , to set setpoints individually |
| Resistance value 4.7 kΩ |
| Resistance value 10 kΩ |

| Ordering data | | |
|-------------------|-----------|-------------|
| Type | Order No. | Pcs. / Pkt. |
| EMG 30-SP- 4K7LIN | 2940252 | 10 |
| EMG 30-SP-10K LIN | 2942124 | 10 |

| |
|------------------------------------|
| MCR constant voltage source |
| With screw connection |
| With spring-cage connection |

| Accessories | | |
|---|-----------|-------------|
| | Order No. | Pcs. / Pkt. |
| MINI MCR-SL-CVS-24-5-10-NC ¹⁾ | 2902822 | 1 |
| MINI MCR-SL-CVS-24-5-10-SP-NC ¹⁾ | 2902823 | 1 |

Accessories

Configuration software package

The **MCR/PI-CONF-WIN configuration software package** is used to configure and visualize all parameters for the programmable MCR measuring transducers.

- Straightforward menu interface
- Rapid programming



Notes:
The software runs under the following operating systems: Windows NT™, 2000™, and XP™.

| |
|--|
| Description |
| MCR configuration software , for programming MCR-T-..., MCR-...-LP-..., MCR-...-HT-..., MCR-S-..., MCR-F-..., and MCR-PSP-... modules, CD-ROM |
| Labels , for labeling MCR-T and MCR-S modules, four sheets DIN A4 marking labels (112 pieces.) |

| Ordering data | | |
|-----------------|-----------|-------------|
| Type | Order No. | Pcs. / Pkt. |
| MCR/PI-CONF-WIN | 2814799 | 1 |
| Accessories | | |
| MCR-ET 38X35 WH | 2814317 | 1 |

USB adapter cable
Software adapter cable

The following adapter cables are available for programming:

- USB adapter cable
- Interface converter

The following modules are supported:

- MCR-T-UI(-E)...
- MCR-F-UI-DC
- MCR-PSP...
- MCR-FL-T-LP-I
- MCR-SL-PT100-LP-I
- MCR-FL-HT-T-I
- MCR-SL-HT-PT100-I



Data cable

| |
|---|
| Description |
| USB adapter cable , D-9-SUB to USB, with adapter D-9-SUB to D-25-SUB |
| Software adapter cable (stereo jack plug/25-pos. D-SUB), 1.2 m long, for programming MCR-T-..., MCR-S-..., and MCR-F-... modules |
| Software adapter cable (6-pos./D-SUB 25-pos.), 1.5 m length, for programming MCR-PSP modules |
| Software adapter cable , 2.4 m length, with USB connection, for programming MCR-...-LP-... and MCR-...-HT-... modules |
| Adapter cable , stranded, 9-pos. D-SUB socket on 25-pos. D-SUB pin |

| Ordering data | | |
|---------------------|-----------|-------------|
| Type | Order No. | Pcs. / Pkt. |
| CM-KBL-RS232/USB | 2881078 | 1 |
| MCR-TTL-RS232-E | 2814388 | 1 |
| MCR-TTL-RS232 | 2814391 | 1 |
| MCR-PAC-T-USB | 2309000 | 1 |
| Accessories | | |
| PSM-KAD 9 SUB 25/BS | 2761295 | 1 |

Analog IN standard signals



For standard analog signals, programmable

- For 0 ... 10 V and 0(4) ... 20 mA standard analog signals
- Programmable
- 5 positions displayed
- 8 mm LED, 7-segment
- Galvanically isolated
- Min./max. value saving
- Freely programmable decimal point display
- Latch/hold function for storing the display value
- Display 48 x 24 mm

| Input data | |
|---|----------------------------------|
| Input signal | |
| Maximum input signal | |
| Input resistance | |
| Resolution | |
| Measuring rate | |
| Input latch signal | |
| Switching level | 1 signal ("H") 0 signal ("L") |
| Output data | |
| Display | |
| Number of the displayed positions | |
| Accuracy | |
| General data | |
| Supply voltage U_B | |
| Current consumption | |
| Data memory | |
| Resolution A/D | |
| System hum suppression | |
| Test voltage input/power supply | |
| Degree of protection | |
| Ambient temperature (operation) | |
| Housing material | |
| Dimensions W / H / D | |
| Control panel cutout | |
| Screw connection solid / stranded / AWG | |
| Conformance / approvals | |
| Conformance | |
| UL, USA / Canada | |

Housing width 48 mm

| Technical data | |
|---|--|
| U input | I input |
| 0 ... 10 V | 0 ... 20 mA / 4 ... 20 mA |
| 30 V DC | 50 mA |
| > 1 MΩ | (approx. 100 Ω with 5 mA / approx. 70 Ω with 20 mA) |
| 1 mV | 2 µA |
| 0.5 to 2 measurements/second | |
| Display stop | |
| 4 V DC ... 30 V DC | |
| 0 V DC ... 2 V DC | |
| 7-segment LED; 8 mm; red | |
| 5 | |
| < 0.1% ±1 digit (At an ambient temperature of 20°C) | |
| 10 V DC ... 30 V DC | |
| 50 mA | |
| EEPROM 1 mil. memory cycles or 10 years | |
| 14 bit | |
| Digital filtering 50/60 Hz | |
| 500 V _{rms} (50/60 Hz, 1 min.) | |
| IP65 from the front | |
| -10°C ... 50°C | |
| Macrolon 2405 | |
| 48 / 24 / 68 mm | |
| 22(+0.6)x45(+0.8) mm | |
| 0.14 ... 1.5 mm ² / 0.14 ... 1.5 mm ² / 26 - 16 | |
| Ordering data | |
| CE-compliant | |
| UL 508 Recognized | |

| Description |
|--|
| MCR digital display , for measurement and display of standard signals |
| MCR DIN rail adapter for digital displays in a 24 x 48 mm housing |

| Type | Order No. | Pcs. / Pkt. |
|--------------|-----------|-------------|
| MCR-SL-D-U-I | 2864011 | 1 |
| Accessories | | |
| MCR-SL-D-RA | 2810081 | 1 |

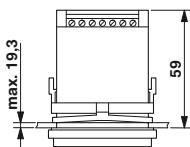
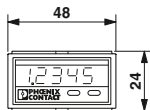

Analog OUT
setpoint adjuster



With manual and automatic ramp function

- Manual setpoint definition with step width setting
- Manual setpoint definition via direct input
- Automatic setpoint definition with hold function and 20 support points
- Highly adjustable 0 ... 12 V or 0 ... 24 mA signal ranges
- Data backup in case of a power failure
- Display value parameterization
- Electrical isolation between output and supply

| Input data | |
|---|---|
| Display | 7-segment, 8 mm, red |
| Number of the displayed positions | 4 |
| Switching level | 1 signal ("H") 0 signal ("L") |
| Output data | |
| Output signal | U output 0 ... 12 V |
| Length of step | 10 mV |
| Load R _B | ≥ 2 kΩ |
| Ripple | ≤ 10 mV _{PP} |
| General data | |
| Supply voltage U _B | 10 V DC ... 30 V DC |
| Power consumption | 1 W (With 24 mA/12 V) |
| Maximum transmission error | < 0.2% ((full-scale) at rated voltage) |
| Test voltage output/power supply | 500 V AC (50 Hz, 1 min.) |
| Degree of protection | IP65 from the front |
| Ambient temperature (operation) | -20°C ... 65°C |
| Housing material | Macrolon 2405 |
| Dimensions W / H / D | 48 / 24 / 68 mm |
| Control panel cutout | 45(+0.6)x22.2(+0.3) mm |
| Screw connection solid / stranded / AWG | 0.14 ... 1.5 mm ² / 0.14 ... 1.5 mm ² / 26 - 16 |
| Conformance / approvals | |
| Conformance | CE-compliant |
| UL, USA / Canada | UL 508 Recognized |

Housing width 48 mm

| Technical data | | |
|---|-----------------------|--|
| U output | I output | |
| 0 ... 12 V | 0 ... 24 mA | |
| 10 mV | 10 µA | |
| ≥ 2 kΩ | ≤ 500 Ω (Up to 20 mA) | |
| | ≤ 400 Ω (> 20 mA) | |
| ≤ 10 mV _{PP} | | |
| 10 V DC ... 30 V DC | | |
| 1 W (With 24 mA/12 V) | | |
| < 0.2% ((full-scale) at rated voltage) | | |
| 500 V AC (50 Hz, 1 min.) | | |
| IP65 from the front | | |
| -20°C ... 65°C | | |
| Macrolon 2405 | | |
| 48 / 24 / 68 mm | | |
| 45(+0.6)x22.2(+0.3) mm | | |
| 0.14 ... 1.5 mm ² / 0.14 ... 1.5 mm ² / 26 - 16 | | |
| CE-compliant | | |
| UL 508 Recognized | | |

| Description |
|--|
| MCR digital setpoint encoder , for presetting current and voltage signals |
| MCR DIN rail adapter for digital displays in a 24 x 48 mm housing |

| Ordering data | | |
|-----------------|-----------|-------------|
| Type | Order No. | Pcs. / Pkt. |
| MCR-SL-D-SPA-UI | 2710314 | 1 |
| Accessories | | |
| MCR-SL-D-RA | 2810081 | 1 |

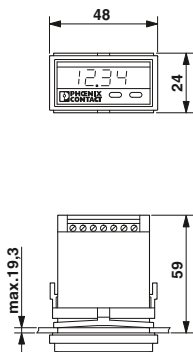



Highly compact – leading technology

MACX Analog Ex – single- and two-channel signal isolating amplifiers for intrinsically safe circuits in the Ex area.

MACX Analog Ex isolating amplifiers ensure maximum system safety and explosion protection within a minimum amount of space. With a design width of just 12.5 mm, this comprehensive range for analog signal conditioning is approved according to ATEX and IECEx and consistently SIL-certified.

Maximum explosion protection for all Ex zones and gas groups

Many process technology systems have areas where potentially explosive atmospheres may occur. As such, measuring and control circuits are usually designed with intrinsic safety protection type Ex i.

MACX Analog Ex i isolating amplifiers and measuring transducers isolate intrinsically safe circuits from non-intrinsically safe circuits and safely limit the energy supplied to the Ex area. Furthermore, they handle extensive signal conditioning tasks.

All MACX Analog Ex isolating amplifiers are approved in accordance with the applicable ATEX and IECEx standards:

- [Ex ia] – for intrinsically safe circuits up to Ex zone 0 and Ex zone 20
- Ex n – for installing devices in Ex zone 2
- In addition, relevant national approvals

such as UL and GOST are available.

Choose the right MACX Analog Ex isolating amplifier for your application:

Analog IN

Measuring transducer repeater power supply and input isolating amplifier for the intrinsically safe operation of 2-wire transmitters, 4-conductor measuring transducers, and current sources.

Analog OUT

Output isolating amplifiers for the intrinsically safe operation of control valves, I/P converters, and displays.

Temperature

Configurable temperature transducers for the intrinsically safe operation of resistance thermometers, remote resistance-type sensors, thermocouples, and mV sources – with safe limit value relays as an option.

Digital IN

NAMUR isolating amplifiers for the intrinsically safe operation of proximity sensors and switches.

Digital OUT

Solenoid drivers for the intrinsically safe operation of solenoid valves and alarm transmitters.



DIN rail connector-compatible

The DIN rail connector enables the modular bridging of the 24 V supply voltage.



Wide-range power supply

The modules featuring a wide-range power supply (...-UP) can be used in all power supply networks the world over without the need for additional power supply units.

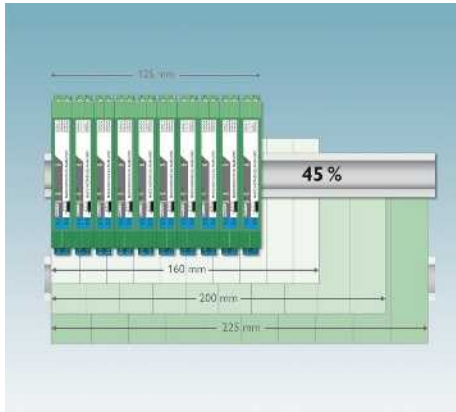

Significant space savings

- Housing width of just 12.5 mm for all single- and two-channel 24 V devices. Saves up to 45% of space, when compared to design widths up to 22.5 mm.



Easy-maintenance connection method:

- Plug-in connection terminal blocks with screw connection or fast push-in technology – coded, with integrated sockets.

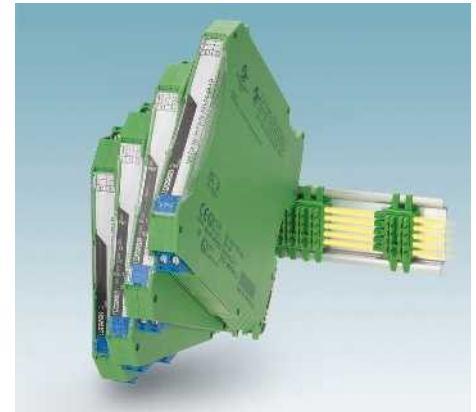

Flexible power bridging and diagnostics

- Supply voltage bridging and the option of redundant, diode-decoupled supply and error indication.



Easy configuration and monitoring

- Either via FDT/DTM or user-friendly stand-alone software – with integrated monitoring function.



Easy configuration

- Without software via DIP switches on the device front or with the operator interface and display unit.

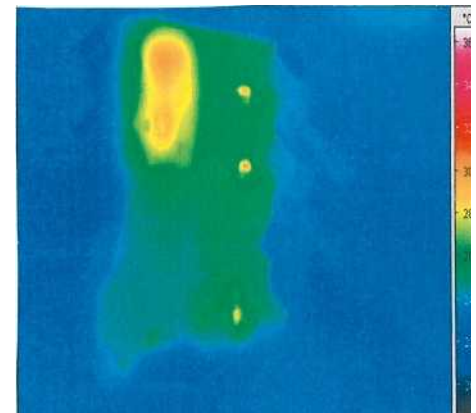

Precise transmission, long service life

- Patented circuit concepts ensure precise transmission and minimal self-heating.



High operational reliability

- High operational reliability, thanks to safe 3-way electrical isolation.



Safe and reliable functions

- Consistent SIL certification. This ensures the highest level of reliability and safety for your systems.



Fast and error-free signal connection

- Compact termination carriers connect MACX Analog Ex devices to the automation system – plug and play.

Facts about explosion protection

The chemical and petrochemical industries involve industrial processes which produce explosive atmospheres. They are caused, for example, by gases, fumes or vapors. Explosive atmospheres are also likely to occur in mills, silos, and sugar and fodder factories due to the dust present there.

Therefore, electrical devices in potentially explosive areas are subject to special directives.

Devices and protective systems in potentially explosive areas

European Parliament directive 94/9/EC of March 23, 1994 (ATEX manufacturer directive) is of particular importance within CENELEC (European Community and Western European EFTA states). It is designed to facilitate the harmonization of legal provisions in the member states of the European Union for devices and protective systems in terms of ensuring correct use in potentially explosive areas. Directive 94/9/EC must be applied to all explosion-protected devices and protective systems placed on the market in the European Union.

The scope of this directive also includes safety, monitoring, and control devices which are used outside of potentially explosive areas, but which are necessary for, or contribute towards, the safe operation of devices and protective systems with respect to explosion hazards.

The term **device** includes machines, equipment, stationary or mobile devices, control components, and system accessories. The directive also covers alarm and protection systems which are meant to be used, either individually or in combination, for the generation, transmission, storage, measurement, control, and conversion of energy as well as for processing materials and which have the potential to ignite and cause an explosion.

Protective systems are devices designed to stop an incipient explosion immediately and/or restrict the area affected by the explosion, and which are placed on the market separately as autonomous systems.



Components are defined as those parts that are necessary for ensuring the safe operation of devices and protective systems, but do not perform an autonomous function in themselves.

European directives are implemented in ordinances or laws at a national level.

Systems in potentially explosive areas

Directive 1999/92/EC (ATEX Operator Directive) was passed in Europe to regulate the operation of systems in potentially explosive areas.

| Terminology associated with the Ex area | |
|--|--|
| Explosive atmosphere | A mixture of combustible gases, steam, vapors or dust and air in atmospheric conditions that allow the entire mixture to combust once ignited. |
| Potentially explosive area | An area where the atmosphere has the potential to explode due to local or operational conditions ("Ex area"). |
| Electrical equipment | The entire set of components, electric circuits or parts of electric circuits that are usually located within a single housing. |
| Intrinsically safe electrical equipment | An electrical device in which all circuits are intrinsically safe. Note: these devices may be used directly in the Ex area. |
| Associated equipment | Electrical devices that contain both intrinsically safe and non-intrinsically safe circuits and that are designed in such a way that the non-intrinsically safe circuits cannot influence the intrinsically safe ones. Note: associated electrical equipment must not be used directly in potentially explosive areas without additional protection defined by a further protection type. |

Classification into groups

The general stipulations of EN 60079-0 divide electrical devices for potentially explosive areas into three groups.

Group I:

Electrical devices for firedamp areas (mines) which are susceptible to pit gases (methane) and/or combustible dusts (coal dust).

Group II:

Electrical devices for operation in areas where explosive gas atmospheres are likely

to occur, excluding mines susceptible to firedamp.

This also includes devices for the chemical, petrochemical, and pharmaceutical industries as well as for waste water treatment.

Electrical devices are further divided into subcategories according to the properties of the explosive atmosphere.

In the case of the intrinsic safety protection type, classification is based on the minimum ignition energy of the gas or vapor.

| Designation | Typical gas | Ignition energy/[i]J Intrinsic safety |
|-------------|-------------|--|
| II A | Propane | > 180 |
| II B | Ethylene | 60 ... 180 |
| II C | Hydrogen | < 60 |

Group III:

Electrical devices for operation in areas where explosive dust atmospheres are likely to occur, excluding mines susceptible to firedamp.

This includes devices for areas associated with the food industry (mills, silos), for example.

Electrical devices are further divided into subcategories according to the properties of the explosive atmosphere.

| Designation | Dusts |
|-------------|---------------------|
| III A | Combustible flyings |
| III B | Non-conductive dust |
| III C | Conductive dust |

Classification into temperature classes

Simply dividing the various gases into explosion or gas groups according to their minimum ignition energy is not sufficient to describe the gases adequately with regard to their explosive properties.

A gas may explode either when the ignition energy is exceeded or where there is an excessively high temperature caused by a hot surface. This ignition temperature is, however, not usually linked to the ignition energy, i.e., a gas with a low ignition energy does not necessarily explode at a low temperature. Consequently, devices that are used directly in potentially explosive atmospheres are divided into temperature classes. Temperature classes define the maximum surface temperature even in the event of errors. Parallel to this, the gases are classified according to their different ignition temperatures.

| Temperature class | Maximum permissible surface temperature of equipment °C | Ignition temperatures of combustible substances °C |
|-------------------|--|---|
| T 1 | 450 | > 450 |
| T 2 | 300 | > 300 ≤ 450 |
| T 3 | 200 | > 200 ≤ 300 |
| T 4 | 135 | > 135 ≤ 200 |
| T 5 | 100 | > 100 ≤ 135 |
| T 6 | 85 | > 85 ≤ 100 |

The following table provides an overview of the ignition energies and ignition temperatures for certain gases:

| Substance | T _{ign} | Temperature class | E _{min} | Group |
|------------------|------------------|-------------------|------------------|-------|
| Ethoxyethane | 170 | T 4 | 190 | II B |
| Ethylene | 425 | T 2 | 82 | II B |
| Ammonia | 630 | T 1 | 14000 | II A |
| Butane | 365 | T 2 | 250 | II A |
| Methane | 595 | T 1 | 280 | I |
| Propane | 470 | T 1 | 250 | II A |
| Carbon disulfide | 95 | T 6 | 9 | II C |
| Hydrogen | 560 | T 1 | 16 | II C |

Zone classification

Potentially explosive areas are divided into zones according to the probability of their occurrence. The EN 60079-10-1 standard defines the zones containing **explosive atmospheres** as follows:

Zone 0:

Area in which an explosive atmosphere is present for continuous or long periods.

These conditions are usually present inside containers, pipelines, apparatus, and tanks.

Zone 1:

Area in which an explosive atmosphere is to be expected only occasionally during normal operation.

This includes the immediate area surrounding zone 0, as well as areas close to filling and emptying equipment.

Zone 2:

Area in which an explosive atmosphere is not expected during normal operation; however, if it does occur, then it does so only rarely and for a short period.

Zone 2 includes areas that are used exclusively for storage, areas around pipe connections that can be disconnected, and generally the immediate area surrounding zone 1.

Areas that are potentially explosive as a result of **combustible dusts** are divided into the following zones according to EN 60079-10-2 (formerly: EN 61241-10):

Zone 20:

Area in which an explosive atmosphere is present for continuous, frequent or long periods in the form of an airborne cloud of combustible dust.

Zone 21:

Area in which an explosive atmosphere in the form of an airborne cloud of combustible dust is to be expected only occasionally during normal operation.

Zone 22:

Area in which an explosive atmosphere in the form of an airborne cloud of combustible dust is not expected during normal operation. However, if it does occur, then it does so only for a short period.

Categories

The ATEX Directive assigns devices for use in potentially explosive areas to categories. In IEC 60079-0, "Equipment Protection Level (EPL)" is the term used instead of "category".

In the same way that there are different zones, there are also different device categories. These consist of categories M1 and M2 for Group I and categories 1, 2, and 3 for Group II. The categories for **equipment group II** are described in more detail below:

Category 1:

Devices constructed to guarantee a very high degree of safety.

Devices in this category must guarantee the required degree of safety even in the unlikely event of a device failure and therefore be provided with measures to protect against explosion, so that:

- In the event of one integrated protection measure failing, a second, independent protection measure is able to guarantee the necessary safety.
- In the event of two independent errors, the necessary safety is guaranteed.

Category 2:

Devices constructed to guarantee a very high degree of safety.

The explosion protection measures associated with this category guarantee the required degree of safety, even in the case of frequent device failures or common error states.

Category 3:

Devices constructed to guarantee a standard degree of safety.

Devices in this category guarantee an adequate degree of safety in normal operation.

The table below shows which categories are assigned to which zones:

| Category | For Zone | Also possible |
|----------|----------|----------------------|
| 1 | 0 20 | 1 and 2 21 and 22 |
| 2 | 1 21 | 2 22 |
| 3 | 2 22 | |

Protection types

| Protection principle | Protection type | Area of application (selection) | Standard |
|--|-------------------------------------|---|-------------|
|  Isolation | Oil immersion | o Transformers, relays, startup controls, switching devices | EN 60079-6 |
| | Sand filling | q Transformers, relays, capacitors | EN 60079-5 |
| | Molded encapsulation | m* Coils of relays and motors, electronics, solenoid valves, connection systems | EN 60079-18 |
|  Exclusion | Pressurized enclosure | p Control cabinets, motors, measuring and analysis devices, computers | EN 60079-2 |
|  Special mechanical design | Flameproof enclosure | d Motors, switching devices, power electronics | EN 60079-1 |
|  Clearance from electrically conductive parts | Increased safety | e Terminal blocks, housing, lights, motors | EN 60079-7 |
|  Energy limitation | Intrinsic safety | Electronics, measurement and control | EN 60079-11 |
| | Intrinsically safe systems | i* Electronic systems | EN 60079-25 |
| | Intrinsically safe fieldbus systems | Fieldbus systems | EN 60079-27 |
| Improved industrial quality nA: non-sparking nC: sparking equipment nR: restricted breathing housing nL: energy-limited nP: simplified pressurized enclosures | Protection type "n" | n** Motors, housing, lights, electronics | EN 60079-15 |

* ia, ma: application in zone 0, 1, 2 / ib, mb: application in zone 1, 2 / ic, mc: application in zone 2 only ** Application in zone 2 only

Marking according to ATEX Directive



Designation according to EN 60079-0

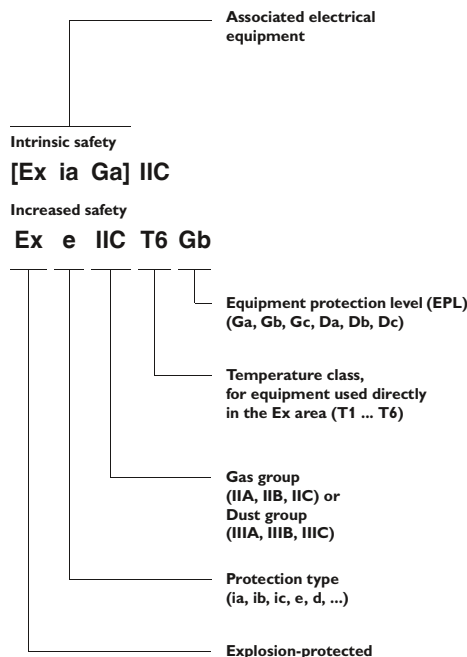

EC-type examination certificate

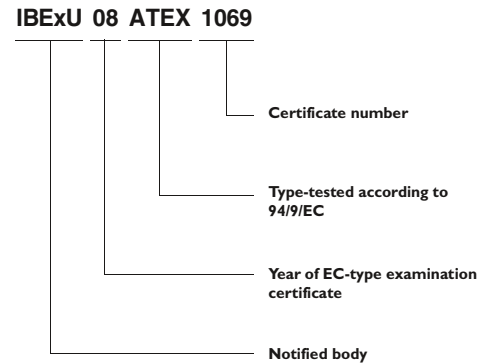

CE mark does not apply to components.

Solenoid drivers for controlling solenoid valves

In order to control intrinsically safe Ex i solenoid valves, you have to have an intrinsically safe control circuit. This is provided by the solenoid drivers that are available from Phoenix Contact.

The following must be taken into account when dimensioning your intrinsically safe control circuit:

- Valve
- Cable with corresponding resistance
- Solenoid driver

As a result, it may be the case that not all valves are compatible with the solenoid drivers.

Below is an extract from a table showing possible combinations of valves and solenoid drivers.

A complete and updated list (along with details of the technical data of suitable valves, the maximum cable lengths, and the maximum cable resistances of the individual combinations) can be found on the Internet at:

www.phoenixcontact.net/products

Example circuit



Valves overview

| Manufacturer | Type designation | Ex certificate | Condition | INTERFACE Ex solenoid driver | | | |
|---------------------------------|---------------------------------------|----------------------|----------------|------------------------------|----------------------------|----------------------------|----------------------------|
| | | | | MACX MCR-EX-SL-SD-21-25-LP | MACX MCR-EX-SL-SD-21-40-LP | MACX MCR-EX-SL-SD-24-48-LP | MACX MCR-EX-SL-SD-21-60-LP |
| ASCO | Coil 195 | LCIE 08 ATEX 6083 | | | ✓ | ✓ | |
| | Coil 302 (12 V) | INERIS 03 ATEX 0249X | | | | | ✓ |
| | Coil 302 (24 V) | INERIS 03 ATEX 0249X | | | | | ✓ |
| Bürkert | Coil AC 10, standard | PTB 01 ATEX 2101 | | | ✓ | ✓ | |
| | Coil AC 10, high-resistance | PTB 01 ATEX 2101 | | | ✓ | ✓ | |
| | Coil AC 21, standard | PTB 01 ATEX 2175 | 700 mW / 65°C | | ✓ | ✓ | |
| | Coil AC 21, high-resistance | PTB 01 ATEX 2175 | 700 mW / 65°C | | ✓ | ✓ | |
| | Coil AC 21, standard | PTB 01 ATEX 2175 | 900 mW / 45°C | | ✓ | ✓ | |
| | Coil AC 21, high-resistance | PTB 01 ATEX 2175 | 900 mW / 45°C | | ✓ | ✓ | |
| | Coil AC 21, standard | PTB 01 ATEX 2175 | 900 mW / 60°C | | ✓ | ✓ | |
| | Coil AC 21, high-resistance | PTB 01 ATEX 2175 | 900 mW / 60°C | | ✓ | ✓ | |
| | Coil G1 642735, standard | | 600 mW / 50°C | | ✓ | | |
| | Coil G1 642735, high-resistance | | 600 mW / 50°C | | ✓ | | |
| | Coil G1 642735, standard | PTB 01 ATEX 2173 | 800 mW / 40°C | | ✓ | ✓ | |
| Coil G1 642735, high-resistance | PTB 01 ATEX 2173 | 800 mW / 40°C | | ✓ | ✓ | | |
| Coil G1 642735, standard | PTB 01 ATEX 2173 | 1000 mW / 40°C | | ✓ | ✓ | | |
| Coil G1 642735, high-resistance | PTB 01 ATEX 2173 | 1000 mW / 40°C | | ✓ | ✓ | | |
| FESTO | Coil MFH...IA-SA-EX GBXE022AIAD03 | PTB 03 ATEX 2097 | | | | ✓ | ✓ |
| | Coil (J)MFH...BIA-SA-EX GBXE022AIAD03 | PTB 03 ATEX 2097 | | | | ✓ | ✓ |
| Norgren Herion | Coil 2050 | PTB 07 ATEX 2019 | | | ✓ | ✓ | ✓ |
| | Coil 2051 | PTB 07 ATEX 2019 | | | ✓ | ✓ | ✓ |
| | Coil 2052 | PTB 07 ATEX 2019 | | | ✓ | ✓ | ✓ |
| | Coil 2053 | PTB 07 ATEX 2019 | | | ✓ | ✓ | ✓ |
| | Coil 2085 | PTB 06 ATEX 2001 U | | ✓ | | ✓ | |
| | Coil 2086 | PTB 06 ATEX 2001 U | | ✓ | ✓ | ✓ | ✓ |
| | Coil 3039 | PTB 03 ATEX 2134 | | | | ✓ | |
| Hörbiger | Piezo P8 38x RF-Nx-SPN65 | DMT 01 ATEX E026X | 30 V type | ✓ | ✓ | | |
| | Piezo P20 381RF-NG-CPN61 | DMT 01 ATEX E025X | 30 V type | ✓ | ✓ | | |
| Parker | Coil VZ07 | LCIE 02 ATEX 6024X | | | ✓ | ✓ | |
| | Coil VZ33 | LCIE 02 ATEX 6024X | | | ✓ | ✓ | |
| | Coil VZ08 | LCIE 02 ATEX 6024X | | | ✓ | ✓ | |
| | Coil VZ09 | LCIE 02 ATEX 6024X | | | ✓ | ✓ | |
| | Coil VZ95 | LCIE 02 ATEX 6024X | EEEx ia IIB T6 | | ✓ | ✓ | ✓ |
| | Coil VZ23 | LCIE 02 ATEX 6024X | | | ✓ | ✓ | |
| Samson | Coil 3701-11 (6 V) | PTB 02 ATEX 2178 | | ✓ | | | |
| | Coil 3701-12 (12 V) | PTB 02 ATEX 2178 | | ✓ | ✓ | | |
| | Coil 3701-13 (24 V) | PTB 02 ATEX 2178 | | ✓ | ✓ | | |
| | Coil 3963-11 (6 V) | PTB 01 ATEX 2085 | | ✓ | | | |
| | Coil 3963-12 (12 V) | PTB 01 ATEX 2085 | | ✓ | ✓ | | |
| | Coil 3963-13 (24 V) | PTB 01 ATEX 2085 | | ✓ | ✓ | | |
| | Coil 3964-11 (6 V) | PTB 02 ATEX 2047 | | ✓ | | | |
| | Coil 3964-12 (12 V) | PTB 02 ATEX 2047 | | ✓ | ✓ | | |
| | Coil 3964-13 (24 V) | PTB 02 ATEX 2047 | | ✓ | ✓ | | |
| | Coil 3965-11 (6 V) | PTB 05 ATEX 2044X | | ✓ | | | |
| | Coil 3965-12 (12 V) | PTB 05 ATEX 2044X | | ✓ | ✓ | | |
| | Coil 3965-13 (24 V) | PTB 05 ATEX 2044X | | ✓ | ✓ | | |
| | Coil 3967-11 (6 V) | PTB 06 ATEX 2027 | | ✓ | | | |
| | Coil 3967-12 (12 V) | PTB 06 ATEX 2027 | | ✓ | ✓ | | |
| | Coil 3967-13 (24 V) | PTB 06 ATEX 2027 | | ✓ | ✓ | | |
| Seitz | Pilot valve PV 12F73 Ci oH | PTB 99 ATEX 2146 | | ✓ | ✓ | ✓ | |
| | Pilot valve PV 12F73 Xi oH | PTB 00 ATEX 2030 | | ✓ | ✓ | ✓ | |
| | Pilot valve PV 12F73 Xi oH-2 | PTB 00 ATEX 2030 | | ✓ | ✓ | ✓ | |
| | Solenoid 11 G 52 | PTB 01 ATEX 2020 | | | | ✓ | |

Safety-related function for the Ex area

The term SIL (safety integrity level) is becoming more and more significant in the field of process technology. It defines the requirements that a device or a system is expected to fulfill so that the failure probability can be specified. The aim is to achieve maximum possible operational reliability. If a device or system fails, a defined state is attained. Standard-based inspections are carried out to determine statistical probability.

Application of SIL on the basis of EN 61508 and EN 61511

The SIL standard is used for a wide range of industries within the process industry, including the chemical industry, refineries, oil and gas production, paper manufacturing, and conventional power generation. In addition to functional safety requirements, systems in potentially explosive areas are also subject to Ex standards EN 60079-0 ff.

EN 61508: “Functional safety of electrical/electronic/programmable electronic safety-related systems”

This standard describes the requirements that the manufacturer has to bear in mind when producing devices or systems.

EN 61511: “Functional safety - Safety instrumented systems for the process industry sector”

Standard EN 61511 describes the requirements for achieving systems with functional safety.

Compliance with the standard is determined by operators, owners, and planners on the basis of safety plans and national regulations. In addition, the standard also describes the requirements for using a device in an application on the basis of its proven effectiveness (proven in use).



SIL marking on devices

The products in the MACX range from Phoenix Contact, which have been developed in accordance with EN 61508, are marked with the designation SIL 2 or SIL 3. This indicates clearly that the devices may be suitable for safety instrumented functions (SIF).

To determine whether they can actually

be used, you need to calculate the sum of the probability failure values for all the devices in the signal circuit. The values required for this can be found in the safety manual accompanying any SIL product.

Overview of terms from SIL standards EN 61508 and EN 61511

| | | | |
|---------------|--|----------------|--|
| SIL | Safety integrity level One of four discrete levels for the specification of requirements for the safety integrity of safety instrumented functions, which are assigned to the E/E/PE safety instrumented systems, where SIL 4 is the highest and SIL 1 the lowest level. | E/E/PES | Electrical/electronic/programmable electronic systems This term is used for all electrical devices or systems which can be used to execute a safety instrumented function. It includes simple electrical devices and all types of programmable logic controllers (PLCs). |
| EUC | Equipment under control Equipment, machines, devices or systems used in production, materials processing or transport. | PFH | Probability of dangerous failure per hour Describes the probability of a dangerous failure occurring per hour. |
| MTBF | Mean Time Between Failures The expected mean time between failures. | SFF | Safe failure fraction Describes the proportion of harmless failures. This is the ratio of the rate of safe failures plus the rate of diagnosed or detected faults in relation to the total failure rate of the system. |
| PFD | Probability of failure on demand The probability of a failure on demand. Describes the probability of a safety instrumented system failing to perform its function when required. | SIF | Safety instrumented function Describes the safety instrumented functions of a system. |
| PFDavg | Average probability of failure on demand The average probability of the function failing on demand. | SIS | Safety instrumented system An SIS (safety instrumented system) consists of one or more safety instrumented functions. An SIL requirement is applicable for each of these safety instrumented functions. |

Ex i isolating amplifiers with SIL functional safety - MACX Analog Ex

SIL inspection

The complete signal path must be taken into account during the SIL inspection. The example shows how in a typical safety application the calculation is based on average failure probabilities of individual devices.

Table 2 of standard EN 61508-1 describes the relationship between the average failure probability and the attainable SIL. Here, the level required determines the overall budget for the sum of all PFD values.

A system with a single-channel structure with a low demand rate is used as an example; for SIL 2 the average PFD value is between 10^{-3} and $< 10^{-2}$.

The INTERFACE Analog and INTERFACE Ex product ranges include products that meet the requirements for explosion protection as well as functional safety.

| Safety integrity level SIL | Operating mode with a low demand rate (average probability of the specified function failing on demand) |
|----------------------------|--|
| 4 | $\geq 10^{-5}$ to $< 10^{-4}$ |
| 3 | $\geq 10^{-4}$ to $< 10^{-3}$ |
| 2 | $\geq 10^{-3}$ to $< 10^{-2}$ |
| 1 | $\geq 10^{-2}$ to $< 10^{-1}$ |

Safety integrity level: failure limit values for a safety function which is operated in an operating mode with a low demand rate.

Example:

A sensor and actuator are assembled in the field and are exposed to chemical and physical loads (process medium, pressure, temperature, vibration, etc.). Accordingly, these components have a high risk of failure:

- The sensor accounts for 25% of the overall PFD
- The actuator accounts for 40% of the overall PFD

Neither the failsafe controller nor the interface modules come into contact with the process medium and both are usually located in a protected control cabinet:

- The failsafe controller accounts for 15% of the overall PFD
- Each of the interface modules accounts for 10% of the overall PFD

Typically, the values form the basis for a calculation.



Analog IN

Repeater power supply, Ex i

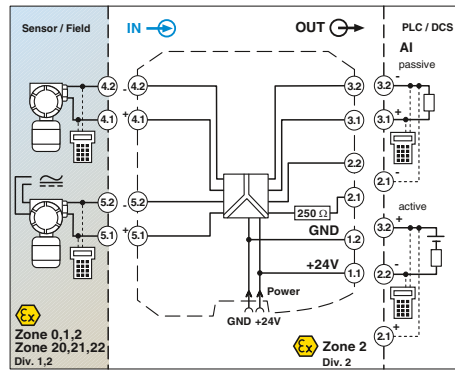
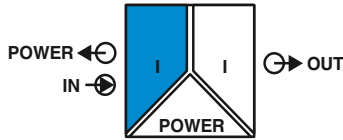

Repeater power supply and input isolating amplifier

UL Functional safety
 Ex: Ex i / Ex ii / Ex iii // Applied for: GL
 Housing width 12.5 mm

Repeater power supply and input isolating amplifier for the operation of intrinsically safe (Ex-i) 2-conductor measuring transducers, 4-conductor measuring transducers, and mA current sources installed in Ex areas.

- 0/4 ... 20 mA input, [Ex ia] (powered or not powered)
- 0/4...20 mA output (active or passive)
- Bidirectional transmission of digital HART communication signals
- Plug-in capable screw or spring-cage connection method, with integrated sockets for HART communicators
- Terminal point with 250 Ω resistor to increase the HART impedance in the case of low-impedance systems
- 3-way electrical isolation
- Power supply via DIN rail connector possible
- Up to SIL 2 according to EN 61508
- Installation in zone 2 permitted

| |
|---|
| Notes: |
| Information about the supply and error evaluation module as well as about the DIN rail connectors and marking material can be found from page 182 |
| Test plugs for test sockets can be found on page 191 |
| Information on "Plug and play" connection using system cabling can be found from page 184 |
| 1) EMC: Class A product, see page 571 |

| | |
|---|--|
| Input data | |
| Input signal | |
| Transmitter supply voltage | |
| Voltage drop | |
| Output data | |
| Output signal | |
| Load | |
| Output ripple | |
| General data | |
| Supply voltage range | |
| Current consumption | |
| Power dissipation | |
| Temperature coefficient | |
| Step response (10 - 90%) | |
| Transmission error, typical | |
| Maximum transmission error | |
| Under-/overload range | |
| Electrical isolation | |
| Ambient temperature range | |
| Humidity | |
| Status indication | |
| SMART communication | |
| Signal bandwidth | |
| Protocols supported | |
| Housing material | |
| Inflammability class according to UL 94 | |
| Dimensions W / H / D | |
| Screw connection solid / stranded / AWG | |
| Spring-cage connection (solid/stranded/AWG) | |
| Safety data as per ATEX | |
| Maximum voltage U _o | |
| Maximum current I _o | |
| Maximum power P _o | |
| Maximum voltage U _m | |
| Conformance / approvals | |
| Conformance | |
| ATEX | |
| IECEX | |
| UL, USA / Canada | |
| Functional safety (SIL) | |
| Input/output/power supply | |
| Input/output | |
| Input/power supply | |

Technical data

| |
|--|
| 0 mA ... 20 mA / 4 mA ... 20 mA |
| > 16 V (at 20 mA) |
| < 3.5 V (in input isolating amplifier operation) |
| 0 mA ... 20 mA (active) |
| 4 mA ... 20 mA (active) |
| 0 mA ... 20 mA (14 ... 26 V ext. source voltage) |
| 4 mA ... 20 mA (14 ... 26 V ext. source voltage) |
| < 600 Ω |
| < 20 mV _{rms} |
| 19.2 V DC ... 30 V DC |
| < 60 mA (at 24 V DC) |
| < 1.1 W (at 24 V DC / 20 mA) |
| < 0.01%/K |
| < 600 μs (for 4 mA ... 20 mA step) |
| < 0.05% (of final value) |
| < 0.1% (of final value) |
| as per NE 43 |
| 2.5 kV (50 Hz, 1 min., test voltage) |
| 300 V _{rms} (Rated insulation voltage, surge voltage category II; pollution degree 2, safe isolation as per EN 61010, EN 50178) |
| 375 V (Peak value in accordance with EN 60079-11) |
| 375 V (Peak value in accordance with EN 60079-11) |
| -20°C ... 60°C (Any mounting position) |
| 10% ... 95% (no condensation) |
| Green LED (supply voltage) |
| Yes |
| as per HART specifications |
| HART |
| PA 66-FR |
| V0 |
| 12.5 / 99 / 114.5 mm |
| 0.2 ... 2.5 mm ² / 0.2 ... 2.5 mm ² / 24 - 14 |
| 0.2 ... 1.5 mm ² / 0.2 ... 1.5 mm ² / 24 - 16 |
| 25.2 V |
| 93 mA |
| 587 mW |
| 253 V AC (125 V DC) |
| CE-compliant, additionally EN 61326 |
| Ex II (1) G [Ex ia Ga] IIC/IIB |
| Ex II (1) D [Ex ia Da] IIIC |
| Ex II 3(1) G Ex nA [ia Ga] IIC/IIB T4 Gc |
| [Ex ia Ga] IIC/IIB; [Ex ia Da] IIIC; Ex nA [ia Ga] IIC/IIB T4 Gc |
| Class I Div 2; IS for Class I, II, III Div 1 |
| SIL 2 according to EN 61508 |

Ordering data

| Description | Type | Order No. | Pcs. / Pkt. |
|--|--|-----------|-------------|
| Repeater power supply, smart, intrinsically safe input | | | |
| Screw connection | MACX MCR-EX-SL-RPSSI-I ¹) | 2865340 | 1 |
| Spring-cage conn. | MACX MCR-EX-SL-RPSSI-I-SP ¹) | 2924016 | 1 |

Analog IN
Repeater power supply, Ex i

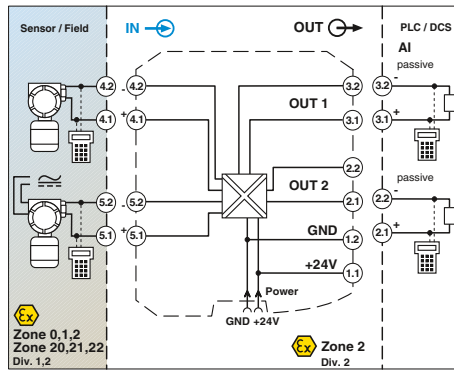
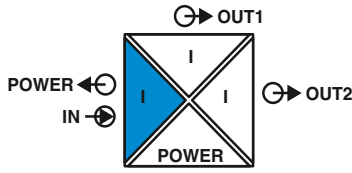

Repeater power supply and input isolating amplifier, with two electrically isolated outputs

Functional safety
Ex:
Housing width 12.5 mm

Repeater power supply and input isolating amplifier for the operation of intrinsically safe (Ex-i) 2-conductor measuring transducers, 4-conductor measuring transducers, and mA current sources installed in Ex areas.

- 0/4 ... 20 mA input, [Ex ia] (powered or not powered)
- Two electrically isolated 0/4 ... 20 mA (active) outputs
- Bidirectional transmission of digital HART communication signals (both outputs)
- Plug-in capable screw or spring-cage connection method, with integrated sockets for HART communicators
- 4-way electrical isolation
- Power supply via DIN rail connector possible
- Up to SIL 2 according to EN 61508
- Installation in zone 2 permitted

| | |
|---|--|
| Input data | |
| Input signal | |
| Transmitter supply voltage | |
| Voltage drop | |
| Output data | |
| Output signal (Per output) | |
| Load | |
| Output ripple | |
| General data | |
| Supply voltage range | |
| Current consumption | |
| Power dissipation | |
| Temperature coefficient | |
| Step response (10 - 90%) | |
| Transmission error, typical | |
| Maximum transmission error | |
| Under-/overload range | |
| Electrical isolation | |
| Input/output/power supply | |
| Input/output | |
| Input/power supply | |
| Output 1/output 2 | |
| Ambient temperature range | |
| Status indication | |
| SMART communication (Per output) | |
| Protocols supported | |
| Housing material | |
| Dimensions W / H / D | |
| Screw connection solid / stranded / AWG | |
| Spring-cage connection (solid/stranded/AWG) | |
| Safety data as per ATEX | |
| Maximum voltage U_o | |
| Maximum current I_o | |
| Maximum power P_o | |
| Maximum voltage U_m | |
| Conformance / approvals | |
| Conformance | |
| ATEX | |
| IECEX | |
| Functional safety (SIL) | |

Technical data

| |
|--|
| 4 mA ... 20 mA / 0 mA ... 20 mA |
| > 16 V (at 20 mA) |
| < 3.9 V (in input isolating amplifier operation) |
| 4 mA ... 20 mA (active) |
| < 450 Ω (at 20 mA) |
| < 20 mV _{rms} |
| 19.2 V DC ... 30 V DC (24 V DC (-20% ... +25%)) |
| < 75 mA (24 V DC/ 20 mA) |
| < 1.45 W (24 V DC/ 20 mA) |
| < 0.01%/K |
| < 1.3 ms (for 4 mA ... 20 mA step) |
| < 0.05% (of final value) |
| < 0.1% (of final value) |
| as per NE 43 |
| 2.5 kV (50 Hz, 1 min., test voltage) |
| 300 V _{rms} (Rated insulation voltage, surge voltage category II; pollution degree 2, safe isolation as per EN 61010, EN 50178) |
| 375 V (Peak value in accordance with EN 60079-11) |
| 375 V (Peak value in accordance with EN 60079-11) |
| 1.5 kV AC (50 Hz, 1 min., test voltage) |
| -20°C ... 60°C (Any mounting position) |
| Green LED (PWR supply voltage) |
| Yes |
| HART |
| PA 66-FR |
| 12.5 / 99 / 114.5 mm |
| 0.2 ... 2.5 mm ² / 0.2 ... 2.5 mm ² / 24 - 14 |
| 0.2 ... 1.5 mm ² / 0.2 ... 1.5 mm ² / 24 - 16 |
| 25.2 V |
| 93 mA |
| 587 mW |
| 253 V AC (125 V DC) |
| CE-compliant, additionally EN 61326 |
| II (1) G [Ex ia Ga] IIC/IIB |
| II (1) D [Ex ia Da] IIIC |
| II 3(1) G Ex nA [ia Ga] IIC/IIB T4 Gc |
| [Ex ia Ga] IIC/IIB; [Ex ia Da] IIIC; Ex nA [ia Ga] IIC/IIB T4 Gc |
| SIL 2 according to EN 61508 |

| |
|---|
| Notes: |
| Information about the supply and error evaluation module as well as about the DIN rail connectors and marking material can be found from page 182 |
| Test plugs for test sockets can be found on page 191 |
| Information on "Plug and play" connection using system cabling can be found from page 184 |
| 1) EMC: Class A product, see page 571 |

Ordering data

| Description | Type | Order No. | Pcs. / Pkt. |
|---|---|-----------|-------------|
| Repeater power supply, smart, intrinsically safe input | | | |
| Screw connection | MACX MCR-EX-SL-RPSSI-2I ¹) | 2865366 | 1 |
| Spring-cage conn. | MACX MCR-EX-SL-RPSSI-2I-SP ¹) | 2924236 | 1 |

Analog IN
Repeater power supply, Ex i

N

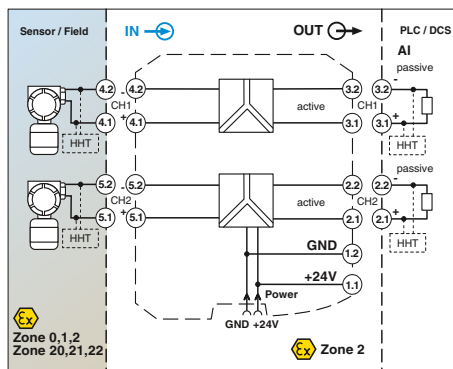

2-channel repeater power supply

Repeater power supply for the operation of intrinsically safe (Ex i) 2-conductor measuring transducers installed in the Ex area.

- 2-channel
- 4 ... 20 mA input, [Ex ia] (powered)
- 4 ... 20 mA output (active)
- Bidirectional transmission of digital HART communication signals
- Plug-in capable screw or spring-cage connection method, with integrated sockets for HART communicators
- Safe 3-way electrical isolation
- Power supply via DIN rail connector possible
- Up to SIL 2 according to EN 61508
- Installation in zone 2 permitted

| |
|---|
| Notes: |
| Information on the supply and error evaluation module, DIN rail connectors, system cabling, and marking material can be found from page 182 |
| Test plugs for test sockets can be found on page 191 |
| Information on "Plug and play" connection using system cabling can be found from page 184 |

| | |
|---------------------------------|--|
| Input data | |
| Input signal | |
| Transmitter supply voltage | |
| Underload/overload signal range | |
| Output data | |
| Output signal | |
| Load | |
| Underload/overload signal range | |
| General data | |
| Supply voltage range | |
| Current consumption | |
| Power dissipation | |
| Temperature coefficient | |
| Step response (10 - 90%) | |
| Transmission error, typical | |
| Maximum transmission error | |
| Electrical isolation | |
| Safety data as per ATEX | |
| Maximum voltage U_o | |
| Maximum current I_o | |
| Maximum power P_o | |
| Maximum voltage U_m | |
| Conformance / approvals | |
| Conformance | |
| ATEX | |
| IECEX | |
| Functional safety (SIL) | |

Housing width 12.5 mm

| Technical data | |
|--|---|
| Per channel | |
| 4 mA ... 20 mA | |
| > 16 V (at 20 mA) | |
| 0 mA ... 24 mA | |
| Per channel | |
| 4 mA ... 20 mA (active) | |
| 450 Ω (at 20 mA) | |
| 0 mA ... 24 mA | |
| General data | |
| 19.2 V DC ... 30 V DC (24 V DC (-20% ... +25%)) | |
| < 100 mW (24 V / 20 mA) | |
| < 1.4 W (at 24 V DC / 20 mA) | |
| < 0.01%/K | |
| < 1.3 ms (for 4 mA ... 20 mA step) | |
| < 0.05% (of final value) | |
| < 0.1% (of final value) | |
| Input/output/power supply | |
| 2.5 kV (50 Hz, 1 min., test voltage) | |
| 300 V _{rms} (Rated insulation voltage, surge voltage category II; pollution degree 2, safe isolation as per EN 61010, EN 50178) | |
| Input/output | 375 V (Peak value in accordance with EN 60079-11) |
| Input/power supply | 375 V (Peak value in accordance with EN 60079-11) |
| Output 1/output 2 | 1.5 kV (50 Hz, 1 min., test voltage) |
| | -20°C ... 60°C (Any mounting position) |
| | Green LED (supply voltage) |
| | Yes |
| | as per HART specifications |
| | HART |
| | PA 66-FR |
| | 12.5 / 99 / 114.5 mm |
| | 0.2 ... 2.5 mm ² / 0.2 ... 2.5 mm ² / 24 - 14 |
| | 0.2 ... 1.5 mm ² / 0.2 ... 1.5 mm ² / 24 - 16 |
| Safety data as per ATEX | |
| Maximum voltage U_o | 25.2 V |
| Maximum current I_o | 93 mA |
| Maximum power P_o | 587 mW |
| Maximum voltage U_m | 253 V AC (125 V DC) |
| Conformance / approvals | |
| Conformance | CE-compliant, additionally EN 61326 |
| ATEX | [Ex] II (1) G [Ex ia Ga] IIC |
| | [Ex] II (1) D [Ex ia Da] IIIC |
| | [Ex] II 3(1) G Ex nA [ia Ga] IIC T4 Gc |
| | [Ex ia Ga] IIC/IIB; [Ex ia Da] IIIC; Ex nA IIC T4 Gc |
| | SIL 2, PL d |

| Ordering data | | |
|--|-------------------------------------|-------------|
| Type | Order No. | Pcs. / Pkt. |
| Repeater power supply, 2-channel, smart, intrinsically safe input | | |
| Screw connection | MACX MCR-EX-SL-RPSS-2I-2I | 2865382 |
| Spring-cage conn. | MACX MCR-EX-SL-RPSS-2I-2I-SP | 2924676 |

Analog OUT
Output isolating amplifier, Ex-i



Functional safety
Ex: Ex, Ex, Ex
Housing width 12.5 mm

Output isolating amplifier for controlling intrinsically safe (Ex-i) I/P converters, control valves, and indicators installed in Ex areas.

- 0/4...20 mA input
- 0/4...20 mA output, [Ex ia] IIC
- Bidirectional transmission of digital HART communication signals
- Plug-in capable screw or spring-cage connection method, with integrated sockets for HART communicators
- Line fault detection (LF)
- 3-way electrical isolation
- Power supply via DIN rail connector possible
- Up to SIL 2 according to EN 61508
- Installation in zone 2 permitted

| |
|---|
| Notes: |
| Information about the supply and error evaluation module as well as about the DIN rail connectors and marking material can be found from page 182 |
| Test plugs for test sockets can be found on page 191 |
| Information on "Plug and play" connection using system cabling can be found from page 184 |

| | |
|---|--|
| Input data | |
| Input signal | |
| Input voltage | |
| Input impedance in the event of a cable break at the output | |
| Output data | |
| Output signal | |
| Load | |
| Output ripple | |
| General data | |
| Supply voltage range | |
| Current consumption | |
| Power dissipation | |
| Temperature coefficient | |
| Step response (10 - 90%) | |
| Maximum transmission error | |
| Electrical isolation | |
| Input/output/power supply | |
| | |
| Output/input | |
| Output/power supply | |
| Ambient temperature range | |
| Humidity | |
| Status indication | |
| SMART communication | |
| Signal bandwidth | |
| Protocols supported | |
| Housing material | |
| Inflammability class according to UL 94 | |
| Dimensions W / H / D | |
| Screw connection solid / stranded / AWG | |
| Spring-cage connection (solid/stranded/AWG) | |
| Safety data as per ATEX | |
| Maximum voltage U_o | |
| Maximum current I_o | |
| Maximum power P_o | |
| Maximum voltage U_m | |
| Conformance / approvals | |
| Conformance | |
| ATEX | |
| IECEX | |
| UL, USA / Canada | |
| Functional safety (SIL) | |

Technical data

| |
|--|
| 0 mA ... 20 mA / 4 mA ... 20 mA |
| 5.4 V (at 20 mA) |
| > 100 kΩ (if there is a line fault) |
| 0 mA ... 20 mA / 4 mA ... 20 mA |
| < 800 Ω (at 20 mA) |
| < 20 mV _{rms} |
| 19.2 V DC ... 30 V DC |
| < 46 mA (at 24 V DC / 20 mA) |
| < 1.1 W (at 24 V DC / 20 mA) |
| < 0.01%/K |
| < 140 μs |
| < 0.1% (of final value) |
| 1.5 kV (50 Hz, 1 min., test voltage) |
| 300 V _{rms} (Rated insulation voltage, surge voltage category II; pollution degree 2, safe isolation as per EN 61010, EN 50178) |
| 375 V (Peak value in accordance with EN 60079-11) |
| 375 V (Peak value in accordance with EN 60079-11) |
| -20°C ... 60°C (Any mounting position) |
| 10% ... 95% (no condensation) |
| Green LED (supply voltage) |
| Yes |
| as per HART specifications |
| HART |
| PA 66-FR |
| V0 |
| 12.5 / 99 / 114.5 mm |
| 0.2 ... 2.5 mm ² / 0.2 ... 2.5 mm ² / 24 - 14 |
| 0.2 ... 1.5 mm ² / 0.2 ... 1.5 mm ² / 24 - 16 |
| 27.7 V |
| 92 mA |
| 633 mW |
| 253 V AC (125 V DC) |
| CE-compliant, additionally EN 61326 |
| Ex II (1) G [Ex ia Ga] IIC |
| Ex II (1) D [Ex ia Da] IIC |
| Ex II 3(1) G Ex nA [ia Ga] IIC T4 Gc |
| [Ex ia Ga] IIC; [Ex ia Da] IIC; Ex nA [ia Ga] IIC T4 Gc |
| Class I Div 2; IS for Class I, II, III Div 1 |
| SIL 2 according to EN 61508 |

Ordering data

| Description | Type | Order No. | Pcs. / Pkt. |
|---|--------------------------------|----------------|-------------|
| Output isolating amplifier, smart, output intrinsically safe | | | |
| Screw connection | MACX MCR-EX-SL-IDS-I | 2865405 | 1 |
| Spring-cage conn. | MACX MCR-EX-SL-IDS-I-SP | 2924032 | 1 |

Temperature transducer, Ex i



For thermocouples and mV sources

Ex: Ex i, Ex ii, Ex ia, Ex ib, Ex ic, Ex ia, Ex ib, Ex ic
Housing width 12.5 mm

Programmable temperature transducer for intrinsically safe operation of thermocouples and mV sources installed in Ex areas. The measured values are converted into a linear 0 ... 20 mA or 4 ... 20 mA signal.

- Input for thermocouples and mV sources, [Ex ia]
- 0 ... 20 mA or 4 ... 20 mA output
- Configuration via software (FDT/DTM): Sensor type, connection method, measuring range, measuring unit, filter, alarm signal, and output range
- Programming during operation with Ex measuring circuit connected and also voltage-free using IFS-USB-PROG-ADAPTER programming adapter
- Status indicator for supply voltage, cable, sensor, and module errors
- 3-way electrical isolation
- Power supply via DIN rail connector possible
- Up to SIL 2 according to EN 61508
- Installation in zone 2 permitted

| | |
|---|---------------------------|
| Input data | Thermocouple sensors |
| Voltage | |
| Measuring range span | |
| Output data | Output signal |
| Load | |
| Behavior in the event of a sensor error | |
| Output ripple | |
| General data | Supply voltage range |
| | Current consumption |
| | Power dissipation |
| | Temperature coefficient |
| | Step response (0 - 99%) |
| | Transmission error, total |
| | Cold junction errors |
| | ZERO / SPAN adjustment |
| | Electrical isolation |
| | Input/output/power supply |
| | Input/output |
| | Input/power supply |
| Ambient temperature range | |
| Humidity | |
| Status indication | |
| Housing material | |
| Inflammability class according to UL 94 | |
| Dimensions W / H / D | |
| Screw connection solid / stranded / AWG | |
| Safety data as per ATEX | |
| Maximum voltage U_o | |
| Maximum current I_o | |
| Maximum power P_o | |
| Maximum voltage U_m | |
| Conformance / approvals | |
| Conformance | |
| ATEX | |
| IECEX | |
| UL, USA / Canada | |
| Functional safety (SIL) | |

Technical data

E, J, K, N as per IEC / EN 60584, L as per DIN 43760

-20 mV ... 70 mV
(Min. 50 K for thermocouples, 3 mV for mV sources)

0 mA ... 20 mA / 4 mA ... 20 mA
max. 500 Ω
As per NE 43 or can be freely defined
< 50 µA_{pp}

19.2 V DC ... 30 V DC
< 40 mA (24 V DC)
< 1 W
0.01%/K
Typ. 800 ms (With SIL)
max. 1200 ms (With SIL)
Typ. 700 ms (Without SIL)
max. 1100 ms (Without SIL)
0.05% x 200 [K]/Measuring range span [K] + 0.05%
±1 K
±5% / ±5%

2.5 kV (50 Hz, 1 min., test voltage)
300 V_{rms} (Rated insulation voltage, surge voltage category II; pollution degree 2, safe isolation as per EN 61010, EN 50178)

375 V (Peak value in accordance with EN 60079-11)
375 V (Peak value in accordance with EN 60079-11)
-20°C ... 60°C (Any mounting position)

5% ... 95% (no condensation)
Green LED (supply voltage, PWR)
Red LED, flashing (line, sensor error, ERR)
Red LED (module error, ERR)

PA 66-FR
V0
12.5 / 99 / 114.5 mm
0.2 ... 2.5 mm² / 0.2 ... 2.5 mm² / 24 - 14

6 V
4.7 mA
7 mW
253 V AC (125 V DC)

CE-compliant, additionally EN 61326
Ex II (1) G [Ex ia Ga] IIC
Ex II (1) D [Ex ia Da] IIIC
Ex II 3(1) G Ex nA ic [ia Ga] IIC T4 Gc X
[Ex ia Ga] IIC; [Ex ia Da] IIIC; Ex nA ic [ia Ga] IIC T4 Gc
Class I Div 2; IS for Class I, II, III Div 1
SIL 2 TÜV Rheinland 968/EZ374.00/09

| |
|---|
| Notes: |
| To order a product with an order configuration, please enter the desired configuration by referring to the order key, see page 167 |
| The configuration software can be downloaded from the Internet (www.phoenixcontact.net/products). |
| Information about the supply and error evaluation module as well as about the DIN rail connectors and marking material can be found from page 182 |
| For information on the programming adapter, refer to page 119 |
| Information on "Plug and play" connection using system cabling can be found from page 184 |
| 1) EMC: Class A product, see page 571 |

Ordering data

| Type | Order No. | Pcs. / Pkt. |
|--------------------------|-----------|-------------|
| MACX MCR-EX-SL-TC-1') | 2865942 | 1 |
| MACX MCR-EX-SL-TC-1-NC') | 2865586 | 1 |

Accessories

| | | |
|------------------------|---------|---|
| IFS-USB-PROG-ADAPTER') | 2811271 | 1 |
|------------------------|---------|---|

| Description | Order configuration | Standard configuration |
|--|---------------------|------------------------|
| Temperature measuring transducers for thermocouples, | | |
| intrinsically safe input | | |
| Order configuration | Screw connection | |
| Standard configuration | | Screw connection |
| Programming adapter for configuring modules with S-PORT interface | | |

Order key and temperature ranges for MACX-MCR-EX-SL-RTD-I(-SP) temperature transducer

Order key for MACX-MCR-EX-SL-RTD-I(-SP) temperature transducer (standard configuration entered as an example)

| Order No. | Sensor type | Safety integrity level (SIL) | Connection technology | Measuring range: | | Measuring unit | Output range | Filter Oversampling | Filter Moving average value |
|---|---|--|---|---|------------|---------------------------|--|---|---|
| | | | | Start | End | | | | |
| 2865939 | PT100 | ON | 3 | 0 | 100 | C | OUT02 | 10 | 1 |
| 2865939 ≙ MACX MCR-EX-SL-RTD-I | see below | ON ≙ active NONE ≙ not active | 2 ≙ 2-conductor 3 ≙ 3-conductor 4 ≙ 4-conductor | see below | see below | C ≙ °C F ≙ °F O ≙ Ω | OUT01 ≙ 0...20 mA OUT02 ≙ 4...20 mA | 1 ≙ 1 value 3 ≙ 3 values 5 ≙ 5 values 7 ≙ 7 values 10 ≙ 10 values 20 ≙ 20 values | 1 ≙ 1 value 2 ≙ 2 values 3 ≙ 3 values 4 ≙ 4 values |
| 2924142 ≙ MACX MCR-EX-SL-RTD-I-SP | | ON only with output range = OUT02 | | | | | | | |
| | | | | Smallest measuring range span | | | | | |
| RES01 ≙ Resistor | | | | 0 | 2000 | Ω | 25 Ω | | |
| PT50 ≙ Pt 50 acc. to IEC 751 | | | | -200 | 850 | °C | 50 K | | |
| PT100 ≙ Pt 100 acc. to IEC 751 | | | | -200 | 850 | °C | 50 K | | |
| PT200 ≙ Pt 200 acc. to IEC 751 | | | | -200 | 850 | °C | 50 K | | |
| PT500 ≙ Pt 500 acc. to IEC 751 | | | | -200 | 850 | °C | 50 K | | |
| PT100S ≙ Pt 100 acc. to Sama RC21-4-1966 | | | | -200 | 600 | °C | 50 K | | |
| PT500S ≙ Pt 500 acc. to Sama RC21-4-1966 | | | | -200 | 600 | °C | 50 K | | |
| NI100DIN ≙ Ni 100 acc. to DIN 43760 | | | | -60 | 250 | °C | 50 K | | |
| NI500DIN ≙ Ni 500 acc. to DIN 43760 | | | | -60 | 250 | °C | 50 K | | |
| CU50 ≙ CU50 acc. to GOST 6651 (α = 1.428) | | | | -50 | 200 | °C | 50 K | | |
| CU53 ≙ CU53 acc. to GOST 6651 (α = 1.426) | | | | -50 | 180 | °C | 50 K | | |
| Alarm signal | | Alarm signal | | Factory calibration certificate = FCC | | | | | |
| Short circuit/overrange | | Sensor break/underrange | | | | | | | |
| ... | I035 | I215 | NONE | Temperature conversion guide for °C to °F: | | | | | |
| | I000 ≙ 0 mA I035 ≙ 3.5 mA I215 ≙ 21.5 mA | I000 ≙ 0 mA I035 ≙ 3.5 mA I215 ≙ 21.5 mA | NONE ≙ without FCC YES ≙ with FCC (a fee is charged) YESPLUS ≙ FCC with 5 measuring points (a fee is charged) | $T [°F] = \frac{9}{5} T [°C] + 32$ | | | | | |
| | I035 only with output range = OUT02 | | | | | | | | |
| | Alarm signals can also be configured individually using software. | | | | | | | | |

Order key and temperature ranges for MACX-MCR-EX-SL-TC-I temperature transducer

Order key for MACX-MCR-EX-SL-TC-I temperature transducer (standard configuration entered as an example)

| Order No. | Sensor type | Safety integrity level (SIL) | Cold junction compensation | Measuring range: | | Measuring unit | Output range | Filter Oversampling | Filter Moving average value |
|-------------------------------------|---|--|---|---|-------------|----------------------------|--|---|---|
| | | | | Start | End | | | | |
| 2924942 | J | ON | 1 | 0 | 1000 | C | OUT02 | 10 | 1 |
| MACX MCR-EX-SL-TC-I | see below | ON ≙ active NONE ≙ not active | 1 ≙ switched on 0 ≙ switched off (e.g., for mV voltage measurement) | see below | see below | C ≙ °C F ≙ °F V ≙ mV | OUT01 ≙ 0...20 mA OUT02 ≙ 4...20 mA | 1 ≙ 1 value 3 ≙ 3 values 5 ≙ 5 values 7 ≙ 7 values 10 ≙ 10 values 20 ≙ 20 values | 1 ≙ 1 value 2 ≙ 2 values 3 ≙ 3 values 4 ≙ 4 values |
| | | | | Smallest measuring range span | | | | | |
| V03 ≙ Voltage (mV) | | | | -20 | +70 | mV | 3 mV | | |
| E ≙ acc. to IEC 584-1 (NiCr-CuNi) | | | | -250 | 1000 | °C | 50 K | | |
| J ≙ acc. to IEC 584-1 (Fe-CuNi) | | | | -210 | 1200 | °C | 50 K | | |
| K ≙ acc. to IEC 584-1 (NiCr-Ni) | | | | -250 | 1372 | °C | 50 K | | |
| N ≙ acc. to IEC 584-1 (NiCrSi-NiSi) | | | | -250 | 1300 | °C | 50 K | | |
| L ≙ acc. to DIN 43760 (Fe-CuNi) | | | | -200 | 900 | °C | 50 K | | |
| Alarm signal | | Alarm signal | | Factory calibration certificate = FCC | | | | | |
| Overrange | | Sensor break/underrange | | | | | | | |
| ... | I035 | I215 | NONE | Temperature conversion guide for °C to °F: | | | | | |
| | I000 ≙ 0 mA I035 ≙ 3.5 mA I215 ≙ 21.5 mA | I000 ≙ 0 mA I035 ≙ 3.5 mA I215 ≙ 21.5 mA | NONE ≙ without FCC YES ≙ with FCC (a fee is charged) YESPLUS ≙ FCC with 5 measuring points (a fee is charged) | $T [°F] = \frac{9}{5} T [°C] + 32$ | | | | | |
| | I035 only with output range = OUT02 | | | | | | | | |
| | Alarm signals can also be configured individually using software. | | | | | | | | |

Temperature transducer, Ex i



Universal, with switching output, wide-range power supply

Functional safety
Ex:
Housing width 17.5 mm

Universal temperature transducer with freely configurable properties for intrinsically safe operation of resistance thermometers, thermocouples, resistance-type sensors, and potentiometers installed in Ex areas

- Input for resistance thermometers, thermocouples, resistance-type sensors, potentiometers, and mV sources, [Ex ia]
- Measure differential temperatures
- Freely programmable input and output
- Option of inverse output signal ranges
- Relay switching output
- Configuration via software (FDT-DTM) or IFS-OP-UNIT operating and display unit
- Programming during operation with Ex measuring circuit connected and also voltage-free using IFS-USB-PROG-ADAPTER programming adapter
- Plug-in capable screw or spring-cage connection method
- Cold junction compensation with separate connector
- Wide-range power supply: 19.2 ... 253 V AC/DC
- Status indicator for supply voltage, cable, sensor, and module errors
- Up to SIL 2 according to EN 61508
- Installation in zone 2 permitted

| | |
|---|--|
| Input data | |
| Resistance thermometers | |
| Thermocouple sensors | |
| Resistor | |
| Potentiometer | |
| Voltage | |
| Output data | |
| Output signal | |
| Maximum output signal | |
| Load R_B | |
| Behavior in the event of a sensor error | |
| Switching output | |
| Contact type | |
| Contact material | |
| Maximum switching voltage | |
| Maximum switching current | |
| General data | |
| Supply voltage range | |
| Power consumption | |
| Temperature coefficient | |
| Transmission error, total | |
| Electrical isolation | |
| Input/output/power supply | |
| Input/output | |
| Input/power supply | |
| Input/switching output | |
| Output/power supply | |
| Ambient temperature range | |
| Humidity | |
| Housing material | |
| Inflammability class according to UL 94 | |
| Dimensions W / H / D | |
| Screw connection solid / stranded / AWG | |
| Spring-cage connection (solid/stranded/AWG) | |
| Safety data as per ATEX | |
| Maximum voltage U_o | |
| Maximum current I_o | |
| Maximum power P_o | |
| Conformance / approvals | |
| Conformance | |
| ATEX | |
| IECEX | |
| Functional safety (SIL) | |

| | |
|--|---------------------------|
| Technical data | |
| Pt, Ni, Cu sensors: 2, 3, 4-conductor | |
| B, E, J, K, N, R, S, T, L, U, CA, DA, A1G, A2G, A3G, MG, LG | |
| 0 Ω ... 50 k Ω | |
| 0 Ω ... 50 k Ω | |
| -1000 mV ... 1000 mV | |
| U output | I output |
| 4 mA ... 20 mA (in the case of SIL; further free configuration without SIL) | |
| ± 11 V | 22 mA |
| ≥ 10 k Ω | $\leq 600 \Omega$ (20 mA) |
| According to NE 43 or freely configurable | |
| Switching output | |
| 1 PDT | |
| AgSnO ₂ , hard gold-plated | |
| 30 V AC (30 V DC) | |
| 0.5 A (30 V AC) / 1 A (30 V DC) | |
| 24 V ... 230 V AC/DC (-20%/+10%, 50/60 Hz) | |
| < 1.5 W | |
| 0.01%/K | |
| < 0.1% (e.g., for Pt 100, 300 K span, 4 ... 20 mA) | |
| 2.5 kV (50 Hz, 1 min., test voltage) | |
| 375 V (Peak value in accordance with EN 60079-11) | |
| 375 V (Peak value in accordance with EN 60079-11) | |
| 375 V (Peak value in accordance with EN 60079-11) | |
| 300 V _{rms} (Rated insulation voltage, surge voltage category II; pollution degree 2, safe isolation as per EN 61010, EN 50178) | |
| -20°C ... 65°C | |
| Typ. 5% ... 95% (no condensation) | |
| PA 66-FR | |
| V0 | |
| 17.5 / 99 / 114.5 mm | |
| 0.2 ... 2.5 mm ² / 0.2 ... 2.5 mm ² / 24 - 14 | |
| 0.2 ... 1.5 mm ² / 0.2 ... 1.5 mm ² / 24 - 16 | |
| 6 V | |
| 7.4 mA | |
| 11 mW | |
| CE-compliant | |
| II (1) G [Ex ia Ga] IIC | |
| II (1) D [Ex ia Da] IIIC | |
| II 3 G Ex nA nC ic IIC T4 Gc X | |
| [Ex ia Ga] IIC; [Ex ia Da] IIIC; Ex nA nC ic IIC T4 Gc | |
| SIL 2, PL d | |

| |
|--|
| Notes: |
| To order a product with an order configuration, enter the required configuration by referring to the adjacent order key. |
| The configuration software can be downloaded from the Internet (www.phoenixcontact.net/products). |
| Information on the IFS-OP-UNIT operating and display unit and the associated IFS-OP-CRADLE DIN rail cradle can be found on page 118 |
| For information on the programming adapter, refer to page 119 |
| 1) EMC: Class A product, see page 571 |

| | |
|--|-------------------|
| Description | |
| Temperature transducer, intrinsically safe input | |
| Standard configuration | Screw connection |
| Standard configuration | Spring-cage conn. |
| Order configuration | Screw connection |
| Order configuration | Spring-cage conn. |

| | |
|--|--|
| Programming adapter for configuring modules with S-PORT interface | |
|--|--|

| | | |
|--|------------------|--------------------|
| Ordering data | | |
| Type | Order No. | Pcs. / Pkt. |
| MACX MCR-EX-T-UI-UP ¹⁾ | 2865654 | 1 |
| MACX MCR-EX-T-UI-UP-SP ¹⁾ | 2924689 | 1 |
| MACX MCR-EX-T-UI-UP-C ¹⁾ | 2811763 | 1 |
| MACX MCR-EX-T-UI-UP-SP-C ¹⁾ | 2924692 | 1 |
| Accessories | | |
| IFS-USB-PROG-ADAPTER ¹⁾ | 2811271 | 1 |

Ex i isolating amplifiers with SIL functional safety - MACX Analog Ex

Order key for MACX-MCR-EX-T-UI-UP(-SP)-C temperature transducer (standard configuration entered as an example)

| Order No. | Safety integrity level (SIL) | Sensor type | Connection technology | Cold junction compensation | Measuring range: | | Measuring unit | Output range | Factory calibration certificate = FCC |
|--|--|--------------------------------------|---|--|------------------|-----------|--|---|---|
| | | | | | Start | End | | | |
| 2811763 | ON | PT100 | 4 | 0 | -50 | 150 | C | OUT02 | NONE |
| 2811763 ≙ MACX MCR-EX-T-UI-UP-C | ON ≙ active NONE ≙ not active | see below | 2 ≙ 2-conductor 3 ≙ 3-conductor 4 ≙ 4-conductor | 0 ≙ off, e.g., with RTD, R, potentiometer, mV 1 ≙ on, e.g., with TC | see below | see below | C ≙ °C F ≙ °F O ≙ Ω P ≙ % V ≙ mV | OUT15 ≙ 0...5 mA OUT16 ≙ 0...10 mA OUT01 ≙ 0...20 mA OUT15 ≙ 0...5 mA OUT25 ≙ 1...5 mA OUT26 ≙ 2...10 mA OUT02 ≙ 4...20 mA OUT05 ≙ 0...5 V OUT03 ≙ 0...10 V OUT06 ≙ 1...5 V OUT04 ≙ 2...10 V OUT13 ≙ -5...+5 V OUT14 ≙ -10...+10 V Others can be freely configured in the software | NONE ≙ without FCC YES ≙ with FCC (a fee is charged) YESPLUS ≙ FCC with 5 measuring points (a fee is charged) |
| 2924692 ≙ MACX MCR-EX-T-UI-UP-SP-C | ON only with output range = OUT02 | | | | | | | | |
| Resistance thermometers (RTD) Others can be selected or freely configured in the software. | | PT100 ≙ Pt 100 acc. to IEC 751 | | | -200 | 850 | °C | 20 K | Other setting options can be configured with the IFS-CONF software: - Freely configurable user characteristic curve with 30 interpolation points - Output behavior in the event of a short circuit, sensor break or overrange/underrange can be freely configured or set according to NE43 (standard configuration: NE43 upscale) - Filter setting (standard configuration: 1) - Restart after failsafe (standard configuration: ON) - Switching behavior: switching output ? (limit values, times, etc.) (standard configuration: OFF) |
| | PT200 ≙ Pt 200 acc. to IEC 751 | | | -200 | 850 | °C | 20 K | | |
| | PT500 ≙ Pt 500 acc. to IEC 751 | | | -200 | 850 | °C | 20 K | | |
| | PT1000 ≙ Pt 1000 acc. to IEC 751 | | | -200 | 850 | °C | 20 K | | |
| | PT100S ≙ Pt 100 acc. to Sama RC21-4-1966 | | | -200 | 850 | °C | 20 K | | |
| | PT1000S ≙ Pt 1000 acc. to Sama RC21-4-1966 | | | -200 | 850 | °C | 20 K | | |
| | PT100G ≙ Pt 100 acc. to GOST 6651-2009 (α = 0.00385) | | | -200 | 850 | °C | 20 K | | |
| | PT1000G ≙ Pt 1000 acc. to GOST 6651-2009 (α = 0.00385) | | | -200 | 850 | °C | 20 K | | |
| | PT100J ≙ Pt 100 acc. to JIS C1604/1997 | | | -200 | 850 | °C | 20 K | | |
| | PT1000J ≙ Pt 1000 acc. to JIS C1604/1997 | | | -200 | 850 | °C | 20 K | | |
| | NI100 ≙ Ni 100 acc. to DIN 43760/DIN IEC 60751 | | | -60 | 250 | °C | 20 K | | |
| | NI1000 ≙ Ni 1000 acc. to DIN 43760/DIN IEC 60751 | | | -60 | 250 | °C | 20 K | | |
| | NI100S ≙ Ni 100 acc. to Sama RC21-4-1966 | | | -60 | 180 | °C | 20 K | | |
| | NI1000S ≙ Ni 1000 acc. to Sama RC21-4-1966 | | | -60 | 180 | °C | 20 K | | |
| | NI1000L ≙ Ni 1000 (Landis & Gyr) | | | -50 | 160 | °C | 20 K | | |
| | CU10 ≙ Cu 10 acc. to Sama RC21-4-1966 | | | -70 | 500 | °C | 100 K | | |
| | CU50 ≙ Cu 50 acc. to GOST 6651-2009 (α = 0.00428) | | | -50 | 200 | °C | 100 K | | |
| | CU100 ≙ Cu 100 acc. to GOST 6651-20091 (α = 0.00428) | | | -50 | 200 | °C | 100 K | | |
| | CU53 ≙ Cu 53 acc. to GOST 6651-2009 (α = 0.00426) | | | -50 | 180 | °C | 100 K | | |
| | KTY81 ≙ KTY81-110 (Philips) | | | -55 | 150 | °C | 20 K | | |
| | KTY84 ≙ KTY84-130 (Philips) | | | -40 | 300 | °C | 20 K | | |
| Thermocouples (TC) Others can be selected in the software. | | B ≙ acc. to IEC 584-1 (Pt30Rh-Pt6Rh) | | | 500 | 1820 | °C | 50 K | |
| | E ≙ acc. to IEC 584-1 (NiCr-CuNi) | | | -230 | 1000 | °C | 50 K | | |
| | J ≙ acc. to IEC 584-1 (Fe-CuNi) | | | -210 | 1200 | °C | 50 K | | |
| | K ≙ acc. to IEC 584-1 (NiCr-Ni) | | | -250 | 1372 | °C | 50 K | | |
| | N ≙ acc. to IEC 584-1 (NiCrSi-NiSi) | | | -250 | 1300 | °C | 50 K | | |
| | R ≙ acc. to IEC 584-1 (Pt13Rh-Pt) | | | -50 | 1768 | °C | 50 K | | |
| | S ≙ acc. to IEC 584-1 (Pt10Rh-Pt) | | | -50 | 1768 | °C | 50 K | | |
| | T ≙ acc. to IEC 584-1 (Cu-CuNi) | | | -200 | 400 | °C | 50 K | | |
| | L ≙ acc. to DIN 43760 (Fe-CuNi) | | | -200 | 900 | °C | 50 K | | |
| | U ≙ acc. to DIN 43760 (Cu-CuNi) | | | -200 | 600 | °C | 50 K | | |
| | CA ≙ C ASTM JE988 (2002) | | | 0 | 2315 | °C | 50 K | | |
| | DA ≙ D ASTM JE988 (2002) | | | 0 | 2315 | °C | 50 K | | |
| | A1G ≙ A-1 GOST 8.585-2001 | | | 0 | 2500 | °C | 50 K | | |
| | A2G ≙ A-2 GOST 8.585-2001 | | | 0 | 1800 | °C | 50 K | | |
| | A3G ≙ A-3 GOST 8.585-2001 | | | 0 | 1800 | °C | 50 K | | |
| | MG ≙ M GOST 8.585-2001 | | | -200 | 100 | °C | 50 K | | |
| | LG ≙ L GOST 8.585-2001 | | | -200 | 800 | °C | 50 K | | |
| Remote resistance-type sensors (R) (2, 3, 4-conductor) Others can be selected in the software. | | RES03 ≙ 0...150 Ω resistor | | | 0 | 150 | Ω | 10% of the selected measuring range | |
| | RES05 ≙ 0...600 Ω resistor | | | 0 | 600 | Ω | | | |
| | RES06 ≙ 0...1200 Ω resistor | | | 0 | 1200 | Ω | | | |
| | RES09 ≙ 0...6250 Ω resistor | | | 0 | 6250 | Ω | | | |
| | RES10 ≙ 0...12500 Ω resistor | | | 0 | 12500 | Ω | | | |
| | RES12 ≙ 0...50000 Ω resistor | | | 0 | 50000 | Ω | | | |
| Potentiometers (3-conductor) Others can be selected in the software. | | POT03 ≙ 0...150 Ω potentiometer | | | 0 | 100 | % | 10% of the selected measuring range | |
| | POT05 ≙ 0...600 Ω potentiometer | | | 0 | 100 | % | | | |
| | POT06 ≙ 0...1200 Ω potentiometer | | | 0 | 100 | % | | | |
| | POT09 ≙ 0...6250 Ω potentiometer | | | 0 | 100 | % | | | |
| | POT10 ≙ 0...12500 Ω potentiometer | | | 0 | 100 | % | | | |
| | POT12 ≙ 0...50000 Ω potentiometer | | | 0 | 100 | % | | | |
| Voltage signals (mV) Others can be selected in the software. | | V04 ≙ Voltage (mV) | | | -1000 | +1000 | mV | 10% of nominal span | |

Temperature conversion guide for °C to °F: $T [°F] = \frac{9}{5} T [°C] + 32$

Temperature transducer, Ex i

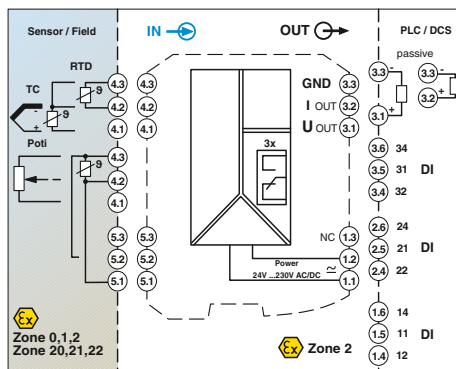
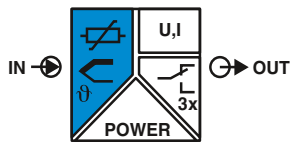

Universal, with three limit value relays, wide-range power supply

Functional safety
Ex: Ex i
Housing width 35 mm

Universal temperature transducer with freely configurable properties for intrinsically safe operation of resistance thermometers, thermocouples, resistance-type sensors, and potentiometers installed in Ex areas

- Input for resistance thermometers, thermocouples, resistance-type sensors, potentiometers, and mV sources, [Ex ia]
- Measure differential temperatures
- Freely programmable input and output
- Option of inverse output signal ranges
- Three limit value relays, can be used in combination as a safe limit value relay
- Configuration via software (FDT-DTM) or IFS-OP-UNIT operating and display unit
- Programming during operation with Ex measuring circuit connected and also voltage-free using IFS-USB-PROG-ADAPTER programming adapter
- Plug-in capable screw or spring-cage connection method
- Cold junction compensation with separate connector
- Wide-range power supply: 19.2 ... 253 V AC/DC
- Status indicator for supply voltage, cable, sensor, and module errors
- Up to SIL 2 according to EN 61508
- Installation in zone 2 permitted

| | |
|--|---|
| Input data | Resistance thermometers Thermocouple sensors |
| Resistor Potentiometer Voltage | |
| Output data | Output signal |
| Maximum output signal Load R_B Behavior in the event of a sensor error | |
| Switching output | Contact type Contact material Maximum switching voltage Maximum switching current |
| General data | Supply voltage range Power consumption Temperature coefficient Transmission error, total Electrical isolation |
| Ambient temperature range Humidity Housing material Inflammability class according to UL 94 Dimensions W / H / D Screw connection solid / stranded / AWG Spring-cage connection (solid/stranded/AWG) | |
| Safety data as per ATEX | Maximum voltage U_o Maximum current I_o Maximum power P_o |
| Conformance / approvals | Conformance ATEX |
| IECEX Functional safety (SIL) | |

Technical data

| | |
|---|---|
| Pt, Ni, Cu sensors: 2, 3, 4-conductor B, E, J, K, N, R, S, T, L, U, CA, DA, A1G, A2G, A3G, MG, LG | |
| 0 Ω ... 50 k Ω 0 Ω ... 50 k Ω -1000 mV ... 1000 mV | |
| U output 4 mA ... 20 mA (in the case of SIL; further free configuration without SIL) | I output |
| ± 11 V ≥ 10 k Ω | 22 mA $\leq 600 \Omega$ (20 mA) |
| According to NE 43 or freely configurable | |
| Relay output | 3 PDTs AgSnO ₂ , hard gold-plated 250 V AC (250 V DC) 2 A (250 V AC) / 2 A (28 V DC) |
| 24 V ... 230 V AC/DC (-20%/+10%, 50/60 Hz) < 2.4 W 0.01%/K < 0.1% (e.g., for Pt 100, 300 K span, 4 ... 20 mA) | |
| Input/output/power supply Input/output Input/power supply Input/switching output Output/power supply | 2.5 kV (50 Hz, 1 min., test voltage) 375 V (Peak value in accordance with EN 60079-11) 375 V (Peak value in accordance with EN 60079-11) 375 V (Peak value in accordance with EN 60079-11) 300 V _{rms} (Rated insulation voltage, surge voltage category II; pollution degree 2, safe isolation as per EN 61010, EN 50178) |
| -20°C ... 65°C Typ. 5% ... 95% (no condensation) PA 66-FR V0 35 / 99 / 114.5 mm 0.2 ... 2.5 mm ² / 0.2 ... 2.5 mm ² / 24 - 14 0.2 ... 1.5 mm ² / 0.2 ... 1.5 mm ² / 24 - 16 | |
| 6 V 7.4 mA 11 mW | |
| CE-compliant Ex II (1) G [Ex ia Ga] IIC Ex II (1) D [Ex ia Da] IIIC Ex II 3 G Ex nA nC ic IIC T4 Gc X [Ex ia Ga] IIC; [Ex ia Da] IIIC; Ex nA nC ic IIC T4 Gc SIL 2, PL d | |

| |
|--|
| Notes: |
| To order a product with an order configuration, enter the required configuration by referring to the adjacent order key. |
| The configuration software can be downloaded from the Internet (www.phoenixcontact.net/products). |
| Information on the IFS-OP-UNIT operating and display unit and the associated IFS-OP-CRADLE DIN rail cradle can be found on page 118 |
| For information on the programming adapter, refer to page 119 |
| 1) EMC: Class A product, see page 571 |

| | |
|------------------------|---|
| Description | Temperature transducer, intrinsically safe input |
| Standard configuration | Screw connection |
| Standard configuration | Spring-cage conn. |
| Order configuration | Screw connection |
| Order configuration | Spring-cage conn. |

Ordering data

| Type | Order No. | Pcs. / Pkt. |
|---|-----------|-------------|
| MACX MCR-EX-T-UIREL-UP ¹⁾ | 2865751 | 1 |
| MACX MCR-EX-T-UIREL-UP-SP ¹⁾ | 2924799 | 1 |
| MACX MCR-EX-T-UIREL-UP-C ¹⁾ | 2865722 | 1 |
| MACX MCR-EX-T-UIREL-UP-SP-C ¹⁾ | 2924809 | 1 |

Accessories

| | | |
|------------------------------------|---------|---|
| IFS-USB-PROG-ADAPTER ¹⁾ | 2811271 | 1 |
|------------------------------------|---------|---|

Programming adapter for configuring modules with S-PORT interface

Ex i isolating amplifiers with SIL functional safety - MACX Analog Ex

Order key for MACX-MCR-EX-T-UIREL-UP(-SP)-C temperature transducer (standard configuration entered as an example)

| Order No. | Safety integrity level (SIL) | Sensor type | Connection technology | Cold junction compensation | Measuring range: | | Measuring unit | Output range | Factory calibration certificate = FCC |
|--|-----------------------------------|--|---|--|---|--|--|---|---|
| | | | | | Start | End | | | |
| 2865722 | ON | PT100 | 4 | 0 | -50 | 150 | C | OUT02 | NONE |
| 2865722 ≙ MACX MCR-EX-T-UIREL-UP-C | ON ≙ active NONE ≙ not active | see below | 2 ≙ 2-conductor 3 ≙ 3-conductor 4 ≙ 4-conductor | 0 ≙ off, e.g., with RTD, R, potentiometer, mV 1 ≙ on, e.g., with TC | see below | see below | C ≙ °C F ≙ °F O ≙ Ω P ≙ % V ≙ mV | OUT15 ≙ 0...5 mA OUT16 ≙ 0...10 mA OUT01 ≙ 0...20 mA OUT15 ≙ 0...5 mA OUT25 ≙ 1...5 mA OUT26 ≙ 2...10 mA OUT02 ≙ 4...20 mA OUT05 ≙ 0...5 V OUT03 ≙ 0...10 V OUT06 ≙ 1...5 V OUT04 ≙ 2...10 V OUT13 ≙ -5...+5 V OUT14 ≙ -10...+10 V Others can be freely configured in the software | NONE ≙ without FCC YES ≙ with FCC (a fee is charged) YESPLUS ≙ FCC with 5 measuring points (a fee is charged) |
| 2924809 ≙ MACX MCR-EX-T-UIREL-UP-SP-C | ON only with output range = OUT02 | | | | | | | | |
| Resistance thermometers (RTD) Others can be selected or freely configured in the software. | | PT100 ≙ Pt 100 acc. to IEC 751 PT200 ≙ Pt 200 acc. to IEC 751 PT500 ≙ Pt 500 acc. to IEC 751 PT1000 ≙ Pt 1000 acc. to IEC 751 PT100S ≙ Pt 100 acc. to Sama RC21-4-1966 PT1000S ≙ Pt 1000 acc. to Sama RC21-4-1966 PT100G ≙ Pt 100 acc. to GOST 6651-2009 (α = 0.00385) PT1000G ≙ Pt 1000 acc. to GOST 6651-2009 (α = 0.00385) PT100J ≙ Pt 100 acc. to JIS C1604/1997 PT1000J ≙ Pt 1000 acc. to JIS C1604/1997 NI100 ≙ Ni 100 acc. to DIN 43760/DIN IEC 60751 NI1000 ≙ Ni 1000 acc. to DIN 43760/DIN IEC 60751 NI100S ≙ Ni 100 acc. to Sama RC21-4-1966 NI1000S ≙ Ni 1000 acc. to Sama RC21-4-1966 NI1000L ≙ Ni 1000 (Landis & Gyr) CU10 ≙ Cu 10 acc. to Sama RC21-4-1966 CU50 ≙ Cu 50 acc. to GOST 6651-2009 (α = 0.00428) CU100 ≙ Cu 100 acc. to GOST 6651-2009 (α = 0.00428) CU53 ≙ Cu 53 acc. to GOST 6651-2009 (α = 0.00426) KTY81 ≙ KTY81-110 (Philips) KTY84 ≙ KTY84-130 (Philips) | | | -200 -200 -200 -200 -200 -200 -200 -200 -200 -200 -60 -60 -60 -60 -50 -70 -50 -50 -50 -50 -55 -40 | 850 850 850 850 850 850 850 850 850 850 250 250 180 180 160 500 200 200 180 300 | °C | 20 K 20 K 20 K 20 K 20 K 20 K 20 K 20 K 20 K 20 K 20 K 20 K 20 K 20 K 100 K 100 K 100 K 100 K 20 K 20 K | - Freely configurable user characteristic curve with 30 interpolation points - Output behavior in the event of a short circuit, sensor break or overrange/underrange can be freely configured or set according to NE43 (standard configuration: NE43 upscale) - Filter setting (standard configuration: 1) - Restart after failsafe (standard configuration: ON) - Switching behavior: switching output ? (limit values, times, etc.) (standard configuration: OFF) |
| Thermocouples (TC) Others can be selected in the software. | | B ≙ acc. to IEC 584-1 (Pt30Rh-Pt6Rh) E ≙ acc. to IEC 584-1 (NiCr-CuNi) J ≙ acc. to IEC 584-1 (Fe-CuNi) K ≙ acc. to IEC 584-1 (NiCr-Ni) N ≙ acc. to IEC 584-1 (NiCrSi-NiSi) R ≙ acc. to IEC 584-1 (Pt13Rh-Pt) S ≙ acc. to IEC 584-1 (Pt10Rh-Pt) T ≙ acc. to IEC 584 (Cu-CuNi) L ≙ acc. to DIN 43760 (Fe-CuNi) U ≙ acc. to DIN 43760 (Cu-CuNi) CA ≙ C ASTM JE988 (2002) DA ≙ D ASTM JE988 (2002) A1G ≙ A-1 GOST 8.585-2001 A2G ≙ A-2 GOST 8.585-2001 A3G ≙ A-3 GOST 8.585-2001 MG ≙ M GOST 8.585-2001 LG ≙ L GOST 8.585-2001 | | | 500 -230 -210 -250 -250 -50 -50 -200 -200 -200 0 0 0 0 0 -200 -200 0 0 0 0 0 0 0 0 0 -200 -200 | 1820 1000 1200 1372 1300 1768 1768 400 900 600 2315 2315 2500 1800 1800 100 800 | °C | 50 K | |
| Remote resistance-type sensors (R) (2, 3, 4-conductor) Others can be selected in the software. | | RES03 ≙ 0...150 Ω resistor RES05 ≙ 0...600 Ω resistor RES06 ≙ 0...1200 Ω resistor RES09 ≙ 0...6250 Ω resistor RES10 ≙ 0...12500 Ω resistor RES12 ≙ 0...50000 Ω resistor | | | 0 0 0 0 0 0 | 150 600 1200 6250 12500 50000 | Ω Ω Ω Ω Ω Ω | 10% of the selected measuring range | |
| Potentiometers (3-conductor) Others can be selected in the software. | | POT03 ≙ 0...150 Ω potentiometer POT05 ≙ 0...600 Ω potentiometer POT06 ≙ 0...1200 Ω potentiometer POT09 ≙ 0...6250 Ω potentiometer POT10 ≙ 0...12500 Ω potentiometer POT12 ≙ 0...50000 Ω potentiometer | | | 0 0 0 0 0 0 | 100 100 100 100 100 100 | % % % % % % | 10% of the selected measuring range | |
| Voltage signals (mV) Others can be selected in the software. | | V04 ≙ Voltage (mV) | | | -1000 | +1000 | mV | 10% of nominal span | |

Temperature conversion guide for °C to °F: $T [°F] = \frac{9}{5} T [°C] + 32$

Digital IN
NAMUR isolating amplifier, Ex i

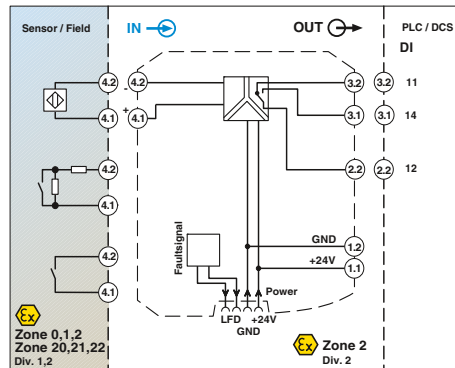
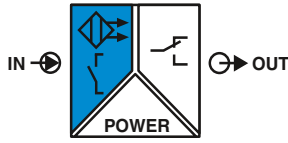

Signal output: PDT relay

Functional safety
Ex:
Housing width 12.5 mm

NAMUR isolating amplifier for intrinsically safe operation of proximity sensors and mechanical contacts installed in Ex areas.

- Input for NAMUR proximity sensors (EN 60947-5-6), floating contacts or contacts with resistance circuit, [Ex ia]
- Relay signal output (PDT)
- Reversible direction of action (operating current or closed-circuit current behavior)
- Line fault detection (LFD), can be activated/deactivated, error message signaled by red flashing LED with de-excitation of output relay
- Power supply and error indication possible via the DIN rail connector
- LED displays for indicating supply voltage, circuit state, and malfunctions to NAMUR NE 44
- 3-way electrical isolation
- Up to SIL 2 according to EN 61508
- Installation in zone 2 permitted

| Notes: |
|---|
| Information about the supply and error evaluation module as well as about the DIN rail connectors and marking material can be found from page 182 |
| Information about resistance circuits is given on page 183 |
| Information on "Plug and play" connection using system cabling can be found from page 184 |
| 1) EMC: Class A product, see page 571 |

| Input data |
|---|
| Input signal |
| No-load voltage |
| Switching points |
| Switching hysteresis |
| Line error detection |
| Switching output |
| Contact type |
| Contact material |
| Maximum switching voltage |
| Maximum switching capacity |
| Recommended minimum load |
| Mechanical service life |
| Switching behavior |
| Maximum switching frequency |
| General data |
| Supply voltage range |
| Current consumption |
| Power dissipation |
| Number of channels |
| Electrical isolation |
| Ambient temperature range |
| Humidity |
| Status indication |
| Housing material |
| Inflammability class according to UL 94 |
| Dimensions W / H / D |
| Screw connection solid / stranded / AWG |
| Spring-cage connection (solid/stranded/AWG) |
| Safety data as per ATEX |
| Maximum voltage U_o |
| Maximum current I_o |
| Maximum power P_o |
| Maximum voltage U_m |
| Conformance / approvals |
| Conformance |
| ATEX |
| IECEX |
| UL, USA / Canada |
| Functional safety (SIL) |

Technical data

| |
|--|
| NAMUR proximity sensors (EN 60947-5-6) |
| Floating switch contacts |
| Switch contacts with resistance circuit |
| 8 V DC $\pm 10\%$ |
| > 2.1 mA (conductive) / < 1.2 mA (blocking) |
| < 0.2 mA |
| Break 0.05 mA $< I_N < 0.35$ mA |
| Short-circuit $100 \Omega < R_{\text{Sensor}} < 360 \Omega$ |
| Relay output |
| 1 PDT |
| AgSnO ₂ , hard gold-plated |
| 250 V AC (2 A) / 120 V DC (0.2 A) / 30 V DC (2 A) |
| 500 VA |
| 5 V / 10 mA |
| 10 ⁷ cycles |
| Can be inverted via slide switch |
| 20 Hz (without load) |
| 19.2 V DC ... 30 V DC |
| 21 mA (24 V DC) |
| < 650 mW |
| 1 |
| 375 V (Peak value in accordance with EN 60079-11) |
| 375 V (Peak value in accordance with EN 60079-11) |
| 300 V _{rms} (Rated insulation voltage, surge voltage category II; pollution degree 2, basic insulation as per EN 61010, EN 50178) |
| 2.5 kV (50 Hz, 1 min., test voltage) |
| -20°C ... 60°C (Any mounting position) |
| 10% ... 95% (no condensation) |
| Green LED (supply voltage) |
| LED yellow (switching state) |
| Red LED (line errors) |
| PA 66-FR |
| V0 |
| 12.5 / 99 / 114.5 mm |
| 0.2 ... 2.5 mm ² / 0.2 ... 2.5 mm ² / 24 - 14 |
| 0.2 ... 1.5 mm ² / 0.2 ... 1.5 mm ² / 24 - 16 |
| 9.6 V |
| 10 mA |
| 25 mW |
| 253 V AC (125 V DC) |
| CE-compliant, additionally EN 61326 |
| II (1) G [Ex ia Ga] IIC |
| II (1) D [Ex ia Da] IIC |
| II 3 G Ex nA nC IIC T4 Gc X |
| [Ex ia Ga] IIC; [Ex ia Da] IIC; Ex nA nC IIC T4 Gc |
| Class I Div 2; IS for Class I, II, III Div 1 |
| SIL 2 according to EN 61508 |

Ordering data

| Description |
|---|
| NAMUR isolating amplifier, 1-channel, input intrinsically safe, output: PDT contact |
| Screw connection |
| Spring-cage conn. |

| Type | Order No. | Pcs. / Pkt. |
|--|-----------|-------------|
| MACX MCR-EX-SL-NAM-R ¹) | 2865434 | 1 |
| MACX MCR-EX-SL-NAM-R-SP ¹) | 2924045 | 1 |

Digital IN
NAMUR isolating amplifier, Ex i



2 signal outputs: N/O contact relay

Functional safety
Ex: Ex i
Housing width 12.5 mm

NAMUR isolating amplifier for intrinsically safe operation of proximity sensors and mechanical contacts installed in Ex areas.

- Input for NAMUR proximity sensors (EN 60947-5-6), floating contacts or contacts with resistance circuit, [Ex ia]
- Two relay signal outputs (N/O contact); output 2 can be used as an error message output
- Reversible direction of action (operating current or closed-circuit current behavior)
- Line fault detection (LFD), can be activated/deactivated, error message signaled by red flashing LED with de-excitation of output relay
- Power supply and error indication possible via the DIN rail connector
- LED displays for indicating supply voltage, circuit state, and malfunctions to NAMUR NE 44
- 4-way electrical isolation
- Up to SIL 2 according to EN 61508
- Installation in zone 2 permitted

Input data
Input signal

No-load voltage
Switching points
Switching hysteresis
Line error detection

Switching output

Contact type
Contact material
Maximum switching voltage
Maximum switching capacity
Recommended minimum load
Mechanical service life
Switching behavior
Maximum switching frequency

General data

Supply voltage range
Current consumption
Power dissipation
Number of channels
Electrical isolation

Input/output
Input/power supply
Input/supply, T connector

Output 1/output 2/input, power supply, T connector

Ambient temperature range
Humidity
Status indication

Housing material
Inflammability class according to UL 94
Dimensions W / H / D
Screw connection solid / stranded / AWG
Spring-cage connection (solid/stranded/AWG)

Safety data as per ATEX

Maximum voltage U_o
Maximum current I_o
Maximum power P_o
Maximum voltage U_m

Conformance / approvals

Conformance
ATEX

IECEX
UL, USA / Canada
Functional safety (SIL)

Technical data

NAMUR proximity sensors (EN 60947-5-6)
Floating switch contacts
Switch contacts with resistance circuit
8 V DC $\pm 10\%$
> 2.1 mA (conductive) / < 1.2 mA (blocking)
< 0.2 mA
Break 0.05 mA < I_{IN} < 0.35 mA
Short-circuit 100 Ω < R_{Sensor} < 360 Ω
Relay output
2 N/O contacts
AgSnO₂, hard gold-plated
250 V AC (2 A) / 120 V DC (0.2 A) / 30 V DC (2 A)
500 VA
5 V / 10 mA
10⁷ cycles
Can be inverted via slide switch
20 Hz (without load)

19.2 V DC ... 30 V DC
30 mA (24 V DC)
< 950 mW
1
375 V (Peak value in accordance with EN 60079-11)
375 V (Peak value in accordance with EN 60079-11)
300 V_{rms} (Rated insulation voltage, surge voltage category II; pollution degree 2, basic insulation as per EN 61010, EN 50178)
2.5 kV (50 Hz, 1 min., test voltage)
300 V_{rms} (Rated insulation voltage, surge voltage category III; pollution degree 2, safe isolation as per EN 61010, EN 50178)
2.5 kV (50 Hz, 1 min., test voltage)
-20°C ... 60°C (Any mounting position)
10% ... 95% (no condensation)
Green LED (supply voltage)
LED yellow (switching state)
Red LED (line errors)
PA 66-FR
V0
12.5 / 99 / 114.5 mm
0.2 ... 2.5 mm² / 0.2 ... 2.5 mm² / 24 - 14
0.2 ... 1.5 mm² / 0.2 ... 1.5 mm² / 24 - 16

9.6 V
10 mA
25 mW
253 V AC (125 V DC)

CE-compliant, additionally EN 61326
Ex II (1) G [Ex ia Ga] IIC
Ex II (1) D [Ex ia Da] IIIC
Ex II 3 G Ex nA nC IIC T4 Gc X
[Ex ia Ga] IIC; [Ex ia Da] IIIC; Ex nA nC IIC T4 Gc
Class I Div 2; IS for Class I, II, III Div 1
SIL 2 according to EN 61508

Ordering data

| Description | Type | Order No. | Pcs. / Pkt. |
|--|---|-----------|-------------|
| NAMUR isolating amplifier, 1-channel, input intrinsically safe, output: 2 N/O contacts | MACX MCR-EX-SL-NAM-2RO ¹⁾ | 2865450 | 1 |
| Screw connection | MACX MCR-EX-SL-NAM-2RO-SP ¹⁾ | 2924061 | 1 |
| Spring-cage conn. | | | |

Notes:

Information about the supply and error evaluation module as well as about the DIN rail connectors and marking material can be found from page 182

Information about resistance circuits is given on page 183

Information on "Plug and play" connection using system cabling can be found from page 184

1) EMC: Class A product, see page 571

Digital IN
NAMUR isolating amplifier, Ex i

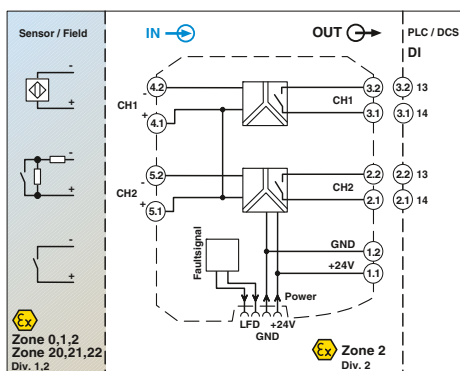
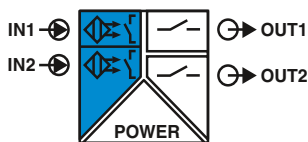

2-channel, signal output: N/O contact relay

Functional safety

Ex: Ex i

Housing width 12.5 mm

Technical data

NAMUR isolating amplifier for intrinsically safe operation of proximity sensors and mechanical contacts installed in Ex areas.

- 2-channel
- Input for NAMUR proximity sensors (EN 60947-5-6), floating contacts or contacts with resistance circuit, [Ex ia]
- Relay signal output (N/O contact)
- Reversible direction of action (operating current or closed-circuit current behavior)
- Line fault detection (LFD), can be activated/deactivated, error message signaled by red flashing LED with de-excitation of output relay
- Power supply and error indication possible via the DIN rail connector
- LED displays for indicating supply voltage, circuit state, and malfunctions to NAMUR NE 44
- 3-way electrical isolation
- Up to SIL 2 according to EN 61508
- Installation in zone 2 permitted

Input data

Input signal
No-load voltage
Switching points
Switching hysteresis
Line error detection

Switching output

Contact type
Contact material
Maximum switching voltage
Maximum switching capacity
Recommended minimum load
Mechanical service life
Switching behavior
Maximum switching frequency

General data

Supply voltage range
Current consumption
Power dissipation
Number of channels
Electrical isolation

Input/output
Input/power supply
Input/supply, T connector

Output 1/output 2/input, power supply, T connector

Ambient temperature range
Humidity
Status indication

Housing material
Inflammability class according to UL 94
Dimensions W / H / D
Screw connection solid / stranded / AWG
Spring-cage connection (solid/stranded/AWG)

Safety data as per ATEX

Maximum voltage U_o
Maximum current I_o
Maximum power P_o
Maximum voltage U_m

Conformance / approvals

Conformance
ATEX

IECEX
UL, USA / Canada
Functional safety (SIL)

375 V (Peak value in accordance with EN 60079-11)
375 V (Peak value in accordance with EN 60079-11)
300 V_{rms} (Rated insulation voltage, surge voltage category II; pollution degree 2, basic insulation as per EN 61010, EN 50178)
2.5 kV (50 Hz, 1 min., test voltage)

300 V_{rms} (Rated insulation voltage, surge voltage category III; pollution degree 2, safe isolation as per EN 61010, EN 50178)
2.5 kV (50 Hz, 1 min., test voltage)

-20°C ... 60°C (Any mounting position)

5% ... 95% (no condensation)

Green LED (supply voltage)

LED yellow (switching state)

Red LED (line errors)

PA 66-FR

V0

12.5 / 99 / 114.5 mm

0.2 ... 2.5 mm² / 0.2 ... 2.5 mm² / 24 - 14

0.2 ... 1.5 mm² / 0.2 ... 1.5 mm² / 24 - 16

9.6 V

10.3 mA

25 mW

253 V AC (125 V DC)

CE-compliant, additionally EN 61326

Ex II (1) G [Ex ia Ga] IIC

Ex II (1) D [Ex ia Da] IIIC

Ex II 3 G Ex nA nC IIC T4 Gc X

[Ex ia Ga] IIC; [Ex ia Da] IIIC; Ex nA nC IIC T4 Gc

Class I Div 2; IS for Class I, II, III Div 1

SIL 2 according to EN 61508

Ordering data

| Type | Order No. | Pcs. / Pkt. |
|---|-----------|-------------|
| MACX MCR-EX-SL-2NAM-RO ¹⁾ | 2865476 | 1 |
| MACX MCR-EX-SL-2NAM-RO-SP ¹⁾ | 2924087 | 1 |

Description

NAMUR isolating amplifier, 2-channel, input intrinsically safe, output: N/O contact
Screw connection
Spring-cage conn.

Digital IN
NAMUR isolating amplifier, Ex i



2-channel, signal output: PDT relay, wide-range power supply

Functional safety
Ex: // Applied for: cUL / UL
Housing width 17.5 mm

NAMUR isolating amplifier for intrinsically safe operation of proximity sensors and mechanical contacts installed in Ex areas.

- 2-channel
- Input for NAMUR proximity sensors (EN 60947-5-6), floating contacts or contacts with resistance circuit, [Ex ia]
- Relay signal output (PDT)
- Reversible direction of action (operating current or closed-circuit current behavior)
- Line fault detection (LFD), can be activated/deactivated, error message signaled by red flashing LED with de-excitation of output relay
- Wide-range power supply: 19.2 ... 253 V AC/DC
- LED displays for indicating supply voltage, circuit state, and malfunctions to NAMUR NE 44
- 3-way electrical isolation
- Up to SIL 2 according to EN 61508
- Installation in zone 2 permitted

| | |
|---|---|
| Input data | |
| Input signal | |
| No-load voltage | |
| Switching points | |
| Switching hysteresis | |
| Line error detection | |
| Switching output | |
| Contact type | |
| Contact material | |
| Maximum switching voltage | |
| Maximum switching capacity | |
| Recommended minimum load | |
| Mechanical service life | |
| Switching behavior | |
| Max. switching frequency | |
| General data | |
| Supply voltage range | |
| Current consumption | |
| Power dissipation | |
| Electrical isolation | |
| Input/output | 375 V (Peak value in accordance with EN 60079-11) |
| Input/power supply | 375 V (Peak value in accordance with EN 60079-11) |
| | 300 V _{rms} (Rated insulation voltage, surge voltage category II; pollution degree 2, safe isolation as per EN 61010, EN 50178) |
| | 2.5 kV AC (50 Hz, 1 min., test voltage) |
| Output 1/output 2/input, power supply | 300 V _{rms} (Rated insulation voltage, surge voltage category III; pollution degree 2, safe isolation as per EN 61010, EN 50178) |
| | 2.5 kV (50 Hz, 1 min., test voltage) |
| Ambient temperature range | -20°C ... 60°C |
| Humidity | 10% ... 95% (no condensation) |
| Housing material | PA 66-FR |
| Inflammability class according to UL 94 | V0 |
| Dimensions W / H / D | 17.5 / 99 / 114.5 mm |
| Screw connection solid / stranded / AWG | 0.2 ... 2.5 mm ² / 0.2 ... 2.5 mm ² / 24 - 14 |
| Spring-cage connection (solid/stranded/AWG) | 0.2 ... 1.5 mm ² / 0.2 ... 1.5 mm ² / 24 - 16 |
| Safety data as per ATEX | |
| Maximum voltage U _o | 9.6 V |
| Maximum current I _o | 10.3 mA |
| Maximum power P _o | 25 mW |
| Maximum voltage U _m | 253 V AC/DC (Supply terminals) |
| | 250 V AC (Output terminals) |
| | 120 V DC (Output terminals) |
| Conformance / approvals | |
| Conformance | |
| ATEX | |
| IECEX | |
| Functional safety (SIL) | |
| CE-compliant, additionally EN 61326 | |
| II (1) G [Ex ia Ga] IIC | |
| II (1) D [Ex ia Da] IIIC | |
| II 3(1) G Ex nA nC [ia Ga] IIC T4 Gc X | |
| [Ex ia Ga] IIC; [Ex ia Da] IIIC; Ex nA nC [ia Ga] IIC T4 Gc | |
| SIL 2 according to EN 61508 | |

Technical data

| | |
|---|---|
| NAMUR proximity sensors (EN 60947-5-6) | |
| open circuit switch contacts | |
| Switch contacts with resistance circuit | |
| 8 V DC ±10% | |
| > 2.1 mA (conductive) / < 1.2 mA (blocking) | |
| Approx. 0.2 mA | |
| Break 0.05 mA < I _N < 0.35 mA | |
| Short-circuit 100 Ω < R _{Sensor} < 360 Ω | |
| Relay output | |
| 2 PDT | |
| AgSnO ₂ , hard gold-plated | |
| 250 V AC (2 A, 60 Hz) / 120 V DC (0.2 A) / 30 V DC (2 A) | |
| 500 VA | |
| 5 V / 10 mA | |
| 10 ⁷ cycles | |
| can be inverted using DIP switch | |
| 20 Hz (Load-dependent) | |
| 24 V ... 230 V AC/DC (-20% ... +10%, 50 ... 60 Hz) | |
| < 80 mA ; < 42 mA (24 V DC) | |
| max. 1.3 W | |
| Input/output | 375 V (Peak value in accordance with EN 60079-11) |
| Input/power supply | 375 V (Peak value in accordance with EN 60079-11) |
| | 300 V _{rms} (Rated insulation voltage, surge voltage category II; pollution degree 2, safe isolation as per EN 61010, EN 50178) |
| | 2.5 kV AC (50 Hz, 1 min., test voltage) |
| Output 1/output 2/input, power supply | 300 V _{rms} (Rated insulation voltage, surge voltage category III; pollution degree 2, safe isolation as per EN 61010, EN 50178) |
| | 2.5 kV (50 Hz, 1 min., test voltage) |
| Ambient temperature range | -20°C ... 60°C |
| Humidity | 10% ... 95% (no condensation) |
| Housing material | PA 66-FR |
| Inflammability class according to UL 94 | V0 |
| Dimensions W / H / D | 17.5 / 99 / 114.5 mm |
| Screw connection solid / stranded / AWG | 0.2 ... 2.5 mm ² / 0.2 ... 2.5 mm ² / 24 - 14 |
| Spring-cage connection (solid/stranded/AWG) | 0.2 ... 1.5 mm ² / 0.2 ... 1.5 mm ² / 24 - 16 |
| Safety data as per ATEX | |
| Maximum voltage U _o | 9.6 V |
| Maximum current I _o | 10.3 mA |
| Maximum power P _o | 25 mW |
| Maximum voltage U _m | 253 V AC/DC (Supply terminals) |
| | 250 V AC (Output terminals) |
| | 120 V DC (Output terminals) |
| Conformance / approvals | |
| Conformance | |
| ATEX | |
| IECEX | |
| Functional safety (SIL) | |
| CE-compliant, additionally EN 61326 | |
| II (1) G [Ex ia Ga] IIC | |
| II (1) D [Ex ia Da] IIIC | |
| II 3(1) G Ex nA nC [ia Ga] IIC T4 Gc X | |
| [Ex ia Ga] IIC; [Ex ia Da] IIIC; Ex nA nC [ia Ga] IIC T4 Gc | |
| SIL 2 according to EN 61508 | |

Notes:
Information on resistance circuits and marking material can be found on page 183
1) EMC: Class A product, see page 571

Ordering data

| Description | Type | Order No. | Pcs. / Pkt. | |
|--|-------------------|-------------------------------|-------------|---|
| NAMUR isolating amplifier, 2-channel, input intrinsically safe, output: Changeover contact | | | | |
| | Screw connection | MACX MCR-EX-SL-2NAM-R-UP') | 2865984 | 1 |
| | Spring-cage conn. | MACX MCR-EX-SL-2NAM-R-UP-SP') | 2924249 | 1 |

Digital IN
NAMUR isolating amplifier, Ex i

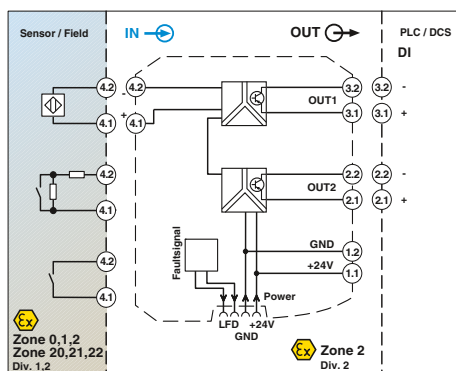
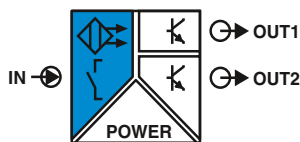

2 signal outputs: transistor (passive)

Functional safety

Ex: Ex i

Housing width 12.5 mm

Technical data

NAMUR isolating amplifier for intrinsically safe operation of proximity sensors and mechanical contacts installed in Ex areas.

- Input for NAMUR proximity sensors (EN 60947-5-6), floating contacts or contacts with resistance circuit, [Ex ia]
- 2 signal outputs: transistor (passive); up to 5 kHz
- Signal output 2 can also be used as a fault signaling output
- Reversible direction of action (operating current or closed-circuit current behavior)
- Line fault detection (LFD), can be activated/deactivated, error message signaled by red flashing LED with inhibiting of transistor output
- Power supply and error indication possible via the DIN rail connector
- LED displays for indicating supply voltage, circuit state, and malfunctions to NAMUR NE 44
- 4-way electrical isolation
- Up to SIL 2 according to EN 61508
- Installation in zone 2 permitted

| | |
|---|---|
| Input data | |
| Input signal | |
| No-load voltage | |
| Switching points | |
| Line error detection | |
| Switching output | |
| Maximum switching voltage | |
| Maximum switching current | |
| Drop (ΔU) | |
| Switching behavior | |
| Maximum switching frequency | |
| General data | |
| Supply voltage range | |
| Current consumption | |
| Power dissipation | |
| Number of channels | |
| Electrical isolation | |
| Input/output | 375 V (Peak value in accordance with EN 60079-11) |
| Input/supply, T-Connector | 375 V (Peak value in accordance with EN 60079-11) |
| Input/output/supply, T-Connector | 300 V _{rms} (Rated insulation voltage, surge voltage category II; pollution degree 2, safe isolation as per EN 61010, EN 50178) 2.5 kV (50 Hz, 1 min., test voltage) |
| Output 1/output 2 | 50 V _{rms} (Rated insulation voltage, surge voltage category II; pollution degree 2, safe isolation as per EN 61010, EN 50178) 1 kV (50 Hz, 1 min., test voltage) |
| Ambient temperature range | -20°C ... 60°C (Any mounting position) |
| Humidity | 10% ... 95% (no condensation) |
| Status indication | Green LED (supply voltage) LED yellow (switching state) Red LED (line errors) |
| Housing material | PA 66-FR |
| Inflammability class according to UL 94 | V0 |
| Dimensions W / H / D | 12.5 / 99 / 114.5 mm |
| Screw connection solid / stranded / AWG | 0.2 ... 2.5 mm ² / 0.2 ... 2.5 mm ² / 24 - 14 |
| Spring-cage connection (solid/stranded/AWG) | 0.2 ... 1.5 mm ² / 0.2 ... 1.5 mm ² / 24 - 16 |
| Safety data as per ATEX | |
| Maximum voltage U _o | 9.6 V |
| Maximum current I _o | 10 mA |
| Maximum power P _o | 25 mW |
| Maximum voltage U _m | 253 V AC (125 V DC) |
| Conformance / approvals | |
| Conformance | |
| ATEX | |
| IECEX | |
| UL, USA / Canada | |
| Functional safety (SIL) | |

NAMUR proximity sensors (EN 60947-5-6)
Floating switch contacts
Switch contacts with resistance circuit
8 V DC $\pm 10\%$
> 2.1 mA (conductive) / < 1.2 mA (blocking)
Break 0.05 mA < I_{th} < 0.35 mA
Short-circuit 100 Ω < R_{sensor} < 360 Ω
2 transistor outputs, passive
30 V DC (per output)
50 mA (short-circuit resistant)
< 1.4 V
can be inverted using DIP switch
5 kHz

| |
|---|
| Notes: |
| Information about the supply and error evaluation module as well as about the DIN rail connectors and marking material can be found from page 182 |
| Information about resistance circuits is given on page 183 |
| Information on "Plug and play" connection using system cabling can be found from page 184 |
| 1) EMC: Class A product, see page 571 |

375 V (Peak value in accordance with EN 60079-11)
375 V (Peak value in accordance with EN 60079-11)
300 V_{rms} (Rated insulation voltage, surge voltage category II; pollution degree 2, safe isolation as per EN 61010, EN 50178) 2.5 kV (50 Hz, 1 min., test voltage)

50 V_{rms} (Rated insulation voltage, surge voltage category II; pollution degree 2, safe isolation as per EN 61010, EN 50178) 1 kV (50 Hz, 1 min., test voltage)

9.6 V
10 mA
25 mW
253 V AC (125 V DC)

CE-compliant, additionally EN 61326
 Ex i II (1) G [Ex ia Ga] IIC
 Ex i II (1) D [Ex ia Da] IIIC
 Ex i II 3 G Ex nA IIC T4 Gc X
[Ex ia Ga] IIC; [Ex ia Da] IIIC; Ex nA IIC T4 Gc
Class I Div 2; IS for Class I, II, III Div 1
SIL 2 according to EN 61508

Ordering data

| Description | Type | Order No. | Pcs. / Pkt. |
|--|--|-----------|-------------|
| NAMUR isolating amplifier, input intrinsically safe, output: Transistor, passive | MACX MCR-EX-SL-NAM-2T ¹⁾ | 2865463 | 1 |
| Screw connection | MACX MCR-EX-SL-NAM-2T-SP ¹⁾ | 2924074 | 1 |
| Spring-cage conn. | | | |

Digital IN
NAMUR isolating amplifier, Ex i



2-channel, signal output transistor (passive)

Functional safety
Ex: Ex i
Housing width 12.5 mm

NAMUR isolating amplifier for intrinsically safe operation of proximity sensors and mechanical contacts installed in Ex areas.

- 2-channel
- Input for NAMUR proximity sensors (EN 60947-5-6), floating contacts or contacts with resistance circuit, [Ex ia]
- Signal output transistor (passive); up to 5 kHz
- Reversible direction of action (operating current or closed-circuit current behavior)
- Line fault detection (LFD), can be activated/deactivated, error message signaled by red flashing LED with inhibiting of transistor output
- Power supply and error indication possible via the DIN rail connector
- LED displays for indicating supply voltage, circuit state, and malfunctions to NAMUR NE 44
- 3-way electrical isolation
- Up to SIL 2 according to EN 61508
- Installation in zone 2 permitted

| | |
|---|----------------------------------|
| Input data | Input signal |
| No-load voltage | |
| Switching points | |
| Line error detection | |
| Switching output | Maximum switching voltage |
| Maximum switching current | |
| Drop (ΔU) | |
| Switching behavior | |
| Maximum switching frequency | |
| General data | Supply voltage range |
| Current consumption | |
| Power dissipation | |
| Number of channels | |
| Electrical isolation | |
| | Input/output |
| | Input/supply, T-Connector |
| | Input/output/supply, T-Connector |
| | Output 1/output 2 |
| Ambient temperature range | |
| Humidity | |
| Status indication | |
| Housing material | |
| Inflammability class according to UL 94 | |
| Dimensions W / H / D | |
| Screw connection solid / stranded / AWG | |
| Spring-cage connection (solid/stranded/AWG) | |
| Safety data as per ATEX | Maximum voltage U_o |
| Maximum current I_o | |
| Maximum power P_o | |
| Maximum voltage U_m | |
| Conformance / approvals | Conformance |
| Conformance | |
| ATEX | |
| IECEX | |
| UL, USA / Canada | |
| Functional safety (SIL) | |

Technical data

| | |
|--|--|
| NAMUR proximity sensors (EN 60947-5-6) | |
| Floating switch contacts | |
| Switch contacts with resistance circuit | |
| 8 V DC $\pm 10\%$ | |
| > 2.1 mA (conductive) / < 1.2 mA (blocking) | |
| Break 0.05 mA < I_{M1} < 0.35 mA | |
| Short-circuit 100 Ω < R_{Sensor} < 360 Ω | |
| Transistor output, passive | |
| 30 V DC (per output) | |
| 50 mA (short-circuit resistant) | |
| < 1.4 V | |
| can be inverted using DIP switch | |
| 5 kHz | |
| 19.2 V DC ... 30 V DC | |
| < 34 mA (24 V DC) | |
| 1000 mW | |
| 2 | |
| 375 V (Peak value in accordance with EN 60079-11) | |
| 375 V (Peak value in accordance with EN 60079-11) | |
| 300 V _{rms} (Rated insulation voltage, surge voltage category II; pollution degree 2, safe isolation as per EN 61010, EN 50178) | |
| 2.5 kV (50 Hz, 1 min., test voltage) | |
| 50 V _{rms} (Rated insulation voltage, surge voltage category II; pollution degree 2, safe isolation as per EN 61010, EN 50178) | |
| 1 kV (50 Hz, 1 min., test voltage) | |
| -20°C ... 60°C (Any mounting position) | |
| 10% ... 95% (no condensation) | |
| Green LED (supply voltage) | |
| LED yellow (switching state) | |
| Red LED (line errors) | |
| PA 66-FR | |
| V0 | |
| 12.5 / 99 / 114.5 mm | |
| 0.2 ... 2.5 mm ² / 0.2 ... 2.5 mm ² / 24 - 14 | |
| 0.2 ... 1.5 mm ² / 0.2 ... 1.5 mm ² / 24 - 16 | |
| 9.6 V | |
| 10.3 mA | |
| 25 mW | |
| 253 V AC (125 V DC) | |
| CE-compliant, additionally EN 61326 | |
| Ex II (1) G [Ex ia Ga] IIC | |
| Ex II (1) D [Ex ia Da] IIIC | |
| Ex II 3 G Ex nA IIC T4 Gc X | |
| [Ex ia Ga] IIC; [Ex ia Da] IIIC; Ex nA IIC T4 Gc | |
| Class I Div 2; IS for Class I, II, III Div 1 | |
| SIL 2 according to EN 61508 | |

| |
|---|
| Notes: |
| Information about the supply and error evaluation module as well as about the DIN rail connectors and marking material can be found from page 182 |
| Information about resistance circuits is given on page 183 |
| Information on "Plug and play" connection using system cabling can be found from page 184 |
| 1) EMC: Class A product, see page 571 |

Ordering data

| Description | Type | Order No. | Pcs. / Pkt. |
|---|----------------------------|-----------|-------------|
| NAMUR isolating amplifier, 2-channel, input intrinsically safe, output: Transistor, passive | MACX MCR-EX-SL-2NAM-T1) | 2865489 | 1 |
| | MACX MCR-EX-SL-2NAM-T-SP1) | 2924090 | 1 |

Digital IN
NAMUR isolating amplifier, Ex i

N



With line fault transparency

NAMUR isolation amplifiers for the intrinsically safe operation of proximity sensors or mechanical contacts installed in the Ex area.

- Input for NAMUR proximity sensors (EN 60947-5-6), floating contacts or contacts with resistance circuit, [Ex ia]
- Signal output with resistive behavior (transistor)
- Signal output with line fault transparency: line error message directly via output to PLC or PCS. The output responds in accordance with EN 60947-5-6.
- Up to 5 kHz
- Direction of operation can be selected
- Line fault detection can be activated/deactivated
- Power supply and error indication possible via the DIN rail connector
- LED indicators for supply voltage, status, and fault according to NAMUR NE 44
- Plug-in screw or spring-cage connection technology
- Safe 3-way electrical isolation
- Up to SIL 2 according to EN 61508
- Installation in zone 2 permissible

| |
|---|
| Notes: |
| Information on the supply and error evaluation module, DIN rail connectors, system cabling, and marking material can be found from page 182 |
| Information about resistance circuits is given on page 183 |

| | |
|---|----------------------------------|
| Input data | Input signal |
| No-load voltage | |
| Switching points | |
| Line error detection | |
| Switching output | Switching voltage |
| Switching frequency | |
| Impedance 0-signal | |
| Impedance 1-signal | |
| Impedance fault | |
| Switching behavior | |
| General data | |
| Supply voltage range | |
| Current draw | |
| Power dissipation | |
| Electrical isolation | |
| | Input/output |
| | Input/supply, T-Connector |
| | Input/output/supply, T-Connector |
| Ambient temperature range | |
| Humidity | |
| Status indication | |
| Housing material | |
| Inflammability class according to UL 94 | |
| Dimensions W / H / D | |
| Screw connection solid / stranded / AWG | |
| Spring-cage connection (solid/stranded/AWG) | |
| Safety data as per ATEX | |
| Maximum voltage U_o | |
| Maximum current I_o | |
| Maximum power P_o | |
| Maximum voltage U_m | |
| Conformance / approvals | |
| Conformance | |
| ATEX | |
| IECEx | |
| Functional safety (SIL) | |

Housing width 12.5 mm

Technical data

| |
|--|
| NAMUR proximity sensors (EN 60947-5-6) |
| Floating switch contacts |
| Switch contacts with resistance circuit |
| 8 V DC $\pm 10\%$ |
| > 2.1 mA (conductive) / < 1.2 mA (blocking) |
| Break 0.05 mA $< I_{IN} < 0.35$ mA |
| Short-circuit $100 \Omega < R_{Sensor} < 360 \Omega$ |
| Resistive (transistor, passive) |
| Typ. 8.2 V DC $\pm 10\%$ (according to EN 60947-5-6) |
| ≤ 5 kHz (Ohmic load) |
| 11 k $\Omega \pm 5\%$ |
| 1.4 k $\Omega \pm 5\%$ |
| > 100 k Ω |
| can be inverted using DIP switch |
| 12 V DC ... 24 V DC $-20\% \dots +25\%$ |
| 25 mA (24 V DC) |
| < 0.6 W |
| 375 V (Peak value in accordance with EN 60079-11) |
| 375 V (Peak value in accordance with EN 60079-11) |
| 300 V _{rms} (Rated insulation voltage, surge voltage category II; pollution degree 2, safe isolation as per EN 61010, EN 50178) |
| 2.5 kV (50 Hz, 1 min., test voltage) |
| $-20^\circ\text{C} \dots 60^\circ\text{C}$ (Any mounting position) |
| $10\% \dots 95\%$ (no condensation) |
| Green LED (supply voltage) |
| LED yellow (switching state) |
| Red LED (line errors) |
| PA 66-FR |
| V0 |
| $12.5 / 99 / 114.5$ mm |
| $0.2 \dots 2.5$ mm ² / $0.2 \dots 2.5$ mm ² / $24 - 14$ |
| $0.2 \dots 1.5$ mm ² / $0.2 \dots 1.5$ mm ² / $24 - 16$ |
| 9.6 V |
| 10 mA |
| 25 mW |
| 253 V AC (125 V DC) |
| CE-compliant, additionally EN 61326 |
| Ex II (1) G [Ex ia Ga] IIC |
| Ex II (1) D [Ex ia Da] IIIC |
| Ex II 3G Ex nA IIC T4 Gc X |
| Yes |
| SIL 2 |

Ordering data

| Type | Order No. | Pcs. / Pkt. |
|---------------------------|-----------|-------------|
| MACX MCR-EX-SL-NAM-NAM | 2866006 | 1 |
| MACX MCR-EX-SL-NAM-NAM-SP | 2924883 | 1 |

| |
|--|
| Description |
| NAMUR isolation amplifier , intrinsically safe input, output with line fault transparency |
| Screw connection |
| Spring-cage conn. |

Digital OUT
Solenoid driver, Ex i



Current limitation 48 mA, with line fault detection

Housing width 12.5 mm

Technical data

| | |
|--|---|
| Input data | Switching level 0 signal ("L") Switching level 1 signal ("H") Input current Input impedance in the event of a line fault at the output |
| Output data | Output voltage Current limitation No-load voltage Internal resistance Immunity to short-circuiting Response time t_A Line error detection |
| Error message output | Switch contact Maximum switching voltage Maximum switching current Short-circuit-proof |
| General data | Supply voltage range Current draw Power dissipation Electrical isolation |
| Ambient temperature range | -20°C ... 60°C (Any mounting position) |
| Humidity | 10% ... 95% (no condensation) |
| Status indication | Green LED (supply voltage) LED yellow (switching state) Red LED (line errors) |
| Degree of protection | IP20 |
| Housing material | PA 66-FR |
| Inflammability class according to UL 94 | V0 |
| Dimensions W / H / D | 12.5 / 99 / 114.5 mm |
| Screw connection solid / stranded / AWG | 0.2 ... 2.5 mm ² / 0.2 ... 2.5 mm ² / 24 - 14 |
| Spring-cage connection (solid/stranded/AWG) | 0.2 ... 1.5 mm ² / 0.2 ... 1.5 mm ² / 24 - 16 |
| Safety data as per ATEX | Maximum voltage U_o Maximum current I_o Maximum power P_o Maximum voltage U_m |
| Conformance / approvals | CE-compliant, additionally EN 61326 Ex II (1) G [Ex ia Ga] IIC Ex II (1) D [Ex ia Da] IIIC Ex II 3(1) G Ex nA [ia Ga] IIC T4 Gc X |
| IECEx | Yes |
| Functional safety (SIL) | SIL 3 (applied for) |

| |
|---|
| 0 V DC ... 5 V DC (Open) |
| 15 V DC ... 30 V DC |
| < 12 mA |
| 3 M Ω (High resistance (Mega Ω)) |

Yes

| |
|--|
| ≥ 9.5 V DC (At 48 mA) |
| > 48 mA (With cable error detection) |
| > 23 V DC |
| $\geq 269 \Omega$ (Internal resistance R_i) |
| Yes |
| < 30 ms |
| < 50 Ω (short circuit on the line) |
| > 10 k Ω (line break) |

| |
|-------------|
| N/C contact |
| 30 V DC |
| 50 mA |
| Yes |

| |
|---|
| 19.2 V DC ... 30 V DC (24 V DC (-20% ... +25%)) |
| < 90 mA |
| < 1.5 W |

Input/output, supply, error message output

| |
|--|
| 375 V (Peak value in accordance with EN 60079-11) |
| 2.5 kV (50 Hz, 1 min., test voltage) |
| 300 V _{rms} (Rated insulation voltage, surge voltage category II; pollution degree 2, safe isolation as per EN 61010, EN 50178) |

Solenoid driver for the intrinsically safe control of Ex i solenoid valves, alarm transmitters or indicators installed in the Ex area.

- Input: logic (low/high signal)
- Output: 48 mA current limitation at 9.5 V, [Ex ia]
- Line fault detection (can be activated/de-activated)
 - Directly via signal channel
 - Or via switching output
- Transparent for test pulses
- Power supply and error indication possible via the DIN rail connector
- LED indicators for supply voltage, status, and fault according to NAMUR NE 44
- Plug-in screw or spring-cage connection technology
- Safe 3-way electrical isolation
- Up to SIL 2 according to EN 61508
- Installation in zone 2 permissible

Notes:

Information on the supply and error evaluation module, DIN rail connectors, system cabling, and marking material can be found from page 182

Ordering data

| Description | Type | Order No. | Pcs. / Pkt. |
|---|--------------------------------|-----------|-------------|
| Solenoid driver , logic input, intrinsically safe output, line fault detection | | | |
| Screw connection | MACX MCR-EX-SL-SD-23-48-LFD | 2924867 | 1 |
| Spring-cage conn. | MACX MCR-EX-SL-SD-23-48-LFD-SP | 2924870 | 1 |

Digital OUT Solenoid driver, Ex i

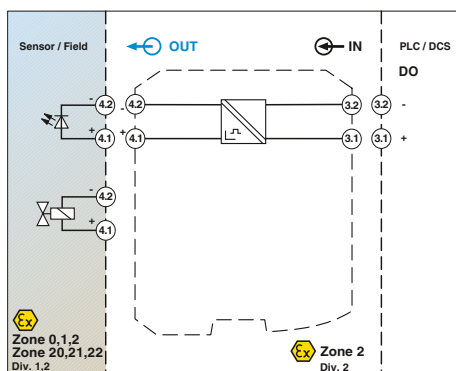

Current limitation 25 mA

Solenoid drivers for controlling intrinsically safe solenoid valves, alarm transmitters, and indicators installed in Ex areas.

- 20 ... 30 V DC input
- Output [Ex ia]
- Various output characteristic curves compatible with the commercial solenoid valves
- Loop-powered: The required power is supplied via the control signal on the input side.
- Mechanically compatible with DIN rail connector
- Galvanic 2-way isolation
- Up to SIL 3 as per EN 61508
- Installation in zone 2 permitted

| Notes: |
|--|
| A list of suitable valves and notes for calculating a valve circuit are available from the download center at www.phoenixcontact.net/products |
| Information on marking material can be found on page 127 |
| Information on "Plug and play" connection using system cabling can be found from page 184 |

| | |
|---|--|
| Input data | |
| Input signal | |
| Input current | |
| Output data | |
| Output voltage | |
| Current limitation | |
| No-load voltage | |
| Internal resistance | |
| Immunity to short-circuiting | |
| Response time t_A | |
| General data | |
| Power dissipation | |
| Temperature coefficient | |
| Electrical isolation | |
| Ambient temperature range | |
| Humidity | |
| Status indication | |
| Degree of protection | |
| Housing material | |
| Inflammability class according to UL 94 | |
| Dimensions W / H / D | |
| Screw connection solid / stranded / AWG | |
| Spring-cage connection (solid/stranded/AWG) | |
| Safety data as per ATEX | |
| Maximum voltage U_o | |
| Maximum current I_o | |
| Maximum power P_o | |
| Maximum voltage U_m | |
| Conformance / approvals | |
| Conformance | |
| ATEX | |
| IECEX | |
| UL, USA / Canada | |
| Functional safety (SIL) | |

Functional safety
Ex: Ex i, Ex ia, Ex ia IIC, Ex ia IIB, Ex ia IIC
Housing width 12.5 mm

| Technical data | |
|---|--|
| Input voltage | 20 V DC ... 30 V DC |
| Input current | 10 mA DC ... 70 mA DC (45 mA for $U_o = 24$ V DC) |
| Output voltage | 5,5 V DC (At 25 mA) |
| Current limitation | 25 mA |
| No-load voltage | 21.9 V DC |
| Internal resistance | 641 Ω (Internal resistance R_i) |
| Immunity to short-circuiting | Yes |
| Response time t_A | 20 ms |
| Power dissipation | < 1 W |
| Temperature coefficient | 0.01%/K |
| Output/input | 375 V (Peak value in accordance with EN 60079-11) 2,5 kV (50 Hz, 1 min., test voltage) 300 V _{rms} (Rated insulation voltage, surge voltage category II; pollution degree 2, safe isolation as per EN 61010, EN 50178) -20°C ... 60°C (Any mounting position) 10% ... 95% (no condensation) Yellow LED (switching state / status, lights up when output circuit is active) |
| IP20 | IP20 |
| PA 66-FR | PA 66-FR |
| V0 | V0 |
| Dimensions W / H / D | 12.5 / 99 / 114.5 mm |
| Screw connection solid / stranded / AWG | 0.2 ... 2.5 mm ² / 0.2 ... 2.5 mm ² / 24 - 14 |
| Spring-cage connection (solid/stranded/AWG) | 0.2 ... 1.5 mm ² / 0.2 ... 1.5 mm ² / 24 - 16 |
| Maximum voltage U_o | 25.1 V |
| Maximum current I_o | 39 mA |
| Maximum power P_o | 245 mW |
| Maximum voltage U_m | 253 V AC (125 V DC) |
| Conformance / approvals | CE-compliant, additionally EN 61326 Ex i IIC II (1) G [Ex ia Ga] IIC/IIB/IIA Ex ia IIC II (1) D [Ex ia Da] IIC Ex ia IIC II 3 G Ex nA IIC T4 Gc X [Ex ia Ga] IIC; [Ex ia Da] IIC; Ex nA IIC T4 Gc X Class I Div 2; IS for Class I, II, III Div 1 SIL 3 |

| Description |
|--|
| Solenoid driver , loop-powered, output intrinsically safe |
| Screw connection |
| Spring-cage conn. |

| Ordering data | | |
|-------------------------------|-----------|-------------|
| Type | Order No. | Pcs. / Pkt. |
| MACX MCR-EX-SL-SD-21-25-LP | 2865492 | 1 |
| MACX MCR-EX-SL-SD-21-25-LP-SP | 2924113 | 1 |

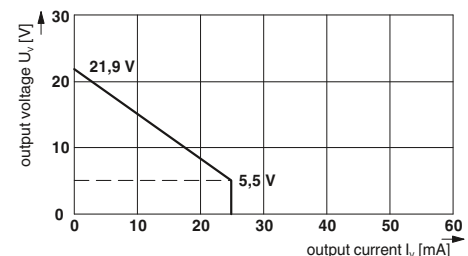

Ex i isolating amplifiers with SIL functional safety - MACX Analog Ex



Current limitation 40 mA

Functional safety
Ex: Ex, Ex, Ex, Ex
Housing width 12.5 mm



Current limitation 48 mA

Functional safety
Ex: Ex, Ex, Ex, Ex
Housing width 12.5 mm



Current limitation 58 mA, [Ex ia] IIB

Functional safety
Ex: Ex, Ex, Ex, Ex
Housing width 12.5 mm

| Technical data | |
|--|--|
| 20 V DC ... 30 V DC 10 mA ... 95 mA (65 mA for $U_o = 24$ V DC) | |
| 10 V DC (At 40 mA) 40 mA 21.9 V DC 287 Ω (Internal resistance R_i) Yes 20 ms | |
| < 1.2 W 0.01%/K | |
| 375 V (Peak value in accordance with EN 60079-11) 2.5 kV (50 Hz, 1 min., test voltage) 300 V _{rms} (Rated insulation voltage, surge voltage category II; pollution degree 2, safe isolation as per EN 61010, EN 50178) -20°C ... 60°C (Any mounting position) 10% ... 95% (no condensation) Yellow LED (switching state / status, lights up when output circuit is active) IP20 PA 66-FR V0 12.5 / 99 / 114.5 mm 0.2 ... 2.5 mm ² / 0.2 ... 2.5 mm ² / 24 - 14 0.2 ... 1.5 mm ² / 0.2 ... 1.5 mm ² / 24 - 16 | |
| 25.1 V 87 mA 550 mW 253 V AC (125 V DC) | |
| CE-compliant, additionally EN 61326 Ex II (1) G [Ex ia Ga] IIC/IIB/IIA Ex II (1) D [Ex ia Da] IIIC Ex II 3 G Ex nA IIC T4 Gc X [Ex ia Ga] IIC; [Ex ia Da] IIIC; Ex nA IIC T4 Gc X Class I Div 2; IS for Class I, II, III Div 1 SIL 3 | |

| Technical data | |
|--|--|
| 20 V DC ... 30 V DC 10 mA ... 95 mA (75 mA for $U_o = 24$ V DC) | |
| 10.5 V DC (At 48 mA) 48 mA 24 V DC 276 Ω (Internal resistance R_i) Yes 30 ms | |
| < 1.4 W 0.01%/K | |
| 375 V (Peak value in accordance with EN 60079-11) 2.5 kV (50 Hz, 1 min., test voltage) 300 V _{rms} (Rated insulation voltage, surge voltage category II; pollution degree 2, safe isolation as per EN 61010, EN 50178) -20°C ... 60°C (Any mounting position) 10% ... 95% (no condensation) Yellow LED (switching state / status, lights up when output circuit is active) IP20 PA 66-FR V0 12.5 / 99 / 114.5 mm 0.2 ... 2.5 mm ² / 0.2 ... 2.5 mm ² / 24 - 14 0.2 ... 1.5 mm ² / 0.2 ... 1.5 mm ² / 24 - 16 | |
| 27.7 V 101 mA 697 mW 253 V AC (125 V DC) | |
| CE-compliant, additionally EN 61326 Ex II (1) G [Ex ia Ga] IIC/IIB/IIA Ex II (1) D [Ex ia Da] IIIC Ex II 3 G Ex nA IIC T4 Gc X [Ex ia Ga] IIC; [Ex ia Da] IIIC; Ex nA IIC T4 Gc X Class I Div 2; IS for Class I, II, III Div 1 SIL 3 | |

| Technical data | |
|--|--|
| 20 V DC ... 30 V DC 10 mA ... 105 mA (95 mA for $U_o = 24$ V DC) | |
| 12.9 V DC (At 58 mA) 58 mA 21.9 V DC 133 Ω (Internal resistance R_i) Yes 30 ms | |
| < 1.4 W 0.01%/K | |
| 375 V (Peak value in accordance with EN 60079-11) 2.5 kV (50 Hz, 1 min., test voltage) 300 V _{rms} (Rated insulation voltage, surge voltage category II; pollution degree 2, safe isolation as per EN 61010, EN 50178) -20°C ... 60°C (Any mounting position) 10% ... 95% (no condensation) Yellow LED (switching state / status, lights up when output circuit is active) IP20 PA 66-FR V0 12.5 / 99 / 114.5 mm 0.2 ... 2.5 mm ² / 0.2 ... 2.5 mm ² / 24 - 14 0.2 ... 1.5 mm ² / 0.2 ... 1.5 mm ² / 24 - 16 | |
| 25.1 V 188 mA 1.18 W 253 V AC (125 V DC) | |
| CE-compliant, additionally EN 61326 Ex II (1) G [Ex ia Ga] IIB/IIA Ex II (1) D [Ex ia Da] IIIC Ex II 3 G Ex nA IIC T4 Gc X [Ex ia Ga] IIB; [Ex ia Da] IIIC; Ex nA IIC T4 Gc X Class I Div 2; IS for Class I, II, III Div 1 SIL 3 | |

| Ordering data | | |
|-------------------------------|-----------|-------------|
| Type | Order No. | Pcs. / Pkt. |
| MACX MCR-EX-SL-SD-21-40-LP | 2865764 | 1 |
| MACX MCR-EX-SL-SD-21-40-LP-SP | 2924139 | 1 |

| Ordering data | | |
|-------------------------------|-----------|-------------|
| Type | Order No. | Pcs. / Pkt. |
| MACX MCR-EX-SL-SD-24-48-LP | 2865609 | 1 |
| MACX MCR-EX-SL-SD-24-48-LP-SP | 2924126 | 1 |

| Ordering data | | |
|-------------------------------|-----------|-------------|
| Type | Order No. | Pcs. / Pkt. |
| MACX MCR-EX-SL-SD-21-60-LP | 2865515 | 1 |
| MACX MCR-EX-SL-SD-21-60-LP-SP | 2924100 | 1 |



Accessories

Power and error message module

Power and error message module for feeding the 24 V supply voltage to the DIN rail connectors and signaling line faults and power supply failures.

- One-time or redundant supply, decoupled from diode, protected against polarization
- Supply current up to 3.75 A
- Relay output (PDT) and flashing LED for error messages
- Error message in the event of a power supply failure or fuse fault
- Bus cable fault message for MACX MCR-...(2)NAM... devices connected via DIN rail connectors
- Replaceable fuse
- Installation in zone 2 permissible

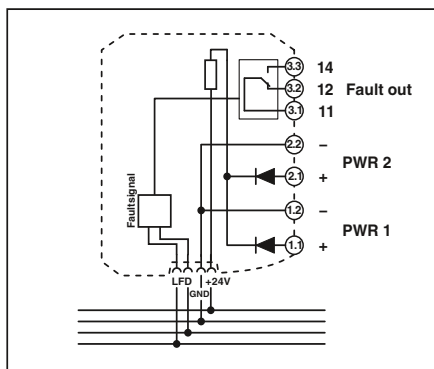

Ex n



Power and error message module

UL, CE, RoHS
 Ex: Ex n IIC T4 Gc X // Applied for: cUL / UL
 Housing width 17.5 mm

Technical data

| | |
|--------------------------------|---|
| Input data | Input signal Redundant supply Polarization and surge protection |
| Output data | Maximum output signal Output voltage |
| Switching output | Contact type Contact material Maximum switching voltage |
| General data | Current consumption Ambient temperature range Humidity Fuse Status indication |
| Housing material | Inflammability class according to UL 94 Dimensions W / H / D Screw connection solid / stranded / AWG Spring-cage connection (solid/stranded/AWG) |
| Conformance / approvals | Conformance ATEX IECEX UL, USA / Canada |

| |
|--|
| 19.2 V DC ... 30 V DC yes, decoupled from diodes Yes |
| 3.75 A (Input voltage - max. 0.8 V at 3.75 A) |
| Relay 1 PDT Gold (Au) 50 V AC (2 A) |
| -20°C ... 60°C (Any mounting position) 5% ... 95% (no condensation) 5 A (replaceable), slow-blow 250 V AC 1 x red LED (error) 2 x green LEDs (PWR1 and PWR2) Polyamide (PA 6.6) V0 17.5 / 99 / 114.5 mm 0.2 ... 2.5 mm ² / 0.2 ... 2.5 mm ² / 24 - 14 0.2 ... 1.5 mm ² / 0.2 ... 1.5 mm ² / 24 - 16 |
| CE-compliant Ex n IIC T4 Gc X Ex nA nC IIC T4 Gc X UL 61010 |

ME 6,2 TBUS... T-Connector

DIN rail connector (5-pos.) for bridging the supply voltage of 12.5 mm wide MACX analog Ex modules.

- Reduces wiring costs
- System can be extended or module replaced even while process is active
- Inter-extendable

| | |
|---|--|
| Description | Supply and error message module , including the relevant DIN rail connector ME 17,5 TBUS 1,5/5-ST-3,81 GN |
| | Screw connection Spring-cage conn. |
| DIN rail connector (TBUS) , for bridging the supply voltage, can be snapped onto 35 mm DIN rails as per EN 60715, with UL approval | |

Ordering data

| Type | Order No. | Pcs. / Pkt. |
|-----------------|-----------|-------------|
| MACX MCR-PTB | 2865625 | 1 |
| MACX MCR-PTB-SP | 2924184 | 1 |

Accessories

| | | |
|--------------------------------|---------|----|
| ME 6,2 TBUS-2 1,5/5-ST-3,81 GN | 2869728 | 10 |
|--------------------------------|---------|----|

Accessories

Marking material for device marking

- For device marking inside the control cabinet and in the field
- Self-adhesive with high adhesive strengths
- Large temperature range



| | | Ordering data | | |
|--|-------|--------------------|-----------|-------------|
| Description | Color | Type | Order No. | Pcs. / Pkt. |
| UniCard, with self-adhesive plastic labels | | | | |
| 10-part, lettering field size: 11 x 9 mm | white | UC-EMLP (11X9) | 0819291 | 10 |
| UniCard, with self-adhesive plastic labels, marked according to customer specifications For ordering details, see Catalog 5 or www.phoenixcontact.net/products | | | | |
| 10-part, lettering field size: 11 x 9 mm | white | UC-EMLP (11X9) CUS | 0824547 | 1 |

Accessories

Resistance circuit

Double-level terminal block with resistance circuit according to NAMUR for line fault detection in the case of mechanical contacts

Important:

- For intrinsically safe circuits, only in combination with D-UKK 3/5 cover



| | | Ordering data | | |
|--|-------|----------------|-----------|-------------|
| Description | Color | Type | Order No. | Pcs. / Pkt. |
| Double-level terminal block, with preassembled resistors | | | | |
| With screw connection | | UKK 5-2R/NAMUR | 2941662 | 50 |
| Cover, width 2.5 mm | | | | |
| | gray | D-UKK 3/5 | 2770024 | 50 |
| | blue | D-UKK 3/5 BU | 2770105 | 50 |

Termination carrier for MACX Analog Ex-isolating amplifiers



Select standard DIN rail device



Select module carrier

TC... termination carriers are compact solutions for quickly and smoothly connecting DIN rail devices from the MACX Analog Ex series to input/output cards of automation systems using system cables.

The termination carriers combine the advantages of modular DIN rail devices with those offered by plug and play rapid cabling solutions to provide a consistent solution for system technology.

Compact

- Saves up to 30% of space due to compact design

Robust and reliable

- Stable, vibration-resistant aluminum carrier device profile
- PCB is completely decoupled from modules
- PCB without active components
- Redundant supply and monitoring in separate DIN rail module

Easy maintenance

- Use of standard DIN rail devices
- Easy access to connection points
- Quick and safe module connection with plug-in and coded cable sets

Flexible

- Horizontal or vertical DIN rail mounting
- Profile section without pitch markings for I/O cards with specific number of channels
- Can be specifically adapted for I/O cards of various automation systems with different system plug types



Select controller-specific front adapter and system cable



Solutions are also available for MINI Analog, MACX Analog Ex, and Safety

Termination carrier for MACX Analog Ex-isolating amplifiers

The **TC-D37SUB-ADIO16-EX-P-UNI** universal termination carrier is a compact solution which connects isolating amplifiers from the MACX Analog Ex series to analog or binary input/output cards of automation systems.

The **TC-D37SUB-AIO16-EX-PS-UNI** termination carrier design, when combined with the MACX MCR-S-MUX HART multiplexer, also enables communication between HART-capable field devices and a management system.

- Connection of up to 16 single-channel (Ex i)-isolating amplifiers
- Universal 1:1 signal routing to a 37-pos. D-SUB plug-in connector
- For system cables with D-SUB socket and open ends for universal connection
- Redundant supply and monitoring in separate DIN rail module

Notes:
Contact us: specific termination carrier designs for I/O modules of various automation systems are available, planned or can be implemented according to your specifications.
1) EMC: Class A product, see page 571



Housing width 244 mm

Technical data

General data
Connection to the control system level
Number of positions
Maximum operating voltage
Maximum permissible current
Rated insulation voltage
Surge voltage category
Pollution degree
Rated surge voltage
Air and creepage distances
Degree of protection
Ambient temperature range

D-SUB pin strip
37
< 50 V DC (Per signal/channel)
1 A (Signal/channel)
50 V
II
2
0.5 kV
DIN EN 50178 (Basic insulation)
IP20
-40°C ... 80°C (Please observe module specifications)

Shock
Vibration (operation)
Inflammability class according to UL 94
Dimensions W / H / D

15g, according to IEC 60068-2-27
2g, according to IEC 60068-2-6
V0
244 / 170 / 160 mm

Power supply via power module

Input voltage range
Redundant supply
Polarization and surge protection
Fuse
Status indication

19.2 V DC ... 30 V DC
yes, decoupled from diodes
Yes
5 A Slow-blow (can be exchanged)
1 x red LED (error)
2 x green LEDs (PWR1 and PWR2)
1 PDT
Au
50 V DC (0.3 A) / 30 V DC (2 A) / 33 V AC (2 A)

Switching output
Contact material
Maximum switching voltage

Ordering data

Description
Universal termination carrier for 16 MACX MCR-EX isolators

| Type | Order No. | Pcs. / Pkt. |
|---|-----------|-------------|
| TC-D37SUB-ADIO16-EX-P-UNI | 2924854 | 1 |
| TC-D37SUB-AIO16-EX-PS-UNI ¹⁾ | 2902932 | 1 |

- With connection for MACX MCR-S-MUX HART multiplexer

Accessories

Supply and error message module

| | | |
|-----------------|---------|---|
| MACX MCR-PTB | 2865625 | 1 |
| MACX MCR-PTB-SP | 2924184 | 1 |
| MACX MCR-S-MUX | 2865599 | 1 |

HART multiplexer, 32-channel

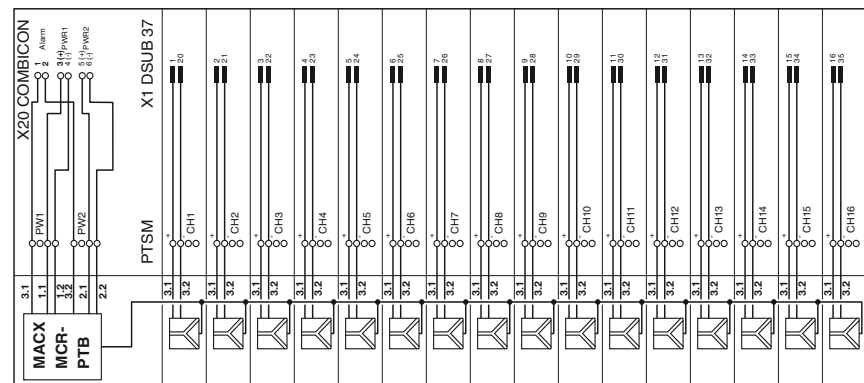

TC-D37SUB-ADIO16-EX-P-UNI and TC-D37SUB-AIO16-EX-PS-UNI connection scheme

Multiplexers for HART signals

Multiplexers for HART signals

Multiplexer for digital connection of HART-capable field devices (such as measuring transducers or control valves) to a PC or management system.

- Supports online configuration and diagnostics for the connected HART-capable field devices
- Constant documentation of process variables and states
- 32 HART channels per multiplexer
- Up to 128 HART multiplexers at one PC interface
- Communication via software tool (e.g., HART OPC Server) using RS-485 interface
- Electrical isolation between auxiliary energy, RS-485 bus and the HART channels
- HART field devices are accessed at the same time that the measurement signal is transmitted without affecting measured value processing
- HART field devices connected via universal HART connection boards; direct connection if processing non-Ex signals, with separate Ex i signal isolator connected upstream if processing Ex signals
- Power supplied via HART connection board

Notes:
1) EMC: Class A product, see page 571

| | |
|---|---|
| Field devices interface (HART) | |
| Channels | 16 or 32; adjustable using a switch |
| Connection method | Flat-ribbon cable, 14-pos. (inclusive) |
| Signal | HART FSK |
| HART specification | HART Field Communication Protocol Rev. 6.0 (downward compatible up to Rev 4.0); FSK Physical Layer Specification (Rev. 8.1) |
| Data transmission display | |
| Display error | Two yellow "Tx" and "Rx" "HART" LEDs Red "ERR" LED (flashes in case of an error in the HART bus) |
| RS-485 interface | |
| Connection method | D-SUB-9 socket |
| Signal | RS-485 |
| Data flow control/protocols | Compatible with OPC HART server, PDM, PRM, and FDT/DTM |
| Number of HART multiplexers per bus segment | |
| Address setting | Max. 31 |
| Data rate | 0...127; using a rotary switch at the front 9600 / 19200 / 38400 / 57600 [bps]; via rotary switch at the front |
| Transmission length | |
| Display | ≤ 1200 m Two yellow "Tx" and "Rx" "RS-485" LEDs |
| General data | |
| Supply voltage range | 18 V ... 31.2 V |
| Nominal supply voltage | 24 V DC |
| Current consumption | 55 mA |
| Power consumption | 1.35 W |
| Operating voltage display | Green "PWR" LED |
| Undervoltage monitoring | Yes (no faulty devices / output states) |
| Galvanic isolation of HART signal/RS-485 | |
| Galvanic isolation of HART signals between each other | 350 V AC |
| Galvanic isolation of HART signal/supply | 100 V DC (Capacitive) |
| Galvanic isolation of RS-485/supply | 350 V AC |
| Error monitoring | 350 V AC Processor error: The "PWR" LED flashes; error in the HART communication: the "ERR" LED flashes |
| Ambient temperature range | |
| Humidity | -20°C ... 60°C |
| Dimensions W / H / D | ≤ 95% (no condensation) |
| Conformance / approvals | 35.2 / 99 / 114.5 mm |
| Conformance | CE-compliant |

| Description |
|---|
| HART multiplexer , 32-channel including two 14-wire flat-ribbon cables |
| Universal termination carrier for 16 MACX MCR-EX isolators - With connection for MACX MCR-S-MUX HART multiplexer |
| Universal termination carrier for 16 MINI MCR isolators - With connection for MACX MCR-S-MUX HART multiplexer |
| HART connection board Interface converter , for conversion from RS-232 (V.24) to RS-485, with electrical isolation, rail-mountable, changeover of data direction self-controlling or through RTS/CTS |
| Repeater , for electrical isolation and increased range |

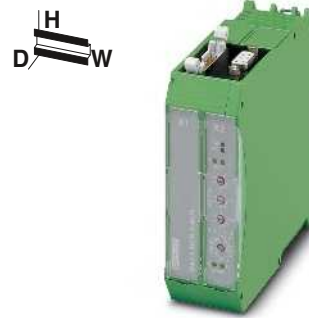

Housing width 35.2 mm

| Technical data | | |
|---|--|--|
| 16 or 32; adjustable using a switch | | |
| Flat-ribbon cable, 14-pos. (inclusive) | | |
| HART FSK | | |
| HART Field Communication Protocol Rev. 6.0 (downward compatible up to Rev 4.0); FSK Physical Layer Specification (Rev. 8.1) | | |
| Two yellow "Tx" and "Rx" "HART" LEDs | | |
| Red "ERR" LED (flashes in case of an error in the HART bus) | | |
| D-SUB-9 socket | | |
| RS-485 | | |
| Compatible with OPC HART server, PDM, PRM, and FDT/DTM | | |
| Max. 31 | | |
| 0...127; using a rotary switch at the front | | |
| 9600 / 19200 / 38400 / 57600 [bps]; via rotary switch at the front | | |
| ≤ 1200 m | | |
| Two yellow "Tx" and "Rx" "RS-485" LEDs | | |
| 18 V ... 31.2 V | | |
| 24 V DC | | |
| 55 mA | | |
| 1.35 W | | |
| Green "PWR" LED | | |
| Yes (no faulty devices / output states) | | |
| 350 V AC | | |
| 100 V DC (Capacitive) | | |
| 350 V AC | | |
| 350 V AC | | |
| Processor error: The "PWR" LED flashes; error in the HART communication: the "ERR" LED flashes | | |
| -20°C ... 60°C | | |
| ≤ 95% (no condensation) | | |
| 35.2 / 99 / 114.5 mm | | |
| CE-compliant | | |

| Ordering data | | |
|----------------|-----------|-------------|
| Type | Order No. | Pcs. / Pkt. |
| MACX MCR-S-MUX | 2865599 | 1 |

| Accessories | | |
|---|-----------|-------------|
| Type | Order No. | Pcs. / Pkt. |
| TC-D37SUB-AIO16-EX-PS-UNI ¹⁾ | 2902932 | 1 |
| TC-D37SUB-AIO16-M-PS-UNI ¹⁾ | 2902934 | 1 |
| MACX MCR-S-MUX-TB | 2308124 | 1 |
| PSM-ME-RS232/RS485-P ¹⁾ | 2744416 | 1 |
| PSM-ME-RS485/RS485-P ¹⁾ | 2744429 | 1 |

Programmable loop-powered temperature measuring transducer, Ex i

- 1-channel
- Loop-powered
- Input for resistance thermometers, thermocouples, and linear mV signals, Ex ia IIC
- Output 4...20 mA/20...4 mA
- Can be installed in zone 1
- Galvanic 2-way isolation
- HART-capable (MCR-FL-TS-LP-I-EX)
- Configuration using software

| |
|---|
| Notes: |
| The devices are supplied with the standard configuration: Pt 100 sensor, measuring range 0 ... 100°C, 3-cond. connection. |
| To configure the MCR-FL-TS-LPI-EX HART-capable device (2864587), you need a HART modem. |
| To configure the MCR-FL-T-LP-EX device (2864574), you need the MCR-PAC-T-USB programming adapter and the MCR/PI-CONF-WIN software, see page 190 |

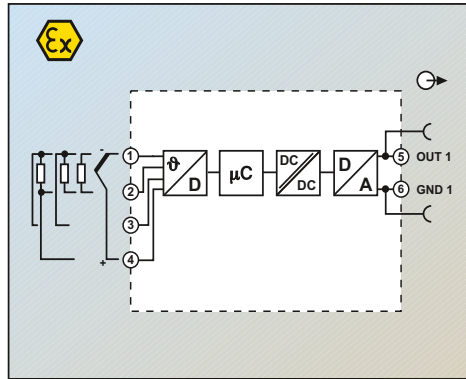

Block diagram MCR-FL-TS-LP-I-EX



Loop-powered, programmable

Ex: Ex i, Ex ia
Housing width 12.5 mm

Technical data

| | | |
|--|--|---|
| Measuring input | Resistance thermometers Thermocouple sensors | |
| Resistor | | 10 Ω ... 400 Ω (min. measurement range 10 Ω) 10 Ω ... 2000 Ω (min. measurement range 100 Ω) -10 mV ... 100 mV (min. measurement range 5 mV) Yes, programmable |
| Voltage | | |
| Configuration | | |
| Measuring output | | |
| Output signal range | | 4 mA ... 20 mA / 20 mA ... 4 mA |
| Maximum output signal | | ≤ 23 mA |
| Load | | ≤ 520 Ω (At U _V = 24 V; U _{supply} - 12 V / 0.023 A) |
| Line monitoring | | NE 43 |
| Short-circuit current | | ≤ 3.6 mA or ≥ 21 mA (adjustable, not for thermocouples) |
| Output current with open circuit | | ≤ 3.6 mA or ≥ 21 mA (adjustable) |
| Output current, measuring range overrange/underrange | | 3.8 mA ... 20.5 mA |
| General data | | |
| Supply voltage range | | 12 V DC ... 30 V DC |
| Current consumption | | < 3.5 mA |
| Step response (10 - 90%) | | < 2 s |
| Transmission error | Resistance thermometers Thermocouple sensors Resistance-type sensors Voltage sensor | 0.2 K (Pt 100, Ni 100), 0.5 K (Pt 500, Ni 500), 0.3 K (Pt 1000, Ni 1000) Type 0.5 K (K, J, T, E, L, U), 1.0 K (N, C, D), 2.0 K (S, B, R) ±0.1 Ω (10...400 Ω), ±1.5 Ω (10...2000 Ω) ±20 µV (-10...100 mV) 2 kV AC (50 Hz, 1 min.) 4 s NAMUR recommendation NE 21 |
| Test voltage input/output | | Polyamide PA non-reinforced V0 |
| Switch on delay time | | 12.5 / 99 / 114.5 mm |
| Standards/regulations | | Plug-in screw connection |
| Housing material | | 0.2 ... 2.5 mm ² / 0.2 ... 2.5 mm ² / 24 - 14 |
| Inflammability class according to UL 94 | | |
| Dimensions W / H / D | | |
| Connection method | | |
| Screw connection solid / stranded / AWG | | |
| Safety data as per ATEX | | |
| Maximum voltage U_i | | MCR-FL-TS-LP-I-EX MCR-FL-T-LP-I-EX |
| Maximum current I_i | | 30 V 30 V |
| Maximum power P_i | | 100 mA 100 mA |
| Maximum voltage U_o | | 750 mW 750 mW |
| Maximum current I_o | | 5 V DC 4.4 V DC |
| Maximum power P_o | | 5.9 mA 9.6 mA |
| Gas group | | 7.2 mW 10.6 mW |
| - max. external inductivity L_o | [mH] | II A II B II C II A II B II C |
| - max. external capacity C_o | [µF] | 100 100 100 100 100 100 |
| Maximum ambient temperature | | 10 10 2 12 12 2.4 |
| | | T4 = 85°C, T5 = 70°C, T6 = 55°C T4 = 85°C, T5 = 65°C, T6 = 50°C |
| Conformance / approvals | | |
| Conformance | | CE-compliant |
| ATEX | | Ex i, Ex ia IIC T6 |
| UL, USA / Canada | | CE-compliant |
| Functional safety (SIL) | | Ex i IIC T4...T6 |
| | | cULus |
| | | SIL 2 according to EN 61508 |
| | | |
| Description | | |
| MCR temperature transducer , for resistance thermometers, thermocouples, resistance-type sensors, and voltage sensors | | |
| HART-compatible | | |

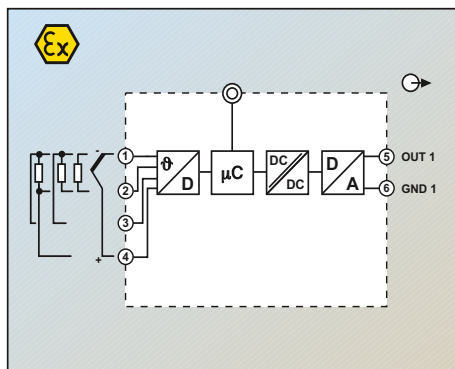

Block diagram MCR-FL-T-LP-I-EX

Ordering data

| Type | Order No. | Pcs. / Pkt. |
|-------------------|-----------|-------------|
| MCR-FL-TS-LP-I-EX | 2864587 | 1 |
| MCR-FL-T-LP-I-EX | 2864574 | 1 |

Ex i 2-conductor field devices

Programmable loop-powered temperature measuring transducers with connection heads, Ex i

- 1-channel
- Loop-powered
- Input for resistance thermometers, thermocouples, and linear mV signals, Ex ia IIC
- Output 4...20 mA/20...4 mA
- Can be installed in zone 0
- Galvanic 2-way isolation
- HART-compatible

Notes:
 The devices are supplied with the standard configuration: Pt 100 sensor, measuring range 0 ... 100°C, 3-conductor connection.
 To configure the MCR-FL-TS-LPI-EX HART-capable device, you need a HART modem.

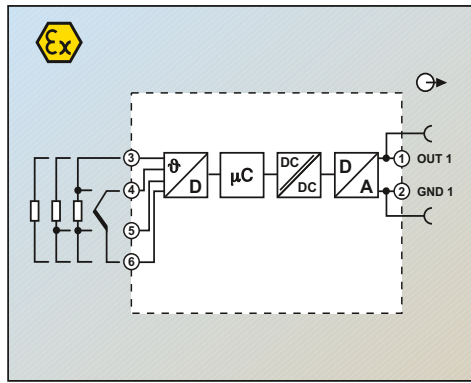

Block diagram MCR-FL-HT-TS-I-EX



Loop-powered, programmable

PC
 Ex: Ex i U₁₁

Measuring input
 Resistance thermometers
 Thermocouple sensors

Resistor

Voltage
 Configuration

Measuring output
 Output signal range
 Maximum output signal
 Load
 Line monitoring
 Short-circuit current

Output current with open circuit
 Output current, measuring range overrange/underrange

General data
 Supply voltage range
 Current consumption
 Step response (10 - 90%)
 Transmission error

Test voltage input/output
 Switch on delay time
 Degree of protection
 Mounting position
 Connection
 Standards/regulations
 Housing material
 Inflammability class according to UL 94
 Screw connection solid / stranded / AWG

Safety data as per ATEX
 Maximum voltage U_i
 Maximum current I_i
 Maximum power P_i
 Maximum voltage U_o
 Maximum current I_o
 Maximum power P_o
 Gas group
 - max. external inductivity L_o [mH]
 - max. external capacity C_o [µF]
 Maximum ambient temperature

Technical data

Pt, Ni (100, 500, 1000); min. measurement range 10 K
 B, C, D, E, J, K, L, N, R, S, T, U; min. measurement range 50 K/500 K

10 Ω ... 400 Ω (min. measurement range 10 Ω)
 10 Ω ... 2000 Ω (min. measurement range 100 Ω)
 -10 mV ... 75 mV (min. measurement range 5 mV)
 Yes, programmable

4 mA ... 20 mA / 20 mA ... 4 mA
 ≤ 23 mA
 ≤ 630 Ω (At $U_V = 24$ V; $U_{supply} - 10$ V / 0.023 A)
 NE 43
 ≤ 3.6 mA or ≥ 21 mA (adjustable, not for thermocouples)

≤ 3.6 mA or ≥ 21 mA (adjustable)
 3.8 mA ... 20.5 mA (linear increase/decrease)

12 V DC ... 30 V DC
 < 3.5 mA
 < 2 s

Resistance thermometers
 Thermocouple sensors
 Resistance-type sensors
 Voltage sensor

0.2 K (Pt 100, Ni 100), 0.5 K (Pt 500, Ni 500), 0.3 K (Pt 1000, Ni 1000)
 Type 0.5 K (K, J, T, E, L, U), 1.0 K (N, C, D), 2.0 K (S, B, R)
 ±0.1 Ω (10...400 Ω), ±1.5 Ω (10...2000 Ω)
 ±20 µV (-10...75 mV)
 2 kV AC (50 Hz, 1 min.)
 6 s
 IP00, IP66 (integrated in the connecting head)
 Connecting head according to DIN 43729 form B
 Installation in connection head according to DIN 43729 form B
 NAMUR recommendation NE 21
 Polycarbonate, PC
 V0
 0.2 ... 1.75 mm² / 0.2 ... 1.75 mm² / 24 - 15

Conformance / approvals
 Conformance
 ATEX
 UL, USA / Canada
 Functional safety (SIL)

CE-compliant
 Ex i I I G and II 2 G Ex ia IIC T6/T5/T4
 cULus
 SIL 2 according to EN 61508

Ordering data

Description
MCR temperature measuring transducer, smart, for resistance thermometers, thermocouples, resistance-type sensors, and voltage sensors

| Type | Order No. | Pcs. / Pkt. |
|-------------------|-----------|-------------|
| MCR-FL-HT-TS-I-EX | 2864545 | 1 |

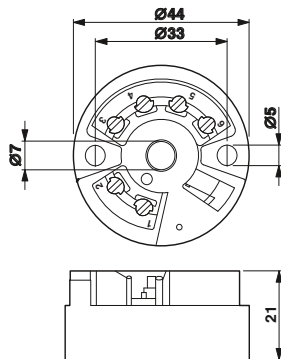

Programmable loop-powered temperature measuring transducers with connection heads, Ex i

- 1-channel
- Loop-powered
- Input for resistance thermometers, thermocouples, and linear mV signals, Ex ia IIC
- Output 4...20 mA/20...4 mA
- Can be installed in zone 0
- Galvanic 2-way isolation
- Configuration using software

Notes:
 The devices are supplied with the standard configuration: Pt 100 sensor, measuring range 0 ... 100°C, 3-cond. connection.
 You can implement your own measuring range settings, linearization, and characteristic curve adjustments. For this purpose, you need the MCR-PAC-T-USB programming adapter and the MCR/PI-CONF-WIN configuration software, see page 190



Block diagram MCR-FL-HT-T-I-EX



Loop-powered, programmable



Measuring input
 Resistance thermometers
 Thermocouple sensors

Resistor

Voltage
 Configuration

Measuring output
 Output signal range
 Maximum output signal
 Load
 Line monitoring
 Short-circuit current

Output current with open circuit
 Output current, measuring range overrange/underrange

General data
 Supply voltage range
 Current consumption
 Step response (10 - 90%)
 Transmission error

Resistance thermometers
 Thermocouple sensors
 Resistance-type sensors
 Voltage sensor

Test voltage input/output
 Switch on delay time
 Degree of protection
 Mounting position
 Connection
 Standards/regulations
 Housing material
 Inflammability class according to UL 94
 Screw connection solid / stranded / AWG

Safety data as per ATEX
 Maximum voltage U_i
 Maximum current I_i
 Maximum power P_i
 Maximum voltage U_o
 Maximum current I_o
 Maximum power P_o
 Gas group
 - max. external inductivity L_o [mH]
 - max. external capacity C_o [µF]
 Maximum ambient temperature

Technical data

Pt, Ni (100, 500, 1000); min. measurement range 10 K
 B, C, D, E, J, K, L, N, R, S, T, U; min. measurement range 50 K/500 K

10 Ω ... 400 Ω (min. measurement range 10 Ω)
 10 Ω ... 2000 Ω (min. measurement range 100 Ω)
 -10 mV ... 100 mV (min. measurement range 5 mV)
 Yes, programmable

4 mA ... 20 mA / 20 mA ... 4 mA
 ≤ 25 mA
 ≤ 720 Ω (For $U_v = 24 V$; $U_{supply} = 8 V / 0.025 A$)
 NE 43
 ≤ 3.6 mA or ≥ 21 mA (adjustable, not for thermocouples)

≤ 3.6 mA or ≥ 21 mA (adjustable)
 3.8 mA ... 20.5 mA (linear increase/decrease)

8 V DC ... 30 V DC
 < 3.5 mA
 < 2 s

0.2 K (Pt 100, Ni 100), 0.5 K (Pt 500, Ni 500), 0.3 K (Pt 1000, Ni 1000)
 Type 0.5 K (K, J, T, E, L, U), 1.0 K (N, C, D), 2.0 K (S, B, R)
 ±0.1 Ω (10...400 Ω), ±1.5 Ω (10...2000 Ω)
 ±20 µV (-10...100 mV)
 2 kV AC (50 Hz, 1 min.)

6 s
 IP00, IP66 (integrated in the connecting head)
 Connecting head according to DIN 43729 form B
 Installation in connection head according to DIN 43729 form B
 NAMUR recommendation NE 21
 Polycarbonate, PC
 V0
 0.2 ... 1.75 mm² / 0.2 ... 1.75 mm² / 24 - 15

Conformance / approvals
 Conformance
 ATEX
 UL, USA / Canada

CE-compliant
 Ex i II 1 G Ex ia IIC T6/T5/T4
 cULus

Description
MCR temperature measuring transducer, for resistance thermometers, thermocouples, resistance-type sensors, and voltage sensors

Ordering data

| Type | Order No. | Pcs. / Pkt. |
|------------------|-----------|-------------|
| MCR-FL-HT-T-I-EX | 2864532 | 1 |

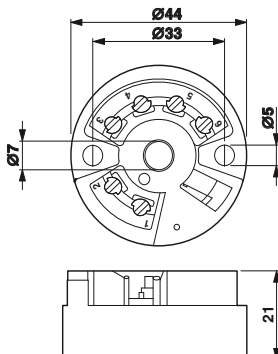

Accessories

Configuration software package

The **MCR/PI-CONF-WIN** configuration software package is used to configure and visualize all parameters for the programmable loop-powered temperature transducers.

- For temperature transducers
MCR-FL-T(S)-LP-I-EX and
MCR-FL-HT-T(S)-I-EX
- Galvanically isolated
- Configuration possible during operation
- Straightforward menu interface
- Rapid programming

The computer and the measuring transducer communicate with one another via a software adapter cable and a serial interface.

Notes:
The software runs under the following operating systems:
Windows NT™, 2000™, and XP™.



| Description |
|--|
| MCR configuration software , for programming MCR-T-..., MCR-...-LP-..., MCR-...-HT-..., MCR-S-..., MCR-F-..., and MCR-PSP-... modules, CD-ROM |

| Ordering data | | |
|-----------------|-----------|-------------|
| Type | Order No. | Pcs. / Pkt. |
| MCR/PI-CONF-WIN | 2814799 | 1 |

Accessories

USB adapter cable

Software adapter cable

For connecting the programmable MCR-/PI modules to the USB interface of a computer, the USB adapter cable **CM-KBL-RS232/USB** can be used together with the relevant adapter cables. Programming with the MCR/PI-CONF-WIN software is possible under the operating systems Windows 98™, Windows 2000™ and Windows XP™.



The following modules are supported:

- MCR-FL-T-LP-I-EX
- MCR-FL-HT-T-I-EX

| Description |
|--|
| USB adapter cable , D-9-SUB to USB, with adapter D-9-SUB to D-25-SUB |
| Software adapter cable , 2.4 m length, with USB connection, for programming MCR-...-LP-... and MCR-...-HT-... modules |

| Ordering data | | |
|------------------|-----------|-------------|
| Type | Order No. | Pcs. / Pkt. |
| CM-KBL-RS232/USB | 2881078 | 1 |
| MCR-PAC-T-USB | 2309000 | 1 |

| Adapter cable, stranded, 9-pos. D-SUB socket on 25-pos. D-SUB pin |
|---|
| Adapter cable , stranded, 9-pos. D-SUB socket on 25-pos. D-SUB pin |

| Accessories | | |
|---------------------|-----------|-------------|
| Type | Order No. | Pcs. / Pkt. |
| PSM-KAD 9 SUB 25/BS | 2761295 | 1 |

Accessories

Shield fast connection

- For connecting cable shielding to cable terminal points
- Can be connected to PLUGTRAB PT
- Easy assembly



| Description | Ordering data | | |
|--|---------------|-----------|-------------|
| | Type | Order No. | Pcs. / Pkt. |
| Shield fast connection For Ø 3-6 mm For Ø 5-10 mm | SSA 3-6 | 2839295 | 10 |
| | SSA 5-10 | 2839512 | 10 |

Accessories

Test plug



| Description | Color | Ordering data | | |
|--|--------|---------------|-----------|-------------|
| | | Type | Order No. | Pcs. / Pkt. |
| Test plug, consisting of: | | | | |
| Metal part for 2.3 mm Ø socket hole and | | MPS-MT | 0201744 | 10 |
| Insulating sleeve, for MPS metal part | | red MPS-IH RD | 0201676 | 10 |
| | white | MPS-IH WH | 0201663 | 10 |
| | blue | MPS-IH BU | 0201689 | 10 |
| | yellow | MPS-IH YE | 0201692 | 10 |
| | green | MPS-IH GN | 0201702 | 10 |
| | gray | MPS-IH GY | 0201728 | 10 |
| | black | MPS-IH BK | 0201731 | 10 |



Monitoring

Energy and power measuring technology

EMpro energy meters measure, analyze, and communicate important electrical system parameters.

PSK DL data logger kits monitor and log operating states.

PSK meters record compressed air consumption.

Current transformers

PACT current transformers convert currents up to 4000 A into secondary currents of 1 and 5 A.

Current and voltage measuring technology

MCR current and voltage transducers convert currents and voltages into standard analog signals.

Solar and PV system monitoring

The SOLARCHECK modular monitoring system is used for string monitoring in photovoltaic systems.

Residual current monitoring

RCM devices provide residual current monitoring in grounded power supply systems. They detect residual currents at an early stage before they result in forced shutdown.

Components for E-Mobility

EV Charge Control is the charging controller used to charge electric vehicles on the AC mains according to IEC 61851-1.

Electronic monitoring relays

EMD monitoring relays detect and indicate deviations in important system parameters at an early stage.

Electronic timer relays

ETD timer relays are used for straightforward time control functions.

Special function modules

EMG special function modules enable simple components such as diodes to be used in an industrial context. These products feature professional housing and connection technology.

Product range overview

| | |
|--|------------|
| Product overview | 194 |
| Energy and power measuring technology | 196 |
| EMpro energy meters | 200 |
| Extension modules | 202 |
| Complete packages for data logging | 206 |
| Compressed air meters | 208 |
| Current transformers | 210 |
| Selection guide | 212 |
| PACT current transformers | 213 |
| Accessories | 223 |
| Current and voltage measuring technology | 226 |
| Current transducers | 229 |
| Voltage transducers | 236 |
| Accessories | 237 |
| Solar and PV system monitoring | 238 |
| SOLARCHECK PV string monitoring | 240 |
| Residual current monitoring | 242 |
| Residual current monitoring - RCM | 244 |
| Components for E-Mobility | 246 |
| EV Charge Control charging controller | 247 |
| Monitoring relays, timer relays, special function modules | 248 |
| EMD electronic monitoring relays | 250 |
| ETD electronic timer relays | 258 |
| EMG special function modules | 262 |

Monitoring

Product overview

Energy and power measuring technology



EMpro energy meters for front-panel installation Page 200



EMpro energy meters for DIN rail mounting Page 201



Special function and communication modules Page 202



DIN rail adapters Page 205



PACT winding current transformers Page 222



Mounting accessories, shock protection Page 223



MCR current transducers for AC/DC and distorted currents up to 600 A Page 229



MCR current transducers for AC/DC and distorted currents up to 55 A, programmable Page 230

Current and voltage measuring technology



Accessories Configuration software and USB adapter cable Page 149



SOLARCHECK PV string monitoring Communication module Page 240



SOLARCHECK PV string monitoring Current measuring modules Page 241



SOLARCHECK PV string monitoring Voltage measuring modules Page 241

Solar and PV system monitoring

Monitoring relays



EMD-BL Compact monitoring relays Page 250



EMD Multifunctional monitoring relays Page 252

Timer relays



ETD-BL Ultra-narrow timer relays Page 258



ETD Multifunctional timer relays Page 260



Complete packages for data logging
Page 206



Compressed air meters
Page 208

Current transformers



PACT bus-bar current transformers
Page 212
Can be calibrated
Page 224



PACT plug-in current transformers
Page 214
Can be calibrated
Page 224



MCR current transducers for AC currents, sinusoidal up to 12 A
Page 232
Passive, up to 5 A
Page 234



MCR current transducers for AC currents, sinusoidal and distorted, up to 200 A
Page 233



MCR current protectors for AC currents, sinusoidal up to 16 A
Page 235



MCR voltage transducers for DC voltages up to 660 V
Page 236
For AC voltages up to 444 V
Page 236

Residual current monitoring



RCM type B+ for DC residual currents and pulsating DC and AC residual currents
Page 244



RCM type A for pulsating DC and AC residual currents
Page 245

Components for E-Mobility



EV Charge Control Charging controller
Page 247



EV Charge Lock Release Mains failure plug release
Page 247

Special function modules



EMG Diode modules, lamp testing modules, display modules
Page 262

Lightning current measuring system



Lightning current measuring system
See Catalog 6

HMI



HMI
See Catalog 8

Signal towers



Signal towers
See Catalog 8



Energy costs at a glance

Within industry, energy is viewed as a variable cost factor. As a result, lower energy costs are becoming increasingly important in terms of providing companies with a major competitive advantage in the areas of production, process, and industrial engineering.

Alongside energy consumption, the quality of the energy supplied, the reliability of supply, and effective system utilization also play an important role in ensuring profitability. This calls for continuous measurement and analysis of all sources of energy.

Advantages of energy data acquisition

Continuously recorded energy flow provides the basis for a target-oriented energy management system.

Access comprehensive information regarding the characteristic electrical data of your machinery and benefit from the advantages of this:

- Reduce your energy costs by identifying potential energy savings.
- Optimize your system capacity: through intelligent switching of system parts, uniform network load, and reduced harmonics.
- Reduce peak loads using forward-looking trend calculation and load management.
- Safeguard your production processes and minimize downtimes by continuously monitoring important system parameters.

Measurement – monitoring – communication

Efficient energy management – network-capable EMpro energy meters can be used to acquire and monitor the characteristic electrical data of your machines and systems.

They can be freely extended with communication modules and special function modules, enabling your energy meters to keep pace with your growing requirements. Future-proof planning and investment is therefore ensured.



The communication expert

The EMpro MA600 is capable of performing all measurement tasks associated with power supply applications up to 700 V AC – from straightforward current and power measurement and detection of harmonics to spectral analysis and trend calculation.

- Flexible network connection
- Can be extended with plug-in communication modules and special function modules
- Remote access via web server



The universal solution on the front panel

The EMpro MA400 is capable of all standard measurement tasks in the main distribution up to 500 V AC.

- Plug-in RS-485 extension module for integration in JBUS and MODBUS systems



The compact starter for use in the sub-distribution

The EMpro MA200 energy meter is ideal for simple measurement tasks where on-site analysis of the measured values is sufficient.

The highly communicative device for use on DIN rails

The EMpro MA250 performs simple measuring tasks in small control cabinets directly on the machine.

- With built-in RS-485 interface for integration in JBUS and MODBUS systems



Data logger kits

PSK DL data logger kits monitor the operating state of your plant and inform you of any change in state by SMS.

The complete package is available in two versions:

- PSK DL BASIC with all basic functions
- PSK DL FLEX allows programming directly in SQL and supports modular expansion. Sends e-mails via GPRS or DSL.



Sensors and meters

Use of resources at a glance - determine all relevant states using sensors and meters.

- Detailed procurement measurement, thanks to precise sensor and meter technology
- Intelligent sensor communication, thanks to IO-Link technology



Inline power measurement terminal

The Inline power measurement terminal enables analysis of AC networks.

- For measuring current, voltage, and power, as well as identifying distortion and harmonics

The power measurement terminal can be found in Catalog 8, control technology, I/O systems, and network structure.

Monitoring

Energy and power measuring technology

Energy meters

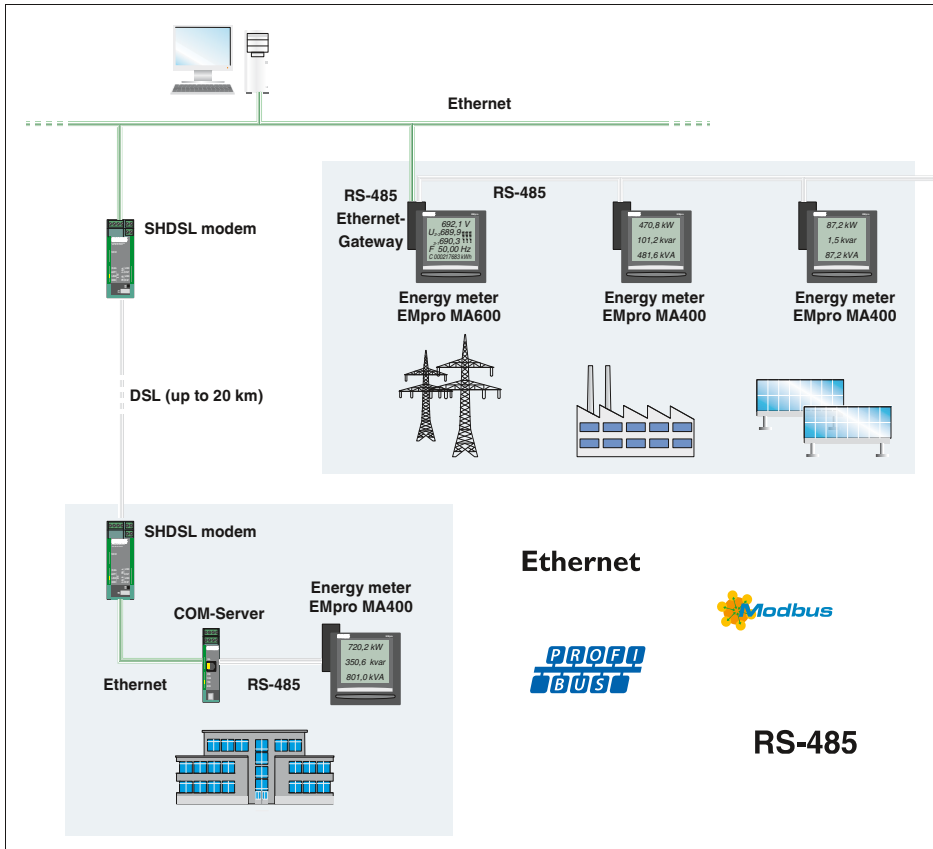

Measurement – monitoring – communication

In order to achieve efficient energy management, all energy data that has been determined is acquired and analyzed centrally in the control center.

For data transmission, integrate the EMpro measuring devices flexibly into your network structures.

The network components from Phoenix Contact offer interference-free and high-performance communication of energy data, even in harsh industrial environments:

- Copper-based and fiber optic data transmission
- Ethernet and modem communication
- Industrial wireless transmission



Direct access to measured values

Analyze your system parameters quickly on site. At the touch of a button, you can access precisely those measured values that are of relevance.

You can also use the user-friendly web server function to request measured values directly from the control center.



Planning reliability and investment security

EMpro extension modules, special function modules, and communication modules enable you to remain flexible and extend your EMpro measuring devices at any time:

- Digital inputs and outputs
- Pulse outputs
- Analog outputs
- Communication interfaces
- Measured data memory
- Temperature measurement



Remote access to multiple meters - with just one IP address

The web server that has been integrated into the Ethernet communication modules allows you to conveniently configure key parameters online. It also allows remote access to key electrical characteristics such as current, voltage, power, energy, and harmonics.

You can easily select the right device for your application by referring to the table below:

| Product type | The compact starter EEM-MA200 | The highly communicative device for use on DIN rails EEM-MA250 with RS-485 | The universal solution on the front panel EEM-MA400 | The communication expert EEM-MA600 EEM-MA600-24DC |
|---|----------------------------------|---|---|---|
| Mounting | | | | |
| DIN rail | • | • | | |
| Front panel | | | • | • |
| Measurement | | | | |
| Currents | | | | |
| I1, I2, I3, Σ3 | • | • | | • |
| I1, I2, I3, IN (calculation) | | | • | • |
| Maximum values | • | • | • | • |
| Average values | | | • | • |
| Supports current measurement without an external transformer | | | | • |
| Voltages | | | | |
| U12, U23, U31, V1, V2, V3 | • | • | • | • |
| Maximum values | | | | • |
| Average values | | | | • |
| Voltage measurement via voltage transducer | | | | • |
| Voltage measurement, direct, up to 500 V | • | • | • | • |
| Voltage measurement, direct, up to 700 V | | | | • |
| Frequency | • | • | • | • |
| Power | | | | |
| ΣP, ΣQ, ΣS (±) | • | • | • | • |
| P, Q, S per phase (±) | | | • | • |
| Maximum values P, Q, S | • | • | • | • |
| Average values P, Q, S | | | • | • |
| Trend power | | | | • |
| Power factor | | | | |
| ΣPF | • | • | • | • |
| PF per phase | | | • | • |
| THD (Total Harmonic Distortion) | | | | |
| I1, I2, I3, U12, U23, U31, V1, V2, V3 | Up to 51st harmonic | Up to 51st harmonic | Up to 51st harmonic | Up to 63rd harmonic |
| Temperature | | | | |
| Temperature measurement (internal) | • | • | | |
| Metering | | | | |
| Active and reactive energy (kWh+, kvarh+) | • | • | • | • |
| Active and reactive energy (kWh±, kvarh±) | | | | • |
| Two-tariff meter | • | • | | |
| Operating hours | • | • | • | • |
| Analysis | | | | |
| Harmonics analysis | | | | Up to 63rd harmonic |
| Outputs | | | | |
| One configurable pulse output (kWh+, kvarh+) or alarm (threshold value) | • | • | | |
| Inputs | | | | |
| One configurable input for tariff switch-over | • | • | | |
| Special function modules (optional) | | | | |
| Memory | | | | |
| Two digital I/Os | | | | • |
| One pulse output or one threshold value | | | • | |
| Two pulse outputs | | | | • |
| Two analog outputs | | | | • |
| Temperature measurement | | | | • |
| Communication modules (optional) | | | | |
| JBUS/Modbus RTU (RS-485) | | | • | • |
| PROFIBUS DP | | | | • |
| PROFIBUS (D-SUB) | | | | • |
| Ethernet | | | | • |
| RS-485/Ethernet gateway | | | | • |

Key

| | |
|---------------|---------------------------|
| I1, I2, I3 | Conductor currents |
| IN | Neutral conductor current |
| U12, U23, U31 | Phase conductor voltages |
| V1, V2, V3 | Conductor voltages to N |

| | |
|-----|---------------------------|
| P | Real power |
| Q | Reactive power |
| S | Apparent power |
| PF | Power factor |
| THD | Total harmonic distortion |

Energy meters

EMpro energy meters are capable of acquiring, monitoring, and displaying all electrical system and machine parameters locally.

EEM-MA600

- Can be extended with special function and communication modules
- Remote access via web server, integrated into Ethernet communication module
- Acquisition of individual harmonic components up to 63rd order
- Trend calculation for active and reactive power

EEM-MA400

- Can be extended with a pulse module
- Can be extended with RS-485 communication module (JBUS/MODBUS)
- Acquisition of total harmonic content up to harmonic of 51st order

EEM-MA250

- Two-tariff measurement via pulse input
- Pulse output
- RS-485 interface (JBUS/MODBUS)

EEM-MA200

- Two-tariff measurement via pulse input
- Pulse output

Notes:

1) EMC: Class A product, see page 571

| | |
|---|--|
| Input data | |
| Measuring principle | |
| Acquisition of harmonics | |
| Measured value | |
| Voltage measuring input V1, V2, V3 | |
| Input voltage range | |
| Accuracy | |
| Current measuring input I1, I2, I3 | |
| Input current range (Via external transformers) | |
| Overload capacity | |
| Operate threshold | |
| Accuracy | |
| Power measurement | |
| Measuring range | |
| Accuracy | |
| Active energy (IEC 62053-22) | |
| Reactive power (IEC 62053-23) | |
| Digital input | |
| Voltage input signal | |
| Switching output | |
| Output description | |
| Maximum switching voltage | |
| Current carrying capacity | |
| Serial port | |
| Output description | |
| Serial transmission speed | |
| Display | |
| Type | |
| Measuring rate | |
| General data | |
| Supply voltage | |
| Nominal power consumption | |
| Degree of protection | |
| Ambient temperature range | |
| Dimensions W / H / D | |
| Dimensions W / H / D With extension module | |
| Connection cross section (solid / stranded / AWG) | |
| Voltage and other connections | |
| Current connection | |
| Conformance / approvals | |
| Conformance | |
| UL, USA / Canada | |

| | |
|---|--|
| Description | |
| Energy meter , for installation in front panel | |
| Energy meter , for front-panel installation, 24 V DC | |
| Energy meter , for mounting on a DIN rail | |



Measuring voltage of up to 700 V AC, extendable



Housing width 96 mm

| Technical data | |
|---|--|
| True r.m.s. value measurement up to 63rd harmonic AC sine (50/60 Hz) | |
| 18 V AC ... 700 V AC (Phase/Phase) 11 V AC ... 404 V AC (Phase/neutral conductor) 500 kV AC (Primary, via external voltage transducers) (Secondary, 60, 100, 110, 115, 120, 173, 190 V AC) | |
| 0.2% | |
| 9999 A (primary) (1 A and 5 A, secondary) 6 A (Permanent) 10 mA | |
| 0.2% | |
| 0 MW ... 8000 MW / 0 Mvar ... 8000 Mvar / 0 MVA ... 8000 MVA | |
| 0.5% | |
| Class 0.5S | |
| Class 2 | |
| (Via extension module) | |
| Via extension module | |
| - | |
| Via extension module | |
| - | |
| LCD display, backlighting approximately | |
| 10 VA 20 VA (With maximum number of extension modules) IP52 (front), IP30 (back) -10°C ... 55°C (14°F to 131°F) 96 / 96 / 82 mm 96 / 96 / 80 mm | |
| 0.5 ... 2.5 mm ² / 0.5 ... 2.5 mm ² / 20 - 14 0.5 ... 6 mm ² / 0.5 ... 6 mm ² / 20 - 8 | |
| CE-compliant | |
| UL 61010-1 | |

| Ordering data | | |
|-------------------------|-----------|-------------|
| Type | Order No. | Pcs. / Pkt. |
| EEM-MA600 ¹⁾ | 2901366 | 1 |



Measuring voltage of up to 700 V AC, supply voltage 24 V DC



Measuring voltage of up to 500 V AC, can be extended with RS-485 interface



Measuring voltage of up to 500 V AC, with DIN rail mounting, also with RS-485 interface

Housing width 96 mm

Housing width 96 mm

Housing width 72 mm

| Technical data | |
|---|--|
| True r.m.s. value measurement up to 63rd harmonic AC sine (50/60 Hz) | |
| 18 V AC ... 700 V AC (Phase/Phase) 11 V AC ... 404 V AC (Phase/neutral conductor) 500 kV AC (Primary, via external voltage transducers) (Secondary, 60, 100, 110, 115, 120, 173, 190 V AC) | |
| 0.2% | |
| 9999 A (primary) (1 A and 5 A, secondary) 6 A (Permanent) 10 mA 0.2% | |
| 0 MW ... 8000 MW / 0 Mvar ... 8000 Mvar / 0 MVA ... 8000 MVA | |
| 0.5% Class 0.5S Class 2 | |
| (Via extension module) | |
| Via extension module - - | |
| Via extension module - | |
| LCD display, backlighting approximately | |
| 10 VA 20 VA (With maximum number of extension modules) IP52 (front), IP30 (back) -10°C ... 55°C (14°F to 131°F) 96 / 96 / 82 mm 96 / 96 / 80 mm | |
| 0.5 ... 2.5 mm ² / 0.5 ... 2.5 mm ² / 20 - 14 0.5 ... 6 mm ² / 0.5 ... 6 mm ² / 20 - 8 | |
| CE-compliant - | |

| Technical data | |
|---|--|
| True r.m.s. value measurement up to 51st harmonic AC sine (50/60 Hz) | |
| 50 V AC ... 500 V AC (Phase/Phase) 28 V AC ... 289 V AC (Phase/neutral conductor) - | |
| 0.2% | |
| 9999 A (primary) 5 A (secondary) 6 A (Permanent) 5 mA 0.2% | |
| 0 MW ... 11 MW / 0 Mvar ... 11 Mvar / 0 MVA ... 11 MVA | |
| 0.5% Class 0.5S Class 2 | |
| - | |
| Via extension module - | |
| Via extension module - | |
| LCD display, backlighting approximately | |
| 5 VA 10 VA (With maximum number of extension modules) IP52 (front), IP30 (back) -10°C ... 55°C (14°F to 131°F) 96 / 96 / 82 mm 96 / 96 / 80 mm | |
| 0.5 ... 2.5 mm ² / 0.5 ... 2.5 mm ² / 20 - 14 0.5 ... 6 mm ² / 0.5 ... 6 mm ² / 20 - 8 | |
| CE-compliant UL 61010-1 | |

| Technical data | |
|---|--|
| True r.m.s. value measurement up to 51st harmonic AC sine (50/60 Hz) | |
| 50 V AC ... 519 V AC (Phase/Phase) 28 V AC ... 300 V AC (Phase/neutral conductor) - | |
| 0.2% | |
| 9999 A (primary) 5 A (secondary) 6 A (Permanent) 5 mA 0.2% | |
| 0 kW ... 9999 kW / 0 kvar ... 9999 kvar / 0 kVA ... 9999 kVA | |
| 0.5% Class 0.5S Class 2 | |
| 230 V AC ±10% (Tariff switchover: e.g., day/nighttime tariff) | |
| Transistor output, active 30 V DC 27 mA EEM-MA250 ¹⁾ EEM-MA200 ¹⁾ Modbus RTU/JBUS RS-485 None 2,4 ... 38.4 kbps | |
| LCD display, backlighting approximately | |
| 5 VA IP51 (front), IP20 (back) -10°C ... 55°C (14°F to 131°F) 72 / 90 / 64 mm | |
| 0.5 ... 2.5 mm ² / 0.5 ... 2.5 mm ² / 20 - 14 0.5 ... 4 mm ² / 0.5 ... 4 mm ² / 20 - 10 | |
| CE-compliant UL 61010-1 | |

| Ordering data | | |
|----------------|-----------|-------------|
| Type | Order No. | Pcs. / Pkt. |
| EEM-MA600-24DC | 2902352 | 1 |

| Ordering data | | |
|-------------------------|-----------|-------------|
| Type | Order No. | Pcs. / Pkt. |
| EEM-MA400 ¹⁾ | 2901364 | 1 |

| Ordering data | | |
|-------------------------|-----------|-------------|
| Type | Order No. | Pcs. / Pkt. |
| EEM-MA250 ¹⁾ | 2901363 | 1 |
| EEM-MA200 ¹⁾ | 2901362 | 1 |

Extension modules

Communication modules

EEM-RS485-MA...

– JBUS/Modbus RTU (RS-485)

EEM-PB...-MA600

– PROFIBUS DP, with transmission speeds of 1.5 or 12 Mbps



RS-485



PROFIBUS

Notes:
1) EMC: Class A product, see page 571

| Technical data | |
|---------------------------|--------------------------------|
| Serial port | Modbus RTU/JBUS RS-485 |
| Output description | 2.4 ... 38.4 kbps |
| Serial transmission speed | |
| General data | |
| Supply voltage | 9 V (via EEM-MA400) |
| Degree of protection | IP20 |
| Ambient temperature range | -10°C ... 55°C (14°F to 131°F) |
| Conformance / approvals | |
| Conformance | CE-compliant |
| UL, USA / Canada | UL 61010-1 |

| Ordering data | | |
|-------------------------------|-----------|-------------|
| Type | Order No. | Pcs. / Pkt. |
| EEM-RS485-MA400 ¹⁾ | 2901365 | 1 |
| EEM-RS485-MA600 ¹⁾ | 2901367 | 1 |

| Technical data | |
|----------------------------|--------------------------------|
| EEM-PB-MA600 ¹⁾ | EEM-PB12-MA600 ¹⁾ |
| PROFIBUS DP RS-485 | PROFIBUS DP RS-485 |
| 9.6 kbps ... 1.5 Mbps | 9.6 kbps ... 12 Mbps |
| General data | |
| Supply voltage | 9 V (via EEM-MA600) |
| Degree of protection | IP20 |
| Ambient temperature range | -10°C ... 55°C (14°F to 131°F) |
| Conformance / approvals | |
| Conformance | CE-compliant |
| UL, USA / Canada | UL 61010-1 |

| Ordering data | | |
|------------------------------|-----------|-------------|
| Type | Order No. | Pcs. / Pkt. |
| EEM-PB-MA600 ¹⁾ | 2901368 | 1 |
| EEM-PB12-MA600 ¹⁾ | 2901418 | 1 |

| Description |
|--|
| Communication module (for EEM-MA400) JBUS/Modbus RTU (RS-485) |
| Communication module (for EEM-MA600) JBUS/Modbus RTU (RS-485) PROFIBUS DP (1.5 Mbps) PROFIBUS DP (12 Mbps) |

Communication modules

EEM-ETH-MA600

– Ethernet
– Integrated web server

EEM-ETH-RS485-MA600

– Ethernet/RS-485 gateway
– MODBUS RTU master for up to 246 slaves
– Integrated web server



Ethernet (MODBUS TCP)



Ethernet/RS-485 gateway (MODBUS TCP/MODBUS RTU)

Notes:
1) EMC: Class A product, see page 571

| Technical data | |
|---------------------------|--------------------------------|
| Serial port | Modbus TCP Ethernet (RJ45) |
| Output description | 10/100 Mbps |
| Serial transmission speed | |
| General data | |
| Supply voltage | 9 V (via EEM-MA600) |
| Degree of protection | IP20 |
| Ambient temperature range | -10°C ... 55°C (14°F to 131°F) |
| Conformance / approvals | |
| Conformance | CE-compliant |
| UL, USA / Canada | UL 61010-1 |

| Ordering data | | |
|-----------------------------|-----------|-------------|
| Type | Order No. | Pcs. / Pkt. |
| EEM-ETH-MA600 ¹⁾ | 2901373 | 1 |

| Technical data | |
|---------------------------|--------------------------------|
| Serial port | Modbus TCP Ethernet (RJ45) |
| Output description | 10/100 Mbps |
| Serial transmission speed | |
| General data | |
| Supply voltage | 9 V (via EEM-MA600) |
| Degree of protection | IP20 |
| Ambient temperature range | -10°C ... 55°C (14°F to 131°F) |
| Conformance / approvals | |
| Conformance | CE-compliant |
| UL, USA / Canada | UL 61010-1 |

| Ordering data | | |
|-----------------------------------|-----------|-------------|
| Type | Order No. | Pcs. / Pkt. |
| EEM-ETH-RS485-MA600 ¹⁾ | 2901374 | 1 |

| Description |
|---|
| Communication module (for EEM-MA600) Ethernet |
| RS-485/Ethernet gateway |

Extension module

Plug-in special function module for the EEM-MA600 energy meter

EEM-TEMP-MA600

- Temperature recording for up to three PT 100 temperature sensors
- Temperature measuring range $-20^{\circ}\text{C} \dots +150^{\circ}\text{C}$
- Internal temperature recording of the ambient temperature $-10^{\circ}\text{C} \dots +55^{\circ}\text{C}$

Notes:
1) EMC: Class A product, see page 571



Temperature module

| |
|---|
| Input data |
| Description of the input Temperature range |
| Transmission error |
| Basic accuracy |
| General data |
| Supply voltage |
| Degree of protection |
| Ambient temperature range |
| Conformance / approvals |
| Conformance |

| Technical data | | |
|--|--|--|
| Pt 100 input: 2, 3, 4-conductor | | |
| $-20^{\circ}\text{C} \dots 150^{\circ}\text{C}$ (Connected sensors) | | |
| $-10^{\circ}\text{C} \dots 55^{\circ}\text{C}$ (in the immediate vicinity) | | |
| 0.5 K/m (2-conductor) | | |
| 0.25 K/m (3-conductor) | | |
| 0 K/m (4-conductor) | | |
| $\pm 1 \text{ K}$ | | |
| 9 V (via EEM-MA600) | | |
| IP20 | | |
| $-10^{\circ}\text{C} \dots 55^{\circ}\text{C}$ (14°F to 131°F) | | |
| CE-compliant | | |

| |
|--|
| Description |
| Special function module (for EEM-MA600) |

| Ordering data | | |
|------------------------------|-----------|-------------|
| Type | Order No. | Pcs. / Pkt. |
| EEM-TEMP-MA600 ¹⁾ | 2901949 | 1 |

Extension modules

N

N

Plug-in special function modules for the EEM-MA400 and EEM-MA600 energy meters.

EEM-IMP-MA400

- One configurable pulse output
- One configurable threshold value

EEM-IMP-MA600

- Two configurable pulse outputs



Pulse module



Pulse module

| |
|---------------------------|
| Digital input |
| Voltage input signal |
| Input pulse length |
| Output |
| Output description |
| Maximum switching voltage |
| General data |
| Supply voltage |
| Degree of protection |
| Ambient temperature range |
| Conformance / approvals |
| Conformance |

| Technical data | | |
|--|--|--|
| - | | |
| - | | |
| Relay output | | |
| 100 V DC | | |
| 9 V (via EEM-MA400) | | |
| IP20 | | |
| $-10^{\circ}\text{C} \dots 55^{\circ}\text{C}$ (14°F to 131°F) | | |
| CE-compliant | | |

| Technical data | | |
|--|--|--|
| - | | |
| - | | |
| Relay output | | |
| 100 V DC | | |
| 9 V (via EEM-MA600) | | |
| IP20 | | |
| $-10^{\circ}\text{C} \dots 55^{\circ}\text{C}$ (14°F to 131°F) | | |
| CE-compliant | | |

| |
|--|
| Description |
| Special function module (for EEM-MA600) |
| With two digital I/Os |
| With two analog outputs |

| Ordering data | | |
|---------------|-----------|-------------|
| Type | Order No. | Pcs. / Pkt. |
| EEM-IMP-MA400 | 2904314 | 1 |

| Ordering data | | |
|---------------|-----------|-------------|
| Type | Order No. | Pcs. / Pkt. |
| EEM-IMP-MA600 | 2904313 | 1 |

Measuring instrument bracket

- For mounting the EEM-MA600 or EEM-MA400 energy meters on a 35 mm DIN rail according to EN 60715



For mounting on DIN rails

General data

Vibration resistance
Weight
DIN rail clip material
Fixing sheet material
Dimensions W / H / D

Technical data

57 Hz ... 150 Hz (2 g)
265 g
Aluminum, natural anodized
Stainless steel VA
116 / 112 / 115 mm

Description

DIN rail adapter for EEM-MA600 and EEM-MA400 energy meters

Ordering data

| Type | Order No. | Pcs. / Pkt. |
|-------------|-----------|-------------|
| EEM-MKT-DRA | 2902078 | 1 |

Complete packages for data logging

BASIC data logger kit

Optimize your use of energy and resources. Data loggers from Phoenix Contact can be used to monitor and log the supply of water, compressed air, and electricity to your system. This enables efficient cost control. No additional software or operator panels are needed to parameterize data loggers – simply use a web browser on your PC.

The BASIC data logger kit features:

- Low installation and energy costs, thanks to parameterization via web interface without programming knowledge
- Comprehensive solution – complete package available under one order number
- Flexible communication, thanks to the integrated GSM/GPRS modem and Ethernet interface
- Maximum system availability, thanks to limit value monitoring
- Standardized data routing, thanks to SQL interface
- Process information sent to the user via e-mail or SMS
- Set digital outputs on the data logger via SMS
- Integrated FTP and web server



Technical data

See www.phoenixcontact.net/products

Ordering data

| Description |
|--|
| Parameterizable data logger kit with Ethernet interface and GSM modem, including power supply unit with 8 digital outputs and 16 digital inputs, plus accessories and patch cable |

| Type | Order No. | Pcs. / Pkt. |
|--------------|-----------|-------------|
| PSK DL BASIC | 2700726 | 1 |

Complete packages for data logging

Notes:

1) EMC: Class A product, see page 571

FLEX data logger kit

The PSK DL FLEX data logger kit is the extended version of the PSK DL BASIC basic package. A maximum of three digital input terminals and four analog input terminals from the Inline I/O system can also be connected to the FLEX kit. The mounted terminals are automatically detected and started up. The PSK DL FLEX can be used to send digital and analog status information via SMS or e-mail or via mobile phone networks or Ethernet. In addition, the PSK DL FLEX can write the information directly to an SQL database that is provided.

In addition to all the properties of the BASIC version, the FLEX extended solution kit also offers the following:

- Direct SQL connection via SQL interface
- Process information via e-mail and SMS
- Flexible extension with additional I/O modules



Technical data

See www.phoenixcontact.net/products

Ordering data

| Type | Order No. | Pcs. / Pkt. |
|-------------|-----------|-------------|
| PSK DL FLEX | 2700727 | 1 |

Accessories

| | | |
|----------------------------------|---------|---|
| IB IL 24 DI 2-PAC ¹⁾ | 2861221 | 1 |
| IB IL 24 DI 4-PAC ¹⁾ | 2861234 | 1 |
| IB IL 24 DI 8-PAC ¹⁾ | 2861247 | 1 |
| IB IL 24 DI 16-PAC ¹⁾ | 2861250 | 1 |
| IB IL DI 8/S0-PAC ¹⁾ | 2897020 | 1 |
| IB IL AI 2/SF-PAC ¹⁾ | 2861302 | 1 |
| IB IL AI 8/SF-PAC ¹⁾ | 2861412 | 1 |
| IB IL AI 8/IS-PAC ¹⁾ | 2861661 | 1 |

Description

Extendable parameterizable **data logger kit** with Ethernet interface and GSM/GPRS modem, including power supply unit with 8 digital outputs, 24 digital inputs, and 8 analog inputs, plus accessories and patch cable

Inline digital input terminal, complete with accessories (connector and labeling field)

- 2 inputs
- 4 inputs
- 8 inputs
- 16 inputs
- S0 counter

Inline analog input terminal, complete with accessories (connector and labeling field)

- 2 inputs
- 8 inputs
- 8 inputs, initiator with supply outputs

Sensors and meters

Compressed air meters

Use meters from Phoenix Contact to monitor the use of compressed air, an expensive production resource. By using compressed air efficiently, you can decrease compressor usage and therefore reduce energy costs. The calorimetric measuring procedure records even the smallest consumption rates. You can therefore detect wear or leaks based on the amount of air consumed.

Use compressed air meters to acquire the following values:

- The current volumetric flow according to ISO 2533 and DIN 1343
- The total volume used
- The temperature of the compressed air in the monitored operating processes

The compressed air meters impress thanks to their:

- Detailed reference measurement with flow rate, total volume, and temperature display
- Intelligent sensor communication, thanks to IO-Link technology
- Measuring range from 0.06 Nm³/h to 700.0 Nm³/h
- Flexible use, thanks to IP65 protection: resistant to dust and splash water

IO-Link



Compressed air counter up to 75 Nm³/h



| | |
|---|--|
| Flow monitoring | |
| Measuring range | |
| Display area | |
| Repeatability | |
| Response time | |
| Measured value error | |
| Temperature monitoring | |
| Measuring range | |
| Display area | |
| Response time | |
| Resolution | |
| Accuracy | |
| Supply for module electronics | |
| Connection method | |
| No. of pos. | |
| Supply voltage range | |
| Current draw | |
| Digital outputs | |
| Pulse value | |
| Pulse length | |
| Delay time | |
| Analog outputs | |
| Type of protection | |
| Current output signal | |
| Load/output load current output | |
| General data | |
| Weight | |
| Width | |
| Height | |
| Depth | |
| Degree of protection | |
| Protection class | |
| Ambient temperature (operation) | |
| Ambient temperature (storage/transport) | |
| Vibration resistance according to IEC 60068-2-6 | |

| Technical data | | |
|---|--|---|
| | PSK AFS6050IOL | PSK AFS6000IOL |
| Measuring range | 0 Nm ³ /h ... 75 Nm ³ /h | 0 Nm ³ /h ... 90 Nm ³ /h |
| Repeatability | (±1.5% of the measured value) | |
| Response time | < 0.1 s ((dAP = 0)) | |
| Measured value error | ±15% of the measured value +1.5% of the measuring range final value | Depending on the air quality: ±3% of the measured value +0.3% of the measuring range final value; ±6% of the measured value +0.6% of the measuring range final value |
| Temperature monitoring | | |
| Measuring range | 0°C ... 60°C | |
| Display area | -12°C ... 72°C | |
| Response time | 30 s (Q > 0.1 Nm ³ /h) | |
| Resolution | 0.5°C | |
| Accuracy | ±2.5°C (Q > 0.1 Nm ³ /h) | |
| Supply for module electronics | | |
| Connection method | M12 plug-in connector | |
| No. of pos. | 4 | |
| Supply voltage range | 19 V DC ... 30 V DC | |
| Current draw | < 100 mA | |
| Digital outputs | | |
| Pulse value | 0.0010 m ³ ... 1000000 m ³ | |
| Pulse length | min. 0.04 s | |
| Delay time | 0.5 s (Operational readiness) | |
| Analog outputs | | |
| Type of protection | Short-circuit protection, polarity reversal protection | |
| Current output signal | 4 mA ... 20 mA | |
| Load/output load current output | ≤ 500 Ω | |
| General data | | |
| Weight | 581 g | 961 g |
| Width | 45 mm | |
| Height | 111 mm | 300 mm |
| Depth | 79.5 mm | 76.8 mm |
| Degree of protection | IP65 | |
| Protection class | III | |
| Ambient temperature (operation) | 0°C ... 60°C | |
| Ambient temperature (storage/transport) | -20°C ... 85°C | |
| Vibration resistance according to IEC 60068-2-6 | 5 g (55 ... 2000 Hz) | |

| Description |
|---|
| Compressed air meter: G1/2 process connection, measuring range up to 75 Nm ³ /h |
| Compressed air meter: G1/2 process connection, measuring range up to 75 Nm ³ /h |
| Compressed air meter: R1/4 process connection, measuring range up to 15 Nm ³ /h |
| Compressed air meter: R1 process connection, measuring range up to 225 Nm ³ /h |
| Compressed air meter: R2 process connection, measuring range up to 700 Nm ³ /h |

| Ordering data | | |
|----------------|-----------|-------------|
| Type | Order No. | Pcs. / Pkt. |
| PSK AFS6050IOL | 2700704 | 1 |
| PSK AFS6000IOL | 2700707 | 1 |



IO-Link



Compressed air counter up to 15 Nm³/h

IO-Link



Compressed air counter up to 225 Nm³/h

IO-Link



Compressed air counter up to 700 Nm³/h



Technical data

Technical data

Technical data

0 Nm³/h ... 15 Nm³/h
 0 Nm³/h ... 18 Nm³/h
 (±1.5% of the measured value)
 < 0.1 s ((dAP = 0))
 Depending on the air quality: ±3% of the measured value +0.3% of the measuring range final value; ±6% of the measured value +0.6% of the measuring range final value

0 Nm³/h ... 225 Nm³/h
 0 Nm³/h ... 270 Nm³/h
 (±1.5% of the measured value)
 < 0.1 s ((dAP = 0))
 Depending on the air quality: ±3% of the measured value +0.3% of the measuring range final value; ±6% of the measured value +0.6% of the measuring range final value

2 Nm³/h ... 700 Nm³/h
 0 Nm³/h ... 840 Nm³/h
 (±1.5% of the measured value)
 < 0.1 s ((dAP = 0))
 Depending on the air quality: ±3% of the measured value +0.3% of the measuring range final value; ±6% of the measured value +0.6% of the measuring range final value

0°C ... 60°C
 -12°C ... 72°C
 30 s (Q > 0.1 Nm³/h)
 0.5°C
 ±2.5°C (Q > 0.1 Nm³/h)

0°C ... 60°C
 -12°C ... 72°C
 30 s (Q > 0.1 Nm³/h)
 0.5°C
 ±2.5°C (Q > 0.1 Nm³/h)

0°C ... 60°C
 -12°C ... 72°C
 30 s (Q > 0.1 Nm³/h)
 0.5°C
 ±2.5°C (Q > 0.1 Nm³/h)

M12 plug-in connector
 4
 19 V DC ... 30 V DC
 < 100 mA

M12 plug-in connector
 4
 19 V DC ... 30 V DC
 < 100 mA

M12 plug-in connector
 4
 19 V DC ... 30 V DC
 < 100 mA

0.0010 m³ ... 1000000 m³
 min. 0.2 s
 0.5 s (Operational readiness)

0.0030 m³ ... 3000000 m³
 min. 0.02 s
 1 s (Operational readiness)

0.0100 m³ ... 4000000 m³
 min. 0.043 s
 0.5 s (Operational readiness)

Short-circuit protection, polarity reversal protection
 4 mA ... 20 mA
 ≤ 500 Ω

Short-circuit protection, polarity reversal protection
 4 mA ... 20 mA
 ≤ 500 Ω

Short-circuit protection, polarity reversal protection
 4 mA ... 20 mA
 ≤ 500 Ω

887 g
 45 mm
 193.3 mm
 74.5 mm
 IP65
 III
 0°C ... 60°C
 -20°C ... 85°C
 5 g (55 ... 2000 Hz)

2.053 kg
 45 mm
 475 mm
 88.5 mm
 IP65
 III
 0°C ... 60°C
 -20°C ... 85°C
 5 g (55 ... 2000 Hz)

4.332 kg
 133 mm
 475 mm
 -
 IP65
 III
 0°C ... 60°C
 -20°C ... 85°C
 5 g (55 ... 2000 Hz)

Ordering data

Ordering data

Ordering data

| Type | Order No. | Pcs. / Pkt. |
|----------------|-----------|-------------|
| PSK AFS5000IOL | 2700705 | 1 |

| Type | Order No. | Pcs. / Pkt. |
|----------------|-----------|-------------|
| PSK AFS8000IOL | 2700708 | 1 |

| Type | Order No. | Pcs. / Pkt. |
|----------------|-----------|-------------|
| PSK AFS2000IOL | 2700709 | 1 |



Extremely versatile

PACT current transformers offer a complete product range for converting alternating currents up to 4000 A into secondary currents of 1 A and 5 A. Depending on requirements, bus-bar, plug-in, and winding current transformers are available. PACT current transformers are available in different transformation ratios, accuracy classes, and rated powers - in 3000 versions, for your current measurement requirements.

Also available for higher accuracy classes

For standard applications, such as in machine building or system manufacturing, Phoenix Contact offers current transformers with accuracy classes 0.5 and 1 in a version that cannot be calibrated.

For higher accuracy or for billing purposes in energy supply, type-tested transformers that can be calibrated as well as calibrated transformers are available - with classes 0.2/0.2S/0.5 and 0.5S.



Fast and secure installation

The current transformer quick-action mechanism offers the following advantages:

- Tool-free mounting
- Considerable reduction in installation time
- Easy handling and secure fastening by pressing with finger
- Current transformers align themselves – no need for subsequent alignment



Variable and space-saving mounting

In addition to the vertical and horizontal mounting position, the optional accessories offer further installation options such as mounting on the DIN rail or on the control cabinet panel.

All PACT current transformers are just 30 mm wide. This saves space – for example flat mounting when measuring branch outlets.

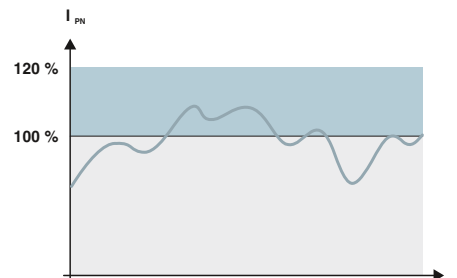

Safe detection of current peaks

PACT current transformers can be used to safely detect current peaks greater than the rated nominal current strength – without resulting in any damage: the transformers are designed for a continuous thermal nominal current that is 120% of the primary rated current strength.

Example: a PACT transformer with a specified rated power of 10 VA does indeed deliver 14.4 VA on a continual basis.

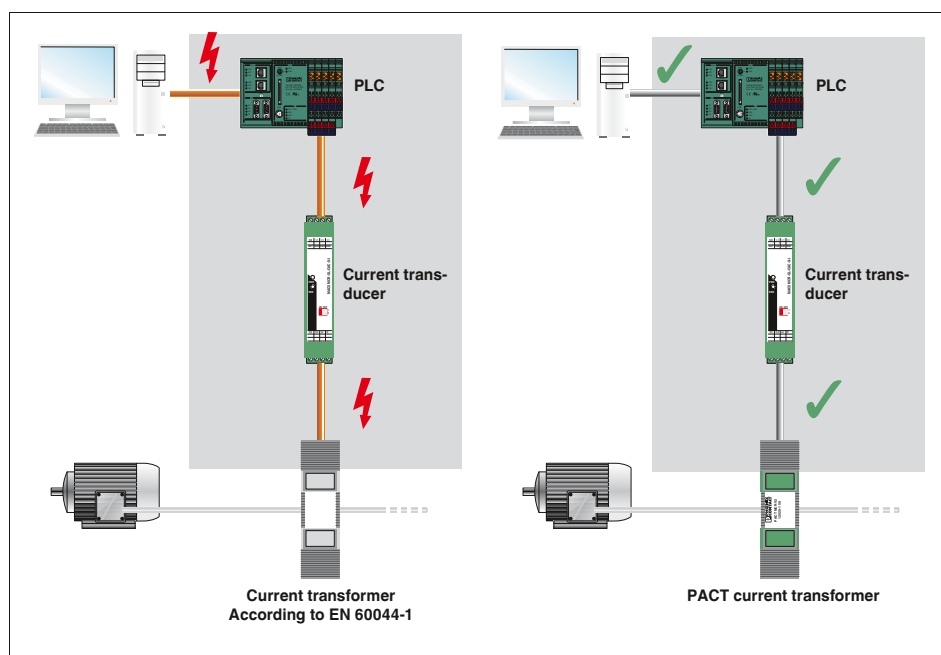

Safe isolation

PACT current transformers are manufactured in accordance with EN 50178. This is relevant for electronic equipment for use in power installations.

EN 50178 differs considerably from EN 60044, the usual standard for transformers, with regard to safety.

Your advantages:

- PACT current transformers offer safe isolation, thanks to greater air and creepage distances
- PACT current transformers ensure that there is no sparkover on the secondary side of the transformer and human life is protected inside and outside the control cabinet
- Up to 1000 V (L-N) operating voltage possible
- Routine testing with 12 kV (1.2/50 μ s)
- Surge voltage category 3 is met

Monitoring

Current transformers

Selection guide

- Complete range consisting of winding, bus-bar, and plug-in current transformers
- Popular types available from stock; alternatively, order key can be used for custom dimensioning
- Versions available to support official calibration

Selection

- Select your converter in accordance with the dimensions of the copper rail
- Specify the four electrical characteristics of the converter:

- 1. The primary rated current strength I_{pn}** - the maximum amperage occurring in the path to be measured
- 2. The secondary rated current I_{sn}** - supplied to the downstream measuring devices
- 3. Class** - accuracy for adherence to the specified tolerances
- 4. Rated power S_n [VA]** - takes account of all the loads occurring in the measuring circuit



Input data

Thermal rated short-time current
 Rated surge current
 Rated frequency
 Surge current limitation factor

General data

Rated insulation voltage
 Test voltage
 Impulse withstand voltage
 Insulating material class
 Connection capacity of secondary terminals
 Ambient temperature (operation)
 Standards/regulations
 Housing material

Technical data

$I_{th} = 60 \cdot I_n$
 $I_{dyn} = 2.5 \cdot I_{th}$
 50 Hz ... 60 Hz
 FS 5

1 kV
 3 kV (50 Hz, 1 min.)
 12 kV (1.2 / 50 μs)
 E
 2 x (2,5 x 4) mm
 -25°C ... 40°C
 IEC 60044-1, EN 50178
 Polyamide PA fiberglass reinforced

Calculation guide

Determination of the secondary side rated power S_n

- All the occurring loads must be added:
- Calculate the power requirement of the copper cable (forward and return line)
 - Take into account the power requirement of the connected devices (measuring devices)
 - Add a reserve requirement

$$S_n \text{ total} = S_n \text{ copper cable} + S_n \text{ measuring device} + S_n \text{ reserve}$$

Power requirement of copper cables with a different diameter

| Conductor cross section in mm ² | Rated power in VA/m (consider the forward and return line) | |
|--|--|--------------------------------|
| | Secondary current I_{sn} 5 A | Secondary current I_{sn} 1 A |
| 1.5 | 0.2917 | 0.0117 |
| 2.5 | 0.1750 | 0.0070 |
| 4 | 0.1094 | 0.0044 |
| 6 | 0.0729 | 0.0029 |

Example:
 S_n copper cable = cable length x 2 x rated power
 S_n copper cable = 10 m x 2 x 0.1750 VA/m = 3.50 VA

S_n measuring device = 2 VA

S_n reserve < 0.5 x (S_n copper cable + S_n measuring device)
 S_n reserve = 2 VA

S_n total = S_n copper cable + S_n measuring device + S_n reserve
 S_n total = 3.5 VA + 2 VA + 2 VA = 7.5 VA

Order key - example for PACT MCR-V2-3015-60

Preferred types that can be ordered directly are marked in green in the selection table.

| Order No. | Primary current I_{pn} | Secondary current I_{sn} | Class | Rated power S_n |
|-----------|--|----------------------------|-----------------------------------|--|
| 2277271 | IP02000 | IS05 | C10 | P750 |
| | IP00600 ≙ 60 A IP00750 ≙ 75 A IP00800 ≙ 80 A IP01000 ≙ 100 A IP01250 ≙ 125 A IP02000 ≙ 200 A IP02500 ≙ 250 A | IS01 ≙ 1 A IS05 ≙ 5 A | C02 ≙ 0.2 C05 ≙ 0.5 C10 ≙ 1 | P125 ≙ 1.25 VA P250 ≙ 2.5 VA P375 ≙ 3.75 VA P500 ≙ 5.0 VA P750 ≙ 7.5 VA P1000 ≙ 10 VA |

1. 2. 3. 4.

Selection table (extract)

| I_{sn} | Cl. | Primary rated current strength I_{pn} [A] | | | | | | | | Rated power S_n [VA] | |
|----------|-----|---|------|------|-----|-----|-----|-----|-----|------------------------|---|
| | | 60 | 75 | 80 | 100 | 125 | 150 | 200 | 250 | | |
| 1A | 0.5 | | | | | | | 2.5 | 2.5 | 3.75 | 5 |
| | 1 | 1.25 | 2.5 | 2.5 | 2.5 | 2.5 | 2.5 | 2.5 | 2.5 | 3.75 | 5 |
| 5A | 0.5 | | | | | | | 2.5 | 2.5 | 3.75 | 5 |
| | 1 | 1.25 | 1.25 | 1.25 | 2.5 | 2.5 | 2.5 | 2.5 | 2.5 | 3.75 | 5 |

Current transformers

PACT MCR-V1-21-44

- Primary rated current I_{pn} : 0...(50...500) A
- Round conductor dimensions: \varnothing 21 mm

| |
|--|
| Notes: |
| Our configurator, which is available at www.phoenixcontact.net/products , makes ordering easy. |
| Current transformers that support official calibration: To specify the type of current transformer you require, please use the order key on page 224 |
| The relevant installation accessories can be found on page 223 |



Bus-bar curr. transf., official calibration as an option

| Description | | Rated power S_n | Ordering data | | |
|---|--|-------------------|-----------------------------------|-----------|-------------|
| Description | | Rated power S_n | Type | Order No. | Pcs. / Pkt. |
| Preferred versions available from stock (marked in green in the selection table) | | | | | |
| Primary rated current I_{pn} : | | | | | |
| - 50 A | | 1.25 VA | PACT MCR-V1-21-44- 50-5A-1 | 2277019 | 1 |
| - 75 A | | 2.5 VA | PACT MCR-V1-21-44- 75-5A-1 | 2277611 | 1 |
| - 100 A | | 2.5 VA | PACT MCR-V1-21-44-100-5A-1 | 2277022 | 1 |
| - 125 A | | 3.75 VA | PACT MCR-V1-21-44-125-5A-1 | 2277763 | 1 |
| - 150 A | | 5 VA | PACT MCR-V1-21-44-150-5A-1 | 2277035 | 1 |
| - 200 A | | 5 VA | PACT MCR-V1-21-44-200-5A-1 | 2277776 | 1 |
| - 250 A | | 5 VA | PACT MCR-V1-21-44-250-5A-1 | 2277048 | 1 |
| - 300 A | | 10 VA | PACT MCR-V1-21-44-300-5A-1 | 2277789 | 1 |
| - 400 A | | 5 VA | PACT MCR-V1-21-44-400-5A-1 | 2277051 | 1 |
| - 500 A | | 10 VA | PACT MCR-V1-21-44-500-5A-1 | 2277792 | 1 |
| Current transformers , pay attention to the following order key for determining the desired current transformer type | | | | | |
| | | | PACT MCR-V1-21-44 | 2277268 | 1 |

Add **order key** from the selection table (ordering example marked in orange)

| | | | | |
|------------------|--|--|--------------|-------------------------------------|
| Order No. | Primary current I_{pn} | Secondary current I_{sn} | Class | Rated power S_n |
| 2277268 | IP05000 | IS01 | C05 | P1000 |

Selection table PACT MCR-V1-21-44 (Order No.: 2277268)

| I_{sn} | Cl. | Primary rated current amperage I_{pn} [A] | | | | | | | | | | | Rated power S_n [VA] | | | | |
|-----------------------|----------------------|---|------|-----|-----|------|------|------|-----|-----|-----|-----|------------------------|-----|-----|-----|--|
| | | 50 | 60 | 75 | 80 | 100 | 125 | 150 | 200 | 250 | 300 | 400 | | 500 | | | |
| IS01 ≈ 1 A | C05 ≈ 0.5 | | | | | 1.25 | 2.5 | 2.5 | 2.5 | 2.5 | 2.5 | 2.5 | 2.5 | 2.5 | 2.5 | 2.5 | |
| | C10 ≈ 1 | | | | | | | 3.75 | 5 | 5 | 5 | 5 | 5 | 5 | 5 | 5 | |
| IS05 ≈ 5 A | C05 ≈ 0.5 | | | | | 1.25 | 1.25 | 1.25 | 2.5 | 2.5 | 2.5 | 2.5 | 2.5 | 2.5 | 2.5 | 2.5 | |
| | C10 ≈ 1 | 1.25 | 1.25 | 2.5 | 2.5 | 2.5 | 2.5 | 2.5 | 2.5 | 2.5 | 2.5 | 2.5 | 2.5 | 2.5 | 2.5 | 2.5 | |

Monitoring

Current transformers

Current transformers

PACT MCR-V2-3015-60

- Primary rated current I_{pn} : 0...(50...750) A
- Round conductor dimensions: \varnothing 28 mm
- Rail dimensions: 30x15 mm; 20x20 mm

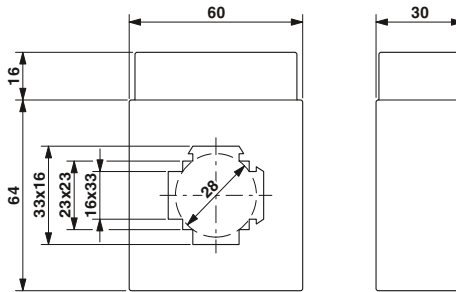

Plug-in curr. transformer, official calibration as an option

Notes:
 Our configurator, which is available at www.phoenixcontact.net/products, makes ordering easy.
 Current transformers that support official calibration: To specify the type of current transformer you require, please use the order key on page 224
 The relevant installation accessories can be found on page 223

Ordering data

| Description | Rated power S_n | Type | Order No. | Pcs. / Pkt. |
|---|-------------------|--------------------------------|-----------|-------------|
| Preferred versions available from stock (marked in green in the selection table) | | | | |
| Primary rated current I_{pn} : | | | | |
| - 60 A | 1.25 VA | PACT MCR-V2-3015- 60- 60-5A-1 | 2277815 | 1 |
| - 75 A | 1.25 VA | PACT MCR-V2-3015- 60- 75-5A-1 | 2277828 | 1 |
| - 75 A | 1.5 VA | PACT MCR-V2- 3015- 60- 75-5A-1 | 2276502 | 1 |
| - 80 A | 1.25 VA | PACT MCR-V2-3015- 60- 80-5A-1 | 2277831 | 1 |
| - 100 A | 2.5 VA | PACT MCR-V2-3015- 60- 100-5A-1 | 2277064 | 1 |
| - 125 A | 3.75 VA | PACT MCR-V2-3015- 60- 125-5A-1 | 2277624 | 1 |
| - 150 A | 3.75 VA | PACT MCR-V2-3015- 60- 150-5A-1 | 2277844 | 1 |
| - 150 A | 5 VA | PACT MCR-V2-3015- 60- 150-5A-1 | 2277077 | 1 |
| - 200 A | 5 VA | PACT MCR-V2-3015- 60- 200-5A-1 | 2277637 | 1 |
| - 200 A | 7.5 VA | PACT MCR-V2-3015- 60- 200-5A-1 | 2277857 | 1 |
| - 250 A | 5 VA | PACT MCR-V2- 3015- 60-250-5A-1 | 2276544 | 1 |
| - 250 A | 7.5 VA | PACT MCR-V2-3015- 60- 250-5A-1 | 2277860 | 1 |
| - 250 A | 10 VA | PACT MCR-V2-3015- 60- 250-5A-1 | 2277080 | 1 |
| - 300 A | 7.5 VA | PACT MCR-V2-3015- 60- 300-5A-1 | 2277640 | 1 |
| - 400 A | 10 VA | PACT MCR-V2-3015- 60- 400-5A-1 | 2277093 | 1 |
| - 500 A | 10 VA | PACT MCR-V2-3015- 60- 500-5A-1 | 2277653 | 1 |
| - 600 A | 10 VA | PACT MCR-V2-3015- 60- 600-5A-1 | 2277103 | 1 |
| - 750 A | 10 VA | PACT MCR-V2-3015- 60- 750-5A-1 | 2277666 | 1 |
| Current transformers , pay attention to the following order key for determining the desired current transformer type | | | | |
| | | PACT MCR-V2- 3015- 60 | 2277271 | 1 |
| Quick-action mechanism ; width of the holding latch 16 mm | | | | |
| Fixing pin length 40 mm | | PACT-FAST-MNT-W16-L40 | | 2276638 |
| Quick-action mechanism ; width of the holding latch 16 mm | | | | |
| Fixing pin length 65 mm | | PACT-FAST-MNT-W16-L65 | | 2276641 |

Accessories

Add **order key** from the selection table (ordering example marked in orange)

| | | | | |
|-----------|--------------------------|----------------------------|-------|-------------------|
| Order No. | Primary current I_{pn} | Secondary current I_{sn} | Class | Rated power S_n |
| 2277271 | IP07500 | IS01 | C05 | P1500 |

Selection table PACT MCR-V2-3015-60 (Order No.: 2277271)

| I_{sn} | Cl. | Primary rated current amperage I_{pn} [A] | | | | | | | | | | | | | Rated power S_n [VA] | | | | | | | | |
|---------------|--------------|---|----|----|----|------|-----|-----|-----|-----|-----|-----|-----|-----|------------------------|-----|-----|-----|-----|-----|-----|-----|-----|
| | | 50 | 60 | 75 | 80 | 100 | 125 | 150 | 200 | 250 | 300 | 400 | 500 | 600 | | 750 | | | | | | | |
| IS01 ≅ 1 A | C05 ≅ 0.5 | | | | | 1.25 | 2.5 | 2.5 | | 2.5 | 2.5 | 2.5 | 2.5 | 2.5 | 2.5 | 2.5 | 2.5 | 2.5 | 2.5 | 2.5 | 2.5 | 2.5 | 2.5 |
| | C10 ≅ 1 | | | | | | | | | | | | | | | | | | | | | | |
| | C10 ≅ 1 | | | | | | | | | | | | | | | | | | | | | | |
| IS05 ≅ 5 A | C05 ≅ 0.5 | | | | | | | | | | | | | | | | | | | | | | |
| | C10 ≅ 1 | | | | | | | | | | | | | | | | | | | | | | |
| | C10 ≅ 1 | | | | | | | | | | | | | | | | | | | | | | |

Current transformers

PACT MCR-V2-4012-70

- Primary rated current I_{pn} : 0...(75...1000) A
- Round conductor dimensions: \varnothing 33 mm
- Rail dimensions: 40x12 mm; 2x 30x10 mm



Plug-in curr. transformer, official calibration as an option

Notes:
 Our configurator, which is available at www.phoenixcontact.net/products, makes ordering easy.
 Current transformers that support official calibration: To specify the type of current transformer you require, please use the order key on page 224
 The relevant installation accessories can be found on page 223

| Description | Rated power S_n |
|---|-------------------|
| Preferred versions available from stock (marked in green in the selection table) | |
| Primary rated current I_{pn} : | |
| - 250 A | 5 VA |
| - 300 A | 7.5 VA |
| - 400 A | 7.5 VA |
| - 500 A | 10 VA |
| - 600 A | 10 VA |
| - 750 A | 10 VA |
| - 800 A | 10 VA |
| - 1000 A | 10 VA |
| Current transformers , pay attention to the following order key for determining the desired current transformer type | |

| Ordering data | | |
|--------------------------------|-----------|-------------|
| Type | Order No. | Pcs. / Pkt. |
| PACT MCR-V2-4012- 70- 250-5A-1 | 2277116 | 1 |
| PACT MCR-V2-4012- 70- 300-5A-1 | 2277679 | 1 |
| PACT MCR-V2-4012- 70- 400-5A-1 | 2277129 | 1 |
| PACT MCR-V2-4012- 70- 500-5A-1 | 2277682 | 1 |
| PACT MCR-V2-4012- 70- 600-5A-1 | 2277132 | 1 |
| PACT MCR-V2-4012- 70- 750-5A-1 | 2277695 | 1 |
| PACT MCR-V2-4012- 70- 800-5A-1 | 2277145 | 1 |
| PACT MCR-V2-4012- 70-1000-5A-1 | 2277158 | 1 |
| PACT MCR-V2- 4012- 70 | 2277284 | 1 |

Quick-action mechanism; width of the holding latch 13 mm
 Fixing pin length 40 mm
Quick-action mechanism; width of the holding latch 13 mm
 Fixing pin length 65 mm

| Accessories | | |
|-----------------------|-----------|-------------|
| Type | Order No. | Pcs. / Pkt. |
| PACT-FAST-MNT-W13-L40 | 2276612 | 1 |
| PACT-FAST-MNT-W13-L65 | 2276625 | 1 |

Add order key from the selection table (ordering example marked in orange)

| | | | | |
|-----------|--------------------------|----------------------------|-------|-------------------|
| Order No. | Primary current I_{pn} | Secondary current I_{sn} | Class | Rated power S_n |
| 2277284 | IP010000 | IS05 | C10 | P250 |

Selection table PACT MCR-V2-4012-70 (Order No.: 2277284)

| I_{sn} | Cl. | Primary rated current strength I_{pn} [A] | | | | | | | | | | | Rated power S_n [VA] | | | | | |
|---------------|-------------------|---|------|------|------|------|------|-----|-----|-----|-----|-----|------------------------|-----|-----|------|-----|----|
| | | 75 | 80 | 100 | 125 | 150 | 200 | 250 | 300 | 400 | 500 | 600 | | 750 | 800 | 1000 | | |
| ≈ 1 A | C05 ≈ 0.5 | | | | 1.25 | 2.5 | 3.75 | 5 | 5 | 5 | 5 | 5 | 5 | 5 | 5 | 5 | 5 | 15 |
| | | | | | | | | | 7.5 | 10 | 10 | 10 | 10 | 10 | 10 | 10 | 10 | |
| | C10 ≈ 1 | | 1.25 | 1.25 | 2.5 | 2.5 | 2.5 | 2.5 | 2.5 | 2.5 | 2.5 | 2.5 | 2.5 | 2.5 | 2.5 | 2.5 | 2.5 | |
| | | | | | | 3.75 | 5 | 5 | 5 | 5 | 5 | 5 | 5 | 5 | 5 | 5 | 5 | |
| ≈ 5 A | C05 ≈ 0.5 | | | | 1.25 | 2.5 | 3.75 | 5 | 5 | 5 | 5 | 5 | 5 | 5 | 5 | 5 | 5 | 15 |
| | | | | | | | | | | 7.5 | 10 | 10 | 10 | 10 | 10 | 10 | 10 | |
| | C10 ≈ 1 | | 1.25 | 1.25 | 2.5 | 2.5 | 2.5 | 2.5 | 2.5 | 2.5 | 2.5 | 2.5 | 2.5 | 2.5 | 2.5 | 2.5 | 2.5 | |
| | | | | | | 3.75 | 5 | 5 | 5 | 5 | 5 | 5 | 5 | 5 | 5 | 5 | 5 | |

Monitoring

Current transformers

Current transformers

PACT MCR-V2-5012-85

- Primary rated current I_{pn} : 0...(100...1500) A
- Round conductor dimensions: \varnothing 42 mm
- Rail dimensions: 50x12 mm; 2x 40x10 mm

Notes:

Our configurator, which is available at www.phoenixcontact.net/products, makes ordering easy.

Current transformers that support official calibration: To specify the type of current transformer you require, please use the order key on page 224

The relevant installation accessories can be found on page 223

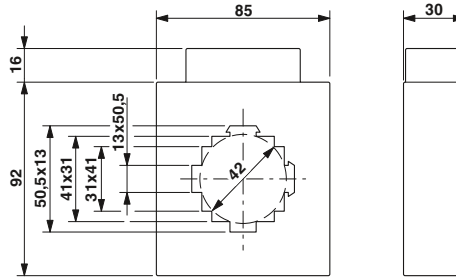

Plug-in curr. transformer, official calibration as an option

Ordering data

| Description | Rated power S_n | Type | Order No. | Pcs. / Pkt. |
|---|-------------------|--------------------------------|-----------|-------------|
| Preferred versions available from stock (marked in green in the selection table) | | | | |
| Primary rated current I_{pn} : | | | | |
| - 150 A | 3.75 VA | PACT MCR-V2-5012- 85- 150-5A-1 | 2276117 | 1 |
| - 200 A | 5 VA | PACT MCR-V2-5012- 85- 200-5A-1 | 2276120 | 1 |
| - 250 A | 7.5 VA | PACT MCR-V2-5012- 85- 250-5A-1 | 2276133 | 1 |
| - 300 A | 10 VA | PACT MCR-V2-5012- 85- 300-5A-1 | 2276146 | 1 |
| - 400 A | 10 VA | PACT MCR-V2-5012- 85- 400-5A-1 | 2277161 | 1 |
| - 500 A | 15 VA | PACT MCR-V2-5012- 85- 500-5A-1 | 2276159 | 1 |
| - 600 A | 10 VA | PACT MCR-V2-5012- 85- 600-5A-1 | 2277174 | 1 |
| - 600 A | 15 VA | PACT MCR-V2-5012- 85- 600-5A-1 | 2276162 | 1 |
| - 750 A | 10 VA | PACT MCR-V2-5012- 85- 750-5A-1 | 2276175 | 1 |
| - 800 A | 10 VA | PACT MCR-V2-5012- 85- 800-5A-1 | 2277187 | 1 |
| - 1000 A | 10 VA | PACT MCR-V2-5012- 85-1000-5A-1 | 2276463 | 1 |
| - 1000 A | 15 VA | PACT MCR-V2-5012- 85-1000-5A-1 | 2277190 | 1 |
| - 1250 A | 15 VA | PACT MCR-V2-5012- 85-1250-5A-1 | 2277200 | 1 |
| - 1500 A | 15 VA | PACT MCR-V2-5012- 85-1500-5A-1 | 2276188 | 1 |
| Current transformers , pay attention to the following order key for determining the desired current transformer type | | | | |
| PACT MCR-V2- 5012- 85 | | | 2277297 | 1 |

Accessories

| Accessories | Order No. | Pcs. / Pkt. | |
|--|-----------------------|-------------|---|
| Quick-action mechanism ; width of the holding latch 13 mm | | | |
| Fixing pin length 40 mm | PACT-FAST-MNT-W13-L40 | 2276612 | 1 |
| Quick-action mechanism ; width of the holding latch 13 mm | | | |
| Fixing pin length 65 mm | PACT-FAST-MNT-W13-L65 | 2276625 | 1 |

Add **order key** from the selection table (ordering example marked in orange)

| | | | | |
|-----------|--------------------------|----------------------------|-------|-------------------|
| Order No. | Primary current I_{pn} | Secondary current I_{sn} | Class | Rated power S_n |
| 2277297 | IP02500 | IS01 | C10 | P750 |

Selection table PACT MCR-V2-5012-85 (Order No.: 2277297)

| I_{sn} | Cl. | Primary rated current amperage I_{pn} [A] | | | | | | | | | | | | | | Rated power S_n [VA] | |
|---------------|--------------|---|-----|------|-----|-----|-----|-----|-----|-----|-----|-----|------|------|------|------------------------|-----|
| | | 100 | 125 | 150 | 200 | 250 | 300 | 400 | 500 | 600 | 750 | 800 | 1000 | 1250 | 1500 | | |
| IS01 ≅ 1 A | C05 ≅ 0.5 | | | 1.25 | 2.5 | 2.5 | 2.5 | 2.5 | 2.5 | 2.5 | 2.5 | 2.5 | 2.5 | 2.5 | 2.5 | 2.5 | 2.5 |
| | | | | | 5 | 5 | 5 | 5 | 5 | 5 | 5 | 5 | 5 | 5 | 5 | 5 | 5 |
| | C10 ≅ 1 | 1.25 | 2.5 | 2.5 | 2.5 | 2.5 | 2.5 | 2.5 | 2.5 | 2.5 | 2.5 | 2.5 | 2.5 | 2.5 | 2.5 | 2.5 | 2.5 |
| IS05 ≅ 5 A | C05 ≅ 0.5 | | | 1.25 | 2.5 | 2.5 | 2.5 | 2.5 | 2.5 | 2.5 | 2.5 | 2.5 | 2.5 | 2.5 | 2.5 | 2.5 | 2.5 |
| | | | | | 5 | 5 | 5 | 5 | 5 | 5 | 5 | 5 | 5 | 5 | 5 | 5 | 5 |
| | C10 ≅ 1 | 1.25 | 2.5 | 2.5 | 2.5 | 2.5 | 2.5 | 2.5 | 2.5 | 2.5 | 2.5 | 2.5 | 2.5 | 2.5 | 2.5 | 2.5 | 2.5 |
| | | | | 3.75 | 5 | 5 | 5 | 5 | 5 | 5 | 5 | 5 | 5 | 5 | 5 | 5 | |
| | | | | | 7.5 | 7.5 | 10 | 10 | 10 | 10 | 10 | 10 | 10 | 10 | 10 | 10 | |
| | | | | | | | 10 | 10 | 10 | 10 | 10 | 10 | 10 | 10 | 10 | 10 | |
| | | | | | | | | 15 | 15 | 15 | 15 | 15 | 15 | 15 | 15 | 15 | |
| | | | | | | | | | 20 | 20 | 20 | 20 | 20 | 20 | 20 | 20 | |
| | | | | | | | | | | 20 | 20 | 20 | 20 | 20 | 20 | 20 | |
| | | | | | | | | | | | 20 | 20 | 20 | 20 | 20 | 20 | |
| | | | | | | | | | | | | 20 | 20 | 20 | 20 | 20 | |
| | | | | | | | | | | | | | 20 | 20 | 20 | 20 | |
| | | | | | | | | | | | | | | 20 | 20 | 20 | |
| | | | | | | | | | | | | | | | 20 | 20 | |

Current transformers

PACT MCR-V2-6015-85

- Primary rated current I_{pn} : 0...(200...1600) A
- Round conductor dimensions: \varnothing 52 mm
- Rail dimensions: 60x15 mm; 2x 50x10 mm; 40x40 mm

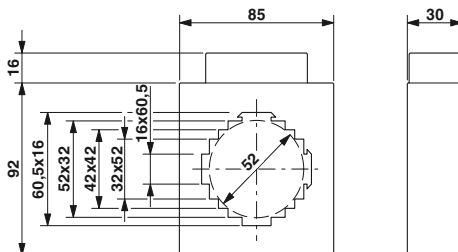

Plug-in curr. transformer, official calibration as an option

Notes:
 Our configurator, which is available at www.phoenixcontact.net/products, makes ordering easy.
 Current transformers that support official calibration: To specify the type of current transformer you require, please use the order key on page 224
 The relevant installation accessories can be found on page 223

| Description | | Rated power S_n | Ordering data | | |
|---|--|-------------------|--------------------------------|-----------|-------------|
| Preferred versions available from stock (marked in green in the selection table) | | | Type | Order No. | Pcs. / Pkt. |
| Primary rated current I_{pn} : | | | | | |
| - 200 A | | 2.5 VA | PACT MCR-V2-6015- 85- 200-5A-1 | 2277873 | 1 |
| - 250 A | | 2.5 VA | PACT MCR-V2-6015- 85- 250-5A-1 | 2277886 | 1 |
| - 300 A | | 2.5 VA | PACT MCR-V2-6015- 85- 300-5A-1 | 2277899 | 1 |
| - 400 A | | 2.5 VA | PACT MCR-V2-6015- 85- 400-5A-1 | 2277909 | 1 |
| - 500 A | | 5 VA | PACT MCR-V2-6015- 85- 500-5A-1 | 2277912 | 1 |
| - 600 A | | 10 VA | PACT MCR-V2-6015- 85- 600-5A-1 | 2277925 | 1 |
| - 750 A | | 10 VA | PACT MCR-V2-6015- 85- 750-5A-1 | 2277938 | 1 |
| - 800 A | | 10 VA | PACT MCR-V2-6015- 85- 800-5A-1 | 2277941 | 1 |
| - 1000 A | | 15 VA | PACT MCR-V2-6015- 85-1000-5A-1 | 2277954 | 1 |
| - 1250 A | | 15 VA | PACT MCR-V2-6015- 85-1250-5A-1 | 2277967 | 1 |
| - 1500 A | | 15 VA | PACT MCR-V2-6015- 85-1500-5A-1 | 2277970 | 1 |
| - 1600 A | | 15 VA | PACT MCR-V2-6015- 85-1600-5A-1 | 2277983 | 1 |
| Current transformers , pay attention to the following order key for determining the desired current transformer type | | | | | |
| PACT MCR-V2- 6015- 85 | | | | 2277336 | 1 |
| Accessories | | | | | |
| Quick-action mechanism; width of the holding latch 16 mm | | | | | |
| Fixing pin length 40 mm | | | PACT-FAST-MNT-W16-L40 | 2276638 | 1 |
| Quick-action mechanism; width of the holding latch 16 mm | | | | | |
| Fixing pin length 65 mm | | | PACT-FAST-MNT-W16-L65 | 2276641 | 1 |

Add order key from the selection table (ordering example marked in orange)

| | | | | |
|-----------|--------------------------|----------------------------|-------|-------------------|
| Order No. | Primary current I_{pn} | Secondary current I_{sn} | Class | Rated power S_n |
| 2277336 | IP05000 | IS01 | C10 | P375 |

Selection table PACT MCR-V2-6015-85 (Order No.: 2277336)

| I_{sn} | Cl. | Primary rated current amperage I_{pn} [A] | | | | | | | | | | | Rated power S_n [VA] | |
|---------------------|--------------------|---|------|------|------|------|-----|-----|-----|------|------|------|------------------------|------|
| | | 200 | 250 | 300 | 400 | 500 | 600 | 750 | 800 | 1000 | 1250 | 1500 | | 1600 |
| IS01 \cong 1 A | C05 \cong 0.5 | | 1.25 | 1.25 | 1.25 | 2.5 | 2.5 | 2.5 | 2.5 | 2.5 | 5 | 5 | 5 | 5 |
| | C10 \cong 1 | 2.5 | 2.5 | 2.5 | 2.5 | 3.75 | 2.5 | 2.5 | 2.5 | 2.5 | 2.5 | 5 | 5 | 5 |
| IS05 \cong 5 A | C05 \cong 0.5 | | 1.25 | 1.25 | 1.25 | 2.5 | 2.5 | 2.5 | 2.5 | 2.5 | 5 | 5 | 5 | 5 |
| | C10 \cong 1 | 2.5 | 2.5 | 2.5 | 2.5 | 5 | 5 | 5 | 5 | 5 | 10 | 10 | 10 | 10 |

Monitoring

Current transformers

Current transformers

PACT MCR-V2-6315-95

- Primary rated current I_{pn} : 0...(200...2500) A
- Round conductor dimensions: \varnothing 53 mm
- Rail dimensions:
63x15 mm
2x 50x10 mm
40x40 mm



Plug-in curr. transformer, official calibration as an option

PACT MCR-V2-6040-96

- Primary rated current I_{pn} : 0...(200...2000) A
- Round conductor dimensions: \varnothing 61 mm
- Rail dimensions:
60x40 mm; 50x50 mm



Plug-in curr. transformer, official calibration as an option

Notes:
Our configurator, which is available at www.phoenixcontact.net/products, makes ordering easy.
Current transformers that support official calibration: To specify the type of current transformer you require, please use the order key on page 225
The relevant installation accessories can be found on page 223

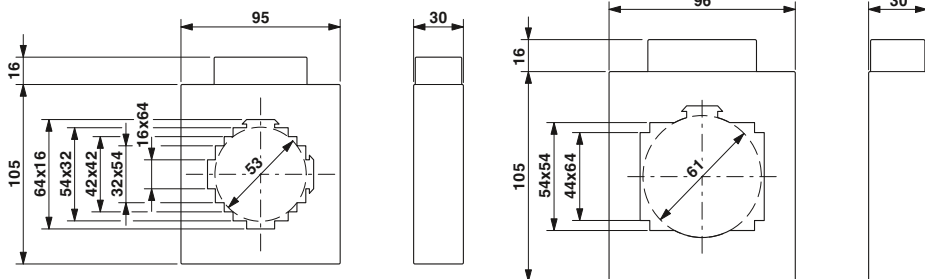

| Description | Rated power S_n |
|---|-------------------|
| Preferred versions available from stock (marked in green in the selection table) Primary rated current I_{pn} : | |
| - 600 A | 10 VA |
| - 750 A | 10 VA |
| - 800 A | 10 VA |
| - 1000 A | 10 VA |
| - 1250 A | 10 VA |
| - 1250 A | 15 VA |
| - 1500 A | 10 VA |
| - 1600 A | 10 VA |
| - 1600 A | 15 VA |
| - 2000 A | 15 VA |
| Current transformers , pay attention to the following order key for determining the desired current transformer type | |

| Ordering data | | |
|-------------------------------|----------------|-------------|
| Type | Order No. | Pcs. / Pkt. |
| PACT MCR-V2-6315-95-800-5A-1 | 2277213 | 1 |
| PACT MCR-V2-6315-95-1000-5A-1 | 2277226 | 1 |
| PACT MCR-V2-6315-95-1250-5A-1 | 2277239 | 1 |
| PACT MCR-V2-6315-95-1500-5A-1 | 2277242 | 1 |
| PACT MCR-V2-6315-95-1600-5A-1 | 2277255 | 1 |
| PACT MCR-V2- 6315- 95 | 2277307 | 1 |

| Ordering data | | |
|-------------------------------|----------------|-------------|
| Type | Order No. | Pcs. / Pkt. |
| PACT MCR-V2-6040-96-600-5A-1 | 2276191 | 1 |
| PACT MCR-V2-6040-96-750-5A-1 | 2276201 | 1 |
| PACT MCR-V2-6040-96-800-5A-1 | 2276214 | 1 |
| PACT MCR-V2-6040-96-1000-5A-1 | 2277705 | 1 |
| PACT MCR-V2-6040-96-1250-5A-1 | 2276227 | 1 |
| PACT MCR-V2-6040-96-1500-5A-1 | 2277718 | 1 |
| PACT MCR-V2-6040-96-1600-5A-1 | 2276230 | 1 |
| PACT MCR-V2-6040-96-2000-5A-1 | 2276243 | 1 |
| PACT MCR-V2- 6040- 96 | 2277349 | 1 |

Quick-action mechanism; width of the holding latch 16 mm
Fixing pin length 40 mm
Quick-action mechanism; width of the holding latch 16 mm
Fixing pin length 65 mm

| Accessories | | |
|-----------------------|-----------|-------------|
| Type | Order No. | Pcs. / Pkt. |
| PACT-FAST-MNT-W16-L40 | 2276638 | 1 |
| PACT-FAST-MNT-W16-L65 | 2276641 | 1 |

| Accessories | | |
|-----------------------|-----------|-------------|
| Type | Order No. | Pcs. / Pkt. |
| PACT-FAST-MNT-W16-L40 | 2276638 | 1 |
| PACT-FAST-MNT-W16-L65 | 2276641 | 1 |

Add **order key** from the selection table (ordering example marked in orange)

| Order No. | Primary current I_{pn} | Secondary current I_{sn} | Class | Rated power S_n |
|-----------|--------------------------|----------------------------|-------|-------------------|
| 2277307 | IP25000 | IS05 | C05 | P500 |

Selection table PACT MCR-V2-6315-95 (Order No.: 2277307)

| I_{sn} | Cl. | Primary rated current amperage I_{pn} [A] | | | | | | | | | | | | | Rated power S_n [VA] | | |
|---------------------|--------------------|---|-----|-----|-----|-----|-----|-----|-----|------|------|------|------|------|------------------------|------|----|
| | | 200 | 250 | 300 | 400 | 500 | 600 | 750 | 800 | 1000 | 1250 | 1500 | 1600 | 2000 | | 2500 | |
| IS01 \cong 1 A | C05 \cong 0.5 | 2.5 | 2.5 | 2.5 | 2.5 | 2.5 | 2.5 | 5 | 5 | 5 | 5 | 5 | 5 | 5 | 5 | 5 | 10 |
| | C10 \cong 1 | 3.75 | 5 | 5 | 5 | 5 | 5 | 10 | 10 | 10 | 10 | 10 | 10 | 10 | 15 | 15 | |
| IS05 \cong 5 A | C05 \cong 0.5 | 2.5 | 2.5 | 2.5 | 2.5 | 2.5 | 2.5 | 5 | 5 | 5 | 5 | 5 | 5 | 5 | 5 | 5 | 15 |
| | C10 \cong 1 | 3.75 | 5 | 5 | 5 | 5 | 5 | 10 | 10 | 10 | 10 | 10 | 10 | 10 | 15 | 15 | |

Selection table PACT MCR-V2-6040-96 (Order No.: 2277349)

| I_{sn} | Cl. | Primary rated current amperage I_{pn} [A] | | | | | | | | | | | | | Rated power S_n [VA] | | |
|---------------------|--------------------|---|------|-----|-----|-----|-----|-----|-----|------|------|------|------|------|------------------------|----|----|
| | | 200 | 250 | 300 | 400 | 500 | 600 | 750 | 800 | 1000 | 1250 | 1500 | 1600 | 2000 | | | |
| IS01 \cong 1 A | C05 \cong 0.5 | 2.5 | 2.5 | 2.5 | 2.5 | 2.5 | 2.5 | 5 | 5 | 5 | 5 | 5 | 5 | 5 | 5 | 5 | 10 |
| | C10 \cong 1 | 3.75 | 5 | 5 | 5 | 5 | 5 | 10 | 10 | 10 | 10 | 10 | 10 | 10 | 15 | 15 | |
| IS05 \cong 5 A | C05 \cong 0.5 | 2.5 | 2.5 | 2.5 | 2.5 | 2.5 | 2.5 | 5 | 5 | 5 | 5 | 5 | 5 | 5 | 5 | 5 | 15 |
| | C10 \cong 1 | 3.75 | 3.75 | 5 | 5 | 5 | 5 | 10 | 10 | 10 | 10 | 10 | 10 | 10 | 15 | 15 | |

Current transformers

PACT MCR-V2-8015-105

- Primary rated current I_{pn} : 0...(400...2500) A
- Round conductor dimensions: \varnothing 61 mm
- Rail dimensions: 80x15 mm; 2x 60x10 mm; 3x 50x10 mm

PACT MCR-V2-8020-105

- Primary rated current I_{pn} : 0...(500...2000) A
- Round conductor dimensions: \varnothing 70 mm
- Rail dimensions: 2x 80x10 mm; 60x60 mm



Plug-in curr. transformer, official calibration as an option



Plug-in curr. transformer, official calibration as an option

Notes:
 Our configurator, which is available at www.phoenixcontact.net/products, makes ordering easy.
 Current transformers that support official calibration: To specify the type of current transformer you require, please use the order key on page 225
 The relevant installation accessories can be found on page 223

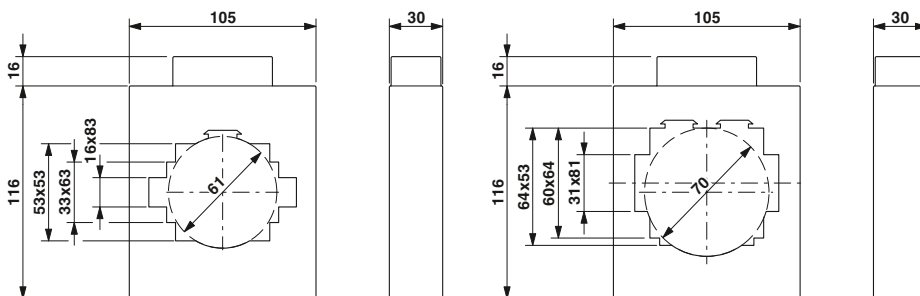

| Description | Rated power S_n |
|---|-------------------|
| Preferred versions available from stock (marked in green in the selection table) | |
| Primary rated current I_{pn} : | |
| - 400 A | 7.5 VA |
| - 500 A | 10 VA |
| - 600 A | 10 VA |
| - 750 A | 10 VA |
| - 800 A | 15 VA |
| - 1000 A | 10 VA |
| - 1000 A | 15 VA |
| - 1250 A | 10 VA |
| - 1500 A | 15 VA |
| - 1600 A | 15 VA |
| - 2000 A | 10 VA |
| - 2000 A | 20 VA |
| - 2500 A | 20 VA |
| Current transformers , pay attention to the following order key for determining the desired current transformer type | |

| Ordering data | | |
|--------------------------------|----------------|-------------|
| Type | Order No. | Pcs. / Pkt. |
| PACT MCR-V2-8015-105- 400-5A-1 | 2276256 | 1 |
| PACT MCR-V2-8015-105- 500-5A-1 | 2276269 | 1 |
| PACT MCR-V2-8015-105- 600-5A-1 | 2276272 | 1 |
| PACT MCR-V2-8015-105- 750-5A-1 | 2276285 | 1 |
| PACT MCR-V2-8015-105- 800-5A-1 | 2276298 | 1 |
| PACT MCR-V2-8015-105-1000-5A-1 | 2277721 | 1 |
| PACT MCR-V2-8015-105-1000-5A-1 | 2276308 | 1 |
| PACT MCR-V2-8015-105-1250-5A-1 | 2276311 | 1 |
| PACT MCR-V2-8015-105-1500-5A-1 | 2277734 | 1 |
| PACT MCR-V2-8015-105-1600-5A-1 | 2276324 | 1 |
| PACT MCR-V2-8015-105-2000-5A-1 | 2276337 | 1 |
| PACT MCR-V2-8015-105-2500-5A-1 | 2276340 | 1 |
| PACT MCR-V2- 8015-105 | 2277352 | 1 |

| Ordering data | | |
|--------------------------------|----------------|-------------|
| Type | Order No. | Pcs. / Pkt. |
| PACT MCR-V2-8020-105-1000-5A-1 | 2277747 | 1 |
| PACT MCR-V2-8020-105-1500-5A-1 | 2277750 | 1 |
| PACT MCR-V2-8020-105-2000-5A-1 | 2276382 | 1 |
| PACT MCR-V2- 8020-105 | 2277365 | 1 |

Add **order key** from the selection table (ordering example marked in orange)

| Order No. | Primary current I_{pn} | Secondary current I_{sn} | Class | Rated power S_n |
|-----------|--------------------------|----------------------------|-------|-------------------|
| 2277352 | IP25000 | IS05 | C10 | P3000 |

Selection table PACT MCR-V2-8015-105 (Order No.: 2277352)

| I_{sn} | Cl. | Primary rated current amperage I_{pn} [A] | | | | | | | | | | | Rated power S_n [VA] | | |
|-----------------------|----------------------|---|-----|-----|-----|-----|------|------|------|------|------|------|------------------------|----|--|
| | | 400 | 500 | 600 | 750 | 800 | 1000 | 1250 | 1500 | 1600 | 2000 | 2500 | | | |
| IS01 ≈ 1 A | C05 ≈ 0.5 | 2.5 | 2.5 | 2.5 | 2.5 | 2.5 | 2.5 | 2.5 | 2.5 | 2.5 | 5 | | | | |
| | C10 ≈ 1 | 5 | 5 | 5 | 5 | 5 | 5 | 5 | 5 | 10 | 10 | 15 | | | |
| | | 7.5 | 10 | 10 | 10 | 10 | 10 | 10 | 15 | 15 | 20 | 20 | 25 | | |
| IS05 ≈ 5 A | C05 ≈ 0.5 | 2.5 | 2.5 | 2.5 | 2.5 | 2.5 | 5 | 2.5 | 2.5 | 2.5 | 2.5 | 5 | | | |
| | C10 ≈ 1 | 5 | 5 | 5 | 5 | 10 | 10 | 5 | 5 | 5 | 10 | 10 | 15 | | |
| | | 7.5 | 10 | 10 | 10 | 15 | 15 | 10 | 10 | 15 | 15 | 20 | 20 | 30 | |

Selection table PACT MCR-V2-8020-105 (Order No.: 2277365)

| I_{sn} | Cl. | Primary rated current amperage I_{pn} [A] | | | | | | | | | Rated power S_n [VA] | | | | |
|-----------------------|----------------------|---|-----|-----|-----|------|------|------|------|------|------------------------|-----|-----|--|--|
| | | 500 | 600 | 750 | 800 | 1000 | 1250 | 1500 | 1600 | 2000 | | | | | |
| IS01 ≈ 1 A | C05 ≈ 0.5 | 2.5 | 2.5 | 2.5 | 2.5 | 2.5 | 2.5 | 2.5 | 2.5 | 2.5 | | | | | |
| | C10 ≈ 1 | 5 | 5 | 5 | 5 | 5 | 5 | 5 | 5 | 5 | | | | | |
| | | 7.5 | 7.5 | 7.5 | 7.5 | 10 | 10 | 10 | 10 | 10 | 15 | | | | |
| IS05 ≈ 5 A | C05 ≈ 0.5 | 2.5 | 2.5 | 2.5 | 2.5 | 2.5 | 2.5 | 2.5 | 2.5 | 2.5 | 2.5 | 2.5 | 2.5 | | |
| | C10 ≈ 1 | 5 | 5 | 5 | 5 | 5 | 5 | 5 | 5 | 5 | 5 | 5 | 5 | | |
| | | 7.5 | 7.5 | 7.5 | 7.5 | 10 | 10 | 10 | 10 | 10 | 10 | 15 | 15 | | |

Monitoring

Current transformers

Current transformers

PACT MCR-V2-10020-129

- Primary rated current I_{pn} : 0...(400...4000) A
- Round conductor dimensions: \varnothing 85 mm
- Rail dimensions: 2x 100x10 mm; 80x64 mm

PACT MCR-V2-10036-129

- Primary rated current I_{pn} : 0...(400...4000) A
- Rail dimensions: 3x 100x12 mm



Plug-in curr. transformer, official calibration as an option



Plug-in curr. transformer, official calibration as an option

Notes:
 Our configurator, which is available at www.phoenixcontact.net/products, makes ordering easy.
 Current transformers that support official calibration: To specify the type of current transformer you require, please use the order key on page 225
 The relevant installation accessories can be found on page 223

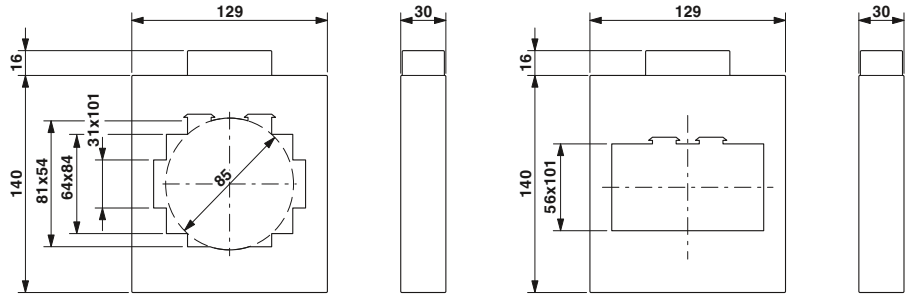

| Description | Rated power S_n |
|---|-------------------|
| Preferred versions available from stock (marked in green in the selection table) Primary rated current I_{pn} : - 2500 A - 3000 A | 15 VA 15 VA |
| Current transformers , pay attention to the following order key for determining the desired current transformer type | |

| Ordering data | | |
|-------------------------------|-----------|-------------|
| Type | Order No. | Pcs. / Pkt. |
| PACT MCR-V2-10020-129-2500-5A | 2276395 | 1 |
| PACT MCR-V2-10020-129 | 2277378 | 1 |

| Ordering data | | |
|-------------------------------|-----------|-------------|
| Type | Order No. | Pcs. / Pkt. |
| PACT MCR-V2-10036-129-3000-5A | 2276405 | 1 |
| PACT MCR-V2-10036-129 | 2277381 | 1 |

Add **order key** from the selection table (ordering example marked in orange)

| Order No. | Primary current I_{pn} | Secondary current I_{sn} | Class | Rated power S_n |
|-----------|--------------------------|----------------------------|-------|-------------------|
| 2277378 | IP40000 | IS05 | C05 | P2500 |

Selection table PACT MCR-V2-10020-129 (Order No.: 2277378)

| I_{sn} | Cl. | Primary rated current amperage I_{pn} [A] | | | | | | | | | | | | Rated power S_n [VA] | | | | | | | | |
|--------------------|-------------------|---|-----|-----|-----|-----|------|------|------|------|------|------|------|------------------------|------|----|----|----|----|----|----|----|
| | | 400 | 500 | 600 | 750 | 800 | 1000 | 1250 | 1500 | 1600 | 2000 | 2500 | 3000 | | 4000 | | | | | | | |
| IS01 ≥ 1 A | C05 ≥ 0.5 | | 5 | 10 | 10 | 10 | 10 | 10 | 10 | 10 | 10 | 10 | 10 | 10 | 15 | 15 | 15 | 15 | 15 | 15 | 20 | 20 |
| | C10 ≥ 1 | 2.5 | 2.5 | 5 | 5 | 5 | 5 | 5 | 5 | 5 | 5 | 5 | 5 | 5 | 5 | 5 | 5 | 5 | 5 | 5 | 25 | 30 |
| IS05 ≥ 5 A | C05 ≥ 0.5 | | 5 | 5 | 10 | 10 | 10 | 10 | 10 | 10 | 10 | 10 | 10 | 10 | 10 | 10 | 10 | 10 | 10 | 10 | 20 | 20 |
| | C10 ≥ 1 | 2.5 | 2.5 | 5 | 5 | 5 | 5 | 5 | 5 | 5 | 5 | 5 | 5 | 5 | 5 | 5 | 5 | 5 | 5 | 5 | 25 | 30 |

Selection table PACT MCR-V2-10036-129 (Order No.: 2277381)

| I_{sn} | Cl. | Primary rated current amperage I_{pn} [A] | | | | | | | | | | | | Rated power S_n [VA] | | | | | | | | |
|--------------------|-------------------|---|-----|-----|-----|-----|------|------|------|------|------|------|------|------------------------|------|----|----|----|----|----|----|----|
| | | 400 | 500 | 600 | 750 | 800 | 1000 | 1250 | 1500 | 1600 | 2000 | 2500 | 3000 | | 4000 | | | | | | | |
| IS01 ≥ 1 A | C05 ≥ 0.5 | | 5 | 10 | 10 | 10 | 10 | 10 | 10 | 10 | 10 | 10 | 10 | 10 | 10 | 10 | 10 | 10 | 10 | 10 | 15 | 15 |
| | C10 ≥ 1 | 2.5 | 2.5 | 5 | 5 | 5 | 5 | 5 | 5 | 5 | 5 | 5 | 5 | 5 | 5 | 5 | 5 | 5 | 5 | 5 | 25 | 30 |
| IS05 ≥ 5 A | C05 ≥ 0.5 | | 5 | 5 | 10 | 10 | 10 | 10 | 10 | 10 | 10 | 10 | 10 | 10 | 10 | 10 | 10 | 10 | 10 | 10 | 20 | 20 |
| | C10 ≥ 1 | 2.5 | 2.5 | 5 | 5 | 5 | 5 | 5 | 5 | 5 | 5 | 5 | 5 | 5 | 5 | 5 | 5 | 5 | 5 | 5 | 25 | 30 |

Current transformers

PACT MCR-V2-12020-159

- Primary rated current I_{pn} : 0...(400...4000) A
- Round conductor dimensions: \varnothing 96 mm
- Rail dimensions: 2x 120x10 mm; 3x 100x10 mm; 80x80 mm

PACT MCR-V2-12040-159

- Primary rated current I_{pn} : 0...(400...4000) A
- Rail dimensions: 4x 120x10 mm



Plug-in current transformer



Plug-in current transformer

Notes:
 Our configurator, which is available at www.phoenixcontact.net/products, makes ordering easy.
 The relevant installation accessories can be found on page 223



| Description | Rated power S_n |
|--|-------------------|
| Preferred versions available from stock (marked in green in the selection table) Primary rated current I_{pn} : - 4000 A | 15 VA |
| Current transformers , pay attention to the following order key for determining the desired current transformer type | |

| Ordering data | | |
|-----------------------|-----------|-------------|
| Type | Order No. | Pcs. / Pkt. |
| PACT MCR-V2-12020-159 | 2277394 | 1 |

| Ordering data | | |
|-------------------------------|-----------|-------------|
| Type | Order No. | Pcs. / Pkt. |
| PACT MCR-V2-12040-159-4000-5A | 2276418 | 1 |
| PACT MCR-V2-12040-159 | 2277404 | 1 |

Add **order key** from the selection table (ordering example marked in orange)

| Order No. | Primary current I_{pn} | Secondary current I_{sn} | Class | Rated power |
|-----------|--------------------------|----------------------------|-------|-------------|
| 2277404 | IP08000 | IS01 | C05 | P250 |

Selection table PACT MCR-V2-12020-159 (Order No.: 2277394)

| I_{sn} | Cl. | Primary rated current amperage I_{pn} [A] | | | | | | | | | | | | | Rated power S_n [VA] |
|---------------|--------------|---|-----|-----|-----|-----|------|------|------|------|------|------|------|------|------------------------|
| | | 400 | 500 | 600 | 750 | 800 | 1000 | 1250 | 1500 | 1600 | 2000 | 2500 | 3000 | 4000 | |
| IS01 ≅ 1A | C05 ≅ 0.5 | 2.5 | 2.5 | 2.5 | 2.5 | 2.5 | 2.5 | 5 | 5 | 5 | 5 | 5 | 5 | 10 | 15 VA |
| | | 5 | 5 | 5 | 5 | 5 | 5 | 10 | 10 | 10 | 10 | 10 | 10 | 15 | |
| | 10 | 10 | 10 | 10 | 10 | 10 | 15 | 15 | 15 | 15 | 15 | 15 | 30 | | |
| | 15 | 20 | 20 | 15 | 20 | 30 | 30 | 30 | 30 | 30 | 30 | 45 | 45 | | |
| C10 ≅ 1 | C05 ≅ 0.5 | 2.5 | 5 | 5 | 2.5 | 2.5 | 5 | 5 | 5 | 5 | 5 | 5 | 10 | 10 | 15 VA |
| | | 5 | 10 | 10 | 5 | 5 | 10 | 10 | 10 | 10 | 10 | 10 | 10 | 15 | |
| | 10 | 15 | 15 | 10 | 10 | 15 | 15 | 15 | 15 | 15 | 15 | 30 | 30 | | |
| | 15 | 20 | 20 | 15 | 20 | 30 | 30 | 30 | 30 | 30 | 30 | 45 | 45 | | |
| IS05 ≅ 5 A | C05 ≅ 0.5 | 2.5 | 2.5 | 2.5 | 2.5 | 2.5 | 5 | 5 | 10 | 5 | 5 | 5 | 10 | 10 | 15 VA |
| | | 5 | 5 | 5 | 5 | 5 | 10 | 10 | 15 | 10 | 10 | 10 | 15 | 15 | |
| | 10 | 10 | 10 | 10 | 10 | 15 | 15 | 30 | 15 | 15 | 15 | 30 | 30 | | |
| | 15 | 15 | 30 | 30 | 45 | 30 | 30 | 30 | 30 | 30 | 45 | 45 | | | |
| C10 ≅ 1 | C05 ≅ 0.5 | 2.5 | 5 | 5 | 5 | 5 | 5 | 10 | 5 | 5 | 5 | 10 | 10 | 10 | 15 VA |
| | | 5 | 10 | 10 | 10 | 10 | 10 | 15 | 10 | 10 | 10 | 15 | 15 | 15 | |
| | 10 | 15 | 15 | 15 | 15 | 15 | 30 | 15 | 15 | 15 | 30 | 30 | 30 | | |
| | 15 | 20 | 20 | 20 | 30 | 30 | 45 | 30 | 30 | 30 | 45 | 45 | 45 | | |

Selection table PACT MCR-V2-12040-159 (Order No.: 2277404)

| I_{sn} | Cl. | Primary rated current amperage I_{pn} [A] | | | | | | | | | | | | | Rated power S_n [VA] |
|---------------|--------------|---|-----|-----|-----|-----|------|------|------|------|------|------|------|------|------------------------|
| | | 400 | 500 | 600 | 750 | 800 | 1000 | 1250 | 1500 | 1600 | 2000 | 2500 | 3000 | 4000 | |
| IS01 ≅ 1A | C05 ≅ 0.5 | 2.5 | 2.5 | 2.5 | 2.5 | 2.5 | 5 | 5 | 5 | 5 | 5 | 5 | 10 | 10 | 15 VA |
| | | 5 | 5 | 5 | 5 | 5 | 5 | 10 | 10 | 10 | 10 | 10 | 10 | 15 | |
| | 10 | 10 | 10 | 10 | 10 | 15 | 15 | 15 | 15 | 15 | 15 | 15 | 30 | | |
| | 15 | 20 | 20 | 15 | 20 | 30 | 30 | 30 | 30 | 30 | 30 | 45 | 45 | | |
| C10 ≅ 1 | C05 ≅ 0.5 | 2.5 | 5 | 5 | 2.5 | 2.5 | 5 | 5 | 5 | 5 | 5 | 5 | 10 | 10 | 15 VA |
| | | 5 | 10 | 10 | 5 | 5 | 10 | 10 | 10 | 10 | 10 | 10 | 10 | 15 | |
| | 10 | 15 | 15 | 10 | 10 | 15 | 15 | 15 | 15 | 15 | 15 | 30 | 30 | | |
| | 15 | 20 | 20 | 15 | 20 | 30 | 30 | 30 | 30 | 30 | 30 | 45 | 45 | | |
| IS05 ≅ 5 A | C05 ≅ 0.5 | 2.5 | 2.5 | 2.5 | 2.5 | 2.5 | 5 | 5 | 10 | 5 | 5 | 5 | 10 | 10 | 15 VA |
| | | 5 | 5 | 5 | 5 | 5 | 10 | 10 | 15 | 10 | 10 | 10 | 15 | 15 | |
| | 10 | 10 | 10 | 10 | 10 | 15 | 15 | 30 | 15 | 15 | 15 | 30 | 30 | | |
| | 15 | 15 | 30 | 30 | 45 | 30 | 30 | 30 | 30 | 30 | 45 | 45 | | | |
| C10 ≅ 1 | C05 ≅ 0.5 | 2.5 | 5 | 5 | 5 | 5 | 5 | 10 | 5 | 5 | 5 | 10 | 10 | 10 | 15 VA |
| | | 5 | 10 | 10 | 10 | 10 | 10 | 15 | 10 | 10 | 10 | 15 | 15 | 15 | |
| | 10 | 15 | 15 | 15 | 15 | 15 | 30 | 15 | 15 | 15 | 30 | 30 | 30 | | |
| | 15 | 20 | 20 | 20 | 30 | 30 | 45 | 30 | 30 | 30 | 45 | 45 | 45 | | |

Monitoring

Current transformers

Current transformers

PACT MCR-V3-60

– Primary rated current I_{pn} :
0...(1...40) A

– Current-carrying copper lines connected directly to the screw terminal blocks on the primary side

Notes:
Our configurator, which is available at www.phoenixcontact.net/products, makes ordering easy.
The relevant installation accessories can be found on page 223

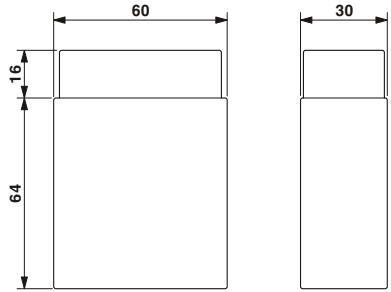

Winding current transformer

| Ordering data | | |
|----------------|-----------|-------------|
| Type | Order No. | Pcs. / Pkt. |
| PACT MCR-V3-60 | 2277417 | 1 |

Description
Current transformers, pay attention to the following order key for determining the desired current transformer type

Add order key from the selection table (ordering example marked in orange)

| Order No. | Primary current I_{pn} | Secondary current I_{sn} | Class | Rated power S_n |
|-----------|--------------------------|----------------------------|-------|-------------------|
| 2277417 | IP00025 | IS01 | C10 | P250 |

Selection table PACT MCR-V3-60 (Order No.: 2277417)

| I_{sn} | Cl. | Primary rated current strength I_{pn} [A] | | | | | | | | | | | | | | Rated power S_n [VA] | |
|---------------|--------------|---|-----|-----|-----|-----|-----|-----|-----|------|-----|-----|-----|-----|-----|------------------------|-----|
| | | 1 | 2 | 2.5 | 4 | 5 | 6 | 7.5 | 10 | 12.5 | 15 | 20 | 25 | 30 | 40 | | |
| IS01 ≅ 1 A | C05 ≅ 0.5 | 2.5 | 2.5 | 2.5 | 2.5 | 2.5 | 2.5 | 2.5 | 2.5 | 2.5 | 2.5 | 2.5 | 2.5 | 2.5 | 2.5 | 2.5 | 250 |
| | C10 ≅ 1 | 5 | 5 | 5 | 5 | 5 | 5 | 5 | 5 | 5 | 5 | 5 | 5 | 5 | 5 | 5 | |
| IS05 ≅ 5 A | C05 ≅ 0.5 | 2.5 | 2.5 | 2.5 | 2.5 | 2.5 | 2.5 | 2.5 | 2.5 | 2.5 | 2.5 | 2.5 | 2.5 | 2.5 | 2.5 | 2.5 | |
| | C10 ≅ 1 | 5 | 5 | 5 | 5 | 5 | 5 | 5 | 5 | 5 | 5 | 5 | 5 | 5 | 5 | 5 | |

Quick-action mechanism for PACT current transformers

- No tools necessary for mounting
- Extremely easy handling, thanks to secure fastening by pressing with finger
- Set consisting of two fixing pins and a holding latch

Notes:

The 16 mm wide quick-action mechanism can also be used for larger current transformers if the length of the fixing pins is sufficient.



for: ...V2-4012-70..., ...V2-5012-85...



for: ...V2-3015-60..., ...V2-6015-85..., ...V2-6315-95...

Technical data

| | |
|---------------------------------|-----------------|
| Material | PA 6 |
| Ambient temperature (operation) | -25°C ... 120°C |

Ordering data

| Type | Order No. | Pcs. / Pkt. |
|-----------------------|-----------|-------------|
| PACT-FAST-MNT-W13-L65 | 2276625 | 1 |
| PACT-FAST-MNT-W13-L40 | 2276612 | 1 |

Technical data

| | |
|---------------------------------|-----------------|
| Material | PA 6 |
| Ambient temperature (operation) | -25°C ... 120°C |

Ordering data

| Type | Order No. | Pcs. / Pkt. |
|-----------------------|-----------|-------------|
| PACT-FAST-MNT-W16-L65 | 2276641 | 1 |
| PACT-FAST-MNT-W16-L40 | 2276638 | 1 |

General data

| | |
|---------------------------------|-----------------|
| Material | PA 6 |
| Ambient temperature (operation) | -25°C ... 120°C |

Description

Quick-action mechanism; width of the holding latch 13 mm

Fixing pin length 65 mm

Fixing pin length 40 mm

Quick-action mechanism; width of the holding latch 16 mm

Fixing pin length 65 mm

Fixing pin length 40 mm

Accessories

- Copper sleeves
- DIN rail adapter
- Secondary terminal cover
- Insulating caps



Copper sleeves
DIN rail adapter

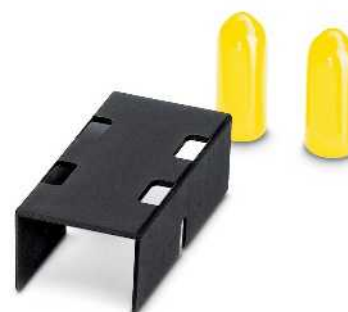

Secondary terminal cover
Insulating caps

Ordering data

| Type | Order No. | Pcs. / Pkt. |
|-------------------|-----------|-------------|
| PACT MCR-CB-21- 8 | 2277569 | 1 |
| PACT MCR-CB-21-12 | 2277556 | 1 |
| PACT MCR-CB-28-12 | 2277543 | 1 |
| PACT MCR-CB-42-12 | 2277530 | 1 |
| PACT MCR-RA | 2277598 | 12 |

Ordering data

| Type | Order No. | Pcs. / Pkt. |
|-----------------|-----------|-------------|
| PACT MCR-ETC-60 | 2277572 | 9 |
| PACT MCR-ETC-75 | 2277585 | 9 |
| PACT MCR-ICAP | 2277608 | 18 |

Description

Copper sleeves, for establishing a conductive connection during the horizontal assembly of PACT analog current transformers. The size of the copper sleeve depends on the diameter of the inner hole of the current transformer.

- for PACT MCR-V1-21-44-... Ø 21/8 mm

- for PACT MCR-V1-21-44-... Ø 21/12 mm

- for PACT MCR-V2-3015-60-... Ø 28/12 mm

- for PACT MCR-V2-5012-85-... Ø 42/12 mm

DIN rail adapter

Secondary terminal cover, for increasing the clearances and creepage distances

Length: 60 mm

Length: 75 mm

Insulating caps, for protection against unintended contact with mounting screws of the primary rail

Current transformers

Calibratable current transformers - order key and selection tables

Add **order key** from the relevant selection table (ordering examples are marked in orange)

| Order No. | Primary current I_{pn} | Secondary current I_{sn} | Class | Rated power S_n | Calibration | Calibration certificate |
|-----------|---|----------------------------|--|--|---|---|
| | IP01500 ≙ 150 A IP02000 ≙ 200 A IP02500 ≙ 250 A IP03000 ≙ 300 A IP04000 ≙ 400 A IP05000 ≙ 500 A IP06000 ≙ 600 A IP07500 ≙ 750 A IP08000 ≙ 800 A IP10000 ≙ 1000 A IP12000 ≙ 1200 A IP12500 ≙ 1250 A IP15000 ≙ 1500 A IP16000 ≙ 1600 A IP20000 ≙ 2000 A IP25000 ≙ 2500 A | IS05 ≙ 5 A | C02S ≙ 0.2S C02 ≙ 0.2 C05S ≙ 0.5S C05 ≙ 0.5 | P250 ≙ 2.5 VA P500 ≙ 5.0 VA P1000 ≙ 10 VA P1500 ≙ 15 VA P2000 ≙ 20 VA P3000 ≙ 30 VA | NONE ≙ not calibrated YES ≙ calibrated | NONE ≙ no calibration certificate YES ≙ calibration certificate (a fee is charged) YESPLUS ≙ Calibration certificate with catalog of errors (5 measuring points) (a fee is charged) |

PACT MCR-V1C-21-44 (Order No.: 2277420)

You will find information about the product on page 213.

Add **order key** from the selection table

2277420 / IP03000 / IS05 / C02 / P250 / NONE / NONE

Selection table

| I_{sn} | Cl. | Primary rated current amperage I_{pn} [A] | | | | | | Rated power S_n [VA] |
|---------------|-------------------|---|-----|-----|-----|-----|-----|------------------------|
| | | 150 | 200 | 250 | 300 | 400 | 500 | |
| IS05 ≙ 5 A | C02S ≙ 0.2S | | | | | 2.5 | 2.5 | 5 |
| | C02 ≙ 0.2 | | | 2.5 | 2.5 | 2.5 | 2.5 | 5 |
| IS05 ≙ 5 A | C05S ≙ 0.5S | 2.5 | 2.5 | 2.5 | 2.5 | 2.5 | 2.5 | 10 |
| | C05 ≙ 0.5 | 2.5 | 2.5 | 2.5 | 2.5 | 2.5 | 2.5 | 10 |

PACT MCR-V2C-3015-60 (Order No.: 2277433)

You will find information about the product on page 214.

Add **order key** from the selection table

2277433 / IP02000 / IS05 / C05 / P250 / NONE / NONE

Selection table

| I_{sn} | Cl. | Primary rated current amperage I_{pn} [A] | | | | | | | Rated power S_n [VA] |
|---------------|-------------------|---|-----|-----|-----|-----|-----|-----|------------------------|
| | | 200 | 250 | 300 | 400 | 500 | 600 | 750 | |
| IS05 ≙ 5 A | C02S ≙ 0.2S | | | | | | 2.5 | 2.5 | 5 |
| | C02 ≙ 0.2 | | | | 2.5 | 2.5 | 2.5 | 2.5 | 5 |
| IS05 ≙ 5 A | C05S ≙ 0.5S | 2.5 | 2.5 | 2.5 | 2.5 | 2.5 | 2.5 | 2.5 | 15 |
| | C05 ≙ 0.5 | 2.5 | 2.5 | 2.5 | 2.5 | 2.5 | 2.5 | 2.5 | 15 |

PACT MCR-V2C-4012-70 (Order No.: 2277446)

You will find information about the product on page 215.

Add **order key** from the selection table

2277446 / IP06000 / IS05 / C02 / P1000 / NONE / NONE

Selection table

| I_{sn} | Cl. | Primary rated current amperage I_{pn} [A] | | | | | | | | Rated power S_n [VA] | |
|---------------|-------------------|---|-----|-----|-----|-----|-----|-----|-----|------------------------|------|
| | | 200 | 250 | 300 | 400 | 500 | 600 | 750 | 800 | | 1000 |
| IS05 ≙ 5 A | C02S ≙ 0.2S | | | | | | 2.5 | 2.5 | 2.5 | 5 | 5 |
| | C02 ≙ 0.2 | | | | 2.5 | 2.5 | 2.5 | 5 | 2.5 | 5 | 10 |
| IS05 ≙ 5 A | C05S ≙ 0.5S | 2.5 | 2.5 | 2.5 | 2.5 | 2.5 | 5 | 5 | 2.5 | 5 | 10 |
| | C05 ≙ 0.5 | 2.5 | 2.5 | 2.5 | 2.5 | 2.5 | 5 | 5 | 2.5 | 5 | 10 |

PACT MCR-V2C-5012-85 (Order No.: 2277459)

You will find information about the product on page 216.

Add **order key** from the selection table

2277459 / IP10000 / IS05 / C05 / P1500 / NONE / NONE

Selection table

| I_{sn} | Cl. | Primary rated current amperage I_{pn} [A] | | | | | | | | | | Rated power S_n [VA] |
|---------------|-------------------|---|-----|-----|-----|-----|-----|-----|-----|------|------|------------------------|
| | | 200 | 250 | 300 | 400 | 500 | 600 | 750 | 800 | 1000 | 1200 | |
| IS05 ≙ 5 A | C02S ≙ 0.2S | | | | | | 2.5 | 2.5 | 2.5 | 5 | 5 | 5 |
| | C02 ≙ 0.2 | | | | 2.5 | 2.5 | 2.5 | 2.5 | 2.5 | 5 | 5 | 5 |
| IS05 ≙ 5 A | C05S ≙ 0.5S | 2.5 | 2.5 | 2.5 | 2.5 | 2.5 | 5 | 5 | 5 | 5 | 5 | 5 |
| | C05 ≙ 0.5 | 2.5 | 2.5 | 2.5 | 2.5 | 2.5 | 5 | 5 | 5 | 5 | 5 | 5 |

PACT MCR-V2C-6015-85 (Order No.: 2277462)

You will find information about the product on page 217.

Add **order key** from the selection table

2277462 / IP02500 / IS05 / C05 / P250 / NONE / NONE

Selection table

| I_{sn} | Cl. | Primary rated current amperage I_{pn} [A] | | | | | | | | | | Rated power S_n [VA] |
|---------------|-------------------|---|-----|-----|-----|-----|-----|-----|------|------|-----|------------------------|
| | | 250 | 300 | 400 | 500 | 600 | 750 | 800 | 1000 | 1200 | | |
| IS05 ≙ 5 A | C02S ≙ 0.2S | | | | | | 2.5 | 2.5 | 2.5 | 2.5 | 2.5 | 2.5 |
| | C02 ≙ 0.2 | | | | 2.5 | 2.5 | 2.5 | 2.5 | 2.5 | 2.5 | 2.5 | 2.5 |
| IS05 ≙ 5 A | C05S ≙ 0.5S | 2.5 | 2.5 | 2.5 | 2.5 | 2.5 | 5 | 5 | 5 | 5 | 5 | 5 |
| | C05 ≙ 0.5 | 2.5 | 2.5 | 2.5 | 2.5 | 2.5 | 5 | 5 | 5 | 5 | 5 | 5 |

Calibratable current transformers - order key and selection tables

Add **order key** from the relevant selection table (ordering examples are marked in orange)

| Order No. | Primary current I_{pn} | Secondary current I_{sn} | Class | Rated power S_n | Calibration | Calibration certificate |
|-----------|---|----------------------------|--|--|---|---|
| | IP01500 ≙ 150 A IP02000 ≙ 200 A IP02500 ≙ 250 A IP03000 ≙ 300 A IP04000 ≙ 400 A IP05000 ≙ 500 A IP06000 ≙ 600 A IP07500 ≙ 750 A IP08000 ≙ 800 A IP10000 ≙ 1000 A IP12000 ≙ 1200 A IP12500 ≙ 1250 A IP15000 ≙ 1500 A IP16000 ≙ 1600 A IP20000 ≙ 2000 A IP25000 ≙ 2500 A | IS05 ≙ 5 A | C02S ≙ 0.2S C02 ≙ 0.2 C05S ≙ 0.5S C05 ≙ 0.5 | P250 ≙ 2.5 VA P500 ≙ 5.0 VA P1000 ≙ 10 VA P1500 ≙ 15 VA P2000 ≙ 20 VA P3000 ≙ 30 VA | NONE ≙ not calibrated YES ≙ calibrated | NONE ≙ no calibration certificate YES ≙ calibration certificate (a fee is charged) YESPLUS ≙ Calibration certificate with catalog of errors (5 measuring points) (a fee is charged) |

PACT MCR-V2C-6315-95 (Order No.: 2277475)

You will find information about the product on page 218.

Add **order key** from the selection table

2277475 / IP15000 / IS05 / C05 / P3000 / NONE / NONE

Selection table

| I_{sn} | Cl. | Primary rated current amperage I_{pn} [A] | | | | | | | | | | Rated power S_n [VA] | | | | | | |
|---------------|-------------------|---|-----|-----|-----|-----|-----|-----|-----|------|------|------------------------|------|------|----|----|----|----|
| | | 200 | 250 | 300 | 400 | 500 | 600 | 750 | 800 | 1000 | 1200 | | 1250 | 1500 | | | | |
| IS05 ≙ 5 A | C02S ≙ 0.2S | | | | | | | | | | | | 2.5 | 5 | 5 | 5 | | |
| | | | | | | | | | | | | | 5 | 10 | 10 | 10 | | |
| | C02 ≙ 0.2 | | | 2.5 | 2.5 | 2.5 | 2.5 | 2.5 | 2.5 | 5 | 5 | 5 | 5 | 5 | 5 | 10 | 10 | 10 |
| | | | | 5 | 5 | 5 | 5 | 5 | 5 | 10 | 10 | 10 | 10 | 10 | 10 | 15 | 15 | 15 |
| | C05S ≙ 0.5S | | | 2.5 | 2.5 | 2.5 | 2.5 | 2.5 | 5 | 5 | 5 | 5 | 5 | 5 | 5 | 10 | 10 | 10 |
| | | | | 5 | 5 | 5 | 5 | 5 | 10 | 10 | 10 | 10 | 10 | 10 | 10 | 15 | 15 | 15 |
| | C05 ≙ 0.5 | 2.5 | 2.5 | 2.5 | 2.5 | 2.5 | 2.5 | 5 | 5 | 5 | 5 | 5 | 5 | 5 | 5 | 10 | 10 | 10 |
| | | 5 | 5 | 5 | 5 | 5 | 5 | 10 | 10 | 10 | 10 | 10 | 10 | 10 | 10 | 15 | 15 | 15 |
| | | | | 10 | 10 | 10 | 10 | 15 | 15 | 15 | 15 | 15 | 15 | 15 | 15 | 20 | 20 | 20 |
| | | | | 15 | 15 | 15 | 20 | 30 | 30 | 30 | 30 | 30 | 30 | 30 | 30 | 30 | 30 | 30 |

PACT MCR-V2C-6040-96 (Order No.: 2277488)

You will find information about the product on page 218.

Add **order key** from the selection table

2277488 / IP12000 / IS05 / C02 / P1000 / NONE / NONE

Selection table

| I_{sn} | Cl. | Primary rated current amperage I_{pn} [A] | | | | | | | | Rated power S_n [VA] | | | |
|---------------|-------------------|---|-----|-----|-----|------|------|------|------|------------------------|-----|-----|--|
| | | 500 | 600 | 750 | 800 | 1000 | 1200 | 1250 | 1500 | | | | |
| IS05 ≙ 5 A | C02S ≙ 0.2S | | | | | | | | | 2.5 | 2.5 | 2.5 | |
| | | | | | | | | | | 5 | 5 | 5 | |
| | C02 ≙ 0.2 | | | 2.5 | 2.5 | 2.5 | 2.5 | 2.5 | 2.5 | 2.5 | 2.5 | 2.5 | |
| | | | | 5 | 5 | 5 | 5 | 5 | 5 | 5 | 5 | 5 | |
| | C05S ≙ 0.5S | 2.5 | 2.5 | 2.5 | 2.5 | 2.5 | 2.5 | 2.5 | 2.5 | 2.5 | 2.5 | 2.5 | |
| | | 5 | 5 | 5 | 5 | 5 | 5 | 5 | 5 | 5 | 5 | 5 | |
| | C05 ≙ 0.5 | 2.5 | 2.5 | 2.5 | 2.5 | 2.5 | 2.5 | 2.5 | 2.5 | 2.5 | 2.5 | 2.5 | |
| | | 5 | 5 | 5 | 5 | 5 | 5 | 5 | 5 | 5 | 5 | 5 | |
| | | | | 10 | 10 | 10 | 10 | 10 | 10 | 10 | 10 | 10 | |
| | | | | 15 | 15 | 15 | 15 | 15 | 15 | 15 | 15 | 15 | |

PACT MCR-V2C-8015-105 (Order No.: 2277491)

You will find information about the product on page 219.

Add **order key** from the selection table

2277491 / IP05000 / IS05 / C05 / P500 / NONE / NONE

Selection table

| I_{sn} | Cl. | Primary rated current amperage I_{pn} [A] | | | | | | | | | Rated power S_n [VA] | |
|---------------|-------------------|---|-----|-----|-----|-----|------|------|------|------|------------------------|-----|
| | | 400 | 500 | 600 | 750 | 800 | 1000 | 1200 | 1250 | 1500 | | |
| IS05 ≙ 5 A | C02S ≙ 0.2S | | | | | | | | | | 2.5 | |
| | | | | | | | | | | | 5 | |
| | C02 ≙ 0.2 | | | 2.5 | 2.5 | 2.5 | 2.5 | 2.5 | 2.5 | 2.5 | 2.5 | 2.5 |
| | | | | 5 | 5 | 5 | 5 | 5 | 5 | 5 | 5 | 5 |
| | C05S ≙ 0.5S | 2.5 | 2.5 | 2.5 | 2.5 | 2.5 | 2.5 | 2.5 | 2.5 | 2.5 | 2.5 | 2.5 |
| | | 5 | 5 | 5 | 5 | 5 | 5 | 5 | 5 | 5 | 5 | 5 |
| | C05 ≙ 0.5 | 2.5 | 2.5 | 2.5 | 2.5 | 2.5 | 5 | 2.5 | 2.5 | 2.5 | 2.5 | 2.5 |
| | | 5 | 5 | 5 | 5 | 5 | 5 | 5 | 5 | 5 | 5 | 5 |
| | | | | 10 | 10 | 10 | 10 | 10 | 10 | 10 | 10 | 10 |
| | | | | 15 | 15 | 20 | | | | | | 15 |

PACT MCR-V2C-8020-105 (Order No.: 2277501)

You will find information about the product on page 219.

Add **order key** from the selection table

2277501 / IP15000 / IS05 / C05S / P1000 / NONE / NONE

Selection table

| I_{sn} | Cl. | Primary rated current amperage I_{pn} [A] | | | | | | | | | Rated power S_n [VA] | |
|---------------|-------------------|---|-----|-----|-----|-----|------|------|------|------|------------------------|-----|
| | | 400 | 500 | 600 | 750 | 800 | 1000 | 1200 | 1250 | 1500 | | |
| IS05 ≙ 5 A | C02S ≙ 0.2S | | | | | | | | | | 2.5 | 2.5 |
| | | | | | | | | | | | 5 | 5 |
| | C02 ≙ 0.2 | | | 2.5 | 2.5 | 2.5 | 2.5 | 2.5 | 2.5 | 2.5 | 2.5 | 2.5 |
| | | | | 5 | 5 | 5 | 5 | 5 | 5 | 5 | 5 | 5 |
| | C05S ≙ 0.5S | 2.5 | 2.5 | 2.5 | 2.5 | 2.5 | 2.5 | 2.5 | 2.5 | 2.5 | 2.5 | 2.5 |
| | | 5 | 5 | 5 | 5 | 5 | 5 | 5 | 5 | 5 | 5 | 5 |
| | C05 ≙ 0.5 | 2.5 | 2.5 | 2.5 | 2.5 | 2.5 | 2.5 | 2.5 | 2.5 | 2.5 | 2.5 | 2.5 |
| | | 5 | 5 | 5 | 5 | 5 | 5 | 5 | 5 | 5 | 5 | 5 |
| | | | | 10 | 10 | 10 | 10 | 10 | 10 | 10 | 10 | 10 |

PACT MCR-V2C-10020-129 (Order No.: 2277514)

You will find information about the product on page 220.

Add **order key** from the selection table

2277514 / IP08000 / IS05 / C05 / P1500 / NONE / NONE

Selection table

| I_{sn} | Cl. | Primary rated current amperage I_{pn} [A] | | | | | | | | | | | Rated power S_n [VA] | | | | |
|---------------|-------------------|---|-----|-----|-----|------|------|------|------|------|------|------|------------------------|-----|-----|-----|-----|
| | | 500 | 600 | 750 | 800 | 1000 | 1200 | 1250 | 1500 | 1600 | 2000 | 2500 | | | | | |
| IS05 ≙ 5 A | C02S ≙ 0.2S | | | | | | | | | | | | 2.5 | 2.5 | 2.5 | 2.5 | |
| | | | | | | | | | | | | | 5 | 5 | 5 | 5 | |
| | C02 ≙ 0.2 | | | 2.5 | 2.5 | 2.5 | 2.5 | 2.5 | 2.5 | 2.5 | 2.5 | 2.5 | 2.5 | 2.5 | 2.5 | 2.5 | 2.5 |
| | | | | 5 | 5 | 5 | 5 | 5 | 5 | 5 | 5 | 5 | 5 | 5 | 5 | 5 | 5 |
| | C05S ≙ 0.5S | 2.5 | 2.5 | 2.5 | 2.5 | 2.5 | 2.5 | 2.5 | 2.5 | 2.5 | 2.5 | 2.5 | 2.5 | 2.5 | 2.5 | 2.5 | 2.5 |
| | | 5 | 5 | 5 | 5 | 5 | 5 | 5 | 5 | 5 | 5 | 5 | 5 | 5 | 5 | 5 | 5 |
| | C05 ≙ 0.5 | 2.5 | 2.5 | 2.5 | 2.5 | 2.5 | 2.5 | 2.5 | 2.5 | 2.5 | 2.5 | 2.5 | 2.5 | 2.5 | 2.5 | 2.5 | 2.5 |
| | | 5 | 5 | 5 | 5 | 5 | 5 | 5 | 5 | 5 | 5 | 5 | 5 | 5 | 5 | 5 | 5 |
| | | | | 10 | 10 | 10 | 10 | 10 | 10 | 10 | 10 | 10 | 10 | 10 | 10 | 10 | 10 |
| | | | | 15 | 15 | 15 | 15 | 15 | 15 | 15 | 15 | 15 | 15 | 15 | 15 | 15 | 15 |

PACT MCR-V2C-10036-129 (Order No.: 2277527)

You will find information about the product on page 220.

Add **order key** from the selection table

2277527 / IP16000 / IS05 / C05 / P500 / NONE / NONE

Selection table

| I_{sn} | Cl. | Primary rated current amperage I_{pn} [A] | | | | | | | | | | | Rated power S_n [VA] | | | | |
|---------------|-------------------|---|-----|-----|-----|------|------|------|------|------|------|------|------------------------|-----|-----|-----|-----|
| | | 500 | 600 | 750 | 800 | 1000 | 1200 | 1250 | 1500 | 1600 | 2000 | 2500 | | | | | |
| IS05 ≙ 5 A | C02S ≙ 0.2S | | | | | | | | | | | | | | | | |
| | | | | | | | | | | | | | | | | | |
| | C02 ≙ 0.2 | | | 2.5 | 2.5 | 2.5 | 2.5 | 2.5 | 2.5 | 2.5 | 2.5 | 2.5 | 2.5 | 2.5 | 2.5 | 2.5 | 2.5 |
| | | | | 5 | 5 | 5 | 5 | 5 | 5 | 5 | 5 | 5 | 5 | 5 | 5 | 5 | 5 |
| | C05S ≙ 0.5S | | | | | | | | | | | | | | | | |
| | | | | | | | | | | | | | | | | | |
| | C05 ≙ 0.5 | 2.5 | 2.5 | 2.5 | 2.5 | 2.5 | 2.5 | 2.5 | 2.5 | 2.5 | 2.5 | 2.5 | 2.5 | 2.5 | 2.5 | 2.5 | 2.5 |
| | | 5 | 5 | 5 | 5 | 5 | 5 | 5 | 5 | 5 | 5 | 5 | 5 | 5 | 5 | 5 | 5 |
| | | | | 10 | 10 | 10 | 10 | 10 | 10 | 10 | 10 | 10 | 10 | 10 | 10 | 10 | 10 |
| | | | | 15 | 15 | 15 | 15 | 15 | 15 | 15 | 15 | 15 | 15 | 15 | 15 | 15 | 15 |



With flexible power supply – current transducers up to 12 A AC

Active current transducers convert sinusoidal alternating currents up to 12 A. The integrated wide-range power supply unit enables use in various different countries.

With hinged Rogowski sensor – current transducers up to 200 A AC

The AC current transducers measure sinusoidal and non-sinusoidal alternating currents up to 200 A. The hinged Rogowski sensor ensures very easy installation, as cables that are to be measured do not have to be isolated. This enables mounting to be carried out without interruptions.

Limit value monitoring with the current protector

At the current protector, a desired amperage is specified at which a PDT contact switches a load on or off.

Flexible signal conditioning – current transducers up to 55 A AC/DC

Current transducers up to 55 A offer an infinitely adjustable measuring range. This range is mapped over the entire output signal range. This ensures extremely accurate resolution of measured values. Basic configuration can be performed quickly via the DIP switches. Additional useful device functions can be set via the software.

For high currents – current transducers up to 600 A AC/DC

The universal current transducers are the ideal solution for measuring high currents with any waveform up to 600 A AC/DC. The product range offers various different devices in graded measuring ranges with current or voltage output.

Voltage transducers, AC and DC

Voltage transducers convert AC and DC voltages into standard analog signals.



For sinusoidal alternating currents up to 12 A

- 3-way electrical isolation
- Wide-range version from 19.2 ... 253 V AC/DC
- Voltage bridging with DIN rail connector
- Input/output can be configured via DIP switches
- Suitable for potentially explosive areas, thanks to ATEX approval for Ex zone 2



For sinusoidal and non-sinusoidal alternating currents up to 200 A

- Distorted alternating currents up to 6000 Hz can be also acquired, thanks to true r.m.s. value measurement (RMS)
- Uninterrupted installation and lossless current measurement thanks to hinged Rogowski sensor
- Measuring range selection with slide switch



Limit value monitoring

- The current protector converts sinusoidal alternating currents to binary switching signals.
- Switching point can be freely selected in the measuring range of 0 ... 16 A AC
 - Changeover relay output
 - Adjustable switch hysteresis
 - 3-way isolation
 - Settable operating current/quiescent current behavior



With flexible measuring ranges for all waveforms up to 55 A

- Lossless true r.m.s. value measurement without shunt via Hall sensor (TRMS)
- Optimum mapping of the measuring range up to 55 A, thanks to software-programmable upper and lower limits
- Limit value alarm in the event of threshold value overrange or underrange up to 55 A
 - via relay or transistor output



For high currents – current transducers up to 600 A AC/DC

- Lossless true r.m.s. value measurement without shunt via Hall sensor (TRMS)
- Compact dimensions also enable distributed use
- Variable mounting on DIN rail and mounting plate
- COMBICON plug-in connection terminal blocks
- 3-way isolation
- For a conductor diameter of up to 32 mm



Voltage transducers, AC and DC

- For DC voltages from 0 ... ± 660 V DC and AC voltages from 0 ... 444 V AC
- Bidirectional output signals
- Adjustable voltage ranges
- ZERO/SPAN adjustment $\pm 20\%$
- 3-way isolation

Current acquisition

If purely ohmic loads (incandescent lamps, heaters, etc.) are operated on a conventional 230 V network, no distortions are produced on the power grid.

As non-linear loads increase as a result of phase angle-controlled regulation modules, pure sinusoidal waves gradually take on a trapezoidal waveform.

The majority of current and voltage transducers are calibrated for sinusoidal alternating currents, which means that they can only indicate the r.m.s. value of an alternating current by mean-value generation.

True r.m.s. measuring transducers do not rely on specific form factors and accept all waveforms.

r.m.s. value acquisition according to the transformer principle (RMS)

According to Faraday's law of induction, a magnetic flux which changes over time produces an induced voltage at the terminals of a coil. A circuit arrangement consisting of two electrically isolated but magnetically coupled circuits is known as a transformer. This is one of the simplest and most commonly used methods of current transfer.

Mean-value generation

r.m.s. value (root mean square value)

The r.m.s. value of an alternating current corresponds to the steady-state value that results from the instantaneous values of this current. This steady-state value generates the same thermal work in an ohmic resistor as a direct current of identical magnitude.

The term "true r.m.s. value" simply means that distorted, direct, and pulsating currents can be acquired. Here, the measuring transducer is compatible with any waveform.

For a sinusoidal AC current this means:

$$I_{\text{rms}} = \frac{I_s}{\sqrt{2}} \quad U_r = \frac{U_s}{\sqrt{2}}$$

True r.m.s. value acquisition according to the Rogowski principle (TRMS)

The Rogowski measuring principle is used to measure sinusoidal and non-sinusoidal alternating currents. A non-ferrous induction coil (air-core coil), known as the Rogowski coil, measures the magnetic voltage along a closed circumference around a live conductor.

The output signal of the Rogowski coil is then conditioned so as to obtain an exact replica of the primary current.

True r.m.s. value acquisition with a Hall sensor (TRMS)

The magnetic flux generated by the primary current I_p is condensed in the magnetic circuit and measured in the air gap using a Hall sensor. The output signal of the Hall sensor is then conditioned so as to obtain an exact replica of the primary current.

Arithmetic average value

The arithmetic average value is used to measure direct currents or filter a DC component out from a pulsating current. Applying the arithmetic average value to a symmetrical alternating current would result in a measured value of "0".

The arithmetic average value enables direct currents to be made available at the output in the form of standard analog signals. The polarity can be evaluated by means of a bipolar output signal.

For a 230 V/50 Hz power grid, this results in the following with regard to the voltage levels:

$$U_{\text{rms}} = 230 \text{ V}$$

$$U_s = 325 \text{ V}$$

$$U_{\text{avg}} = 0 \text{ V}$$

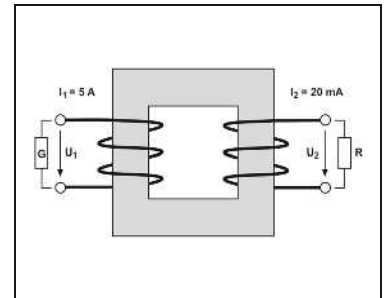

r.m.s. value acquisition according to the transformer principle (RMS)

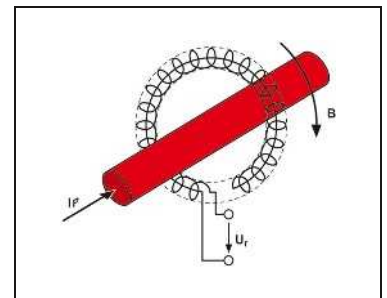

True r.m.s. value acquisition according to the Rogowski principle (TRMS)

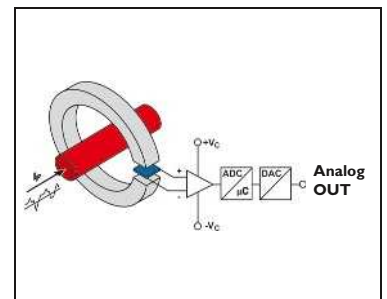

True r.m.s. value acquisition with a Hall sensor (TRMS)

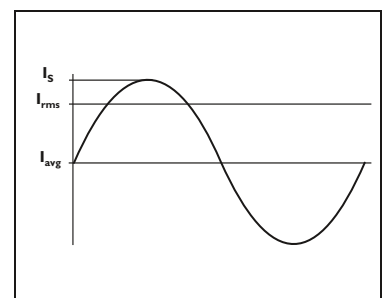

Arithmetic average value

AC/DC current transducers and distorted currents

The **MCR-SL-CUC-...** current transducers measure DC, AC, and distorted currents of 0 ... 600 A.

- Universal current measurement, no shunt required
- Compact dimensions also enable distributed use
- Variable mounting on DIN rail and mounting plate
- Simple connection method thanks to COMBICON plug-in connection terminal blocks
- 3-way isolation



For DC, AC, and distorted currents of 0 ... 300 A, voltage output



For DC, AC, and distorted currents of 0 ... 600 A, current output

Housing width 90 mm



Technical data

| | |
|---|--|
| Input data | |
| Frequency range | 20 Hz ... 6000 Hz (0 Hz) |
| Curve type | AC, DC or distorted currents |
| Connection method | Cable design: 32 mm diameter |
| Output data | |
| Output signal | 0 ... 10 V |
| Maximum output signal | |
| Load R _b | ≥ 10 kΩ |
| General data | |
| Supply voltage U _B | 20 V DC ... 30 V DC |
| Maximum transmission error | <±1% (of final value) |
| Temperature coefficient | typ. 0.02%/K (0 ... 60°C) 0.04%/K (-40 ... 65°C) |
| Step response (10 - 90%) | 150 ms |
| Safe isolation | acc. to EN 61010 |
| Rated insulation voltage | 300 V AC |
| Surge voltage category / pollution degree | III / 2 |
| Degree of protection | IP20 |
| Ambient temperature range | -40°C ... 65°C |
| Dimensions W / H / D | 90 / 33.8 / 85 mm |
| Spring-cage connection (solid/stranded/AWG) | 0.25 ... 2.5 mm ² / 0.2 ... 2.5 mm ² / 24 - 12 |
| Conformance / approvals | |
| Conformance | CE-compliant |
| UL, USA / Canada | UL/C-UL listed UL 508 |

Housing width 90 mm



Technical data

| | |
|---|--|
| Input data | |
| Frequency range | 20 Hz ... 6000 Hz (0 Hz) |
| Curve type | AC, DC or distorted currents |
| Connection method | Cable design: 32 mm diameter |
| Output data | |
| Output signal | 4 ... 20 mA |
| Maximum output signal | < 25 mA |
| Load R _b | < 300 Ω |
| General data | |
| Supply voltage U _B | 20 V DC ... 30 V DC |
| Maximum transmission error | <±1% (of final value) |
| Temperature coefficient | typ. 0.02%/K (0 ... 60°C) 0.04%/K (-40 ... 65°C) |
| Step response (10 - 90%) | 150 ms |
| Safe isolation | acc. to EN 61010 |
| Rated insulation voltage | 300 V AC |
| Surge voltage category / pollution degree | III / 2 |
| Degree of protection | IP20 |
| Ambient temperature range | -40°C ... 65°C |
| Dimensions W / H / D | 90 / 33.8 / 85 mm |
| Spring-cage connection (solid/stranded/AWG) | 0.25 ... 2.5 mm ² / 0.2 ... 2.5 mm ² / 24 - 12 |
| Conformance / approvals | |
| Conformance | CE-compliant |
| UL, USA / Canada | UL/C-UL listed UL 508 |

Ordering data

| Type | Order No. | Pcs. / Pkt. |
|------------------|-----------|-------------|
| MCR-SL-CUC-100-U | 2308108 | 1 |
| MCR-SL-CUC-200-U | 2308205 | 1 |
| MCR-SL-CUC-300-U | 2308302 | 1 |

Ordering data

| Type | Order No. | Pcs. / Pkt. |
|------------------|-----------|-------------|
| MCR-SL-CUC-100-I | 2308027 | 1 |
| MCR-SL-CUC-200-I | 2308030 | 1 |
| MCR-SL-CUC-300-I | 2308043 | 1 |
| MCR-SL-CUC-400-I | 2308072 | 1 |
| MCR-SL-CUC-500-I | 2308085 | 1 |
| MCR-SL-CUC-600-I | 2308098 | 1 |

| Description | Overload capacity |
|---|-----------------------|
| Universal current transducer | |
| Input current range: 0 ... 100 A | 6 x I _N |
| Input current range: 0 ... 200 A | 3 x I _N |
| Input current range: 0 ... 300 A | 3.33 x I _N |
| Input current range: 0 ... 400 A | 2.5 x I _N |
| Universal current transducer without UL approval | |
| Input current range: 0 ... 500 A | 3.6 x I _N |
| Input current range: 0 ... 600 A | 3 x I _N |

Monitoring

Current and voltage measuring technology

AC/DC current transducers and distorted currents

The **MCR-S...-UI(-SW)-DCI** current transducers measure direct, alternating and distorted currents.

- Device can be set via DIP switches or MCR/PI-CONF-WIN configuration software
- True r.m.s. value measurement
- 3-way isolation
- With optional relay and transistor output



For DC, AC, and distorted currents
0 ... 11 A



For DC, AC, and distorted currents
0 ... 55 A

Notes:

To order a configurable product, enter the required configuration by referring to the adjacent order key.

Further information about the configuration software can be found on page 237

1) EMC: Class A product, see page 571



Ex:
Housing width 22.5 mm



Ex:
Housing width 22.5 mm



| Input data | |
|---|--|
| Input current | 0 A ... 11 A (AC/DC) |
| Operate threshold | 2% (of measuring range nominal value 1/5/10 A) |
| Frequency range | 15 Hz ... 400 Hz |
| Curve type | AC, DC or distorted currents |
| Overload capacity | 2 x I _N (continuous) |
| Surge strength | 20 x I _N (1 s) |
| Connection method | Screw connection |
| Output data | |
| Output signal (normal and inverse) | U output: 0 ... 5 V / 1 ... 5 V / 0 ... 10 V I output: 0 ... 20 mA / 4 ... 20 mA |
| Load R _B | > 10 kΩ |
| Switching output | |
| Relay output | Contact material: 1 PDT / AgSnO, hard gold-plated Max. switching current: 50 mA (for gold layer, 30 V AC/ 36 V DC) 2 A (in case of a destroyed gold layer, 250 V AC) 19 V ... 29 V (supply voltage - 1 V) |
| Transistor output pnp | Output voltage: 80 mA (Not short-circuit proof) Continuous load current: 1% ... 110% |
| Setting range of the threshold value | 0.1 s ... 20 s |
| Response delay | Yellow LED |
| Status indication | |
| General data | |
| Supply voltage U _B | 20 V DC ... 30 V DC |
| Current consumption | < 50 mA (without load) |
| Maximum transmission error | < 0.5% (of nominal range value under nominal conditions) |
| Temperature coefficient | typ. < 0.025%/K |
| Step response (10 - 90%) | 330 ms (with AC) 40 ms (with DC) |
| Safe isolation | as per EN 50178, EN 61010 |
| Rated insulation voltage | 300 V AC (to ground) |
| Surge voltage category / pollution degree | III / 2 |
| Test voltage input/output | 4 kV (50 Hz, 1 min.) |
| Test voltage input/power supply | 4 kV (50 Hz, 1 min.) |
| Test voltage output/power supply | 500 V (50 Hz, 1 min.) |
| Degree of protection | IP20 |
| Ambient temperature range | -20°C ... 60°C |
| Dimensions W / H / D | 22.5 / 99 / 114.5 mm |
| Screw connection solid / stranded / AWG | 0.2 ... 2.5 mm ² / 0.2 ... 2.5 mm ² / 24 - 14 |
| Conformance / approvals | |
| Conformance | CE-compliant |
| UL, USA / Canada | Class I, Zone 2, AEx nC IIC T6, Ex nC IIC T6 |

| Technical data | |
|---|--|
| Input current | 0 A ... 11 A (AC/DC) |
| Operate threshold | 2% (of measuring range nominal value 1/5/10 A) |
| Frequency range | 15 Hz ... 400 Hz |
| Curve type | AC, DC or distorted currents |
| Overload capacity | 2 x I _N (continuous) |
| Surge strength | 20 x I _N (1 s) |
| Connection method | Screw connection |
| Output data | |
| Output signal (normal and inverse) | U output: 0 ... 5 V / 1 ... 5 V / 0 ... 10 V I output: 0 ... 20 mA / 4 ... 20 mA |
| Load R _B | > 10 kΩ |
| Switching output | |
| Relay output | Contact material: 1 PDT / AgSnO, hard gold-plated Max. switching current: 50 mA (for gold layer, 30 V AC/ 36 V DC) 2 A (in case of a destroyed gold layer, 250 V AC) 19 V ... 29 V (supply voltage - 1 V) |
| Transistor output pnp | Output voltage: 80 mA (Not short-circuit proof) Continuous load current: 1% ... 110% |
| Setting range of the threshold value | 0.1 s ... 20 s |
| Response delay | Yellow LED |
| Status indication | |
| General data | |
| Supply voltage U _B | 20 V DC ... 30 V DC |
| Current consumption | < 50 mA (without load) |
| Maximum transmission error | < 0.5% (of nominal range value under nominal conditions) |
| Temperature coefficient | typ. < 0.025%/K |
| Step response (10 - 90%) | 330 ms (with AC) 40 ms (with DC) |
| Safe isolation | as per EN 50178, EN 61010 |
| Rated insulation voltage | 300 V AC (to ground) |
| Surge voltage category / pollution degree | III / 2 |
| Test voltage input/output | 4 kV (50 Hz, 1 min.) |
| Test voltage input/power supply | 4 kV (50 Hz, 1 min.) |
| Test voltage output/power supply | 500 V (50 Hz, 1 min.) |
| Degree of protection | IP20 |
| Ambient temperature range | -20°C ... 60°C |
| Dimensions W / H / D | 22.5 / 99 / 114.5 mm |
| Screw connection solid / stranded / AWG | 0.2 ... 2.5 mm ² / 0.2 ... 2.5 mm ² / 24 - 14 |
| Conformance / approvals | |
| Conformance | CE-compliant |
| UL, USA / Canada | Class I, Zone 2, AEx nC IIC T6, Ex nC IIC T6 |

| Technical data | |
|---|--|
| Input current | 0 A ... 55 A (AC/DC) |
| Operate threshold | 0.8% (of measuring range nominal value 50 A) |
| Frequency range | 15 Hz ... 400 Hz |
| Curve type | AC, DC or distorted currents |
| Overload capacity | Depending on through connected conductor |
| Surge strength | Depending on through connected conductor |
| Connection method | Through connection, diameter 10.5 mm |
| Output data | |
| Output signal (normal and inverse) | U output: 0 ... 5 V / 1 ... 5 V / 0 ... 10 V I output: 0 ... 20 mA / 4 ... 20 mA |
| Load R _B | > 10 kΩ |
| Switching output | |
| Relay output | Contact material: 1 PDT / AgSnO, hard gold-plated Max. switching current: 50 mA (for gold layer, 30 V AC/ 36 V DC) 2 A (in case of a destroyed gold layer, 250 V AC) 19 V ... 29 V (supply voltage - 1 V) |
| Transistor output pnp | Output voltage: 80 mA (Not short-circuit proof) Continuous load current: 1% ... 110% |
| Setting range of the threshold value | 0.1 s ... 20 s |
| Response delay | Yellow LED |
| Status indication | |
| General data | |
| Supply voltage U _B | 20 V DC ... 30 V DC |
| Current consumption | < 50 mA (without load) |
| Maximum transmission error | < 0.5% (of nominal range value under nominal conditions) |
| Temperature coefficient | typ. < 0.025%/K |
| Step response (10 - 90%) | 330 ms (with AC) 40 ms (with DC) |
| Safe isolation | as per EN 50178, EN 61010 |
| Rated insulation voltage | 300 V AC (to ground) |
| Surge voltage category / pollution degree | III / 2 |
| Test voltage input/output | 4 kV (50 Hz, 1 min.) |
| Test voltage input/power supply | 4 kV (50 Hz, 1 min.) |
| Test voltage output/power supply | 500 V (50 Hz, 1 min.) |
| Degree of protection | IP20 |
| Ambient temperature range | -20°C ... 60°C |
| Dimensions W / H / D | 22.5 / 99 / 114.5 mm |
| Screw connection solid / stranded / AWG | 0.2 ... 2.5 mm ² / 0.2 ... 2.5 mm ² / 24 - 14 |
| Conformance / approvals | |
| Conformance | CE-compliant |
| UL, USA / Canada | Class I, Zone 2, AEx nC IIC T6, Ex nC IIC T6 |

| Description |
|---|
| MCR current measuring transducer for measuring AC, DC, and distorted currents with relay and transistor switching output |
| Configurable product |
| Standard product |
| Configurable product, without switching output |
| Standard product, without switching output |

| Ordering data | | |
|---------------------------|-----------|-------------|
| Type | Order No. | Pcs. / Pkt. |
| MCR-S-1-5-UI-SW-DCI(1) | 2814650 | 1 |
| MCR-S-1-5-UI-SW-DCI-NC(1) | 2814731 | 1 |
| MCR-S-1-5-UI-DCI(1) | 2814634 | 1 |
| MCR-S-1-5-UI-DCI-NC(1) | 2814715 | 1 |

| Ordering data | | |
|-----------------------------|-----------|-------------|
| Type | Order No. | Pcs. / Pkt. |
| MCR-S-10-50-UI-SW-DCI(1) | 2814663 | 1 |
| MCR-S-10-50-UI-SW-DCI-NC(1) | 2814744 | 1 |
| MCR-S-10-50-UI-DCI(1) | 2814647 | 1 |
| MCR-S-10-50-UI-DCI-NC(1) | 2814728 | 1 |

Order key for the current transducers (standard configuration entered as example)

| Order No. | Measuring range: Start | End | Output | Threshold value | Suppression time | Operating behavior of relay and transistor | |
|----------------------------------|---|--|---|---|---------------------------------------|---|-------------------------------------|
| 2814634 | 0.00 | 5.00 | OUT01 | | | | |
| 2814650 | 0.00 | 5.00 | OUT01 | 50 | 3.0 | A | O |
| 2814634 ≙ MCR-S-1-5-UI-DCI | Measuring range starting value is between 0.00...7.50 A | Measuring range final value between 0.2...11 A | OUT01 ≙ 0...20 mA OUT02 ≙ 4...20 mA OUT03 ≙ 0...10 V OUT04 ≙ 2...10 V OUT05 ≙ 0...5 V OUT06 ≙ 1...5 V OUT07 ≙ 20...0 mA OUT08 ≙ 20...4 mA OUT09 ≙ 10...0 V OUT10 ≙ 10...2V OUT11 ≙ 5...0 V OUT12 ≙ 5...1 V OUT13 ≙ -5...+5 V OUT14 ≙ -10...+10 V OUT17 ≙ +10...-10 V OUT18 ≙ +5...-5 V | Switching threshold between 1 ... 110% 50 ≙ 50% of set upper measuring range value (here: 2.5 A) | between 0.1 ... 20 s 3.0 ≙ 3 s | A ≙ Operating current controlled R ≙ Closed-circuit current controlled | O ≙ Overrange U ≙ Underrange |
| 2814650 ≙ MCR-S-1-5-UI-SW-DCI | 0.00 ≙ 0.00 A | 5.00 ≙ 5.00 A | | | | | |

| Order No. | Measuring range: Start | End | Output | Threshold value | Suppression time | Operating behavior and transistor | |
|------------------------------------|--|--|---|--|---------------------------------------|---|-------------------------------------|
| 2814647 | 0.0 | 50.0 | OUT01 | | | | |
| 2814663 | 0.0 | 50.0 | OUT01 | 50 | 3.0 | A | O |
| 2814647 ≙ MCR-S-10-50-UI-DCI | Measuring range start value is between 0.00...37.5 A | Measuring range final value between 9.5...55 A | OUT01 ≙ 0...20 mA OUT02 ≙ 4...20 mA OUT03 ≙ 0...10 V OUT04 ≙ 2...10 V OUT05 ≙ 0...5 V OUT06 ≙ 1...5 V OUT07 ≙ 20...0 mA OUT08 ≙ 20...4 mA OUT09 ≙ 10...0 V OUT10 ≙ 10...2V OUT11 ≙ 5...0 V OUT12 ≙ 5...1 V OUT13 ≙ -5...+5 V OUT14 ≙ -10...+10 V OUT17 ≙ +10...-10 V OUT18 ≙ +5...-5 V | Switching threshold between 1 ... 110% 50 ≙ 50% of set upper measuring range value (here: 25 A) | between 0.1 ... 20 s 3.0 ≙ 3 s | A ≙ Operating current controlled R ≙ Closed-circuit current controlled | O ≙ Overrange U ≙ Underrange |
| 2814663 ≙ MCR-S-10-50-UI-SW-DCI | 0.0 ≙ 0.0 A | 50.0 ≙ 50.0 A | | | | | |

Function diagrams: Switching behavior of relay and transistor output:

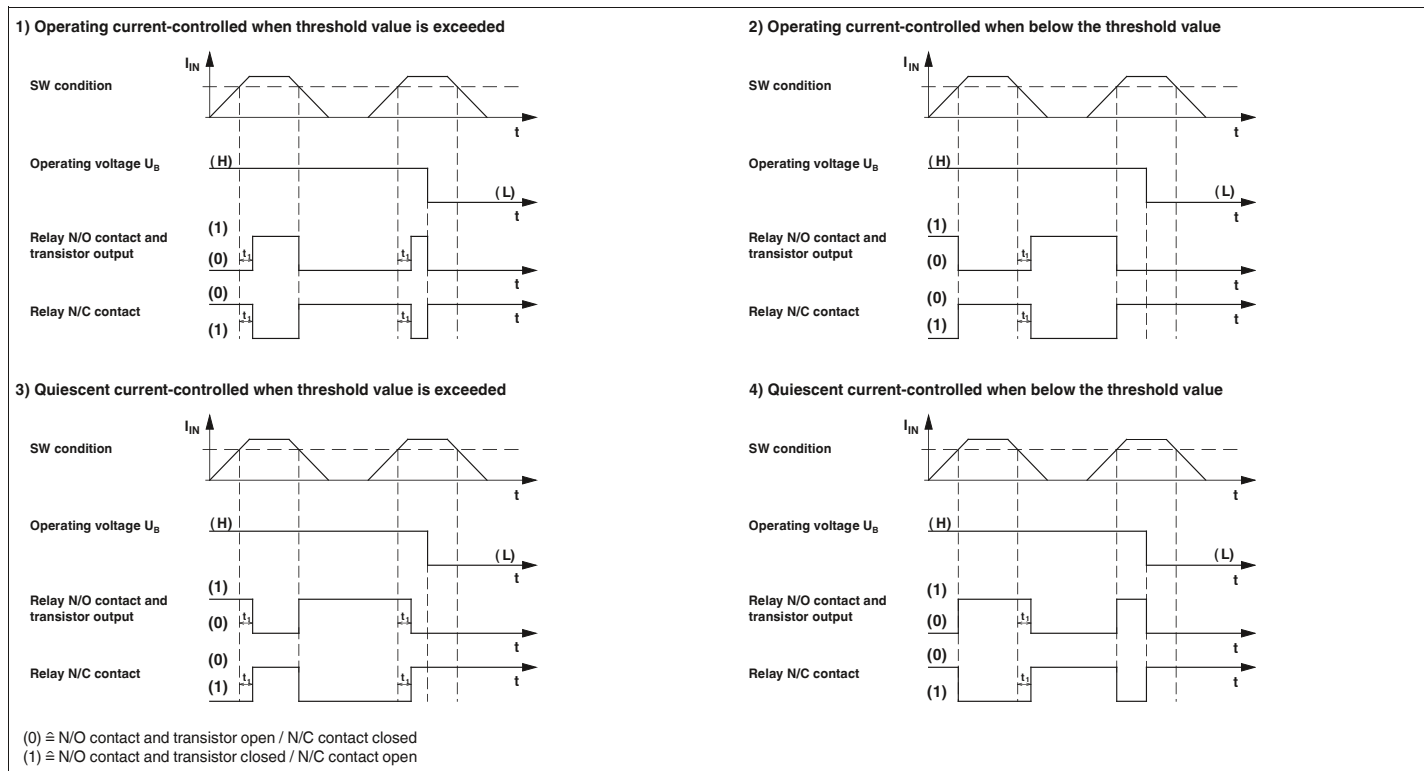

Monitoring

Current and voltage measuring technology

AC current transducers, sinusoidal

The **MCR-SL-CAC-...** current transducers measure sinusoidal alternating currents within the range 0 ... 1/5/12 A.

- Wide-range version from 19.2 ... 253 V AC/DC
- 3-way isolation
- Input/output can be configured using the DIP switch



For sinusoidal alternating currents
0 ... 1 A/0 ... 5 A



For sinusoidal alternating currents
0 ... 5 A/0 ... 12 A

Notes:
1) EMC: Class A product, see page 571

UL US
Ex:
Housing width 22.5 mm



Housing width 22.5 mm

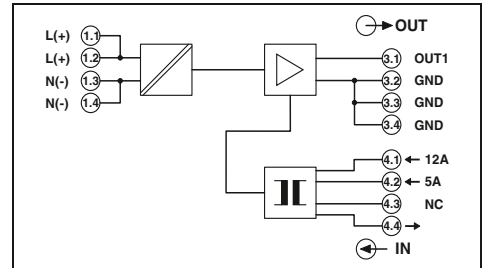

Technical data

| | | |
|-------------------------------|--|---|
| Input data | 0 A AC ... 1 A AC (configurable) / 0 A AC ... 5 A AC (configurable) | 0 A AC ... 5 A AC (configurable) / 0 A AC ... 12 A AC (configurable) |
| Nominal frequency | 50 Hz | 50 Hz |
| Frequency range | 45 Hz ... 65 Hz | 45 Hz ... 65 Hz |
| Curve type | Sine | Sine |
| Overload capacity | 2 x I _N (continuous) | 1 x I _N (continuous) |
| Surge strength | 20 x I _N (1 s) | 8 x I _N (1 s) |
| Connection method | Screw terminal block | Screw terminal block |
| Output data | 0 ... 20 mA / 4 ... 20 mA | 0 ... 20 mA / 4 ... 20 mA |
| Output signal (configurable) | 25 mA | 25 mA |
| Maximum output signal | < 500 Ω (at 20 mA) | < 500 Ω (at 20 mA) |
| Load R _B | < 10 mV _{pp} (for 500 Ω at 20 mA) | < 10 mV _{pp} (for 500 Ω at 20 mA) |
| Ripple | MACX MCR-SL-CAC-5-I ¹⁾ | MACX MCR-SL-CAC-12-I-UP ¹⁾ |
| General data | 19.2 V DC ... 30 V DC | 19.2 V AC/DC ... 253 V AC/DC |
| Supply voltage U _B | < 32 mA | < 30 mA |
| Current consumption | (at U _B =24 V DC, I _{OUT} =20 mA) | (at U _B =24 V DC, I _{OUT} =20 mA) |
| Maximum transmission error | ≤ 0.5% (of nominal range value under nominal conditions) | ≤ 0.5% (of nominal range value under nominal conditions) |

Technical data

| | | |
|-------------------------------|--|---|
| Input data | 0 A AC ... 1 A AC (configurable) / 0 A AC ... 5 A AC (configurable) | 0 A AC ... 5 A AC (configurable) / 0 A AC ... 12 A AC (configurable) |
| Nominal frequency | 50 Hz | 50 Hz |
| Frequency range | 45 Hz ... 65 Hz | 45 Hz ... 65 Hz |
| Curve type | Sine | Sine |
| Overload capacity | 2 x I _N (continuous) | 1 x I _N (continuous) |
| Surge strength | 20 x I _N (1 s) | 8 x I _N (1 s) |
| Connection method | Screw terminal block | Screw terminal block |
| Output data | 0 ... 20 mA / 4 ... 20 mA | 0 ... 20 mA / 4 ... 20 mA |
| Output signal (configurable) | 25 mA | 25 mA |
| Maximum output signal | < 500 Ω (at 20 mA) | < 500 Ω (at 20 mA) |
| Load R _B | < 10 mV _{pp} (for 500 Ω at 20 mA) | < 10 mV _{pp} (for 500 Ω at 20 mA) |
| Ripple | MACX MCR-SL-CAC-5-I ¹⁾ | MACX MCR-SL-CAC-12-I-UP ¹⁾ |
| General data | 19.2 V DC ... 30 V DC | 19.2 V AC/DC ... 253 V AC/DC |
| Supply voltage U _B | < 32 mA | < 33 mA |
| Current consumption | (at U _B =24 V DC, I _{OUT} =20 mA) | (at 24 V DC) |
| Maximum transmission error | ≤ 0.5% (of nominal range value under nominal conditions) | ≤ 0.5% (of nominal range value under nominal conditions) |

| | | |
|---|---|---|
| Temperature coefficient | < 0.02%/K | < 0.02%/K |
| Step response (10 - 90%) | max. 300 ms Typ. 200 ms | max. 300 ms Typ. 200 ms |
| Safe isolation | acc. to EN 61010 | acc. to EN 61010 |
| Rated insulation voltage | - | - |
| Surge voltage category Input/output | - | - |
| Pollution degree | 2 | 2 |
| Test voltage input/output | 4 kV (50 Hz, 1 min.) | 4 kV (50 Hz, 1 min.) |
| Test voltage output/power supply | 1.5 kV (50 Hz, 1 min.) | 2 kV (50 Hz, 1 min.) |
| Degree of protection | IP20 | IP20 |
| Ambient temperature range | -20°C ... 65°C (-4°F ... 149°F) | -20°C ... 65°C (-4°F ... 149°F) |
| Dimensions W / H / D | 22.5 / 104 / 114.5 mm | 22.5 / 104 / 114.5 mm |
| Screw connection solid / stranded / AWG | 0.2 ... 2.5 mm ² / 0.2 ... 2.5 mm ² / 24 - 14 | 0.2 ... 2.5 mm ² / 0.2 ... 2.5 mm ² / 24 - 14 |
| Conformance / approvals | CE-compliant ATEX UL, USA / Canada | CE-compliant UL 508 Recognized |

| | | |
|---|---|---|
| Temperature coefficient | < 0.02%/K | < 0.02%/K |
| Step response (10 - 90%) | max. 300 ms Typ. 200 ms | max. 300 ms Typ. 200 ms |
| Safe isolation | acc. to EN 61010 | acc. to EN 61010 |
| Rated insulation voltage | - | - |
| Surge voltage category Input/output | - | - |
| Pollution degree | 2 | 2 |
| Test voltage input/output | 4 kV (50 Hz, 1 min.) | 4 kV (50 Hz, 1 min.) |
| Test voltage output/power supply | 2 kV (50 Hz, 1 min.) | 2 kV (50 Hz, 1 min.) |
| Degree of protection | IP20 | IP20 |
| Ambient temperature range | -20°C ... 65°C (-4°F ... 149°F) | -20°C ... 65°C (-4°F ... 149°F) |
| Dimensions W / H / D | 22.5 / 104 / 114.5 mm | 22.5 / 104 / 114.5 mm |
| Screw connection solid / stranded / AWG | 0.2 ... 2.5 mm ² / 0.2 ... 2.5 mm ² / 24 - 14 | 0.2 ... 2.5 mm ² / 0.2 ... 2.5 mm ² / 24 - 14 |
| Conformance / approvals | CE-compliant ATEX UL, USA / Canada | CE-compliant UL 508 Recognized |

Ordering data

| Type | Order No. | Pcs. / Pkt. |
|--------------------------------------|-----------|-------------|
| MACX MCR-SL-CAC-5-I ¹⁾ | 2810612 | 1 |
| MACX MCR-SL-CAC-5-I-UP ¹⁾ | 2810625 | 1 |

Accessories

| | | |
|--------------------------------|---------|----|
| ME 22,5 TBUS 1,5/ 5-ST-3,81 GN | 2707437 | 50 |
|--------------------------------|---------|----|

Ordering data

| Type | Order No. | Pcs. / Pkt. |
|---------------------------------------|-----------|-------------|
| MACX MCR-SL-CAC-12-I-UP ¹⁾ | 2810638 | 1 |

Accessories

| | | |
|--|--|--|
| | | |
|--|--|--|

AC current transducers, sinusoidal and distorted

The **MCR-SL-S-...00-...** current transducers measure sinusoidal and non-sinusoidal alternating currents within the range 0 ... 200 A.

- True/r.m.s. value measurement from 30...6000 Hz
- Measuring range selection with slide switch
- Loop-powered
- Can be retrofitted with the open-up Rogowski coil



For sinusoidal and non-sinusoidal alternating currents, 0 ... 200 A, voltage output

Ex: Housing width 55 mm



Technical data

| | |
|---|---|
| Input data | ... |
| Input current (configurable) | 0 A ... 100 A (0...50/75/100 A) |
| Operate threshold | 1% (of final value) |
| Frequency range | 30 Hz ... 6000 Hz |
| Curve type | Sinusoidal and non-sinusoidal |
| Overload capacity | Depending on laid conductor |
| Surge strength | Depending on through connected conductor |
| Connection method | Clamp-on cable design, diameter 18.5 mm |
| Output data | 0 ... 5 V / 0 ... 10 V |
| Output signal | ((0 V ... 10 V) 14 V, (0 V ... 5 V) 7 V) |
| Maximum output signal | ≥ 10 kΩ |
| Load R _B | |
| General data | |
| Supply voltage U _B | 20 V DC ... 30 V DC |
| Current consumption | < 30 mA |
| Maximum transmission error | < 1% (of final value) |
| Cable position error | < 0.63% |
| Temperature coefficient | < 0.035%/K |
| Step response (10 - 90%) | < 340 ms |
| Safe isolation | As per IEC 61010-1 and IEC 61326 |
| Rated insulation voltage | 300 V AC (to ground) |
| Surge voltage category / pollution degree | III / 2 |
| Test voltage input/output | 5 kV (50 Hz, 1 min.) |
| Degree of protection | IP20 |
| Ambient temperature range | -20°C ... 60°C |
| Dimensions W / H / D | 55 / 85 / 70.5 mm |
| Screw connection solid / stranded / AWG | 0.2 ... 2.5 mm ² / 0.2 ... 2.5 mm ² / 24 - 14 |
| Conformance / approvals | |
| Conformance | CE-compliant |
| UL, USA / Canada | cULus |

Ordering data

| Description | Type | Order No. | Pcs. / Pkt. |
|---|----------------|-----------|-------------|
| MCR current measuring transducers for sinusoidal and non-sinusoidal alternating currents | | | |
| Input current range: 0...50/75/100 A | MCR-SL-S-100-U | 2813457 | 1 |
| Input current range: 0..0.100/150/200 A | MCR-SL-S-200-U | 2813460 | 1 |



For sinusoidal and non-sinusoidal alternating currents, 0 ... 200 A, current output (loop-powered)

Ex: Housing width 55 mm

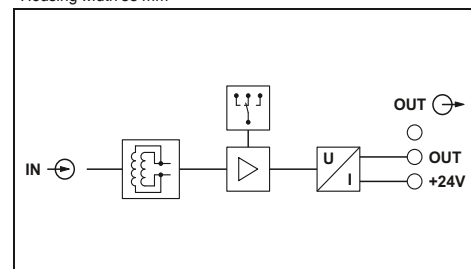

Technical data

| | |
|---|---|
| ... | ... |
| Input current (configurable) | 0 A ... 100 A (0...50/75/100 A) |
| Operate threshold | 1% (of final value) |
| Frequency range | 30 Hz ... 6000 Hz |
| Curve type | Sinusoidal and non-sinusoidal |
| Overload capacity | Depending on laid conductor |
| Surge strength | Depending on through connected conductor |
| Connection method | Clamp-on cable design, diameter 18.5 mm |
| Output data | 4 ... 20 mA |
| Output signal | < 25 mA |
| Maximum output signal | ((U _B - 12 V) x 350 / 12 A) |
| Load R _B | |
| General data | |
| Supply voltage U _B | 20 V DC ... 30 V DC |
| Current consumption | < 1% (of final value) |
| Maximum transmission error | < 0.63% |
| Cable position error | < 0.025%/K |
| Temperature coefficient | < 340 ms |
| Step response (10 - 90%) | < 340 ms |
| Safe isolation | As per IEC 61010-1 and IEC 61326 |
| Rated insulation voltage | 300 V AC (to ground) |
| Surge voltage category / pollution degree | III / 2 |
| Test voltage input/output | 5 kV (50 Hz, 1 min.) |
| Degree of protection | IP20 |
| Ambient temperature range | -20°C ... 60°C |
| Dimensions W / H / D | 55 / 85 / 70.5 mm |
| Screw connection solid / stranded / AWG | 0.2 ... 2.5 mm ² / 0.2 ... 2.5 mm ² / 24 - 14 |
| Conformance / approvals | |
| Conformance | CE-compliant |
| UL, USA / Canada | cULus |

Ordering data

| Description | Type | Order No. | Pcs. / Pkt. |
|---|-------------------|-----------|-------------|
| MCR current measuring transducers for sinusoidal and non-sinusoidal alternating currents | | | |
| Input current range: 0...50/75/100 A | MCR-SL-S-100-I-LP | 2813486 | 1 |
| Input current range: 0..0.100/150/200 A | MCR-SL-S-200-I-LP | 2813499 | 1 |

Monitoring

Current and voltage measuring technology

Passive AC current transducers, sinusoidal

The **MCR-SLP-1-5-UI-0** passive current transducer measures sinusoidal alternating currents within the range 0 ... 1 A/0 ... 5 A.

- Loop-powered
- Measuring ranges 1 A and 5 A AC, reconnectable

Notes:

1) EMC: Class A product, see page 571



For sinusoidal alternating currents
0 ... 1 A/0 ... 5 A



Housing width 22.5 mm

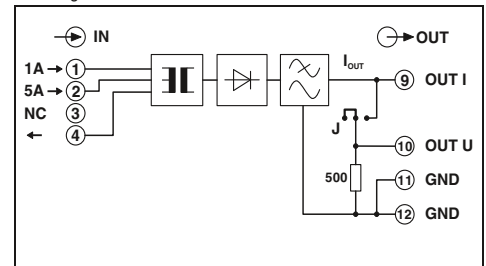

Technical data

| | | |
|---|---|---|
| Input data | 1 A input | 5 A input |
| Input current | 0 A AC ... 5 A AC | 0 A AC ... 0.005 A AC |
| Frequency range | 45 Hz ... 60 Hz | 45 Hz ... 60 Hz |
| Curve type | Sine | Sine |
| Overload capacity | 2 x I _N (5 min. at 60°C ambient temperature) | - |
| Surge strength | 50 A (1 s) | 100 A (1 s) |
| Permissible output range | 1.2 x I _N | 1.2 x I _N |
| Connection method | Screw connection | Screw connection |
| Output data | U output | I output |
| Output signal | 0 ... 10 V | 0 ... 20 mA |
| Maximum output signal | 20 V | 30 mA |
| Load R _B | > 100 kΩ | < 750 Ω < 250 Ω (when current and voltage outputs are used simultaneously) |
| Ripple | < 50 mV _{pp} | < 50 mV _{pp} |
| General data | | |
| Maximum transmission error | < 0.5% (of final value) | |
| Temperature coefficient | < 0.015%/K | |
| Step response (10 - 90%) | < 200 ms | |
| Safe isolation | as per EN 50178, EN 61010 | |
| Rated insulation voltage | 300 V AC (to ground) | |
| Surge voltage category / pollution degree | III / 2 | |
| Test voltage input/output | 4 kV (50 Hz, 1 min.) | |
| Degree of protection | IP20 | |
| Ambient temperature range | -25°C ... 60°C | |
| Dimensions W / H / D | 22.5 / 99 / 114.5 mm | |
| Screw connection solid / stranded / AWG | 0.2 ... 2.5 mm ² / 0.2 ... 2.5 mm ² / 24 - 14 | |
| Conformance / approvals | CE-compliant | |
| Conformance | | |

Ordering data

| Description | Type | Order No. | Pcs. / Pkt. |
|--|--------------------------------------|----------------|-------------|
| MCR passive current measuring transducers for sinusoidal alternating currents | MCR-SLP-1-5-UI-0¹⁾ | 2814359 | 1 |

AC current protectors, sinusoidal

The **MCR-SL-S-16-SP-24** current protector converts sinusoidal 50 Hz/60 Hz alternating currents into binary switching signals.

- Switching point can be freely selected in the measuring range of 0...16 A AC
- Changeover relay output
- Adjustable switch hysteresis
- 3-way isolation
- Settable operating current/quiescent current behavior

Notes:
1) EMC: Class A product, see page 571



For sinusoidal alternating currents, 0 ... 16 A AC

Housing width 22.5 mm

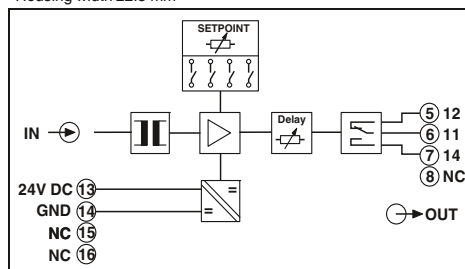

Technical data

| | |
|---|---|
| Input data | 0 A AC ... 16 A AC |
| Input current | 45 Hz ... 65 Hz |
| Frequency range | Sine |
| Curve type | 2 x I _{N,continuous} |
| Overload capacity | Through connection, diameter 4.2 mm |
| Connection method | Relay output |
| Switching output | 1 PDT |
| Contact type | AgSnO, hard gold-plated |
| Contact material | 50 mA (for gold layer, 30 V AC/ 36 V DC) |
| Maximum switching current | 2 A (in case of a destroyed gold layer, 250 V AC) |
| | Adjustable using a DIP switch (0.5%, 5%, 10%, 15%) |
| Switching hysteresis | Typ. 0.1 s ... 10 s (Adjustable using a potentiometer) |
| Response delay | Adjustable using a DIP switch |
| Operating and closed circuit current behavior | Yellow LED (relay active) |
| Relay status display | |
| General data | 20 V DC ... 30 V DC |
| Supply voltage U _B | < 30 mA |
| Current consumption | < 0.5% |
| Setting accuracy | < 0.02%/K |
| Temperature coefficient | 40 ms |
| Step response (10 - 90%) | as per EN 50178, EN 61010-1 |
| Safe isolation | 300 V AC (to ground) |
| Rated insulation voltage | III / 2 |
| Surge voltage category / pollution degree | 4 kV (50 Hz, 1 min.) |
| Test voltage input/output | 4 kV (50 Hz, 1 min.) |
| Test voltage input/power supply | IP20 |
| Degree of protection | -20°C ... 65°C |
| Ambient temperature range | 22.5 / 99 / 114.5 mm |
| Dimensions W / H / D | 0.2 ... 2.5 mm ² / 0.2 ... 2.5 mm ² / 24 - 14 |
| Screw connection solid / stranded / AWG | |
| Conformance / approvals | CE-compliant |
| Conformance | |

Ordering data

| Description | Type | Order No. | Pcs. / Pkt. |
|--|-----------------------------------|-----------|-------------|
| MCR current protector for sinusoidal alternating currents | MCR-SL-S- 16-SP- 24 ¹⁾ | 2864464 | 1 |

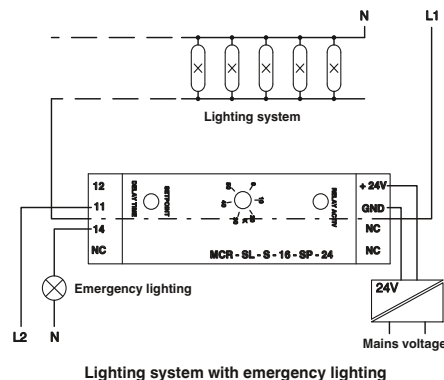

Monitoring

Current and voltage measuring technology

Voltage transducers

The **MCR-VDC-UI-B-DC** voltage transducer measures DC voltages within the range 0 ... ±660 V DC.

The **MCR-VAC-UI-O-DC** voltage transducer measures sinusoidal AC voltages from 0 ... 444 V AC.

- Bidirectional output signals
- Adjustable voltage ranges
- ZERO/SPAN adjustment ±20%
- 3-way isolation

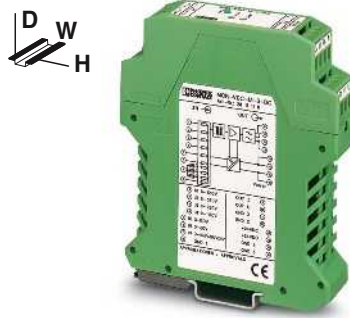

For DC voltages
0 ... ±660 V DC



For sinusoidal AC voltages
0...444 V AC

Notes:
1) EMC: Class A product, see page 571

Housing width 22.5 mm

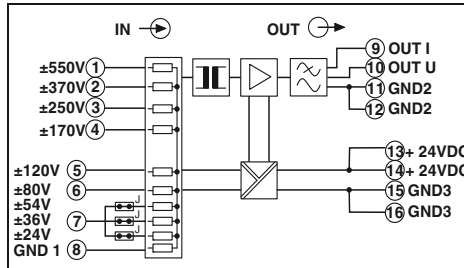

Technical data

| | |
|------------------------|--------|
| -550 V DC ... 550 V DC | 550 kΩ |
| -370 V DC ... 370 V DC | 370 kΩ |
| -250 V DC ... 250 V DC | 250 kΩ |
| -170 V DC ... 170 V DC | 170 kΩ |
| -120 V DC ... 120 V DC | 120 kΩ |
| -80 V DC ... 80 V DC | 80 kΩ |
| -54 V DC ... 54 V DC | 54 kΩ |
| -36 V DC ... 36 V DC | 36 kΩ |
| -24 V DC ... 24 V DC | 24 kΩ |
| ±20% / ±20% | - |

Input data
Input voltage range / resistor

ZERO / SPAN adjustment
Frequency range

Output data
Output signal
Maximum output signal
Load R_B
Ripple

General data

Supply voltage U_B 18.5 V DC ... 30.2 V DC
Current consumption < 50 mA
Maximum transmission error < 1% (of final value)
Temperature coefficient < 0.015%/K
Limit frequency (3 dB) 40 Hz
Step response (10 - 90%) 12 ms
Safe isolation acc. to EN 50178
Rated insulation voltage -
Surge voltage category / pollution degree II / 2
Test voltage input/output 1.5 kV (50 Hz, 1 min.)
Degree of protection IP20
Ambient temperature range -25°C ... 50°C
Dimensions W / H / D 22.5 / 99 / 114.5 mm
Screw connection solid / stranded / AWG 0.2 ... 2.5 mm² / 0.2 ... 2.5 mm² / 24 - 14
Conformance / approvals CE-compliant

Ordering data

Description

MCR voltage measuring transducer, for DC voltages from 0...±20 V DC to 0...±660 V DC

MCR voltage transducer, for sinusoidal AC voltages from 0...20 V AC to 0...440 V AC

| Type | Order No. | Pcs. / Pkt. |
|-------------------------------|-----------|-------------|
| MCR-VDC-UI-B-DC ¹⁾ | 2811116 | 1 |

Housing width 22.5 mm

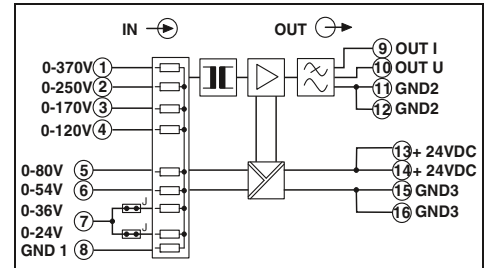

Technical data

| | |
|------------------|--------|
| 0 V ... 370 V AC | 370 kΩ |
| 0 V ... 250 V AC | 250 kΩ |
| 0 V ... 170 V AC | 170 kΩ |
| 0 V ... 120 V AC | 120 kΩ |
| 0 V ... 80 V AC | 80 kΩ |
| 0 V ... 54 V AC | 54 kΩ |
| 0 V ... 36 V AC | 36 kΩ |
| 0 V ... 24 V AC | 24 kΩ |
| ±20% / ±20% | - |

Frequency range
45 Hz ... 400 Hz

Output data
U output
I output

Supply voltage U_B 18.5 V DC ... 30.2 V DC
Current consumption < 45 mA
Maximum transmission error < 1.5% (of final value)
Temperature coefficient -
Limit frequency (3 dB) -
Step response (10 - 90%) 250 ms
Safe isolation acc. to EN 50178
Rated insulation voltage 300 V DC
Surge voltage category / pollution degree III / 2
Test voltage input/output 3.3 kV (50 Hz, 1 min.)
Degree of protection IP20
Ambient temperature range -25°C ... 60°C
Dimensions W / H / D 22.5 / 99 / 114.5 mm
Screw connection solid / stranded / AWG 0.2 ... 2.5 mm² / 0.2 ... 2.5 mm² / 24 - 14
Conformance / approvals CE-compliant

Ordering data

| Type | Order No. | Pcs. / Pkt. |
|-------------------------------|-----------|-------------|
| MCR-VAC-UI-O-DC ¹⁾ | 2811103 | 1 |

Accessories

Configuration software package

The **MCR/PI-CONF-WIN configuration software package** is used to configure and visualize all parameters for the programmable MCR measuring transducers.

- Straightforward menu interface
- Rapid programming

Notes:

The software runs under the following operating systems: Windows NT™, 2000™, and XP™.



For MCR-S... current transducer

| Description | | Ordering data | | |
|--|--|-----------------|-----------|-------------|
| MCR configuration software , for programming MCR-T-..., MCR-...-LP-..., MCR-...-HT-..., MCR-S-..., MCR-F-..., and MCR-PSP-... modules, CD-ROM | | Type | Order No. | Pcs. / Pkt. |
| | | MCR/PI-CONF-WIN | 2814799 | 1 |
| Labels | | Accessories | | |
| Labels , for labeling MCR-T and MCR-S modules, four sheets DIN A4 marking labels (112 pieces) | | MCR-ET 38X35 WH | 2814317 | 1 |

USB adapter cable

Software adapter cable

The following adapter cables are available for programming the MCR-S... current transducers:

- USB adapter cable
- Software adapter cable



For MCR-S... current transducer

| Description | | Ordering data | | |
|---|--|---------------------|-----------|-------------|
| USB adapter cable , D-9-SUB to USB, with adapter D-9-SUB to D-25-SUB | | Type | Order No. | Pcs. / Pkt. |
| | | CM-KBL-RS232/USB | 2881078 | 1 |
| Software adapter cable (stereo jack plug/25-pos. D-SUB), 1.2 m long, for programming MCR-T-..., MCR-S-..., and MCR-F-... modules | | MCR-TTL-RS232-E | 2814388 | 1 |
| Adapter cable | | Accessories | | |
| Adapter cable , stranded, 9-pos. D-SUB socket on 25-pos. D-SUB pin | | PSM-KAD 9 SUB 25/BS | 2761295 | 1 |

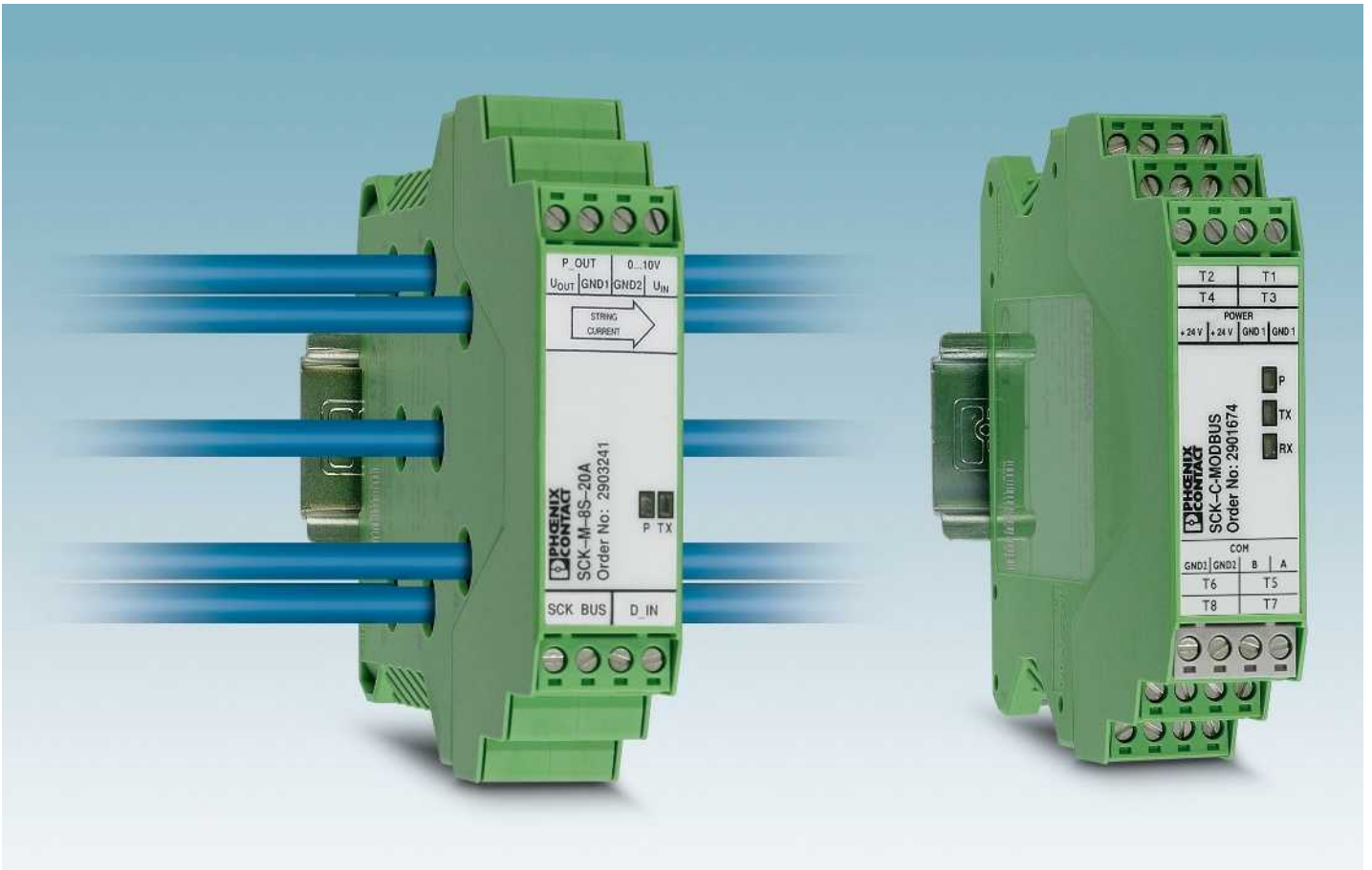

Utilize solar electricity efficiently

Detect errors – increase efficiency: photovoltaic systems should achieve maximum energy yield within the shortest possible time.

SOLARCHECK provides reliable information regarding the performance of your photovoltaic system. It can be used to detect faults, which may be caused by damaged panels, defective contacts or damage in the cabling. This allows you to implement countermeasures quickly, thereby increasing the efficiency of your system.

Current topic: reliable monitoring

Whether a small roof-top system on a family home or a megawatt outdoor system: for reliable operation, the photovoltaic market requires monitoring systems where status information is continuously available and visualization is easy. Phoenix Contact offers a comprehensive portfolio of hardware and software products specifically designed for this purpose.

Energy of the future

From installation to monitoring - in the "Components and systems for photovoltaics" brochure you will find further innovative solutions for your photovoltaic system, such as:

- Connection technology
- Surge protection
- Hardware and software solutions
- Generator connection boxes
- Tools and marking

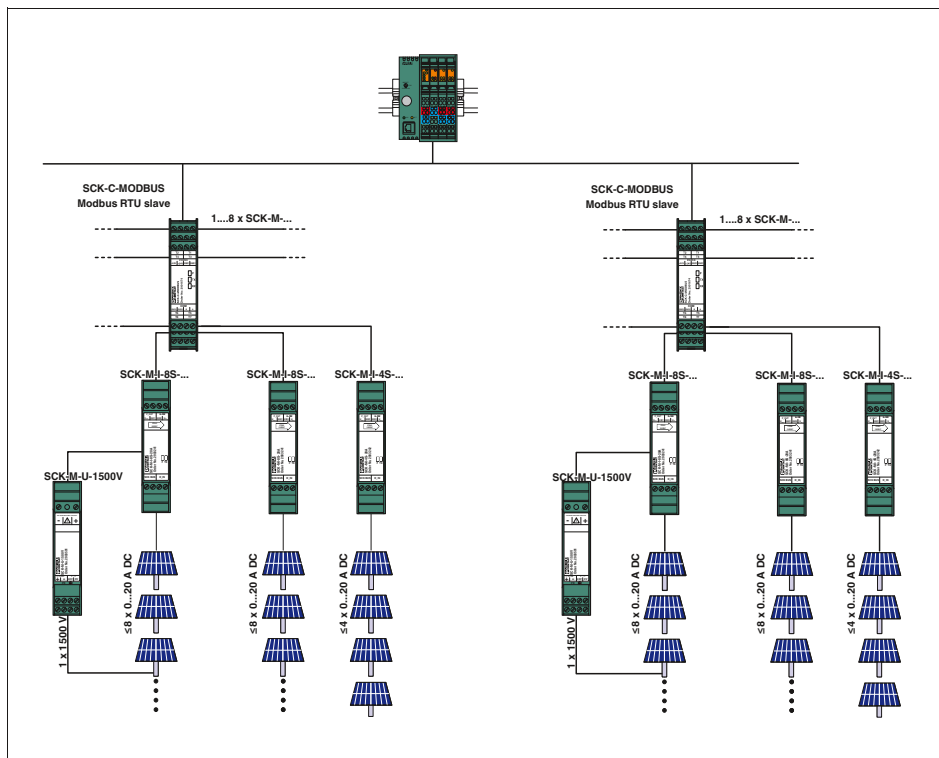

Easy integration in monitoring systems

The modular Solarcheck monitoring system consists of various measuring modules for current and voltage measurement and an associated communication module.

The communication module collects the measured values from the current measuring modules and forwards them to a higher-level controller. You can acquire up to eight or four string currents with one current measuring module each. A maximum of eight current measuring modules of any type can be connected to one communication module. The 2-conductor communication cable is also used to supply the measuring modules with power. This means that no additional power supply unit is required in the field.

The voltage measuring module is usually connected to and also supplied via the analog input provided on the 8-channel current measuring modules.

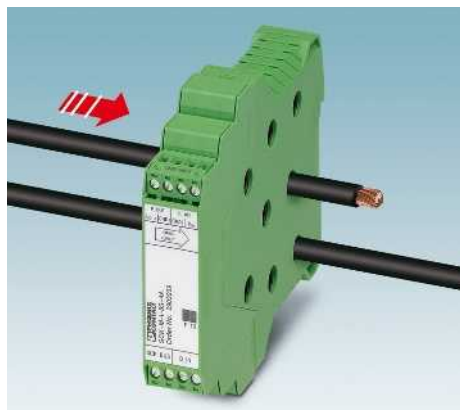

Contact-free current measurement

Contact-free measurement using Hall sensors offers many advantages:

- Safe isolation is already ensured by the cable insulation.
- No contact resistance due to additional contact points.
- The current is forwarded safely as the line circuit is not directly accessed.



Space-saving installation without an additional power supply unit

With a width of just 22.5 mm, the narrow measuring module bundles the cables in a confined space.

- The 2-conductor communication cable is also used to supply the measuring modules.
- This means that one communication module supplies up to eight measuring modules – without an additional power supply unit.

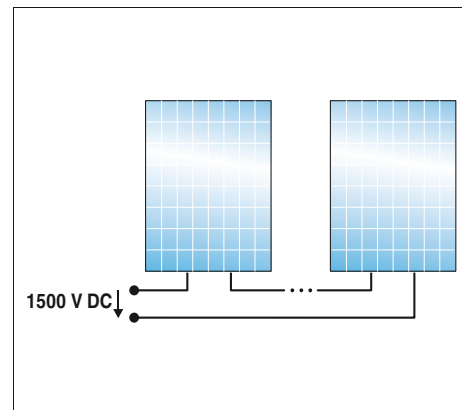

Flexible expansion

Optional extension of voltage measurement up to 1500 V DC.

- Also suitable for grounded systems.
- Suitable for PV systems with extra high system voltages.
- Flexible use, even outside the Solarcheck system.

Monitoring

Solar and PV system monitoring

PV string monitoring Solarcheck

The modular Solarcheck monitoring system consists of various devices for current and voltage measurement and an associated communication module.

Communication module:

- For connecting and collecting measured values from up to eight measuring modules
- Provision of data for transfer to higher-level controllers

Current measuring modules:

- 8-channel current measurement up to 20 A DC
- Detection of reverse currents up to -1 A
- 4-channel extension modules for 20 A DC
- Internal temperature monitoring
- Digital input for monitoring, e.g., the remote indication contacts of surge protection modules
- Supply via the communication module

Voltage measuring module

- Voltage measurement up to 1500 V DC in any grounded PV system
- Connection and supply is usually via the analog input provided (0 ... 10 V) on the 8-channel Solarcheck current measuring module
- Output of the voltage measured value as a 2 ... 10 V analog signal
- As an option, can also be removed from the Solarcheck group and used separately

Notes:
1) EMC: Class A product, see page 571



**Communication module
RS-485 (Modbus RTU)**

Housing width 22.5 mm

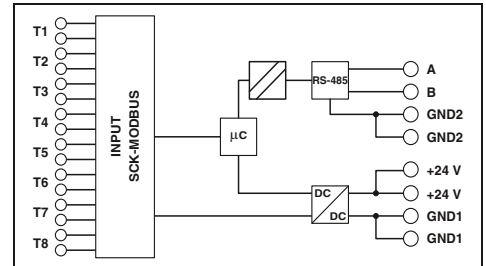

Technical data

| | |
|--|---|
| Supply | |
| Supply voltage | 24 V DC -10% ... +25% |
| Own current consumption | 12 mA |
| Measuring input | |
| Current measuring range | - |
| Maximum transmission error | - |
| Temperature coefficient | - |
| Reverse current detection | - |
| Number of measuring channels | - |
| Voltage measuring range | - |
| Connection method | - |
| Digital input | |
| Controlled by external floating contact | - |
| Analog input | |
| Input voltage range | - |
| Analog output | |
| Output voltage range | - |
| SCK-C-MODBUS data interface | |
| Cable length (for 0.15 mm ²) | - |
| Communication protocol | - |
| Serial port | RS-485 |
| Serial transmission speed | 9.6/14.4/19.2/38.4 kbps |
| Cable length | ≤ 1200 m |
| Communication protocol | Modbus RTU |
| General data | |
| Degree of protection | IP20 |
| Ambient temperature range | -20°C ... 70°C |
| Dimensions W / H / D | 22.5 / 102 / 106 mm |
| Screw connection solid / stranded / AWG | 0.14 ... 1.5 mm ² / 0.14 ... 1.5 mm ² / 26 - 16 |
| Conformance / approvals | |
| Conformance | CE-compliant |

Ordering data

| Description | Type | Order No. | Pcs. / Pkt. |
|--|----------------------------------|----------------|-------------|
| Communication module | | | |
| Current measuring module, 8-channel | SCK-C-MODBUS¹⁾ | 2901674 | 1 |
| Current measuring module, 4-channel for extension | | | |
| Voltage measuring module | | | |



Current measuring module, 20 A DC, 8-channel

N



Extension module, 4-channel Current measurement 20 A DC

N



Voltage measuring module, 0...1500 V DC

N

Housing width 22.5 mm



Technical data

| |
|---|
| - |
| 45 mA |
| 0 A ... 20 A |
| ±1% (From the measuring range final value) |
| 0.02%/K (From T > 25°C) |
| -1 A ... 0 A |
| 8 |
| - |
| Through connection, 9.5 mm diameter |
| Floating switch contacts |
| 0 V ... 10 V |
| - |
| max. 300 m |
| Proprietary |
| - |
| - |
| - |
| IP20 |
| -20°C ... 70°C |
| 22.5 / 102 / 128.5 mm |
| 0.14 ... 1.5 mm ² / 0.14 ... 1.5 mm ² / 26 - 16 |
| CE-compliant |

Ordering data

| Type | Order No. | Pcs. / Pkt. |
|----------------|-----------|-------------|
| SCK-M-I-8S-20A | 2903241 | 1 |

Housing width 22.5 mm

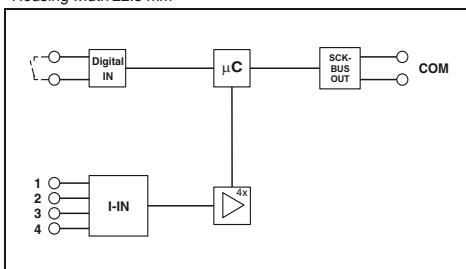

Technical data

| |
|---|
| - |
| 45 mA |
| 0 A ... 20 A |
| ±1% (From the measuring range final value) |
| 0.02%/K (From T > 25°C) |
| -1 A ... 0 A |
| 4 |
| - |
| Through connection, 9.5 mm diameter |
| - |
| - |
| - |
| max. 300 m |
| Proprietary |
| - |
| - |
| - |
| IP20 |
| -20°C ... 70°C |
| 22.5 / 102 / 128.5 mm |
| 0.14 ... 1.5 mm ² / 0.14 ... 1.5 mm ² / 26 - 16 |
| CE-compliant |

Ordering data

| Type | Order No. | Pcs. / Pkt. |
|----------------|-----------|-------------|
| SCK-M-I-4S-20A | 2903242 | 1 |

Housing width 22.5 mm

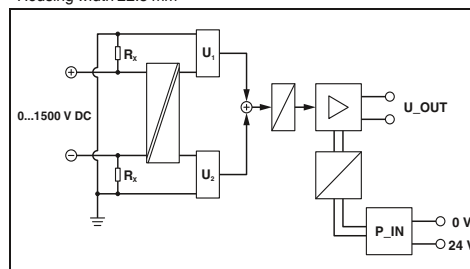

Technical data

| |
|---|
| 24 V DC -10% ... +25% (or via SCK-M-I-8S-...) |
| 35 mA |
| - |
| 1% (After additional adjustment) |
| < 0.03%/K |
| - |
| 1 |
| 0 V DC ... 1500 V DC |
| Screw connection |
| - |
| - |
| 2 V ... 10 V |
| max. 0.5 m |
| - |
| - |
| - |
| IP20 |
| -20°C ... 70°C |
| 22.5 / 102 / 128.5 mm |
| 0.14 ... 1.5 mm ² / 0.14 ... 1.5 mm ² / 26 - 16 |
| CE-compliant |

Ordering data

| Type | Order No. | Pcs. / Pkt. |
|---------------|-----------|-------------|
| SCK-M-U-1500V | 2903591 | 1 |

Monitoring

Residual current monitoring

Detect errors before they actually occur



RCM devices provide residual current monitoring in grounded power supply systems. They detect residual currents at an early stage, such as those that occur as a result of insulation errors. They can therefore be used to prevent forced system shutdown. Plans can be made to remove errors outside of operating hours. RCM devices also act as a form of fire prevention.

Increasing use is being made of equipment such as frequency inverters. In the event of an error, residual currents with a frequency of up to 50 kHz can be generated. Type B+ RCM devices from Phoenix Contact are already able to detect residual currents with frequencies up to 100 kHz. This far exceeds present-day requirements of 20 kHz for type B+ devices.

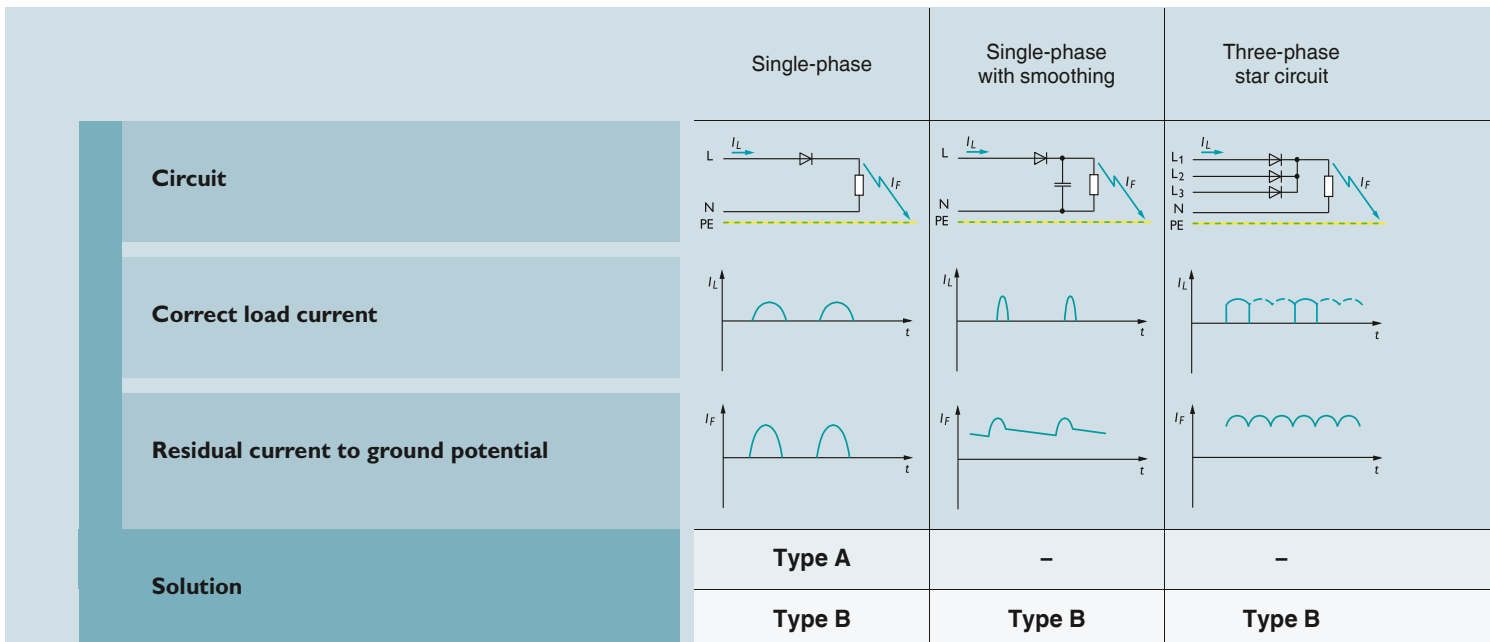

Residual currents can increase continually due to gradual processes. This can be attributed to humidity or conductive dirt on live parts, for example. Residual current circuit breakers trip at different rated residual currents $I_{\Delta n}$, depending on their type. Additionally installed residual current monitoring devices prevent sudden system downtimes thanks to early warnings. The continuous supply of information about gradually increasing residual currents allows timely intervention. Unplanned system failures can be avoided.

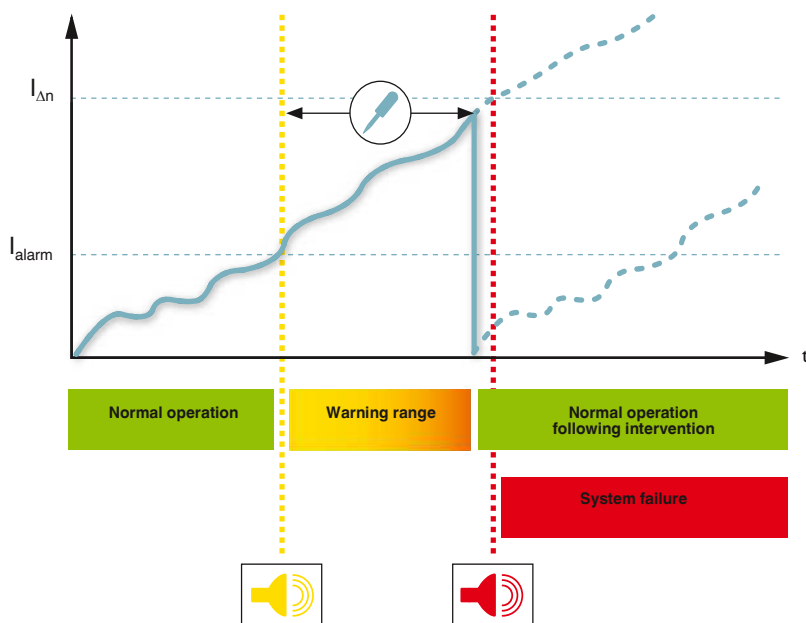

| Full bridge circuit | Semi-controlled full bridge circuit | Full bridge circuit between phase conductors | Three-phase full bridge circuit | Phase-controlled modulator | Burst control |
|---------------------|-------------------------------------|--|---------------------------------|----------------------------|---------------|
| | | | | | |
| | | | | | |
| | | | | | |
| Type A | Type A | – | – | Type A | Type A |
| Type B | Type B | Type B | Type B | Type B | Type B |

Monitoring

Residual current monitoring

Residual current monitoring - RCM

- Adjustable residual response current of 30 mA to 3 A
- Adjustable pre-alarm threshold and delay time
- Actual differential current can be read via LED display
- Remote signaling for main and pre-alarm



kHz



RCM type B+ for smooth and pulsating DC and AC residual currents up to 100 kHz



Converter for RCM type B+

Notes:
Cables for type B+ converter connection (RJ45, 4-pair, 1:1 line) can be found in the accessories section by entering the order number (RCM/converter) at: www.phoenixcontact.net/products

Total width 71.6 mm



Total width 65.5 mm



Technical data

| | |
|---|---|
| Electrical data | 85 V AC ... 264 V AC 50 Hz (60 Hz) - 16 A (B) |
| Nominal voltage range | |
| Nominal frequency f_N | |
| Rated current I_n | |
| Max. required back-up fuse | |
| RCM data | |
| Rated response differential current I_{dyn} | 3 A |
| Differential current acquisition characteristic | Type B+ (DC up to 100 kHz) |
| Response differential current $I_{\Delta n}$ | 30, 100, 300, 1000, 3000 mA (adjustable) |
| Discrimination threshold main alarm | 80% ... 100% (of the set response differential current $I_{\Delta n}$) |
| Discrimination threshold pre-alarm | 10% ... 90% (of the main alarm threshold, adjustable) |
| Response time for $2 \times I_{\Delta n}$ | 0.1 s ... 1 s (adjustable) |
| Thermal permanent differential current $I_{\Delta th}$ | - |
| Thermal rated short-time differential current $I_{\Delta th}$ | - |
| Rated surge voltage resistance U_{imp} | 4 kV |
| General data | |
| Connection data solid / stranded / AWG | 0.2 ... 4 mm ² / 0.2 ... 2.5 mm ² / 24 - 12 |
| Maximum permissible outside diameter of cables | - |
| Housing material | polycarbonate |
| Ambient temperature (operation) | -25°C ... 65°C |
| Degree of protection | IP20 |
| Test standards | DIN EN 62020 / DIN EN 60664 / DIN VDE 0664-110 |
| Test standards | - |
| Pollution degree | 2 |
| Surge voltage category | III |
| Mounting | |
| Mounting type | DIN rail: 35 mm |
| Remote indication contact | PDT contact |
| Connection data solid / stranded / AWG | 0.2 ... 4 mm ² / 0.2 ... 2.5 mm ² / - |
| Max. operating voltage | 230 V AC |
| Max. operating current | 5 A (cos phi > 0.9) |

Technical data

| ...SCT-35 | ...SCT-70 | ...SCT-105 |
|-----------------------------|--|--|
| - | - | - |
| 125 A | 200 A | 300 A |
| - | - | - |
| 3 A | 3 A | 3 A |
| Type B+ (DC up to 100 kHz) | Type B+ (DC up to 100 kHz) | Type B+ (DC up to 100 kHz) |
| 0.03 A ... 3 A | 0.03 A ... 3 A | 0.1 A ... 3 A |
| - | - | - |
| - | - | - |
| 150 A (50 Hz/20 kHz) | 150 A (50 Hz/20 kHz) | 150 A (50 Hz/20 kHz) |
| 3 kA for 1 s (50 Hz/20 kHz) | 3 kA for 1 s (50 Hz/20 kHz) | 3 kA for 1 s (50 Hz/20 kHz) |
| 8 kV | 8 kV | 8 kV |
| 23.00 mm | 46.00 mm | 70.00 mm |
| | polycarbonate | polycarbonate |
| | -20°C ... 65°C | -20°C ... 65°C |
| | IP20 | IP20 |
| | DIN EN 62020 / VDE 0663 / DIN EN 60044-1 / VDE 0414 / DIN V VDE V 0664-110 | DIN EN 62020 / VDE 0663 / DIN EN 60044-1 / VDE 0414 / DIN V VDE V 0664-110 |
| 2 | 2 | 2 |
| IV | IV | IV |
| Screw mounting | Screw mounting | Screw mounting |
| - | - | - |
| - | - | - |
| - | - | - |

Ordering data

| Description | Type | Order No. | Pcs. / Pkt. |
|----------------------------|-------------------------|----------------|-------------|
| Evaluation unit | | | |
| Current transformer | | | |
| 20 mm Ø | | | |
| 30 mm Ø | | | |
| 35 mm Ø | | | |
| 70 mm Ø | | | |
| 105 mm Ø | | | |
| 140 mm Ø | | | |
| 210 mm Ø | | | |
| | RCM-B/50/85-264V | 2806210 | 1 |

Ordering data

| Type | Order No. | Pcs. / Pkt. |
|----------------------|----------------|-------------|
| RCM-B-SCT- 35 | 2806223 | 1 |
| RCM-B-SCT- 70 | 2806236 | 1 |
| RCM-B-SCT-105 | 2806249 | 1 |



RCM type A for pulsating DC and AC residual currents with 50/60 Hz



Converter for RCM type A



Converter for RCM type A

Total width 71.6 mm

Total width 32 mm

Total width 33 mm

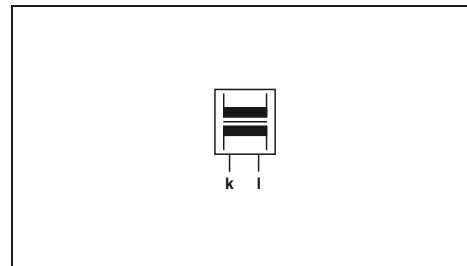

| Technical data |
|---|
| 85 V AC ... 264 V AC |
| 50 Hz (60 Hz) |
| - |
| 16 A (B) |
| 3 A |
| Type A |
| (50 / 60 Hz) |
| 30, 100, 300, 1000, 3000 mA (adjustable) |
| 80% ... 100% (of the set response differential current $I_{\Delta n}$) |
| 10% ... 90% (of the main alarm threshold, adjustable) |
| 0.1 s ... 1 s (adjustable) |
| - |
| - |
| 4 kV |
| 0.2 ... 4 mm ² / 0.2 ... 2.5 mm ² / 24 - 12 |
| - |
| polycarbonate |
| -25°C ... 65°C |
| IP20 |
| DIN EN 62020 / DIN EN 60664 |
| - |
| 2 |
| III |
| DIN rail: 35 mm |
| PDT contact |
| 0.2 ... 4 mm ² / 0.2 ... 2.5 mm ² / - |
| 230 V AC |
| 5 A (cos phi > 0.9) |

| Technical data | | | | |
|---|---|---|---|--|
| ...SCT-20 | ...SCT-30 | ...SCT-35 | ...SCT-70 | |
| - | - | - | - | |
| 50 A | 100 A | 125 A | 200 A | |
| - | - | - | - | |
| 3 A | 3 A | 3 A | 3 A | |
| Type A | Type A | Type A | Type A | |
| (50 / 60 Hz) | (50 / 60 Hz) | (50 / 60 Hz) | (50 / 60 Hz) | |
| 0.03 A ... 3 A | 0.03 A ... 3 A | 0.03 A ... 3 A | 0.03 A ... 3 A | |
| - | - | - | - | |
| - | - | - | - | |
| 1.5 x I _n | 1.5 x I _n | 1.5 x I _n | 1.5 x I _n | |
| 10 x I _n (for 1 s) | 10 x I _n (for 1 s) | 10 x I _n (for 1 s) | 10 x I _n (for 1 s) | |
| 8 kV | 8 kV | 8 kV | 8 kV | |
| 0.2 ... 4 mm ² / 0.2 ... 2.5 mm ² / 24 - 12 | 0.2 ... 4 mm ² / 0.2 ... 2.5 mm ² / 24 - 12 | 0.2 ... 4 mm ² / 0.2 ... 2.5 mm ² / 24 - 12 | 0.2 ... 4 mm ² / 0.2 ... 2.5 mm ² / 24 - 12 | |
| 13.00 mm | 20.00 mm | 23.00 mm | 46.00 mm | |
| | polycarbonate | polycarbonate | polycarbonate | |
| | -20°C ... 65°C | -20°C ... 65°C | -20°C ... 65°C | |
| | IP20 (terminal blocks) | IP20 (terminal blocks) | IP20 (terminal blocks) | |
| | DIN EN 62020 / VDE 0663 / DIN EN 60044-1 / VDE 0414 | DIN EN 62020 / VDE 0663 / DIN EN 60044-1 / VDE 0414 | DIN EN 62020 / VDE 0663 / DIN EN 60044-1 / VDE 0414 | |
| 2 | 2 | 2 | 2 | |
| IV | IV | IV | IV | |
| DIN rail: 35 mm | DIN rail: 35 mm | Screw mounting | Screw mounting | |
| | | - | - | |
| | | - | - | |
| | | - | - | |

| Technical data | | |
|---|---|---|
| ...SCT-105 | ...SCT-140 | ...SCT-210 |
| - | - | - |
| 250 A | 350 A | 400 A |
| - | - | - |
| 3 A | 3 A | 3 A |
| Type A | Type A | Type A |
| (50 / 60 Hz) | (50 / 60 Hz) | (50 / 60 Hz) |
| 0.03 A ... 3 A | 0.03 A ... 3 A | 0.03 A ... 3 A |
| - | - | - |
| - | - | - |
| 1.5 x I _n | 1.5 x I _n | 1.5 x I _n |
| 10 x I _n (for 1 s) | 10 x I _n (for 1 s) | 10 x I _n (for 1 s) |
| 8 kV | 8 kV | 8 kV |
| 0.2 ... 4 mm ² / 0.2 ... 2.5 mm ² / 24 - 12 | 0.2 ... 4 mm ² / 0.2 ... 2.5 mm ² / 24 - 12 | 0.2 ... 4 mm ² / 0.2 ... 2.5 mm ² / 24 - 12 |
| 70.00 mm | 93.00 mm | 140.00 mm |
| | polycarbonate | polycarbonate |
| | -20°C ... 65°C | -20°C ... 65°C |
| | IP20 (terminal blocks) | IP20 (terminal blocks) |
| | DIN EN 62020 / VDE 0663 / DIN EN 60044-1 / VDE 0414 | DIN EN 62020 / VDE 0663 / DIN EN 60044-1 / VDE 0414 |
| 2 | 2 | 2 |
| IV | IV | IV |
| Screw mounting | Screw mounting | Screw mounting |
| | | - |
| | | - |
| | | - |

| Ordering data | | |
|------------------|-----------|-------------|
| Type | Order No. | Pcs. / Pkt. |
| RCM-A/50/85-264V | 2806016 | 1 |

| Ordering data | | |
|---------------|-----------|-------------|
| Type | Order No. | Pcs. / Pkt. |
| RCM-A-SCT- 20 | 2806045 | 1 |
| RCM-A-SCT- 30 | 2806058 | 1 |
| RCM-A-SCT- 35 | 2806061 | 1 |
| RCM-A-SCT- 70 | 2806074 | 1 |

| Ordering data | | |
|---------------|-----------|-------------|
| Type | Order No. | Pcs. / Pkt. |
| RCM-A-SCT-105 | 2806087 | 1 |
| RCM-A-SCT-140 | 2806090 | 1 |
| RCM-A-SCT-210 | 2806100 | 1 |



EV Charge Control charging controller

EV Charge Control is the charging controller used to charge electric vehicles on the AC mains according to IEC 61851-1.

The control and monitoring functions that are defined here for charging mode 3 serve as the basis for the equipment.

- Control Pilot evaluation and control
- Monitoring of the PE protective ground connection
- Evaluation of the proximity
- Control of the charge contactor and locking actuators

Plug-in charging systems

For information on plug-in charging systems, see Catalog 2, connection technology for field devices.

Additional functions:

All necessary control functions are integrated in a single device. No additional controller is required.

- Easy configuration directly at the device or via the integrated web server
- Adjustable charging current limitation of 6 ... 80 A
- Parameterizable automatic rejection of charging cables with low current carrying capacity
- Automatic or manual locking as well as selection of DC motor or magnetic locking actuators
- Optional locking confirmation and external enabling as a switching requirement
- Integration into your charging infrastructure via Ethernet interface (Modbus/TCP)
- Charging process enabling, status requests, and dynamic load management via remote access
- 4 digital inputs and 4 digital outputs
- Two digital outputs configurable via web server
- 4 relay outputs

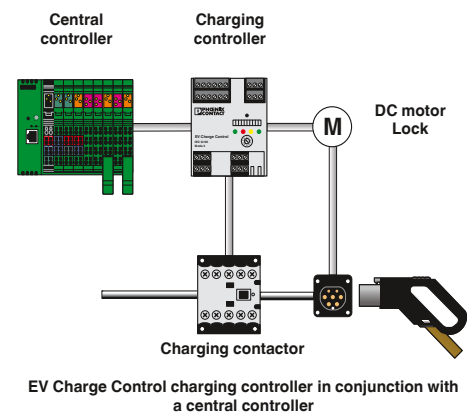
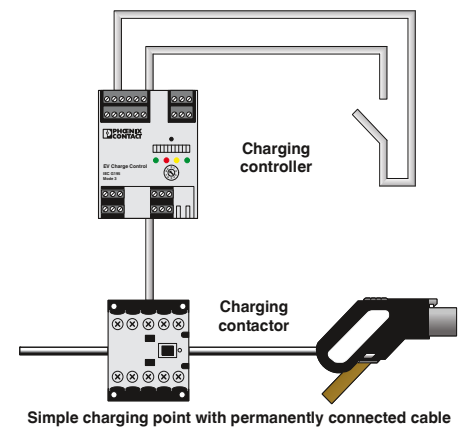

EV Charge Control charging controller

EV Charge Control

- Charging controller for charging electric vehicles on AC mains according to IEC 61851-1.

EV Charge Lock Release

- Optional extension module for plug release in the event of mains failure.



Charging controller



Mains power failure plug enable

Notes:
For information on plug-in charging systems, see Catalog 2, connection technology for field devices.

Housing width 71.6 mm

Technical data

| Input | |
|---|---|
| Description of the input | Digital input |
| Nominal input voltage U_N | 24 V |
| Input current | 8 mA (24 V) |
| Input ranges | -3 V ... 5 V (Off) 15 V ... 30 V (On) |
| Switching output | |
| Output description | Relay output $C_{1,2}$ and $V_{1,2}$ |
| Maximum switching voltage | 250 V AC |
| Maximum switching current | 6 A |
| Switching output | |
| Output description | Relay output $R_{1,3}$ and $R_{2,4}$ |
| Maximum switching voltage | 30 V AC/DC |
| Maximum switching current | 6 A |
| Switching output | |
| Output description | Digital output |
| Maximum output voltage | 30 V |
| Maximum output current | 0.6 A |
| Ethernet interface | |
| Connection method | RJ45 socket |
| Transmission speed | 10/100 Mbps |
| Transmission length | 100 m (with shielded, twisted-pair data cable) |
| General data | |
| Supply voltage | |
| Supply voltage range | 110 V AC ... 240 V AC (nominal voltage range) 95 V AC ... 264 V AC |
| Maximum current consumption | 40 mA |
| Own current consumption | - |
| Frequency range | 45 Hz ... 65 Hz |
| Degree of protection | IP20 |
| Ambient temperature range | -25°C ... 60°C |
| Dimensions W / H / D | 71.6 / 61 / 90 mm |
| Screw connection solid / stranded / AWG | 0.2 ... 4 mm ² / 0.2 ... 2.5 mm ² / 24 - 12 |
| Conformance / approvals | |
| Conformance | CE-compliant |

Housing width 35.6 mm

Technical data

| Input | |
|---|--|
| Description of the input | Signal input |
| Nominal input voltage U_N | 12 V |
| Input current | Approx. 5 mA (at 12 V) |
| Input ranges | -3 V ... 3 V (Off) -30 V ... -10 V (Locking ON) 10 V ... 30 V (Unlocking ON) |
| Switching output | |
| Output description | Relay output |
| Maximum switching voltage | Approx. 11.5 V (Operating/capacitor voltage minus the diode voltage of ~ 0.5 V) |
| Maximum switching current | 4 A |
| Switching output | |
| Output description | - |
| Maximum switching voltage | - |
| Maximum switching current | - |
| Switching output | |
| Output description | - |
| Maximum output voltage | - |
| Maximum output current | - |
| Ethernet interface | |
| Connection method | - |
| Transmission speed | - |
| Transmission length | - |
| General data | |
| Supply voltage | |
| Supply voltage range | 12 V DC ±5% |
| Maximum current consumption | - |
| Own current consumption | 4 A (4 mA in idle state) |
| Frequency range | - |
| Degree of protection | IP20 |
| Ambient temperature range | -25°C ... 60°C |
| Dimensions W / H / D | 35.6 / 61 / 90 mm |
| Screw connection solid / stranded / AWG | 0.2 ... 4 mm ² / 0.2 ... 2.5 mm ² / 24 - 12 |
| Conformance / approvals | |
| Conformance | CE-compliant |

Ordering data

| Description | Type | Order No. | Pcs. / Pkt. |
|---------------------------------------|--------------|-----------|-------------|
| EV Charge Control charging controller | EM-CP-PP-ETH | 2902802 | 1 |

Ordering data

| Description | Type | Order No. | Pcs. / Pkt. |
|---|---------------|-----------|-------------|
| Mains failure plug release EV Charge Lock Release | EM-EV-CLR-12V | 2903246 | 1 |



For high system availability

EMD monitoring relays can be used to detect deviations in important system parameters at an early stage. These can be indicated or system parts can be shut down selectively. EMD monitoring relays ensure error-free and cost-effective operation of your system. They are an inexpensive solution for numerous monitoring functions.

- Surge voltage and undervoltage
- Overcurrent and undercurrent
- Phase failure, phase sequence, and phase asymmetry
- Power factor and real power
- Motor winding temperature
- Levels

For system monitoring, choose from two product ranges: compact or multifunctional monitoring relays.

Perfect timing

ETD timer relays ensure optimum time sequences.

The modules are the cost-effective alternative to a PLC: with easy configuration and fast wiring.

Choose from two product ranges for your ideal time control application:

- Ultra-narrow timer relays each with one time range and one function
- Multifunctional timer relays with selectable time ranges and functions

Professionally packaged components

Special function modules with professional housing and connection technology can be used to integrate electronic components in your system. They can be used to perform a variety of tasks:

- Diode modules provide protection against polarity reversal. In addition, they decouple messages in fault reporting systems.
- Lamp testing modules decouple signals in isolation in the field of fault reporting technology.
- Display modules simplify troubleshooting and provide help for monitoring processes.



Compact monitoring relays

- Ideal for simple monitoring tasks – from series production to building installation.
- Compact installation housing
 - Quick and tool-free wiring with push-in technology
 - Parameters can be adjusted easily using rotary switches
 - Clear diagnostics, thanks to color status LED



Multifunctional monitoring relays

- Parameters can be adjusted easily using rotary switches
- Fast error detection, thanks to fine tuning and short response times
- Worldwide use, thanks to wide-range power supply unit or plug-in transformer
- Space saving – with two PDT outputs in 22.5 mm wide housing
- Electrically isolated measuring and supply circuits
- Clear diagnostics, thanks to color status LEDs



Ultra-narrow timer relays

- The space-saving and inexpensive solution for simple time control applications.
- Each with one time range and one function
 - Design width of just 6.2 mm - saves up to 70% space compared to conventional timer relays
 - Precise time setting using the illuminated thumbwheel
 - Fast wiring through the use of plug-in bridges



Multifunctional timer relays

- For universal use thanks to wide range of functions.
- Just three versions for all conventional time control applications.
 - Two floating PDT outputs on a design width of just 22.5 mm
 - Supply voltage via wide-range power supply unit
 - Optimum setting of times ranging from milliseconds to several days



Special function modules

- Special function modules transform components such as diodes into a shock-proof and dust-proof electronics module.
- Easy installation, thanks to electronics housing with IP20 protection that can be installed in a control cabinet
 - Fast mounting on DIN rails, thanks to the foot catch
 - User-friendly wiring, thanks to practical connection technology

Monitoring

Monitoring relays, timer relays, special function modules

Single-phase current and voltage monitoring

Single-phase current monitoring

- The **EMD-BL-C-10** monitors AC currents from 0 ... 10 A.
- Adjustable response delay
- 0 ... 5 A or 0 ... 10 A measuring range
- Adjustable via rotary switch on the front

Single-phase voltage monitoring

- The **EMD-BL-V-230** monitors DC and AC voltages.
- 24 V AC/DC or 230 V AC
- Separately adjustable response delay
- Adjustable monitoring range
- Adjustable via potentiometer on the front



Current monitoring, 1-phase
Overcurrent, undercurrent, window



Voltage monitoring, 1-phase
Undervoltage, window

Housing width 17.5 mm



Technical data

Overcurrent, undercurrent, window

0 A ... 5 A AC
0 A ... 10 A AC
(Configurable via rotary switches)
3 mΩ
5% ... 95% (From I_N)
10% ... 100% (From I_N)
0.1 s ... 10 s
≤ 5% (of the nominal value)
±5% (of the nominal value)
≤ 2%

1 floating PDT
1250 VA (5 A/250 V AC)
1 x 10⁵ cycles
15 x 10⁶ cycles
5 A (fast-blow)

230 V AC ±15%
5 VA (0.8 W)

Degree of protection IP40 (housing) / IP20 (connection terminal blocks)

Ambient temperature range -25°C ... 55°C
Dimensions W / H / D 17.5 / 88 / 65.5 mm
Connection data solid / stranded / AWG 0.5 ... 2.5 mm² / 0.5 ... 2.5 mm² / 20 - 14

Conformance / approvals CE-compliant

Ordering data

Description

Compact monitoring relays with push-in connection

Compact monitoring relays with screw connection

| Type | Order No. | Pcs. / Pkt. |
|----------------|-----------|-------------|
| EMD-BL-C-10-PT | 2903522 | 1 |
| EMD-BL-C-10 | 2903521 | 1 |

Housing width 17.5 mm

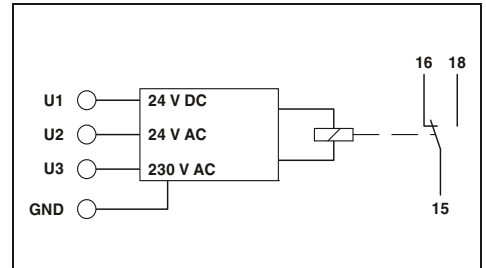

Technical data

Undervoltage, window

0 V DC ... 24 V DC (connection terminal blocks: U1 and GND)
0 V AC ... 24 V AC (connection terminal blocks: U2 and GND)
0 V AC ... 230 V AC (connection terminal blocks: U3 and GND)

75% ... 115% (From U_N)
80% ... 120% (From U_N)
0.1 s ... 10 s
≤ 5% (of scale end value)
±5% (of scale end value)
≤ 2%

1 floating PDT
1250 VA (5 A/250 V AC)
1 x 10⁵ cycles
15 x 10⁶ cycles
5 A (fast-blow)

-25% ... +20% (= measuring voltage)
10 VA (At 230 V AC (0.6 W))
1.3 VA (At 24 V AC (0.8 W))
0.6 W (at 24 V DC)

IP40 (housing) / IP20 (connection terminal blocks)

Ambient temperature range -25°C ... 55°C
Dimensions W / H / D 17.5 / 88 / 65.5 mm
Connection data solid / stranded / AWG 0.5 ... 2.5 mm² / 0.5 ... 2.5 mm² / 20 - 14

Conformance / approvals CE-compliant

Ordering data

| Type | Order No. | Pcs. / Pkt. |
|-----------------|-----------|-------------|
| EMD-BL-V-230-PT | 2903524 | 1 |
| EMD-BL-V-230 | 2903523 | 1 |

Three-phase voltage monitoring, phase monitoring

Three-phase voltage monitoring

- The **EMD-BL-3V-400** monitors three-phase AC voltages.
- 3~ 400 V AC/230 V AC ±30%
- Separately adjustable response delay
- Adjustable monitoring range
- Adjustable via potentiometer on the front
- Supply from the measuring circuit

Phase monitoring

- The **EMD-BL-PH-400** monitors three-phase AC voltages.
- 3~ 208 ... 480 V AC/120 ... 277 V AC
- Adjustable response delay
- Adjustable asymmetry: 5 ... 25%/OFF
- Adjustable via potentiometer on the front
- Supply from the measuring circuit



Voltage monitoring, 3-phase
Window, phase sequence



Phase monitoring
Phase sequence, phase failure, asymmetry

Housing width 17.5 mm

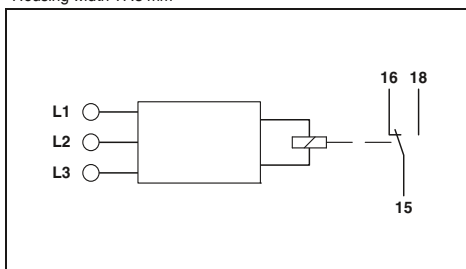

Housing width 17.5 mm

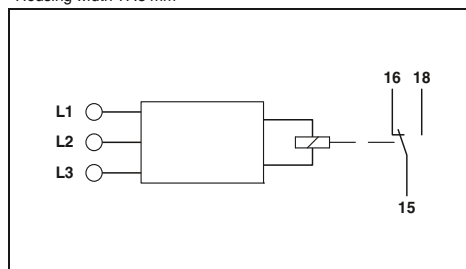

Technical data

Window, phase sequence

280 V AC ... 519 V AC
3~ 400/230 V
-
70% ... 120% (From U_N)
80% ... 130% (From U_N)
0.1 s ... 10 s
-
≤ 5% (of the nominal value)
±5% (of scale end value)
≤ 2%

Functions

Input
Monitoring range
Input ranges
Input resistance
Min. setting range
Max. setting range
Setting range for response delay
Asymmetry
Basic accuracy
Setting accuracy
Repeat accuracy
Relay output
Contact type
Switching capacity
Electrical service life
Mechanical service life
Output fuse
General data
Supply voltage
Nominal power consumption

Degree of protection

Ambient temperature range
Dimensions W / H / D
Connection data solid / stranded / AWG
Conformance / approvals
Conformance

Ordering data

| Type | Order No. | Pcs. / Pkt. |
|------------------|-----------|-------------|
| EMD-BL-3V-400-PT | 2903526 | 1 |
| EMD-BL-3V-400 | 2903525 | 1 |

Technical data

Phase sequence, phase failure, asymmetry

187 V AC ... 519 V AC
3~ 208 ... 480 V/120 ... 277 V
-
-
-
0.1 s ... 10 s
5% ... 25% / OFF
≤ 5% (of scale end value)
±5% (of scale end value)
≤ 2%

1 floating PDT
1250 VA (5 A/250 V AC)
1 x 10⁵ cycles
15 x 10⁶ cycles
5 A (fast-blow)

±10% (= measuring voltage)
10 VA ((1 W) at 400 V/50 Hz)
16 VA ((1.5 W) at 480 V/60 Hz)
IP40 (housing) / IP20 (connection terminal blocks)

-25°C ... 55°C
17.5 / 88 / 65.5 mm
0.5 ... 2.5 mm² / 0.5 ... 2.5 mm² / 20 - 14

CE-compliant

Ordering data

| Type | Order No. | Pcs. / Pkt. |
|------------------|-----------|-------------|
| EMD-BL-PH-480-PT | 2903528 | 1 |
| EMD-BL-PH-480 | 2903527 | 1 |

Description
Compact monitoring relays with push-in connection
Compact monitoring relays with screw connection

Monitoring

Monitoring relays, timer relays, special function modules

Single-phase current monitoring

EMD-...C... monitoring relays monitor DC and AC currents within the range 0 ... 10 A.

- Separately adjustable startup and release delays
- Variable supply voltage range
- Adjustable via potentiometer on front

Notes:
1) EMC: Class A product, see page 571



Overcurrent and undercurrent monitoring



Overcurrent or undercurrent monitoring

Housing width 22.5 mm

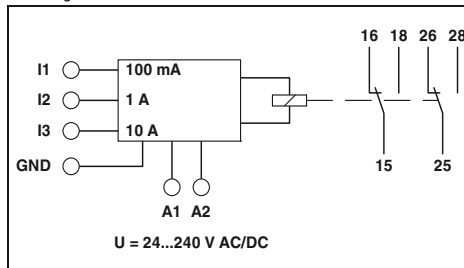

Technical data

| | |
|---|---|
| Functions | Overcurrent, undercurrent, window, error memory |
| Input | 0 mA ... 100 mA AC/DC (Connection terminals: I1 and GND) 0 A ... 1 A AC/DC (Connection terminals: I2 and GND) 0 A ... 10 A AC/DC (Connection terminals: I3 and GND) |
| Input ranges | 470 mΩ (at I _N = 100 mA) ; 47 mΩ (at I _N = 1 A) ; 5 mΩ (at I _N = 10 A) |
| Input resistance | 470 mΩ (at I _N = 100 mA) ; 47 mΩ (at I _N = 1 A) ; 5 mΩ (at I _N = 10 A) |
| Min. setting range | 5% ... 95% (From I _N) |
| Max. setting range | 10% ... 100% (From I _N) |
| Setting range for response delay | 0.1 s ... 10 s |
| Setting range for starting delay | 0 s ... 10 s |
| Basic accuracy | ±5% (of scale end value) |
| Setting accuracy | ≤ 5% (of scale end value) |
| Repeat accuracy | ≤ 2% |
| Relay output | 2 floating PDT contacts |
| Contact type | 750 VA (3 A/250 V AC, module aligned, ≤ 5 mm spacing) 1250 VA (5 A/250 V AC, module not aligned, ≥ 5 mm spacing) |
| Switching capacity | 750 VA (3 A/250 V AC, module aligned, ≤ 5 mm spacing) 1250 VA (5 A/250 V AC, module not aligned, ≥ 5 mm spacing) |
| Electrical service life | 2 x 10 ⁵ cycles at ohmic load, 1000 VA |
| Mechanical service life | Approx. 2 x 10 ⁷ cycles |
| Output fuse | 5 A (fast-blow) |
| General data | |
| Supply voltage | 4.5 VA (1.5 W) |
| Nominal power consumption | IP40 (housing) / IP20 (connection terminal blocks) |
| Degree of protection | -25°C ... 55°C |
| Ambient temperature range | 22.5 / 90 / 113 mm |
| Dimensions W / H / D | 0.5 ... 2.5 mm ² / 0.25 ... 2.5 mm ² / 20 - 14 |
| Screw connection solid / stranded / AWG | |
| Conformance / approvals | CE-compliant UL/C-UL listed UL 508 |

Housing width 22.5 mm

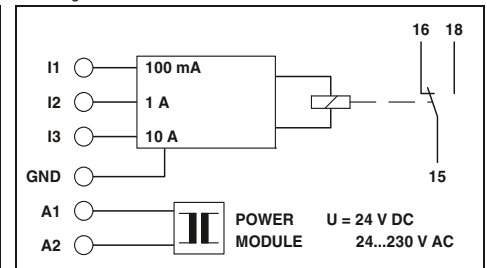

Technical data

| | |
|---|---|
| EMD-SL-C-OC-10 | EMD-SL-C-UC-10 |
| Overcurrent | Undercurrent |
| 0 mA ... 100 mA AC/DC (Connection terminals: I1 and GND) 0 A ... 1 A AC/DC (Connection terminals: I2 and GND) 0 A ... 10 A AC/DC (Connection terminals: I3 and GND) | 0 mA ... 100 mA AC/DC (Connection terminals: I1 and GND) 0 A ... 1 A AC/DC (Connection terminals: I2 and GND) 0 A ... 10 A AC/DC (Connection terminals: I3 and GND) |
| 470 mΩ (at I _N = 100 mA) ; 47 mΩ (at I _N = 1 A) ; 5 mΩ (at I _N = 10 A) | 470 mΩ (at I _N = 100 mA) ; 47 mΩ (at I _N = 1 A) ; 5 mΩ (at I _N = 10 A) |
| 5% ... 95% (From I _N) | 5% ... 95% (From I _N) |
| 10% ... 100% (From I _N) | 10% ... 100% (From I _N) |
| 0.2 s ... 10 s | 0.2 s ... 10 s |
| - | - |
| ±5% (of scale end value) | ±5% (of scale end value) |
| ≤ 5% (of scale end value) | ≤ 5% (of scale end value) |
| ≤ 2% | ≤ 2% |
| 1 floating PDT | 1 floating PDT |
| 750 VA (3 A/250 V AC, module aligned, ≤ 5 mm spacing) 1250 VA (5 A/250 V AC, module not aligned, ≥ 5 mm spacing) | 750 VA (3 A/250 V AC, module aligned, ≤ 5 mm spacing) 1250 VA (5 A/250 V AC, module not aligned, ≥ 5 mm spacing) |
| 2 x 10 ⁵ cycles at ohmic load, 1000 VA | 2 x 10 ⁵ cycles at ohmic load, 1000 VA |
| Approx. 2 x 10 ⁷ cycles | Approx. 2 x 10 ⁷ cycles |
| 5 A (fast-blow) | 5 A (fast-blow) |
| 2 VA (1.5 W) | 2 VA (1.5 W) |
| IP40 (housing) / IP20 (connection terminal blocks) | IP40 (housing) / IP20 (connection terminal blocks) |
| -25°C ... 55°C | -25°C ... 55°C |
| 22.5 / 90 / 113 mm | 22.5 / 90 / 113 mm |
| 0.5 ... 2.5 mm ² / 0.25 ... 2.5 mm ² / 20 - 14 | 0.5 ... 2.5 mm ² / 0.25 ... 2.5 mm ² / 20 - 14 |
| CE-compliant | CE-compliant |
| UL/C-UL listed UL 508 | UL/C-UL listed UL 508 |

Ordering data

| Description | Type | Order No. | Pcs. / Pkt. |
|--|---------------------------|-----------|-------------|
| Electronic monitoring relay | EMD-FL-C-10 ¹⁾ | 2866022 | 1 |
| Power module, plug-in, please order at the same time! | | | |
| Supply voltage 20 ... 30 V DC | | | |
| Supply voltage 20.2 ... 26.4 V AC | | | |
| Supply voltage 88 ... 121 V AC | | | |
| Supply voltage 108 ... 132 V AC | | | |
| Supply voltage 195 ... 264 V AC | | | |

Ordering data

| Type | Order No. | Pcs. / Pkt. |
|-----------------|-----------|-------------|
| EMD-SL-C-OC-10 | 2866019 | 1 |
| EMD-SL-C-UC-10 | 2867937 | 1 |
| EMD-SL-PS- 24DC | 2885359 | 1 |
| EMD-SL-PS- 24AC | 2866103 | 1 |
| EMD-SL-PS-110AC | 2866116 | 1 |
| EMD-SL-PS-120AC | 2885731 | 1 |
| EMD-SL-PS-230AC | 2866129 | 1 |

Single-phase voltage monitoring

- EMD-...V...** monitoring relays monitor DC and AC voltages within the range 0 ... 300 V.
- Separately adjustable startup and release delays
 - Variable supply voltage range
 - Adjustable via potentiometer on front

Notes:
1) EMC: Class A product, see page 571



Undervoltage and overvoltage monitoring



Undervoltage monitoring

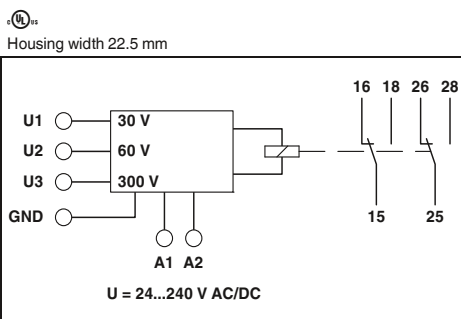

Technical data

| | |
|---|--|
| Functions | Undervoltage, overvoltage, window, error memory |
| Input | 0 V ... 30 V AC/DC (connection terminal blocks: U1 and GND) 0 V ... 60 V AC/DC (connection terminal blocks: U2 and GND) 0 V ... 300 V AC/DC (connection terminal blocks: U3 and GND) |
| Input ranges | 47 kΩ (connection terminal blocks: U1 and GND) 100 kΩ (connection terminal blocks: U2 and GND) 470 kΩ (connection terminal blocks: U3 and GND) |
| Input resistance | 5% ... 95% (From U _N) 10% ... 100% (From U _N) 0.1 s ... 10 s 0 s ... 10 s |
| Min. setting range | ±5% (of scale end value) |
| Max. setting range | ≤ 5% (of scale end value) |
| Setting range for response delay | ≤ 2% |
| Setting range for starting delay | 2 floating PDT contacts |
| Basic accuracy | 750 VA (3 A/250 V AC, module aligned, ≤ 5 mm spacing) 1250 VA (5 A/250 V AC, module not aligned, ≥ 5 mm spacing) |
| Setting accuracy | 2 x 10 ⁵ cycles at ohmic load, 1000 VA |
| Repeat accuracy | Approx. 2 x 10 ⁷ cycles |
| Relay output | 5 A (fast-blow) |
| Contact type | 4.5 VA (1.5 W) |
| Switching capacity | IP40 (housing) / IP20 (connection terminal blocks) -25°C ... 55°C |
| Electrical service life | 22.5 / 90 / 113 mm |
| Mechanical service life | 0.5 ... 2.5 mm ² / 0.25 ... 2.5 mm ² / 20 - 14 |
| Output fuse | CE-compliant |
| General data | UL/C-UL listed UL 508 |
| Supply voltage | |
| Nominal power consumption | |
| Degree of protection | |
| Ambient temperature range | |
| Dimensions W / H / D | |
| Screw connection solid / stranded / AWG | |
| Conformance / approvals | |
| Conformance | |
| UL, USA / Canada | |

Ordering data

| Type | Order No. | Pcs. / Pkt. |
|---------------|-----------|-------------|
| EMD-FL-V-3001 | 2866048 | 1 |

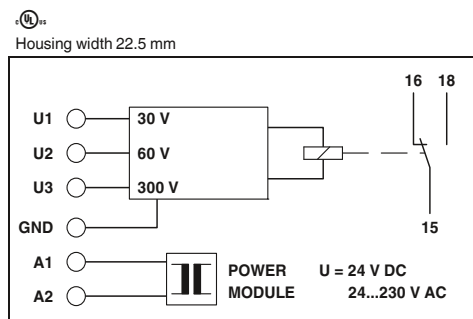

Technical data

| | |
|---|--|
| Functions | Undervoltage |
| Input | 0 V ... 30 V AC/DC (connection terminal blocks: U1 and GND) 0 V ... 60 V AC/DC (connection terminal blocks: U2 and GND) 0 V ... 300 V AC/DC (connection terminal blocks: U3 and GND) |
| Input ranges | 47 kΩ (connection terminal blocks: U1 and GND) 100 kΩ (connection terminal blocks: U2 and GND) 470 kΩ (connection terminal blocks: U3 and GND) |
| Input resistance | 5% ... 95% (From U _N) 10% ... 100% (From U _N) 0.2 s ... 10 s - |
| Min. setting range | ±5% (of scale end value) |
| Max. setting range | ≤ 5% (of scale end value) |
| Setting range for response delay | ≤ 2% |
| Setting range for starting delay | 1 floating PDT |
| Basic accuracy | 750 VA (3 A/250 V AC, module aligned, ≤ 5 mm spacing) 1250 VA (5 A/250 V AC, module not aligned, ≥ 5 mm spacing) |
| Setting accuracy | 2 x 10 ⁵ cycles at ohmic load, 1000 VA |
| Repeat accuracy | Approx. 2 x 10 ⁷ cycles |
| Relay output | 5 A (fast-blow) |
| Contact type | 2 VA (1.5 W) |
| Switching capacity | IP40 (housing) / IP20 (connection terminal blocks) -25°C ... 55°C |
| Electrical service life | 22.5 / 90 / 113 mm |
| Mechanical service life | 0.5 ... 2.5 mm ² / 0.25 ... 2.5 mm ² / 20 - 14 |
| Output fuse | CE-compliant |
| General data | UL/C-UL listed UL 508 |
| Supply voltage | |
| Nominal power consumption | |
| Degree of protection | |
| Ambient temperature range | |
| Dimensions W / H / D | |
| Screw connection solid / stranded / AWG | |
| Conformance / approvals | |
| Conformance | |
| UL, USA / Canada | |

Ordering data

| Type | Order No. | Pcs. / Pkt. |
|-----------------|-----------|-------------|
| EMD-SL-V-UV-300 | 2866035 | 1 |
| EMD-SL-PS-24DC | 2885359 | 1 |
| EMD-SL-PS-24AC | 2866103 | 1 |
| EMD-SL-PS-110AC | 2866116 | 1 |
| EMD-SL-PS-120AC | 2885731 | 1 |
| EMD-SL-PS-230AC | 2866129 | 1 |

| Description |
|--|
| Electronic monitoring relay |
| Power module, plug-in, please order at the same time! |
| Supply voltage 20 ... 30 V DC |
| Supply voltage 20.2 ... 26.4 V AC |
| Supply voltage 88 ... 121 V AC |
| Supply voltage 108 ... 132 V AC |
| Supply voltage 195 ... 264 V AC |

Monitoring

Monitoring relays, timer relays, special function modules

Three-phase voltage monitoring

EMD-...-3V... monitoring relays monitor three-phase AC voltages of 160 ... 897 V AC (depending on the device concerned).

- Adjustable response delay
- Variable supply voltage range
- Adjustable via potentiometer on front
- Adjustable asymmetry

Notes:
1) EMC: Class A product, see page 571

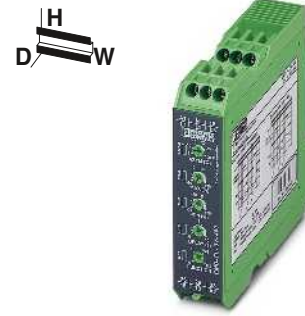

Undervoltage and phase monitoring, 400 V or 230 V



Housing width 22.5 mm

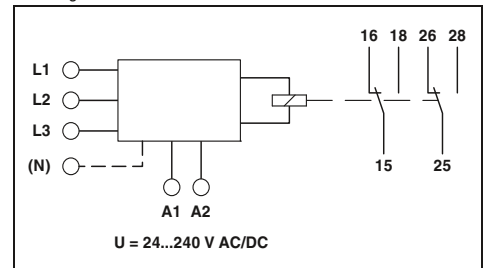

Technical data

| Functions | EMD-FL-3V-400 ¹⁾ Undervoltage, window, asymmetry, phase sequence, phase failure | EMD-FL-3V-230 ¹⁾ Undervoltage, window, asymmetry, phase sequence, phase failure |
|---|---|---|
| Input | | |
| Monitoring range | 280 V AC ... 520 V AC | 161 V AC ... 299 V AC |
| Input ranges | 3 N ~ 400/230 V | 3 N ~ 230/132 V |
| Input resistance | 1 MΩ | 470 kΩ |
| Min. setting range | -30% ... 20% (From U _N) | |
| Max. setting range | -20% ... 30% (From U _N) | |
| Setting range for response delay | 0.1 s ... 10 s | |
| Asymmetry | 5% ... 25% / OFF | 5% ... 25% / OFF |
| Basic accuracy | ±5% (of scale end value) | |
| Setting accuracy | ≤ 5% (of scale end value) | |
| Repeat accuracy | ≤ 2% | |
| Relay output | | |
| Contact type | 2 floating PDT contacts | |
| Switching capacity | 750 VA (3 A/250 V AC, module aligned, ≤ 5 mm spacing) 1250 VA (5 A/250 V AC, module not aligned, ≥ 5 mm spacing) | |
| Electrical service life | 2 x 10 ⁵ cycles at ohmic load, 1000 VA | |
| Mechanical service life | Approx. 2 x 10 ⁷ cycles | |
| Output fuse | 5 A (fast-blow) | |
| General data | | |
| Supply voltage | 4,5 VA (1.5 W) | |
| Nominal power consumption | IP40 (housing) / IP20 (connection terminal blocks) | |
| Degree of protection | -25°C ... 55°C | |
| Ambient temperature range | 22.5 / 90 / 113 mm | |
| Dimensions W / H / D | 0.5 ... 2.5 mm ² / 0.25 ... 2.5 mm ² / 20 - 14 | |
| Screw connection solid / stranded / AWG | | |
| Conformance / approvals | | |
| Conformance | CE-compliant | |
| UL, USA / Canada | UL/C-UL listed UL 508 | |

Ordering data

| Description | Type | Order No. | Pcs. / Pkt. |
|--|-----------------------------|-----------|-------------|
| Electronic monitoring relay | | | |
| Power module, plug-in, please order at the same time! | | | |
| Supply voltage 20 ... 30 V DC | EMD-FL-3V-400 ¹⁾ | 2866064 | 1 |
| Supply voltage 20.2 ... 26.4 V AC | EMD-FL-3V-230 ¹⁾ | 2885773 | 1 |
| Supply voltage 88 ... 121 V AC | | | |
| Supply voltage 108 ... 132 V AC | | | |
| Supply voltage 195 ... 264 V AC | | | |
| Supply voltage 323 ... 456 V AC | | | |

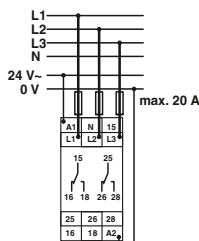

Connection example



**Undervoltage and phase monitoring,
500 V or 690 V**



**Undervoltage/overvoltage monitoring,
400 V with/without neutral conductor**



Phase monitoring, 400 V



Housing width 45 mm

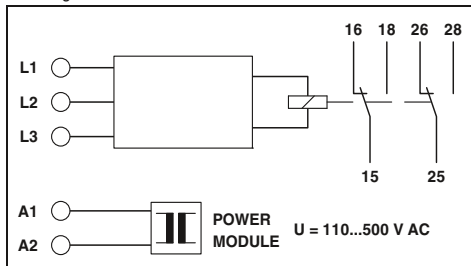

Technical data

| | |
|--|--|
| EMD-FL-3V-690 Undervoltage, window, asymmetry, phase sequence, phase failure | EMD-FL-3V-500 Undervoltage, window, asymmetry, phase sequence, phase failure |
|--|--|

| | |
|---|---|
| 483 V AC ... 897 V AC 3 ~ 690 V 1 MΩ -30% ... 20% (From U _N) -20% ... 30% (From U _N) 0.1 s ... 10 s 5% ... 25% / OFF ±5% (of scale end value) ≤ 5% (of scale end value) ≤ 2% | 350 V AC ... 650 V AC 3 ~ 500 V 1 MΩ -30% ... 20% (From U _N) -20% ... 30% (From U _N) 0.2 s ... 10 s 5% ... 25% / OFF ±5% (of scale end value) ≤ 5% (of scale end value) ≤ 2% |
|---|---|

2 floating PDT contacts
750 VA (3 A/250 V AC, module aligned, ≤ 5 mm spacing)
1250 VA (5 A/250 V AC, module not aligned, ≥ 5 mm spacing)

2 x 10⁶ cycles at ohmic load, 1000 VA
Approx. 2 x 10⁷ cycles
5 A (fast-blow)

4.5 VA (1.5 W)
IP40 (housing) / IP20 (connection terminal blocks)
-25°C ... 55°C
45 / 90 / 113 mm
0.5 ... 2.5 mm² / 0.25 ... 2.5 mm² / 20 - 14

CE-compliant
UL/C-UL listed UL 508

Ordering data

| Type | Order No. | Pcs. / Pkt. |
|--------------------------|-----------|-------------|
| EMD-FL-3V-690 | 2885249 | 1 |
| EMD-FL-3V-500 | 2867979 | 1 |
| EMD-SL-PS45-110AC | 2885281 | 1 |
| EMD-SL-PS45-120AC | 2885744 | 1 |
| EMD-SL-PS45-230AC | 2885294 | 1 |
| EMD-SL-PS45-400AC | 2885304 | 1 |



Housing width 22.5 mm

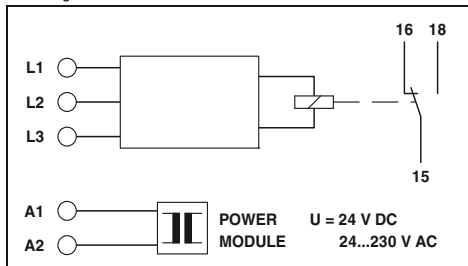

Technical data

| | |
|--|---|
| EMD-SL-3V-400 Window, without neutral conductor connection | EMD-SL-3V-400-N Window, with neutral conductor connection |
|--|---|

| | |
|---|---|
| 280 V AC ... 520 V AC 3 ~ 400 V 1 MΩ -30% ... 20% (From U _N) -20% ... 30% (From U _N) 0.2 s ... 10 s ±5% (of scale end value) ≤ 5% (of scale end value) ≤ 2% | 280 V AC ... 520 V AC 3 N ~ 400/230 V 1 MΩ -30% ... 20% (From U _N) -20% ... 30% (From U _N) 0.2 s ... 10 s ±5% (of scale end value) ≤ 5% (of scale end value) ≤ 2% |
|---|---|

1 floating PDT
750 VA (3 A/250 V AC, module aligned, ≤ 5 mm spacing)
1250 VA (5 A/250 V AC, module not aligned, ≥ 5 mm spacing)

2 x 10⁶ cycles at ohmic load, 1000 VA
Approx. 2 x 10⁷ cycles
5 A (fast-blow)

2 VA (1.5 W)
IP40 (housing) / IP20 (connection terminal blocks)
-25°C ... 55°C
22.5 / 90 / 113 mm
0.5 ... 2.5 mm² / 0.25 ... 2.5 mm² / 20 - 14

CE-compliant
UL/C-UL listed UL 508

Ordering data

| Type | Order No. | Pcs. / Pkt. |
|------------------------|-----------|-------------|
| EMD-SL-3V-400 | 2866051 | 1 |
| EMD-SL-3V-400-N | 2885278 | 1 |
| EMD-SL-PS-24DC | 2885359 | 1 |
| EMD-SL-PS-24AC | 2866103 | 1 |
| EMD-SL-PS-110AC | 2866116 | 1 |
| EMD-SL-PS-120AC | 2885731 | 1 |
| EMD-SL-PS-230AC | 2866129 | 1 |



Housing width 22.5 mm

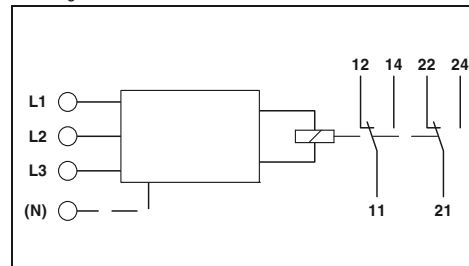

Technical data

Phase sequence, phase failure, asymmetry

342 V AC ... -
3 N ~ 400/230 V
15 kΩ
-
≤ 350 ms (fixed setting)
Fixed, approx. 30%
-
-

2 floating PDT contacts
750 VA (3 A/250 V AC, module aligned, ≤ 5 mm spacing)
1250 VA (5 A/250 V AC, module not aligned, ≥ 5 mm spacing)

2 x 10⁶ cycles at ohmic load, 1000 VA
Approx. 2 x 10⁷ cycles
5 A (fast-blow)

(From the measured voltage)
9 VA
IP40 (housing) / IP20 (connection terminal blocks)
-25°C ... 55°C
22.5 / 90 / 113 mm
0.5 ... 2.5 mm² / 0.25 ... 2.5 mm² / 20 - 14

CE-compliant
UL/C-UL listed UL 508

Ordering data

| Type | Order No. | Pcs. / Pkt. |
|----------------------|-----------|-------------|
| EMD-SL-PH-400 | 2866077 | 1 |

Monitoring

Monitoring relays, timer relays, special function modules

Effective power monitoring, load monitoring (cos φ)

Effective power monitoring

The effective power in single- and 3-phase networks can be monitored with the **EMD-FL-RP-480** effective power monitoring relay.

- Monitoring range up to 7.2 kW
- Separately adjustable startup and release delays
- Temperature monitoring of the motor winding
- Variable supply voltage range
- Detection of switched off loads

Load monitoring (cos φ)

The **EMD-FL-PF-400** monitoring relay is a cos φ monitor for load monitoring in single- or three-phase networks.

Notes:

- 1) EMC: Class A product, see page 571



Effective power monitoring



Load monitoring (cos φ)

Housing width 45 mm

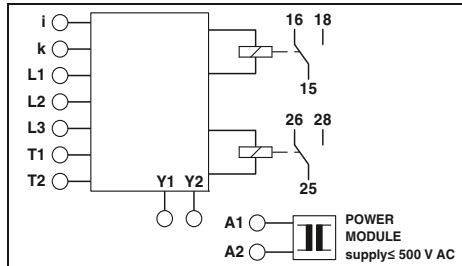

Technical data

Underload, overload, window, winding temperature monitoring

Voltage input
AC sine (10 Hz ... 400 Hz)
Can be switched between 0.75 kW, 1.5 kW, 3 kW and 6 kW

480 V (3 N ~ 480/277 V)
0 V AC ... 480 V AC (1(N) ~, single-phase load)
0 V AC ... 480 V AC (3(N) ~, 3-phase load)
0.15 A ... 6 A (Range: 0.75 kW and 1.5 kW)
0.3 A ... 12 A (Range: 3 kW and 6 kW)
5% ... 110% (of P_N)
10% ... 120% (of P_N)

Min.
Max.

2 floating PDT contacts
750 VA (3 A/250 V AC, module aligned, ≤ 5 mm spacing)
1250 VA (5 A/250 V AC, module not aligned, ≥ 5 mm spacing)

2 x 10⁵ cycles at ohmic load, 1000 VA
Approx. 2 x 10⁷ cycles
5 A (fast-blow)

3.5 VA (3 W)
300 V (According to EN 50178)
IP40 (housing) / IP20 (connection terminal blocks)
-25°C ... 55°C
45 / 90 / 113 mm
0.5 ... 2.5 mm² / 0.25 ... 2.5 mm² / 20 - 14

CE-compliant
UL applied for

Ordering data

| Functions | |
|---|--|
| Input | |
| Description of the input | |
| Measured value | |
| Measuring ranges P _N | |
| Nominal input voltage U _N | |
| Input ranges | |
| Input ranges | |
| Min. setting range | |
| Max. setting range | |
| Switching threshold cos φ | |
| Relay output | |
| Contact type | |
| Switching capacity | |
| Electrical service life | |
| Mechanical service life | |
| Output fuse | |
| General data | |
| Supply voltage | |
| Nominal power consumption | |
| Rated insulation voltage | |
| Degree of protection | |
| Ambient temperature range | |
| Dimensions W / H / D | |
| Screw connection solid / stranded / AWG | |
| Conformance / approvals | |
| Conformance | |
| UL, USA / Canada | |

Description

Electronic monitoring relay

Power module, plug-in, please order at the same time!
Supply voltage 88 ... 121 V AC
Supply voltage 108 ... 132 V AC
Supply voltage 195 ... 264 V AC
Supply voltage 323 ... 456 V AC
Supply voltage 425 ... 550 V AC



Housing width 22.5 mm

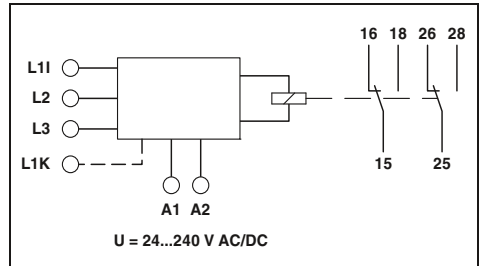

Technical data

Underload, overload, Window

-
AC sine (10 ... 100 Hz)
-

(3 N ~ 415/240 V)
40 V AC ... 415 V AC (1(N) ~, single-phase load)
40 V AC ... 415 V AC (3(N) ~, 3-phase load)
0.5 A ... 10 A (Connection terminal blocks: L1i and L1k)
-
-
0.1 ... 0.99
0.2 ... 1

2 floating PDT contacts
750 VA (3 A/250 V AC, module aligned, ≤ 5 mm spacing)
1250 VA (5 A/250 V AC, module not aligned, ≥ 5 mm spacing)

2 x 10⁵ cycles at ohmic load, 1000 VA
Approx. 2 x 10⁷ cycles
5 A (fast-blow)

4.5 VA (1.5 W)
300 V (According to EN 50178)
IP40 (housing) / IP20 (connection terminal blocks)
-25°C ... 55°C
22.5 / 90 / 113 mm
0.5 ... 2.5 mm² / 0.25 ... 2.5 mm² / 20 - 14

CE-compliant
UL/C-UL listed UL 508

Ordering data

| Type | Order No. | Pcs. / Pkt. |
|-------------------|-----------|-------------|
| EMD-FL-RP-480 | 2900177 | 1 |
| EMD-SL-PS45-110AC | 2885281 | 1 |
| EMD-SL-PS45-120AC | 2885744 | 1 |
| EMD-SL-PS45-230AC | 2885294 | 1 |
| EMD-SL-PS45-400AC | 2885304 | 1 |
| EMD-SL-PS45-500AC | 2885317 | 1 |

| Type | Order No. | Pcs. / Pkt. |
|-----------------------------|-----------|-------------|
| EMD-FL-PF-400 ¹⁾ | 2885809 | 1 |



Temperature monitoring, filling level monitoring

Temperature monitoring (motor winding)

The monitoring relay **EMD-SL-PTC** monitors the motor winding temperatures by means of PTC (PTC thermistor resistance) as per DIN 44081.

- Test function with integrated test/reset button
- Variable supply voltage range
- Short-circuit and open-circuit monitoring

Filling level monitoring

The **EMD-SL-LL-...** monitoring relay monitors the level of electrically conductive liquids with the help of conductive probes (not supplied as standard).

- Adjustable response delay
- Adjustable via potentiometer on front



Temperature monitoring (motor windings)



Filling level monitoring

Housing width 22.5 mm

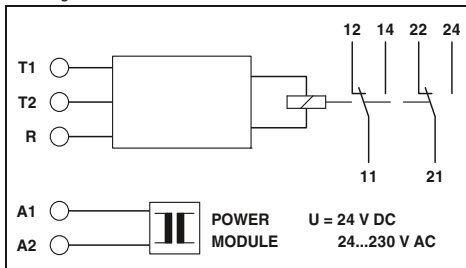

Technical data

Winding temperature monitoring

- < 1.5 kΩ
- ≥ 3.6 kΩ (Relay drops out)
- ≤ 1.8 kΩ (Relay picks up)
- ±10% (of scale end value)
- ≤ 2%
-
-
-
-

-

2 floating PDT contacts
750 VA (3 A/250 V AC, module aligned, ≤ 5 mm spacing)
1250 VA (5 A/250 V AC, module not aligned, ≥ 5 mm spacing)

2 x 10⁵ cycles at ohmic load, 1000 VA
Approx. 2 x 10⁷ cycles
5 A (fast-blow)

2 VA (1.5 W)
IP40 (housing) / IP20 (connection terminal blocks)
-25°C ... 55°C
22.5 / 90 / 113 mm
0.5 ... 2.5 mm² / 0.25 ... 2.5 mm² / 20 - 14

CE-compliant
UL/C-UL listed UL 508

Ordering data

| Type | Order No. | Pcs. / Pkt. |
|-----------------|-----------|-------------|
| EMD-SL-PTC | 2866093 | 1 |
| EMD-SL-PS- 24DC | 2885359 | 1 |
| EMD-SL-PS- 24AC | 2866103 | 1 |
| EMD-SL-PS-110AC | 2866116 | 1 |
| EMD-SL-PS-120AC | 2885731 | 1 |
| EMD-SL-PS-230AC | 2866129 | 1 |

Housing width 22.5 mm

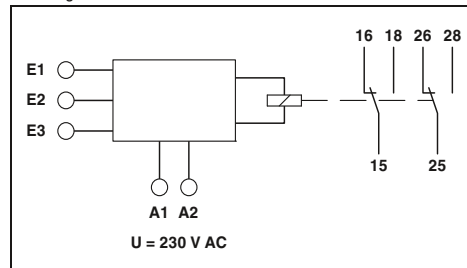

Technical data

Pumping up (minimum monitoring),
pumping down (maximum monitoring)

-
-
-
-
-
- Conductive probe, type: SK1, SK2, SK3
- 16 V AC
- 7 mA
- < 1000 m Set value < 50% (Capacity 100 nF/km)
- < 100 m Set value 100% (Capacity 100 nF/km)

0.25 kΩ ... 100 kΩ (4 mS ... 1 μS)

2 floating PDT contacts
750 VA (3 A/250 V AC, module aligned, ≤ 5 mm spacing)
1250 VA (5 A/250 V AC, module not aligned, ≥ 5 mm spacing)

2 x 10⁵ cycles at ohmic load, 1000 VA
Approx. 2 x 10⁷ cycles
5 A (fast-blow)
EMD-SL-LL-230 EMD-SL-LL-110
230 V AC -15% ... +15% AC 110 V AC -10% ... +15% AC
2 VA (1.5 W)
IP40 (housing) / IP20 (connection terminal blocks)
-25°C ... 55°C
22.5 / 90 / 113 mm
0.5 ... 2.5 mm² / 0.25 ... 2.5 mm² / 20 - 14

CE-compliant
UL/C-UL listed UL 508

Ordering data

| Type | Order No. | Pcs. / Pkt. |
|---------------|-----------|-------------|
| EMD-SL-LL-230 | 2885906 | 1 |
| EMD-SL-LL-110 | 2901137 | 1 |

Functions

Input

- Total cold resistance
- Response value
- Release value
- Basic accuracy
- Repeat accuracy
- Measuring input
- Max. probe voltage
- Max. probe current
- Length of probe cable

Switching threshold

Relay output

Contact type

Switching capacity

Electrical service life

Mechanical service life

Output fuse

General data

Supply voltage

Nominal power consumption

Degree of protection

Ambient temperature range

Dimensions W / H / D

Screw connection solid / stranded / AWG

Conformance / approvals

Conformance

UL, USA / Canada

Description

Electronic monitoring relay

Power module, plug-in, please order at the same time!

- Supply voltage 20 ... 30 V DC
- Supply voltage 20.2 ... 26.4 V AC
- Supply voltage 88 ... 121 V AC
- Supply voltage 108 ... 132 V AC
- Supply voltage 195 ... 264 V AC

Ultra-narrow timer relays

The **ETD-BL-1T...** ultra-narrow timer relays show their strengths in applications that involve set parameters for functionality and time range.

- Purposeful device selection: one function, one time range
- High level of setting accuracy thanks to labeled and illuminated thumbwheel
- 6.2 mm slim design width



N

Timer relay with switch-on delay, voltage controlled

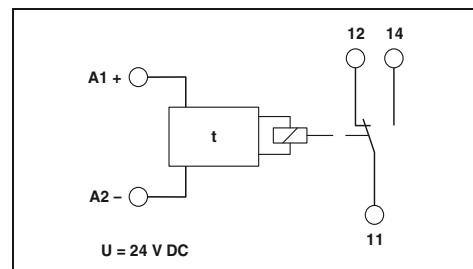

Technical data

| Functions | |
|---|---|
| Control contact | - |
| Connection | - |
| Control pulse length | min. 50 ms |
| Relay output | |
| Contact type | 1 floating PDT |
| Switching capacity | 1500 VA (6 A / 250 V AC) |
| Mechanical service life | Approx. 2×10^7 cycles |
| General data | |
| Supply voltage | 24 V DC (19,2 V DC ... 30 V DC) |
| Nominal current typ. | 15 mA (Relay ON) 7 mA (Relay OFF) |
| Impulse withstand voltage | 6 kV (According to EN 50178) |
| Degree of protection | IP20 |
| Ambient temperature range | -20°C ... 65°C |
| Housing material | Polyamide PA, self-extinguishing |
| Dimensions W / H / D | 6,2 / 80 / 86 mm |
| Screw connection solid / stranded / AWG | 0,14 ... 2,5 mm ² / 0,14 ... 2,5 mm ² / 26 - 14 |
| Spring-cage connection (solid/stranded/AWG) | 0,14 ... 2,5 mm ² / 0,14 ... 2,5 mm ² / 26 - 14 |
| Conformance / approvals | |
| Conformance | CE-compliant |
| ATEX | Ex II 3 G Ex nA nC IIC T4 Gc X |

ON: With switch-on delay



Conveyor belt 1 starts immediately



Conveyor belt 2 starts with a time delay

| Description | |
|---|--|
| Compact timer relay, with screw connection | |
| Time range 0.1...10 s | |
| Time range 3...300 s | |
| Time range 0.3...30 min | |
| Time range 3...300 min | |
| Compact timer relay, with push-in technology | |
| Time range 0.1...10 s | |
| Time range 3...300 s | |
| Time range 0.3...30 min | |
| Time range 3...300 min | |

Ordering data

| Type | Order No. | Pcs. / Pkt. |
|------------------------|-----------|-------------|
| ETD-BL-1T-ON- 10S | 2917379 | 1 |
| ETD-BL-1T-ON-300S | 2917382 | 1 |
| ETD-BL-1T-ON- 30MIN | 2917395 | 1 |
| ETD-BL-1T-ON-300MIN | 2917405 | 1 |
| ETD-BL-1T-ON- 10S-PT | 2901476 | 1 |
| ETD-BL-1T-ON-300S-PT | 2901477 | 1 |
| ETD-BL-1T-ON- 30MIN-PT | 2901478 | 1 |
| ETD-BL-1T-ON-300MIN-PT | 2901479 | 1 |



N



N



N

Timer relay with switch-on delay, with control contact

Timer relay with off delay, with control contact

Timer relay with flashing indic. function, beginning with the pulse

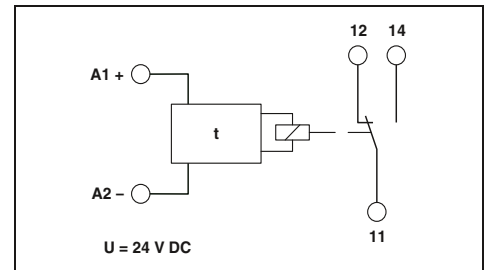
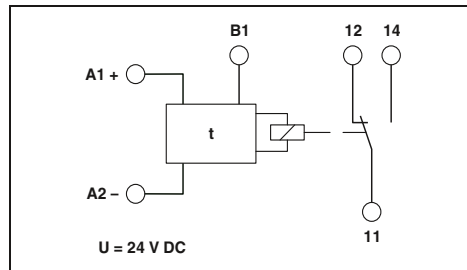
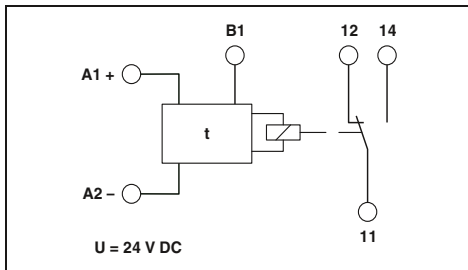

Technical data

Technical data

Technical data

ON-CC: With switch-on delay with control contact

OFF-CC: Off delay with control contact

F: Flashing beginning with pulse

Non-floating, terminals A1-B1
min. 50 ms

Non-floating, terminals A1-B1
min. 50 ms

-
min. 50 ms

1 floating PDT
1500 VA (6 A / 250 V AC)
Approx. 2×10^7 cycles

1 floating PDT
1500 VA (6 A / 250 V AC)
Approx. 2×10^7 cycles

1 floating PDT
1500 VA (6 A / 250 V AC)
Approx. 2×10^7 cycles

24 V DC (19,2 V DC ...30 V DC)
15 mA (Relay ON)
7 mA (Relay OFF)
6 kV (According to EN 50178)
IP20
-20°C ... 65°C
Polyamide PA, self-extinguishing
6.2 / 80 / 86 mm
0.14 ... 2.5 mm² / 0.14 ... 2.5 mm² / 26 - 14
0.14 ... 2.5 mm² / 0.14 ... 2.5 mm² / 26 - 14

24 V DC (19,2 V DC ...30 V DC)
15 mA (Relay ON)
7 mA (Relay OFF)
6 kV (According to EN 50178)
IP20
-20°C ... 65°C
Polyamide PA, self-extinguishing
6.2 / 80 / 86 mm
0.14 ... 2.5 mm² / 0.14 ... 2.5 mm² / 26 - 14
0.14 ... 2.5 mm² / 0.14 ... 2.5 mm² / 26 - 14

24 V DC (19,2 V DC ...30 V DC)
15 mA (Relay ON)
7 mA (Relay OFF)
6 kV (According to EN 50178)
IP20
-20°C ... 65°C
Polyamide PA, self-extinguishing
6.2 / 80 / 86 mm
0.14 ... 2.5 mm² / 0.14 ... 2.5 mm² / 26 - 14
0.14 ... 2.5 mm² / 0.14 ... 2.5 mm² / 26 - 14

CE-compliant
II 3 G Ex nA nC IIC T4 Gc X

CE-compliant
II 3 G Ex nA nC IIC T4 Gc X

CE-compliant
II 3 G Ex nA nC IIC T4 Gc X

Ordering data

Ordering data

Ordering data

| Type | Order No. | Pcs. / Pkt. |
|---------------------------|-----------|-------------|
| ETD-BL-1T-ON-CC- 10S | 2917418 | 1 |
| ETD-BL-1T-ON-CC-300S | 2917421 | 1 |
| ETD-BL-1T-ON-CC- 30MIN | 2917434 | 1 |
| ETD-BL-1T-ON-CC-300MIN | 2917447 | 1 |
| ETD-BL-1T-ON-CC- 10S-PT | 2901480 | 1 |
| ETD-BL-1T-ON-CC-300S-PT | 2901481 | 1 |
| ETD-BL-1T-ON-CC- 30MIN-PT | 2901483 | 1 |
| ETD-BL-1T-ON-CC-300MIN-PT | 2901484 | 1 |

| Type | Order No. | Pcs. / Pkt. |
|----------------------------|-----------|-------------|
| ETD-BL-1T-OFF-CC- 10S | 2917450 | 1 |
| ETD-BL-1T-OFF-CC-300S | 2917463 | 1 |
| ETD-BL-1T-OFF-CC- 30MIN | 2917467 | 1 |
| ETD-BL-1T-OFF-CC-300MIN | 2917489 | 1 |
| ETD-BL-1T-OFF-CC- 10S-PT | 2901485 | 1 |
| ETD-BL-1T-OFF-CC-300S-PT | 2901486 | 1 |
| ETD-BL-1T-OFF-CC- 30MIN-PT | 2901487 | 1 |
| ETD-BL-1T-OFF-CC-300MIN-PT | 2901488 | 1 |

| Type | Order No. | Pcs. / Pkt. |
|-----------------------|-----------|-------------|
| ETD-BL-1T-F- 10S | 2917492 | 1 |
| ETD-BL-1T-F-300S | 2917502 | 1 |
| ETD-BL-1T-F- 30MIN | 2917515 | 1 |
| ETD-BL-1T-F-300MIN | 2917528 | 1 |
| ETD-BL-1T-F- 10S-PT | 2901489 | 1 |
| ETD-BL-1T-F-300S-PT | 2901490 | 1 |
| ETD-BL-1T-F- 30MIN-PT | 2901491 | 1 |
| ETD-BL-1T-F-300MIN-PT | 2901492 | 1 |

Monitoring

Monitoring relays, timer relays, special function modules

Multifunctional timer relays

The full range of conventional applications can be accommodated by the three versions of the **ETD** multifunctional timer relay.

- Suitable for universal use thanks to varied functions and selectable time ranges
- Time ranges from a few milliseconds to several days
- Variable supply voltage range
- 2 floating PDT outputs

Notes:
1) EMC: Class A product, see page 571



**Multifunctional timer relay,
two adjustable times**



Housing width 22.5 mm

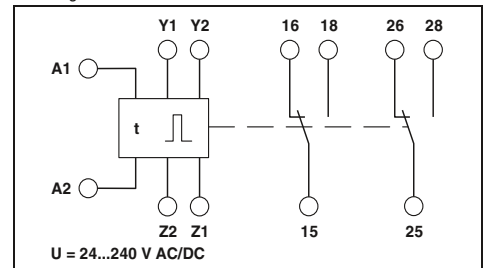

Technical data

Ip: Switched-mode beginning with the pause
Ii: Switched-mode beginning with the pulse
ER: With switch-on and release delay with control contact
EWu: With switch-on delay and single shot leading edge, voltage controlled
EWS: With switch-on delay and single shot leading edge with control contact
WsWa: With single shot leading edge and single shot trailing edge with control contact
Wt: Pulse sequence evaluation (retriggerable release delay)

Functions

Time ranges
Setting range
Control contact
Connection
Load capacity
Cable length
Control pulse length
Relay output
Contact type
Switching capacity

50 ms ... 10 h (10 time end ranges)

Floating, basic isolation between connection and input/output/bridge Y1-Y2
Cannot carry load

max. 10 m
min. 50 ms (Only with Wt function: > 7 ms)

2 floating PDT contacts
750 VA (3 A/250 V AC, module aligned, ≤ 5 mm spacing)
1250 VA (5 A/250 V AC, module not aligned, ≥ 5 mm spacing)

Mechanical service life
General data
Supply voltage
Nominal power consumption
Degree of protection
Ambient temperature range
Housing material
Dimensions W / H / D
Screw connection solid / stranded / AWG
Conformance / approvals
Conformance
UL, USA / Canada

Approx. 2×10^7 cycles

24 V DC ... 240 V DC -20 % ... +25 %
24 V AC ... 240 V AC -15 % ... +10 %
2.5 VA (1 W)
IP40 (housing) / IP20 (connection terminal blocks)
-25°C ... 55°C
Polyamide PA, self-extinguishing
22.5 / 90 / 113 mm
0.5 ... 2.5 mm² / 0.5 ... 2.5 mm² / 20 - 14

CE-compliant
UL/C-UL listed UL 508

Ordering data

Description
Electronic timer relay with adjustable functions and times

| Type | Order No. | Pcs. / Pkt. |
|-----------------------------|-----------|-------------|
| ETD-FL-2T-DT1 ¹⁾ | 2866187 | 1 |

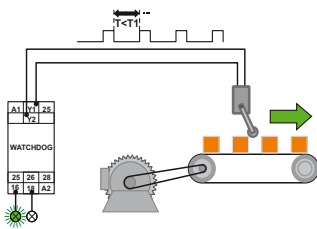

Function: Pulse sequence evaluation

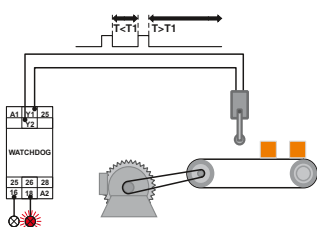

Message for incorrect pulse



**Multifunctional timer relay,
one adjustable time**



**Impulse encoder,
adjustable pulse and pause times**



Housing width 22.5 mm

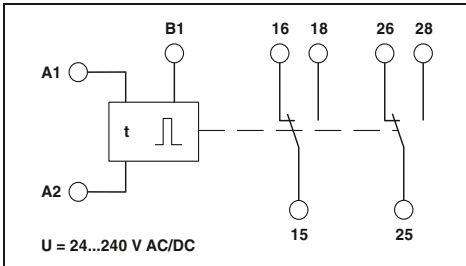

Technical data

- E: With switch-on delay
- R: With release delay and control contact
- Es: With switch-on delay and control contact
- Wu: With single shot leading edge, voltage controlled
- Ws: With single shot leading edge and control contact
- Wa: With single shot trailing edge and control contact
- Bi: Flashing beginning with pulse
- Bp: Flashing beginning with pause

50 ms ... 100 h (7 time end ranges)

Non-floating, terminals A1-B1

Parallel switched minimum load current 1 VA (0.5 W), terminals A2-B1

max. 10 m
min. 70 ms

2 floating PDT contacts
750 VA (3 A/250 V AC, module aligned, ≤ 5 mm spacing)
1250 VA (5 A/250 V AC, module not aligned, ≥ 5 mm spacing)

Approx. 2 x 10⁷ cycles

24 V DC ... 240 V DC -20 % ... +25 %
24 V AC ... 240 V AC -15 % ... +10 %
2.5 VA (1 W)
IP40 (housing) / IP20 (connection terminal blocks)
-25°C ... 55°C
Polyamide PA, self-extinguishing
22.5 / 90 / 113 mm
0.5 ... 2.5 mm² / 0.5 ... 2.5 mm² / 20 - 14

CE-compliant
UL/C-UL listed UL 508

Ordering data

| Type | Order No. | Pcs. / Pkt. |
|-----------------------------|-----------|-------------|
| ETD-SL-1T-DTF ¹⁾ | 2866161 | 1 |



Housing width 22.5 mm

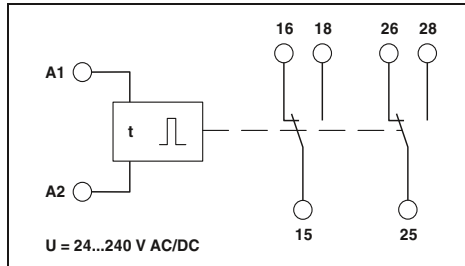

Technical data

- Ip: Switched-mode beginning with the pause
- Ii: Switched-mode beginning with the pulse

50 ms ... 100 h (7 time end ranges)

-

-

-
-

2 floating PDT contacts
750 VA (3 A/250 V AC, module aligned, ≤ 5 mm spacing)
1250 VA (5 A/250 V AC, module not aligned, ≥ 5 mm spacing)

Approx. 2 x 10⁷ cycles

24 V DC ... 240 V DC -20 % ... +25 %
24 V AC ... 240 V AC -15 % ... +10 %
2.5 VA (1 W)
IP40 (housing) / IP20 (connection terminal blocks)
-25°C ... 55°C
Polyamide PA, self-extinguishing
22.5 / 90 / 113 mm
0.5 ... 2.5 mm² / 0.5 ... 2.5 mm² / 20 - 14

CE-compliant
UL/C-UL listed UL 508

Ordering data

| Type | Order No. | Pcs. / Pkt. |
|---------------------------|-----------|-------------|
| ETD-SL-2T-I ¹⁾ | 2866174 | 1 |

Monitoring

Monitoring relays, timer relays, special function modules

Diode modules

Diode circuits perform various tasks in electrical control systems, particularly in electronic ones:

- Electrical decoupling of messages in fault signaling systems
- Spark-suppression diodes for limiting surge voltages of inductive loads, (solenoid valves, DC relays or similar)
- Can be supplied as “diode gates” combined with anode or cathode or as freely assignable diodes



with diode type 1 N 4007



with diode type 1 N 5408

Notes:
Further circuit diagrams can be found in the data sheet at www.phoenixcontact.net/products

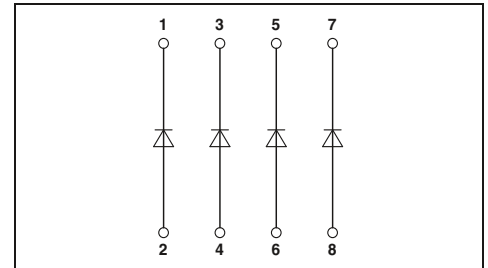

Technical data

| | | |
|------------------------------------|-------------------------|-----------------------|
| Diodes | 4E / 8E / 17E / 7P / 7M | 14P / 14M / 32P / 32M |
| Max. operating voltage U_{max} | 250 V AC | 250 V AC |
| Peak reverse voltage per diode | 1300 V | 1300 V |
| Reverse current per diode | 5 μ A | 5 μ A |
| Conducting state voltage per diode | Approx. 0.8 V | Approx. 0.8 V |
| Conducting state current per diode | | |
| | with single load | 0.7 A |
| | with simultaneous loads | 0.5 A |

Technical data

| | | |
|------------------------------------|-----------------------------------|-----------------|
| Diodes | 4E-... / 4P-... / 4M-... / 8E-... | 8P-... / 8M-... |
| Max. operating voltage U_{max} | 250 V AC | 250 V AC |
| Peak reverse voltage per diode | 1000 V | 1000 V |
| Reverse current per diode | 10 μ A | 10 μ A |
| Conducting state voltage per diode | Approx. 0.8 V | Approx. 0.8 V |
| Conducting state current per diode | | |
| | with single load | 1.5 A |
| | with simultaneous loads | 1 A |

| | |
|---|---|
| General data | |
| Ambient temperature range | -20°C ... 50°C |
| Rated insulation voltage | 300 V (According to EN 50178) |
| Pollution degree / Surge voltage category | III, basic insulation (as per EN 50178) |
| Pollution degree / Surge voltage category | 2 (according to EN 50178) |
| Mounting position | Any |
| Mounting | In rows with zero spacing |
| Dimensions H / D | 75 / 55 mm |
| Screw connection solid / stranded / AWG | 0.2 ... 4 mm ² / 0.2 ... 2.5 mm ² / 24 - 12 |
| Conformance / approvals | |
| Conformance | CE-compliant |

| | |
|---|---|
| General data | |
| Ambient temperature range | -20°C ... 50°C |
| Rated insulation voltage | 300 V (According to EN 50178) |
| Pollution degree / Surge voltage category | III, basic insulation (as per EN 50178) |
| Pollution degree / Surge voltage category | 2 (according to EN 50178) |
| Mounting position | Any |
| Mounting | In rows with zero spacing |
| Dimensions H / D | 75 / 55 mm |
| Screw connection solid / stranded / AWG | 0.2 ... 4 mm ² / 0.2 ... 2.5 mm ² / 24 - 12 |
| Conformance / approvals | |
| Conformance | CE-compliant |

Ordering data

| Description | Housing width | Type | Order No. | Pcs. / Pkt. |
|---|---------------|----------------|-----------|-------------|
| Diode module, can be individually wired | 4 diodes | EMG 22-DIO 4E | 2950048 | 10 |
| | 8 diodes | EMG 45-DIO 8E | 2950103 | 5 |
| | 17 diodes | EMG 90-DIO 17E | 2954895 | 5 |
| Diode module, with P-polarity (common cathode) | 4 diodes | EMG 22-DIO 7P | 2950064 | 10 |
| | 7 diodes | | | |
| | 8 diodes | | | |
| | 14 diodes | | | |
| Diode module, with M polarity (common anode) | 14 diodes | EMG 45-DIO14P | 2950116 | 5 |
| | 32 diodes | EMG 90-DIO 32P | 2954918 | 5 |
| Diode module, with M polarity (common anode) | 4 diodes | EMG 22-DIO 7M | 2950077 | 10 |
| | 7 diodes | | | |
| | 8 diodes | | | |
| | 14 diodes | | | |
| Diode module, with M polarity (common anode) | 14 diodes | EMG 45-DIO14M | 2950129 | 5 |
| | 32 diodes | EMG 90-DIO 32M | 2954934 | 5 |

Ordering data

| Type | Order No. | Pcs. / Pkt. |
|----------------------|-----------|-------------|
| EMG 22-DIO 4E-1N5408 | 2952790 | 10 |
| EMG 45-DIO 8E-1N5408 | 2949389 | 5 |
| EMG 22-DIO 4P-1N5408 | 2952198 | 10 |
| EMG 45-DIO 8P-1N5408 | 2954879 | 5 |
| EMG 22-DIO 4M-1N5408 | 2952211 | 10 |
| EMG 45-DIO 8M-1N5408 | 2954882 | 5 |

Accessories

| | | | |
|------------------|------------|---------|----|
| Equipment marker | EMG-GKS 12 | 2947035 | 50 |
|------------------|------------|---------|----|

Accessories

| | | | |
|------------------|------------|---------|----|
| Equipment marker | EMG-GKS 12 | 2947035 | 50 |
|------------------|------------|---------|----|

Lamp testing modules, display modules

Lamp testing modules

Lamp testing modules for checking lamps that are installed and ready for operation:

- Individual checking of separate lamps (EMG...-E/LP)
- Centrally controlled checking of lamps (EMG...-M/LP)

Display modules

- Light indicator modules facilitate the monitoring of processes on electronic control systems during troubleshooting



Lamp testing module, groups of 2 diodes with common cathode



Light indicator module, with common return line

Notes:

Further circuit diagrams can be found in the data sheet at www.phoenixcontact.net/products

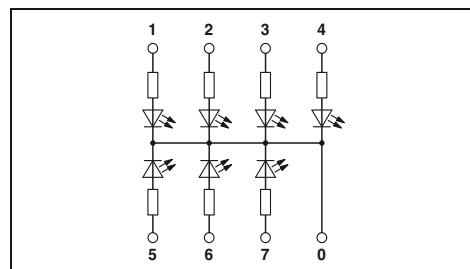
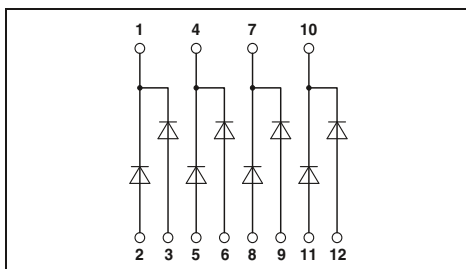

| | | |
|------------------------------------|----------------|----------------|
| Diodes | 8E/16E | 14M/32M |
| Max. operating voltage U_{max} | 250 V AC | 250 V AC |
| Peak reverse voltage per diode | 1300 V | 1300 V |
| Reverse current per diode | $\leq 5 \mu A$ | $\leq 5 \mu A$ |
| Conducting state voltage per diode | Approx. 0.8 V | Approx. 0.8 V |
| Conducting state current per diode | | |

| Technical data | |
|-------------------------|-------|
| | |
| with single load | 0.7 A |
| with simultaneous loads | 0.4 A |

| Technical data | |
|----------------|----------------|
| LA 7S | LED 7S/LED 14S |
| | |
| Approx. 1 mA | Approx. 3 mA |

| | |
|---|---|
| Input | |
| Current required per light indicator | |
| General data | |
| Ambient temperature range | -20°C ... 50°C |
| Rated insulation voltage | 300 V (According to EN 50178) |
| Pollution degree / Surge voltage category | III, basic insulation (as per EN 50178) |
| Pollution degree / Surge voltage category | 2 (according to EN 50178) |
| Mounting position | Any |
| Mounting | In rows with zero spacing |
| Dimensions H / D | 75 / 55 mm |
| Screw connection solid / stranded / AWG | 0.2 ... 4 mm ² / 0.2 ... 2.5 mm ² / 24 - 12 |
| Conformance / approvals | |
| Conformance | CE-compliant |

Ordering data

| Type | Order No. | Pcs. / Pkt. |
|-------------------|-----------|-------------|
| EMG 45-DIO 8E/LP | 2954798 | 5 |
| EMG 90-DIO 16E/LP | 2954808 | 5 |
| EMG 45-DIO14M/LP | 2950132 | 5 |
| EMG 90-DIO 32M/LP | 2954785 | 5 |

Ordering data

| Type | Order No. | Pcs. / Pkt. |
|-------------------|-----------|-------------|
| EMG 22-LA 7S/230 | 2949677 | 10 |
| EMG 22-LED 7S/24 | 2952305 | 10 |
| EMG 45-LED 14S/24 | 2952334 | 5 |

| Description | Housing width |
|---|---------------|
| Lamp testing module, for individual wiring | |
| 4-pair | 45 mm |
| 8-pair | 90 mm |
| Lamp testing module, with common control | |
| 7-pair | 45 mm |
| 16-pair | 90 mm |
| Light indicator module, 110 ... 230 V AC input voltage | |
| 7 glow lamps | 22.5 mm |
| Light indicator module, 24 V DC input voltage | |
| 7 LEDs | 22.5 mm |
| 14 LEDs | 45 mm |

Accessories

| | | |
|------------|---------|----|
| EMG-GKS 12 | 2947035 | 50 |
|------------|---------|----|

Accessories

| | | |
|------------|---------|----|
| EMG-GKS 12 | 2947035 | 50 |
|------------|---------|----|

| | |
|------------------|--|
| Equipment marker | |
|------------------|--|

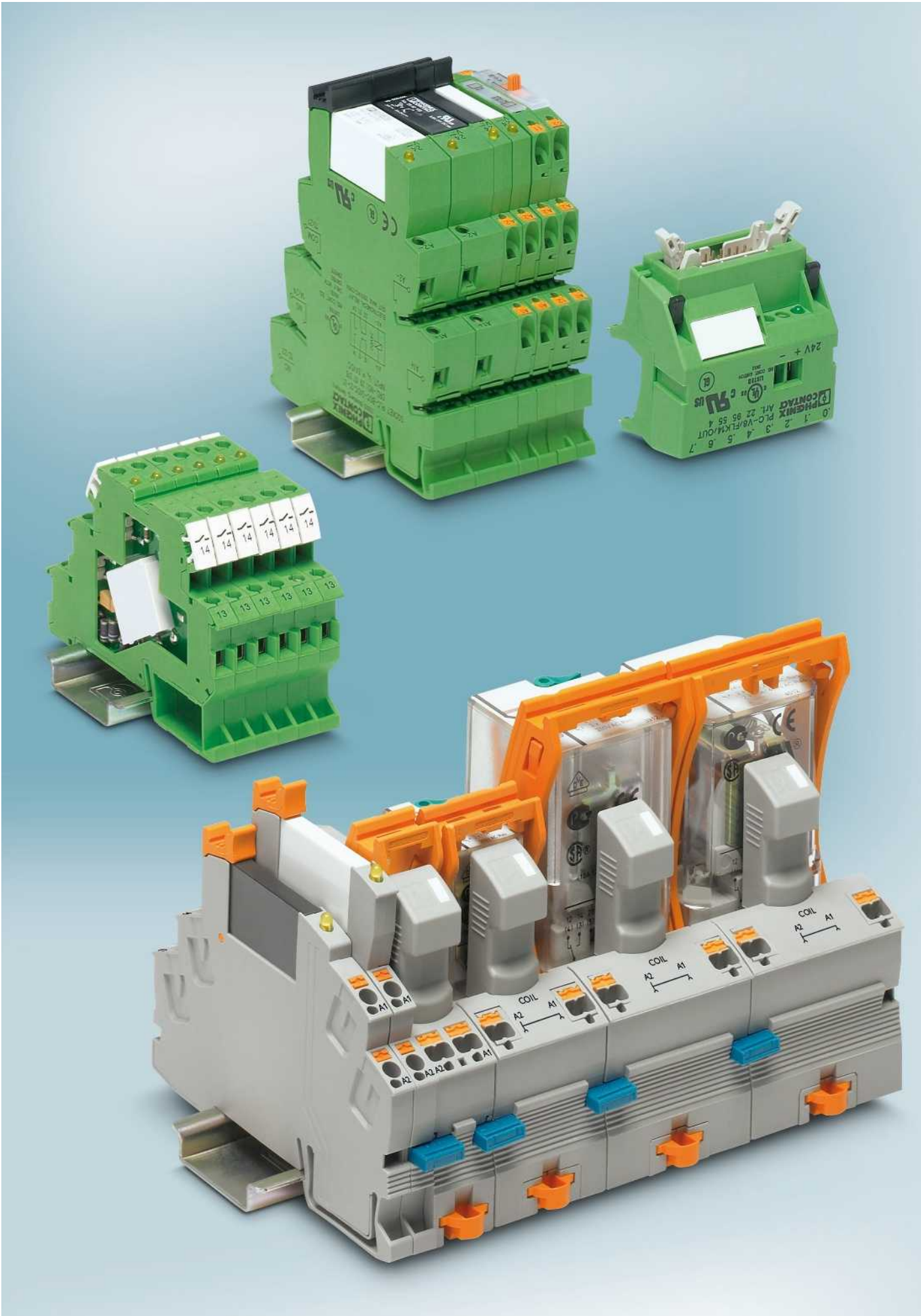

Relay modules

The importance of the reliability of industrial automation equipment is growing with the increase in use of electronic modules.

Modern relay or solid-state relay interfaces perform a wide range of tasks. Whether in production engineering, for the electrical equipment of machines or in control engineering for energy distribution, building automation and materials processing – the main aim is to guarantee the exchange of signals between the process peripherals and the superior, central control systems. This exchange must provide reliable operation, be floating and electrically unambiguous.

Safe electrical interface modules that meet the requirements of modern system concepts must include the following features:

- Coupling of different signal levels
- Safe electrical isolation between input and output
- High interference insensitivity.

In practice, a relay interface comes into use with a flexible interface configuration with a large switching capacity range and the possibility of combining different types of contact. Further important features of relay interfaces are:

- Electrical isolation between open contacts
- Switching of independent switching current types
- High short-term overload resistance in the event of a short circuit or voltage peaks
- Practically impervious to electromagnetic fields
- Easy handling.

Solid-state relay modules are used when an interface between the process peripherals and electronics is subject to the following requirements:

- Low control power
- High switching frequencies
- Wear-free switching with no contact bounce
- Resistance to vibration and impacts
- Long service life.

Product range overview

| | |
|--|------------|
| Product overview | 266 |
| Basics of relay technology | 268 |
| Basics of solid-state relay technology | 272 |
| RIFLINE complete | 274 |
| PLC series | 320 |
| PR series | 370 |
| DEK series | 396 |
| Special relay and solid-state relay modules | 402 |

Relay modules

Product overview

RIFLINE complete



RIF-0 for miniature and solid-state relays
Page 276



RIF-1 for miniature and solid-state relays
Page 282



RIF-2 for industrial relays
Page 290



RIF-3 for octal relays
Page 294

PLC series



With relay/solid-state relay
As sensor/actuator version
Page 322
Page 326



For high inrush/continuous currents
Resistant to interference currents/voltages
Page 332
Page 334



With switch
For railway applications
Page 350
Page 359



For NAMUR initiators
Types of electronics
Page 364
Page 365

DEK series



With miniature relay
Page 397



Actuator series with miniature relays
Page 399



Sensor series with miniature relays
Page 399



With solid-state relay
Page 400

Safety devices



Safety devices
See Catalog 8

Monitoring relays



Monitoring relays
Page 250

Timer relays



Timer relays
Page 258



RIF-4 for high-power relays
Page 298



Accessories
Page 304

PR series



PR1 for miniature or solid-state relays
Page 372



PR2 for industrial relays
Page 378



PR3 for octal relays
Page 382



Accessories
Page 373

Special relay and solid-state relay modules



Relay terminal blocks with switch
Page 403



Interference-free relays and solid-state relays
Page 404



Relays for switching lamp loads
Page 407



Solid-state power relays with 400 V AC/400 V AC/3 A output
Page 408

Basics of relay technology

General

Electromechanical relays are used as interface modules between the process I/O devices, on the one hand, and the open-loop/closed-loop control and signaling equipment, on the other, for level and power adjustment purposes.

Essentially, electromechanical relays can be divided into two main groups: monostable and bistable relays.

With monostable DC or AC relays, the contacts automatically return to the release state as soon as they are de-energized.

In the case of bistable relays, the contacts remain in their present switch position when the excitation current is switched off.

Coil side

Input circuits and voltage types

There are various kinds of input circuit depending on the type of relay used and the nature of the control voltage.

If pure AC relays are used (AC input), the input circuit is generally nothing more than a visual switching status indicator.

Unless otherwise specified, the frequency of the control voltage is 50/60 Hz.



Basic construction of a relay with AC input

In the case of a pure DC input, the most important addition to the circuit is a freewheeling diode. This limits the voltages induced on the coil on circuit interruption to a value of approximately 0.7 V, which does not pose a danger to any connected control electronics.

As the freewheeling diode can only perform its required function if the polarity of the voltage connection is correct, a reverse polarity protection diode is also integrated into the input circuit.



Basic construction of a relay with DC input

To allow DC or AC voltage operation, a bridge rectifier is connected in the input circuit. The diodes are simultaneously responsible for performing rectification, freewheeling, and polarity reversal protection functions. The interrupting voltage of the coil is limited to approximately 1.4 V.

To protect the input circuit against overvoltages, a varistor is also connected (depending on the type) upstream of the bridge rectifier.



Basic construction of a relay with AC/DC input

Bistable remanence relays with a double winding are only ever operated with DC voltage.

With these types of relay, there are three coil connections on the coil side. In addition to the common connection, there are separate connections for “setting” and “resetting”; these are controlled by short pulses only. As a result, the relays hardly heat up at all. Simultaneous control of both control inputs is not permitted.

A distinction is made between negative switching (M) and positive switching (P) types, depending on the polarity of the freewheeling and reverse polarity protection diodes.



Block diagram of a bistable relay, negative switching type



Block diagram of bistable relay, positive switching type

Operating voltage range

The ambient temperature prevailing at the location of use has a major impact on certain relay operating parameters.

As the ambient temperature increases, the coil winding heats up, causing the operate and release voltages to rise. At the same time, the maximum permissible coil voltage decreases, which means that the usable

working range becomes restricted as a result.

The diagram below illustrates how the operating voltage behaves as a function of the ambient temperature.



Basic curve of a relay operating voltage

- I: Maximum permissible voltage with 100% operating time (OT) and assuming compliance with the coil temperature limit
- II: Minimum operate voltage

Interference voltages and interference currents on the coil side

When inductive or capacitive interference voltages are coupled into the long supply lines of a relay, this can prevent the relay from operating safely.

If the coupled-in voltage exceeds the release voltage required by the IEC 61810-1 “relay standard”, in extreme cases the relay may fail to release. In the case of DC relays, this release voltage is $\geq 0.05 \times U_N$ and for purely AC relays, it is $\geq 0.15 \times U_N$.

The same disturbances can occur when a relay with a low input power is controlled by an electronics module with an AC voltage output featuring an RC circuit. The typical leakage current from RC elements of this kind (generally in the region of several mA) provides sufficient control power to prevent the downstream relay from releasing or even enough power to excite it.

The disturbance level of any interference voltages that are present can be reduced by connecting an RC element parallel to the relay coil. This measure also subjects the interference voltage to a capacitive load, causing it to collapse.



External RC interference suppression filter to prevent interference voltage coupling

The following values are recommended for the purpose of dimensioning the RC element:

- R = 100 ... 220 Ω
- C = 220 ... 470 nF

The SO46 series have been developed to provide even higher levels of immunity to interference. These products already contain an integrated RCZ filter. See, for example, PLC...SO46.

Contact side, contact materials

Given the wide variety of potential applications in the different industrial sectors, the relays used must be matched to the various tasks that need to be performed by selecting the right kind of contact material.

The voltage, current, and power values play an important role when determining the suitability of contact materials. Other criteria include:

- Contact resistance
- Erosion resistance
- Material migration
- Welding tendency
- Chemical influences

In this way, the various contact materials (generally noble metal alloys) can be matched to the relevant areas of application.

The adjacent table provides details of some of the key materials.

Contact protection circuit

Every electrical load constitutes a mixed load with ohmic, capacitive, and inductive components.

When these loads are switched, the switching contact is in turn subjected to a load, to either a lesser or greater extent. This load can be reduced by including a suitable contact protection circuit.

In view of the fact that loads with a large inductive component are predominantly used in practice (e.g., contactors, solenoid valves, motors, etc.), these application scenarios are worth considering in more detail.

On interruption, voltage peaks with values of up to several thousand volts occur due to the energy stored in the coil.

| Contact material | Typ. properties | Typ. applications | Guide values for the area of application* |
|--|--|--|---|
| Gold Au | Largely insensitive to industrial atmospheres; low and constant contact resistances in the range of small switching capacities with nickel (AuNi) or silver (AuAg) alloys | Dry measuring and switching circuits, control inputs | μA ... 0.2 A μV ... 30 V |
| Silver Ag | High electrical conductivity; sensitive to sulfur, therefore often gold-flashed (approximately 0.2 μm) as protection; nickel (AgNi) or copper (AgCu) alloys increase the mechanical resistance and erosion resistance and reduce the welding tendency. | Universal; suitable for medium loads; nickel alloys (AgNi 0.15) for DC circuits with medium to large loads. | ≥ 12 V ≥ 10 mA |
| Silver, hard gold-plated Ag+Au | Properties similar to gold Au. When switching loads > 30 V/0.2 A, the hard gold plating (5 - 10 μm) is destroyed and the values and properties of the Ag contact are applicable. However, a reduction in the service life is then to be expected. | Suitable for control inputs and other small loads. | ≥ 100 mV ≥ 1 mA |
| Tungsten W | Highest melting point; very high erosion resistance; greater contact resistances; very low welding tendency; susceptible to corrosion; often used as lead contact. | Loads with very high inrush currents, e.g., glow lamps, fluorescent lamps. | ≥ 60 V ≥ 1 A |
| Silver nickel AgNi | High erosion resistance; low welding tendency; higher contact resistances than with pure silver. | Universal; suitable for medium to high loads; DC circuits and inductive loads. | ≥ 12 V ≥ 10 mA |
| Silver nickel AgNi+Au | Properties similar to gold Au. When switching loads > 30 V/0.2 A, the hard gold plating (5 - 10 μm) is destroyed and the values and properties of the AgNi contact are applicable. However, a reduction in the service life is then to be expected. | Suitable for control inputs and other small loads. | ≥ 100 mV ≥ 1 mA |
| Silver tin oxide AgSnO | Low welding tendency; very high erosion resistance for high switching capacities; low material migration | Application depends heavily on the relay type; switching circuits with high make and break loads, e.g., glow lamps and fluorescent lamps, AC and DC circuits. Due to different alloys and production procedures, partly also suitable for smaller loads. | ≥ 12 V ≥ 100 mA (≥ 10 mA) |
| Silver tin oxide, hard gold-plated AgSnO+Au | Properties similar to gold Au. When switching loads > 30 V/0.2 A, the hard gold plating (5 - 10 μm) is destroyed and the values and properties of the AgSnO contact are applicable. However, a reduction in the service life is then to be expected. | Suitable for control inputs and other small loads. | ≥ 100 mV ≥ 1 mA |

* Values depend on the relay used and on further operating conditions.

These high voltages cause an arc on the switching contact which can destroy the contact due to material vaporization and material migration. The electrical service life is reduced considerably as a result. In extreme cases, the relay may fail in the very first cycle with DC voltage and a static arc.

A protective circuit must be used to suppress the formation of an arc. With optimum dimensioning, almost the same number of cycles can be achieved as with an ohmic load.

Basics of relay technology

In principle, there are a number of possible ways of achieving an effective circuit:

1. Contact wiring
2. Load wiring
3. Combination of both wiring methods

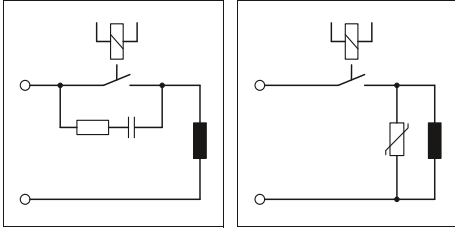

Contact wiring

Inductive load wiring

In principle, protective measures should intervene directly at the source of the interference.

Wiring a load should therefore be given priority over wiring the contact.

The following points are advantageous for the load circuit (image on right):

1. The circuit is only loaded with the induction voltage during interruption. By contrast, the sum of the operating voltage and the induction voltage is applied to the contact circuit.
2. When the contact is open, the load is electrically isolated from the operating voltage.
3. It is not possible for the load to be activated or to "stick" due to undesired operating currents, e.g., from RC elements.
4. Cut-off peaks of the load cannot be coupled into parallel control lines.

Nowadays, solenoid valves are usually connected using valve plugs that are also supplied with LEDs and components that limit the induction voltage. Valve plugs with an RC element, varistor or Zener diode often do not quench the arc and only serve to comply with legislation governing EMC. Only valve plugs with an integrated 1N4007 freewheeling diode quench the arc quickly and safely, thereby increasing the service life of the relay by a factor of 5 to 10. Valve plugs with LED, integrated 1N4007, and free cable end can be supplied on request as part of the SAC range.

| Load wiring | Additional dropout delay | Defined induction voltage limitation | Effective bipolar attenuation | Advantages/disadvantages |
|--|--------------------------|--------------------------------------|-------------------------------|--|
| Diode | Large | Yes (U_D) | No | Advantages: <ul style="list-style-type: none"> • Good effect in terms of extending the service life of the contacts • Easy implementation • Inexpensive • Reliable • Dimensioning not critical • Low induction voltage Disadvantages: <ul style="list-style-type: none"> • Attenuation only via load resistor • Long dropout delay |
| Diode/Zener diode series connection | Medium to small | Yes (U_{ZD}) | No | Advantages: <ul style="list-style-type: none"> • Dimensioning not critical Disadvantages: <ul style="list-style-type: none"> • Attenuation only above U_{ZD} • Minimal effect in terms of extending the service life of the contacts |
| Suppressor diode | Medium to small | Yes (U_{ZD}) | Yes | Advantages: <ul style="list-style-type: none"> • Inexpensive • Dimensioning not critical • Limitation of positive peaks • Suitable for AC voltages Disadvantages: <ul style="list-style-type: none"> • Attenuation only above U_{ZD} • Minimal effect in terms of extending the service life of the contacts |
| Varistor | Medium to small | Yes (U_{VDR}) | Yes | Advantages: <ul style="list-style-type: none"> • High energy absorption • Dimensioning not critical • Suitable for AC voltages Disadvantages: <ul style="list-style-type: none"> • Attenuation only above U_{VDR} • Minimal effect in terms of extending the service life of the contacts |
| R/C combination | Medium to small | No | Yes | Advantages: <ul style="list-style-type: none"> • HF attenuation due to energy storage • Suitable for AC voltages • Level-independent damping Disadvantages: <ul style="list-style-type: none"> • Precise dimensioning required • High inrush current surge • Minimal effect in terms of extending the service life of the contacts |

Switching small loads

Small loads must be processed mainly in applications where signals must be forwarded to control inputs (e.g., of a PLC).

With these loads, no switching sparks (arcs) occur on the contacts in the small load range.

In addition to the constant cleaning effect due to contact friction, this switching spark assumes the function of penetrating non-conductive contamination layers that are formed on the contact surfaces of power contacts.



Application example: measurement point changeover

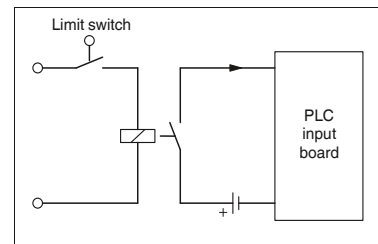

Application example: PLC input signal

These contamination layers are usually oxidation or sulfidation products of the contact materials silver (Ag) or silver alloys such as silver nickel (AgNi) or silver tin oxide (AgSnO). As a result, the contact resistance may rise so considerably within a short time that reliable switching is no longer possible in the case of small loads.

Due to these properties, the high-performance contact materials mentioned are not suitable for small load applications.

Gold (Au) has become accepted as the contact material of choice for these areas of application mainly on account of its low and constant contact resistances even with small loads and its insensitivity to sulfurous atmospheres.

For the smallest of loads and even greater contact reliability, double contact relays with gold contacts are used.

The slotted contact spring in this design provides two parallel contact points with even lower contact resistances and considerably higher contact reliability.

Switching large loads

A few important points also need to be considered with regard to switching operations in the large load range that involve power contacts made of either silver (Ag) or silver tin oxide (AgSnO).

A basic distinction must be made between switching DC and AC loads.

Switching large AC loads

When switching large AC loads, the relay can be operated up to the corresponding maximum values for switching voltage, current, and power. The arc that occurs during interruption depends on the current, voltage, and phase angle. This cut-off arc usually disappears automatically the next time the load current passes through zero.

In applications with an inductive load, an effective protective circuit must be provided, otherwise the service life of the system will be reduced considerably.

Switching large DC loads

Conventional switching relays can only switch off relatively small direct currents (which contrasts with their ability to switch off the maximum permissible AC current), since there is no zero crossing to extinguish the arc automatically. This maximum DC value is also dependent to a large extent on the switching voltage and is determined, among other things, by constructional features such as contact spacing and contact opening speed.

The corresponding current and voltage values are documented by relay manufacturers in arc or load limit curves.

A non-attenuated inductive DC load fur-



Example of a load limit curve (dependent on the type)

ther reduces the values given for switchable currents. The energy stored in the inductance can cause an arc to occur, which forwards the current through the open contacts.

With an effective contact protection circuit, preferably type 1N4007 freewheeling diodes, the service life can be increased by a factor of 5 to 10 compared with unprotected or poorly protected inductive loads (see also "Contact protection circuits" section).

If higher DC loads than those documented are to be switched or if the electrical service life is to be increased, several contacts of a relay can be connected in series. See, for example, REL-IR... industrial relays.

Alternatively, solid-state relays with DC voltage output can also be used.

Switching lamps and capacitive loads

Regardless of the type of voltage, all kinds of lamps and loads with a capacitive component impose extreme requirements on the switching contacts. The moment it is switched on, in other words precisely in the dynamic chattering phase of the relay, extremely powerful current peaks occur.

These are often in the region of several tens of amps, and not infrequently are known to exceed 100 A, which results in welding of the contact. This can be remedied by using specially optimized "lamp load relays" that can cope with these inrush peaks. See, for example, PLC...IC type.

Switching capacity in accordance with utilization categories AC15 and DC13 (IEC 60947)

In practice, both the maximum interrupting rating for AC loads and the DC interruption values taken from the load limit curves provide only a rough guide for the choice of relay. In reality, this is insufficient, since real loads in the vast majority of industrial applications have inductive or capacitive components and the wiring of the loads can be totally different. As already described, this sometimes leads to considerable variations in terms of service life.

The IEC 60947 contactor standard seeks to avoid these disadvantages by dividing the loads into various utilization categories (DC13, AC15, etc.). This standard is also partly applied to relays. However, users must be aware of the fact that these values are only applicable in practice to a limited extent as well, since all DC13 and AC15 test loads are highly inductive and are also operated without any protective circuit at all (see "Contact protection circuit" section). Moreover, the switching capacity test in accordance with IEC 60947 only requires 6060 cycles to be performed by way of a minimum requirement.

A much more reliable way to determine the switching capacity and the anticipated service life is to refer to the specific application data. Using a comprehensive data bank, the service life can be accurately estimated for most applications and, if necessary, suggestions for improvement can be made. In the case of critical applications, the user is advised to gather service life information based on empirical data.

Control side

Solid-state relays for various voltage and power levels are available from Phoenix Contact for use as interface modules designed to match process I/O devices to control, signaling, and regulating devices. The solid-state relay element which is actually located in the module is limited to one defined voltage range by virtue of its design. The current consumption on the input side fluctuates depending on the circuit architecture and voltage level.

To accommodate all industrial voltages between 5 V and 230 V, an input circuit is provided. The inputs for DC voltage and AC voltage must always be differentiated.

DC input

Adjustments are made in accordance with the various voltage levels by adding electronics which have been specially adapted to the desired voltage range. In the case of most modules, a polarity protection diode provides reliable protection against destruction in the event of a control voltage being connected incorrectly. Specially coordinated filters reliably suppress possible high-frequency noise emissions.

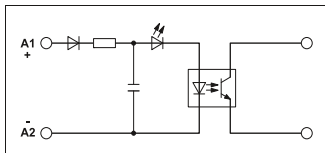

Figure 1: block diagram for DC input

AC input

The solid-state relay element requires a stable control voltage to ensure reliable operation. In the case of the AC input, this is achieved by connecting a rectifier and filter capacitor upstream. Rectifying is followed, in principle, by the same circuit architecture as the DC input.

The switching frequency always lies below half the mains frequency. Due to the filter capacitor, a higher switching frequency cannot be achieved. This would result in continuous through-switching.

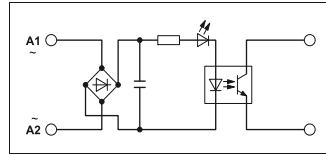

Figure 2: block diagram for AC input

Load side

Depending on the application and the type of load, the solid-state relay output must meet various requirements. The following are crucial:

- Power amplification
- Matching the switching voltage and the switching current (AC/DC)
- Short-circuit protection

For these different applications, the solid-state relay element must also be processed using additional electronics on the output side.

DC output

In order to achieve the necessary output power, the solid-state relay element is supplemented by one or more semiconductor components.

The on-site user should nevertheless simply regard the connection terminal blocks of the output as conventional switch connections. Observing the specified polarity is the only essential requirement.

For practical reasons, the following criteria should be taken into account when selecting a suitable solid-state relay:

1. Operating voltage range (e.g., 12 ... 60 V DC)

This determines the minimum or maximum voltage to be switched. The lower value must be observed in order to ensure reliable operation. In order to protect the output transistor, the upper value must not be exceeded.
2. Maximum continuous current (e.g., 1 A)

This value indicates the maximum continuous current. If this value is exceeded continuously, the output semiconductor will be destroyed. The dependence of the output current on the ambient temperature of the solid-state relay should also be taken into consideration. A de-rating curve is therefore generally specified for solid-state power relays. This

shows the maximum load current as a function of the ambient temperature.

3. Output circuit

The 2-conductor output is similar to a mechanical contact. Only the polarity of the connections is specified and must be observed.

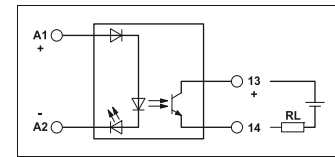

Figure 3: 2-conductor output

The 3-conductor output is non-isolated and requires both potentials from the voltage source on the output side to be connected if it is to operate reliably.

When switched off, a permanent reference to ground (negative potential) is established. In addition, this output circuit offers the advantage of an almost constant internal resistance.

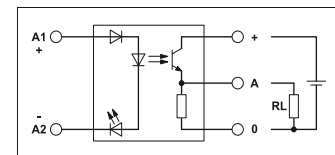

Figure 4: 3-conductor output

AC output

In order to control the switching and control devices for AC voltage, a semiconductor for AC voltage (TRIAC or thyristor) is connected downstream of the solid-state relay element.

As with the DC output, it is particularly important to consider the maximum operating voltage range and the maximum continuous load current as a function of the ambient temperature.

Basics of solid-state relay technology

In addition, the maximum peak reverse voltage of the TRIAC (e.g., 600 V) is crucial with AC outputs. This must not be exceeded even in the case of voltage fluctuations or interference voltage peaks in order to prevent destruction. That is why the AC outputs of all solid-state relays from Phoenix Contact have an internal RC protective circuit to protect against interference voltage peaks.

Application notes

Input solid-state relays acting in the direction from the I/O devices to the controller (signaling, controlling, monitoring)

Plug-in version:

- PLC-O...

Modular version:

- DEK-OE...
- EMG 10-OE...
- SIM-EI...
- OPT...



Figure 5: basic circuit diagram of AC output

Protective circuits

The moment inductive loads (contactors, solenoid valves, motors) are switched off, surge voltages occur and these can reach very high amplitudes. Electronic components and switching elements are particularly susceptible to these. A protective circuit should therefore always be provided to prevent destruction.

A parallel connection to the load effectively reduces the switching surge voltage to a harmless level. Depending on the solid-state relay output and type of load:

- A freewheeling diode/suppressor diode (DC only)
 - A varistor (AC and DC)
 - Or an RC element (AC only)
- can provide the necessary protection.

Output (power) solid-state relays acting in the direction from the controller to the I/O devices (switching, amplifying, controlling)

Plug-in version:

- PLC-O...

Modular version:

- DEK-OV...
- EMG 10-OV
- EMG 12-OV
- EMG 17-OV
- OV...
- OPT...



Figure 6: protective circuit with DC voltage output

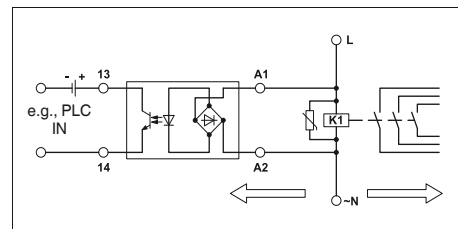

Figure 7: protective circuit with AC voltage output

Example: load contactor monitoring (DC contactor)



Example: load contactor monitoring (AC contactor)



Example: position indication with limit stop contact or initiator



Example: switching the contactor, solenoid valve or motor (DC load)



Example: switching the contactor, solenoid valve or motor (AC load)



Remarks:

- 1) Ground (negative) potential from the input and output of the solid-state relay must not be connected.
- 2) DC loads must be provided with an effective protective circuit (e.g., diode).
- 3) AC loads must be protected with a varistor or an RC element.



RIFLINE complete is an inexpensive relay system with various accessories. It consists of DIN rail bases, electromechanical or solid-state relays, plug-in input/interference suppression modules, marking material, and bridging material. The range of accessories is rounded off with a timer module. This can be used to transform a basic relay into a timer relay with three different functions.

The RIFLINE complete relay range consists of seven different base versions from RIF-0 to RIF-4 – these range from one N/O contact up to four PDT contacts. The field of application of this product group ranges from coupling relay applications with switching currents of one milliamp to replacement for miniature contactors with currents up to 16 A.

The relay bases feature push-in connection technology, which enables quick and tool-free conductor contacting. The RIF-1 to RIF-4 bases offer double the contact options on both the input and output side.

On the input side of all bases, the negative potential (A2) can be bridged – regardless of the base size. On the output side, the grouped contact (11) can be bridged within the RIF-0 base version. This connection can also be bridged within the RIF-1 base size.

To offer diverse marking options, the engagement lever can be fitted with a zack marker strip. In addition, marker carriers

can be mounted on the bases so that additional marking surfaces are available.

RIFLINE complete can be extended using many elements from the CLIPLINE complete accessories range. This includes marking complete material, bridges, and test adapters.

To make ordering and management easy, RIFLINE complete modules are provided in the most popular voltages as complete modules with relay and input/interference suppression module. For individual assembly, tailored to the requirements of the application, additional voltage levels are offered in the modular system.

**RIF-0**

The narrow 6.2 mm RIF-0 base series is designed for miniature relays with one contact. Switching currents up to 6 A are implemented here. Two base versions are available: 1 N/O contact and 1 PDT contact. RIF-0 is therefore a good choice for all coupling applications.

**RIF-1**

The narrow 16 mm RIF-1 base series is designed for miniature relays with 2 contacts. Currents up to 13 A can be switched when using the FBS 2-8 plug-in bridge. This is the ideal relay for applications that require coupling, power switching, and signal duplication.

**RIF-2**

The 31 mm wide RIF-2 base series is designed for industrial relays with up to 4 contacts. Currents up to 12 A are no problem for these bases. This relay is ideal for applications that require power and signal multiplication.

**RIF-3**

The 40 mm wide RIF-3 base series is designed for octal relays with up to 3 contacts. Switching currents up to 10 A can be implemented here. Two base versions are available: 2 PDT contacts and 3 PDT contacts. RIF-3 bases are ideal for all applications that require power and signal multiplication.

**RIF-4**

The 43 mm wide RIF-4 base series is designed for power relays with up to 3 contacts. Currents up to 16 A can be switched. RIF-4 bases are a good choice for applications that require power and signal multiplication, e.g., in miniature contactor applications.

**Accessories**

A wide range of accessories are available for the RIFLINE complete relay system that round off the range. These include bridges, professional marking material, special function modules, test plugs, and end brackets.

Relay modules

RIFLINE complete

Modular RIF-0 relay base

Relay base that can be fitted with miniature power relays or solid-state relays with a nominal voltage of 12 to 24 V DC.

The advantages:

- Integrated freewheeling diode for input circuit and interference suppression circuit
- LED for status display
- Safe isolation according to DIN EN 50178 between coil and contact
- Professional marking material
- Holders for test plugs
- Professional bridging of adjacent modules saves wiring time (A2 and 11/13)
- FBS 2-6 plug-in bridges for the input and output side

| Notes: |
|--|
| Type of insulating housing: Polyamide PA non-reinforced, color: gray. |
| For further marking systems and mounting material, see Catalog 5. |

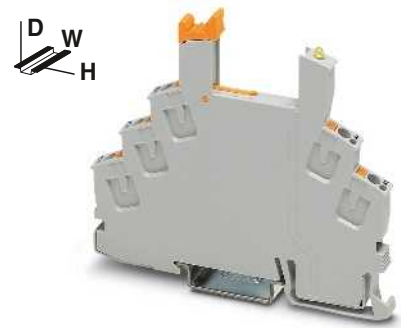

1 PDT relay base for miniature power relay

Nominal voltage U_N
Nominal current at U_N

| Technical data |
|---|
| 230 V AC (Contact side) max. 8 A (Depends on application/assembly) |

| General data |
|--|
| Ambient temperature (operation) |
| Connection data solid / stranded / AWG |
| Dimensions |
| Width |
| Depth |
| Height |

| |
|---|
| -40°C ... 85°C (Depends on application/assembly) |
| 0.14 ... 1.5 mm ² / 0.14 ... 1.5 mm ² / 26 - 16 |
| 6.2 mm |
| 78 mm |
| 93 mm |

| Description |
|--|
| RIF-0 relay base , PDT version, safe isolation I/O With push-in connection |
| RIF-0 relay base , N/O contact version, safe isolation I/O With push-in connection |

| Ordering data | | |
|---------------|-----------|-------------|
| Type | Order No. | Pcs. / Pkt. |
| RIF-0-BPT/21 | 2900958 | 10 |

| Plug-in bridge |
|----------------|
| 2-pos. red |
| 2-pos. blue |
| 2-pos. gray |
| 5-pos. red |
| 10-pos. red |
| 20-pos. red |
| 50-pos. red |

Accessories

| | | |
|------------|---------|----|
| FBS 2-6 | 3030336 | 50 |
| FBS 2-6 BU | 3036932 | 50 |
| FBS 2-6 GY | 3032237 | 50 |
| FBS 5-6 | 3030349 | 50 |
| FBS 10-6 | 3030271 | 10 |
| FBS 20-6 | 3030365 | 10 |
| FBS 50-6 | 3032224 | 10 |

End clamp, to snap on NS 35, 9.5 mm wide, can be labeled with ZB 6, ZB 8/27, KLM...

| | | |
|------------|---------|----|
| CLIPFIX 35 | 3022218 | 50 |
|------------|---------|----|

| Test plug, consisting of: |
|--|
| Metal part for 2.3 mm Ø socket hole and |
| Insulating sleeve , for MPS metal part |
| red |
| white |
| blue |
| yellow |
| green |
| gray |
| black |

| | | |
|-----------|---------|----|
| MPS-MT | 0201744 | 10 |
| MPS-IH RD | 0201676 | 10 |
| MPS-IH WH | 0201663 | 10 |
| MPS-IH BU | 0201689 | 10 |
| MPS-IH YE | 0201692 | 10 |
| MPS-IH GN | 0201702 | 10 |
| MPS-IH GY | 0201728 | 10 |
| MPS-IH BK | 0201731 | 10 |

Zack marker strip, 10-section, unprinted: pack contains enough to label 100 terminal blocks

| | | |
|-----------------|---------|----|
| ZB 6:UNBEDRUCKT | 1051003 | 10 |
|-----------------|---------|----|

10-section

N



1 N/O contact relay base for
miniature power relay

Technical data

230 V AC
max. 8 A (Depends on application/assembly)

-40°C ... 85°C (Depends on application/assembly)

0.14 ... 1.5 mm² / 0.14 ... 1.5 mm² / 26 - 16

6.2 mm
66 mm
93 mm

Ordering data

| Type | Order No. | Pcs. / Pkt. |
|-------------|-----------|-------------|
| RIF-0-BPT/1 | 2901873 | 10 |

Accessories

| | | |
|-----------------|---------|----|
| FBS 2-6 | 3030336 | 50 |
| FBS 2-6 BU | 3036932 | 50 |
| FBS 2-6 GY | 3032237 | 50 |
| FBS 5-6 | 3030349 | 50 |
| FBS 10-6 | 3030271 | 10 |
| FBS 20-6 | 3030365 | 10 |
| FBS 50-6 | 3032224 | 10 |
| CLIPFIX 35 | 3022218 | 50 |
| MPS-MT | 0201744 | 10 |
| MPS-IH RD | 0201676 | 10 |
| MPS-IH WH | 0201663 | 10 |
| MPS-IH BU | 0201689 | 10 |
| MPS-IH YE | 0201692 | 10 |
| MPS-IH GN | 0201702 | 10 |
| MPS-IH GY | 0201728 | 10 |
| MPS-IH BK | 0201731 | 10 |
| ZB 6:UNBEDRUCKT | 1051003 | 10 |

Plug-in miniature power relays

Plug-in miniature power relays suitable for RIF-0 and PLC-INTERFACE relay bases.

The advantages:

- Power contacts up to 6 A
- Multi-layer gold contact or power contact
- High degree of protection RT III (comparable with IP67)
- Safe isolation according to DIN EN 50178 between coil and contact
- Can be soldered in on PCB



1 PDT

Notes:
If the specified maximum values for multi-layer contact relays are exceeded, the gold plating is destroyed. The maximum values of the power contact relay are then valid. This can result in a shorter service life than with a pure power contact.
For dimensional drawings and perforations for assembly, see page 344



Technical data

| Input data | ① | ② |
|--|---------------------------------|-------------------------|
| Permissible range (with reference to U_N) | refer to the diagram | |
| Typ. input current at U_N [mA] | 14 | 7 |
| Typ. response time at U_N [ms] | 5 | 5 |
| Typ. release time at U_N [ms] | 2.5 | 2.5 |
| Output data | | |
| Contact type | Single contact, 1-PDT | Single contact, 1-PDT |
| Contact material | AgSnO | AgSnO, hard gold-plated |
| Max. switching voltage | 250 V AC/DC | 30 V AC / 36 V DC |
| Min. switching voltage | 5 V (at 100 mA) | 100 mV (at 10 mA) |
| Limiting continuous current | 6 A | 50 mA |
| Max. inrush current | (on request) | 50 mA |
| Min. switching current | 10 mA (at 12 V) | 1 mA (at 24 V) |
| General data | | |
| Test voltage (winding / contact) | 4 kV AC (50 Hz, 1 min.) | |
| Ambient temperature (operation) | -40°C ... 85°C | |
| Nominal operating mode | 100% operating factor | |
| Mechanical service life | 2 x 10 ⁷ cycles | |
| Standards/regulations | IEC 60664, EN 50178, IEC 62103 | |
| Mounting position/mounting | Any / In rows with zero spacing | |
| Dimensions | 5 mm / 28 mm / 15 mm | |

Ordering data

| Description | Input voltage U_N | Type | Order No. | Pcs. / Pkt. |
|---------------------------------------|---------------------|-------------------|-----------|-------------|
| Plug-in miniature power relays | | | | |
| with power contact | ① 12 V DC | REL-MR- 12DC/21 | 2961150 | 10 |
| with power contact | ② 24 V DC | REL-MR- 24DC/21 | 2961105 | 10 |
| Plug-in miniature power relays | | | | |
| with gold contact | ① 12 V DC | REL-MR- 12DC/21AU | 2961163 | 10 |
| with gold contact | ② 24 V DC | REL-MR- 24DC/21AU | 2961121 | 10 |

REL-MR-.../21... (1 PDT)



Interrupting rating



Relay modules

RIFLINE complete

Plug-in solid-state relays

Plug-in solid-state relays suitable for RIF-0 and PLC-INTERFACE relay bases.

The advantages:

- Switching capacity of up to 24 V DC/3 A
- RT III wash tight (comparable to IP67)
- Vibration- and shock-resistant
- Wear-free and long-lasting
- Zero voltage switch at AC output
- Can be soldered in on PCB

Notes:
For dimensional drawings and perforations for assembly, see page 345



Max. DC voltage output of 3 A

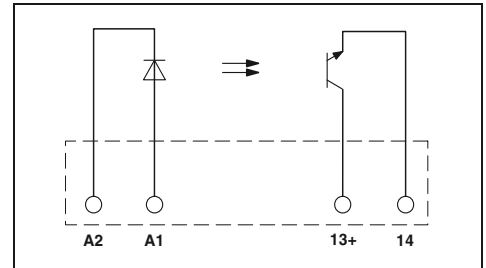

Technical data

| | |
|--|--|
| Input data | ① |
| Permissible range (with reference to U_N) | 0,8 - 1,2 |
| Switching level | 1 signal ("H") [V DC] \geq 16 0 signal ("L") [V DC] \leq 10 |
| Typ. input current at U_N | [mA] 7 |
| Typ. switch-on time at U_N | [μ s] 20 |
| Typ. switch-off time at U_N | [μ s] 300 |
| Transmission frequency f_{limit} | [Hz] 300 |
| Output data | |
| Max. switching voltage | 33 V DC |
| Min. switching voltage | 3 V DC |
| Limiting continuous current | 3 A (see derating curve) |
| Min. load current | - |
| Max. inrush current | 15 A (10 ms) |
| Leakage current in off state | - |
| Phase angle ($\cos \phi$) | - |
| Output circuit | 2-conductor, floating |
| Max. load value | - |
| Output protection | Protection against polarity reversal, surge protection |
| Voltage drop at max. limiting continuous current | \leq 150 mV |
| General data | |
| Rated surge voltage | Basic insulation |
| Test voltage input/output | 2,5 kV (50 Hz, 1 min.) |
| Ambient temperature (operation) | -25°C ... 60°C |
| Nominal operating mode | 100% operating factor |
| Standards/regulations | IEC 60664, EN 50178, IEC 62103 |
| Pollution degree/surge voltage category | 2 / III |
| Mounting position/mounting | Any / In rows with zero spacing |
| Dimensions | W / H / D 5 mm / 28 mm / 15 mm |

Ordering data

| Description | Input voltage U_N | Type | Order No. | Pcs. / Pkt. |
|-----------------------------------|---------------------|--------------------------|----------------|-------------|
| Plug-in solid-state relays | | | | |
| Solid-state power relays | ① 24 V DC | OPT-24DC/ 24DC/ 2 | 2966595 | 10 |
| Plug-in solid-state relays | | | | |
| Solid-state input relays | ① 24 V DC | | | |



Max. DC voltage output of 100 mA



Max. AC voltage output of 750 mA

Derating curve for OPT...DC/24DC/2 and PLC-OS.../24DC/2 solid-state relays



Derating curve for OPT...DC/230AC/1 and PLC-OS.../230AC/1 solid-state relays

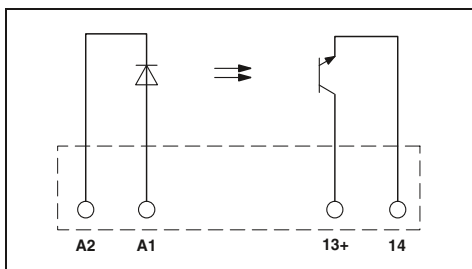

Technical data

| | | |
|---|---------------------------------|--|
| ① | 0.8 - 1.2 | 16 |
| | 10 | 7 |
| | 20 | 300 |
| | 300 | 300 |
| | 48 V DC | 3 V DC |
| | 100 mA | - |
| | - | - |
| | - | - |
| | - | - |
| | 2-conductor, floating | - |
| | - | Protection against polarity reversal, surge protection |
| | ≤ 1 V | |
| | Basic insulation | 2.5 kV (50 Hz, 1 min.) |
| | -25°C ... 60°C | 100% operating factor |
| | IEC 60664, EN 50178, IEC 62103 | 2 / III |
| | Any / In rows with zero spacing | 5 mm / 28 mm / 15 mm |

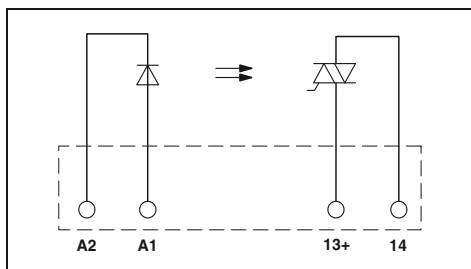

Technical data

| | | |
|---|---------------------------------|---|
| ① | 0.8 - 1.2 | 10 |
| | 5 | 3 |
| | 6000 | 500 |
| | 500 | 10 |
| | 253 V AC | 24 V AC |
| | 0.75 A (see derating curve) | 10 mA |
| | 30 A (10 ms) | < 1 mA |
| | 0.5 | 2-conductor floating, zero voltage switch |
| | 4.5 A²s | RCV circuit |
| | < 1 V | |
| | Basic insulation | 2.5 kV (50 Hz, 1 min.) |
| | -25°C ... 60°C | 100% operating factor |
| | IEC 60664, EN 50178, IEC 62103 | 2 / III |
| | Any / In rows with zero spacing | 5 mm / 28 mm / 15 mm |

Ordering data

| Type | Order No. | Pcs. / Pkt. |
|--------------------|-----------|-------------|
| OPT-24DC/ 48DC/100 | 2966618 | 10 |

Ordering data

| Type | Order No. | Pcs. / Pkt. |
|-------------------|-----------|-------------|
| OPT-24DC/230AC/ 1 | 2967950 | 10 |

Relay modules

RIFLINE complete

Modular RIF-1 relay base

Relay base that can be fitted with 1 or 2 PDT relays or solid-state relays.

Range of accessories includes:

- Plug-in input and interference suppression module
- Plug-in timer module
- Relay retaining bracket with ejector function and holder for marking material
- Comprehensive range of marking material
- Test plug
- FBS 2-6 plug-in bridges for the input side (A2)
- FBS 2-8 plug-in bridges for the output side (11/21)

| |
|--|
| Notes: |
| Type of insulating housing: Polyamide PA non-reinforced, color: gray. |
| For further marking systems and mounting material, see Catalog 5. |

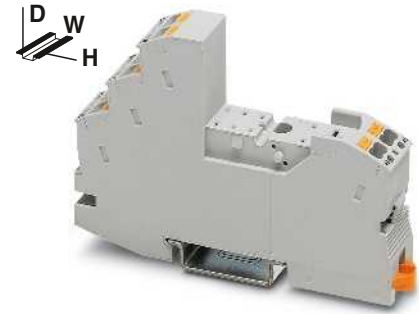

2 PDT relay base for miniature power relay

Nominal voltage U_N
Nominal current at U_N

| |
|--|
| General data |
| Ambient temperature (operation) |
| Connection data solid / stranded / AWG |
| Dimensions |
| Width |
| Depth with retaining bracket |
| Height |

| |
|---|
| Technical data |
| 230 V AC |
| max. 13 A (Depends on application/assembly) |

| |
|---|
| -40°C ... 85°C (Depends on application/assembly) |
| 0.14 ... 1.5 mm ² / 0.14 ... 1.5 mm ² / 26 - 16 |
| 16 mm |
| 75 mm |
| 93 mm |

| |
|--|
| Description |
| RIF-1 relay base , plug-in option for input/interference suppression module, safe isolation I/O with push-in connection |
| Relay retaining bracket , with ejector function and holder for marking material, suitable for RIF-1 relay base |

| | | |
|----------------------|------------------|--------------------|
| Ordering data | | |
| Type | Order No. | Pcs. / Pkt. |
| RIF-1-BPT/2X21 | 2900931 | 10 |

| |
|-----------------------|
| Plug-in bridge |
| 2-pos. red |
| 2-pos. blue |
| 2-pos. gray |
| 2-pos. red |
| 2-pos. blue |
| 2-pos. gray |

End clamp, to snap on NS 35, 9.5 mm wide, can be labeled with ZB 6, ZB 8/27, KLM...

| |
|--|
| Test plug , consisting of: |
| Metal part for 2.3 mm Ø socket hole and |
| Insulating sleeve , for MPS metal part |
| red |
| white |
| blue |
| yellow |
| green |
| gray |
| black |

| |
|---------------------------------------|
| Zack marker strip, unprinted |
| 10-section |
| 5-section |
| Double marker carrier for ZB 5 |

| | | |
|--------------------|---------|-----|
| Accessories | | |
| FBS 2-6 | 3030336 | 50 |
| FBS 2-6 BU | 3036932 | 50 |
| FBS 2-6 GY | 3032237 | 50 |
| FBS 2-8 | 3030284 | 10 |
| FBS 2-8 BU | 3032567 | 10 |
| FBS 2-8 GY | 3032541 | 10 |
| 7042 | | |
| CLIPFIX 35 | 3022218 | 50 |
| MPS-MT | 0201744 | 10 |
| MPS-IH RD | 0201676 | 10 |
| MPS-IH WH | 0201663 | 10 |
| MPS-IH BU | 0201689 | 10 |
| MPS-IH YE | 0201692 | 10 |
| MPS-IH GN | 0201702 | 10 |
| MPS-IH GY | 0201728 | 10 |
| MPS-IH BK | 0201731 | 10 |
| ZB 5 :UNBEDRUCKT | 1050004 | 10 |
| ZB 15:UNBEDRUCKT | 0811972 | 10 |
| STP 5-2 | 0800967 | 100 |

N



Relay retaining bracket

Technical data

-
-
-
-
-
-

Ordering data

| Type | Order No. | Pcs. / Pkt. |
|----------|-----------|-------------|
| RIF-RH-1 | 2900953 | 10 |

Accessories

| Type | Order No. | Pcs. / Pkt. |
|------|-----------|-------------|
| | | |
| | | |
| | | |

Relay modules

RIFLINE complete

Plug-in miniature power relays

Plug-in miniature power relays with 1 or 2 PDT contacts, suitable for RIF-1, PR1, and PLC-INTERFACE relay bases.

The advantages:

- Power contacts up to 16 A
- Multi-layer gold contact or power contact
- High degree of protection up to RT III (comparable with IP67) depending on type



1 PDT relay



2 PDT relay

Notes:
If the specified maximum values for multi-layer contact relays are exceeded, the gold plating is destroyed. The maximum values of the power contact relay are then valid. This can result in a shorter service life than with a pure power contact.



| Technical data | | | | | | | | |
|--|--------------------------------|----|-----|------------------------|-----|------|------|------|
| ① | ② | ③ | ④ | ⑤ | ⑥ | ⑦ | ⑧ | |
| refer to the diagram | | | | | | | | |
| Permissible range (with reference to U _N) | 33 | 17 | 8.7 | 8.2 | 4.1 | 32 | 7 | 3 |
| Typ. input current at U _N | [mA] | 7 | 7 | 7 | 7 | | | |
| Typ. response time at U _N | [ms] | | | | | 3-12 | 3-12 | 3-12 |
| Typ. response time at U _N (depending on phase relation) | [ms] | | | | | | | |
| Typ. release time at U _N | [ms] | 3 | 3 | 3 | 3 | | | |
| Typ. release time at U _N (depending on phase relation) | [ms] | | | | | 2-9 | 2-9 | 2-9 |
| Output data | | | | | | | | |
| Contact type | Single contact, 1-PDT | | | Single contact, 1-PDT | | | | |
| Contact material | AgNi | | | AgNi, hard gold-plated | | | | |
| Max. switching voltage | 250 V AC/DC | | | 30 V AC / 36 V DC | | | | |
| Min. switching voltage | 12 V (at 10 mA) | | | 100 mV (at 10 mA) | | | | |
| Limiting continuous current | 16 A | | | 50 mA | | | | |
| Max. inrush current, AC | 25 A (20 ms) | | | 50 mA | | | | |
| Max. inrush current, DC | 50 A (20 ms) | | | 50 mA | | | | |
| Min. switching current | 10 mA (at 12 V) | | | 1 mA (at 24 V) | | | | |
| General data | | | | | | | | |
| Test voltage (winding / contact) | 5 kV AC (50 Hz, 1 min.) | | | | | | | |
| Test voltage (contact/contact) | - | | | | | | | |
| Ambient temperature (operation), AC | -40°C ... 85°C | | | | | | | |
| Ambient temperature (operation), DC | -40°C ... 85°C | | | | | | | |
| Mechanical service life, AC | 1 x 10 ⁷ cycles | | | | | | | |
| Mechanical service life, DC | 3 x 10 ⁷ cycles | | | | | | | |
| Standards/regulations | IEC 60664, EN 50178, IEC 62103 | | | | | | | |

| Technical data | | | | | | | | |
|--|--------------------------------|----|-----|------------------------|-----|------|------|------|
| ① | ② | ③ | ④ | ⑤ | ⑥ | ⑦ | ⑧ | |
| refer to the diagram | | | | | | | | |
| Permissible range (with reference to U _N) | 33 | 17 | 8.7 | 8.2 | 4.1 | 32 | 7 | 3 |
| Typ. input current at U _N | [mA] | 7 | 7 | 7 | 7 | | | |
| Typ. response time at U _N | [ms] | | | | | 3-12 | 3-12 | 3-12 |
| Typ. response time at U _N (depending on phase relation) | [ms] | | | | | | | |
| Typ. release time at U _N | [ms] | 3 | 3 | 3 | 3 | | | |
| Typ. release time at U _N (depending on phase relation) | [ms] | | | | | 2-9 | 2-9 | 2-9 |
| Output data | | | | | | | | |
| Contact type | Single contact, 2-PDT | | | Single contact, 2-PDT | | | | |
| Contact material | AgNi | | | AgNi, hard gold-plated | | | | |
| Max. switching voltage | 250 V AC/DC | | | 30 V AC / 36 V DC | | | | |
| Min. switching voltage | 5 V (at 10 mA) | | | 100 mV (at 10 mA) | | | | |
| Limiting continuous current | 8 A | | | 50 mA | | | | |
| Max. inrush current, AC | 12 A (20 ms) | | | 50 mA | | | | |
| Max. inrush current, DC | 25 A (20 ms) | | | 50 mA | | | | |
| Min. switching current | 10 mA (At 5 V) | | | 1 mA (at 24 V) | | | | |
| General data | | | | | | | | |
| Test voltage (winding / contact) | 5 kV AC (50 Hz, 1 min.) | | | | | | | |
| Test voltage (contact/contact) | 2.5 kV AC (50 Hz, 1 min.) | | | | | | | |
| Ambient temperature (operation), AC | -40°C ... 85°C | | | | | | | |
| Ambient temperature (operation), DC | -40°C ... 85°C | | | | | | | |
| Mechanical service life, AC | 1 x 10 ⁷ cycles | | | | | | | |
| Mechanical service life, DC | 3 x 10 ⁷ cycles | | | | | | | |
| Standards/regulations | IEC 60664, EN 50178, IEC 62103 | | | | | | | |

| Ordering data | | | |
|----------------------|-----------|-------------|--|
| Type | Order No. | Pcs. / Pkt. | |
| REL-MR- 12DC/21HC | 2961309 | 10 | |
| REL-MR- 24DC/21HC | 2961312 | 10 | |
| REL-MR- 48DC/21HC | 2834821 | 10 | |
| REL-MR- 60DC/21HC | 2961325 | 10 | |
| REL-MR-110DC/21HC | 2961338 | 10 | |
| REL-MR- 24AC/21HC | 2961406 | 10 | |
| REL-MR-120AC/21HC | 2961419 | 10 | |
| REL-MR-230AC/21HC | 2961422 | 10 | |
| REL-MR- 12DC/21HC AU | 2961532 | 10 | |
| REL-MR- 24DC/21HC AU | 2961545 | 10 | |
| REL-MR-110DC/21HC AU | 2961561 | 10 | |
| REL-MR- 24AC/21HC AU | 2961503 | 10 | |
| REL-MR-120AC/21HC AU | 2961516 | 10 | |
| REL-MR-230AC/21HC AU | 2961529 | 10 | |

| Ordering data | | | |
|----------------------|-----------|-------------|--|
| Type | Order No. | Pcs. / Pkt. | |
| REL-MR- 12DC/21-21 | 2961257 | 10 | |
| REL-MR- 24DC/21-21 | 2961192 | 10 | |
| REL-MR- 48DC/21-21 | 2834834 | 10 | |
| REL-MR- 60DC/21-21 | 2961273 | 10 | |
| REL-MR-110DC/21-21 | 2961202 | 10 | |
| REL-MR- 24AC/21-21 | 2961435 | 10 | |
| REL-MR-120AC/21-21 | 2961448 | 10 | |
| REL-MR-230AC/21-21 | 2961451 | 10 | |
| REL-MR- 12DC/21-21AU | 2961299 | 10 | |
| REL-MR- 24DC/21-21AU | 2961215 | 10 | |
| REL-MR- 48DC/21-21AU | 2834847 | 10 | |
| REL-MR- 60DC/21-21AU | 2961286 | 10 | |
| REL-MR-110DC/21-21AU | 2961228 | 10 | |
| REL-MR- 24AC/21-21AU | 2961464 | 10 | |
| REL-MR-120AC/21-21AU | 2961477 | 10 | |
| REL-MR-230AC/21-21AU | 2961480 | 10 | |

| Description | Input voltage U _N |
|---------------------------------------|------------------------------|
| Plug-in miniature power relays | |
| with power contact | ① 12 V DC |
| with power contact | ② 24 V DC |
| with power contact | ③ 48 V DC |
| with power contact | ④ 60 V DC |
| with power contact | ⑤ 110 V DC |
| with power contact | ⑥ 24 V AC |
| with power contact | ⑦ 120 V AC |
| with power contact | ⑧ 230 V AC |
| Plug-in miniature power relays | |
| with gold contact | ① 12 V DC |
| with gold contact | ② 24 V DC |
| with gold contact | ③ 48 V DC |
| with gold contact | ④ 60 V DC |
| with gold contact | ⑤ 110 V DC |
| with gold contact | ⑥ 24 V AC |
| with gold contact | ⑦ 120 V AC |
| with gold contact | ⑧ 230 V AC |

REL-MR...21HC... (1 PDT)

Operating voltage range



- 1 DC coils
- 2 AC coils

Interrupting rating

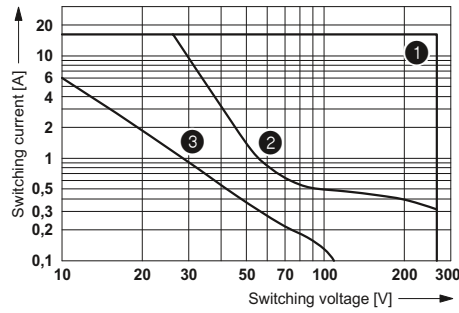

- 1 AC, ohmic load
- 2 DC, ohmic load
- 3 DC, L/R = 40 ms

Electrical service life



- 1 250 V AC, ohmic load (DC coils)
- 2 250 V AC, ohmic load (AC coils)

Service life reduction factor with various cos phi



REL-MR...21-21... (2 PDTs)

Operating voltage range



- 1 DC coils
- 2 AC coils

Interrupting rating

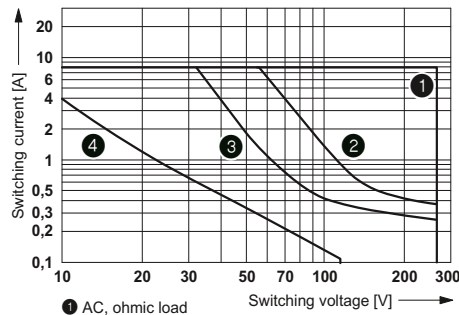

- 1 AC, ohmic load
- 2 DC, ohmic load, contacts in series
- 3 DC, ohmic load
- 4 DC, L/R = 40 ms

Electrical service life



- 1 250 V AC, ohmic load (DC coils)
- 2 250 V AC, ohmic load (AC coils)

Service life reduction factor with various cos phi



Plug-in miniature power relays

Plug-in miniature power relays with 1 or 2 PDT contacts, suitable for RIF-1 and PR1 relay bases.

The advantages:

- Switching current of up to 16 A
- With lockable manual operation
- Mechanical switch position indicator
- Integrated status LED
- Multi-layer gold contact or power contact
- DC types with integrated freewheeling diode
- Can be soldered in on PCB



1 PDT relay



2 PDT relay

Notes:

If the specified maximum values for multi-layer contact relays are exceeded, the gold plating is destroyed. The maximum values of the power contact relay are then valid. This can result in a shorter service life than with a pure power contact.

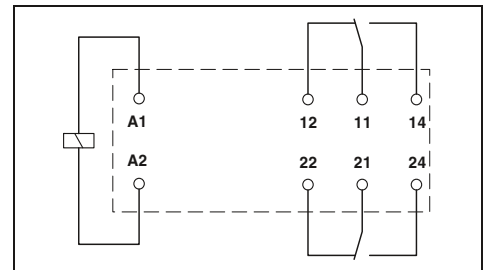
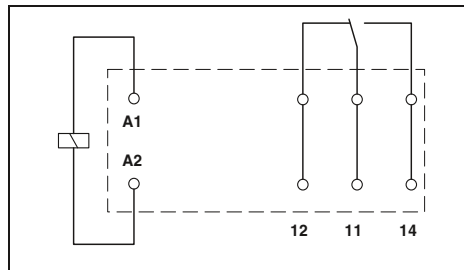

Technical data

| ① | ② | ③ | ④ |
|----------------------|----|--------|--------|
| refer to the diagram | | | |
| 18 | 32 | 7 | 3.5 |
| 9 | | 3 - 12 | 3 - 12 |
| 6 | | 2 - 8 | 2 - 8 |

Technical data

| ① | ② | ③ | ④ |
|----------------------|----|--------|--------|
| refer to the diagram | | | |
| 18 | 32 | 7 | 3.5 |
| 9 | | 3 - 12 | 3 - 12 |
| 6 | | 2 - 8 | 2 - 8 |

| Input data | |
|--|------|
| Permissible range (with reference to U_N) | |
| Typ. input current at U_N | [mA] |
| Typ. response time at U_N | [ms] |
| Typ. response time at U_N (depending on phase relation) | [ms] |
| Typ. release time at U_N | [ms] |
| Typ. release time at U_N (depending on phase relation) | [ms] |
| Output data | |
| Contact type | |
| Contact material | |
| Max. switching voltage | |
| Min. switching voltage | |
| Limiting continuous current | |
| Max. inrush current, AC | |
| Max. inrush current, DC | |
| Min. switching current | |
| General data | |
| Test voltage (winding / contact) | |
| Test voltage (contact/contact) | |
| Ambient temperature (operation), AC | |
| Ambient temperature (operation), DC | |
| Mechanical service life, AC | |
| Mechanical service life, DC | |
| Standards/regulations | |

| ① | ② | ③ | ④ |
|---|----|------------------------|--------|
| refer to the diagram | | | |
| 18 | 32 | 7 | 3.5 |
| 9 | | 3 - 12 | 3 - 12 |
| 6 | | 2 - 8 | 2 - 8 |
| Single contact, 1-PDT | | Single contact, 1-PDT | |
| AgNi | | AgNi, hard gold-plated | |
| 250 V AC/DC | | 30 V AC / 36 V DC | |
| 12 V (at 10 mA) | | 12 V (At 1 mA) | |
| 16 A | | 50 mA | |
| 32 A (20 ms) | | 50 mA | |
| 32 A (20 ms) | | 50 mA | |
| 10 mA (at 12 V) | | 1 mA (at 12 V) | |
| 5 kV AC (50 Hz, 1 min.) | | | |
| - | | | |
| -40°C ... 70°C | | | |
| -40°C ... 70°C | | | |
| 5 x 10 ⁶ cycles | | | |
| 5 x 10 ⁶ cycles | | | |
| DIN EN 61810-1, VDE 0435-201, EN 50178, IEC 62103 | | | |

| ① | ② | ③ | ④ |
|---|----|------------------------|--------|
| refer to the diagram | | | |
| 18 | 32 | 7 | 3.5 |
| 9 | | 3 - 12 | 3 - 12 |
| 6 | | 2 - 8 | 2 - 8 |
| Single contact, 2-PDT | | Single contact, 2-PDT | |
| AgNi | | AgNi, hard gold-plated | |
| 250 V AC/DC | | 30 V AC / 36 V DC | |
| 12 V (at 10 mA) | | 12 V (At 1 mA) | |
| 8 A | | 50 mA | |
| 16 A (20 ms) | | 50 mA | |
| 16 A (20 ms) | | 50 mA | |
| 10 mA (at 12 V) | | 1 mA (at 12 V) | |
| 5 kV AC (50 Hz, 1 min.) | | | |
| 2.5 kV AC (50 Hz, 1 min.) | | | |
| -40°C ... 70°C | | | |
| -40°C ... 70°C | | | |
| 5 x 10 ⁶ cycles | | | |
| 5 x 10 ⁶ cycles | | | |
| DIN EN 61810-1, VDE 0435-201, EN 50178, IEC 62103 | | | |

Ordering data

| Description | Input voltage U_N |
|---|---------------------|
| Plug-in miniature power relays, with power contacts | |
| - Status LED, freewheeling diode A1+, A2- | ① 24 V DC |
| - Status LED | ② 24 V AC |
| - Status LED | ③ 120 V AC |
| - Status LED | ④ 230 V AC |
| Plug-in miniature power relays with manual test function, with hard gold-plated multi-layer contacts, mechanical switch position indicator | |
| - Status LED, freewheeling diode A1+, A2- | ① 24 V DC |
| - Status LED | ④ 230 V AC |

| Type | Order No. | Pcs. / Pkt. |
|-------------------------|-----------|-------------|
| REL-MR- 24DC/21HC/MS | 2987888 | 10 |
| REL-MR- 24AC/21HC/MS | 2987891 | 10 |
| REL-MR-120AC/21HC/MS | 2987901 | 10 |
| REL-MR-230AC/21HC/MS | 2987914 | 10 |
| REL-MR- 24DC/21HC AU/MS | 2987927 | 10 |
| REL-MR-230AC/21HC AU/MS | 2987930 | 10 |

Ordering data

| Type | Order No. | Pcs. / Pkt. |
|-------------------------|-----------|-------------|
| REL-MR- 24DC/21-21/MS | 2987943 | 10 |
| REL-MR- 24AC/21-21/MS | 2987956 | 10 |
| REL-MR-120AC/21-21/MS | 2987969 | 10 |
| REL-MR-230AC/21-21/MS | 2987972 | 10 |
| REL-MR- 24DC/21-21AU/MS | 2987985 | 10 |
| REL-MR-230AC/21-21AU/MS | 2987998 | 10 |

REL-MR...21HC...MS (1 PDT)

Operating voltage range

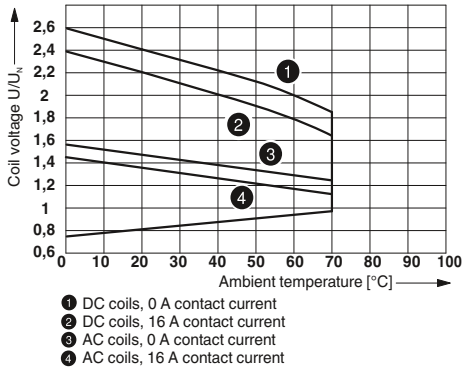

Interrupting rating

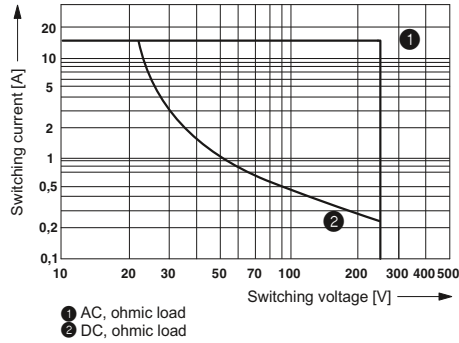

Electrical service life

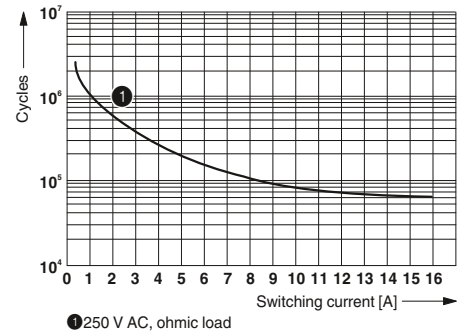

Service life reduction factor with various cos phi



REL-MR...21-21...MS (2 PDTs)

Operating voltage range



Interrupting rating

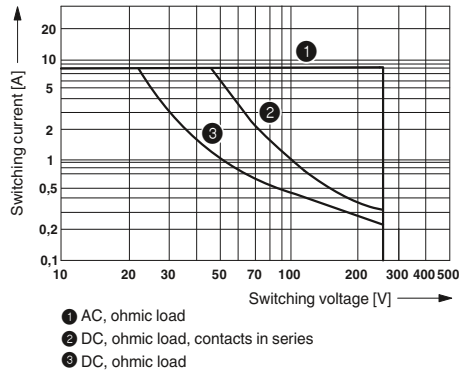

Electrical service life

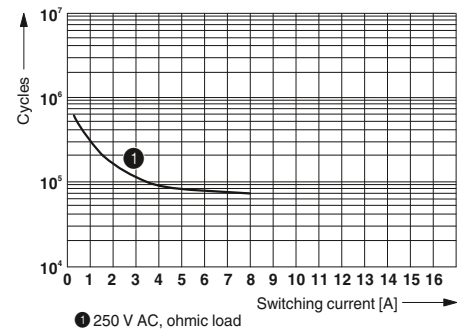

Service life reduction factor with various cos phi



Plug-in solid-state relays

Plug-in solid-state relays suitable for RIF-1, PR1, and PLC-INTERFACE relay bases.

The advantages:

- Switching capacity of up to 24 V DC/5 A
- RT III wash tight (comparable to IP67)
- Vibration- and shock-resistant
- Wear-free and long-lasting
- Zero voltage switch at AC output
- Can be soldered in on PCB

Notes:

For dimensional drawings and perforations for assembly, see page 345



Max. DC voltage output of 5 A

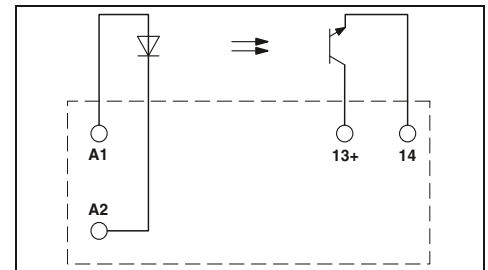

Technical data

| Input data | | ① | ② | ③ |
|--|------------------------------|--|-----------|-----------|
| Permissible range (with reference to U_N) | | 0.8 - 1.2 | 0.8 - 1.2 | 0.9 - 1.1 |
| Switching level | 1 signal ("H") [V DC] \geq | 2.5 | 16 | 35 |
| | 0 signal ("L") [V DC] \leq | 0.8 | 10 | 20 |
| Typ. input current at U_N | [mA] | 9 | 7 | 3 |
| Typ. switch-on time at U_N | [μ s] | 10 | 20 | 25 |
| Typ. switch-off time at U_N | [μ s] | 400 | 400 | 400 |
| Transmission frequency f_{limit} | [Hz] | 300 | 300 | 300 |
| Output data | | | | |
| Max. switching voltage | | 33 V DC | | |
| Min. switching voltage | | 3 V DC | | |
| Limiting continuous current | | 5 A (see derating curve) | | |
| Min. load current | | - | | |
| Max. inrush current | | 15 A (10 ms) | | |
| Leakage current in off state | | - | | |
| Phase angle (cos ϕ) | | - | | |
| Output circuit | | 2-conductor, floating | | |
| Max. load value | | - | | |
| Output protection | | Protection against polarity reversal, surge protection | | |
| Voltage drop at max. limiting continuous current | | \leq 200 mV | | |
| General data | | | | |
| Rated surge voltage | | Basic insulation | | |
| Test voltage input/output | | 2.5 kV (50 Hz, 1 min.) | | |
| Ambient temperature (operation) | | -25°C ... 60°C | | |
| Nominal operating mode | | 100% operating factor | | |
| Standards/regulations | | IEC 60664, EN 50178, IEC 62103 | | |
| Pollution degree/surge voltage category | | 2 / III | | |
| Mounting position/mounting | | Any / In rows with zero spacing | | |
| Dimensions | W / H / D | 12.7 mm / 29 mm / 15.7 mm | | |

Ordering data

| Description | Input voltage U_N | Type | Order No. | Pcs. / Pkt. |
|----------------------------|---------------------|-----------------|-----------|-------------|
| Plug-in solid-state relays | ① 5 V DC | OPT-5DC/24DC/5 | 2982113 | 10 |
| | ② 24 V DC | OPT-24DC/24DC/5 | 2982100 | 10 |
| | ③ 60 V DC | OPT-60DC/24DC/5 | 2982126 | 10 |



Max. AC voltage output of 2 mA



Technical data

| ① | ② | ③ |
|-------|-------|-------|
| 0.8 - | 0.8 - | 0.9 - |
| 1.2 | 1.2 | 1.1 |
| 3 | 18 | 40 |
| 1 | 8.4 | 20 |
| 15 | 7 | 2.6 |
| 10000 | 10000 | 10000 |
| 10000 | 10000 | 10000 |
| 10 | 10 | 10 |

253 V AC
 24 V AC
 2 A (see derating curve)
 25 mA
 30 A (10 ms)
 < 1 mA
 -
 2-conductor floating, zero voltage switch
 4 A²s (tp = 10 ms, at 25°C)
 Surge protection
 ≤ 1 V

Basic insulation
 2.5 kV (50 Hz, 1 min.)
 -25°C ... 60°C
 100% operating factor
 IEC 60664, EN 50178, IEC 62103
 2 / III
 Any / See derating curve
 12.7 mm / 29 mm / 15.7 mm

Ordering data

| Type | Order No. | Pcs. / Pkt. |
|-------------------|-----------|-------------|
| OPT-5DC/230AC/ 2 | 2982168 | 10 |
| OPT-24DC/230AC/ 2 | 2982171 | 10 |
| OPT-60DC/230AC/ 2 | 2982184 | 10 |

Derating curve for OPT...DC/24DC/5 solid-state relays



Derating curve for OPT...DC/230AC/2 solid-state relays

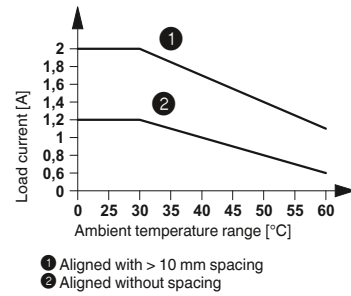

- ① Aligned with > 10 mm spacing
- ② Aligned without spacing

Relay modules

RIFLINE complete

Modular RIF-2 relay base

Relay base that can be fitted with 2 or 4 PDT relays.

Range of accessories includes:

- Plug-in input and interference suppression module
- Plug-in timer module
- Relay retaining bracket with ejector function and holder for marking material
- Comprehensive range of marking material
- Test plug
- FBS 2-6 plug-in bridges for the input side (A2)

| |
|--|
| Notes: |
| Type of insulating housing: Polyamide PA non-reinforced, color: gray. |
| For further marking systems and mounting material, see Catalog 5. |



4 PDT relay base for industrial relay

N

Nominal voltage U_N
Nominal current at U_N

| Technical data | |
|--------------------------|---|
| Nominal voltage U_N | 250 V AC |
| Nominal current at U_N | max. 12 A (Depends on application/assembly) |

| General data | |
|--|---|
| Ambient temperature (operation) | -40°C ... 85°C (Depends on application/assembly) |
| Connection data solid / stranded / AWG | 0.14 ... 1.5 mm ² / 0.14 ... 1.5 mm ² / 26 - 16 |
| Dimensions | |
| Width | 31 mm |
| Depth with retaining bracket | 75 mm |
| Height | 93 mm |

| Description | |
|--|--|
| RIF-2 relay base , plug-in option for input/interference suppression module, safe isolation I/O with push-in connection | |
| Relay retaining bracket , with ejector function and holder for marking material, suitable for RIF-2 relay base | |

| Ordering data | | |
|----------------|-----------|-------------|
| Type | Order No. | Pcs. / Pkt. |
| RIF-2-BPT/4X21 | 2900934 | 10 |

| Plug-in bridge | |
|---|--------|
| 2-pos. red | |
| 2-pos. blue | |
| 2-pos. gray | |
| End clamp , to snap on NS 35, 9.5 mm wide, can be labeled with ZB 6, ZB 8/27, KLM... | |
| Test plug, consisting of: | |
| Metal part for 2.3 mm Ø socket hole and | |
| Insulating sleeve , for MPS metal part | red |
| | white |
| | blue |
| | yellow |
| | green |
| | gray |
| | black |
| Zack marker strip, unprinted | |
| 10-section | |
| 5-section | |
| Double marker carrier for ZB 5 | |

| Accessories | | |
|------------------|---------|-----|
| FBS 2-6 | 3030336 | 50 |
| FBS 2-6 BU | 3036932 | 50 |
| FBS 2-6 GY | 3032237 | 50 |
| CLIPFIX 35 | 3022218 | 50 |
| MPS-MT | 0201744 | 10 |
| MPS-IH RD | 0201676 | 10 |
| MPS-IH WH | 0201663 | 10 |
| MPS-IH BU | 0201689 | 10 |
| MPS-IH YE | 0201692 | 10 |
| MPS-IH GN | 0201702 | 10 |
| MPS-IH GY | 0201728 | 10 |
| MPS-IH BK | 0201731 | 10 |
| ZB 5 :UNBEDRUCKT | 1050004 | 10 |
| ZB 15:UNBEDRUCKT | 0811972 | 10 |
| STP 5-2 | 0800967 | 100 |

N



Relay retaining bracket

Technical data

-
-
-
-
-
-

Ordering data

| Type | Order No. | Pcs. / Pkt. |
|----------|-----------|-------------|
| RIF-RH-2 | 2900954 | 10 |

Accessories

| Type | Order No. | Pcs. / Pkt. |
|------|-----------|-------------|
| | | |
| | | |
| | | |

Plug-in industrial relays with 2 or 4 PDT contacts, suitable for RIF-2 and PR2 relay bases.

The advantages:

- Detectable manual operation
- Mechanical switch position indicator
- Integrated status LED
- Multi-layer gold contact or power contact
- DC types with integrated freewheeling diode



2 PDT relay



4 PDT relay

Notes:
For other voltages, see www.phoenixcontact.net/products



| Input data | |
|--|------|
| Permissible range (with reference to U_N) | |
| Typ. input current at U_N | [mA] |
| Typ. response time at U_N | [ms] |
| Typ. response time at U_N (depending on phase relation) | [ms] |
| Typ. release time at U_N | [ms] |
| Typ. release time at U_N (depending on phase relation) | [ms] |
| Output data | |
| Contact data | |
| Contact type | |
| Contact material | |
| Max. switching voltage | |
| Min. switching voltage | |
| Limiting continuous current | |
| Max. inrush current, AC | |
| Max. inrush current, DC | |
| Min. switching current | |
| General data | |
| Test voltage (winding / contact) | |
| Ambient temperature (operation), AC | |
| Ambient temperature (operation), DC | |
| Mechanical service life, AC | |
| Mechanical service life, DC | |
| Standards/regulations | |

| Technical data | | | | | | | |
|---------------------------------------|----|----|----|----|--------|--------|--------|
| ① | ② | ③ | ④ | ⑤ | ⑥ | ⑦ | ⑧ |
| refer to the diagram | | | | | | | |
| 78 | 41 | 22 | 18 | 8 | 70 | 13 | 6.5 |
| 13 | 13 | 13 | 13 | 13 | 5 - 15 | 5 - 15 | 5 - 15 |
| 14 | 14 | 14 | 14 | 14 | 5 - 20 | 5 - 20 | 5 - 20 |
| Single contact, 2-PDT | | | | | | | |
| AgNi | | | | | | | |
| 250 V AC/DC | | | | | | | |
| 5 V (At 24 mA) | | | | | | | |
| 12 A | | | | | | | |
| 30 A (20 ms, N/O contact) | | | | | | | |
| 30 A (20 ms, N/O contact) | | | | | | | |
| 5 mA (at 24 V) | | | | | | | |
| 2.5 kV _{rms} (50 Hz, 1 min.) | | | | | | | |
| -40°C ... 55°C | | | | | | | |
| -40°C ... 70°C | | | | | | | |
| Approx. 2 x 10 ⁷ cycles | | | | | | | |
| Approx. 2 x 10 ⁷ cycles | | | | | | | |
| IEC 60664 | | | | | | | |

| Technical data | | | | | | | |
|---------------------------------------|----|----|----|----|--------|--------|--------|
| ① | ② | ③ | ④ | ⑤ | ⑥ | ⑦ | ⑧ |
| refer to the diagram | | | | | | | |
| 78 | 41 | 22 | 18 | 8 | 70 | 13 | 6.5 |
| 13 | 13 | 13 | 13 | 13 | 5 - 15 | 5 - 15 | 5 - 15 |
| 14 | 14 | 14 | 14 | 14 | 5 - 20 | 5 - 20 | 5 - 20 |
| Single contact, 4-PDT | | | | | | | |
| AgNi | | | | | | | |
| 250 V AC/DC | | | | | | | |
| 5 V (At 24 mA) | | | | | | | |
| 6 A | | | | | | | |
| 16 A (20 ms, N/O contact) | | | | | | | |
| 16 A (20 ms, N/O contact) | | | | | | | |
| 5 mA (at 24 V) | | | | | | | |
| 2.5 kV _{rms} (50 Hz, 1 min.) | | | | | | | |
| -40°C ... 55°C | | | | | | | |
| -40°C ... 70°C | | | | | | | |
| Approx. 2 x 10 ⁷ cycles | | | | | | | |
| Approx. 2 x 10 ⁷ cycles | | | | | | | |
| IEC 60664 | | | | | | | |

| Description | | Input voltage U_N |
|--|---|---------------------|
| Plug-in industrial relays, with power contacts | | |
| With freewheeling diode | ① | 12 V DC |
| With freewheeling diode | ② | 24 V DC |
| With freewheeling diode | ③ | 48 V DC |
| With freewheeling diode | ④ | 60 V DC |
| With freewheeling diode | ⑤ | 110 V DC |
| | ⑥ | 24 V AC |
| | ⑦ | 120 V AC |
| | ⑧ | 230 V AC |
| Plug-in industrial relays, with multi-layer gold contacts | | |
| With freewheeling diode | ① | 12 V DC |
| With freewheeling diode | ② | 24 V DC |
| With freewheeling diode | ③ | 48 V DC |
| With freewheeling diode | ④ | 60 V DC |
| With freewheeling diode | ⑤ | 110 V DC |
| | ⑥ | 24 V AC |
| | ⑦ | 120 V AC |
| | ⑧ | 230 V AC |

| Ordering data | | |
|------------------------|-----------|-------------|
| Type | Order No. | Pcs. / Pkt. |
| REL-IR2/LDP- 12DC/2X21 | 2903659 | 10 |
| REL-IR2/LDP- 24DC/2X21 | 2903660 | 10 |
| REL-IR2/LDP- 48DC/2X21 | 2903661 | 10 |
| REL-IR2/LDP- 60DC/2X21 | 2903662 | 10 |
| REL-IR2/LDP-110DC/2X21 | 2903663 | 10 |
| REL-IR2/L- 24AC/2X21 | 2903666 | 10 |
| REL-IR2/L-120AC/2X21 | 2903667 | 10 |
| REL-IR2/L-230AC/2X21 | 2903668 | 10 |

| Ordering data | | |
|--------------------------|-----------|-------------|
| Type | Order No. | Pcs. / Pkt. |
| REL-IR4/LDP- 12DC/4X21 | 2903676 | 10 |
| REL-IR4/LDP- 24DC/4X21 | 2903677 | 10 |
| REL-IR4/LDP- 48DC/4X21 | 2903678 | 10 |
| REL-IR4/LDP- 60DC/4X21 | 2903679 | 10 |
| REL-IR4/LDP-110DC/4X21 | 2903680 | 10 |
| REL-IR4/L- 24AC/4X21 | 2903686 | 10 |
| REL-IR4/L-120AC/4X21 | 2903687 | 10 |
| REL-IR4/L-230AC/4X21 | 2903688 | 10 |
| REL-IR4/LDP- 12DC/4X21AU | 2903669 | 10 |
| REL-IR4/LDP- 24DC/4X21AU | 2903670 | 10 |
| REL-IR4/LDP- 48DC/4X21AU | 2903671 | 10 |
| REL-IR4/LDP- 60DC/4X21AU | 2903672 | 10 |
| REL-IR4/LDP-110DC/4X21AU | 2903673 | 10 |
| REL-IR4/L- 24AC/4X21AU | 2903683 | 10 |
| REL-IR4/L-120AC/4X21AU | 2903684 | 10 |
| REL-IR4/L-230AC/4X21AU | 2903685 | 10 |

REL-IR2... (2 PDTs)

Operating voltage range



Interrupting rating

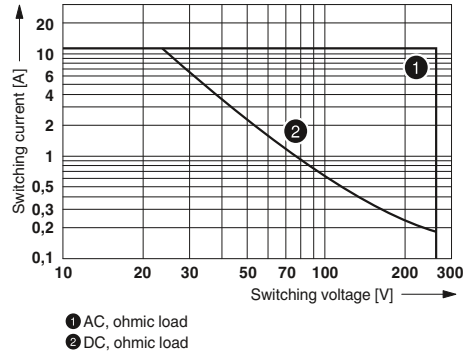

Electrical service life

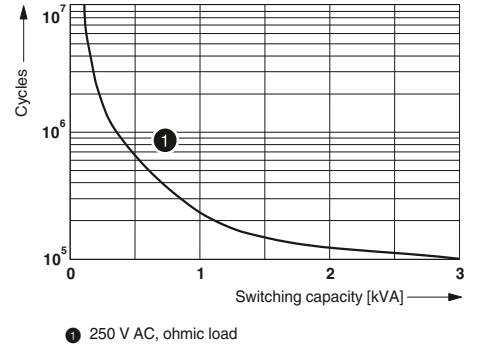

Service life reduction factor

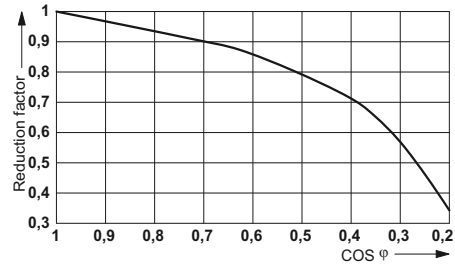

REL-IR4... (4 PDTs)

Operating voltage range



Interrupting rating

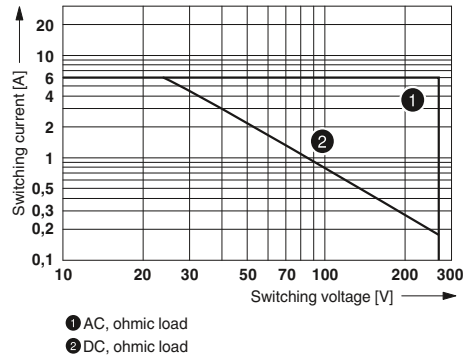

Electrical service life

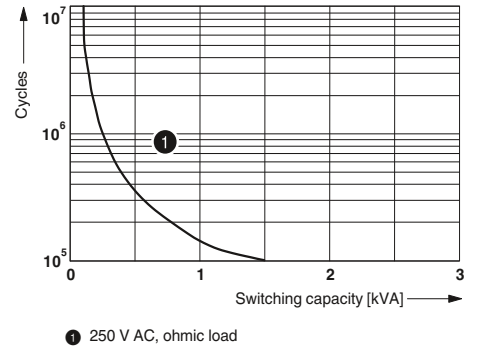

Service life reduction factor

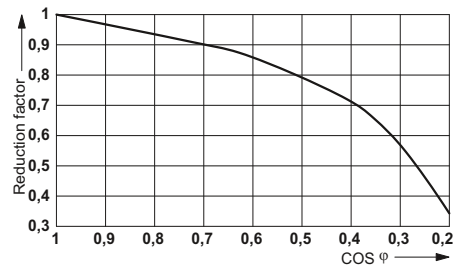

Modular RIF-3 relay base

Relay base that can be fitted with 2 or 3 PDT relays.

Range of accessories includes:

- Plug-in input and interference suppression module
- Plug-in timer module
- Relay retaining bracket with ejector function and holder for marking material
- Comprehensive range of marking material
- Test plug
- FBS 2-6 plug-in bridges for the input side (A2)

| Notes: |
|--|
| Type of insulating housing: Polyamide PA non-reinforced, color: gray. |
| For further marking systems and mounting material, see Catalog 5. |



2 PDT relay base for octal relay

N

Nominal voltage U_N
Nominal current at U_N

Technical data

250 V AC
max. 12 A (Depends on application/assembly)

| General data |
|--|
| Ambient temperature (operation) |
| Connection data solid / stranded / AWG |
| Dimensions |
| Width |
| Depth with retaining bracket |
| Height |

-40°C ... 85°C (Depends on application/assembly)
0.14 ... 1.5 mm² / 0.14 ... 1.5 mm² / 26 - 16
40 mm
90 mm
100 mm

| Description |
|---|
| RIF-3 relay base , 2 PDT version, plug-in option for input/interference suppression module, safe isolation I/O with push-in connection |
| RIF-3 relay base , 3 PDT version, plug-in option for input/interference suppression module, safe isolation I/O with push-in connection |
| Relay retaining bracket , with holder for marking material, suitable for RIF-3 relay base |

Ordering data

| Type | Order No. | Pcs. / Pkt. |
|----------------|-----------|-------------|
| RIF-3-BPT/2X21 | 2900937 | 10 |

| | |
|--|--|
| Plug-in bridge 2-pos. red 2-pos. blue 2-pos. gray End clamp , to snap on NS 35, 9.5 mm wide, can be labeled with ZB 6, ZB 8/27, KLM... | |
| Test plug , consisting of: Metal part for 2.3 mm Ø socket hole and Insulating sleeve , for MPS metal part | red white blue yellow green gray black |
| Zack marker strip , unprinted 10-section 5-section Double marker carrier for ZB 5 | |

Accessories

| | | |
|---|---|--|
| FBS 2-6 FBS 2-6 BU FBS 2-6 GY | 3030336 3036932 3032237 | 50 50 50 |
| CLIPFIX 35 | 3022218 | 50 |
| MPS-MT | 0201744 | 10 |
| MPS-IH RD MPS-IH WH MPS-IH BU MPS-IH YE MPS-IH GN MPS-IH GY MPS-IH BK | 0201676 0201663 0201689 0201692 0201702 0201728 0201731 | 10 10 10 10 10 10 10 |
| ZB 5 :UNBEDRUCKT ZB 15:UNBEDRUCKT STP 5-2 | 1050004 0811972 0800967 | 10 10 100 |



3 PDT relay base for octal relay

N



Relay retaining bracket

N

| Technical data |
|---|
| 250 V AC |
| max. 12 A (Depends on application/assembly) |
| -40°C ... 85°C (Depends on application/assembly) |
| 0.14 ... 1.5 mm ² / 0.14 ... 1.5 mm ² / 26 - 16 |
| 40 mm |
| 90 mm |
| 100 mm |

| Technical data |
|----------------|
| - |
| - |
| - |
| - |
| - |
| - |

| Ordering data | | |
|----------------|-----------|-------------|
| Type | Order No. | Pcs. / Pkt. |
| RIF-3-BPT/3X21 | 2900938 | 10 |

| Ordering data | | |
|---------------|-----------|-------------|
| Type | Order No. | Pcs. / Pkt. |
| RIF-RH-3 | 2900955 | 10 |

| Accessories | | |
|------------------|---------|-----|
| FBS 2-6 | 3030336 | 50 |
| FBS 2-6 BU | 3036932 | 50 |
| FBS 2-6 GY | 3032237 | 50 |
| CLIPFIX 35 | 3022218 | 50 |
| MPS-MT | 0201744 | 10 |
| MPS-IH RD | 0201676 | 10 |
| MPS-IH WH | 0201663 | 10 |
| MPS-IH BU | 0201689 | 10 |
| MPS-IH YE | 0201692 | 10 |
| MPS-IH GN | 0201702 | 10 |
| MPS-IH GY | 0201728 | 10 |
| MPS-IH BK | 0201731 | 10 |
| ZB 5 :UNBEDRUCKT | 1050004 | 10 |
| ZB 15:UNBEDRUCKT | 0811972 | 10 |
| STP 5-2 | 0800967 | 100 |

| Accessories | | |
|-------------|--|--|
| | | |
| | | |
| | | |
| | | |
| | | |
| | | |
| | | |
| | | |
| | | |
| | | |
| | | |

Relay modules

RIFLINE complete

Plug-in octal relays

Plug-in octal relays with 2 or 3 PDT contacts, suitable for RIF-3 and PR3 relay bases.

The advantages:

- Detectable manual operation
- Mechanical switch position indicator
- Integrated status LED
- DC types with integrated freewheeling diode



2 PDT relay



3 PDT relay



Technical data

| ① | ② | ③ | ④ |
|----------------------|--------|--------|--------|
| refer to the diagram | | | |
| 60 | 108 | 23 | 13 |
| 18 | | | |
| | 5 - 15 | 5 - 15 | 5 - 15 |
| | | | |
| | 5 - 20 | 5 - 20 | 5 - 20 |

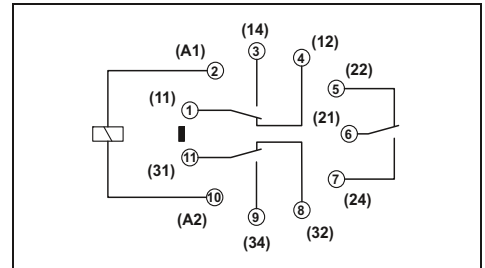

Technical data

| ① | ② | ③ | ④ |
|----------------------|--------|--------|--------|
| refer to the diagram | | | |
| 60 | 108 | 23 | 13 |
| 18 | | | |
| | 5 - 15 | 5 - 15 | 5 - 15 |
| | | | |
| | 5 - 20 | 5 - 20 | 5 - 20 |

| | |
|--|---------------------------------------|
| Input data | |
| Permissible range (with reference to U_N) | |
| Typ. input current at U_N | [mA] |
| Typ. response time at U_N | [ms] |
| Typ. response time at U_N (depending on phase relation) | [ms] |
| Typ. release time at U_N | [ms] |
| Typ. release time at U_N (depending on phase relation) | [ms] |
| Output data | |
| Contact type | Single contact, 2-PDT |
| Contact material | AgNi |
| Max. switching voltage | 250 V AC/DC |
| Min. switching voltage | 10 V (At 24 mA) |
| Limiting continuous current | 10 A |
| Max. inrush current, AC | 30 A (20 ms, N/O contact) |
| Max. inrush current, DC | 30 A (20 ms, N/O contact) |
| Min. switching current | 10 mA (at 24 V) |
| General data | |
| Test voltage (winding / contact) | 2.5 kV _{rms} (50 Hz, 1 min.) |
| Ambient temperature (operation), AC | -40°C ... 55°C |
| Ambient temperature (operation), DC | -40°C ... 70°C |
| Nominal operating mode | 100% operating factor |
| Mechanical service life, AC | Approx. 2×10^7 cycles |
| Mechanical service life, DC | Approx. 2×10^7 cycles |
| Standards/regulations | IEC 60664 |
| Mounting position/mounting | Any |
| Dimensions | W / H / D 35 mm / 54.4 mm / 35 mm |

Ordering data

| Type | Order No. | Pcs. / Pkt. |
|------------------------|-----------|-------------|
| REL-OR2/LDP- 24DC/2X21 | 2903689 | 10 |
| REL-OR2/L- 24AC/2X21 | 2903690 | 10 |
| REL-OR2/L-120AC/2X21 | 2903691 | 10 |
| REL-OR2/L-230AC/2X21 | 2903692 | 10 |

Ordering data

| Type | Order No. | Pcs. / Pkt. |
|-----------------------|-----------|-------------|
| REL-OR3/LDP-24DC/3X21 | 2903693 | 10 |
| REL-OR3/L- 24AC/3X21 | 2903694 | 10 |
| REL-OR3/L-120AC/3X21 | 2903695 | 10 |
| REL-OR3/L-230AC/3X21 | 2903696 | 10 |

| Description | Input voltage U_N |
|--|---------------------|
| Plug-in octal relays, with power contacts | |
| With freewheeling diode | |
| ① | 24 V DC |
| ② | 24 V AC |
| ③ | 120 V AC |
| ④ | 230 V AC |

REL-OR2... (2 PDTs)

Operating voltage range



Interrupting rating

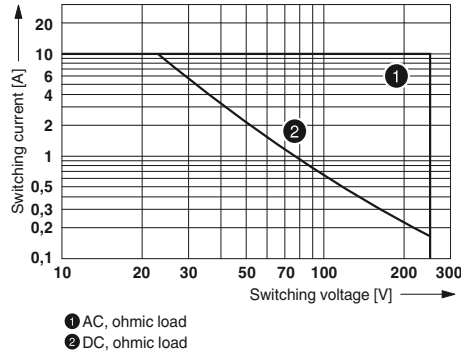

Electrical service life



Service life reduction factor



REL-OR3... (3 PDTs)

Operating voltage range



Interrupting rating

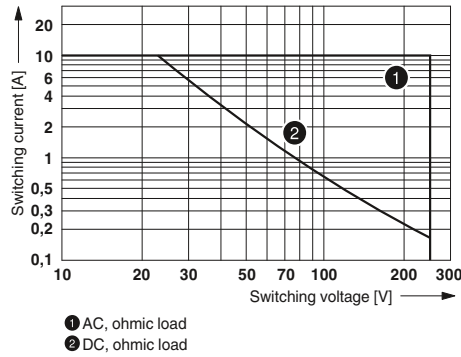

Electrical service life



Service life reduction factor



Modular RIF-4 relay base

Relay base that can be fitted with 2 or 3 PDT relays or 3 N/O relays.

Range of accessories includes:

- Plug-in input and interference suppression module
- Plug-in timer module
- Relay retaining bracket with ejector function and holder for marking material
- Comprehensive range of marking material
- Test plug
- FBS 2-6 plug-in bridges for the input side (A2)

| Notes: |
|--|
| Type of insulating housing: Polyamide PA non-reinforced, color: gray. |
| For further marking systems and mounting material, see Catalog 5. |



3 PDT relay base for high-power relay

N

Nominal voltage U_N
Nominal current at U_N

| Technical data | |
|--------------------------|---|
| Nominal voltage U_N | 400 V AC |
| Nominal current at U_N | max. 16 A (Depends on application/assembly) |

| General data | |
|--|---|
| Ambient temperature (operation) | -40°C ... 85°C (Depends on application/assembly) |
| Connection data solid / stranded / AWG | |
| Input side | 0.14 ... 1.5 mm ² / 0.14 ... 1.5 mm ² / 26 - 16 |
| Output side | 0.14 ... 2.5 mm ² / 0.14 ... 2.5 mm ² / 26 - 14 |
| Dimensions | |
| Width | 43 mm |
| Depth with retaining bracket | 90 mm |
| Height | 107 mm |

| Technical data | |
|---------------------------------|---|
| Ambient temperature (operation) | -40°C ... 85°C (Depends on application/assembly) |
| Input side | 0.14 ... 1.5 mm ² / 0.14 ... 1.5 mm ² / 26 - 16 |
| Output side | 0.14 ... 2.5 mm ² / 0.14 ... 2.5 mm ² / 26 - 14 |
| Width | 43 mm |
| Depth with retaining bracket | 90 mm |
| Height | 107 mm |

| Ordering data | |
|--|----------------|
| Description | Type |
| RIF-4 relay base , plug-in option for input/interference suppression module, safe isolation I/O with push-in connection | RIF-4-BPT/3X21 |
| Relay retaining bracket , with holder for marking material, suitable for RIF-4 relay base | |

| Ordering data | | |
|----------------|-----------|-------------|
| Type | Order No. | Pcs. / Pkt. |
| RIF-4-BPT/3X21 | 2900961 | 10 |

| Accessories | |
|---|---|
| Plug-in bridge 2-pos. red 2-pos. blue 2-pos. gray | FBS 2-6 FBS 2-6 BU FBS 2-6 GY |
| End clamp , to snap on NS 35, 9.5 mm wide, can be labeled with ZB 6, ZB 8/27, KLM... | CLIPFIX 35 |
| Test plug , consisting of: Metal part for 2.3 mm Ø socket hole and | MPS-MT |
| Insulating sleeve , for MPS metal part | MPS-IH RD MPS-IH WH MPS-IH BU MPS-IH YE MPS-IH GN MPS-IH GY MPS-IH BK |
| Zack marker strip, unprinted 10-section 5-section | ZB 5 :UNBEDRUCKT ZB 15:UNBEDRUCKT |
| Double marker carrier for ZB 5 | STP 5-2 |

| Accessories | | |
|------------------|-----------|-------------|
| Type | Order No. | Pcs. / Pkt. |
| FBS 2-6 | 3030336 | 50 |
| FBS 2-6 BU | 3036932 | 50 |
| FBS 2-6 GY | 3032237 | 50 |
| CLIPFIX 35 | 3022218 | 50 |
| MPS-MT | 0201744 | 10 |
| MPS-IH RD | 0201676 | 10 |
| MPS-IH WH | 0201663 | 10 |
| MPS-IH BU | 0201689 | 10 |
| MPS-IH YE | 0201692 | 10 |
| MPS-IH GN | 0201702 | 10 |
| MPS-IH GY | 0201728 | 10 |
| MPS-IH BK | 0201731 | 10 |
| ZB 5 :UNBEDRUCKT | 1050004 | 10 |
| ZB 15:UNBEDRUCKT | 0811972 | 10 |
| STP 5-2 | 0800967 | 100 |

N



Relay retaining bracket

Technical data

-
-
-
-
-
-
-

Ordering data

| Type | Order No. | Pcs. / Pkt. |
|----------|-----------|-------------|
| RIF-RH-4 | 2900956 | 10 |

Accessories

| Type | Order No. | Pcs. / Pkt. |
|------|-----------|-------------|
| | | |
| | | |
| | | |

Relay modules

RIFLINE complete

Plug-in high-power relays

Plug-in high-power relays with 2 or 3 PDT contacts for the RIF-4 relay base.

The advantages:

- Use in miniature contactor applications
- Switching current of up to 16 A
- Up to 440 V AC switching voltage



2 PDT relay



3 PDT relay



Technical data

| | ① | ② | ③ | ④ |
|--|---------------------------|--|--------|--------|
| Input data | refer to the diagram | | | |
| Permissible range (with reference to U_N) | | | | |
| Typ. input current at U_N | [mA] | 56 | 116 | 23 |
| Typ. response time at U_N | [ms] | 20 | | |
| Typ. response time at U_N (depending on phase relation) | [ms] | | 5 - 25 | 5 - 25 |
| Typ. release time at U_N | [ms] | 15 | | |
| Typ. release time at U_N (depending on phase relation) | [ms] | | 5 - 20 | 5 - 20 |
| Output data | | | | |
| Contact type | Single contact, 2-PDT | | | |
| Contact material | AgNi | | | |
| Max. switching voltage | 440 V AC / 250 V DC | | | |
| Min. switching voltage | 10 V (At 24 mA) | | | |
| Limiting continuous current | 16 A | | | |
| Max. inrush current, AC | 50 A (20 ms, N/O contact) | | | |
| Max. inrush current, DC | 50 A (20 ms, N/O contact) | | | |
| Min. switching current | 10 mA (at 24 V) | | | |
| Max. interrupting rating, ohmic load | 250 V AC | 4000 VA | | |
| | 440 V AC | 4000 VA | | |
| Motor load according to UL 508 | | 1/3 HP, 120 V AC (single-phase AC motor) | | |
| | | 1/2 HP, 240 V AC (single-phase AC motor) | | |

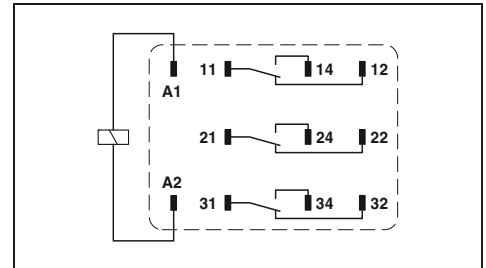

Technical data

| | ① | ② | ③ | ④ |
|--|----------------------------|--|--------|--------|
| Input data | refer to the diagram | | | |
| Permissible range (with reference to U_N) | | | | |
| Typ. input current at U_N | [mA] | 56 | 116 | 23 |
| Typ. response time at U_N | [ms] | 20 | | |
| Typ. response time at U_N (depending on phase relation) | [ms] | | 5 - 25 | 5 - 25 |
| Typ. release time at U_N | [ms] | 15 | | |
| Typ. release time at U_N (depending on phase relation) | [ms] | | 5 - 20 | 5 - 20 |
| Output data | | | | |
| Contact type | Single contact, three PDTs | | | |
| Contact material | AgNi | | | |
| Max. switching voltage | 440 V AC / 250 V DC | | | |
| Min. switching voltage | 10 V (At 24 mA) | | | |
| Limiting continuous current | 16 A | | | |
| Max. inrush current, AC | 50 A (20 ms, N/O contact) | | | |
| Max. inrush current, DC | 50 A (20 ms, N/O contact) | | | |
| Min. switching current | 10 mA (at 24 V) | | | |
| Max. interrupting rating, ohmic load | 250 V AC | 4000 VA | | |
| | 440 V AC | 4000 VA | | |
| Motor load according to UL 508 | | 1/3 HP, 120 V AC (single-phase AC motor) | | |
| | | 1/2 HP, 240 V AC (single-phase AC motor) | | |
| | | 1/2 HP, 240 V AC (three-phase induction motor) | | |

| General data | |
|-------------------------------------|--|
| Test voltage (winding / contact) | 2.5 kV _{rms} (50 Hz, 1 min.) |
| Ambient temperature (operation), AC | -40°C ... 55°C |
| Ambient temperature (operation), DC | -40°C ... 70°C |
| Nominal operating mode | 100% operating factor |
| Mechanical service life, AC | Approx. 10 ⁷ cycles |
| Mechanical service life, DC | Approx. 10 ⁷ cycles |
| Standards/regulations | IEC 60664 |
| Mounting position/mounting | Any |
| Dimensions | W / H / D 38.6 mm / 45.5 mm / 36.1 mm |

| General data | |
|-------------------------------------|--|
| Test voltage (winding / contact) | 2.5 kV _{rms} (50 Hz, 1 min.) |
| Ambient temperature (operation), AC | -40°C ... 55°C |
| Ambient temperature (operation), DC | -40°C ... 70°C |
| Nominal operating mode | 100% operating factor |
| Mechanical service life, AC | Approx. 10 ⁷ cycles |
| Mechanical service life, DC | Approx. 10 ⁷ cycles |
| Standards/regulations | IEC 60664 |
| Mounting position/mounting | Any |
| Dimensions | W / H / D 38.6 mm / 45.5 mm / 36.1 mm |

Ordering data

| Description | Input voltage U_N | Type | Order No. | Pcs. / Pkt. |
|--|---------------------|--------------------|-----------|-------------|
| Plug-in high-power relays, 2 PDTs with power contacts | | | | |
| | ① 24 V DC | REL-PR2- 24DC/2X21 | 2903698 | 1 |
| | ② 24 V AC | REL-PR2- 24AC/2X21 | 2903699 | 1 |
| | ③ 120 V AC | REL-PR2-120AC/2X21 | 2903700 | 1 |
| | ④ 230 V AC | REL-PR2-230AC/2X21 | 2903701 | 1 |
| Plug-in high-power relays, 3 PDTs with power contacts | | | | |
| | ① 24 V DC | | | |
| | ② 24 V AC | | | |
| | ③ 120 V AC | | | |
| | ④ 230 V AC | | | |

Ordering data

| Type | Order No. | Pcs. / Pkt. |
|--------------------|-----------|-------------|
| REL-PR3- 24DC/3X21 | 2903702 | 1 |
| REL-PR3- 24AC/3X21 | 2903703 | 1 |
| REL-PR3-120AC/3X21 | 2903704 | 1 |
| REL-PR3-230AC/3X21 | 2903705 | 1 |

REL-PR2... (2 PDTs)

Operating voltage range



- 1 Maximum continuous voltage at limiting continuous current = 16 A
 - 2 Minimum operate voltage
- For pre-excitation with UN and limiting continuous current = 16 A

Interrupting rating

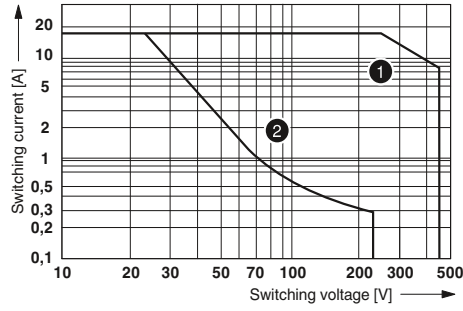

- 1 AC, ohmic load
- 2 DC, ohmic load

Electrical service life



- 1 250 V AC, ohmic load

Service life reduction factor



REL-PR3... (3 PDTs)

Operating voltage range



- 1 DC coils
- 2 AC coils

Interrupting rating

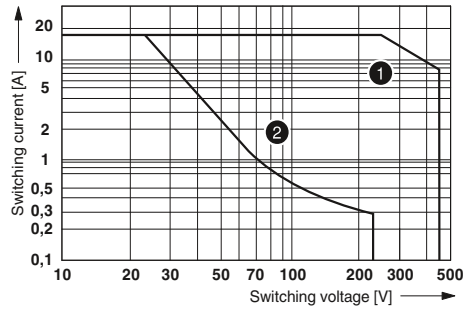

- 1 AC, ohmic load
- 2 DC, ohmic load

Electrical service life



- 1 250 V AC, ohmic load

Service life reduction factor

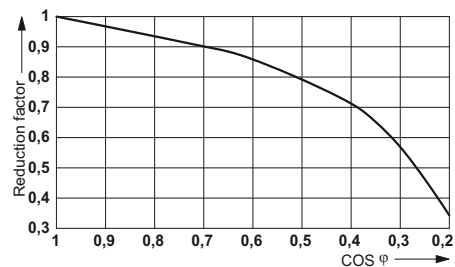

Relay modules

RIFLINE complete

Plug-in high-power relays

N

Plug-in high-power relays with 3 N/O contacts suitable for the RIF-4 relay base.

The advantages:

- Use in miniature contactor applications
- Switching current of up to 16 A
- Up to 440 V AC switching voltage
- Full shutdown by means of ≥ 3 mm contact opening



3 N/O relay



Technical data

| | ① | ② | ③ | ④ |
|--|---------------------------------------|--|--------|--------|
| Input data | refer to the diagram | | | |
| Permissible range (with reference to U_N) | | | | |
| Typ. input current at U_N | [mA] | 70 | 116 | 23 |
| Typ. response time at U_N | [ms] | 20 | | |
| Typ. response time at U_N (depending on phase relation) | [ms] | | 5 - 25 | 5 - 25 |
| Typ. release time at U_N | [ms] | 15 | | |
| Typ. release time at U_N (depending on phase relation) | [ms] | | 5 - 20 | 5 - 20 |
| Output data | | | | |
| Contact type | Single contact, 3 N/O contacts | | | |
| Contact material | AgNi | | | |
| Max. switching voltage | 440 V AC / 250 V DC | | | |
| Min. switching voltage | 10 V (At 24 mA) | | | |
| Limiting continuous current | 16 A | | | |
| Max. inrush current, AC | 50 A (20 ms, N/O contact) | | | |
| Max. inrush current, DC | 50 A (20 ms, N/O contact) | | | |
| Min. switching current | 10 mA (at 24 V) | | | |
| Max. interrupting rating, ohmic load | 250 V AC | 4000 VA | | |
| | 440 V AC | 4000 VA | | |
| Motor load according to UL 508 | | 1/3 HP, 120 V AC (single-phase AC motor) | | |
| | | 1/2 HP, 240 V AC (single-phase AC motor) | | |
| | | 1/2 HP, 240 V AC (three-phase induction motor) | | |
| General data | | | | |
| Test voltage (winding / contact) | 2.5 kV _{rms} (50 Hz, 1 min.) | | | |
| Ambient temperature (operation), AC | -40°C ... 55°C | | | |
| Ambient temperature (operation), DC | -40°C ... 70°C | | | |
| Nominal operating mode | 100% operating factor | | | |
| Mechanical service life, AC | Approx. 10 ⁷ cycles | | | |
| Mechanical service life, DC | Approx. 10 ⁷ cycles | | | |
| Standards/regulations | IEC 60664 | | | |
| Mounting position/mounting | Any | | | |
| Dimensions | W / H / D | 38.6 mm / 45.5 mm / 36.1 mm | | |

Ordering data

| Description | Input voltage U_N | Type | Order No. | Pcs. / Pkt. |
|--|---------------------|-------------------|-----------|-------------|
| Plug-in high-power relays, 3 N/O contacts with power contacts | | | | |
| | ① 24 V DC | REL-PR3- 24DC/3X1 | 2903706 | 1 |
| | ② 24 V AC | REL-PR3- 24AC/3X1 | 2903707 | 1 |
| | ③ 120 V AC | REL-PR3-120AC/3X1 | 2903708 | 1 |
| | ④ 230 V AC | REL-PR3-230AC/3X1 | 2903709 | 1 |

REL-PR2... (3 N/O contacts)

Operating voltage range



- ① DC coils
- ② AC coils

Interrupting rating

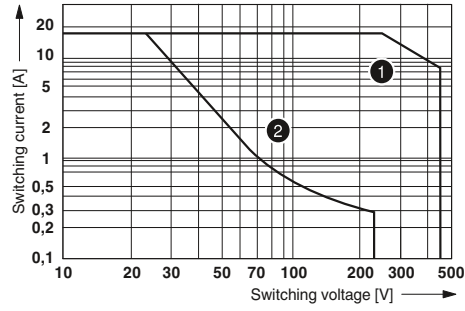

- ① AC, ohmic load
- ② DC, ohmic load

Electrical service life

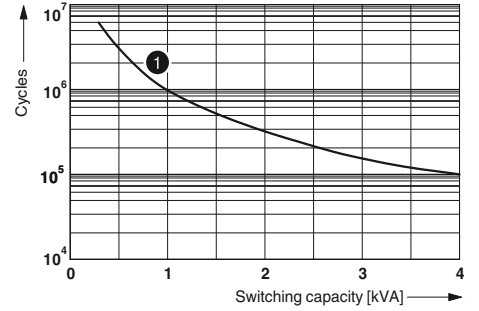

- ① 250 V AC, ohmic load

Service life reduction factor

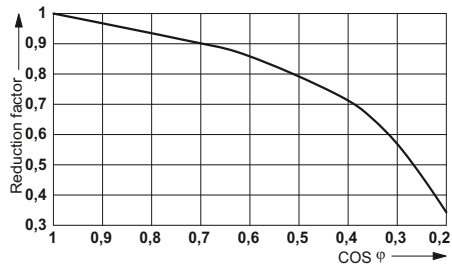

Input modules/interference suppression modules for RIF-1, RIF-2, RIF-3, and RIF-4

Plug-in input modules/interference suppression modules for optional fitting of RIF-1 to RIF-4 relay bases.

The advantages:

- Attenuation of reverse voltage induced in coil
- Mechanical coding to protect against incorrect connection



Input/interference suppression module

| Description | Ordering data | | |
|---|--|---|-------------------------|
| | Type | Order No. | Pcs. / Pkt. |
| <p>Plug-in module, with LED status indicator and freewheeling diode to effectively limit the coil induction voltage, polarity: A1+, A2-, input voltage:</p> <ul style="list-style-type: none"> - 12-24 V DC $\pm 20\%$ - 48-60 V DC $\pm 20\%$ - 110 V DC $\pm 20\%$ | <p>RIF-LDP-12-24 DC RIF-LDP-48-60 DC RIF-LDP-110 DC</p> | <p>2900939 2900940 2900941</p> | <p>10 10 10</p> |
| <p>Plug-in module, with LED status indicator and varistor to limit the coil induction voltage and/or external interference peaks, input voltage:</p> <ul style="list-style-type: none"> - 12-24 V AC/DC $\pm 20\%$ (30-V-varistor) - 48-60 V AC/DC $\pm 20\%$ (75-V-varistor) - 120-230 V AC/110 V DC $\pm 20\%$ (275-V-varistor) | <p>RIF-LV-12-24 UC RIF-LV-48-60 UC RIF-LV-120-230 AC/110 DC</p> | <p>2900942 2900943 2900944</p> | <p>10 10 10</p> |
| <p>Plug-in module, with varistor to limit the coil induction voltage and/or external interference peaks, input voltage:</p> <ul style="list-style-type: none"> - 12-24 V AC/DC $\pm 20\%$ (30-V-varistor) - 48-60 V AC/DC $\pm 20\%$ (75-V-varistor) - 120-230 V AC/110 V DC $\pm 20\%$ (275-V-varistor) | <p>RIF-V-12-24 UC RIF-V-48-60 UC RIF-V-120-230 UC</p> | <p>2900945 2900947 2900948</p> | <p>10 10 10</p> |
| <p>Plug-in module, with RC element to limit the coil induction voltage and/or external interference peaks, input voltage:</p> <ul style="list-style-type: none"> - 12-24 V AC/DC $\pm 20\%$ (220 nF/100 Ω) - 48-60 V AC/DC $\pm 20\%$ (220 nF/220 Ω) - 120 - 230 V AC/110 DC $\pm 20\%$ (100 nF/470 Ω) | <p>RIF-RC-12-24 UC RIF-RC-48-60 UC RIF-RC-120-230 UC</p> | <p>2900949 2900950 2900951</p> | <p>10 10 10</p> |

Plug-in timer module for RIF-1, RIF-2, RIF-3, and RIF-4

The multifunctional plug-in timer module transforms the relay module into a timer relay. The RIF-1 to RIF-4 bases can be fitted with this module. Using DIP switches, you can choose from three time ranges and select four time functions. Fine adjustments to the time are made using a potentiometer. Relays can be operated with an input voltage of 24 V AC/DC.

Functions:

- Switch-on delay
- Single shot leading edge
- Flasher/pulse generator

Time ranges:

- 0.5 s - 10 s
- 5 s - 100 s
- 0.5 min - 10 min
- 5 min - 100 min



Time module

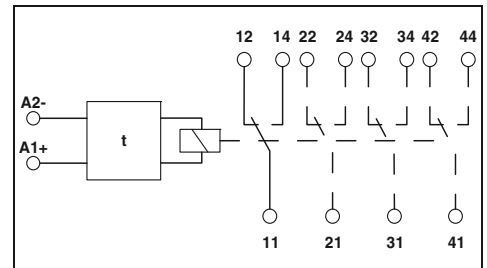

With switch-on delay

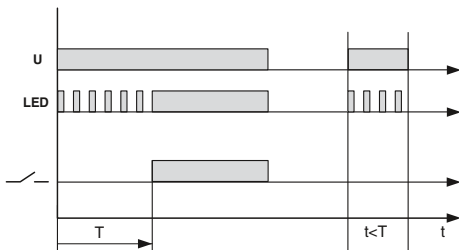

With passing make contact

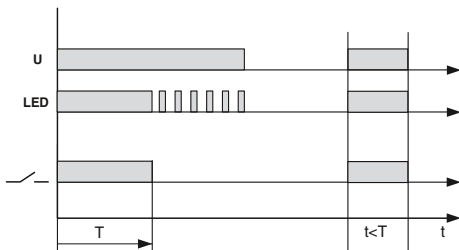

Flasher/pulse generator

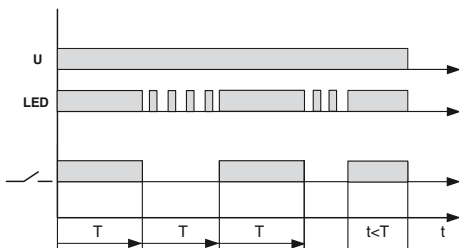

Input data

Nominal input voltage U_N
 Nominal input voltage range with reference to U_N
 Input circuit

Output data

Limiting continuous current

General data

Mounting position
 Repeat accuracy
 Ambient temperature (operation)

Standards/specifications

Rated insulation voltage
 Rated surge voltage

Technical data

24 V DC (AC operation only permitted for RIF-1)
 0.4 ... 1.2
 Varistor, Yellow LED

≤ 250 mA (Relay coil current)

Any

1%

- 25°C ... 50°C (RIF-1, AC coil, 2 PDTs at 6 A)
- 25°C ... 50°C (RIF-1, DC coil, 2 PDTs at 5 A)
- 25°C ... 40°C (RIF-2, DC coil, 2 PDTs at 8 A)
- 25°C ... 40°C (RIF-2, DC coil, 4 PDTs at 5 A)
- 25°C ... 40°C (RIF-3, DC coil, 3 PDTs at 6.75 A)
- 25°C ... 40°C (RIF-3, DC coil, 2 PDTs at 8 A)
- 25°C ... 35°C (RIF-4, DC coil, 3 PDTs at 8 A)
- 25°C ... 25°C (RIF-4, DC coil, 3 N/O contacts at 8 A)

DIN EN 50178

50 V DC

0.4 kV

Ordering data

| Type | Order No. | Pcs. / Pkt. |
|-------------|-----------|-------------|
| RIF-T3-24UC | 2902647 | 1 |

Description

Timer module, for mounting on RIF-1 to RIF-4, with LED status indicator for extending a relay module to create a timer relay with an input voltage of 24 V AC/DC

Relay modules

RIFLINE complete

Fully mounted RIF-0 relay modules

Fully mounted RIF-0 relay modules, consisting of:

- Relay base
- 1 N/O contact or 1 PDT relay
- Relay ejector lever on the housing

The advantages:

- Status LED integrated in the relay base
- Operational reliability thanks to sealed relay
- Safe isolation between coil and contact side
- Professional bridging of adjacent modules saves wiring time
- For FBS 2-6 plug-in bridges for the input and output side, see page 318.



RIF-0 relay module with 1 PDT relay

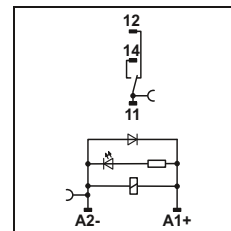

DC coils

| Input data | |
|--|-----------|
| Permissible range (with reference to U_N) | |
| Typ. input current at U_N | [mA] |
| Typ. response time at U_N | [ms] |
| Typ. release time at U_N | [ms] |
| Input protection: | |
| Output data | |
| Contact type | |
| Contact material | |
| Max. switching voltage | |
| Min. switching voltage | |
| Limiting continuous current | |
| Min. switching current | |
| General data | |
| Test voltage (winding / contact) | |
| Ambient temperature (operation) | |
| Nominal operating mode | |
| Mechanical service life | |
| Standards/regulations | |
| Pollution degree/surge voltage category | |
| Mounting position/mounting | |
| Connection data solid / stranded / AWG | |
| Dimensions | W / H / D |

| Technical data | | |
|---|-------------------------|--|
| ① | ② | |
| refer to the diagram | | |
| 16 | 9 | |
| 5 | 5 | |
| 8 | 8 | |
| Yellow LED, Damping diode | | |
| Single contact, 1-PDT | Single contact, 1-PDT | |
| AgSnO | AgSnO, hard gold-plated | |
| 250 V AC/DC | 30 V AC / 36 V DC | |
| 5 V (at 100 mA) | 100 mV (at 10 mA) | |
| 6 A | 50 mA | |
| 10 mA (at 12 V) | 1 mA | |
| 4 kV_{rms} (50 Hz, 1 min.) | | |
| -40°C ... 60°C | | |
| 100% operating factor | | |
| Approx. 2×10^7 cycles | | |
| DIN EN 50178, IEC 62103 | | |
| 2 / III | | |
| Any / In rows with zero spacing | | |
| 0.14 - 1.5 mm ² / 0.14 - 1.5 mm ² / 26 - 16 | | |
| 6.2 mm / 78 mm / 93 mm | | |

| Description | Input voltage U_N |
|--|---------------------|
| Coupling relay modules with power contact relay | ① 12 V DC |
| | ② 24 V DC |
| Coupling relay modules with power contact relay and gold contacts | ① 12 V DC |
| | ② 24 V DC |

| Ordering data | | |
|----------------------------|----------------|-------------|
| Type | Order No. | Pcs. / Pkt. |
| RIF-0-RPT-12DC/21 | 2903371 | 10 |
| RIF-0-RPT-24DC/21 | 2903370 | 10 |
| RIF-0-RPT-12DC/21AU | 2903369 | 10 |
| RIF-0-RPT-24DC/21AU | 2903368 | 10 |



RIF-0 relay module with 1 N/O relay

Z RIF-0-RPT.../21... (1 PDT)

Operating voltage range

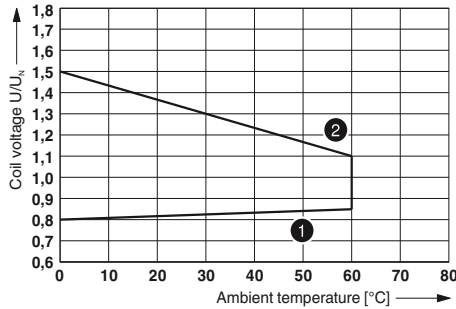

- ① Maximum continuous voltage at limiting continuous current = 6 A
- ② Minimum operate voltage
For pre-excitation with U_n and limiting continuous current = 6 A

Interrupting rating

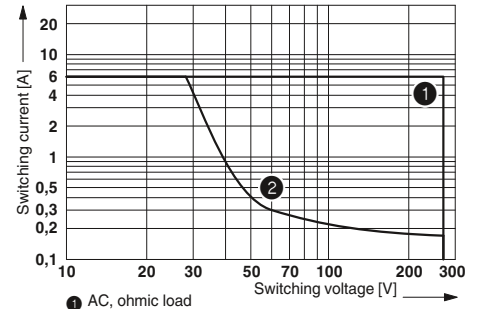

- ① AC, ohmic load
- ② DC, ohmic load

Service life reduction factor

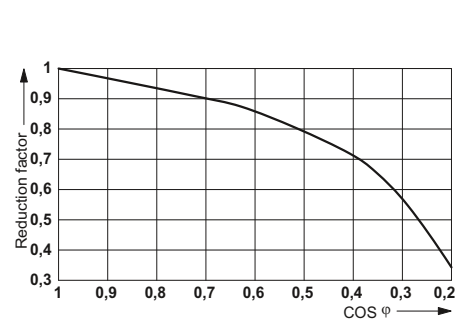

Electrical service life

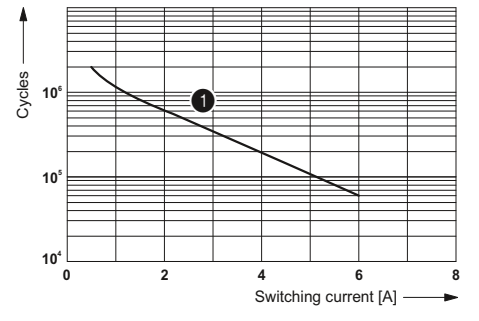

- ① 250 V AC, ohmic load

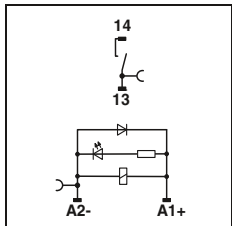

DC coils

Technical data

- ① refer to the diagram
- 16
- 5
- 8
- Yellow LED, Damping diode

| | |
|-------------------------------|-------------------------------|
| Single contact, 1 N/O contact | Single contact, 1 N/O contact |
| AgSnO | AgSnO, hard gold-plated |
| 250 V AC/DC | 30 V AC / 36 V DC |
| 5 V (at 100 mA) | 100 mV (at 10 mA) |
| 6 A | 50 mA |
| 10 mA (at 12 V) | 1 mA (at 12 V) |

- 4 kV_{rms} (50 Hz, 1 min.)
- 40°C ... 60°C
- 100% operating factor
- Approx. 2 x 10⁷ cycles
- DIN EN 50178, IEC 62103
- 2 / III
- Any / In rows with zero spacing
- 0.14 - 1.5 mm² / 0.14 - 1.5 mm² / 26 - 16
- 6.2 mm / 78 mm / 93 mm

Ordering data

| Type | Order No. | Pcs. / Pkt. |
|---------------------|-----------|-------------|
| RIF-0-RPT-12DC/ 1 | 2903362 | 10 |
| RIF-0-RPT-24DC/ 1 | 2903361 | 10 |
| RIF-0-RPT-12DC/ 1AU | 2903360 | 10 |
| RIF-0-RPT-24DC/ 1AU | 2903359 | 10 |

RIF-0-RPT.../1... (1 N/O contact)

Operating voltage range

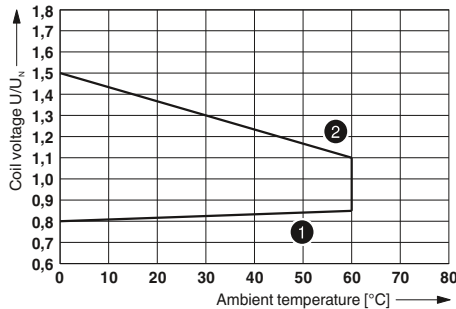

- ① Maximum continuous voltage at limiting continuous current = 6 A
- ② Minimum operate voltage
For pre-excitation with U_n and limiting continuous current = 6 A

Interrupting rating

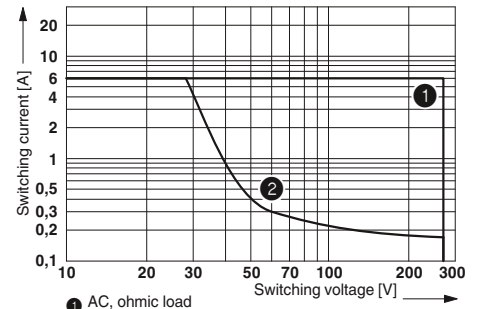

- ① AC, ohmic load
- ② DC, ohmic load

Service life reduction factor

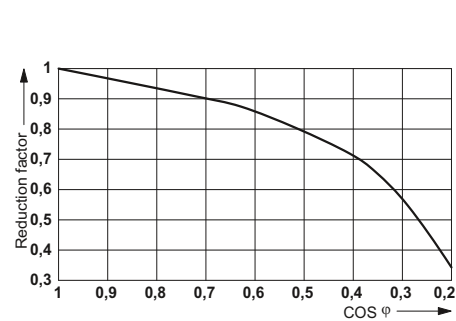

Electrical service life

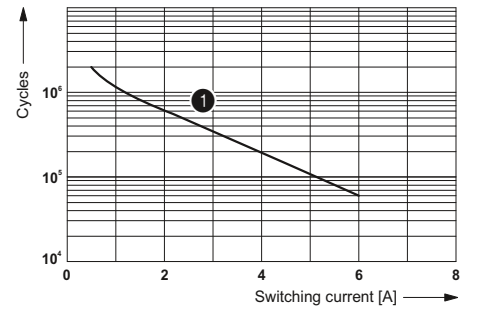

- ① 250 V AC, ohmic load

Fully mounted RIF-1 relay modules

Fully mounted RIF-1 relay modules, consisting of:

- 1 or 2 PDT relays
- Relay retaining bracket
- Input module/interference suppr. module

The advantages:

- Logical contact arrangement thanks to 1/3-level relay base
- Operational reliability thanks to sealed relay
- Safe isolation between coil and contact side
- Professional bridging of adjacent modules saves wiring time
- For FBS 2-6 plug-in bridges for the input side (A2), see page 318.
- For FBS 2-8 plug-in bridges for the output side (11/21), see page 318.



N

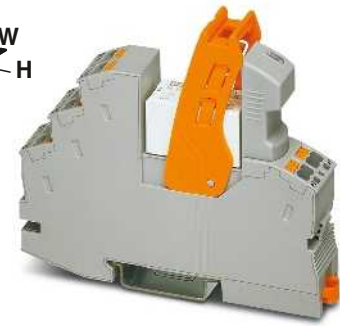

RIF-1 relay module with 1 PDT relay

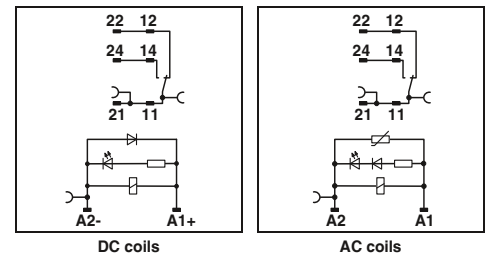

DC coils

AC coils

Technical data

| Input data | ① | ② | ③ | ④ |
|--|---|--------|------------------------|--------|
| Permissible range (with reference to U_N) | refer to the diagram | | | |
| Typ. input current at U_N [mA] | 18 | 33 | 8 | 6 |
| Typ. response time at U_N [ms] | 8 | 3 - 12 | 3 - 12 | 3 - 12 |
| Typ. release time at U_N [ms] | 10 | 3 - 20 | 3 - 20 | 3 - 20 |
| Input circuit AC | Yellow LED, Varistor | | | |
| Input circuit DC | Yellow LED, Damping diode, Polarity protection diode | | | |
| Output data | Single contact, 1-PDT | | Single contact, 1-PDT | |
| Contact type | | | | |
| Contact material | AgNi | | AgNi, hard gold-plated | |
| Max. switching voltage | 250 V AC/DC | | 30 V AC / 36 V DC | |
| Min. switching voltage | 12 V (at 10 mA) | | 100 mV (at 10 mA) | |
| Limiting continuous current | (refer to the diagram) | | 50 mA | |
| Max. inrush current, AC | 25 A (20 ms, N/O contact) | | 50 mA | |
| Max. inrush current, DC | 50 A (20 ms, N/O contact) | | 50 mA | |
| Min. switching current | 10 mA (at 12 V) | | 1 mA (at 24 V) | |
| General data | 4 kV_{rms} (50 Hz, 1 min.) | | | |
| Test voltage (winding / contact) | -40°C ... 70°C | | | |
| Ambient temperature (operation), AC | -40°C ... 50°C | | | |
| Ambient temperature (operation), DC | 100% operating factor | | | |
| Nominal operating mode | Approx. 10^7 cycles | | | |
| Mechanical service life, AC | Approx. 3×10^7 cycles | | | |
| Mechanical service life, DC | DIN EN 50178, IEC 62103 | | | |
| Standards/regulations | 2 / III | | | |
| Pollution degree/surge voltage category | Any / In rows with zero spacing | | | |
| Mounting position/mounting | 0.14 - 1.5 mm ² / 0.14 - 1.5 mm ² / 26 - 16 | | | |
| Connection data solid / stranded / AWG | 16 mm / 75 mm / 93 mm | | | |
| Dimensions | W / H / D | | | |

Ordering data

| Description | Input voltage U_N | Type | Order No. | Pcs. / Pkt. |
|--|---------------------|---------------------------|-----------|-------------|
| Coupling relay modules with power contact relay | ① 24 V DC | RIF-1-RPT-LDP-24DC/1X21 | 2903342 | 10 |
| | ② 24 V AC | RIF-1-RPT-LV-24AC/1X21 | 2903341 | 10 |
| | ③ 120 V AC | RIF-1-RPT-LV-120AC/1X21 | 2903340 | 10 |
| | ④ 230 V AC | RIF-1-RPT-LV-230AC/1X21 | 2903339 | 10 |
| Coupling relay modules with power contact relay and gold contacts | ① 24 V DC | RIF-1-RPT-LDP-24DC/1X21AU | 2903338 | 10 |
| | ② 24 V AC | RIF-1-RPT-LV-24AC/1X21AU | 2903337 | 10 |
| | ③ 120 V AC | RIF-1-RPT-LV-120AC/1X21AU | 2903336 | 10 |
| | ④ 230 V AC | RIF-1-RPT-LV-230AC/1X21AU | 2903335 | 10 |

N RIF-1-RPT.../1X21... (1 PDT)



RIF-1 relay module with 2 PDT relay

Operating voltage range

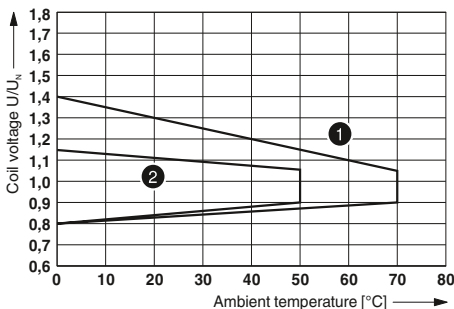

- 1 DC coils
- 2 AC coils

Interrupting rating

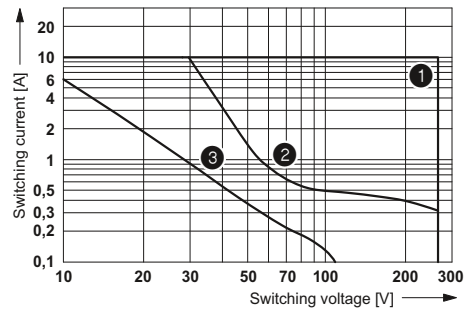

- 1 AC, ohmic load
- 2 DC, ohmic load
- 3 DC, L/R = 40 ms

Contact derating

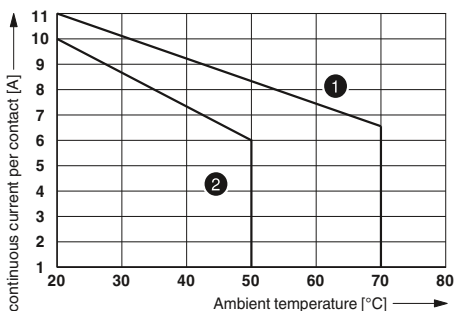

- 1 DC coil
- 2 AC coil

Electrical service life

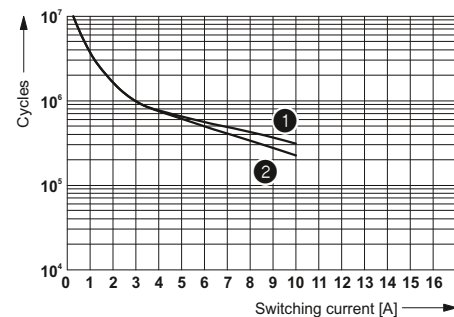

- 1 250 V AC, ohmic load (DC coils)
- 2 250 V AC, ohmic load (AC coils)



Technical data

| ① | ② | ③ | ④ |
|--|--------|--------|--------|
| refer to the diagram | | | |
| 18 | 33 | 8 | 6 |
| 8 | 3 - 12 | 3 - 12 | 3 - 12 |
| 10 | 3 - 20 | 3 - 20 | 3 - 20 |
| Yellow LED, Varistor | | | |
| Yellow LED, Damping diode, Polarity protection diode | | | |

Single contact, 2-PDT Single contact, 2-PDT

| AgNi | AgNi, hard gold-plated |
|----------------------------|------------------------|
| 250 V AC/DC | 30 V AC / 36 V DC |
| 5 V (at 10 mA) | 100 mV (at 10 mA) |
| 8 A (refer to the diagram) | 50 mA |
| 12 A (20 ms, N/O contact) | 50 mA |
| 25 A (20 ms, N/O contact) | 50 mA |
| 10 mA (at 5 V) | 1 mA (at 24 V) |

4 kV_{ms} (50 Hz, 1 min.)
 -40°C ... 70°C
 -40°C ... 50°C
 100% operating factor
 Approx. 10⁷ cycles
 Approx. 3 x 10⁷ cycles
 DIN EN 50178, IEC 62103
 2 / III
 Any / In rows with zero spacing
 0.14 - 1.5 mm² / 0.14 - 1.5 mm² / 26 - 16
 16 mm / 75 mm / 93 mm

Ordering data

| Type | Order No. | Pcs. / Pkt. |
|---------------------------|-----------|-------------|
| RIF-1-RPT-LDP-24DC/2X21 | 2903334 | 10 |
| RIF-1-RPT-LV-24AC/2X21 | 2903333 | 10 |
| RIF-1-RPT-LV-120AC/2X21 | 2903332 | 10 |
| RIF-1-RPT-LV-230AC/2X21 | 2903331 | 10 |
| RIF-1-RPT-LDP-24DC/2X21AU | 2903330 | 10 |
| RIF-1-RPT-LV-24AC/2X21AU | 2903329 | 10 |
| RIF-1-RPT-LV-120AC/2X21AU | 2903328 | 10 |
| RIF-1-RPT-LV-230AC/2X21AU | 2903327 | 10 |

RIF-1-RPT.../2X21... (2 PDTs)

Operating voltage range

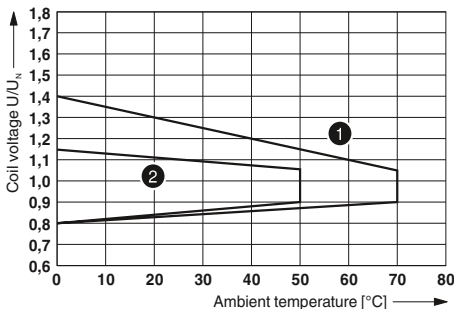

- 1 DC coils
- 2 AC coils

Interrupting rating

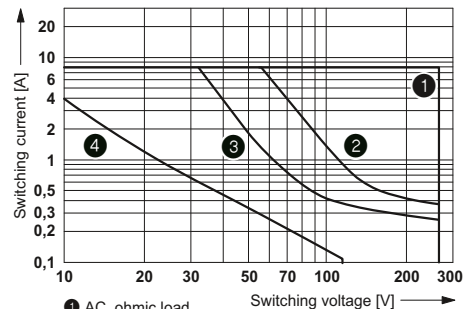

- 1 AC, ohmic load
- 2 DC, ohmic load, contacts in series
- 3 DC, ohmic load
- 4 DC, L/R = 40 ms

Contact derating

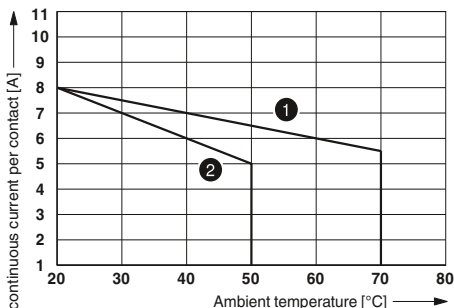

- 1 DC coil
- 2 AC coil

Electrical service life

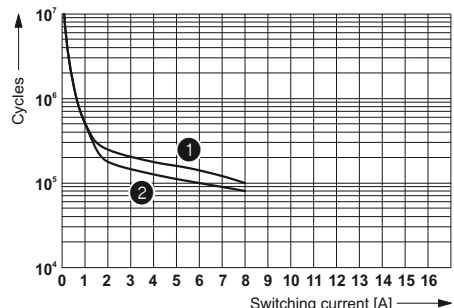

- 1 250 V AC, ohmic load (DC coils)
- 2 250 V AC, ohmic load (AC coils)

Fully mounted RIF-2 relay modules

Fully mounted RIF-2 relay modules, consisting of:

- 1 or 2 PDT relays
- Relay retaining bracket
- Input module/interference suppr. module (AC types only)

The advantages:

- Relay with lockable manual operation and status LED
- With DC types, freewheeling diode is integrated into relay
- Mechanical switch position indicator
- Logical contact arrangement thanks to 1/3-level relay base
- Professional bridging of adjacent modules saves wiring time
- For FBS 2-6 plug-in bridges for the input side (A2), see page 318.



N



RIF-2 relay module with 2 PDT relay

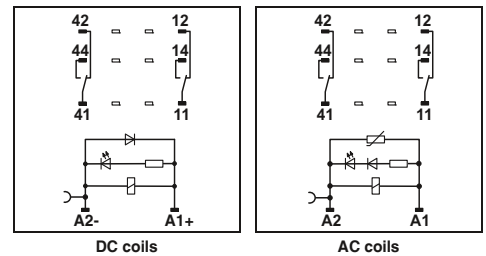

DC coils

AC coils

Technical data

| | ① | ② | ③ | ④ |
|--|---|----|--------|--------|
| Input data | refer to the diagram | | | |
| Permissible range (with reference to U_N) | 41 | 70 | 13 | 6.5 |
| Typ. input current at U_N | [mA] | | | |
| Typ. response time at U_N | [ms] | 13 | 5 - 15 | 5 - 15 |
| Typ. release time at U_N | [ms] | 14 | 5 - 20 | 5 - 20 |
| Input circuit AC | Yellow LED, Varistor | | | |
| Input circuit DC | Yellow LED, Damping diode | | | |
| Output data | Single contact, 2-PDT | | | |
| Contact type | AgNi | | | |
| Contact material | 250 V AC/DC | | | |
| Max. switching voltage | 5 V (At 24 mA) | | | |
| Min. switching voltage | (refer to the diagram) | | | |
| Limiting continuous current | 30 A (20 ms, N/O contact) | | | |
| Max. inrush current, AC | 30 A (20 ms, N/O contact) | | | |
| Max. inrush current, DC | 5 mA (at 24 V) | | | |
| Min. switching current | | | | |
| General data | 2.5 kV _{rms} (50 Hz, 1 min.) | | | |
| Test voltage (winding / contact) | -40°C ... 50°C | | | |
| Ambient temperature (operation), AC | -40°C ... 60°C | | | |
| Ambient temperature (operation), DC | 100% operating factor | | | |
| Nominal operating mode | Approx. 2×10^7 cycles | | | |
| Mechanical service life, AC | Approx. 2×10^7 cycles | | | |
| Mechanical service life, DC | DIN EN 50178, IEC 62103 | | | |
| Standards/regulations | 2 / III | | | |
| Pollution degree/surge voltage category | Any / In rows with zero spacing | | | |
| Mounting position/mounting | 0.14 - 1.5 mm ² / 0.14 - 1.5 mm ² / 26 - 16 | | | |
| Connection data solid / stranded / AWG | 31 mm / 75 mm / 93 mm | | | |
| Dimensions | W / H / D | | | |

Ordering data

| Description | Input voltage U_N | Type | Order No. | Pcs. / Pkt. |
|--|---------------------|-------------------------|-----------|-------------|
| Pre-assembled coupling relay modules with miniature power contact relay | ① 24 V DC | RIF-2-RPT-LDP-24DC/2X21 | 2903315 | 10 |
| | ② 24 V AC | RIF-2-RPT-LV-24AC/2X21 | 2903313 | 10 |
| | ③ 120 V AC | RIF-2-RPT-LV-120AC/2X21 | 2903311 | 10 |
| | ④ 230 V AC | RIF-2-RPT-LV-230AC/2X21 | 2903310 | 10 |



RIF-2 relay module with 4 PDT relay

N RIF-2-RPT.../2X21 (2 PDTs)

Operating voltage range

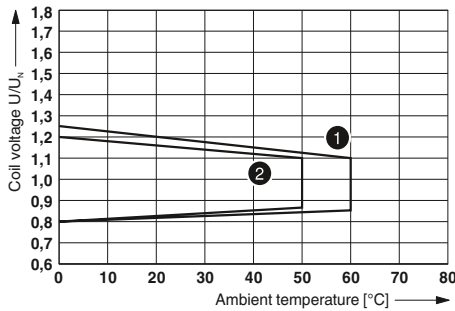

- ① DC coil (observe contact derating)
- ② AC coil (observe contact derating)

Interrupting rating

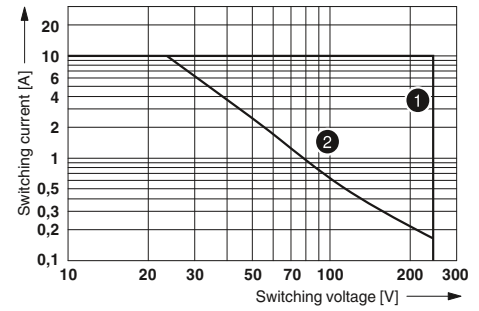

- ① AC, ohmic load
- ② DC, ohmic load

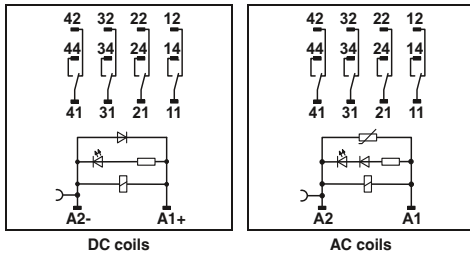

DC coils

AC coils

Contact derating

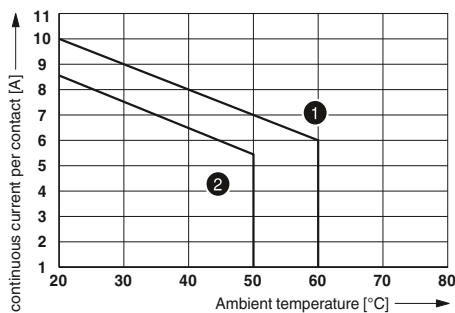

- ① DC coil
- ② AC coil

Electrical service life

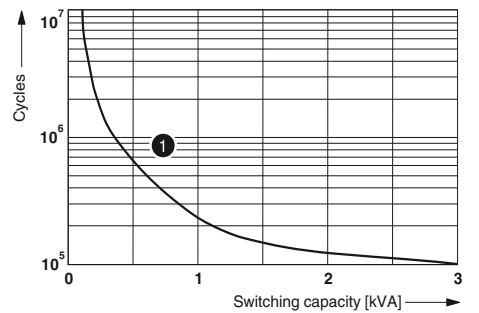

- ① 250 V AC, ohmic load

Technical data

| ① | ② | ③ | ④ |
|---------------------------|--------|--------|--------|
| refer to the diagram | | | |
| 41 | 70 | 13 | 6.5 |
| 13 | 5 - 15 | 5 - 15 | 5 - 15 |
| 14 | 5 - 20 | 5 - 20 | 5 - 20 |
| Yellow LED, Varistor | | | |
| Yellow LED, Damping diode | | | |

Single contact, 4-PDT
 AgNi
 250 V AC/DC
 5 V (At 24 mA)
 (refer to the diagram)
 16 A (20 ms, N/O contact)
 16 A (20 ms, N/O contact)
 5 mA (at 24 V)

2.5 kV_{rms} (50 Hz, 1 min.)
 -40°C ... 50°C
 -40°C ... 60°C
 100% operating factor
 Approx. 2 x 10⁷ cycles
 Approx. 2 x 10⁷ cycles
 DIN EN 50178, IEC 62103
 2 / II
 Any / In rows with zero spacing
 0.14 - 1.5 mm² / 0.14 - 1.5 mm² / 26 - 16
 31 mm / 75 mm / 93 mm

Ordering data

| Type | Order No. | Pcs. / Pkt. |
|-------------------------|-----------|-------------|
| RIF-2-RPT-LDP-24DC/4X21 | 2903308 | 10 |
| RIF-2-RPT-LV-24AC/4X21 | 2903306 | 10 |
| RIF-2-RPT-LV-120AC/4X21 | 2903305 | 10 |
| RIF-2-RPT-LV-230AC/4X21 | 2903304 | 10 |

RIF-2-RPT.../4X21 (4 PDTs)

Operating voltage range

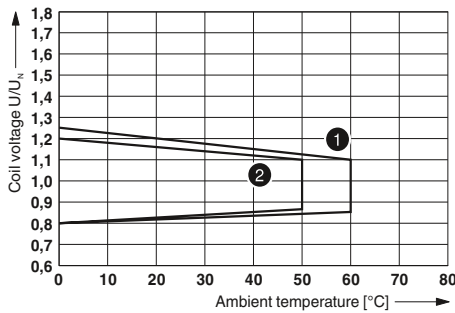

- ① DC coil (observe contact derating)
- ② AC coil (observe contact derating)

Interrupting rating

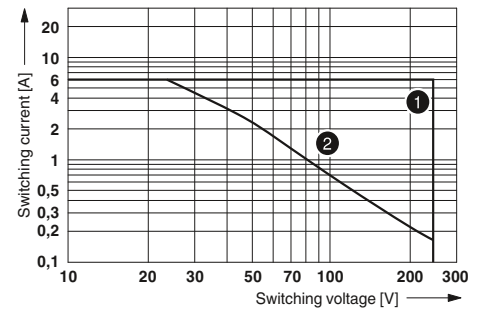

- ① AC, ohmic load
- ② DC, ohmic load

Contact derating

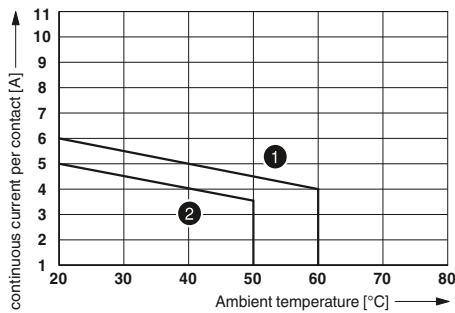

- ① DC coil
- ② AC coil

Electrical service life

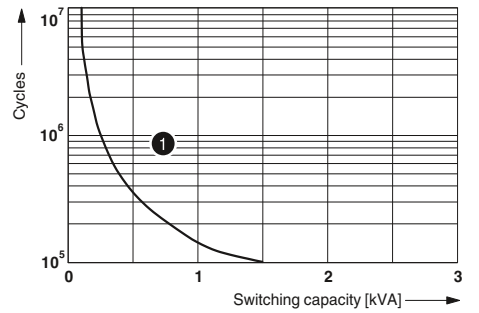

- ① 250 V AC, ohmic load

Fully mounted RIF-3 relay modules

Fully mounted RIF-3 relay modules, consisting of:

- Relay base
- 2 or 3 PDT relays
- Relay retaining bracket
- Input module/interference suppr. module (AC types only)

The advantages:

- Relay with lockable manual operation and status LED
- With DC types, freewheeling diode is integrated into relay
- Mechanical switch position indicator
- Logical contact arrangement thanks to 1/3-level relay base
- Professional bridging of adjacent modules saves wiring time
- For FBS 2-6 plug-in bridges for the input side (A2), see page 318.



RIF-3 relay module with 2 PDT relay



DC coils

AC coils

Technical data

| Input data | ① | ② | ③ |
|--|---|----|---------------|
| Permissible range (with reference to U_N) | refer to the diagram | | |
| Typ. input current at U_N | [mA] | 60 | 23 13 |
| Typ. response time at U_N | [ms] | 18 | 5 - 15 5 - 15 |
| Typ. release time at U_N | [ms] | 20 | 5 - 20 5 - 20 |
| Input circuit AC | Yellow LED, Varistor | | |
| Input circuit DC | Yellow LED, Damping diode | | |
| Output data | | | |
| Contact type | Single contact, 2-PDT | | |
| Contact material | AgNi | | |
| Max. switching voltage | 250 V AC/DC | | |
| Min. switching voltage | 10 V (At 24 mA) | | |
| Limiting continuous current | (refer to the diagram) | | |
| Max. inrush current, AC | 30 A (20 ms, N/O contact) | | |
| Max. inrush current, DC | 30 A (20 ms, N/O contact) | | |
| Min. switching current | 10 mA (at 24 V) | | |
| General data | | | |
| Test voltage (winding / contact) | 2.5 kV _{rms} (50 Hz, 1 min.) | | |
| Ambient temperature (operation), AC | -40°C ... 50°C | | |
| Ambient temperature (operation), DC | -40°C ... 60°C | | |
| Nominal operating mode | 100% operating factor | | |
| Mechanical service life, AC | Approx. 2×10^7 cycles | | |
| Mechanical service life, DC | Approx. 2×10^7 cycles | | |
| Standards/regulations | DIN EN 50178, IEC 62103 | | |
| Pollution degree/surge voltage category | 2 / III | | |
| Mounting position/mounting | Any / In rows with zero spacing | | |
| Connection data solid / stranded / AWG | 0.14 - 1.5 mm ² / 0.14 - 1.5 mm ² / 26 - 16 | | |
| Dimensions | W / H / D 40 mm / 90 mm / 100 mm | | |

Ordering data

| Description | Input voltage U_N | Type | Order No. | Pcs. / Pkt. |
|--|---------------------|-------------------------|-----------|-------------|
| Pre-assembled coupling relay modules with miniature power contact relay | ① 24 V DC | RIF-3-RPT-LDP-24DC/2X21 | 2903297 | 5 |
| | ② 120 V AC | RIF-3-RPT-LV-120AC/2X21 | 2903296 | 5 |
| | ③ 230 V AC | RIF-3-RPT-LV-230AC/2X21 | 2903295 | 5 |

N RIF-3-RPT.../2X21 (2 PDTs)



RIF-3 relay module with 3 PDT relay

Operating voltage range

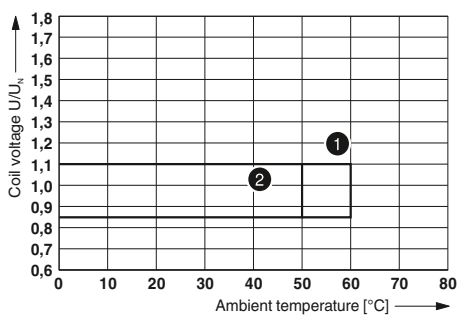

- ① DC coil (observe contact derating)
- ② AC coil (observe contact derating)

Interrupting rating

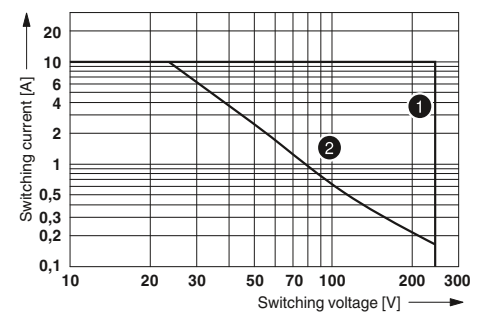

- ① AC, ohmic load
- ② DC, ohmic load

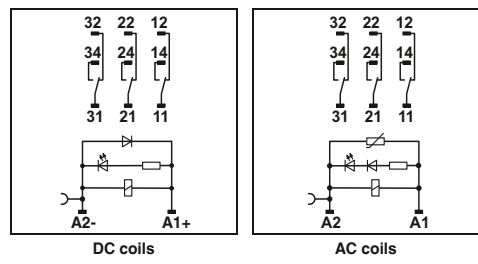

Contact derating

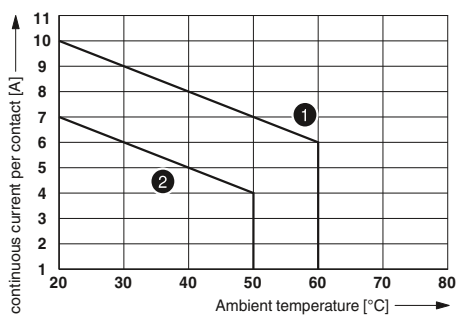

- ① DC coil
- ② AC coil

Electrical service life

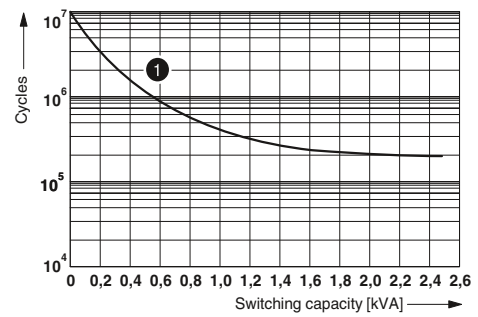

- ① 250 V AC, ohmic load

Technical data

- ① refer to the diagram
- ② 60
- ③ 23
- 18
- 20
- Yellow LED, Varistor
- Yellow LED, Damping diode

Single contact, three PDTs
 AgNi
 250 V AC/DC
 10 V (At 24 mA)
 (refer to the diagram)
 30 A (20 ms, N/O contact)
 30 A (20 ms, N/O contact)
 10 mA (at 24 V)

2.5 kV_{rms} (50 Hz, 1 min.)
 -40°C ... 50°C
 -40°C ... 60°C
 100% operating factor
 Approx. 2 x 10⁷ cycles
 Approx. 2 x 10⁷ cycles
 DIN EN 50178, IEC 62103
 2 / III
 Any / In rows with zero spacing
 0.14 - 1.5 mm² / 0.14 - 1.5 mm² / 26 - 16
 40 mm / 90 mm / 100 mm

Ordering data

| Type | Order No. | Pcs. / Pkt. |
|-------------------------|-----------|-------------|
| RIF-3-RPT-LDP-24DC/3X21 | 2903294 | 5 |
| RIF-3-RPT-LV-120AC/3X21 | 2903293 | 5 |
| RIF-3-RPT-LV-230AC/3X21 | 2903292 | 5 |

RIF-3-RPT.../3X21 (3 PDTs)

Operating voltage range

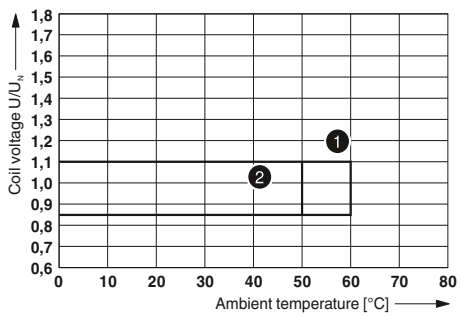

- ① DC coil (observe contact derating)
- ② AC coil (observe contact derating)

Interrupting rating

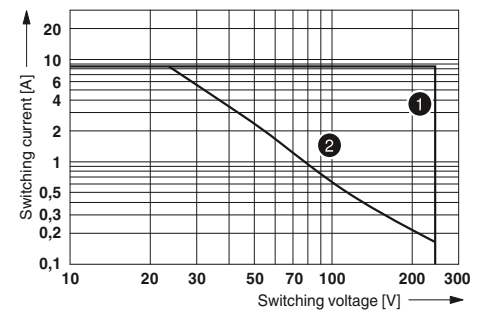

- ① AC, ohmic load
- ② DC, ohmic load

Contact derating

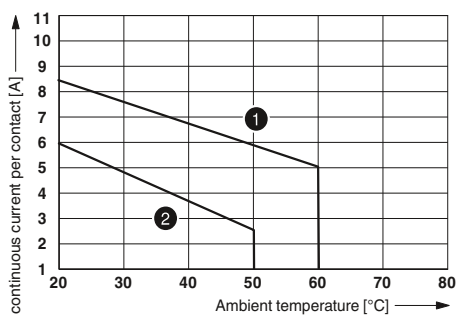

- ① DC coil
- ② AC coil

Electrical service life

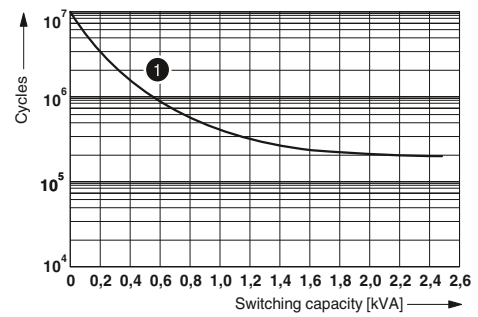

- ① 250 V AC, ohmic load

Relay modules

RIFLINE complete

Fully mounted RIF-4 relay modules

Fully mounted RIF-4 relay modules, consisting of:

- Relay base
- 2 or 3 PDT relays
- Relay retaining bracket
- Input module/interference suppr. module

The advantages:

- Logical contact arrangement thanks to 1/3-level relay base
- Professional bridging of adjacent modules saves wiring time
- For FBS 2-6 plug-in bridges for the input side (A2), see page 318.



RIF-4 relay module with 2 PDT relay



Technical data

| Input data | ① | ② | ③ |
|--|---|--|--------|
| Permissible range (with reference to U_N) | refer to the diagram | | |
| Typ. input current at U_N [mA] | 56 | 24 | 14 |
| Typ. response time at U_N [ms] | 20 | 5 - 25 | 5 - 25 |
| Typ. release time at U_N [ms] | 20 | 5 - 20 | 5 - 20 |
| Input circuit AC | Yellow LED, Varistor | | |
| Input circuit DC | Yellow LED, Damping diode, Polarity protection diode | | |
| Output data | | | |
| Contact type | Single contact, 2-PDT | | |
| Contact material | AgNi | | |
| Max. switching voltage | 440 V AC / 250 V DC | | |
| Min. switching voltage | 10 V (At 24 mA) | | |
| Limiting continuous current | (refer to the diagram) | | |
| Max. inrush current, AC | 50 A (20 ms, N/O contact) | | |
| Max. inrush current, DC | 50 A (20 ms, N/O contact) | | |
| Min. switching current | 10 mA (at 24 V) | | |
| Max. interrupting rating, ohmic load | 250 V AC | 2500 VA | |
| | 440 V AC | 4000 VA | |
| Motor load according to UL 508 | | 1/3 HP, 120 V AC (single-phase AC motor) | |
| | | 1/2 HP, 240 V AC (single-phase AC motor) | |
| General data | | | |
| Test voltage (winding / contact) | 2.5 kV _{rms} (50 Hz, 1 min.) | | |
| Ambient temperature (operation), AC | -40°C ... 40°C | | |
| Ambient temperature (operation), DC | -40°C ... 60°C | | |
| Nominal operating mode | 100% operating factor | | |
| Mechanical service life, AC | Approx. 10 ⁷ cycles | | |
| Mechanical service life, DC | Approx. 10 ⁷ cycles | | |
| Standards/regulations | DIN EN 50178, IEC 62103 | | |
| Pollution degree/surge voltage category | 2 / III | | |
| Mounting position/mounting | Any / In rows with zero spacing | | |
| Connection data solid / stranded / AWG | | | |
| Input side | 0.14 ... 1.5 mm ² / 0.14 ... 1.5 mm ² / 26 - 16 | | |
| Output side | 0.14 ... 2.5 mm ² / 0.14 ... 2.5 mm ² / 26 - 14 | | |
| Dimensions | W / H / D 43 mm / 90 mm / 107 mm | | |

Ordering data

| Description | Input voltage U_N | Type | Order No. | Pcs. / Pkt. |
|--|---------------------|-------------------------|-----------|-------------|
| Pre-assembled coupling relay modules with miniature power contact relay | ① 24 V DC | RIF-4-RPT-LDP-24DC/2X21 | 2903281 | 5 |
| | ② 120 V AC | RIF-4-RPT-LV-120AC/2X21 | 2903280 | 5 |
| | ③ 230 V AC | RIF-4-RPT-LV-230AC/2X21 | 2903279 | 5 |



RIF-4 relay module with 3 PDT relay

N RIF-4-RPT.../2X21 (2 PDTs)

Operating voltage range

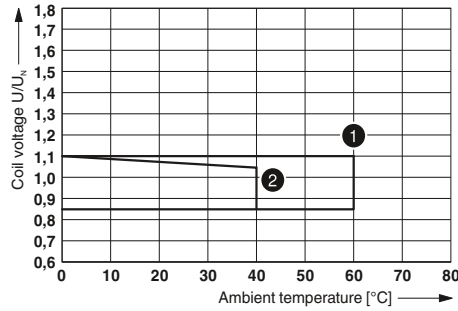

- ① DC coil (observe contact derating)
- ② AC coil (observe contact derating)

Interrupting rating

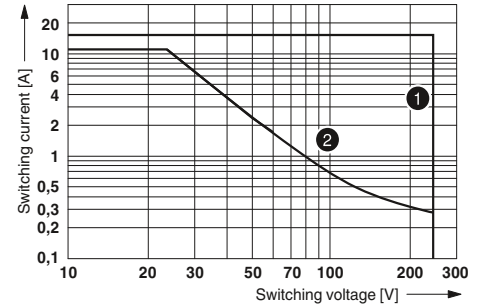

- ① AC, ohmic load
- ② DC, ohmic load

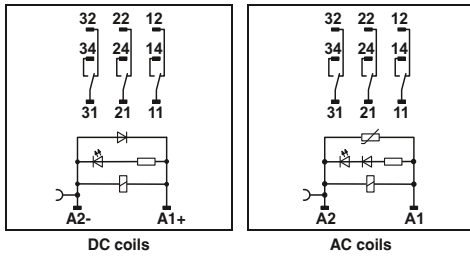

Contact derating

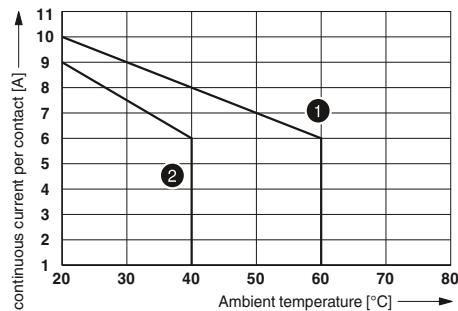

- ① DC coil
- ② AC coil

Electrical service life



- ① 250 V AC, ohmic load

Technical data

- ① refer to the diagram
- ② 56
- ③ 14
- 20 5 - 25 5 - 25
- 20 5 - 20 5 - 20
- Yellow LED, Varistor
- Yellow LED, Damping diode, Polarity protection diode

Single contact, three PDTs
 AgNi
 440 V AC / 250 V DC
 10 V (At 24 mA)
 (refer to the diagram)
 50 A (20 ms, N/O contact)
 50 A (20 ms, N/O contact)
 10 mA (at 24 V)

2500 VA
 4000 VA
 1/3 HP, 120 V AC (single-phase AC motor)
 1/2 HP, 240 V AC (single-phase AC motor)
 1/2 HP, 240 V AC (three-phase induction motor)

2.5 kV_{rms} (50 Hz, 1 min.)
 -40°C ... 40°C
 -40°C ... 60°C
 100% operating factor
 Approx. 10⁷ cycles
 Approx. 10⁷ cycles
 DIN EN 50178, IEC 62103
 2 / III
 Any / In rows with zero spacing

0.14 ... 1.5 mm² / 0.14 ... 1.5 mm² / 26 - 16
 0.14 ... 2.5 mm² / 0.14 ... 2.5 mm² / 26 - 14
 43 mm / 90 mm / 107 mm

Ordering data

| Type | Order No. | Pcs. / Pkt. |
|-------------------------|-----------|-------------|
| RIF-4-RPT-LDP-24DC/3X21 | 2903278 | 5 |
| RIF-4-RPT-LV-120AC/3X21 | 2903277 | 5 |
| RIF-4-RPT-LV-230AC/3X21 | 2903276 | 5 |

RIF-4-RPT.../3X21 (3 PDTs)

Operating voltage range

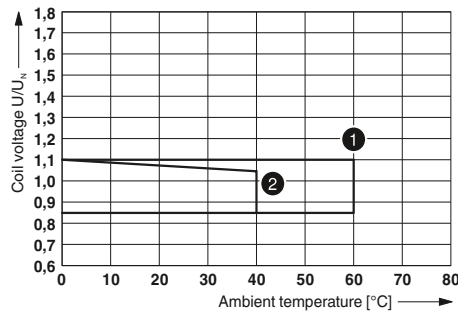

- ① DC coil (observe contact derating)
- ② AC coil (observe contact derating)

Interrupting rating



- ① AC, ohmic load
- ② DC, ohmic load

Contact derating

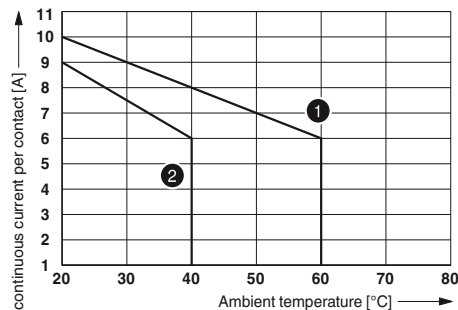

- ① DC coil
- ② AC coil

Electrical service life



- ① 250 V AC, ohmic load

Fully mounted RIF-4 relay modules

Fully mounted RIF-4 relay modules, consisting of:

- Relay base
- 3 N/O relays
- Relay retaining bracket
- Input module/interference suppr. module

The advantages:

- Logical contact arrangement thanks to 1/3-level relay base
- Full shutdown by means of ≥ 3 mm contact opening
- Professional bridging of adjacent modules saves wiring time
- For FBS 2-6 plug-in bridges for the input side (A2), see page 318.



RIF-4 relay module with 3 N/O relay



DC coils

AC coils

Technical data

| Input data | ① | ② | ③ |
|--|---|--|--------|
| Permissible range (with reference to U_N) | refer to the diagram | | |
| Typ. input current at U_N [mA] | 70 | 24 | 14 |
| Typ. response time at U_N [ms] | 20 | 5 - 25 | 5 - 25 |
| Typ. release time at U_N [ms] | 20 | 5 - 20 | 5 - 20 |
| Input circuit AC | Yellow LED, Varistor | | |
| Input circuit DC | Yellow LED, Damping diode, Polarity protection diode | | |
| Output data | | | |
| Contact type | Single contact, 3 N/O contacts | | |
| Contact material | AgNi | | |
| Max. switching voltage | 440 V AC / 250 V DC | | |
| Min. switching voltage | 10 V (At 24 mA) | | |
| Limiting continuous current | (refer to the diagram) | | |
| Max. inrush current, AC | 50 A (20 ms, N/O contact) | | |
| Max. inrush current, DC | 50 A (20 ms, N/O contact) | | |
| Min. switching current | 10 mA (at 24 V) | | |
| Max. interrupting rating, ohmic load | 250 V AC | 2500 VA | |
| | 440 V AC | 4000 VA | |
| Motor load according to UL 508 | | 1/3 HP, 120 V AC (single-phase AC motor) | |
| | | 1/2 HP, 240 V AC (single-phase AC motor) | |
| | | 1/2 HP, 240 V AC (three-phase induction motor) | |
| General data | | | |
| Test voltage (winding / contact) | 2.5 kV _{rms} (50 Hz, 1 min.) | | |
| Ambient temperature (operation), AC | -40°C ... 40°C | | |
| Ambient temperature (operation), DC | -40°C ... 60°C | | |
| Nominal operating mode | 100% operating factor | | |
| Mechanical service life, AC | Approx. 10 ⁷ cycles | | |
| Mechanical service life, DC | Approx. 10 ⁷ cycles | | |
| Standards/regulations | DIN EN 50178, IEC 62103 | | |
| Pollution degree/surge voltage category | 2 / III | | |
| Mounting position/mounting | Any / In rows with zero spacing | | |
| Connection data solid / stranded / AWG | | | |
| Input side | 0.14 ... 1.5 mm ² / 0.14 ... 1.5 mm ² / 26 - 16 | | |
| Output side | 0.14 ... 2.5 mm ² / 0.14 ... 2.5 mm ² / 26 - 14 | | |
| Dimensions | W / H / D 43 mm / 90 mm / 107 mm | | |

Ordering data

| Description | Input voltage U_N | Type | Order No. | Pcs. / Pkt. |
|--|---------------------|------------------------|-----------|-------------|
| Pre-assembled coupling relay modules with miniature power contact relay | ① 24 V DC | RIF-4-RPT-LDP-24DC/3X1 | 2903275 | 5 |
| | ② 120 V AC | RIF-4-RPT-LV-120AC/3X1 | 2903274 | 5 |
| | ③ 230 V AC | RIF-4-RPT-LV-230AC/3X1 | 2903273 | 5 |

Z

RIF-4-RPT.../3X1 (3 N/O contacts)

Operating voltage range

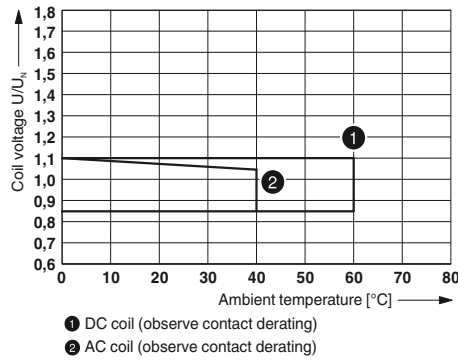

Interrupting rating

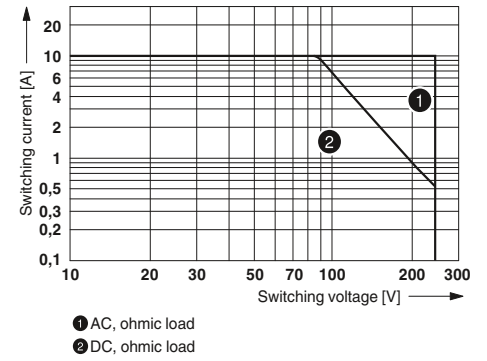

Contact derating

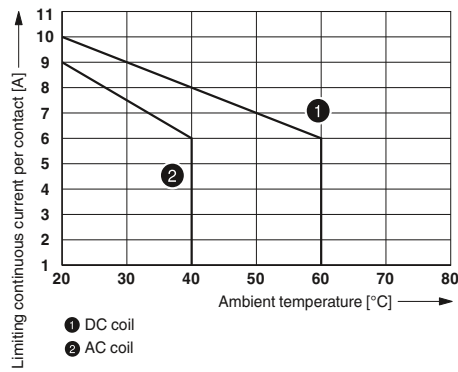

Electrical service life

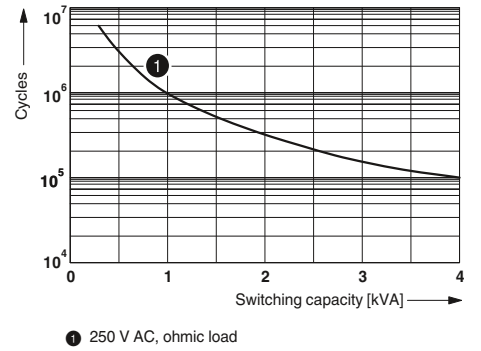

Relay modules

RIFLINE complete

RIFLINE complete accessories Plug-in bridges

The plug-in bridges can be used for simple potential distribution via all relay bases.

The end clamp is used for safe isolation between adjacent modules and to visually separate the various function groups.



| Description | Color | Ordering data | | | Ordering data | | |
|---|-------|---------------|-----------|-------------|---------------|-----------|-------------|
| | | Type | Order No. | Pcs. / Pkt. | Type | Order No. | Pcs. / Pkt. |
| Plug-in bridge | | | | | | | |
| 2-pos. red | | FBS 2-6 | 3030336 | 50 | | | |
| 2-pos. blue | | FBS 2-6 BU | 3036932 | 50 | | | |
| 2-pos. gray | | FBS 2-6 GY | 3032237 | 50 | | | |
| 5-pos. red | | FBS 5-6 | 3030349 | 50 | | | |
| 10-pos. red | | FBS 10-6 | 3030271 | 10 | | | |
| 20-pos. red | | FBS 20-6 | 3030365 | 10 | | | |
| 50-pos. red | | FBS 50-6 | 3032224 | 10 | | | |
| 2-pos. red | | FBS 2-8 | 3030284 | 10 | | | |
| 2-pos. blue | | FBS 2-8 BU | 3032567 | 10 | | | |
| 2-pos. gray | | FBS 2-8 GY | 3032541 | 10 | | | |
| End clamp , to snap on NS 35, 9.5 mm wide, can be labeled with ZB 6, ZB 8/27, KLM... | | | | | | | |
| | | | | | CLIPFIX 35 | 3022218 | 50 |

RIFLINE complete accessories Marking material

The ZB zack marker strip system offers numerous marking options that can be attached directly to the relay retaining brackets. In addition, further markings can be fixed to the relay base by means of double marker carriers.



5.2 mm, 6.2 mm, and 15.2 mm wide



Double marker carrier

| Description | Color | Ordering data | | | Ordering data | | |
|---------------------------------------|-------|------------------|-----------|-------------|---------------|-----------|-------------|
| | | Type | Order No. | Pcs. / Pkt. | Type | Order No. | Pcs. / Pkt. |
| Zack marker strip, unprinted | | | | | | | |
| 10-section | white | ZB 5 :UNBEDRUCKT | 1050004 | 10 | | | |
| 10-section | white | ZB 6:UNBEDRUCKT | 1051003 | 10 | | | |
| 5-section | white | ZB 15:UNBEDRUCKT | 0811972 | 10 | | | |
| Double marker carrier for ZB 5 | gray | | | | | | |
| | | | | | STP 5-2 | 0800967 | 100 |

RIFLINE complete accessories

Test plugs

The two-piece test plug offers individual plug color combinations. The test plug is inserted directly in the function shaft of the push-in connection.



| | | Ordering data | | |
|--|--------|------------------|----------------|-------------|
| Description | Color | Type | Order No. | Pcs. / Pkt. |
| Test plug, consisting of: | | | | |
| Metal part for 2.3 mm Ø socket hole and | | MPS-MT | 0201744 | 10 |
| Insulating sleeve , for MPS metal part | red | MPS-IH RD | 0201676 | 10 |
| | white | MPS-IH WH | 0201663 | 10 |
| | blue | MPS-IH BU | 0201689 | 10 |
| | yellow | MPS-IH YE | 0201692 | 10 |
| | green | MPS-IH GN | 0201702 | 10 |
| | gray | MPS-IH GY | 0201728 | 10 |
| | black | MPS-IH BK | 0201731 | 10 |



The PLC-INTERFACE relay system is the interface between the controller and system I/O devices.

The universal design is compact and space-saving. While the narrow 6.2 mm module has one contact, the 14 mm version is available with two contacts. The modules can be equipped with either an electromechanical or a solid-state relay.

They are protected against environmental influences by RTIII (IP67). The relays also offer safe isolation according to DIN EN 50178 (VDE 0160).

PLC-INTERFACE is available with three connection technologies. Depending on the area of application, screw, spring-cage or push-in connection can be selected.

In addition to the universal types, PLC-INTERFACE is also available in numerous special versions. These include:

- Sensor and actuator modules that can accommodate all connections directly on the interface
- Modules for high inrush or continuous currents
- Railway modules, which meet specific railway requirements
- Filter modules, which filter out interference on the input side

Plug-in bridges are available for all modules for simple potential distribution. In addition, solutions from system cabling applications offer easy connection to the plant control system. VARIOFACE adapters can be used to reduce wiring effort considerably. Installation is simplified significantly thanks to the integrated input and protective circuit.

Standard marking material from CLIPLINE complete modular terminal blocks can be used to mark PLC-INTERFACE.



Adapters for the system cabling

The PLC-V8... adapter is used to connect 8 PLC-INTERFACE modules to the PLC system cabling for input and output functions. For more details, see page 369



6.2 mm design width

PLC-R...21 and PLC-O... relay and solid-state relay modules with PDT or N/O contact, designed for universal use. Available with screw, spring-cage or push-in connection.



14 mm design width

PLC-R...21-21 includes plug-in relays with two PDT contacts for switching capacities of up to 250 V AC/6 A. Available with screw, spring-cage, and push-in connection.



Feed-through terminal block

PLC-VT... is the feed-through terminal block for PLC-INTERFACE and the system cabling for passive signal transfer. For more details, see page 486



Sensors/actuators

PLC...SEN and PLC...ACT do not require additional supply/output terminal blocks. All connections are connected directly.



High currents

PLC...IC is ideal for high inrush currents, e.g., from lamp loads. PLC...HC are the modules to use for applications with high continuous load currents.



Railway applications

PLC...RW relay or solid-state relay modules are suitable for railway requirements. They are only available with spring-cage and push-in connection.



Interference signals on the input side

PLC-B...SO46 basic terminal blocks are used for filtering interference currents and interference voltages on the input side.



Accessories

The entire PLC-INTERFACE system can be extended with a wide range of accessories, such as power terminal blocks or plug-in bridges. For more details, see page 368

Relay modules

PLC series

Universal PLC series with PDT relay

PLC-R... is the relay series that can be used universally and consists of basic terminal blocks and plug-in relays with PDT contacts.

- The advantages:
- Slim design
 - Screw, spring-cage, and push-in technology
 - Functional plug-in bridges
 - Integrated input and interference suppression circuit
 - RT III sealed relay
 - Safe isolation according to DIN EN 50178 between coil and contact
 - Efficient connection to system cabling using V8 adapter

| Notes: |
|---|
| Type of housing: Polyamide PA non-reinforced, color: green. |
| Marking systems and mounting material See Catalog 5 |
| Separating plate PLC-ATP must be installed for voltages larger than 250 V (L1, L2, L3) between identical terminal blocks in adjacent modules. Potential bridging is then carried out with FBST 8-PLC... or FBST 500.... |
| If the specified maximum values for multi-layer contact relays are exceeded, the gold plating is destroyed. The maximum values of the power contact relay are then valid. This can result in a shorter service life than with a pure power contact. |
| For diagrams of operating voltage ranges, see page 343 |
| Note: for marking material (ZB 6), see "CLIPLINE industrial connection technology, marking material for terminals, conductors, and cables". |
| 1) 120 and 230 V types up to 55°C |
| 2) 230 V types up to 55°C |
| 3) EMC: Class A product, see page 571 |



1 PDT with power contact

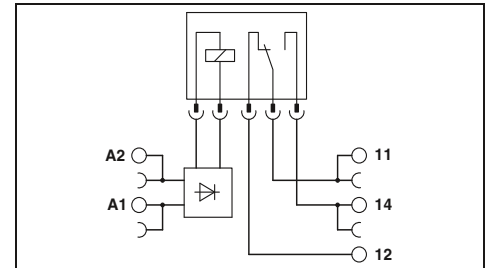

Electrical interrupting rating for PLC...21 with 1-PDT relay

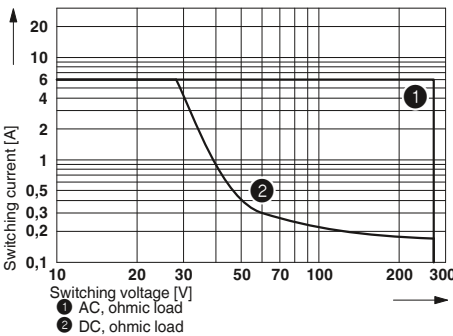

Electrical interrupting rating for PLC...21-21 with 2-PDT relay

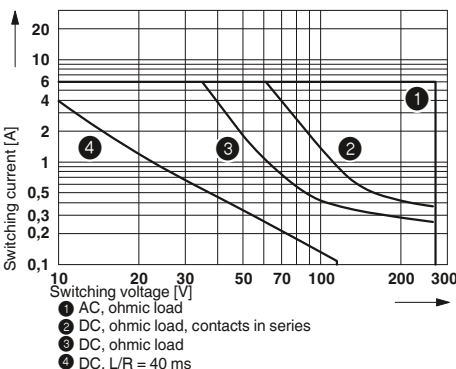

| Input data | | |
|--|-----------|--|
| Typ. input current at U_N | [mA] | |
| Response/release time at U_N | [ms] | |
| Input circuit DC | | |
| Input circuit AC/DC | | |
| Output data | | |
| Contact material | | |
| Max. switching voltage | | |
| Min. switching voltage | | |
| Limiting continuous current | | |
| Max. inrush current | | |
| Min. switching current | | |
| General data | | |
| Test voltage input/output | | |
| Ambient temperature (operation) | | |
| Mechanical service life | | |
| Standards/regulations | | |
| Connection data solid / stranded / AWG | | |
| Dimensions | W / H / D | |

| Technical data | | | | | | |
|--|-----|------|-----|-----|------|------|
| ① | ② | ③ | ④ | ⑤ | ⑥ | ⑦ |
| 15.3 | 9 | 11 | 9.2 | 4.8 | 3.5 | 3.2 |
| 5/8 | 5/8 | 6/15 | 5/8 | 5/8 | 6/15 | 7/15 |
| Yellow LED, Protection against polarity reversal, freewheeling diode | | | | | | |
| Yellow LED, Bridge rectifier | | | | | | |

| |
|---|
| AgSnO |
| 250 V AC/DC |
| 5 V (at 100 mA) |
| 6 A |
| (on request) |
| 10 mA (at 12 V) |
| 4 kV AC (50 Hz, 1 min.) |
| -40°C ... 60°C ¹⁾ |
| 2 x 10 ⁷ cycles |
| IEC 60664, EN 50178, IEC 62103 |
| 0.14 - 2.5 mm ² / 0.14 - 2.5 mm ² / 26 - 14 |
| 6.2 mm / 80 mm / 94 mm |

Ordering data

| Description | Input voltage U_N | Type | Order No. | Pcs. / Pkt. |
|---|---------------------|--------------------------------|-----------|-------------|
| PLC INTERFACE, with screw connection | | | | |
| ① | 12 V DC | PLC-RSC- 12DC/21 ³⁾ | 2966906 | 10 |
| ② | 24 V DC | PLC-RSC- 24DC/21 ³⁾ | 2966171 | 10 |
| ③ | 24 V AC/DC | PLC-RSC- 24UC/21 ³⁾ | 2966184 | 10 |
| ④ | 48 V DC | PLC-RSC- 48DC/21 ³⁾ | 2966113 | 10 |
| ⑤ | 60 V DC | PLC-RSC- 60DC/21 ³⁾ | 2966139 | 10 |
| ⑥ | 120 V AC (110 V DC) | PLC-RSC-120UC/21 ³⁾ | 2966197 | 10 |
| ⑦ | 230 V AC (220 V DC) | PLC-RSC-230UC/21 ³⁾ | 2966207 | 10 |
| PLC INTERFACE, with spring-cage connection | | | | |
| ① | 12 V DC | PLC-RSP- 12DC/21 ³⁾ | 2967439 | 10 |
| ② | 24 V DC | PLC-RSP- 24DC/21 ³⁾ | 2966472 | 10 |
| ③ | 24 V AC/DC | PLC-RSP- 24UC/21 ³⁾ | 2966485 | 10 |
| ④ | 48 V DC | PLC-RSP- 48DC/21 ³⁾ | 2966498 | 10 |
| ⑤ | 60 V DC | PLC-RSP- 60DC/21 ³⁾ | 2966511 | 10 |
| ⑥ | 120 V AC (110 V DC) | PLC-RSP-120UC/21 ³⁾ | 2966524 | 10 |
| ⑦ | 230 V AC (220 V DC) | PLC-RSP-230UC/21 ³⁾ | 2966537 | 10 |
| PLC-INTERFACE, with push-in connection | | | | |
| ① | 12 V DC | PLC-RPT- 12DC/21 ³⁾ | 2900316 | 10 |
| ② | 24 V DC | PLC-RPT- 24DC/21 ³⁾ | 2900299 | 10 |
| ③ | 24 V AC/DC | PLC-RPT- 24UC/21 ³⁾ | 2900300 | 10 |
| ④ | 48 V DC | PLC-RPT- 48DC/21 ³⁾ | 2900301 | 10 |
| ⑤ | 60 V DC | PLC-RPT- 60DC/21 ³⁾ | 2900303 | 10 |
| ⑥ | 120 V AC (110 V DC) | PLC-RPT-120UC/21 ³⁾ | 2900304 | 10 |
| ⑦ | 230 V AC (220 V DC) | PLC-RPT-230UC/21 ³⁾ | 2900305 | 10 |

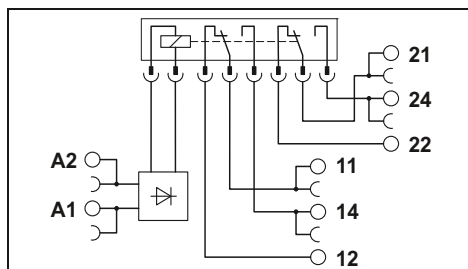
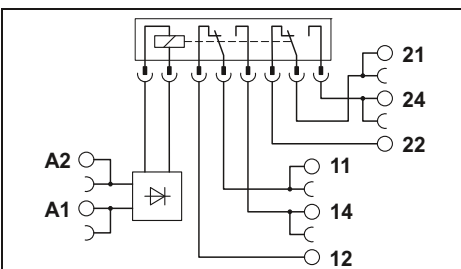
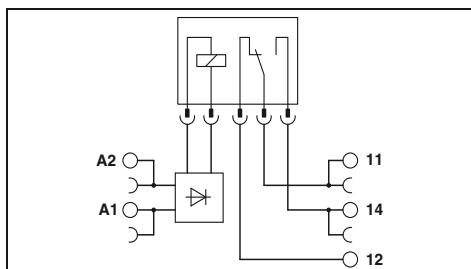
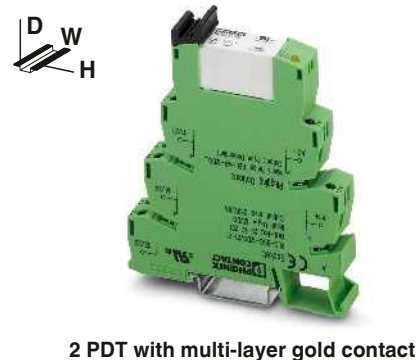
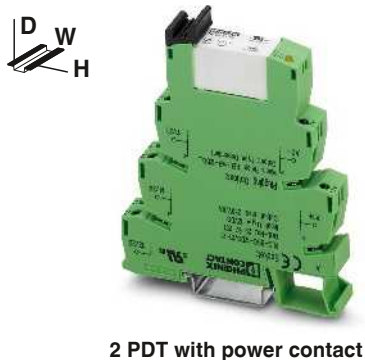
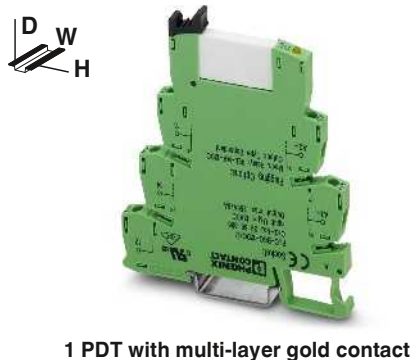

| Technical data | | | | | | |
|--|-----|------|-----|-----|------|------|
| ① | ② | ③ | ④ | ⑤ | ⑥ | ⑦ |
| 15.3 | 9 | 11 | 9.2 | 4.8 | 3.5 | 3.2 |
| 5/8 | 5/8 | 6/15 | 5/8 | 5/8 | 6/15 | 7/15 |
| Yellow LED, Protection against polarity reversal, freewheeling diode | | | | | | |
| Yellow LED, Bridge rectifier | | | | | | |
| AgSnO, hard gold-plated | | | | | | |
| 30 V AC / 36 V DC | | | | | | |
| 100 mV (at 10 mA) | | | | | | |
| 50 mA | | | | | | |
| 50 mA | | | | | | |
| 1 mA (at 24 V) | | | | | | |
| 4 kV AC (50 Hz, 1 min.) | | | | | | |
| -40°C ... 60°C ¹⁾ | | | | | | |
| 2 x 10 ⁷ cycles | | | | | | |
| IEC 60664, EN 50178, IEC 62103 | | | | | | |
| 0.14 - 2.5 mm ² / 0.14 - 2.5 mm ² / 26 - 14 | | | | | | |
| 6.2 mm / 80 mm / 94 mm | | | | | | |

| Technical data | | | | | | |
|--|------|------|------|------|------|------|
| ① | ② | ③ | ④ | ⑤ | ⑥ | ⑦ |
| 33 | 18 | 17.5 | 20 | 10 | 4.5 | 4.5 |
| 8/10 | 8/10 | 8/10 | 8/10 | 8/10 | 7/10 | 7/10 |
| Yellow LED, Protection against polarity reversal, freewheeling diode | | | | | | |
| Yellow LED, Bridge rectifier | | | | | | |
| AgNi | | | | | | |
| 250 V AC/DC | | | | | | |
| 5 V AC/DC (at 10 mA) | | | | | | |
| 6 A | | | | | | |
| 15 A (300 ms) | | | | | | |
| 10 mA (At 5 V) | | | | | | |
| 4 kV AC (50 Hz, 1 min.) | | | | | | |
| -40°C ... 60°C ²⁾ | | | | | | |
| 3 x 10 ⁷ cycles | | | | | | |
| IEC 60664, EN 50178, IEC 62103 | | | | | | |
| 0.14 - 2.5 mm ² / 0.14 - 2.5 mm ² / 26 - 14 | | | | | | |
| 14 mm / 80 mm / 94 mm | | | | | | |

| Technical data | | | | | | |
|--|------|------|------|------|------|------|
| ① | ② | ③ | ④ | ⑤ | ⑥ | ⑦ |
| 33 | 18 | 17.5 | 20 | 10 | 4.5 | 4.5 |
| 8/10 | 8/10 | 8/10 | 8/10 | 8/10 | 7/10 | 7/10 |
| Yellow LED, Protection against polarity reversal, freewheeling diode | | | | | | |
| Yellow LED, Bridge rectifier | | | | | | |
| AgNi, hard gold-plated | | | | | | |
| 30 V AC / 36 V DC | | | | | | |
| 100 mV (at 10 mA) | | | | | | |
| 50 mA | | | | | | |
| 50 mA | | | | | | |
| 1 mA (at 24 V) | | | | | | |
| 4 kV AC (50 Hz, 1 min.) | | | | | | |
| -40°C ... 60°C ²⁾ | | | | | | |
| 3 x 10 ⁷ cycles | | | | | | |
| IEC 60664, EN 50178, IEC 62103 | | | | | | |
| 0.14 - 2.5 mm ² / 0.14 - 2.5 mm ² / 26 - 14 | | | | | | |
| 14 mm / 80 mm / 94 mm | | | | | | |

| Ordering data | | |
|----------------------------------|-----------|-------------|
| Type | Order No. | Pcs. / Pkt. |
| PLC-RSC- 12DC/21AU ³⁾ | 2966919 | 10 |
| PLC-RSC- 24DC/21AU ³⁾ | 2966265 | 10 |
| PLC-RSC- 24UC/21AU ³⁾ | 2966278 | 10 |
| PLC-RSC- 48DC/21AU ³⁾ | 2966126 | 10 |
| PLC-RSC- 60DC/21AU ³⁾ | 2966142 | 10 |
| PLC-RSC-120UC/21AU ³⁾ | 2966281 | 10 |
| PLC-RSC-230UC/21AU ³⁾ | 2966294 | 10 |
| PLC-RSP- 12DC/21AU ³⁾ | 2967442 | 10 |
| PLC-RSP- 24DC/21AU ³⁾ | 2966540 | 10 |
| PLC-RSP- 24UC/21AU ³⁾ | 2966553 | 10 |
| PLC-RSP- 48DC/21AU ³⁾ | 2966566 | 10 |
| PLC-RSP- 60DC/21AU ³⁾ | 2966579 | 10 |
| PLC-RSP-120UC/21AU ³⁾ | 2966582 | 10 |
| PLC-RSP-230UC/21AU ³⁾ | 2966647 | 10 |
| PLC-RPT- 12DC/21AU ³⁾ | 2900317 | 10 |
| PLC-RPT- 24DC/21AU ³⁾ | 2900306 | 10 |
| PLC-RPT- 24UC/21AU ³⁾ | 2900307 | 10 |
| PLC-RPT- 48DC/21AU ³⁾ | 2900308 | 10 |
| PLC-RPT- 60DC/21AU ³⁾ | 2900309 | 10 |
| PLC-RPT-120UC/21AU ³⁾ | 2900310 | 10 |
| PLC-RPT-230UC/21AU ³⁾ | 2900311 | 10 |

| Ordering data | | |
|-----------------------------------|-----------|-------------|
| Type | Order No. | Pcs. / Pkt. |
| PLC-RSC- 12DC/21-21 ³⁾ | 2967235 | 10 |
| PLC-RSC- 24DC/21-21 ³⁾ | 2967060 | 10 |
| PLC-RSC- 24UC/21-21 ³⁾ | 2967073 | 10 |
| PLC-RSC- 48DC/21-21 ³⁾ | 2967248 | 10 |
| PLC-RSC- 60DC/21-21 ³⁾ | 2967293 | 10 |
| PLC-RSC-120UC/21-21 ³⁾ | 2967086 | 10 |
| PLC-RSC-230UC/21-21 ³⁾ | 2967099 | 10 |
| PLC-RSP- 12DC/21-21 ³⁾ | 2912497 | 10 |
| PLC-RSP- 24DC/21-21 ³⁾ | 2912507 | 10 |
| PLC-RSP- 24UC/21-21 ³⁾ | 2912510 | 10 |
| PLC-RSP- 48DC/21-21 ³⁾ | 2912523 | 10 |
| PLC-RSP- 60DC/21-21 ³⁾ | 2912536 | 10 |
| PLC-RSP-120UC/21-21 ³⁾ | 2912549 | 10 |
| PLC-RSP-230UC/21-21 ³⁾ | 2912552 | 10 |
| PLC-RPT- 12DC/21-21 ³⁾ | 2900329 | 10 |
| PLC-RPT- 24DC/21-21 ³⁾ | 2900330 | 10 |
| PLC-RPT- 24UC/21-21 ³⁾ | 2900332 | 10 |
| PLC-RPT- 48DC/21-21 ³⁾ | 2900333 | 10 |
| PLC-RPT- 60DC/21-21 ³⁾ | 2900334 | 10 |
| PLC-RPT-120UC/21-21 ³⁾ | 2900335 | 10 |
| PLC-RPT-230UC/21-21 ³⁾ | 2900336 | 10 |

| Ordering data | | |
|-------------------------------------|-----------|-------------|
| Type | Order No. | Pcs. / Pkt. |
| PLC-RSC- 12DC/21-21AU ³⁾ | 2967277 | 10 |
| PLC-RSC- 24DC/21-21AU ³⁾ | 2967125 | 10 |
| PLC-RSC- 24UC/21-21AU ³⁾ | 2967112 | 10 |
| PLC-RSC- 48DC/21-21AU ³⁾ | 2967280 | 10 |
| PLC-RSC- 60DC/21-21AU ³⁾ | 2967303 | 10 |
| PLC-RSC-120UC/21-21AU ³⁾ | 2967138 | 10 |
| PLC-RSC-230UC/21-21AU ³⁾ | 2967141 | 10 |
| PLC-RSP- 12DC/21-21AU ³⁾ | 2912565 | 10 |
| PLC-RSP- 24DC/21-21AU ³⁾ | 2912578 | 10 |
| PLC-RSP- 24UC/21-21AU ³⁾ | 2912581 | 10 |
| PLC-RSP- 48DC/21-21AU ³⁾ | 2912594 | 10 |
| PLC-RSP- 60DC/21-21AU ³⁾ | 2912604 | 10 |
| PLC-RSP-120UC/21-21AU ³⁾ | 2912617 | 10 |
| PLC-RSP-230UC/21-21AU ³⁾ | 2912620 | 10 |
| PLC-RPT- 12DC/21-21AU ³⁾ | 2900337 | 10 |
| PLC-RPT- 24DC/21-21AU ³⁾ | 2900338 | 10 |
| PLC-RPT- 24UC/21-21AU ³⁾ | 2900339 | 10 |
| PLC-RPT- 48DC/21-21AU ³⁾ | 2900340 | 10 |
| PLC-RPT- 60DC/21-21AU ³⁾ | 2900341 | 10 |
| PLC-RPT-120UC/21-21AU ³⁾ | 2900342 | 10 |
| PLC-RPT-230UC/21-21AU ³⁾ | 2900343 | 10 |

Relay modules

PLC series

Universal PLC series with solid-state relays

PLC-O... is the solid-state relay series that can be used universally consisting of basic terminal blocks and plug-in solid-state relays.

The advantages:

- Slim design
- Screw, spring-cage, and push-in technology
- Functional plug-in bridges
- Integrated input circuit
- RT-III sealed solid-state relays
- High switching capacity
- Zero voltage switch at AC output
- Efficient connection to system cabling using V8 adapter

| Notes: |
|---|
| Type of housing: Polyamide PA non-reinforced, color: green. |
| Marking systems and mounting material See Catalog 5 |
| Separating plate PLC-ATP must be installed for voltages larger than 250 V (L1, L2, L3) between identical terminal blocks in adjacent modules. Potential bridging is then carried out with FBST 8-PLC... or FBST 500.... |
| For derating curves see page 345 |
| 1) EMC: Class A product, see page 571 |



Max. DC voltage output of 100 mA



| Input data | |
|--|---|
| Permissible range (with reference to U_N) | |
| Switching level (with reference to U_N) | 1 signal ("H") 0 signal ("L") |
| Typ. input current at U_N | [mA] |
| Typ. switch-on time at U_N | [ms] |
| Typ. switch-off time at U_N | [ms] |
| Transmission frequency f_{limit} | [Hz] |
| Input circuit DC | |
| Input circuit AC/DC | |
| Output data | |
| Max. switching voltage | 48 V DC |
| Min. switching voltage | 3 V DC |
| Max. inrush current | - |
| Min./max. switching current | - / 100 mA |
| Output protection | Protection against polarity reversal, Surge protection |
| Voltage drop at max. limiting continuous current | ≤ 1 V |
| Leakage current in off state | - |
| Phase angle (cos ϕ) | - |
| Max. load value | - |
| General data | |
| Test voltage input/output | 2.5 kV (50 Hz, 1 min.) |
| Ambient temperature (operation) | -25°C ... 60°C |
| Standards/regulations | IEC 60664, EN 50178, IEC 62103 |
| Pollution degree/surge voltage category | 2 / III |
| Connection data solid / stranded / AWG | 0.14 - 2.5 mm ² / 0.14 - 2.5 mm ² / 26 - 14 |
| Dimensions | W / H / D 6.2 mm / 80 mm / 94 mm |

| Technical data | | | | | |
|----------------|-----------|-----------|-----------|-----------|-----------|
| ① | ② | ③ | ④ | ⑤ | ⑥ |
| 0.8 - 1.2 | 0.8 - 1.2 | 0.8 - 1.2 | 0.8 - 1.1 | 0.9 - 1.1 | 0.9 - 1.1 |
| ≥ 0.8 | ≥ 0.8 | ≥ 0.8 | ≥ 0.8 | ≥ 0.9 | ≥ 0.8 |
| ≤ 0.4 | ≤ 0.3 | ≤ 0.4 | ≤ 0.4 | ≤ 0.3 | ≤ 0.3 |
| 8.5 | 9 | 5 | 3 | 3.5 | 3.5 |
| 0.02 | 0.03 | 0.04 | 1 | 3 | 3 |
| 0.3 | 0.2 | 3 | 3 | 4 | 5 |
| 300 | 300 | 100 | 50 | 10 | 10 |

Yellow LED, Protection against polarity reversal, freewheeling diode
Yellow LED, Bridge rectifier

| Description | Input voltage U_N |
|---|---------------------|
| PLC INTERFACE, with screw connection | |
| ① | 24 V DC |
| ② | 48 V DC |
| ③ | 60 V DC |
| ④ | 125 V DC |
| ⑤ | 120 V AC (110 V DC) |
| ⑥ | 230 V AC (220 V DC) |
| PLC INTERFACE, with spring-cage connection | |
| ① | 24 V DC |
| ② | 48 V DC |
| ③ | 60 V DC |
| ④ | 120 V AC (110 V DC) |
| ⑤ | 230 V AC (220 V DC) |
| PLC-INTERFACE, with push-in connection | |
| ① | 24 V DC |
| ② | 48 V DC |
| ③ | 60 V DC |
| ④ | 120 V AC (110 V DC) |
| ⑤ | 230 V AC (220 V DC) |

| Ordering data | | |
|--|-----------|-------------|
| Type | Order No. | Pcs. / Pkt. |
| PLC-OSC- 24DC/ 48DC/100 ¹) | 2966728 | 10 |
| PLC-OSC- 48DC/ 48DC/100 ¹) | 2966993 | 10 |
| PLC-OSC- 60DC/ 48DC/100 ¹) | 2967455 | 10 |
| PLC-OSC-125DC/ 48DC/100 ¹) | 2980047 | 10 |
| PLC-OSC-120UC/ 48DC/100 ¹) | 2966744 | 10 |
| PLC-OSC-230UC/ 48DC/100 ¹) | 2966757 | 10 |
| PLC-OSP- 24DC/ 48DC/100 ¹) | 2967549 | 10 |
| PLC-OSP- 48DC/ 48DC/100 ¹) | 2967743 | 10 |
| PLC-OSP- 60DC/ 48DC/100 ¹) | 2967756 | 10 |
| PLC-OSP-120UC/ 48DC/100 ¹) | 2967552 | 10 |
| PLC-OSP-230UC/ 48DC/100 ¹) | 2967565 | 10 |
| PLC-OPT- 24DC/ 48DC/100 ¹) | 2900352 | 10 |
| PLC-OPT- 48DC/ 48DC/100 ¹) | 2900353 | 10 |
| PLC-OPT- 60DC/ 48DC/100 ¹) | 2900354 | 10 |
| PLC-OPT-120UC/ 48DC/100 ¹) | 2900355 | 10 |
| PLC-OPT-230UC/ 48DC/100 ¹) | 2900356 | 10 |

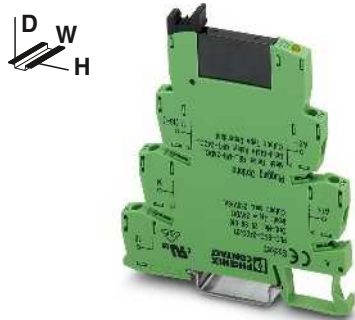

Max. DC voltage output of 3 A

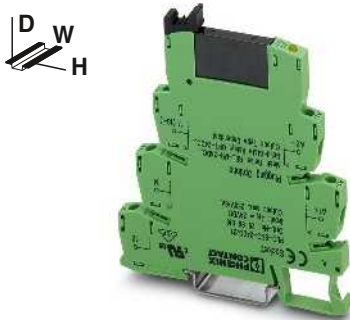

Max. AC voltage output of 750 mA

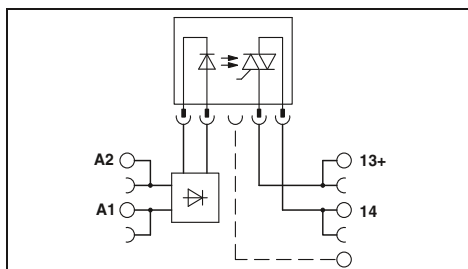
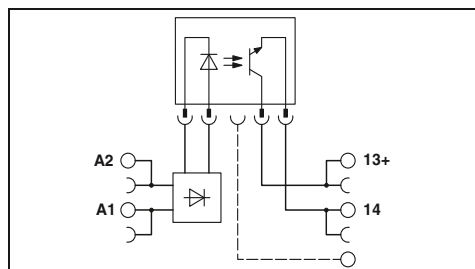

Technical data

| ① | ② | ③ | ④ | ⑤ | ⑥ |
|-----------|-----------|-----------|-----------|-----------|-----------|
| 0.8 - 1.2 | 0.8 - 1.2 | 0.8 - 1.2 | 0.8 - 1.1 | 0.9 - 1.1 | 0.9 - 1.1 |
| ≥ 0.8 | ≥ 0.8 | ≥ 0.8 | ≥ 0.8 | ≥ 0.8 | ≥ 0.8 |
| ≤ 0.4 | ≤ 0.4 | ≤ 0.3 | ≤ 0.3 | ≤ 0.3 | ≤ 0.3 |
| 8.5 | 9 | 5 | 3 | 3.5 | 3.5 |
| 0.02 | 0.03 | 0.04 | 0.04 | 3.5 | 4 |
| 0.3 | 0.3 | 0.5 | 0.6 | 7 | 7 |
| 300 | 300 | 100 | 100 | 10 | 10 |

Yellow LED, Protection against polarity reversal, freewheeling diode
Yellow LED, Bridge rectifier

33 V DC
3 V DC
15 A (10 ms)
- / 3 A (see derating curve)

Protection against polarity reversal, Surge protection
≤ 200 mV
-
-

2.5 kV (50 Hz, 1 min.)
-25°C ... 60°C
IEC 60664, EN 50178, IEC 62103
2 / III
0.14 - 2.5 mm² / 0.14 - 2.5 mm² / 26 - 14
6.2 mm / 80 mm / 94 mm

Technical data

| ① | ② | ③ | ④ | ⑤ | ⑥ |
|-----------|-----------|-----------|-----------|-----------|-----------|
| 0.8 - 1.2 | 0.8 - 1.2 | 0.8 - 1.2 | 0.8 - 1.1 | 0.9 - 1.1 | 0.8 - 1.1 |
| ≥ 0.8 | ≥ 0.8 | ≥ 0.8 | ≥ 0.8 | ≥ 0.8 | ≥ 0.8 |
| ≤ 0.25 | ≤ 0.25 | ≤ 0.3 | ≤ 0.3 | ≤ 0.25 | ≤ 0.25 |
| 8 | 9 | 6 | 3.5 | 4 | 3.5 |
| 10 | 10 | 10 | 10 | 10 | 10 |
| 10 | 10 | 10 | 10 | 10 | 10 |
| 10 | 10 | 10 | 10 | 3 | 3 |

253 V AC
24 V AC
30 A (10 ms)
10 mA / 0.75 A (see derating curve)
RCV circuit
< 1 V
< 1 mA (in off state)
0.5
4.5 A₂₅

2.5 kV (50 Hz, 1 min.)
-25°C ... 60°C
IEC 60664, EN 50178, IEC 62103
2 / III
0.14 - 2.5 mm² / 0.14 - 2.5 mm² / 26 - 14
6.2 mm / 80 mm / 94 mm

Ordering data

| Type | Order No. | Pcs. / Pkt. |
|--------------------------|-----------|-------------|
| PLC-OSC- 24DC/ 24DC/ 2') | 2966634 | 10 |
| PLC-OSC- 48DC/ 24DC/ 2') | 2967002 | 10 |
| PLC-OSC- 60DC/ 24DC/ 2') | 2967468 | 10 |
| PLC-OSC-125DC/ 24DC/ 2') | 2980050 | 10 |
| PLC-OSC-120UC/ 24DC/ 2') | 2966650 | 10 |
| PLC-OSC-230UC/ 24DC/ 2') | 2966663 | 10 |
| PLC-OSP- 24DC/ 24DC/ 2') | 2967471 | 10 |
| PLC-OSP- 48DC/ 24DC/ 2') | 2967727 | 10 |
| PLC-OSP- 60DC/ 24DC/ 2') | 2967730 | 10 |
| PLC-OSP-120UC/ 24DC/ 2') | 2967484 | 10 |
| PLC-OSP-230UC/ 24DC/ 2') | 2967497 | 10 |
| PLC-OPT- 24DC/ 24DC/2') | 2900364 | 10 |
| PLC-OPT- 48DC/ 24DC/2') | 2900365 | 10 |
| PLC-OPT- 60DC/ 24DC/2') | 2900366 | 10 |
| PLC-OPT-120UC/ 24DC/2') | 2900367 | 10 |
| PLC-OPT-230UC/ 24DC/2') | 2900368 | 10 |

Ordering data

| Type | Order No. | Pcs. / Pkt. |
|--------------------------|-----------|-------------|
| PLC-OSC- 24DC/230AC/ 1') | 2967840 | 10 |
| PLC-OSC- 48DC/230AC/ 1') | 2967853 | 10 |
| PLC-OSC- 60DC/230AC/ 1') | 2967866 | 10 |
| PLC-OSC-125DC/230AC/ 1') | 2980063 | 10 |
| PLC-OSC-120UC/230AC/ 1') | 2967879 | 10 |
| PLC-OSC-230UC/230AC/ 1') | 2967882 | 10 |
| PLC-OSP- 24DC/230AC/ 1') | 2967895 | 10 |
| PLC-OSP- 48DC/230AC/ 1') | 2967905 | 10 |
| PLC-OSP- 60DC/230AC/ 1') | 2967918 | 10 |
| PLC-OSP-120UC/230AC/ 1') | 2967921 | 10 |
| PLC-OSP-230UC/230AC/ 1') | 2967934 | 10 |
| PLC-OPT- 24DC/230AC/1') | 2900369 | 10 |
| PLC-OPT- 48DC/230AC/1') | 2900370 | 10 |
| PLC-OPT- 60DC/230AC/1') | 2900371 | 10 |
| PLC-OPT-120UC/230AC/1') | 2900372 | 10 |
| PLC-OPT-230UC/230AC/1') | 2900374 | 10 |

Relay modules

PLC series

PLC actuator series for output functions

PLC actuator series for coupling controller and actuators, such as motors, contactors, valves, etc.

The advantages:

- Actuator connected directly to relay module
- No need for additional modular terminal blocks
- Space savings of up to 80%
- Time savings of up to 60%
- Screw, spring-cage, and push-in technology
- Relay modules with safe isolation according to DIN EN 50178 between coil and contact
- Functional plug-in bridges
- Efficient connection to system cabling using V8 adapter

| Notes: | |
|---|--|
| Type of housing: | Polyamide PA non-reinforced, color: green. |
| Marking systems and mounting material | See Catalog 5 |
| Separating plate PLC-ATP must be installed for voltages larger than 250 V (L1, L2, L3) between identical terminal blocks in adjacent modules. Potential bridging is then carried out with FBST 8-PLC... or FBST 500.... | |
| For diagrams of operating voltage ranges, see page 343 | |
| For derating curves see page 345 | |
| 1) EMC: Class A product, see page 571 | |



1 N/O contact with power contact

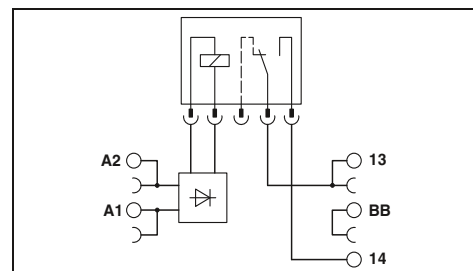

Technical data

| Input data | |
|--|--|
| Permissible range (with reference to U_N) | See diagram |
| Switching level (with reference to U_N) | 1 signal ("H") 0 signal ("L") |
| Typ. input current at U_N | [mA] 9 |
| Typ. response time/switch-on time at U_N | [ms] 5 |
| Typ. release time/switch-off time at U_N | [ms] 8 |
| Transmission frequency f_{limit} | [Hz] |
| Input circuit DC | Yellow LED, Protection against polarity reversal, freewheeling diode |
| Output data | |
| Contact material | AgSnO |
| Max. switching voltage | 250 V AC/DC |
| Min. switching voltage | 5 V (at 100 mA) |
| Limiting continuous current | 6 A |
| Max. inrush current | (on request) |
| Min. switching current | 10 mA (at 12 V) |
| Output protection | - |
| Voltage drop at max. limiting continuous current | - |
| Leakage current in off state | - |
| Phase angle (cos ϕ) | - |
| Max. load value | - |
| General data | |
| Test voltage input/output | 4 kV AC (50 Hz, 1 min.) |
| Ambient temperature (operation) | -40°C ... 60°C |
| Mechanical service life | 2 x 10 ⁷ cycles |
| Standards/regulations | IEC 60664, EN 50178, IEC 62103 |
| Pollution degree/surge voltage category | 3 / III |
| Connection data solid / stranded / AWG | 0.14 - 2.5 mm ² / 0.14 - 2.5 mm ² / 26 - 14 |
| Dimensions | W / H / D 6.2 mm / 80 mm / 94 mm |

Electrical interrupting rating for PLC...24DC/1/ACT with 1-N/O relay

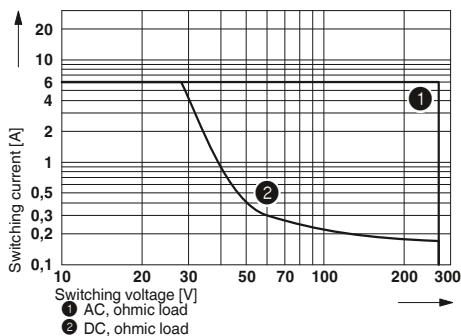

Electrical interrupting rating for PLC...24DC/1-1/ACT with 2-N/O relay

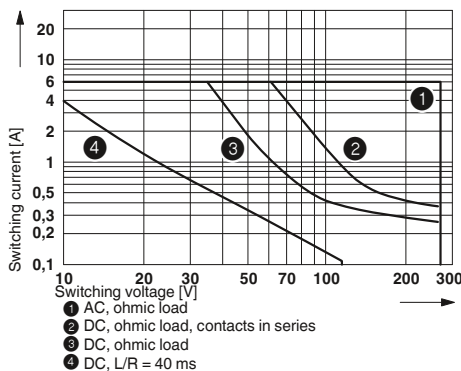

| Description | Input voltage U_N |
|--|---------------------|
| PLC INTERFACE, with screw connection | ① 5 V DC |
| | ② 24 V DC |
| PLC INTERFACE, with spring-cage connection | ① 5 V DC |
| | ② 24 V DC |
| PLC-INTERFACE, with push-in connection | ① 5 V DC |
| | ② 24 V DC |

Ordering data

| Type | Order No. | Pcs. / Pkt. |
|------------------------------------|-----------|-------------|
| PLC-RSC- 24DC/ 1/ACT ¹⁾ | 2966210 | 10 |
| PLC-RSP- 24DC/ 1/ACT ¹⁾ | 2967345 | 10 |
| PLC-RPT- 24DC/ 1/ACT ¹⁾ | 2900312 | 10 |



2 N/O contacts with power contact



Max. DC voltage output of 3 A



Max. AC voltage output of 750 mA



Technical data

Technical data

Technical data

| | |
|--|--|
| ② | |
| See diagram | |
| 18 | |
| 8 | |
| 10 | |
| Yellow LED, Protection against polarity reversal, freewheeling diode | |
| AgNi | |
| 250 V AC/DC | |
| 5 V AC/DC | |
| 6 A | |
| 8 A | |
| 10 mA | |
| - | |
| - | |
| - | |
| - | |
| - | |
| 4 kV AC (50 Hz, 1 min.) | |
| -40°C ... 60°C | |
| 3 x 10 ⁷ cycles | |
| IEC 60664, EN 50178, IEC 62103 | |
| 2 / III | |
| 0.14 - 2.5 mm ² / 0.14 - 2.5 mm ² / 26 - 14 | |
| 14 mm / 80 mm / 94 mm | |

| | |
|--|-----------|
| ① | ② |
| 0.8 - 1.2 | 0.8 - 1.2 |
| ≥ 0.8 | ≥ 0.8 |
| ≤ 0.25 | ≤ 0.4 |
| 9.5 | 8.5 |
| 0.02 | 0.02 |
| 0.3 | 0.3 |
| 300 | 300 |
| Yellow LED, Protection against polarity reversal, freewheeling diode | |
| - | |
| 33 V DC | |
| 3 V DC | |
| 3 A (see derating curve) | |
| 15 A (10 ms) | |
| - | |
| Protection against polarity reversal, Surge protection | |
| ≤ 200 mV | |
| - | |
| - | |
| - | |
| - | |
| 2.5 kV (50 Hz, 1 min.) | |
| -25°C ... 60°C | |
| - | |
| IEC 60664, EN 50178, IEC 62103 | |
| 2 / III | |
| 0.14 - 2.5 mm ² / 0.14 - 2.5 mm ² / 26 - 14 | |
| 6.2 mm / 80 mm / 94 mm | |

| | |
|--|--|
| ② | |
| 0.8 - 1.2 | |
| ≥ 0.8 | |
| ≤ 0.25 | |
| 9 | |
| 3 | |
| 9 | |
| 10 | |
| Yellow LED, Protection against polarity reversal, freewheeling diode | |
| - | |
| 253 V AC | |
| 24 V AC | |
| 0.75 A (see derating curve) | |
| 30 A (10 ms) | |
| 10 mA | |
| RCV circuit | |
| < 1 V | |
| < 1 mA (in off state) | |
| 0.5 | |
| 4.5 A ^{2s} | |
| - | |
| 2.5 kV (50 Hz, 1 min.) | |
| -25°C ... 60°C | |
| - | |
| IEC 60664, EN 50178, IEC 62103 | |
| 2 / III | |
| 0.14 - 2.5 mm ² / 0.14 - 2.5 mm ² / 26 - 14 | |
| 6.2 mm / 80 mm / 94 mm | |

Ordering data

Ordering data

Ordering data

| Type | Order No. | Pcs. / Pkt. |
|--|-----------|-------------|
| PLC-RSC- 24DC/ 1- 1/ACT ¹) | 2967109 | 10 |

| Type | Order No. | Pcs. / Pkt. |
|---|-----------|-------------|
| PLC-OSC- 5DC/ 24DC/ 2/ACT ¹) | 2980144 | 10 |
| PLC-OSC- 24DC/ 24DC/ 2/ACT ¹) | 2966676 | 10 |
| PLC-OSP- 5DC/ 24DC/ 2/ACT ¹) | 2980157 | 10 |
| PLC-OSP- 24DC/ 24DC/ 2/ACT ¹) | 2967507 | 10 |
| PLC-OPT- 5DC/ 24DC/2/ACT ¹) | 2900375 | 10 |
| PLC-OPT- 24DC/ 24DC/2/ACT ¹) | 2900376 | 10 |

| Type | Order No. | Pcs. / Pkt. |
|---|-----------|-------------|
| PLC-OSC- 24DC/230AC/ 1/ACT ¹) | 2967947 | 10 |

Relay modules

PLC series

PLC actuator series for output functions

PLC actuator series with solid-state power relays for coupling the controller and actuators, such as motors, contactors, valves, etc.

| |
|---|
| Notes: |
| Type of housing: Polyamide PA non-reinforced, color: green. |
| Marking systems and mounting material See Catalog 5 |
| Separating plate PLC-ATP must be installed for voltages larger than 250 V (L1, L2, L3) between identical terminal blocks in adjacent modules. Potential bridging is then carried out with FBST 8-PLC... or FBST 500.... |
| For derating curves see page 345 |



Max. DC voltage output of 5 A

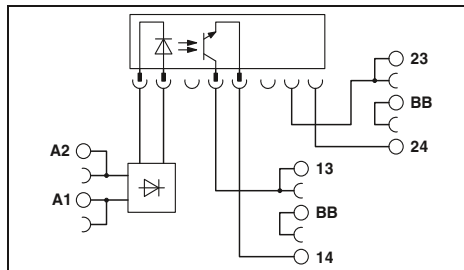

Technical data

| | |
|--|--|
| Input data | ① |
| Permissible range (with reference to U_N) | 0.8 - 1.2 |
| Switching level (with reference to U_N) | 1 signal ("H") ≥ 0.8 0 signal ("L") ≤ 0.4 |
| Typ. input current at U_N | [mA] 9 |
| Typ. switch-on time at U_N | [ms] 0.02 |
| Typ. switch-off time at U_N | [ms] 0.4 |
| Transmission frequency f_{limit} | [Hz] 300 |
| Input circuit DC | Yellow LED, Protection against polarity reversal, freewheeling diode |
| Output data | |
| Max. / min. switching voltage | 33 V DC / 3 V DC |
| Max. inrush current | 15 A (10 ms) |
| Min./max. switching current | - / 5 A (see derating curve) |
| Output protection | Protection against polarity reversal, Surge protection |
| Voltage drop at max. limiting continuous current | ≤ 200 mV |
| Leakage current in off state | - |
| Phase angle (cos ϕ) | - |
| Max. load value | - |
| General data | |
| Rated insulation voltage | 100 V DC |
| Rated surge voltage | 1.5 kV, basic insulation |
| Ambient temperature (operation) | -20°C ... 60°C |
| Standards/regulations | IEC 60664, EN 50178, IEC 62103 |
| Pollution degree/surge voltage category | 2 / III |
| Mounting position/mounting | Refer to Derating / In rows with zero spacing |
| Connection data solid / stranded / AWG | 0.14 - 2.5 mm ² / 0.14 - 2.5 mm ² / 26 - 14 |
| Dimensions | 14 mm / 80 mm / 94 mm |



Max. AC voltage output of 2 mA

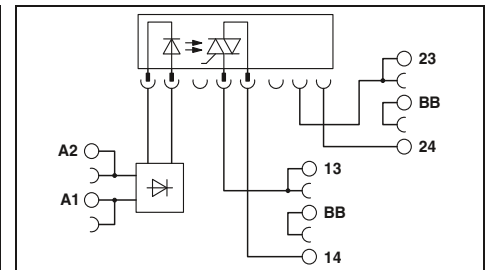

Technical data

| | |
|--|--|
| Input data | ① |
| Permissible range (with reference to U_N) | 0.8 - 1.2 |
| Switching level (with reference to U_N) | 1 signal ("H") ≥ 0.8 0 signal ("L") ≤ 0.4 |
| Typ. input current at U_N | [mA] 9 |
| Typ. switch-on time at U_N | [ms] 10 |
| Typ. switch-off time at U_N | [ms] 10 |
| Transmission frequency f_{limit} | [Hz] 10 |
| Input circuit DC | Yellow LED, Protection against polarity reversal, freewheeling diode |
| Output data | |
| Max. / min. switching voltage | 253 V AC / 24 V AC |
| Max. inrush current | 30 A (10 ms) |
| Min./max. switching current | 25 mA / 2 A (see derating curve) |
| Output protection | Surge protection |
| Voltage drop at max. limiting continuous current | ≤ 1 V |
| Leakage current in off state | Typ. 1 mA |
| Phase angle (cos ϕ) | 0.5 |
| Max. load value | 4 A ² s (tp = 10 ms, at 25°C) |
| General data | |
| Rated insulation voltage | 250 V AC |
| Rated surge voltage | 4 kV / basic insulation |
| Ambient temperature (operation) | -20°C ... 60°C |
| Standards/regulations | IEC 60664, EN 50178, IEC 62103 |
| Pollution degree/surge voltage category | 2 / III |
| Mounting position/mounting | Refer to Derating / In rows with zero spacing |
| Connection data solid / stranded / AWG | 0.14 - 2.5 mm ² / 0.14 - 2.5 mm ² / 26 - 14 |
| Dimensions | 14 mm / 80 mm / 94 mm |

Ordering data

| Description | Input voltage U_N |
|---|---------------------|
| PLC INTERFACE, with screw connection | |
| ① | 24 V DC |

| Type | Order No. | Pcs. / Pkt. |
|-------------------------|-----------|-------------|
| PLC-OSC-24DC/24DC/5/ACT | 2982786 | 10 |

Ordering data

| Type | Order No. | Pcs. / Pkt. |
|--------------------------|-----------|-------------|
| PLC-OSC-24DC/230AC/2/ACT | 2982760 | 10 |

PLC actuator series for output functions

PLC actuator basic terminal blocks that can be fitted with a mechanical or solid-state relay. For coupling the controller and actuators, such as motors, contactors, valves, etc.

| |
|--|
| Notes: |
| Maximum interrupting rating diagrams, see page 346 |
| For derating curves see page 345 |
| 1) EMC: Class A product, see page 571 |



Basic terminal block that can be fitted with mech. relay



Basic terminal block that can be fitted with solid-state relay

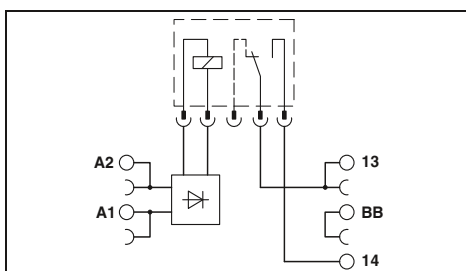

Technical data

| | |
|--|---|
| Input data | |
| Permissible range (with reference to U_N) | 0.8 ... 1.2 |
| Typ. input current with U_N (50 /60 Hz) | 15.6 mA / 8.5 mA |
| Typ. response time at U_N | 5 ms |
| Typ. release time at U_N | 30 ms |
| Input circuit | LED yellow, Bridge rectifier |
| Output data with: | REL-MR-24DC/21AU REL-MR-24DC/21 |
| Contact type | Single contact, 1 N/O contact Single contact, 1 N/O contact |
| Contact material | AgSnO, hard gold-plated AgSnO |
| Max. switching voltage | 30 V AC / 36 V DC 250 V AC/DC |
| Min. switching voltage | 100 mV (at 10 mA) 5 V (at 100 mA) |
| Limiting continuous current | 50 mA 6 A |
| Min. switching current | 1 mA (at 24 V) 10 mA (at 12 V) |
| Output protection | - - |
| Voltage drop at limiting continuous current | - - |
| Leakage current in off state | - - |
| Max. load value $I^2 \times t$ (t = 10 ms) | - - |
| General data | |
| Rated insulation voltage | 250 V AC |
| Rated surge voltage / insulation | 6 kV / Safe isolation, increased insulation |
| Ambient temperature (operation) | -20°C ... 60°C |
| Air and creepage distances | EN 50178, IEC 62103 |
| Pollution degree / Surge voltage category | 2 / III |
| Connection data solid / stranded / AWG | 0.14 - 2.5 mm ² / 0.14 - 2.5 mm ² / 26 - 14 |
| Dimensions | W / H / D 6.2 mm / 80 mm / 94 mm |

Ordering data

| Description | Voltage U_N |
|---|---------------|
| PLC INTERFACE, with screw connection | 24 V AC/DC |
| PLC INTERFACE, with spring-cage connection | 24 V AC/DC |
| PLC-INTERFACE, with push-in connection | 24 V AC/DC |

| Type | Order No. | Pcs. / Pkt. |
|------------------------------------|-----------|-------------|
| PLC-BSC- 24UC/ 1/ACT | 2982799 | 10 |
| PLC-BSP- 24UC/ 1/ACT | 2982809 | 10 |
| PLC-BPT- 24UC/ 1/ACT ¹⁾ | 2900450 | 10 |

Accessories

| | | | |
|---|--|--------------------|----------|
| Plug-in miniature relays with gold contact with power contact | REL-MR- 24DC/21AU REL-MR- 24DC/21 | 2961121 2961105 | 10 10 |
| Plug-in solid-state relays Solid-state input relays Solid-state power relays Solid-state power relays | | | |

| | | | |
|--|--|--|--|
| | | | |
| | | | |

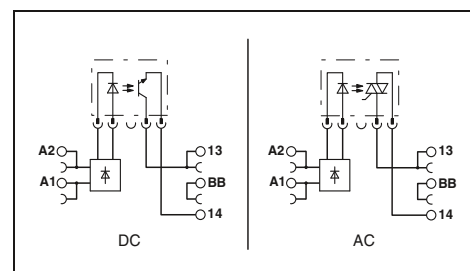

Technical data

| | | |
|---|---|----------------------|
| Input data | | |
| Permissible range (with reference to U_N) | 0.8 ... 1.2 | |
| Typ. input current with U_N (50 /60 Hz) | 15 mA / 8.3 mA | |
| Typ. response time at U_N | 10 ms | |
| Typ. release time at U_N | 20 ms | |
| Input circuit | Yellow LED, Bridge rectifier | |
| Output data with: | OPT...48DC/... OPT...24DC/... OPT...230AC/... | |
| Contact type | - - - | |
| Contact material | - - - | |
| Max. switching voltage | 48 V DC 33 V DC 253 V AC | |
| Min. switching voltage | 3 V DC 3 V DC 24 V AC | |
| Limiting continuous current | 100 mA 3 A 0.75 A | (see derating curve) |
| Min. switching current | - - - | |
| Output protection | Protection against polarity reversal, Surge protection Protection against polarity reversal, Surge protection RCV circuit | |
| Voltage drop at limiting continuous current | ≤ 1 V ≤ 150 mV ≤ 1 V | |
| Leakage current in off state | - - ≤ 1 mA | |
| Max. load value $I^2 \times t$ (t = 10 ms, at 25°C) | - - 4.5 A ² s | |
| General data | | |
| Rated insulation voltage | 250 V AC | |
| Rated surge voltage / insulation | 6 kV / Safe isolation, increased insulation | |
| Ambient temperature (operation) | -20°C ... 60°C | |
| Air and creepage distances | EN 50178, IEC 62103 | |
| Pollution degree / Surge voltage category | 2 / III | |
| Connection data solid / stranded / AWG | 0.14 - 2.5 mm ² / 0.14 - 2.5 mm ² / 26 - 14 | |
| Dimensions | W / H / D 6.2 mm / 80 mm / 94 mm | |

Ordering data

| Type | Order No. | Pcs. / Pkt. |
|------------------------------------|-----------|-------------|
| PLC-BSC- 24UC/ 1/ACT | 2982799 | 10 |
| PLC-BSP- 24UC/ 1/ACT | 2982809 | 10 |
| PLC-BPT- 24UC/ 1/ACT ¹⁾ | 2900450 | 10 |

Accessories

| | | | |
|--|---|-------------------------------|----------------|
| | OPT-24DC/ 48DC/100 OPT-24DC/ 24DC/ 2 OPT-24DC/230AC/ 1 | 2966618 2966595 2967950 | 10 10 10 |
|--|---|-------------------------------|----------------|

Relay modules

PLC series

PLC sensor series for input functions

PLC sensor series for coupling controller and sensors, such as proximity switches, limit switches or auxiliary contacts

The advantages:

- Direct connection of sensor to relay module
- No need for additional modular terminal blocks
- Space savings of up to 80%
- Time savings of up to 60%
- Screw, spring-cage, and push-in technology
- Relay modules with safe isolation according to DIN EN 50178 between coil and contact
- Functional plug-in bridges
- Efficient connection to system cabling using V8 adapter

| Notes: |
|---|
| Type of housing: Polyamide PA non-reinforced, color: green. |
| Marking systems and mounting material See Catalog 5 |
| Separating plate PLC-ATP must be installed for voltages larger than 250 V (L1, L2, L3) between identical terminal blocks in adjacent modules. Potential bridging is then carried out with FBST 8-PLC... or FBST 500.... |
| If the specified maximum values for multi-layer contact relays are exceeded, the gold plating is destroyed. The maximum values of the power contact relay are then valid. This can result in a shorter service life than with a pure power contact. |
| For diagrams of operating voltage ranges, see page 343 |
| 1) 120 and 230 V types up to 55°C |
| 2) EMC: Class A product, see page 571 |



Relay module
1 N/O contact



Technical data

| Input data | ① | ② | ③ |
|--|---|---|---------|
| Permissible range (with reference to U_N) | See diagram | | |
| Switching level (with reference to U_N) | 1 signal ("H") 0 signal ("L") | | |
| Typ. input current at U_N | [mA] | 9 | 3.5 3.2 |
| Typ. response time/switch-on time at U_N | [ms] | 5 | 6 7 |
| Typ. release time/switch-off time at U_N | [ms] | 8 | 15 15 |
| Transmission frequency f_{limit} | [Hz] | | |
| Input circuit DC | | | |
| Input circuit AC/DC | | | |
| Output data | | | |
| Contact material | AgSnO, hard gold-plated | | |
| Max. switching voltage | 30 V AC / 36 V DC | | |
| Min. switching voltage | 100 mV (at 10 mA) | | |
| Limiting continuous current | 50 mA | | |
| Max. inrush current | 50 mA | | |
| Min. switching current | 1 mA (at 24 V) | | |
| Output protection | - | | |
| Voltage drop at max. limiting continuous current | - | | |
| General data | | | |
| Test voltage input/output | 4 kV AC (50 Hz, 1 min.) | | |
| Ambient temperature (operation) | -40°C ... 60°C ¹⁾ | | |
| Mechanical service life | 2 x 10 ⁷ cycles | | |
| Standards/regulations | IEC 60664, EN 50178, IEC 62103 | | |
| Pollution degree/surge voltage category | 3 / III | | |
| Connection data solid / stranded / AWG | 0.14 - 2.5 mm ² / 0.14 - 2.5 mm ² / 26 - 14 | | |
| Dimensions | W / H / D 6.2 mm / 80 mm / 94 mm | | |

| ① | ② | ③ |
|--|---|---|
| See diagram | | |
| Yellow LED, Protection against polarity reversal, freewheeling diode | | |
| Yellow LED, Bridge rectifier | | |

Ordering data

| Description | Input voltage U_N |
|---|---------------------|
| PLC INTERFACE, with screw connection | |
| ① | 24 V DC |
| ② | 120 V AC (110 V DC) |
| ③ | 230 V AC (220 V DC) |
| PLC INTERFACE, with spring-cage connection | |
| ① | 24 V DC |
| ② | 120 V AC (110 V DC) |
| ③ | 230 V AC (220 V DC) |
| PLC-INTERFACE, with push-in connection | |
| ① | 24 V DC |
| ② | 120 V AC (110 V DC) |
| ③ | 230 V AC (220 V DC) |

| Type | Order No. | Pcs. / Pkt. |
|--------------------------------------|-----------|-------------|
| PLC-RSC- 24DC/ 1AU/SEN ²⁾ | 2966317 | 10 |
| PLC-RSC-120UC/ 1AU/SEN ²⁾ | 2966320 | 10 |
| PLC-RSC-230UC/ 1AU/SEN ²⁾ | 2966333 | 10 |
| PLC-RSP- 24DC/ 1AU/SEN ²⁾ | 2967374 | 10 |
| PLC-RSP-120UC/ 1AU/SEN ²⁾ | 2967390 | 10 |
| PLC-RSP-230UC/ 1AU/SEN ²⁾ | 2967413 | 10 |
| PLC-RPT- 24DC/ 1AU/SEN ²⁾ | 2900313 | 10 |
| PLC-RPT-120UC/ 1AU/SEN ²⁾ | 2900314 | 10 |
| PLC-RPT-230UC/ 1AU/SEN ²⁾ | 2900315 | 10 |



Max. DC voltage output of 100 mA

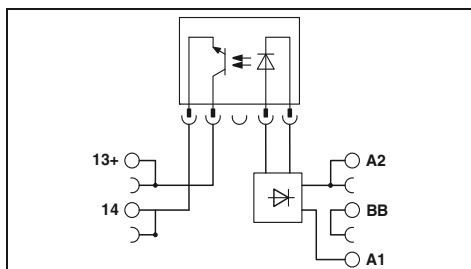

Technical data

| ① | ② | ③ |
|-----------|-----------|-----------|
| 0.8 - 1.2 | 0.8 - 1.1 | 0.8 - 1.1 |
| ≥ 0.8 | ≥ 0.8 | ≥ 0.8 |
| ≤ 0.4 | ≤ 0.3 | ≤ 0.3 |
| 8.5 | 3.5 | 3.5 |
| 0.02 | 6 | 3 |
| 0.3 | 10 | 5 |
| 300 | 10 | 10 |

Yellow LED, Protection against polarity reversal, freewheeling diode
 Yellow LED, Bridge rectifier

-
 48 V DC
 3 V DC
 100 mA
 -
 -
 Protection against polarity reversal, Surge protection
 ≤ 1 V

2.5 kV (50 Hz, 1 min.)
 -25°C ... 60°C

-
 IEC 60664, EN 50178, IEC 62103
 2 / III
 0.14 - 2.5 mm² / 0.14 - 2.5 mm² / 26 - 14
 6.2 mm / 80 mm / 94 mm

Ordering data

| Type | Order No. | Pcs. / Pkt. |
|--|-----------|-------------|
| PLC-OSC- 24DC/ 48DC/100/SEN ²) | 2966773 | 10 |
| PLC-OSC-120UC/ 48DC/100/SEN ²) | 2966799 | 10 |
| PLC-OSC-230UC/ 48DC/100/SEN ²) | 2966809 | 10 |
| PLC-OSP- 24DC/ 48DC/100/SEN ²) | 2967578 | 10 |
| PLC-OSP-120UC/ 48DC/100/SEN ²) | 2967581 | 10 |
| PLC-OSP-230UC/ 48DC/100/SEN ²) | 2967594 | 10 |
| PLC-OPT- 24DC/ 48DC/100/SEN ²) | 2900358 | 10 |
| PLC-OPT-120UC/ 48DC/100/SEN ²) | 2900359 | 10 |
| PLC-OPT-230UC/ 48DC/100/SEN ²) | 2900361 | 10 |

Relay modules

PLC series

PLC-INTERFACE for high inrush currents

PLC relay modules for high inrush currents due, for example, to capacitive loads

The advantages:

- Max. inrush current of 130 A
- Direct connection of load return line thanks to actuator type
- Screw, spring-cage, and push-in technology
- Safe isolation according to DIN EN 50178 between coil and contact
- Functional plug-in bridges
- Efficient connection to system cabling using V8 adapter

| Notes: |
|---|
| Type of housing: Polyamide PA non-reinforced, color: green. |
| Marking systems and mounting material See Catalog 5 |
| Separating plate PLC-ATP must be installed for voltages larger than 250 V (L1, L2, L3) between identical terminal blocks in adjacent modules. Potential bridging is then carried out with FBST 8-PLC... or FBST 500.... |
| For diagrams of operating voltage ranges, see page 343 |
| 1) EMC: Class A product, see page 571 |



1 N/O contact of up to 130 A peak



Technical data

| | |
|--|-----------|
| Input data | |
| Typ. input current at U_N | [mA] |
| Response/release time at U_N | [ms] |
| Input circuit DC | |
| Output data | |
| Contact material | |
| Max. switching voltage | |
| Min. switching voltage | |
| Max. inrush current | |
| General data | |
| Test voltage input/output | |
| Ambient temperature (operation) | |
| Mechanical service life | |
| Standards/regulations | |
| Connection data solid / stranded / AWG | |
| Dimensions | W / H / D |

| | |
|---|---|
| ① | 18 |
| | 8 / 10 |
| | Yellow LED, Protection against polarity reversal, freewheeling diode |
| | AgSnO |
| | 250 V AC/DC |
| | 12 V AC/DC (at 100 mA) |
| | 80 A (for 20 ms) / 130 A (peak, at capacitive load, 230 V AC, 24 μ F) |
| | 4 kV AC (50 Hz, 1 min.) |
| | -40°C ... 60°C |
| | 3 x 10 ⁷ cycles |
| | IEC 60664, EN 50178, IEC 62103 |
| | 0.14 - 2.5 mm ² / 0.14 - 2.5 mm ² / 26 - 14 |
| | 14 mm / 80 mm / 94 mm |

Basic behavior of capacitive loads:

- Very high input current
- Voltage increases with an e-function

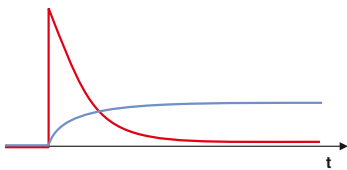

Max. interrupting rating

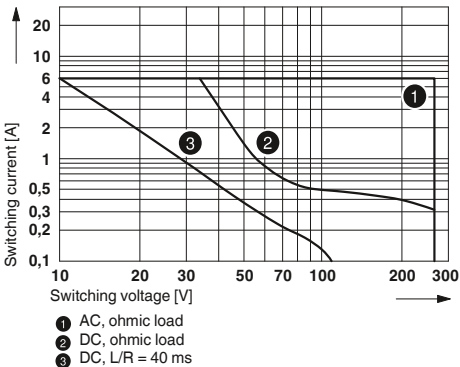

| Description | Input voltage U_N |
|---|---------------------|
| PLC INTERFACE, with screw connection ① | 24 V DC |
| PLC INTERFACE, with spring-cage connection ① | 24 V DC |
| PLC-INTERFACE, with push-in connection ① | 24 V DC |

Ordering data

| Type | Order No. | Pcs. / Pkt. |
|---------------------------------------|-----------|-------------|
| PLC-RSC- 24DC/ 1IC/ACT ¹) | 2967604 | 10 |
| PLC-RSP- 24DC/ 1IC/ACT ¹) | 2912413 | 10 |
| PLC-RPT- 24DC/ 1IC/ACT ¹) | 2900298 | 10 |

PLC-INTERFACE for high continuous currents

PLC relay modules for high continuous switching currents

- The advantages:
- Max. continuous current of 10 A
 - Safe isolation according to DIN EN 50178 between coil and contact
 - Screw, spring-cage, and push-in technology
 - Functional plug-in bridges
 - Efficient connection to system cabling using V8 adapter
 - Long electrical service life thanks to 16 A relay
 - All common input voltages of 12 V DC to 230 V AC

| | |
|---|--|
| Notes: | |
| Type of housing: | Polyamide PA non-reinforced, color: green. |
| Marking systems and mounting material | See Catalog 5 |
| Separating plate PLC-ATP must be installed for voltages larger than 250 V (L1, L2, L3) between identical terminal blocks in adjacent modules. Potential bridging is then carried out with FBST 8-PLC... or FBST 500.... | |
| For diagrams of operating voltage ranges, see page 343 | |
| 1) 230 V types up to 55°C | |
| 2) EMC: Class A product, see page 571 | |



1 PDT up to 10 A

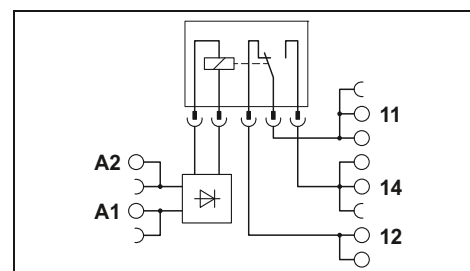

Technical data

| | ① | ② | ③ | ④ | ⑤ | ⑥ | ⑦ |
|--|--|--------|--------|--------|--------|--------|--------|
| Input data | | | | | | | |
| Typ. input current at U_N | 33 | 18 | 17.5 | 20 | 10 | 4.5 | 4.5 |
| Response/release time at U_N | 8 / 10 | 8 / 10 | 8 / 10 | 8 / 10 | 8 / 10 | 7 / 10 | 7 / 10 |
| Input circuit DC | Yellow LED, Protection against polarity reversal, freewheeling diode | | | | | | |
| Input circuit AC/DC | Yellow LED, Bridge rectifier | | | | | | |
| Output data | | | | | | | |
| Contact material | AgNi | | | | | | |
| Max. switching voltage | 250 V AC/DC | | | | | | |
| Min. switching voltage | 12 V AC/DC | | | | | | |
| Limiting continuous current | 10 A | | | | | | |
| Max. inrush current | 30 A (300 ms) | | | | | | |
| Min. switching current | 100 mA | | | | | | |
| General data | | | | | | | |
| Test voltage input/output | 4 kV AC (50 Hz, 1 min.) | | | | | | |
| Ambient temperature (operation) | -40°C ... 60°C ¹⁾ | | | | | | |
| Mechanical service life | 3 x 10 ⁷ cycles | | | | | | |
| Standards/regulations | IEC 60664, EN 50178, IEC 62103 | | | | | | |
| Connection data solid / stranded / AWG | 0.14 - 2.5 mm ² / 0.14 - 2.5 mm ² / 26 - 14 | | | | | | |
| Dimensions | W / H / D 14 mm / 80 mm / 94 mm | | | | | | |

Ordering data

| Description | Input voltage U_N | Type | Order No. | Pcs. / Pkt. |
|---|---------------------|----------------------------------|-----------|-------------|
| PLC INTERFACE, with screw connection | | | | |
| ① | 12 V DC | PLC-RSC- 12DC/21HC ²⁾ | 2967617 | 10 |
| ② | 24 V DC | PLC-RSC- 24DC/21HC ²⁾ | 2967620 | 10 |
| ③ | 24 V AC/DC | PLC-RSC- 24UC/21HC ²⁾ | 2967633 | 10 |
| ④ | 48 V DC | PLC-RSC- 48DC/21HC ²⁾ | 2967646 | 10 |
| ⑤ | 60 V DC | PLC-RSC- 60DC/21HC ²⁾ | 2967659 | 10 |
| ⑥ | 120 V AC (110 V DC) | PLC-RSC-120UC/21HC ²⁾ | 2967662 | 10 |
| ⑦ | 230 V AC (220 V DC) | PLC-RSC-230UC/21HC ²⁾ | 2967675 | 10 |
| PLC INTERFACE, with spring-cage connection | | | | |
| ① | 12 V DC | PLC-RSP- 12DC/21HC ²⁾ | 2912264 | 10 |
| ② | 24 V DC | PLC-RSP- 24DC/21HC ²⁾ | 2912277 | 10 |
| ③ | 24 V AC/DC | PLC-RSP- 24UC/21HC ²⁾ | 2912280 | 10 |
| ④ | 48 V DC | PLC-RSP- 48DC/21HC ²⁾ | 2912293 | 10 |
| ⑤ | 60 V DC | PLC-RSP- 60DC/21HC ²⁾ | 2912303 | 10 |
| ⑥ | 120 V AC (110 V DC) | PLC-RSP-120UC/21HC ²⁾ | 2912316 | 10 |
| ⑦ | 230 V AC (220 V DC) | PLC-RSP-230UC/21HC ²⁾ | 2912329 | 10 |
| PLC-INTERFACE, with push-in connection | | | | |
| ① | 12 V DC | PLC-RPT- 12DC/21HC ²⁾ | 2900290 | 10 |
| ② | 24 V DC | PLC-RPT- 24DC/21HC ²⁾ | 2900291 | 10 |
| ③ | 24 V AC/DC | PLC-RPT- 24UC/21HC ²⁾ | 2900293 | 10 |
| ④ | 48 V DC | PLC-RPT- 48DC/21HC ²⁾ | 2900294 | 10 |
| ⑤ | 60 V DC | PLC-RPT- 60DC/21HC ²⁾ | 2900295 | 10 |
| ⑥ | 120 V AC (110 V DC) | PLC-RPT-120UC/21HC ²⁾ | 2900296 | 10 |
| ⑦ | 230 V AC (220 V DC) | PLC-RPT-230UC/21HC ²⁾ | 2900297 | 10 |

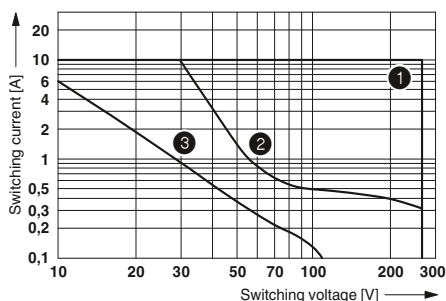

① AC, ohmic load
② DC, ohmic load
③ DC, L/R = 40 ms

Max. interrupting rating

Basic terminal blocks with interference current filter that can be fitted with relays

PLC basic terminal blocks with integrated filter to protect against interference voltages or currents due, for example, to long control lines

The advantages:

- Resistant to interference currents
- High relay release voltage

Typical applications:

- Applications with long control lines
- Use of AC output boards, resulting in residual AC currents
- Screw, spring-cage, and push-in technology

| Notes: |
|---|
| Type of housing: Polyamide PA non-reinforced, color: green. |
| Marking systems and mounting material See Catalog 5 |
| Separating plate PLC-ATP must be installed for voltages larger than 250 V (L1, L2, L3) between identical terminal blocks in adjacent modules. Potential bridging is then carried out with FBST 8-PLC... or FBST 500.... |
| For diagrams of operating voltage ranges, see page 343 |
| Maximum interrupting rating diagrams, see page 346 |
| 1) EMC: Class A product, see page 571 |



Universal design



| Input data |
|--|
| Nominal input voltage U_N |
| Permissible range (with reference to U_N) |
| Typ. release voltage (with relay) |
| Typ. input current with U_N (50/60 Hz) |
| Typ. response time at U_N |
| Typ. release time at U_N |
| Input circuit |
| Output data with: |
| Contact type |
| Contact material |
| Max. switching voltage |
| Min. switching voltage |
| Limiting continuous current |
| Max. inrush current |
| Min. switching current |
| General data |
| Test voltage input/output |
| Ambient temperature (operation) |
| Mechanical service life |
| Standards/regulations |
| Pollution degree / Surge voltage category |
| Connection data solid / stranded / AWG |
| Dimensions |

| Technical data | |
|---|-------------------------|
| 120 V AC | 230 V AC |
| 0.8 ... 1.4 | 0.78 ... 1.14 |
| 50 V AC | 80 V AC |
| 7 mA / 8 mA | 8.8 mA / 10 mA |
| 7 ms | 7 ms |
| 20 ms | 20 ms |
| Yellow LED, Bridge rectifier, Filter | |
| REL-MR-60DC/21 | REL-MR-60DC/21AU |
| Single contact, 1-PDT | Single contact, 1-PDT |
| AgSnO | AgSnO, hard gold-plated |
| 250 V AC/DC | 30 V AC / 36 V DC |
| 5 V (at 100 mA) | 100 mV (at 10 mA) |
| 6 A | 50 mA |
| (on request) | 50 mA |
| 10 mA (at 12 V) | 1 mA (at 24 V) |
| 4 kV (50 Hz, 1 min.) | |
| -20°C ... 55°C | |
| 2 x 10 ⁷ cycles | |
| IEC 60664, EN 50178, IEC 62103 | |
| 3 / III | |
| 0.14 - 2.5 mm ² / 0.14 - 2.5 mm ² / 26 - 14 | |
| 6.2 mm / 80 mm / 94 mm | |

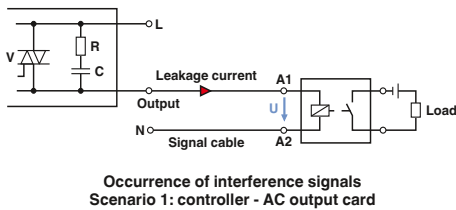

| Description | Voltage U_N |
|--|---------------|
| PLC-INTERFACE basic terminal block , for plug-in miniature relays or solid-state relays | |
| With screw connection | 120 V AC |
| With screw connection | 230 V AC |
| With spring-cage connection | 120 V AC |
| With spring-cage connection | 230 V AC |
| With push-in connection | 120 V AC |
| With push-in connection | 230 V AC |

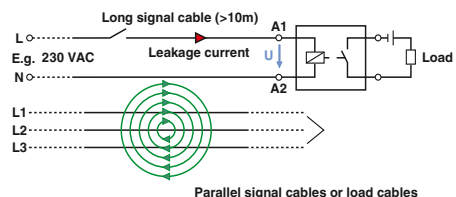

| Plug-in miniature relays |
|--------------------------|
| with gold contact |
| with power contact |

| Ordering data | | | |
|-------------------------------------|-----------|-------------|--|
| Type | Order No. | Pcs. / Pkt. | |
| PLC-BSC-120UC/21/SO46 ¹⁾ | 2980319 | 10 | |
| PLC-BSC-230UC/21/SO46 ¹⁾ | 2980335 | 10 | |
| PLC-BSP-120UC/21/SO46 ¹⁾ | 2980351 | 10 | |
| PLC-BSP-230UC/21/SO46 ¹⁾ | 2980377 | 10 | |
| PLC-BPT-120UC/21/SO46 ¹⁾ | 2900453 | 10 | |
| PLC-BPT-230UC/21/SO46 ¹⁾ | 2900455 | 10 | |

| Accessories | | |
|-------------------|---------|----|
| REL-MR- 60DC/21AU | 2961134 | 10 |
| REL-MR- 60DC/21 | 2961118 | 10 |

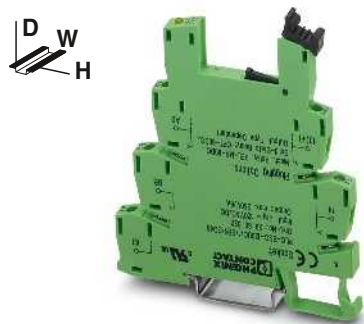

Sensor design

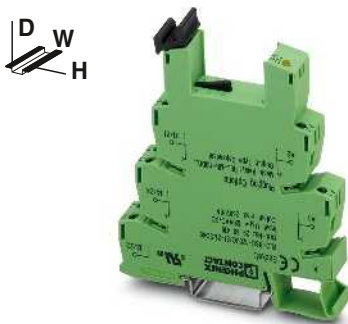

2 PDT universal design

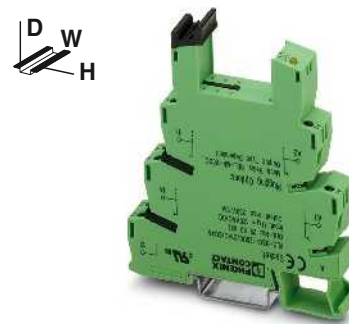

1 PDT for high continuous currents

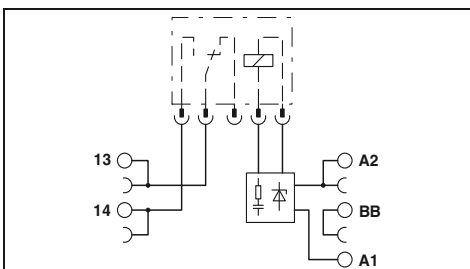

Technical data

| | |
|---|-------------------------------|
| 120 V AC | 230 V AC |
| 0.8 ... 1.4 | 0.78 ... 1.14 |
| 50 V AC | 80 V AC |
| 7 mA / 8 mA | 8.8 mA / 10 mA |
| 7 ms | 7 ms |
| 20 ms | 20 ms |
| Yellow LED, Bridge rectifier, Filter | |
| REL-MR-60DC/21 | REL-MR-60DC/21AU |
| Single contact, 1 N/O contact | Single contact, 1 N/O contact |
| AgSnO | AgSnO, hard gold-plated |
| 250 V AC/DC | 30 V AC / 36 V DC |
| 5 V (at 100 mA) | 100 mV (at 10 mA) |
| 6 A | 50 mA |
| (on request) | 50 mA |
| 10 mA (at 12 V) | 1 mA (at 24 V) |
| 4 kV (50 Hz, 1 min.) | |
| -20°C ... 55°C | |
| 2 x 10 ⁷ cycles | |
| IEC 60664, EN 50178, IEC 62103 | |
| 3 / III | |
| 0.14 - 2.5 mm ² / 0.14 - 2.5 mm ² / 26 - 14 | |
| 6.2 mm / 80 mm / 94 mm | |

Ordering data

| Type | Order No. | Pcs. / Pkt. |
|---|-----------|-------------|
| PLC-BSC-120UC/ 1/SEN/SO46 ¹⁾ | 2980322 | 10 |
| PLC-BSC-230UC/ 1/SEN/SO46 ¹⁾ | 2980348 | 10 |
| PLC-BSP-120UC/ 1/SEN/SO46 ¹⁾ | 2980364 | 10 |
| PLC-BSP-230UC/ 1/SEN/SO46 ¹⁾ | 2980380 | 10 |
| PLC-BPT-120UC/ 1/SEN/SO46 ¹⁾ | 2900456 | 10 |
| PLC-BPT-230UC/ 1/SEN/SO46 ¹⁾ | 2900457 | 10 |

Accessories

| | | |
|-------------------|---------|----|
| REL-MR- 60DC/21AU | 2961134 | 10 |
| REL-MR- 60DC/21 | 2961118 | 10 |

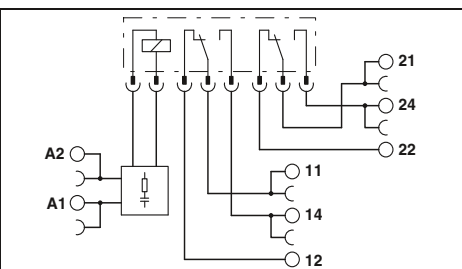

Technical data

| | |
|---|-----------------------|
| 120 V AC | 230 V AC |
| 0.78 ... 1.4 | 0.78 ... 1.14 |
| 16 V AC | 70 V AC |
| 6 mA / 7 mA | 8.5 mA / 10 mA |
| 7 ms | 7 ms |
| 10 ms | 10 ms |
| Yellow LED, Bridge rectifier, Filter | |
| REL-MR-110DC/21-21 | REL-MR-110DC/21-21AU |
| Single contact, 2-PDT | Single contact, 2-PDT |
| AgNi | AgNi, + 5 µm Au |
| 250 V AC/DC | 30 V AC / 36 V DC |
| 5 V AC/DC | 100 mV |
| 6 A | 50 mA |
| 15 A (300 ms) | 50 mA |
| 10 mA | 1 mA |
| 4 kV (50 Hz, 1 min.) | |
| -20°C ... 55°C | |
| 3 x 10 ⁷ cycles | |
| IEC 60664, EN 50178, IEC 62103 | |
| 3 / III | |
| 0.14 - 2.5 mm ² / 0.14 - 2.5 mm ² / 26 - 14 | |
| 14 mm / 80 mm / 94 mm | |

Ordering data

| Type | Order No. | Pcs. / Pkt. |
|--|-----------|-------------|
| PLC-BSC-120UC/21-21/SO46 ¹⁾ | 2980416 | 10 |
| PLC-BSC-230UC/21-21/SO46 ¹⁾ | 2980429 | 10 |

Accessories

| | | |
|----------------------|---------|----|
| REL-MR-110DC/21-21AU | 2961228 | 10 |
| REL-MR-110DC/21-21 | 2961202 | 10 |

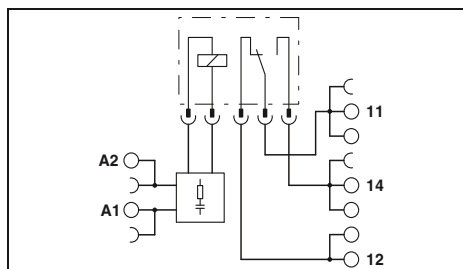

Technical data

| | |
|---|-----------------------|
| 120 V AC | 230 V AC |
| 0.85 ... 1.4 | 0.78 ... 1.14 |
| 16 V AC | 70 V AC |
| 6 mA / 7 mA | 8.5 mA / 10 mA |
| 7 ms | 7 ms |
| 20 ms | 20 ms |
| Yellow LED, Bridge rectifier, Filter | |
| REL-MR-110DC/21HC | REL-MR-110DC/21AU |
| Single contact, 1-PDT | Single contact, 1-PDT |
| AgNi | AgNi |
| 250 V AC/DC | 30 V AC / 36 V DC |
| 12 V AC/DC | 100 mV |
| 10 A | 50 mA |
| 30 A (300 ms) | 50 mA |
| 100 mA | 1 mA |
| 4 kV (50 Hz, 1 min.) | |
| -20°C ... 55°C | |
| 3 x 10 ⁷ cycles | |
| IEC 60664, EN 50178, IEC 62103 | |
| 3 / III | |
| 0.14 - 2.5 mm ² / 0.14 - 2.5 mm ² / 26 - 14 | |
| 14 mm / 80 mm / 94 mm | |

Ordering data

| Type | Order No. | Pcs. / Pkt. |
|---------------------------------------|-----------|-------------|
| PLC-BSC-120UC/21HC/SO46 ¹⁾ | 2980432 | 10 |
| PLC-BSC-230UC/21HC/SO46 ¹⁾ | 2980445 | 10 |

Accessories

| | | |
|-------------------|---------|----|
| REL-MR-110DC/21HC | 2961338 | 10 |
|-------------------|---------|----|

Relay modules

PLC series

Basic terminal blocks with interference current filter that can be fitted with solid-state relays

PLC basic terminal blocks with integrated filter to protect against interference voltages or currents due, for example, to long control lines

The advantages:

- Resistant to interference currents
- High relay release voltage

Typical applications:

- Applications with long control lines
- Use of AC output boards, resulting in residual AC currents
- Screw, spring-cage, and push-in technology

| Notes: |
|---|
| Type of housing: Polyamide PA non-reinforced, color: green. |
| Marking systems and mounting material See Catalog 5 |
| Separating plate PLC-ATP must be installed for voltages larger than 250 V (L1, L2, L3) between identical terminal blocks in adjacent modules. Potential bridging is then carried out with FBST 8-PLC... or FBST 500.... |
| For derating curves see page 345 |
| 1) EMC: Class A product, see page 571 |



Universal design



| Input data |
|---|
| Nominal input voltage U_N |
| Permissible range (with reference to U_N) |
| Switching level (with optocoupler) 0 signal ("L") |
| Typ. input current with U_N (50 / 60 Hz) |
| Typ. response time/switch-on time at U_N |
| Typ. switch-off time at U_N |
| Input circuit |
| Output data with: |
| Max. switching voltage |
| Min. switching voltage |
| Limiting continuous current |
| Max. inrush current |
| Output protection |
| Voltage drop at limiting continuous current |
| Leakage current in off state |
| Max. phase shift (inductive consumer) |
| Max. load value $I^2 \times t$ ($t = 10$ ms) |
| General data |
| Test voltage input/output |
| Ambient temperature (operation) |
| Standards/regulations |
| Pollution degree / Surge voltage category |
| Connection data solid / stranded / AWG |
| Dimensions |

| Technical data | | |
|---|--|----------------------|
| 120 V AC | 230 V AC | |
| 0.85 ... 1.1 | 0.8 ... 1.1 | |
| ≤ 0.4 | ≤ 0.4 | |
| 7 mA / 8 mA | 8.8 mA / 10 mA | |
| 6 ms | 6 ms | |
| 10 ms | 10 ms | |
| Yellow LED, Bridge rectifier, Filter | | |
| OPT...48DC/... | OPT...24DC/... | OPT...230AC/... |
| 48 V DC | 30 V DC | 253 V AC |
| 3 V DC | 3 V DC | 24 V AC |
| 100 mA | 3 A | 0.75 A |
| | 15 A (10 ms) | 30 A (10 ms) |
| Protection against polarity reversal, Surge protection | Protection against polarity reversal, Surge protection | RCV circuit |
| < 1 V DC | < 200 mV | < 1 V AC |
| - | - | < 1 mA |
| - | - | 0.5 |
| - | - | 4.5 A ² s |
| 2.5 kV (50 Hz, 1 min.) | | |
| -20°C ... 55°C | | |
| IEC 60664, EN 50178, IEC 62103 | | |
| 2 / III | | |
| 0.14 - 2.5 mm ² / 0.14 - 2.5 mm ² / 26 - 14 | | |
| 6.2 mm / 80 mm / 94 mm | | |

| Description | Voltage U_N |
|--|---------------|
| PLC-INTERFACE basic terminal block , for plug-in miniature relays or solid-state relays | |
| With screw connection | 120 V AC |
| With screw connection | 230 V AC |
| With spring-cage connection | 120 V AC |
| With spring-cage connection | 230 V AC |
| With push-in connection | 120 V AC |
| With push-in connection | 230 V AC |

| Ordering data | | | |
|------------------------------------|-----------|-------------|--|
| Type | Order No. | Pcs. / Pkt. | |
| PLC-BSC-120UC/21/SO46 ¹ | 2980319 | 10 | |
| PLC-BSC-230UC/21/SO46 ¹ | 2980335 | 10 | |
| PLC-BSP-120UC/21/SO46 ¹ | 2980351 | 10 | |
| PLC-BSP-230UC/21/SO46 ¹ | 2980377 | 10 | |
| PLC-BPT-120UC/21/SO46 ¹ | 2900453 | 10 | |
| PLC-BPT-230UC/21/SO46 ¹ | 2900455 | 10 | |

| Plug-in solid-state relays | |
|----------------------------|--|
| Solid-state input relays | |
| Solid-state power relays | |
| Solid-state power relays | |

| Accessories | | |
|--------------------|---------|----|
| OPT-60DC/ 48DC/100 | 2966621 | 10 |
| OPT-60DC/ 24DC/ 2 | 2966605 | 10 |
| OPT-60DC/230AC/ 1 | 2967963 | 10 |



Sensor design

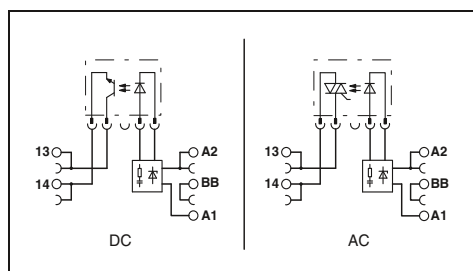

Technical data

| | |
|--|----------------|
| 120 V AC | 230 V AC |
| 0.85 ... 1.1 | 0.8 ... 1.1 |
| ≤ 0.4 | ≤ 0.4 |
| 7 mA / 8 mA | 8.8 mA / 10 mA |
| 6 ms | 6 ms |
| 10 ms | 10 ms |
| Yellow LED, Bridge rectifier, Filter | |
| OPT...48DC/... | OPT...24DC/... |
| 48 V DC | 30 V DC |
| 3 V DC | 3 V DC |
| 100 mA | 3 A |
| | 15 A (10 ms) |
| Protection against polarity reversal, Surge protection | RCV circuit |
| < 1 V | < 200 mV |
| - | < 1 mA |
| - | 0.5 |
| - | 4.5 A²s |

2.5 kV (50 Hz, 1 min.)
 -20°C ... 55°C
 IEC 60664, EN 50178, IEC 62103
 2 / III
 0.14 - 2.5 mm² / 0.14 - 2.5 mm² / 26 - 14
 6.2 mm / 80 mm / 94 mm

Ordering data

| Type | Order No. | Pcs. / Pkt. |
|-----------------------------|-----------|-------------|
| PLC-BSC-120UC/ 1/SEN/SO46¹) | 2980322 | 10 |
| PLC-BSC-230UC/ 1/SEN/SO46¹) | 2980348 | 10 |
| PLC-BSP-120UC/ 1/SEN/SO46¹) | 2980364 | 10 |
| PLC-BSP-230UC/ 1/SEN/SO46¹) | 2980380 | 10 |
| PLC-BPT-120UC/ 1/SEN/SO46¹) | 2900456 | 10 |
| PLC-BPT-230UC/ 1/SEN/SO46¹) | 2900457 | 10 |

Accessories

| Accessories | Order No. | Pcs. / Pkt. |
|--------------------|-----------|-------------|
| OPT-60DC/ 48DC/100 | 2966621 | 10 |
| OPT-60DC/ 24DC/ 2 | 2966605 | 10 |
| OPT-60DC/230AC/ 1 | 2967963 | 10 |

Plug-in miniature power relays

Plug-in miniature power relays suitable for PLC-INTERFACE and RIF-0, RIF-1, and PR1 relay bases.

The advantages:

- Power contacts up to 16 A
- Multi-layer gold contact or power contact
- High degree of protection up to RT III (comparable with IP67) depending on type
- Safe isolation according to DIN EN 50178 between coil and contact

| Notes: |
|---|
| If the specified maximum values for multi-layer contact relays are exceeded, the gold plating is destroyed. The maximum values of the power contact relay are then valid. This can result in a shorter service life than with a pure power contact. |
| For dimensional drawings and perforations for assembly, see page 344 |
| For diagrams of operating voltage ranges, see page 343 |



1 PDT



| Input data | | Technical data | | | | |
|--|-----------|---------------------------------|---------|-----|-------------------------|-------|
| Permissible range (with reference to U_N) | | ① | ② | ③ | ④ | ⑤ |
| Typ. input current at U_N | [mA] | refer to the diagram | | | | |
| Typ. response time at U_N | [ms] | 38 | 14 | 9 | 7 | 3 |
| Typ. release time at U_N | [ms] | 5 | 5 | 5 | 5 | 5 |
| Output data | | 2.5 | 2.5 | 2.5 | 2.5 | 2.5 |
| Contact type | | Single contact, 1-PDT | | | Single contact, 1-PDT | |
| Contact material | | AgSnO | | | AgSnO, hard gold-plated | |
| Max. switching voltage | | 250 V AC/DC | | | 30 V AC / 36 V DC | |
| Min. switching voltage | | 5 V (at 100 mA) | | | 100 mV (at 10 mA) | |
| Limiting continuous current | | 6 A | | | 50 mA | |
| Max. inrush current | | (on request) | | | (on request) | |
| Min. switching current | | 10 mA (at 12 V) | | | 1 mA (at 24 V) | |
| Max. interrupting rating, ohmic load | | 24 V DC | 140 W | | | 1.2 W |
| | | 48 V DC | 20 W | | | - |
| | | 60 V DC | 18 W | | | - |
| | | 110 V DC | 23 W | | | - |
| | | 220 V DC | 40 W | | | - |
| | | 250 V AC | 1500 VA | | | - |
| General data | | 4 kV AC (50 Hz, 1 min.) | | | | |
| Test voltage (winding / contact) | | -40°C ... 85°C | | | | |
| Ambient temperature (operation) | | 100% operating factor | | | | |
| Nominal operating mode | | 2 x 10 ⁷ cycles | | | | |
| Mechanical service life | | IEC 60664, EN 50178, IEC 62103 | | | | |
| Standards/regulations | | Any / In rows with zero spacing | | | | |
| Mounting position/mounting | | Dimensions | | | | |
| | W / H / D | 5 mm / 28 mm / 15 mm | | | | |

| Ordering data | | Type | Order No. | Pcs. / Pkt. |
|---------------------------------------|---|-------------------|-----------|-------------|
| Plug-in miniature power relays | | | | |
| with power contact | ① | REL-MR- 4,5DC/21 | 2961367 | 10 |
| with power contact | ② | REL-MR- 12DC/21 | 2961150 | 10 |
| with power contact | ③ | REL-MR- 18DC/21 | 2961383 | 10 |
| with power contact | ④ | REL-MR- 24DC/21 | 2961105 | 10 |
| with power contact | ⑤ | REL-MR- 60DC/21 | 2961118 | 10 |
| with power contact | ⑥ | | | |
| Plug-in miniature power relays | | | | |
| with gold contact | ① | REL-MR 4,5DC/21AU | 2961370 | 10 |
| with gold contact | ② | REL-MR- 12DC/21AU | 2961163 | 10 |
| with gold contact | ③ | REL-MR- 18DC/21AU | 2961493 | 10 |
| with gold contact | ④ | REL-MR- 24DC/21AU | 2961121 | 10 |
| with gold contact | ⑤ | REL-MR- 60DC/21AU | 2961134 | 10 |
| with gold contact | ⑥ | | | |



2 PDT



1 N/O contact, for high inrush currents



1 PDT for high continuous currents

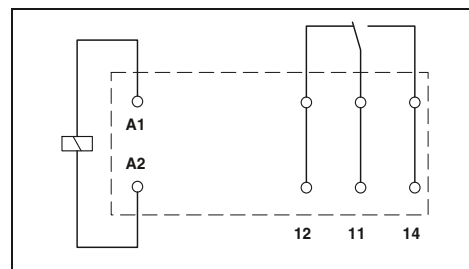
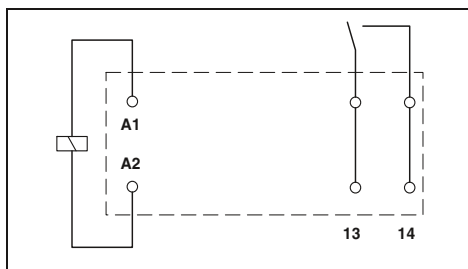
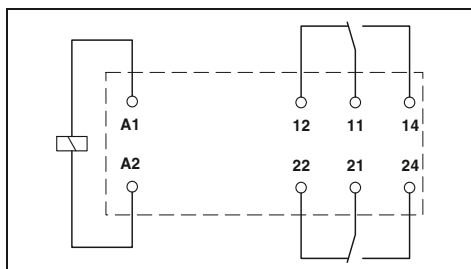

Technical data

Technical data

Technical data

| ② | ④ | ⑤ | ⑥ |
|----------------------|----|-----|-----|
| refer to the diagram | | | |
| 33 | 17 | 8.2 | 4.1 |
| 7 | 7 | 7 | 7 |
| 3 | 3 | 3 | 3 |

| ④ |
|----------------------|
| refer to the diagram |
| 17 |
| 8 |
| 3 |

| ② | ④ | ⑤ | ⑥ |
|----------------------|----|-----|-----|
| refer to the diagram | | | |
| 33 | 17 | 8.2 | 4.1 |
| 7 | 7 | 7 | 7 |
| 3 | 3 | 3 | 3 |

Single contact, 2-PDT

Single contact, 1 N/O contact

Single contact, 1-PDT

AgNi
250 V AC/DC
5 V (at 10 mA)
8 A
25 A (20 ms)
10 mA (At 5 V)

AgSnO
250 V AC/DC
12 V (at 100 mA)
16 A
80 A (20 ms)
100 mA (at 12 V DC)

AgNi
250 V AC/DC
12 V (at 10 mA)
16 A
30 A (300 ms)
100 mA

190 W
85 W
60 W
44 W
60 W
2000 VA

384 W
58 W
48 W
50 W
80 W
4000 VA

384 W
58 W
48 W
50 W
80 W
4000 VA

5 kV AC (50 Hz, 1 min.)
-40°C ... 85°C
100% operating factor
3 x 10⁷ cycles
IEC 60664, EN 50178, IEC 62103
Any / Can be aligned without spacing (> 70°C ≥ 2.5 mm)

5 kV AC (50 Hz, 1 min.)
-40°C ... 85°C
100% operating factor
3 x 10⁷ cycles
IEC 60664, EN 50178, IEC 62103
Any / Can be aligned without spacing (> 70°C ≥ 2.5 mm)

5 kV AC (50 Hz, 1 min.)
-40°C ... 85°C
100% operating factor
3 x 10⁷ cycles
IEC 60664, EN 50178, IEC 62103
Any / Can be aligned without spacing (> 70°C ≥ 2.5 mm)

12.7 mm / 29 mm / 15.7 mm

12.7 mm / 29 mm / 15.7 mm

12.7 mm / 29 mm / 15.7 mm

Ordering data

Ordering data

Ordering data

| Type | Order No. | Pcs. / Pkt. |
|----------------------|-----------|-------------|
| REL-MR- 12DC/21-21 | 2961257 | 10 |
| REL-MR- 24DC/21-21 | 2961192 | 10 |
| REL-MR- 60DC/21-21 | 2961273 | 10 |
| REL-MR-110DC/21-21 | 2961202 | 10 |
| REL-MR- 12DC/21-21AU | 2961299 | 10 |
| REL-MR- 24DC/21-21AU | 2961215 | 10 |
| REL-MR- 60DC/21-21AU | 2961286 | 10 |
| REL-MR-110DC/21-21AU | 2961228 | 10 |

| Type | Order No. | Pcs. / Pkt. |
|------------------|-----------|-------------|
| REL-MR- 24DC/11C | 2961341 | 10 |

| Type | Order No. | Pcs. / Pkt. |
|-------------------|-----------|-------------|
| REL-MR- 12DC/21HC | 2961309 | 10 |
| REL-MR- 24DC/21HC | 2961312 | 10 |
| REL-MR- 60DC/21HC | 2961325 | 10 |
| REL-MR-110DC/21HC | 2961338 | 10 |

Plug-in solid-state relays

Plug-in solid-state relays suitable for PLC-INTERFACE and RIF-0, RIF-1, and PR1 relay bases.

The advantages:

- Switching capacity of up to 24 V DC/5 A
- RT III wash tight (comparable to IP67)
- Vibration- and shock-resistant
- Wear-free and long-lasting
- Zero voltage switch at AC output
- Can be soldered in on PCB



Max. DC voltage output of 3 A



Max. DC voltage output of 100 mA

Notes:

For dimensional drawings and perforations for assembly, see page 345

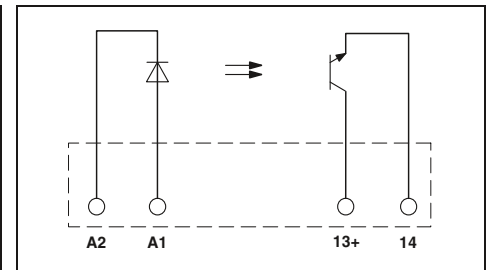
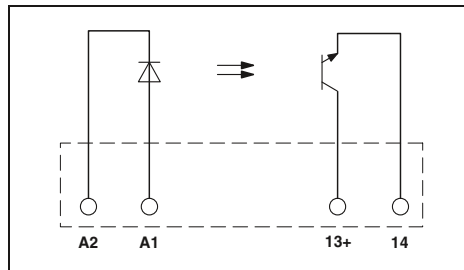

Technical data

Technical data

| | |
|--|--|
| Input data | |
| Permissible range (with reference to U_N) | |
| Switching level | 1 signal ("H") [V DC] \geq 0 signal ("L") [V DC] \leq |
| Typ. input current at U_N | [mA] |
| Typ. switch-on time at U_N | [μ s] |
| Typ. switch-off time at U_N | [μ s] |
| Transmission frequency f_{emit} | [Hz] |
| Output data | |
| Max. switching voltage | 33 V DC |
| Min. switching voltage | 3 V DC |
| Limiting continuous current | 3 A (see derating curve) |
| Min. load current | - |
| Max. inrush current | 15 A (10 ms) |
| Leakage current in off state | - |
| Phase angle (cos ϕ) | - |
| Output circuit | 2-conductor, floating |
| Max. load value | - |
| Output protection | Protection against polarity reversal, Surge protection |
| Voltage drop at max. limiting continuous current | \leq 150 mV |
| General data | |
| Rated surge voltage | Basic insulation |
| Test voltage input/output | 2.5 kV (50 Hz, 1 min.) |
| Ambient temperature (operation) | -25°C ... 60°C |
| Nominal operating mode | 100% operating factor |
| Standards/regulations | IEC 60664, EN 50178, IEC 62103 |
| Pollution degree/surge voltage category | 2 / III |
| Mounting position/mounting | Any / In rows with zero spacing |
| Dimensions | 5 mm / 28 mm / 15 mm |

| | | |
|--|-----------|-----------|
| ① | ② | ③ |
| 0.8 - 1.2 | 0.8 - 1.2 | 0.8 - 1.2 |
| 2.5 | 16 | 35 |
| 0.8 | 10 | 20 |
| 9 | 7 | 3 |
| 20 | 20 | 40 |
| 300 | 300 | 500 |
| 300 | 300 | 300 |
| Technical data | | |
| ① | ② | ③ |
| 0.8 - 1.2 | 0.8 - 1.2 | 0.9 - 1.1 |
| 2.5 | 16 | 52 |
| 0.8 | 10 | 40 |
| 4 | 7 | 3 |
| 20 | 20 | 50 |
| 300 | 300 | 800 |
| 300 | 300 | 100 |
| Technical data | | |
| 48 V DC | | |
| 3 V DC | | |
| 100 mA | | |
| - | | |
| - | | |
| - | | |
| - | | |
| 2-conductor, floating | | |
| - | | |
| Protection against polarity reversal, Surge protection | | |
| \leq 1 V | | |
| General data | | |
| Basic insulation | | |
| 2.5 kV (50 Hz, 1 min.) | | |
| -25°C ... 60°C | | |
| 100% operating factor | | |
| IEC 60664, EN 50178, IEC 62103 | | |
| 2 / III | | |
| Any / In rows with zero spacing | | |
| 5 mm / 28 mm / 15 mm | | |

Ordering data

Ordering data

| Description | Input voltage U_N |
|-----------------------------------|---------------------|
| Plug-in solid-state relays | |
| Solid-state power relays | ① 5 V DC |
| Solid-state power relays | ② 24 V DC |
| Solid-state power relays | ③ 60 V DC |
| Plug-in solid-state relays | |
| Solid-state input relays | ① 5 V DC |
| Solid-state input relays | ② 24 V DC |
| Solid-state input relays | ③ 60 V DC |

| Type | Order No. | Pcs. / Pkt. |
|-------------------|-----------|-------------|
| OPT-5DC/ 24DC/ 2 | 2967989 | 10 |
| OPT-24DC/ 24DC/ 2 | 2966595 | 10 |
| OPT-60DC/ 24DC/ 2 | 2966605 | 10 |

| Type | Order No. | Pcs. / Pkt. |
|--------------------|-----------|-------------|
| OPT-5DC/ 48DC/100 | 2967992 | 10 |
| OPT-24DC/ 48DC/100 | 2966618 | 10 |
| OPT-60DC/ 48DC/100 | 2966621 | 10 |



Max. DC voltage output of 5 A



Max. AC voltage output of 750 mA



Max. AC voltage output of 2 mA



Technical data

| ① | ② | ③ |
|-------|-------|-------|
| 0.8 - | 0.8 - | 0.9 - |
| 1.2 | 1.2 | 1.1 |
| 2.5 | 16 | 35 |
| 0.8 | 10 | 20 |
| 9 | 7 | 3 |
| 10 | 20 | 25 |
| 400 | 400 | 400 |
| 300 | 300 | 300 |

33 V DC
 3 V DC
 5 A (see derating curve)
 -
 15 A (10 ms)
 -
 2-conductor, floating
 -
 Protection against polarity reversal, Surge protection
 ≤ 200 mV

Basic insulation
 2.5 kV (50 Hz, 1 min.)
 -25°C ... 60°C
 100% operating factor
 IEC 60664, EN 50178, IEC 62103
 2 / III
 Any / In rows with zero spacing
 12.7 mm / 29 mm / 15.7 mm

Ordering data

| Type | Order No. | Pcs. / Pkt. |
|-------------------|-----------|-------------|
| OPT- 5DC/ 24DC/ 5 | 2982113 | 10 |
| OPT-24DC/ 24DC/ 5 | 2982100 | 10 |
| OPT-60DC/ 24DC/ 5 | 2982126 | 10 |

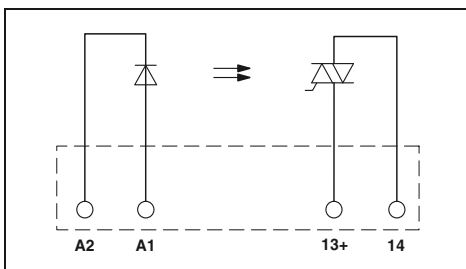

Technical data

| ② | ③ |
|-------|-------|
| 0.8 - | 0.9 - |
| 1.2 | 1.1 |
| 10 | 50 |
| 5 | 15 |
| 3 | 3 |
| 6000 | 9000 |
| 500 | 700 |
| 10 | 10 |

253 V AC
 24 V AC
 0.75 A (see derating curve)
 10 mA
 30 A (10 ms)
 < 1 mA
 0.5
 2-conductor floating, zero voltage switch
 4.5 A²s
 RCV circuit
 < 1 V

Basic insulation
 2.5 kV (50 Hz, 1 min.)
 -25°C ... 60°C
 100% operating factor
 IEC 60664, EN 50178, IEC 62103
 2 / III
 Any / In rows with zero spacing
 5 mm / 28 mm / 15 mm

Ordering data

| Type | Order No. | Pcs. / Pkt. |
|-------------------|-----------|-------------|
| OPT-24DC/230AC/ 1 | 2967950 | 10 |
| OPT-60DC/230AC/ 1 | 2967963 | 10 |

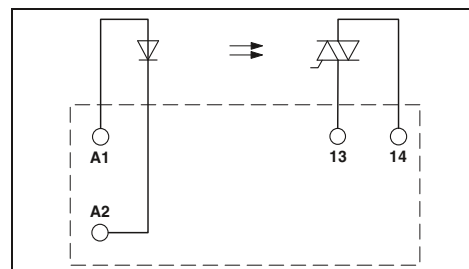

Technical data

| ① | ② | ③ |
|-------|-------|-------|
| 0.8 - | 0.8 - | 0.9 - |
| 1.2 | 1.2 | 1.1 |
| 3 | 18 | 40 |
| 1 | 8.4 | 20 |
| 15 | 7 | 2.6 |
| 10000 | 10000 | 10000 |
| 10000 | 10000 | 10000 |
| 10 | 10 | 10 |

253 V AC
 24 V AC
 2 A (see derating curve)
 25 mA
 30 A (10 ms)
 < 1 mA
 -
 2-conductor floating, zero voltage switch
 4 A²s (tp = 10 ms, at 25°C)
 Surge protection
 ≤ 1 V

Basic insulation
 2.5 kV (50 Hz, 1 min.)
 -25°C ... 60°C
 100% operating factor
 IEC 60664
 2 / III
 Any / See derating curve
 12.7 mm / 29 mm / 15.7 mm

Ordering data

| Type | Order No. | Pcs. / Pkt. |
|-------------------|-----------|-------------|
| OPT- 5DC/230AC/ 2 | 2982168 | 10 |
| OPT-24DC/230AC/ 2 | 2982171 | 10 |
| OPT-60DC/230AC/ 2 | 2982184 | 10 |

Relay modules

Tables, diagrams, dimensional drawings

Relay options for PLC basic terminal blocks

| Relay and solid-state relay options | Push-in connection | | Spring-cage connection | | Screw connection | |
|-------------------------------------|----------------------------|---------|-------------------------------|---------|-----------------------|---------|
| | 1 PDT basic terminal block | | | | | |
| | PLC-BPT-5DC/21 | 2900443 | PLC-BSP-5DC/21 | 2980238 | PLC-BSC-5DC/21 | 2980225 |
| REL-MR-4,5DC/21 | X | | PLC-BPT-12DC/21 | 2900444 | PLC-BSP-12DC/21 | 2987426 |
| REL-MR-4,5DC/21AU | X | | PLC-BPT-24DC/21 | 2900445 | PLC-BSP-24DC/21 | 2967219 |
| REL-MR-12DC/21 | | X | PLC-BPT-24UC/21 | 2900446 | PLC-BSP-24UC/21 | 2967222 |
| REL-MR-12DC/21AU | | X | PLC-BPT-48DC/21 | 2900447 | PLC-BSP-48DC/21 | 2967329 |
| REL-MR-24DC/21 | | X | PLC-BPT-60DC/21 | 2900279 | PLC-BSP-60DC/21 | 2967332 |
| REL-MR-24DC/21AU | | X | PLC-BPT-120DC/21 | 2900280 | PLC-BSP-120DC/21 | 2967167 |
| REL-MR-60DC/21 | | X | PLC-BPT-230DC/21 | 2900281 | PLC-BSP-230DC/21 | 2967183 |
| REL-MR-60DC/21AU | | X | 2 PDT basic terminal block | | PLC-BSC-125DC/21 | 2980018 |
| REL-MR-24DC/1IC | | X | PLC-BPT-12DC/21-21 | 2900282 | PLC-BSC-230DC/21 | 2966045 |
| REL-MR-18DC/21 | | X | PLC-BPT-12DC/21-21AU | 2900283 | PLC-BSP-12DC/21-21 | 2912426 |
| REL-MR-18DC/21AU | | X | PLC-BPT-24DC/21-21 | 2900284 | PLC-BSP-24DC/21-21 | 2912439 |
| REL-MR-12DC/21-21 | | X | PLC-BPT-24UC/21-21 | 2900285 | PLC-BSC-24DC/21-21 | 2967015 |
| REL-MR-12DC/21-21AU | | X | PLC-BPT-48DC/21-21 | 2900286 | PLC-BSC-24UC/21-21 | 2967028 |
| REL-MR-24DC/21-21 | | X | PLC-BPT-48DC/21-21AU | 2900287 | PLC-BSC-48DC/21-21 | 2967264 |
| REL-MR-24DC/21-21AU | | X | PLC-BPT-60DC/21-21 | 2900288 | PLC-BSC-48DC/21-21 | 2967264 |
| REL-MR-60DC/21-21 | | X | PLC-BPT-60DC/21-21AU | 2900289 | PLC-BSC-60DC/21-21 | 2967316 |
| REL-MR-60DC/21-21AU | | X | PLC-BPT-120DC/21-21 | 2900290 | PLC-BSC-60DC/21-21 | 2967031 |
| REL-MR-110DC/21-21 | | X | PLC-BPT-120DC/21-21AU | 2900291 | PLC-BSC-120DC/21-21 | 2967031 |
| REL-MR-110DC/21-21AU | | X | PLC-BPT-230DC/21-21 | 2900292 | PLC-BSC-230DC/21-21 | 2967044 |
| REL-MR-12DC/21HC | | X | HC basic terminal block | | PLC-BSC-12DC/21HC | 2967769 |
| REL-MR-24DC/21HC | | X | PLC-BPT-12DC/21HC | 2900253 | PLC-BSP-12DC/21HC | 2912332 |
| REL-MR-60DC/21HC | | X | PLC-BPT-24DC/21HC | 2900254 | PLC-BSP-24DC/21HC | 2912345 |
| REL-MR-110DC/21HC | | X | PLC-BPT-24UC/21HC | 2900255 | PLC-BSP-24UC/21HC | 2967772 |
| OPT-24DC/230AC/1 | | X | PLC-BPT-48DC/21HC | 2900256 | PLC-BSP-48DC/21HC | 2967785 |
| OPT-60DC/230AC/1 | | X | PLC-BPT-48DC/21HC | 2900257 | PLC-BSP-48DC/21HC | 2967798 |
| OPT-5DC/24DC/2 | | X | PLC-BPT-60DC/21HC | 2900258 | PLC-BSP-60DC/21HC | 2967808 |
| OPT-24DC/24DC/2 | | X | PLC-BPT-120DC/21HC | 2900259 | PLC-BSP-120DC/21HC | 2967811 |
| OPT-60DC/24DC/2 | | X | PLC-BPT-230DC/21HC | 2900260 | PLC-BSP-230DC/21HC | 2967824 |
| OPT-5DC/48DC/100 | | X | Sensor basic terminal block | | PLC-BSC-5DC/1/SEN | 2980267 |
| OPT-24DC/48DC/100 | | X | PLC-BPT-24DC/1/SEN | 2900262 | PLC-BSP-24DC/1/SEN | 2967206 |
| OPT-60DC/48DC/100 | | X | PLC-BPT-120UC/1/SEN | 2900451 | PLC-BSP-120UC/1/SEN | 2966061 |
| OPT-24DC/24DC/5 | | X | PLC-BPT-230UC/1/SEN | 2900452 | PLC-BSP-230UC/1/SEN | 2966074 |
| OPT-60DC/24DC/5 | | X | Actuator basic terminal block | | PLC-BSC-230UC/1/SEN | 2966087 |
| OPT-24DC/230AC/2 | | X | PLC-BPT-5DC/1/ACT | 2900448 | PLC-BSP-5DC/1/ACT | 2980254 |
| OPT-60DC/230AC/2 | | X | PLC-BPT-24DC/1/ACT | 2900449 | PLC-BSP-24DC/1/ACT | 2967196 |
| | | X | PLC-BPT-24UC/1/ACT | 2900450 | PLC-BSP-24UC/1/ACT | 2962809 |
| | | X | PLC-BPT-24DC/2/IRW | 2900261 | PLC-BSP-24DC/2/IRW | 2961396 |
| | | X | IC basic terminal block | | PLC-BSC-5DC/1/ACT | 2980241 |
| | | X | PLC-BPT-24DC/1/IC/ACT | 2900260 | PLC-BSP-24DC/1/IC/ACT | 2966068 |
| | | X | PLC-BPT-24DC/1/IC/ACT | 2912400 | PLC-BSC-24DC/1/IC/ACT | 2982799 |
| | | X | PLC-BPT-24DC/1/IC/ACT | 2912400 | PLC-BSC-24DC/1/IC/ACT | 2967837 |

Operating voltage ranges for PLC-INTERFACE, 6.2 mm versions, equipped with relay



Operating voltage ranges for PLC-INTERFACE, 14 mm versions, equipped with relay



General conditions:
Direct alignment in the block, all devices 100% operating time, horizontal or vertical mounting.

Curve A
Maximum permissible continuous voltage U_{max} , with limiting continuous current on the contact side (see relevant technical data).

Curve B
Minimum permissible operate voltage U_{op} after pre-excitation¹⁾ (see relevant technical data).

^{1) Pre-excitation:} relay has been operated in a thermally steady state at the ambient temperature T_A with nominal voltage U_N and limiting continuous current on the contact side (see relevant technical data) (warm coil). After being switched off for a short time, the relay must reliably pick up again at U_{op} . The U_{op} values for cold coils ($T_{coil} = T_A = 20^\circ\text{C}$) indicated by other manufacturers yield better values, but are not practical.

Relay modules

Tables, diagrams, dimensional drawings

Plug-in miniature power relays

REL-MR...21

5 mm design width

Perforations for assembly: view of the connections



Pitch division: 1.25 mm and 1.27 mm



Permissible input voltage range for REL-MR...21



General conditions:

Direct alignment in the block, all devices 100% operating time, horizontal or vertical mounting.

Curve A

Maximum permissible continuous voltage U_{max} with limiting continuous current on the contact side (see relevant technical data).

Curve B

Minimum permissible operate voltage U_{op} after pre-excitation¹⁾ (see relevant technical data).

¹⁾ **Pre-excitation:** relay has been operated in a thermally steady state at the ambient temperature T_A with nominal voltage U_N and limiting continuous current on the contact side (see relevant technical data) (warm coil). After being switched off for a short time, the relay must reliably pick up again at U_{op} . The U_{op} values for cold coils ($T_{coil} = T_A = 20^\circ\text{C}$) indicated by other manufacturers yield better values, but are not practical.

REL-MR...21-21

12.7 mm design width

Perforations for assembly: view of the connections

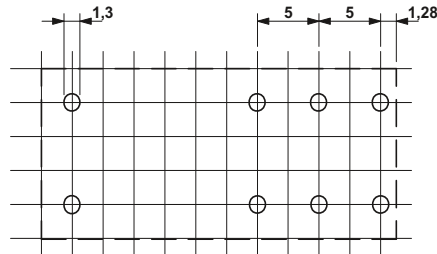

Pitch division: 2.5 mm



Permissible input voltage range for REL-MR...21-21, REL-MR-24DC/1IC, REL-MR...21HC



Plug-in solid-state relays

OPT...DC/24DC/2
OPT...DC/230AC/1

5 mm design width

Perforations for assembly: view of the connections

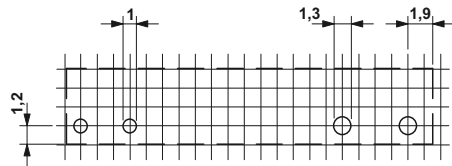

Pitch division: 1.25 mm and 1.27 mm

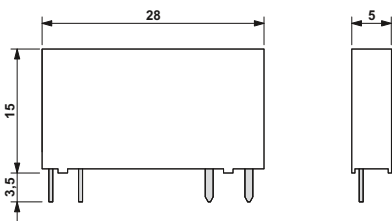

Derating curve for OPT...DC/24DC/2 and PLC-OS.../24DC/2 solid-state relays

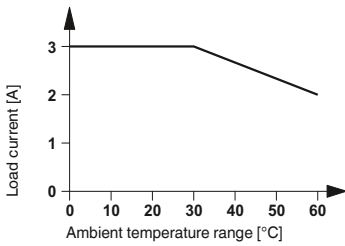

OPT...DC/24DC/5
OPT...DC/230AC/2

12.7 mm design width

Perforations for assembly: view of the connections

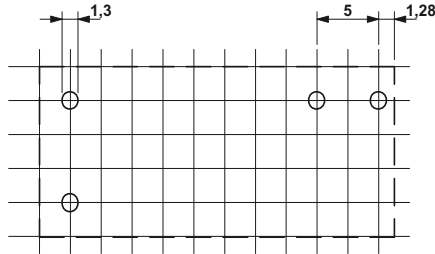

Pitch division: 2.5 mm

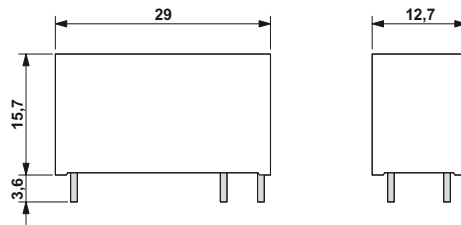

Derating curve for OPT...DC/24DC/5 and PLC-OS.../24DC/5/ACT solid-state relays

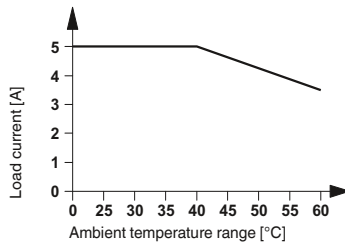

Derating curve for OPT...DC/230AC/1 and PLC-OS.../230AC/1 solid-state relays

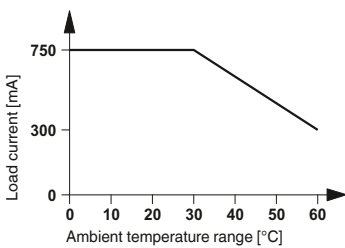

Derating curve for OPT...DC/230AC/2 and PLC-OS.../230AC/2/ACT solid-state relays

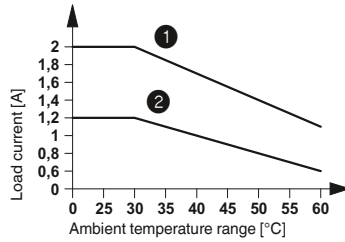

- ① Aligned with > 10 mm spacing
- ② Aligned without spacing

Relay modules

Tables, diagrams, dimensional drawings

Electrical interrupting rating for PLC-INTERFACE

Electrical interrupting rating for PLC...21 with 1 PDT relays



PLC-INTERFACE for railway applications

Electrical service life for PLC-RSP...UC/21RW



Electrical interrupting rating for PLC...21-21 with 2 PDT relays



Electrical service life for PLC-RSP...UC/21-21/RW



Electrical interrupting rating for PLC...11C/ACT for high inrush currents



Electrical service life for PLC-RSP...UC/21HC/RW



Electrical interrupting rating for PLC...21HC for high continuous currents



EMG-OV solid-state power relays

Derating curve for EMG 17-OV...48DC/2

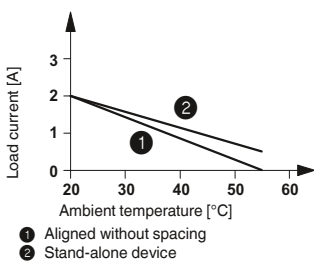

ST-OV 4-24DC/24DC...PRO power circuit breaker solid-state relays with signal logic

Derating curve for ST-OV 4-24DC/24DC...PRO

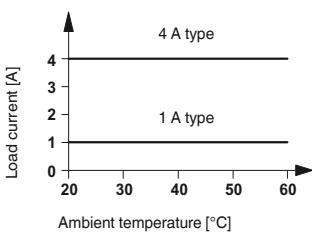

Time-current characteristic, 1 A version



Time-current characteristic, 4 A version

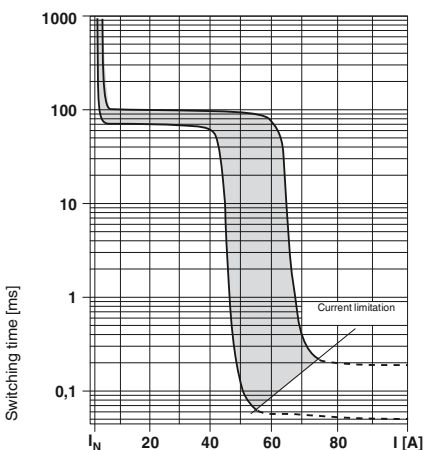

State diagram

| Operating state | Switching level Input | Light indicator, yellow LED | Light indicator, red LED | Alarm contact/CONTROL |
|-------------------------|-----------------------|-----------------------------|--------------------------|-----------------------|
| Not activated | L | L | L | |
| Normal operation | H | H | L | |
| Over-load/short circuit | H | H | H | |
| Opencircuit | L | L | H | |

UEGM-OE/AV logic pulse expansion module

Time diagrams for UEGM-OE/AV-24DC/24DC/100

Scenario 1: input pulse $t_i < t_{O\ set}$

Operating voltage present



Scenario 2: input pulse $t_i \geq t_{O\ set}$; $t_i = t_o$

Operating voltage present



Table of adjustable output pulse lengths

| | DIP switches ¹⁾ | | | | | | | |
|---|----------------------------|----|----|-----|-----|-----|------|------|
| | S1 | S2 | S3 | S4 | S5 | S6 | S7 | S8 |
| Length of output pulses [ms] (when in "on" switch position) | 10 | - | - | - | - | - | - | - |
| | - | 20 | - | - | - | - | - | - |
| | - | - | 50 | - | - | - | - | - |
| | - | - | - | 100 | - | - | - | - |
| | - | - | - | - | 200 | - | - | - |
| | - | - | - | - | - | 500 | - | - |
| | - | - | - | - | - | - | 1000 | - |
| | - | - | - | - | - | - | - | 1500 |

¹⁾ If no switch is actuated, the output voltage is not defined.

If the input pulse is longer than the set time, the output is switched off almost simultaneously with the input.

Intermediate values can be obtained by combining several DIP switches according to the following formula:

$$T_{tot} = \frac{1}{\frac{1}{t_1} + \frac{1}{t_2} + \dots + \frac{1}{t_n}}$$

Relay modules

PLC series

PLC-INTERFACE with two integrated relays

Relay module with two permanently soldered-in power relays

The advantages:

- 100% more channel density than the conventional 6.2 mm relay
- Two switching channels in a 6.2 mm housing
- Integrated input circuit/protective circuit
- Safe isolation according to DIN EN 50178 between coil and contacts and between contacts
- Screw, spring-cage, and push-in technology

| Notes: |
|--|
| Type of housing: Polyamide PA non-reinforced, color: green. |
| Marking systems and mounting material See Catalog 5 |
| 1) EMC: Class A product, see page 571 |



Two integrated relays



Technical data

| | |
|--|--|
| Input data | ① |
| Typ. input current at U_N | 7 [mA] |
| Response/release time at U_N | 4 / 6 [ms] |
| Input circuit DC | Yellow LED, Protection against polarity reversal, freewheeling diode |
| Output data | |
| Contact material | AgNi |
| Max. switching voltage | 250 V AC/DC |
| Min. switching voltage | 24 V AC/DC |
| Limiting continuous current | 3.5 A |
| Min. switching current | 5 mA |
| General data | |
| Test voltage input/output | 3 kV AC (50 Hz, 1 min.) |
| Test voltage output/output | 3 kV AC (50 Hz, 1 min.) |
| Ambient temperature (operation) | -20°C ... 60°C |
| Mechanical service life | 2×10^7 cycles |
| Standards/regulations | IEC 60664, EN 50178, IEC 62103 |
| Connection data solid / stranded / AWG | 0.14 - 2.5 mm ² / 0.14 - 2.5 mm ² / 26 - 14 |
| Dimensions | 6.2 mm / 80 mm / 86 mm W / H / D |

Ordering data

| Description | Input voltage U_N | Type | Order No. | Pcs. / Pkt. |
|--|---------------------|--------------------|-----------|-------------|
| PLC INTERFACE, with screw connection ① | 24 V DC | PLC-2RSC-24DC/ 1') | 2987309 | 10 |
| PLC INTERFACE, with spring-cage connection ① | 24 V DC | PLC-2RSP-24DC/ 1') | 2987312 | 10 |
| PLC-INTERFACE, with push-in connection ① | 24 V DC | PLC-2RPT-24DC/1') | 2901639 | 10 |

Application example for PLC-2RS...24DC/1

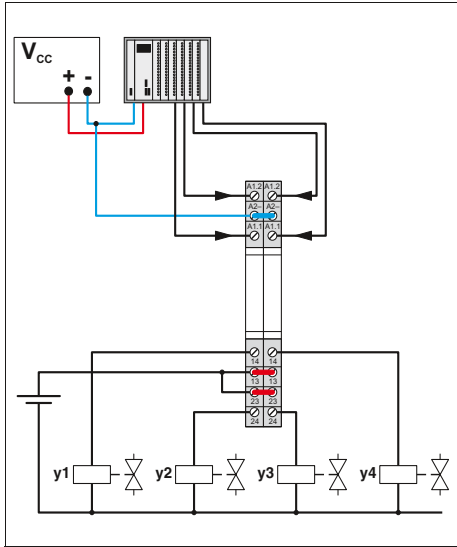

Operating voltage range

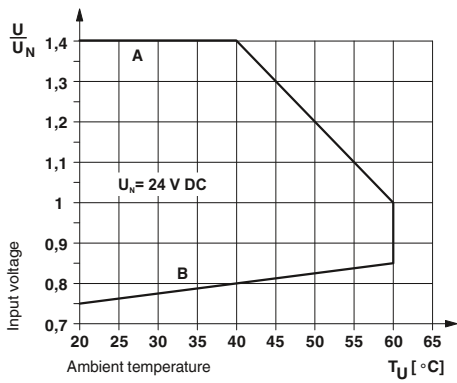

Interrupting rating

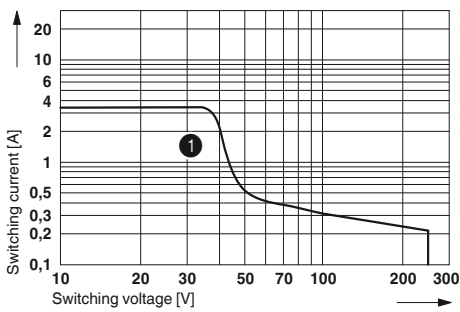

① DC, ohmic load

Relay modules

PLC series

PLC-INTERFACE with manual switch and relay

Relay module with manual switch and integrated power relay for manual, zero, and automatic functions

The advantages are:

- Max. switching current of 6 A
- Only 6.2 mm wide
- Floating confirmation contact
- Safe isolation according to DIN EN 50178 between coil and contact
- Screw, spring-cage, and push-in technology

| |
|---|
| Notes: |
| Type of housing: Polyester PBT non-reinforced, color: green. |
| Marking systems and mounting material See Catalog 5 |
| For the protection of input and output, inductive loads must be dampened with an effective protection circuit. |
| Separating plate PLC-ATP is to be used in the following cases: always at the start and end of a PLC terminal strip, for voltages greater than 250 V (L1, L2, L3) between the same terminal points of neighboring modules (potential bridging then takes place with FBST 8-PLC... or FBST 500...) and with safe isolation between neighboring modules. |
| Module height: PLC-...-S/H = 90 mm; PLC-...-S/L: = 86 mm |
| PLC...H - manual operation PLC...L - operation using screwdriver |
| 1) EMC: Class A product, see page 571 |



Relay module with manual switch and integrated relay

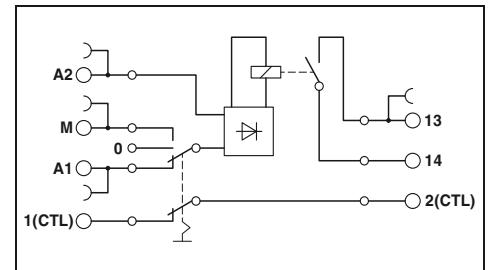

Application example PLC-RS...24UC/1/S...

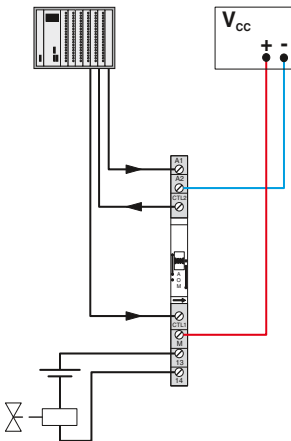

Permissible input voltage range for PLC-RS...24UC/1/S...



Curve A maximum continuous voltage at limiting continuous current = 6 A

Curve B minimum operating voltage for pre-excitation with U_N and limiting continuous current = 6 A

| | |
|---|---|
| Input data | |
| Typ. input current at U_N | [mA] |
| Response/release time at U_N | [ms] |
| Input circuit AC/DC | |
| Output data | |
| Contact material | AgSnO |
| Max. switching voltage | 250 V AC/DC |
| Min. switching voltage | 5 V (at 100 mA) |
| Limiting continuous current | 6 A |
| Max. inrush current | (on request) |
| Min. switching current | 10 mA (at 12 V) |
| Feedback | |
| Operating mode "Automatic" floating | max. 30 V AC/DC / 50 mA min. 2 V AC/DC / 1 mA |
| General data | |
| Rated insulation voltage | 250 V AC |
| Rated surge voltage | 6 kV |
| Ambient temperature (operation) | -20°C ... 60°C |
| Standards/regulations | IEC 60664, EN 50178, IEC 62103 |
| Pollution degree/surge voltage category | 2 / III |
| Connection data solid / stranded / AWG | 0.14 - 2.5 mm ² / 0.14 - 2.5 mm ² / 26 - 14 |
| Dimensions | W / H / D 6.2 mm / 80 mm / 90 mm |

Technical data

| | | |
|---|---|--------|
| | ① | ② |
| Typ. input current at U_N | 11 | 11 |
| Response/release time at U_N | 6 / 15 | 6 / 15 |
| Input circuit AC/DC | Yellow LED, Bridge rectifier | |
| Contact material | AgSnO | |
| Max. switching voltage | 250 V AC/DC | |
| Min. switching voltage | 5 V (at 100 mA) | |
| Limiting continuous current | 6 A | |
| Max. inrush current | (on request) | |
| Min. switching current | 10 mA (at 12 V) | |
| Operating mode "Automatic" floating | max. 30 V AC/DC / 50 mA min. 2 V AC/DC / 1 mA | |
| Rated insulation voltage | 250 V AC | |
| Rated surge voltage | 6 kV | |
| Ambient temperature (operation) | -20°C ... 60°C | |
| Standards/regulations | IEC 60664, EN 50178, IEC 62103 | |
| Pollution degree/surge voltage category | 2 / III | |
| Connection data solid / stranded / AWG | 0.14 - 2.5 mm ² / 0.14 - 2.5 mm ² / 26 - 14 | |
| Dimensions | W / H / D 6.2 mm / 80 mm / 90 mm | |

| Description | Input voltage U_N |
|---|---------------------|
| PLC INTERFACE, with screw connection | |
| ① | 24 V AC/DC |
| ② | 24 V AC/DC |
| PLC INTERFACE, with spring-cage connection | |
| ① | 24 V AC/DC |
| ② | 24 V AC/DC |
| PLC-INTERFACE, with push-in connection | |
| ① | 24 V AC/DC |
| ② | 24 V AC/DC |

Ordering data

| Type | Order No. | Pcs. / Pkt. |
|------------------------------------|-----------|-------------|
| PLC-RSC- 24UC/ 1/S/H | 2982236 | 10 |
| PLC-RSC- 24UC/ 1/S/L ¹⁾ | 2834876 | 10 |
| PLC-RSP- 24UC/ 1/S/H | 2982249 | 10 |
| PLC-RSP- 24UC/ 1/S/L ¹⁾ | 2834889 | 10 |
| PLC-RPT- 24UC/ 1/S/H ¹⁾ | 2900328 | 10 |
| PLC-RPT- 24UC/ 1/S/L ¹⁾ | 2900327 | 10 |

PLC-INTERFACE with manual switch without relay

Switching module without relay for manual, zero, and automatic functions

The advantages:

- Only 6.2 mm wide
- Floating confirmation contact
- Screw and spring-cage connection technology

| |
|---|
| Notes: |
| Type of housing: Polyester PBT non-reinforced, color: green. |
| Marking systems and mounting material See Catalog 5 |
| For the protection of input and output, inductive loads must be dampened with an effective protection circuit. |
| Separating plate PLC-ATP is to be used in the following cases: always at the start and end of a PLC terminal strip, for voltages greater than 250 V (L1, L2, L3) between the same terminal points of neighboring modules (potential bridging then takes place with FBST 8-PLC... or FBST 500...) and with safe isolation between neighboring modules. |
| Module height: PLC-...-S/H = 90 mm; PLC-...-S/L: = 86 mm |
| PLC...-H - manual operation PLC...-L - operation using screwdriver |



Module with manual switch without relay



Technical data

| | |
|---|--|
| Max. switching voltage | 72 V DC |
| Min. switching voltage | 2 V DC |
| Max. inrush current | 50 mA |
| Min. switching current | 1 mA |
| Cycles, max. | 100 (At 72 V DC / 50 mA) / 10000 (at 12 V DC / 100 mA) |
| Feedback | |
| Operating mode "Automatic" floating | ≤ 72 V DC / 50 mA |
| General data | |
| Rated insulation voltage | 85 V AC |
| Rated surge voltage | 0.5 kV / basic insulation |
| Ambient temperature (operation) | -20°C ... 60°C |
| Standards/regulations | IEC 60664, EN 50178, IEC 62103 |
| Pollution degree/surge voltage category | 2 / III |
| Dimensions | W / H / D 6.2 mm / 80 mm / 90 mm |

Ordering data

| Description | Type | Order No. | Pcs. / Pkt. |
|---|------------|-----------|-------------|
| PLC INTERFACE, with screw connection | | | |
| | PLC-SC-S/H | 2980733 | 10 |
| | PLC-SC-S/L | 2980775 | 10 |
| PLC INTERFACE, with spring-cage connection | | | |
| | PLC-SP-S/H | 2980746 | 10 |
| | PLC-SP-S/L | 2980788 | 10 |

Application example PLC-S...S...



Relay modules

PLC series

PLC-INTERFACE with an integrated solid-state relay

The slim 6.2 mm PLC housing with integrated electronics in various versions offers the following advantages:

- Option of bridging adjacent modules
- Status display
- Protection circuits in input and output
- Wear-resistant and bounce-free switching
- Integrated protection circuit
- DC outputs of up to 300 V DC/1 A or up to 24 V DC/10 A
- Electronic PDT output of up to 48 V DC/500 mA
- Screw, spring-cage, and push-in technology

| Notes: |
|---|
| Type of housing: Polyester PBT non-reinforced, color: green. |
| Marking systems and mounting material See Catalog 5 |
| For the protection of input and output, inductive loads must be dampened with an effective protection circuit. |
| Separating plate PLC-ATP is to be used in the following cases: always at the start and end of a PLC terminal strip, for voltages greater than 250 V (L1, L2, L3) between the same terminal points of neighboring modules (potential bridging then takes place with FBST 8-PLC... or FBST 500...) and with safe isolation between neighboring modules. |
| The housings of the following modules are open on one side: - PLC-OS...-300DC/1 - PLC-OS...-24DC/24DC/10/R |
| 1) EMC: Class A product, see page 571 |



Power solid-state relay with DC voltage output, max. 1 A



| Input data | |
|--|----------------------------------|
| Permissible range (with reference to U_N) | |
| Switching level (with reference to U_N) | 1 signal ("H") 0 signal ("L") |
| Typ. input current at U_N | [mA] |
| Transmission frequency f_{limit} | [Hz] |
| Alarm output | |
| Operating range | |
| Output data | |
| Max. / min. switching voltage | |
| Limiting continuous current | |
| Voltage drop at max. limiting continuous current | |
| General data | |
| Rated insulation voltage | |
| Rated surge voltage | |
| Ambient temperature (operation) | |
| Standards/regulations | |
| Connection data solid / stranded / AWG | |
| Dimensions | W / H / D |

| Technical data | | | | | | | |
|----------------|------------|------------|------------|------------|------------|------------|------------|
| ① | ② | ③ | ④ | ⑤ | ⑥ | ⑦ | ⑧ |
| 0.8 - 1.2 | 0.8 - 1.2 | 0.8 - 1.2 | 0.8 - 1.2 | 0.8 - 1.2 | 0.8 - 1.2 | 0.8 - 1.1 | 0.8 - 1.1 |
| ≥ 0.8 | ≥ 0.8 | ≥ 0.8 | ≥ 0.8 | ≥ 0.8 | ≥ 0.8 | ≥ 0.8 | ≥ 0.8 |
| ≤ 0.4 | ≤ 0.4 | ≤ 0.4 | ≤ 0.4 | ≤ 0.4 | ≤ 0.4 | ≤ 0.4 | ≤ 0.4 |
| 15 | 6 | 8 | 5 | 5 | 3 | 5.6 | 8.4 |
| 50 | 50 | 50 | 50 | 50 | 50 | 10 | 10 |

- / -

300 V DC / 12 V DC
1 A (see derating curve)
< 500 mV

300 V
4 kV / basic insulation
-25°C ... 60°C
IEC 60664, EN 50178, IEC 62103
0.14 - 2.5 mm² / 0.14 - 2.5 mm² / 26 - 14
6.2 mm / 80 mm / 86 mm

Ordering data

| Description | Input voltage U_N | Type | Order No. | Pcs. / Pkt. |
|---|---------------------|--------------------------|-----------|-------------|
| PLC INTERFACE, with screw connection | | | | |
| | ① 5 V DC | PLC-OSC- 5DC/300DC/ 1') | 2980652 | 10 |
| | ② 12 V DC | PLC-OSC- 12DC/300DC/ 1') | 2980665 | 10 |
| | ③ 24 V DC | PLC-OSC- 24DC/300DC/ 1') | 2980678 | 10 |
| 48 V DC ... 60 V DC | ④ 60 V DC | PLC-OSC- 60DC/300DC/ 1') | 2980681 | 10 |
| | ⑤ 110 V DC | PLC-OSC-110DC/300DC/ 1') | 2980694 | 10 |
| | ⑥ 220 V DC | PLC-OSC-220DC/300DC/ 1') | 2980704 | 10 |
| | ⑦ 120 V AC | PLC-OSC-120AC/300DC/ 1') | 2980717 | 10 |
| | ⑧ 230 V AC | PLC-OSC-230AC/300DC/ 1') | 2980720 | 10 |
| PLC INTERFACE, with spring-cage connection | | | | |
| | ① 5 V DC | PLC-OSP- 5DC/300DC/ 1') | 2980814 | 10 |
| | ② 12 V DC | PLC-OSP- 12DC/300DC/ 1') | 2980827 | 10 |
| | ③ 24 V DC | PLC-OSP- 24DC/300DC/ 1') | 2980830 | 10 |
| 48 V DC ... 60 V DC | ④ 60 V DC | PLC-OSP- 60DC/300DC/ 1') | 2980843 | 10 |
| | ⑤ 110 V DC | PLC-OSP-110DC/300DC/ 1') | 2980856 | 10 |
| | ⑥ 220 V DC | PLC-OSP-220DC/300DC/ 1') | 2980869 | 10 |
| | ⑦ 120 V AC | PLC-OSP-120AC/300DC/ 1') | 2980872 | 10 |
| | ⑧ 230 V AC | PLC-OSP-230AC/300DC/ 1') | 2980885 | 10 |
| PLC-INTERFACE, with push-in connection | | | | |
| | ① 5 V DC | PLC-OPT- 5DC/300DC/1') | 2900381 | 10 |
| | ② 12 V DC | PLC-OPT- 12DC/300DC/1') | 2900382 | 10 |
| | ③ 24 V DC | PLC-OPT- 24DC/300DC/1') | 2900383 | 10 |
| 48 V DC ... 60 V DC | ④ 60 V DC | PLC-OPT- 60DC/300DC/1') | 2900384 | 10 |
| | ⑤ 110 V DC | PLC-OPT-110DC/300DC/1') | 2900385 | 10 |
| | ⑥ 220 V DC | PLC-OPT-220DC/300DC/1') | 2900387 | 10 |
| | ⑦ 120 V AC | PLC-OPT-120AC/300DC/1') | 2900388 | 10 |
| | ⑧ 230 V AC | PLC-OPT-230AC/300DC/1') | 2900389 | 10 |



Power solid-state relay with short-circuit-proof DC voltage output, max. 10 A, with feedback



Input solid-state relay with DC voltage output, max. 500 mA, with electronic PDT



Technical data

- ③
- 0.8 - 1.2
- ≥ 0.8
- ≤ 0.4
- 3
- 100

3 V DC ... 33 V DC (High active) / 100 mA

33 V DC / 5 V DC
10 A (see derating curve)
≤ 50 mV

300 V
4 kV / basic insulation
-25°C ... 60°C
IEC 60664, EN 50178, IEC 62103
0.14 - 2.5 mm² / 0.14 - 2.5 mm² / 26 - 14
6.2 mm / 80 mm / 86 mm

Ordering data

| Type | Order No. | Pcs. / Pkt. |
|--|-----------|-------------|
| PLC-OSC- 24DC/ 24DC/ 10/R ¹ | 2982702 | 10 |
| PLC-OSP- 24DC/ 24DC/ 10/R ¹ | 2982715 | 10 |
| PLC-OPT- 24DC/ 24DC/10/R ¹ | 2900398 | 10 |



Technical data

- ③
- 0.8 - 1.2
- ≥ 0.8
- ≤ 0.4
- 3
- 1000

- / -

48 V DC / 3 V DC
500 mA (see derating curve)
< 1.2 V

300 V
4 kV / basic insulation
-25°C ... 60°C
IEC 60664, EN 50178, IEC 62103
0.14 - 2.5 mm² / 0.14 - 2.5 mm² / 26 - 14
6.2 mm / 80 mm / 86 mm

Ordering data

| Type | Order No. | Pcs. / Pkt. |
|--|-----------|-------------|
| PLC-OSC- 24DC/ 48DC/500/W ¹ | 2980636 | 10 |
| PLC-OSP- 24DC/ 48DC/500/W ¹ | 2980649 | 10 |
| PLC-OPT- 24DC/ 48DC/500/W ¹ | 2900378 | 10 |

Derating curve for PLC...300DC/1



① For input voltages 220 V DC and 230 V AC

Derating curve for PLC...24DC/24DC/10/R



Derating curve for PLC...24DC/48DC/500/W

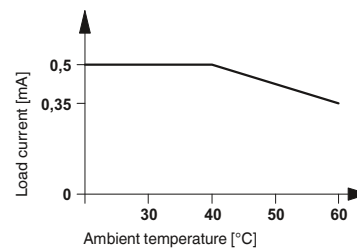

PLC-INTERFACE

Solid-state relays up to 100 kHz

A solid-state relay for the safe acquisition of short pulses.

- Status display
- Bridging options
- Limit frequency of up to 100 kHz
- Push-pull stage on output side
- Features a capacitor on the input side for interference suppression

| Notes: |
|--|
| Type of housing: Polyamide PA non-reinforced, color: green. |
| Marking systems and mounting material See Catalog 5 |
| 1) EMC: Class A product, see page 571 |



N

with DC voltage output
Transmission frequency 100 kHz

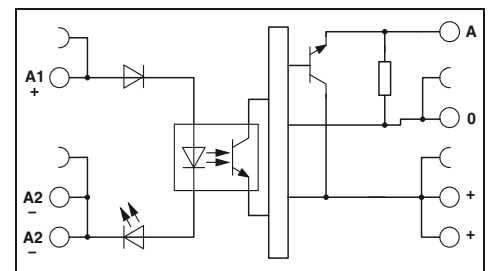

| Input data | |
|--|----------------------------------|
| Permissible range (with reference to U_N) | |
| Switching level with reference to U_N | 1 signal ("H") 0 signal ("L") |
| Typ. input current at U_N | [mA] |
| Typ. switch-on time at U_N | [μ s] |
| Typ. switch-off time at U_N | [μ s] |
| Transmission frequency f_{limit} | [kHz] |
| Input protection: | |
| Output data | |
| Operating voltage range | |
| Limiting continuous current | |
| Quiescent current | |
| Residual voltage drop at "H" | |
| Output circuit | |
| Output protection | |
| General data | |
| Test voltage input/output | |
| Ambient temperature (operation) | |
| Standards/regulations | |
| Pollution degree/surge voltage category | |
| Connection data solid / stranded / AWG | |
| Dimensions | W / H / D |

| Technical data | |
|--|-----------|
| ① | ② |
| 0.8 - 1.2 | 0.8 - 1.2 |
| > 0.8 | > 0.8 |
| < 0.4 | < 0.4 |
| 7 | 6 |
| 1.5 | 1.5 |
| 2 | 2 |
| 100 | 100 |
| LED yellow, Protection against polarity reversal, Surge protection | |
| 4 V DC ... 30 V DC | |
| 50 mA | |
| 4.3 mA | |
| < 0.5 V | |
| 3-conductor, ground-referenced | |
| Protection against polarity reversal, Surge protection | |
| 2.5 kV _{ms} (50 Hz, 1 min.) | |
| -20°C ... 60°C | |
| DIN EN 50178 | |
| 2 / II | |
| 0.14 - 2.5 mm ² / 0.14 - 2.5 mm ² / 26 - 14 | |
| 6.2 mm / 80 mm / 86 mm | |

| Description | Input voltage U_N |
|--|---------------------|
| Input solid-state relay with push-in connection | |
| ① | 5 V DC |
| ② | 24 V DC |
| Input solid-state relay with screw connection | |
| ① | 5 V DC |
| ② | 24 V DC |

| Ordering data | | |
|---|-----------|-------------|
| Type | Order No. | Pcs. / Pkt. |
| PLC-OSC- 5DC/24DC/100KHZ ¹⁾ | 2902963 | 1 |
| PLC-OSC- 24DC/24DC/100KHZ ¹⁾ | 2902964 | 1 |
| PLC-OPT- 5DC/ 24DC/100KHZ ¹⁾ | 2902969 | 1 |
| PLC-OPT- 24DC/24DC/100KHZ ¹⁾ | 2902970 | 1 |



N

with DC voltage output push-pull
Transmission frequency 100 kHz



N

with DC voltage output push-pull
Transmission frequency 100 kHz



Technical data

| ① | ② |
|-----------|-----------|
| 0.5 - 1.2 | 0.8 - 1.2 |
| > 0.5 | > 0.8 |
| < 0.3 | < 0.4 |
| 8 | 8 |
| 1 | 1 |
| 2 | 2 |
| 100 | 100 |

LED yellow, Protection against polarity reversal, Surge protection

Technical data

| ① | ② |
|-----------|-----------|
| 0.5 - 1.2 | 0.8 - 1.2 |
| > 0.5 | > 0.8 |
| < 0.3 | < 0.4 |
| 8 | 8 |
| 1 | 1 |
| 2 | 2 |
| 100 | 100 |

LED yellow, Protection against polarity reversal, Surge protection

4 V DC ... 18 V DC
50 mA
8.5 mA
< 1.2 V
3-conductor push-pull, ground referenced
Protection against polarity reversal, Surge protection

14 V DC ... 30 V DC
50 mA
15 mA
< 2.2 V
3-conductor push-pull, ground referenced
Protection against polarity reversal, Surge protection

2.5 kV_{rms} (50 Hz, 1 min.)
-20°C ... 60°C
DIN EN 50178
2 / II
0.14 - 2.5 mm² / 0.14 - 2.5 mm² / 26 - 14
6.2 mm / 80 mm / 86 mm

2.5 kV_{rms} (50 Hz, 1 min.)
-20°C ... 60°C
DIN EN 50178
2 / II
0.14 - 2.5 mm² / 0.14 - 2.5 mm² / 26 - 14
6.2 mm / 80 mm / 86 mm

Ordering data

| Type | Order No. | Pcs. / Pkt. |
|--|-----------|-------------|
| PLC-OSC- 5DC/ 5DC/100KHZ-G ¹) | 2902965 | 1 |
| PLC-OSC- 24DC/ 5DC/100KHZ-G ¹) | 2902966 | 1 |
| PLC-OPT- 5DC/ 5DC/100KHZ-G ¹) | 2902971 | 1 |
| PLC-OPT- 24DC/ 5DC/100KHZ-G ¹) | 2902972 | 1 |

Ordering data

| Type | Order No. | Pcs. / Pkt. |
|---|-----------|-------------|
| PLC-OSC- 5DC/ 24DC/100KHZ-G ¹) | 2902967 | 1 |
| PLC-OSC- 24DC/ 24DC/100KHZ-G ¹) | 2902968 | 1 |
| PLC-OPT- 5DC/24DC/100KHZ-G ¹) | 2902973 | 1 |
| PLC-OPT- 24DC/24DC/100KHZ-G ¹) | 2902974 | 1 |

PLC-INTERFACE for the TTL signal at the input

The PLC-BS...TTL/1 basic terminal block is controlled using a TTL (5 V) input signal and can be equipped with a mechanical relay or a solid-state relay as an option. The basic terminal block equipped with a robust miniature relay offers the following advantages:

- 6.2 mm slim design width
- Bridging options
- Status display
- Screw and spring-cage connection
- RTIII degree of protection
- Safe isolation in accordance with EN 50178 (VDE 0160)
- 4 kV_{rms} electrical isolation between coil and contact.
- Screw, spring-cage, and push-in technology

| Notes: |
|---|
| Type of housing: Polyester PBT non-reinforced, color: green. |
| Marking systems and mounting material See Catalog 5 |
| 1) EMC: Class A product, see page 571 |



Basic terminal block, for fitting with relay for TTL (5 V)

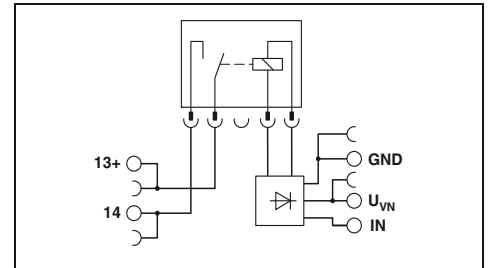

Technical data

| | | |
|---|--|-------------------------------|
| Input data | | |
| Rated control supply voltage U_{VN} | 5 V DC | |
| Rated control supply voltage range with reference to U_{VN} | 0.9 ... 1.2 | |
| Rated control supply current I_{VN} | 41 mA | |
| Rated actuating voltage U_c (IN) | 5 V DC (TTL) | |
| Rated actuating voltage range with reference to U_c | 0.9 ... 1.2 | |
| Rated actuating current I_c | 2.5 mA | |
| Typ. response time at U_c | 4.5 ms | |
| Typ. release time for U_c | 3.5 ms | |
| Input circuit | Yellow LED, Protection against polarity reversal, Surge protection | |
| Output data with: | REL-MR-4,5DC/21 AU | REL-MR-4,5DC/21 |
| Contact type | Single contact, 1 N/O contact | Single contact, 1 N/O contact |
| Contact material | AgSnO, hard gold-plated | AgSnO |
| Max. switching voltage | 30 V AC / 36 V DC | 250 V AC/DC |
| Min. switching voltage | 100 mV (at 10 mA) | 5 V (at 100 mA) |
| Limiting continuous current | 50 mA | 6 A |
| Max. inrush current | 50 mA | (on request) |
| Min. switching current | 1 mA (at 24 V) | 10 mA (at 12 V) |
| General data | | |
| Rated insulation voltage | 250 V | |
| Rated surge voltage / insulation | 6 kV | |
| Ambient temperature (operation) | -20°C ... 60°C | |
| Mechanical service life | 2 x 10 ⁷ cycles | |
| Air and creepage distances between the power circuits | IEC 60664, EN 50178, IEC 62103 | |
| Pollution degree / Surge voltage category | 2 / III | |
| Mounting position / Assembly | Any / In rows with zero spacing | |
| Connection data solid / stranded / AWG | 0.14 - 2.5 mm ² / 0.14 - 2.5 mm ² / 26 - 14 | |
| Dimensions | W / H / D 6.2 mm / 80 mm / 94 mm | |

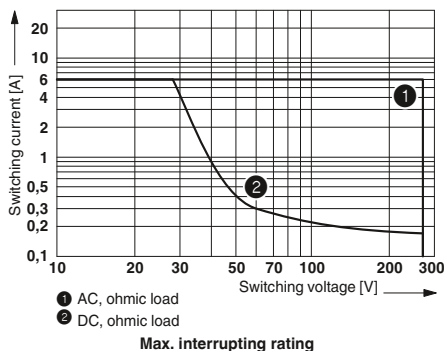

| Description |
|-----------------------------|
| PLC-INTERFACE |
| With screw connection |
| With spring-cage connection |
| With push-in connection |

| Plug-in miniature power relays |
|--------------------------------|
| with gold contact |
| with power contact |

Ordering data

| Type | Order No. | Pcs. / Pkt. |
|-----------------|-----------|-------------|
| PLC-BSC-TTL(1') | 2982689 | 10 |
| PLC-BSP-TTL(1') | 2982692 | 10 |
| PLC-BPT-TTL(1') | 2900458 | 10 |

Accessories

| REL-MR 4,5DC/21AU | 2961370 | 10 |
|-------------------|---------|----|
| REL-MR- 4,5DC/21 | 2961367 | 10 |

PLC-INTERFACE for the TTL signal at the input

The PLC-BS...TTL/1 basic terminal block is controlled using a TTL (5 V) input signal and can be equipped with a mechanical relay or a solid-state relay as an option. The basic terminal block equipped with a solid-state relay offers the following advantages:

- 6.2 mm slim design width
- Bridging options
- Status display
- Screw and spring-cage connection
- IP67-protected solid-state relay electronic unit
- Switching capacity of up to 24 V DC/3 A
- Alternative input or power solid-state relay
- Wear-free and output-free
- Integrated protection circuit
- Insensitive to vibrations and shocks
- 2.5 kV_{rms} electrical isolation between input and output
- Screw, spring-cage, and push-in technology

| Notes: |
|---|
| Type of housing: Polyester PBT non-reinforced, color: green. |
| Marking systems and mounting material See Catalog 5 |
| For derating curves see page 345 |
| 1) EMC: Class A product, see page 571 |



Basic terminal block for fitting with solid-state relay for TTL (5 V)



Technical data

| Input data | 5 V DC | 48 V DC |
|---|--|--|
| Rated control supply voltage U_{VN} | 5 V DC | 48 V DC |
| Rated control supply voltage range with reference to U_{VN} | 0.9 ... 1.2 | 0.9 ... 1.2 |
| Rated control supply current I_{VN} | 11.5 mA | 11.5 mA |
| Rated actuating voltage U_c (IN) | 5 V DC (TTL) | 5 V DC (TTL) |
| Switching level 1 signal ("H") (TTL signal) | > 2 V DC | > 2 V DC |
| Switching level 0 signal ("L") (TTL signal) | < 0.8 V DC | < 0.8 V DC |
| Rated actuating current I_c | 2.5 mA | 2.5 mA |
| Typ. response time/switch-on time at U_c | 35 μ s | 35 μ s |
| Typ. switch-off time at U_c | 320 μ s | 320 μ s |
| Input circuit | Yellow LED, Protection against polarity reversal, Surge protection | Yellow LED, Protection against polarity reversal, Surge protection |
| Output data with: | OPT-5DC/48DC/100 | OPT-5DC/24DC/2 |
| Max. switching voltage | 48 V DC | 33 V DC |
| Min. switching voltage | 3 V DC | 3 V DC |
| Limiting continuous current | 100 mA | 3 A |
| Output protection | Protection against polarity reversal, Surge protection | Protection against polarity reversal, Surge protection |
| Voltage drop at limiting continuous current | < 1 V | < 200 mV |
| General data | | |
| Rated insulation voltage | 250 V | 250 V |
| Rated surge voltage / insulation | 6 kV/basic isolation | 6 kV/basic isolation |
| Ambient temperature (operation) | -20°C ... 60°C | -20°C ... 60°C |
| Air and creepage distances between the power circuits | IEC 60664, EN 50178, IEC 62103 | IEC 60664, EN 50178, IEC 62103 |
| Pollution degree / Surge voltage category | 2 / III | 2 / III |
| Connection data solid / stranded / AWG | 0.14 - 2.5 mm ² / 0.14 - 2.5 mm ² / 26 - 14 | 0.14 - 2.5 mm ² / 0.14 - 2.5 mm ² / 26 - 14 |
| Dimensions | W / H / D | 6.2 mm / 80 mm / 94 mm |

Ordering data

| Description | Type | Order No. | Pcs. / Pkt. |
|-----------------------------|-----------------------------|-----------|-------------|
| PLC-INTERFACE | | | |
| With screw connection | PLC-BSC-TTL/1 ¹⁾ | 2982689 | 10 |
| With spring-cage connection | PLC-BSP-TTL/1 ¹⁾ | 2982692 | 10 |
| With push-in connection | PLC-BPT-TTL/1 ¹⁾ | 2900458 | 10 |

Accessories

| Plug-in solid-state relays | Type | Order No. | Pcs. / Pkt. |
|----------------------------|------------------|-----------|-------------|
| Solid-state input relays | OPT-5DC/48DC/100 | 2967992 | 10 |
| Solid-state power relays | OPT-5DC/24DC/2 | 2967989 | 10 |

PLC-INTERFACE for the TTL signal at the output

The PLC-OS...24DC/TTL with a built-in solid-state relay can be used for fast and wear-free switching of TTL (5 V) signals.

The module offers the following advantages:

- Switching capacity TTL (5 V), fan out = 1
- 6.2 mm slim design width
- Bridging options
- Status display
- Screw and spring-cage connection
- Integrated protection circuit
- Insensitive to vibrations and shocks
- Screw, spring-cage, and push-in technology

| Notes: |
|---|
| Type of housing: Polyester PBT non-reinforced, color: green. |
| Marking systems and mounting material See Catalog 5 |
| 1) EMC: Class A product, see page 571 |



Input solid state relay with TTL (5 V) output

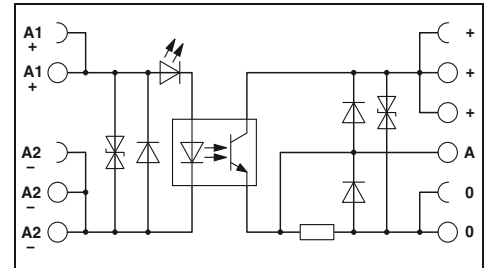

Technical data

| | | |
|--|--|--------------------|
| Input data | | |
| Rated actuating voltage U_C | 24 V DC | |
| Rated actuating voltage range with reference to U_C | 0.8 ... 1.2 | |
| Switching level 1 signal ("H") | > 0.8 | |
| Switching level 0 signal ("L") | < 0.4 | |
| Rated actuating current I_C | 3.4 mA | |
| Typ. switch-on time for U_C | 35 μ s | |
| Typ. switch-off time at U_C | 35 μ s | |
| Transmission frequency f_{limit} | 1 kHz | |
| Input circuit DC | Yellow LED, Protection against polarity reversal, Surge protection | |
| Output data with: | | |
| Rated control supply voltage U_S | 5 V DC | |
| Rated control supply voltage range with reference to U_S | 0.9 ... 1.2 | |
| Limiting continuous current | (A TTL load (Fan out = 1)/50 mA for switching mode) | |
| Output protection | Protection against polarity reversal, Surge protection | |
| Voltage drop at max. limiting continuous current | < 80 mV | |
| General data | | |
| Rated insulation voltage | 250 V DC | |
| Rated surge voltage / insulation | 4 kV / basic insulation | |
| Ambient temperature (operation) | -25°C ... 60°C | |
| Air and creepage distances between the power circuits | IEC 60664, EN 50178, IEC 62103 | |
| Pollution degree/surge voltage category | 2 / III | |
| Connection data solid / stranded / AWG | 0.14 - 2.5 mm ² / 0.14 - 2.5 mm ² / 26 - 14 | |
| Dimensions | W / H / D 6.2 mm / 80 mm / 86 mm | |
| Ordering data | | |
| Type | Order No. | Pcs. / Pkt. |
| PLC-OSC- 24DC/TTL ¹⁾ | 2982728 | 10 |
| PLC-OSP- 24DC/TTL ¹⁾ | 2982731 | 10 |
| PLC-OPT- 24DC/TTL ¹⁾ | 2900363 | 10 |

Derating curve for PLC-OSP...24DC/3RW

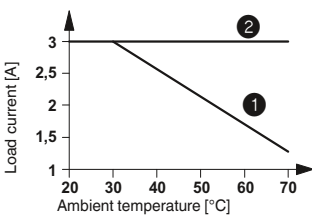

- ① Aligned without spacing
- ② Aligned with ≥ 20 mm spacing

Derating curve for PLC-OSP...110DC/3RW

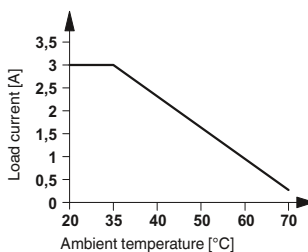

PLC-INTERFACE with solid-state relays for railway applications

The PLC-OSP...RW interface modules are intended for use as per DIN EN 50155 (VDE 0115 part 200) "Railway applications, Part 200: Electronic devices in rail vehicles".

The advantages:

- Temperature range -25°C to +70°C
- Input voltage range 0.7 - 1.25 x U_N
- Shock resistance according to DIN 50155 (requirements according to EN 61373).
- Screw, spring-cage, and push-in technology



Power solid-state relay with DC voltage output, max. 3 A



Power solid-state relay with DC voltage output, max. 3 A

| | |
|---------------------------------------|---|
| Notes: | |
| Type of housing: | Polyester PBT non-reinforced, color: green. |
| Marking systems and mounting material | See Catalog 5 |
| For derating curves see page 358 | |
| 1) EMC: Class A product, see page 571 | |

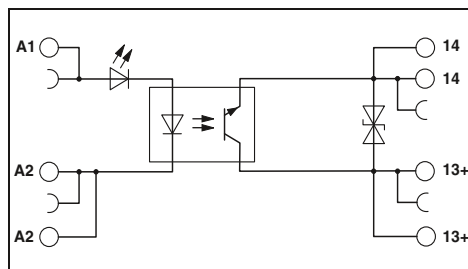

| Input data | |
|---|---|
| Permissible range (with reference to U _N) | |
| Switching level (with reference to U _N) | 1 signal ("H") 0 signal ("L") |
| Typ. input current at U _N | [mA] |
| Typ. switch-on time at U _N | [ms] |
| Typ. switch-off time at U _N | [ms] |
| Transmission frequency f _{limit} | [Hz] |
| Input circuit DC | |
| Output data | |
| Max. switching voltage | 33 V DC |
| Min. switching voltage | 3 V DC |
| Limiting continuous current | 3 A (see derating curve) |
| Output protection | Protection against polarity reversal, Surge protection |
| Voltage drop at max. limiting continuous current | <200 mV |
| General data | |
| Rated insulation voltage | 250 V |
| Rated surge voltage | 4 kV / basic insulation |
| Ambient temperature (operation) | -25°C ... 70°C |
| Standards/regulations | IEC 60664, EN 50178, IEC 62103 |
| Pollution degree/surge voltage category | 2 / III |
| Connection data solid / stranded / AWG | 0.14 - 2.5 mm ² / 0.14 - 2.5 mm ² / 26 - 14 |
| Dimensions | W / H / D 6.2 mm / 80 mm / 86 mm |

| Technical data | |
|--|------------|
| ① | ⑥ |
| 0.7 - 1.25 | 0.7 - 1.25 |
| ≥ 0.6 | ≥ 0.6 |
| ≤ 0.3 | ≤ 0.3 |
| 8.5 | 3 |
| 0.04 | 0.08 |
| 0.2 | 0.6 |
| 300 | 100 |
| Yellow LED, Protection against polarity reversal | |

| Technical data | | | | | |
|--|------------|------------|------------|------------|------------|
| ① | ② | ③ | ④ | ⑤ | ⑥ |
| 0.7 - 1.25 | 0.7 - 1.25 | 0.7 - 1.25 | 0.7 - 1.25 | 0.7 - 1.25 | 0.7 - 1.25 |
| > 0.6 | > 0.6 | > 0.6 | > 0.6 | > 0.6 | > 0.6 |
| < 0.4 | < 0.4 | < 0.3 | < 0.3 | < 0.3 | < 0.3 |
| 12 | 12 | 5.5 | 5.5 | 5.5 | 5.5 |
| 0.4 | 0.4 | 0.04 | 0.04 | 0.04 | 0.4 |
| 0.2 | 0.1 | 0.2 | 0.2 | 0.2 | 0.2 |
| 50 | 50 | 300 | 300 | 300 | 300 |
| Yellow LED, Protection against polarity reversal, Surge protection | | | | | |

| Description | Input voltage U _N |
|---|------------------------------|
| PLC INTERFACE, with spring-cage connection | |
| ① | 24 V DC |
| ② | 36 V DC |
| ③ | 48 V DC |
| ④ | 72 V DC |
| ⑤ | 96 V DC |
| ⑥ | 110 V DC |
| PLC-INTERFACE, with push-in connection | |
| ① | 24 V DC |
| ② | 36 V DC |
| ③ | 48 V DC |
| ④ | 72 V DC |
| ⑤ | 96 V DC |
| ⑥ | 110 V DC |

| Ordering data | | | |
|---------------------------------------|-----------|-------------|--|
| Type | Order No. | Pcs. / Pkt. | |
| PLC-OSP- 24DC/ 24DC/ 3RW | 2980513 | 10 | |
| PLC-OSP-110DC/ 24DC/ 3RW | 2980526 | 10 | |
| PLC-OPT- 24DC/ 24DC/3RW ¹⁾ | 2900379 | 10 | |
| PLC-OPT-110DC/ 24DC/3RW ¹⁾ | 2900380 | 10 | |

| Ordering data | | | |
|--|-----------|-------------|--|
| Type | Order No. | Pcs. / Pkt. | |
| PLC-OSP- 24DC/110DC/ 3RW ¹⁾ | 2982511 | 10 | |
| PLC-OSP- 36DC/110DC/ 3RW ¹⁾ | 2982524 | 10 | |
| PLC-OSP- 48DC/110DC/ 3RW ¹⁾ | 2982537 | 10 | |
| PLC-OSP- 72DC/110DC/ 3RW ¹⁾ | 2982540 | 10 | |
| PLC-OSP- 96DC/110DC/ 3RW ¹⁾ | 2982553 | 10 | |
| PLC-OSP-110DC/110DC/ 3RW ¹⁾ | 2982566 | 10 | |
| PLC-OPT- 24DC/110DC/3RW ¹⁾ | 2900391 | 10 | |
| PLC-OPT- 36DC/110DC/3RW ¹⁾ | 2900392 | 10 | |
| PLC-OPT- 48DC/110DC/3RW ¹⁾ | 2900393 | 10 | |
| PLC-OPT- 72DC/110DC/3RW ¹⁾ | 2900394 | 10 | |
| PLC-OPT- 96DC/110DC/3RW ¹⁾ | 2900395 | 10 | |
| PLC-OPT-110DC/110DC/3RW ¹⁾ | 2900396 | 10 | |

Relay modules

PLC series

PLC-INTERFACE for railway applications

Relay modules with extended input voltage and temperature range, specifically for use in railway applications

The advantages:

- Temperature range -25°C to +70°C
- Input voltage range 0.7 to 1.25 x UN
- Vibration and shock resistance to EN 50155
- Safe isolation according to DIN EN 50178 between coil and contact
- Spring cage and push-in connection method

| Notes: |
|---|
| Type of housing: Polyamide PA non-reinforced, color: green. |
| Marking systems and mounting material See Catalog 5 |
| Separating plate PLC-ATP must be installed for voltages larger than 250 V (L1, L2, L3) between identical terminal blocks in adjacent modules. Potential bridging is then carried out with FBST 8-PLC... or FBST 500.... |
| If the specified maximum values for multi-layer contact relays are exceeded, the gold plating is destroyed. The maximum values of the power contact relay are then valid. This can result in a shorter service life than with a pure power contact. |
| 1) EMC: Class A product, see page 571 |



Basic terminal block that can be fitted with 1 PDT relay

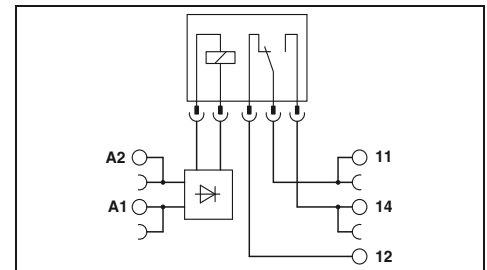

Permissible input voltage range for PLC-BSP-24DC/21RW (with REL-MR-18DC/21... relay)



Curve A
Maximum continuous voltage at limiting continuous current = 3 A

Curve B
Minimum operate voltage for pre-excitation with U_N and limiting continuous current = 3 A

Electrical interrupting rating for PLC...21 with 1 PDT relay



| Input data |
|---|
| Nominal input voltage U _N |
| Permissible range (with reference to U _N) |
| Typ. input current at U _N |
| Typ. response time at U _N |
| Typ. release time at U _N |
| Input circuit |
| Output data with: |
| Contact type |
| Contact material |
| Max. switching voltage |
| Min. switching voltage |
| Limiting continuous current |
| Max. inrush current |
| Min. switching current |
| General data |
| Test voltage input/output |
| Ambient temperature (operation) |
| Mechanical service life |
| Standards/regulations |
| Pollution degree / Surge voltage category |
| Connection data solid / stranded / AWG |
| Dimensions |

| Technical data | |
|--|-------------------------|
| 24 V DC | |
| See diagram | |
| 12 mA | |
| 5 ms | |
| 8 ms | |
| Yellow LED, Protection against polarity reversal, freewheeling diode | |
| REL-MR-18DC/21 | REL-MR-18DC/21AU |
| Single contact, 1-PDT | Single contact, 1-PDT |
| AgSnO | AgSnO, hard gold-plated |
| 250 V AC/DC | 30 V AC / 36 V DC |
| 5 V (at 100 mA) | 100 mV (at 10 mA) |
| 3 A | 50 mA |
| (on request) | 50 mA |
| 10 mA (at 12 V) | 1 mA (at 24 V) |
| 4 kV (50 Hz, 1 min.) | |
| -25°C ... 70°C | |
| 2 x 10 ⁷ cycles | |
| IEC 60664, EN 50178, IEC 62103 | |
| 3 / III | |
| 0.14 - 2.5 mm ² / 0.14 - 2.5 mm ² / 26 - 14 | |
| 6.2 mm / 80 mm / 94 mm | |

| Description | Voltage U _N |
|--|------------------------|
| PLC-INTERFACE basic terminal block, for plug-in miniature relay | |
| With spring-cage connection | 24 V DC |
| With push-in connection | 24 V DC |

| Ordering data | | |
|----------------------------------|-----------|-------------|
| Type | Order No. | Pcs. / Pkt. |
| PLC-BSP- 24DC/21RW ¹⁾ | 2961396 | 10 |
| PLC-BPT- 24DC/21RW ¹⁾ | 2900261 | 10 |

| Plug-in miniature relays | |
|--------------------------|--|
| with power contact | |
| with gold contact | |

| Accessories | | |
|-------------------|-----------|-------------|
| Type | Order No. | Pcs. / Pkt. |
| REL-MR- 18DC/21 | 2961383 | 10 |
| REL-MR- 18DC/21AU | 2961493 | 10 |

PLC-INTERFACE for railway applications

Relay module for input voltages with a nominal frequency of 16.7 Hz

The advantages:

- Input nominal frequency 16.7 Hz
- Vibration and shock resistance to EN 50155
- Safe isolation according to DIN EN 50178 between coil and contact
- Spring cage and push-in connection method

| Notes: |
|---|
| Type of housing: Polyamide PA non-reinforced, color: green. |
| Marking systems and mounting material See Catalog 5 |
| Separating plate PLC-ATP must be installed for voltages larger than 250 V (L1, L2, L3) between identical terminal blocks in adjacent modules. Potential bridging is then carried out with FBST 8-PLC... or FBST 500.... |
| If the specified maximum values for multi-layer contact relays are exceeded, the gold plating is destroyed. The values in parentheses then apply for further operation. This can result in a shorter service life than with a pure power contact. |
| 1) EMC: Class A product, see page 571 |



For 16.7 Hz input frequency with 2 PDTs



Technical data

| | |
|--|---|
| Input data | |
| Nominal input voltage U_N | 230 V AC |
| Input nominal frequency | 16.67 Hz |
| Permissible range (with reference to U_N) | (refer to the diagram) |
| Typ. input current at U_N | 4.8 mA (with AC) |
| Typ. response time at U_N | 20 ms |
| Typ. release time at U_N | 60 ms |
| Input circuit | Yellow LED, Bridge rectifier |
| Output data | |
| Contact type | Single contact, 2-PDT |
| Contact material | AgNi, hard gold-plated |
| Max. switching voltage | 30 V AC / 36 V DC (250 V AC/DC) |
| Min. switching voltage | 100 mV (5 V AC/DC) |
| Limiting continuous current | 50 mA (6 A) |
| Max. inrush current | 50 mA (8 A) |
| Min. switching current | 1 mA (10 mA) |
| General data | |
| Test voltage input/output | 6 kV |
| Ambient temperature (operation) | -25°C ... 60°C |
| Mechanical service life | Approx. 3×10^7 cycles |
| Standards/regulations | IEC 60664, EN 50178, IEC 62103 |
| Pollution degree / Surge voltage category | 2 / III |
| Connection data solid / stranded / AWG | 0.14 - 2.5 mm ² / 0.14 - 2.5 mm ² / 26 - 14 |
| Dimensions | 14 mm / 80 mm / 94 mm W / H / D |

Permissible input voltage range for PLC-RSP-230UC/21-21AU/RWF



Curve A
maximum continuous voltage at limiting continuous current = 6 A

Curve B
minimum operating voltage for pre-excitation with U_N and limiting continuous current = 6 A

Ordering data

| Description | Voltage U_N | Type | Order No. | Pcs. / Pkt. |
|-----------------------------|---------------|---|-----------|-------------|
| PLC-INTERFACE | | | | |
| With spring-cage connection | 230 V AC | PLC-RSP-230UC/21-21AU/RWF ¹⁾ | 2968001 | 10 |
| With push-in connection | 230 V AC | PLC-RPT-230UC/21-21AU/RWF ¹⁾ | 2900345 | 10 |

PLC-INTERFACE for railway applications

Relay modules with extended input voltage and temperature range, specifically designed for railway applications

The advantages:

- Certified to EN 50155
- Optimum relay operation thanks to wide-range electronics
- Temperature range from -40°C to +70°C (short-term 85°C)
- Input voltage range 0.7 to 1.25 x U_N (short-term 1.4 x U_N)
- Vibration and shock resistance to EN 50155
- Safe isolation according to DIN EN 50178 between coil and contact
- Spring cage and push-in connection method

| Notes: |
|---|
| Type of housing: Polyamide PA non-reinforced, color: green. |
| Marking systems and mounting material See Catalog 5 |
| Separating plate PLC-ATP must be installed for voltages larger than 250 V (L1, L2, L3) between identical terminal blocks in adjacent modules. Potential bridging is then carried out with FBST 8-PLC... or FBST 500.... |
| If the specified maximum values for multi-layer contact relays are exceeded, the gold plating is destroyed. The maximum values of the power contact relay are then valid. This can result in a shorter service life than with a pure power contact. |
| Electrical service life diagrams, see page 346 |
| 1) EMC: Class A product, see page 571 |



1 PDT



Technical data

| Input data | ① | ② | ③ |
|---|---|------------|------------|
| Permissible range (with reference to U _N) | 0.7 - 1.25 | 0.7 - 1.25 | 0.7 - 1.25 |
| Typ. input current at U _N | 9 [mA] | 3 | 2 |
| Typ. response time at U _N | 4 [ms] | 4 | 4 |
| Typ. release time at U _N | 4 [ms] | 4 | 4 |
| Input protection: | Yellow LED, Bridge rectifier, freewheeling diode | | |
| Output data | | | |
| Contact type | Single contact, 1-PDT | | |
| Contact material | AgSnO | | |
| Max. switching voltage | 250 V AC/DC | | |
| Min. switching voltage | 5 V (at 100 mA) | | |
| Limiting continuous current | 6 A | | |
| Max. inrush current | (on request) | | |
| Min. switching current | 10 mA (at 12 V) | | |
| General data | | | |
| Test voltage (winding / contact) | 4 kV _{rms} (50 Hz, 1 min.) | | |
| Ambient temperature (operation) | -40°C ... 70°C (Temperature class TX) | | |
| Mechanical service life | Approx. 2 x 10 ⁷ cycles | | |
| Standards/regulations | EN 50155 (VDE 0115 part 200), EN 50178, IEC 62103, EN 61373, EN 50121 | | |
| Connection data solid / stranded / AWG | 0.14 - 2.5 mm ² / 0.14 - 2.5 mm ² / 26 - 14 | | |
| Dimensions | W / H / D 6.2 mm / 80 mm / 94 mm | | |

| ① | ② | ③ |
|---|------------|------------|
| 0.7 - 1.25 | 0.7 - 1.25 | 0.7 - 1.25 |
| 9 [mA] | 3 | 2 |
| 4 [ms] | 4 | 4 |
| 4 [ms] | 4 | 4 |
| Yellow LED, Bridge rectifier, freewheeling diode | | |
| Single contact, 1-PDT | | |
| AgSnO | | |
| 250 V AC/DC | | |
| 5 V (at 100 mA) | | |
| 6 A | | |
| (on request) | | |
| 10 mA (at 12 V) | | |
| 4 kV _{rms} (50 Hz, 1 min.) | | |
| -40°C ... 70°C (Temperature class TX) | | |
| Approx. 2 x 10 ⁷ cycles | | |
| EN 50155 (VDE 0115 part 200), EN 50178, IEC 62103, EN 61373, EN 50121 | | |
| 0.14 - 2.5 mm ² / 0.14 - 2.5 mm ² / 26 - 14 | | |
| 6.2 mm / 80 mm / 94 mm | | |

Ordering data

| Description | Input voltage U _N | Type | Order No. | Pcs. / Pkt. | |
|---|------------------------------|-------------------------------------|-------------------------------------|-------------|----|
| PLC-INTERFACE, with power contact | With spring-cage connection | ① 24 V DC | PLC-RSP- 24UC/21/RW ¹⁾ | 2987011 | 10 |
| | | ② 72 V DC | PLC-RSP- 72UC/21/RW ¹⁾ | 2987037 | 10 |
| | | ③ 110 V DC | PLC-RSP-110UC/21/RW ¹⁾ | 2987053 | 10 |
| With push-in connection | ① 24 V DC | PLC-RPT- 24UC/21/RW ¹⁾ | 2900318 | 10 | |
| | ② 72 V DC | PLC-RPT- 72UC/21/RW ¹⁾ | 2900319 | 10 | |
| | ③ 110 V DC | PLC-RPT-110UC/21/RW ¹⁾ | 2900320 | 10 | |
| PLC-INTERFACE, with hard gold-plated contact | With spring-cage connection | ① 24 V DC | PLC-RSP- 24UC/21AU/RW ¹⁾ | 2987024 | 10 |
| | | ② 72 V DC | PLC-RSP- 72UC/21AU/RW ¹⁾ | 2987040 | 10 |
| | | ③ 110 V DC | PLC-RSP-110UC/21AU/RW ¹⁾ | 2987066 | 10 |
| With push-in connection | ① 24 V DC | PLC-RPT- 24UC/21AU/RW ¹⁾ | 2900321 | 10 | |
| | ② 72 V DC | PLC-RPT- 72UC/21AU/RW ¹⁾ | 2900322 | 10 | |
| | ③ 110 V DC | PLC-RPT-110UC/21AU/RW ¹⁾ | 2900323 | 10 | |

| Type | Order No. | Pcs. / Pkt. |
|-------------------------------------|-----------|-------------|
| PLC-RSP- 24UC/21/RW ¹⁾ | 2987011 | 10 |
| PLC-RSP- 72UC/21/RW ¹⁾ | 2987037 | 10 |
| PLC-RSP-110UC/21/RW ¹⁾ | 2987053 | 10 |
| PLC-RPT- 24UC/21/RW ¹⁾ | 2900318 | 10 |
| PLC-RPT- 72UC/21/RW ¹⁾ | 2900319 | 10 |
| PLC-RPT-110UC/21/RW ¹⁾ | 2900320 | 10 |
| PLC-RSP- 24UC/21AU/RW ¹⁾ | 2987024 | 10 |
| PLC-RSP- 72UC/21AU/RW ¹⁾ | 2987040 | 10 |
| PLC-RSP-110UC/21AU/RW ¹⁾ | 2987066 | 10 |
| PLC-RPT- 24UC/21AU/RW ¹⁾ | 2900321 | 10 |
| PLC-RPT- 72UC/21AU/RW ¹⁾ | 2900322 | 10 |
| PLC-RPT-110UC/21AU/RW ¹⁾ | 2900323 | 10 |



2 PDT



1 PDT up to 10 A

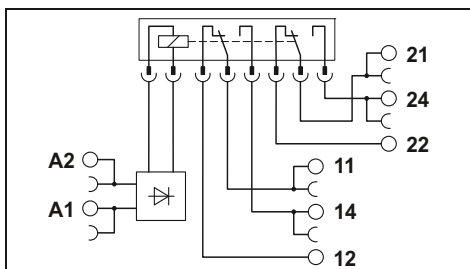

Technical data

| ① | ② | ③ |
|------------|------------|------------|
| 0.7 - 1.25 | 0.7 - 1.25 | 0.7 - 1.25 |
| 20 | 6 | 4.5 |
| 5 | 5 | 5 |
| 11 | 11 | 11 |

Yellow LED, Bridge rectifier, freewheeling diode

Single contact, 2-PDT

Single contact, 2-PDT

AgNi
250 V AC/DC
5 V (at 100 mA)
2x 6 A
15 A (300 ms)
10 mA (at 12 V)

AgNi, hard gold-plated
30 V AC / 36 V DC
100 mV
50 mA
50 mA
1 mA

5 kV_{rms} (50 Hz, 1 min.)

-40°C ... 70°C (Temperature class TX)

Approx. 3 x 10⁷ cycles

EN 50155 (VDE 0115 part 200), EN 50178, IEC 62103, EN 61373, EN 50121

0.14 - 2.5 mm² / 0.14 - 2.5 mm² / 26 - 14

14 mm / 80 mm / 94 mm

Ordering data

| Type | Order No. | Pcs. / Pkt. |
|--|-----------|-------------|
| PLC-RSP- 24UC/21-21/RW ¹⁾ | 2987105 | 10 |
| PLC-RSP- 72UC/21-21/RW ¹⁾ | 2987121 | 10 |
| PLC-RSP-110UC/21-21/RW ¹⁾ | 2987147 | 10 |
| PLC-RPT- 24UC/21-21/RW ¹⁾ | 2900346 | 10 |
| PLC-RPT- 72UC/21-21/RW ¹⁾ | 2900347 | 10 |
| PLC-RPT-110UC/21-21/RW ¹⁾ | 2900348 | 10 |
| PLC-RSP- 24UC/21-21AU/RW ¹⁾ | 2987118 | 10 |
| PLC-RSP- 72UC/21-21AU/RW ¹⁾ | 2987134 | 10 |
| PLC-RSP-110UC/21-21AU/RW ¹⁾ | 2987150 | 10 |
| PLC-RPT- 24UC/21-21AU/RW ¹⁾ | 2900349 | 10 |
| PLC-RPT- 72UC/21-21AU/RW ¹⁾ | 2900350 | 10 |
| PLC-RPT-110UC/21-21AU/RW ¹⁾ | 2900351 | 10 |

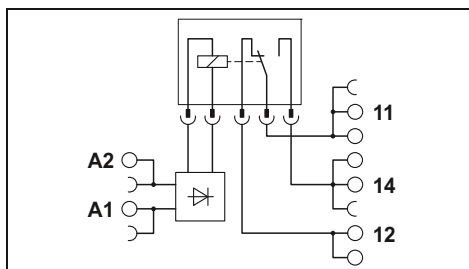

Technical data

| ① | ② | ③ |
|------------|------------|------------|
| 0.7 - 1.25 | 0.7 - 1.25 | 0.7 - 1.25 |
| 20 | 6 | 4.5 |
| 5 | 5 | 5 |
| 11 | 11 | 11 |

Yellow LED, Bridge rectifier, freewheeling diode

Single contact, 1-PDT

AgNi
250 V AC/DC
12 V AC/DC
10 A (With inserted bridge 2967691)
30 A (300 ms)
10 mA

5 kV_{rms} (50 Hz, 1 min.)

-40°C ... 70°C (Temperature class TX)

Approx. 3 x 10⁷ cycles

EN 50155 (VDE 0115 part 200), EN 50178, IEC 62103, EN 61373, EN 50121

0.14 - 2.5 mm² / 0.14 - 2.5 mm² / 26 - 14

14 mm / 80 mm / 94 mm

Ordering data

| Type | Order No. | Pcs. / Pkt. |
|-------------------------------------|-----------|-------------|
| PLC-RSP- 24UC/21HC/RW ¹⁾ | 2987079 | 10 |
| PLC-RSP- 72UC/21HC/RW ¹⁾ | 2987082 | 10 |
| PLC-RSP-110UC/21HC/RW ¹⁾ | 2987095 | 10 |
| PLC-RPT- 24UC/21HC/RW ¹⁾ | 2900324 | 10 |
| PLC-RPT- 72UC/21HC/RW ¹⁾ | 2900325 | 10 |
| PLC-RPT-110UC/21HC/RW ¹⁾ | 2900326 | 10 |

Derating curve for

PLC-RSP...21/RW
PLC-RSP...21AU/RW
PLC-RSP...21-21/RW
PLC-RSP...21-21AU/RW

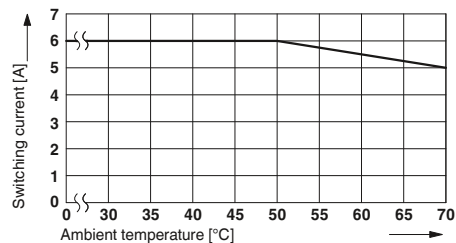

Interrupting rating for PLC-RSP...UC/21RW

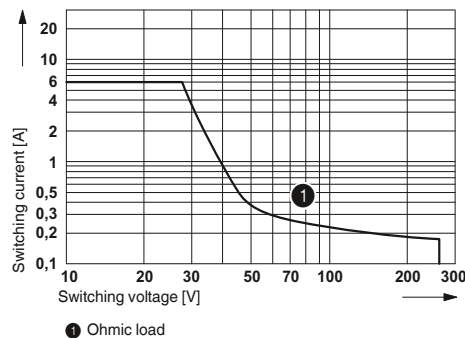

① Ohmic load

Interrupting rating for PLC-RSP...UC/21-21/RW

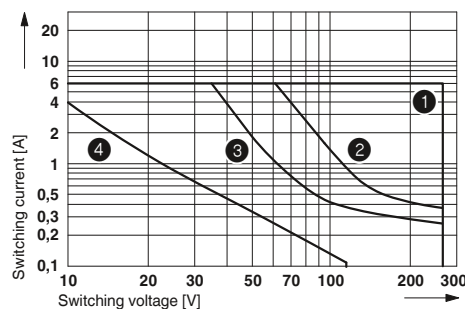

① AC, ohmic load
② DC, ohmic load, contacts in series
③ DC, ohmic load
④ DC, L/R = 40 ms

Interrupting rating for PLC-RSP...UC/21HC/RW

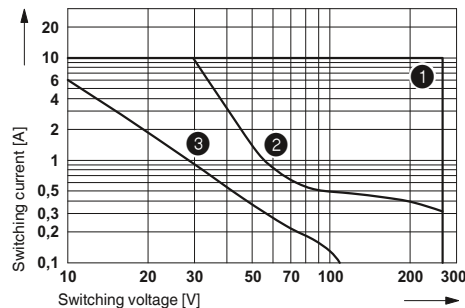

① AC, ohmic load
② DC, ohmic load
③ DC, L/R = 40 ms

PLC electronic sensor terminal block for NAMUR proximity sensors

The PLC-...EIK 1-SVN electronic sensor terminal block from Phoenix Contact converts the changeable resistance of a NAMUR sensor unit into a digital signal that can be read by all PLCs.

In addition, the electronics unit monitors the sensor side for short-circuits or wire breaks and reports this error via an integrated LED.

Due to a corresponding resistance circuit, the PLC-...-EIK 1-SVN can be used to monitor all mechanical switches (N/C contact or N/O contact) for short-circuits and/or wire break.

In addition to a high packing density, this switching amplifier features the following:

- Regulated power supply for the NAMUR proximity switch
- 24 V/50 mA digital output for directly connecting programmable logic controls
- Connection option for PLC-V8 adapter
- Screw, spring-cage, and push-in technology

Application 1

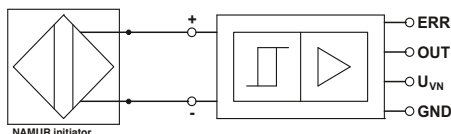

Application 2

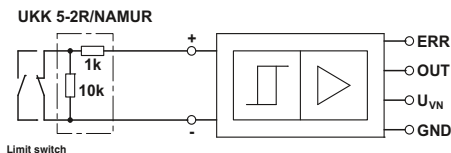

| Initiator state | Switching level | | LED | |
|-----------------|-----------------|-----|-------|-----|
| | OUT | ERR | Green | Red |
| conductive | L | L | OFF | OFF |
| blocking | H | L | ON | OFF |
| short circuit | L | H | OFF | ON |
| open circuit | L | H | OFF | ON |

Notes:

Type of housing:
Polyamide PA non-reinforced, color: green.

Marking systems and mounting material
See Catalog 5

Separating plate PLC-ATP is to be used in the following cases: always at the start and end of a PLC terminal strip, for voltages greater than 250 V (L1, L2, L3) between the same terminal points of neighboring modules (potential bridging then takes place with FBST 8-PLC... or FBST 500...) and with safe isolation between neighboring modules.

1) EMC: Class A product, see page 571



For inductive proximity sensors according to NAMUR, with light indicators for sensor signal and faults



Technical data

Supply

Input supply nominal voltage U_{VN}
Typ. input current at U_{VN}
Transmission frequency f_{limit}
Input circuit

24 V DC $\pm 20\%$

Approx. 14 mA

Approx. 350 Hz

Green LED, Protection against polarity reversal, Surge protection

Control circuit

No-load voltage
Switching points in accordance with EN 60947-5-6:

8.2 V DC $\pm 10\%$

≥ 2.1 mA (In conductive state)

≤ 1.2 mA (In blocking state)

6.3 mA ... 10 mA (in the event of a short-circuit)

0 mA ... 0.35 mA (In the event of a wire break)

Surge protection

Protective circuit

Alarm output

Operating voltage range (positive switching)
Limiting continuous current
Voltage drop at max. limiting continuous current
Output protection

$(U_{VN} - U_{Res})$

50 mA

≤ 1.5 V (U_R)

Red LED, Surge protection

Signal output

Limiting continuous current
Voltage drop U_R at max. limiting continuous current
Output protection

50 mA

≤ 1.5 V (U_R)

Surge protection

General data

Rated insulation voltage
Rated surge voltage / insulation
Ambient temperature (operation)
Standards/regulations
Pollution degree / Surge voltage category
Connection data solid / stranded / AWG
Dimensions

50 V DC

0.4 kV / Basic isolation

-25°C ... 50°C

IEC 60664, EN 50178, IEC 62103

2 / I

0.14 - 2.5 mm² / 0.14 - 2.5 mm² / 26 - 12

6.2 mm / 80 mm / 86 mm

W / H / D

Ordering data

Description

Switching amplifier electronic terminal block, positive switching

With screw connection
With spring-cage connection
With push-in connection

Type

PLC-SC-EIK 1-SVN 24P/P¹⁾

PLC-SP-EIK 1-SVN 24P/P¹⁾

PLC-PT-EIK 1-SVN 24P/P¹⁾

Order No.

2982663

2982676

2900397

Pcs. / Pkt.

10

10

10

Accessories

Double-level terminal block, with preassembled resistors

With screw connection

UKK 5-2R/NAMUR

2941662

50

PLC series

Electronic reversing load relay for DC motors

The PLC-S...-ELR W 1/2-24DC electronic reversing load relays are used to switch mechanically commutated DC motors up to 24 V/2 A.

- Wear-free reversing
- Braking by controlling both inputs
- Short-circuit and surge- and overload-proof output
- Integrated locking circuit and load wiring
- Screw, spring-cage, and push-in technology

| Notes: |
|---|
| Type of housing: Polyester PBT non-reinforced, color: green. |
| Marking systems and mounting material See Catalog 5 |
| Separating plate PLC-ATP is to be used in the following cases: always at the start and end of a PLC terminal strip, for voltages greater than 250 V (L1, L2, L3) between the same terminal points of neighboring modules (potential bridging then takes place with FBST 8-PLC... or FBST 500...) and with safe isolation between neighboring modules. |
| For the protection of input and output, inductive loads must be dampened with an effective protection circuit. |
| PWM = Pulse Width Modulation |
| 1) EMC: Class A product, see page 571 |



With overload and short-circuit-proof output

Application example for PLC-S...ELR W 1/2-24DC

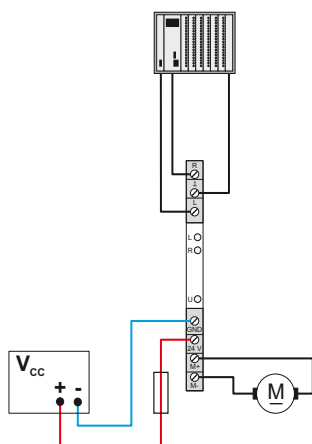

Status table

| Input | | Output | |
|-------|------|-----------------|-----------------|
| Right | Left | M + | M - |
| 0 | 0 | High resistance | High resistance |
| 1 | 0 | +24 V | GND |
| 0 | 1 | GND | +24 V |
| 1 | 1 | GND | GND |

Derating curve for PLC-S...ELR W 1/2-24DC



- 1 Aligned without spacing
- 2 Aligned with > 20 mm spacing

| | |
|-------------------------------|--|
| Input data | Control voltage U_{ST} right/left Control input current I_{ST} right/left Input protection: |
| PWM option | Max. clock frequency of the PWM at the control inputs |
| | Pulse width repetition rate of the PWM |
| Output data | Supply voltage range U_V Quiescent current Output protection |
| Motor switching output | Continuous current I_A max. Current limitation at short-circuits |
| General data | Rated insulation voltage Rated surge voltage / insulation Ambient temperature (operation) Standards/regulations Pollution degree / Surge voltage category Mounting position Mounting Connection data solid / stranded / AWG Dimensions |

(R)

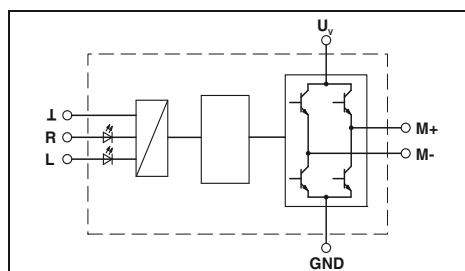

Technical data

| |
|--|
| 24 V DC $\pm 20\%$ Approx. 3 mA Yellow LED, Protection against polarity reversal, Surge protection |
| 1000 Hz |
| 0% ... 100% |
| 10 V DC ... 30 V DC 10 mA Green LED, Protection against polarity reversal, Surge protection |
| 2 A (see derating curve) 15 A (during braking) |
| 50 V DC 0.5 kV / basic insulation -25°C ... 60°C IEC 60664, EN 50178, IEC 62103 2 / II Vertical (horizontal DIN rail) In rows with zero spacing 0.14 - 2.5 mm ² / 0.14 - 2.5 mm ² / 26 - 14 6.2 mm / 80 mm / 86 mm |

Ordering data

| Type | Order No. | Pcs. / Pkt. |
|-------------------------------------|-----------|-------------|
| PLC-SC-ELR W1/ 2-24DC ¹⁾ | 2980539 | 1 |
| PLC-SP-ELR W1/ 2-24DC ¹⁾ | 2980555 | 1 |

PLC-INTERFACE Pulse expansion module

- A solid-state relay for acquiring and extending short pulses.
- Pulse detection can be set from > 0.1 ms or > 2 ms
- Status display
- Delay times of 10 to 2550, can be set via DIP switches
- Bridging options
- Can be retriggered
- Screw and push-in connection technology



With DC voltage output
Max. 100 mA



Technical data

| | | | |
|--|--|-----------|-------------|
| Input data | | | |
| Rated control supply voltage U_s | 24 V DC | | |
| Rated control supply voltage range with reference to U_s | 0.8 ... 1.2 | | |
| Rated control supply current I_s | | | |
| Input low, output low | 13 mA | | |
| Input high, output high | 19 mA | | |
| Rated actuating voltage U_c | 24 V DC | | |
| Rated actuating current I_c | 3 mA | | |
| Switching threshold "0" signal in reference to U_c | < 0.4 | | |
| Switching threshold "1" signal in reference to U_c | > 0.8 | | |
| Status indication | Yellow LED | | |
| Operating voltage display | Green LED | | |
| Input circuit | Protection against polarity reversal, Surge protection | | |
| Output data | | | |
| Output voltage range U_E | 3 V DC ... 48 V DC | | |
| Limiting continuous current | 100 mA | | |
| Voltage drop at max. limiting continuous current | < 1 V DC | | |
| Output circuit | 3-conductor, ground-referenced | | |
| Output protection | Protection against polarity reversal, Surge protection, Free running | | |
| General data | | | |
| Rated insulation voltage | 50 V DC | | |
| Rated surge voltage | 0.5 kV | | |
| Ambient temperature (operation) | -25°C ... 60°C | | |
| Standards/regulations | DIN EN 50178 | | |
| Connection data solid / stranded / AWG | 0.14 - 2.5 mm ² / 0.14 - 2.5 mm ² / 26 - 14 | | |
| Dimensions | 6.2 mm / 80 mm / 86 mm | | |
| | W / H / D | | |
| Ordering data | | | |
| Description | Type | Order No. | Pcs. / Pkt. |
| PLC INTERFACE, with screw connection | PLC-OSC-LPE-24DC/48DC/100 | 2903171 | 1 |
| PLC-INTERFACE, with push-in connection | PLC-OPT-LPE-24DC/48DC/100 | 2903173 | 1 |

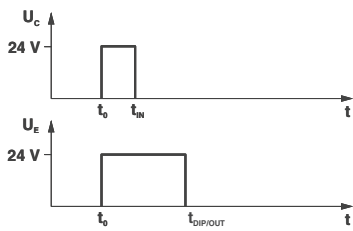

Input pulse $t_1 <$ set output pulse t_3
(no restart when triggered again)

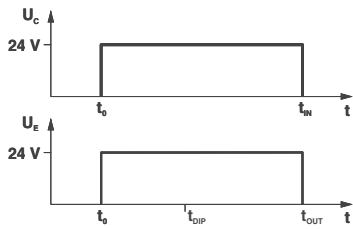

Input pulse $t_1 \geq$ set output pulse t_3 , then input pulse $t_1 =$ output pulse t_2
(no restart when triggered again)

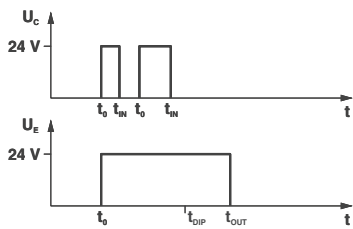

Input pulse $t_1 <$ set output pulse t_3
(restart when triggered again)

| DIP | | | | | | | |
|-----|----|----|----|-----|-----|-----|------|
| S1 | S2 | S3 | S4 | S5 | S6 | S7 | S8 |
| 10 | - | - | - | - | - | - | - |
| - | 20 | - | - | - | - | - | - |
| - | - | 40 | - | - | - | - | - |
| - | - | - | 80 | - | - | - | - |
| - | - | - | - | 160 | - | - | - |
| - | - | - | - | - | 320 | - | - |
| - | - | - | - | - | - | 640 | - |
| - | - | - | - | - | - | - | 1280 |

Relay modules

PLC series

PLC accessories

The **PLC-ESK** power terminal helps with supplying the bridge potentials; the **PLC-ATP** partition plate helps with optical and safe disconnection of the adjacent PLC modules. The **PLC-BP (A1-14)** passive feed-through bridge is used instead of a relay and connects the A1 and 14 terminal points.



| Description | Color |
|---|-------|
| Power terminal block , for supply of up to four potentials, with the same shape as PLC standard series, max. 32 A/250 V AC | |
| Separating plate , thickness 2 mm, required at the start and end of a PLC terminal strip. It is also used for visual separation of groups, safe isolation of different voltages of neighboring PLC interfaces as per DIN EN 50178/VDE0160, separation of neighboring bridges of different potentials, and separation of PLC interfaces at voltages > 250 V | gray |
| Screwdriver Blade: 0.6 x 3.5 x 100 mm, length: 181 mm | black |
| Passive feed-through bridge , can be plugged in instead of relay or solid-state relay, bridges terminal points A1 and 14 | black |

| Ordering data | | |
|---------------|-----------|-------------|
| Type | Order No. | Pcs. / Pkt. |
| PLC-ESK GY | 2966508 | 5 |
| PLC-ATP BK | 2966841 | 25 |
| SZF 1-0,6X3,5 | 1204517 | 10 |

| Ordering data | | |
|---------------|-----------|-------------|
| Type | Order No. | Pcs. / Pkt. |
| PLC-BP A1-14 | 2980283 | 10 |

PLC accessories

The colored isolated FBST plug-in bridges are not required for the PLC interface up to 70%. The 500 mm long **FBST 500-PLC** “endless bridges” are especially effective. The 2-pos. **FBST 6** single plug-in bridges are especially suited for bridging a smaller number of PLC modules.



| Description | Color |
|--|---------------------|
| Cont. plug-in bridge , 500 mm long, isolated, can be cut to length, for potential distribution Nominal current: 32 A | red blue gray |
| Plug-in bridge , 2-pos., 6 mm long, for potential distribution Nominal current: 6 A | red blue gray |
| Plug-in bridge , 2-pos., 8 mm long, for potential distribution with a partition plate Nominal current: 6 A | gray |
| Plug-in bridge , 2-pos., 14 mm long, insulated, for potential distribution Nominal current: 10 A | black |
| Zack marker strip , printed horizontally, 10-section, with consecutive numbers, e.g., 1-10, 11-20, etc. up to 91-100 | |

| Ordering data | | |
|-----------------|-----------|-------------|
| Type | Order No. | Pcs. / Pkt. |
| FBST 500-PLC RD | 2966786 | 20 |
| FBST 500-PLC BU | 2966692 | 20 |
| FBST 500-PLC GY | 2966838 | 20 |
| FBST 6-PLC RD | 2966236 | 50 |
| FBST 6-PLC BU | 2966812 | 50 |
| FBST 6-PLC GY | 2966825 | 50 |
| FBST 8-PLC GY | 2967688 | 50 |
| FBST 14-PLC BK | 2967691 | 50 |

| Ordering data | | |
|-----------------------|-----------|-------------|
| Type | Order No. | Pcs. / Pkt. |
| ZB 6,LGS:FORTL.ZAHLEN | 1051016 | 10 |

Adapter for PLC-INTERFACE

PLC-V8/... are VARIOFACE adapters which connect the 6.2 mm wide PLC RELAY modules to the VARIOFACE system cabling

Notes:
For cross-reference list with matching PLC-INTERFACE modules, see page 488



VARIOFACE adapter for 6.2 mm PLC-INTERFACE



VARIOFACE adapter for 14 mm PLC-INTERFACE



| | |
|--|--------------|
| Max. perm. operating voltage | |
| Max. perm. current (per branch) | |
| Max total current (voltage supply) | |
| Test voltage | |
| Ambient temperature (operation) | |
| Standards/regulations | |
| Connection method | Power supply |
| | Signal level |
| Connection data solid / stranded / AWG | |
| Dimensions | H / D |

| Technical data | |
|---|--|
| 24 V DC ±25% | |
| 1 A (per signal path) | |
| 3 A | |
| 500 V AC (50 Hz, 1 min.) | |
| -40°C ... 70°C | |
| IEC 60664, DIN EN 50178, IEC 62103 | |
| Screw connection | |
| IDC/FLK pin strip (2.54 mm) | |
| 0.2 ... 4 mm ² / 0.2 ... 2.5 mm ² / 24 - 12 | |
| 100 mm / 94 mm | |

| Technical data | |
|---|--|
| 24 V DC ±25% | |
| 1 A (per signal path) | |
| 3 A | |
| 500 V (50 Hz, 1 min.) | |
| -40°C ... 70°C | |
| IEC 60664, DIN EN 50178, IEC 62103 | |
| Screw connection | |
| IDC/FLK pin strip (2.54 mm) | |
| 0.2 ... 4 mm ² / 0.2 ... 2.5 mm ² / 24 - 12 | |
| 100 mm / 94 mm | |

| Description | No. of pos. | Module width W |
|--|-------------|----------------|
| V8 adapter , for 8 PLC interfaces (6.2 mm), with F LK connection, for PLC system cabling, positive switching | | |
| OUTPUT | 14 | 49.6 mm |
| INPUT | 14 | 49.6 mm |
| V8 adapter , for 8 PLC interfaces (6.2 mm), with FLK connection, for PLC system cabling, negative switching | | |
| OUTPUT | 14 | 49.6 mm |
| INPUT | 14 | 49.6 mm |
| V8 output adapter , for 8 PLC interfaces (6.2 mm), with 15-pos. D-SUB connection | | |
| Pin strip | 15 | 49.6 mm |
| Socket strip | 15 | 49.6 mm |
| V8 input adapter , for 8 PLC interfaces (6.2 mm), with 15-pos. D-SUB connection | | |
| Pin strip | 15 | 49.6 mm |
| Socket strip | 15 | 49.6 mm |
| V8 adapter , for 8 PLC interfaces (14 mm), with FLK connection, for PLC system cabling, positive switching | 14 | 112.3 mm |
| V8 adapter , for 8 PLC interfaces (14 mm), with FLK connection, for PLC system cabling, negative switching | 14 | 112.3 mm |

| Ordering data | | |
|--------------------|-----------|-------------|
| Type | Order No. | Pcs. / Pkt. |
| PLC-V8/FLK14/OUT | 2295554 | 1 |
| PLC-V8/FLK14/IN | 2296553 | 1 |
| PLC-V8/FLK14/OUT/M | 2304102 | 1 |
| PLC-V8/FLK14/IN/M | 2304115 | 1 |
| PLC-V8/D15S/OUT | 2296058 | 1 |
| PLC-V8/D15B/OUT | 2296061 | 1 |
| PLC-V8/D15S/IN | 2296074 | 1 |
| PLC-V8/D15B/IN | 2296087 | 1 |

| Ordering data | | |
|---------------------|-----------|-------------|
| Type | Order No. | Pcs. / Pkt. |
| PLC-V8L/FLK14/OUT | 2299660 | 1 |
| PLC-V8L/FLK14/OUT/M | 2304306 | 1 |



The PR series is a low-priced relay modular system, consisting of DIN rail bases, relays, plug-in input/interference suppression modules, engagement levers, and the matching marking labels and universal bridging materials for all bases. The modules are largely compatible with the usual standards on the market, have the major international approvals and are therefore accepted worldwide.

Besides the familiar relay bases with the screw connection method, relay bases with the spring-cage connection method for miniature power relays with one or two PDT contacts and for industrial relays with two or four PDT contacts are available in the PR series. The connections in these bases are configured with double spring cages for free, simple bridging of all potentials.

The PR series also boasts its own particular features:

- Relay retaining bracket: The EL... plastic relay retaining bracket, with which the relays can be held and, if necessary, ejected, have an exposed, smooth, large equipment marking area for standard self-adhesive labels that can be printed easily and inexpensively using standard printers. When fitted, the engagement lever is securely connected to the base, which means that the labeling cannot be lost.
- Industrial relays: All REL-IR... industrial relays have as standard an LED status display

and all DC types also have an integrated freewheeling diode. In most cases, this eliminates the plug-in input modules that are otherwise also used.

- Plug-in input modules with RC element: most standard input/interference suppression modules with an RC element used for compensation of interference coupling on long lines or in the event of leakage currents from electronic AC outputs have only low capacitance values. This greatly limits the filter effect. In contrast, the RC-120-230UC and RC3-120-230UC plug-in module series for mains voltage applications have a filter function that is improved up to a factor of 10. Unlike with the discharge resistors that are normally used for such applications, using RC plug-in modules gives rise to no additional heating!



PR1 series

The narrow 16 mm PR1 base series for relays with one or two contacts is available with a screw or spring-cage connection method. Both the traditional 2/2-level bases and two modern “logical” 1/3-level versions with fully opposite coil and contact connections are available.



PR2 series

The PR2 base series accommodates plug-in industrial relays with two or four PDT contacts. Like the PR1 series, the bases are available with screw and spring-cage connection methods, as well as in the traditional 2/2-level and modern “logical” 1/3-level versions.



PR3 series

The robust octal relays with two or three PDT contacts that are widely used in some areas fit on the PR3 base with touch-protected screw connections. All the base connections have a wide connection cross section and are arranged on one level with good accessibility.



The active components of the PR1 modular system include various miniature power relays (optionally available with manual test function) and electronic solid-state relays. Matching relay retaining brackets with integrated marking area prevent them from being shaken loose. Depending on requirements, input/interference suppression modules with various functions can also be plugged in. Marking labels and loop bridges in various colors that are suitable for universal use with all PR bases complete the range of accessories.



The PR2 modular system is specifically designed for plug-in industrial relays. Industrial relays from Phoenix Contact feature the following as standard: a manual test button, switch position indicator, status LED, and freewheeling diode (DC coils only). Interference suppression modules with a varistor or RC element can also be plugged in as an option. Relay retaining brackets with integrated marking areas prevent the relays from being shaken loose. Marking labels and loop bridges in various colors that are suitable for universal use with all PR bases complete the range of accessories.



The PR3 modular system is specifically designed for the robust octal relays. The relays have a switch position indicator and a manual test button and there is a wire bracket to prevent them from being shaken loose. Input/interference suppression modules with various functions can also be plugged in as an option. The base can be marked with an 8 x 20 mm standard adhesive label. Loop bridges in various colors for universal use round off the range of accessories.

Relay modules

PR series

Modular PR1 relay base

Range of relay bases that can be fitted with 1 PDT or 2 PDT relay or solid-state relay

Range of accessories includes:

- Plug-in input modules/interference suppression modules
- Relay retaining bracket with labeling field and ejection function
- Marking labels
- Loop bridges

| Notes: |
|--|
| Type of housing: Polyamide fiber reinforced PA-F, color: green. |
| Marking systems and mounting material See Catalog 5 |

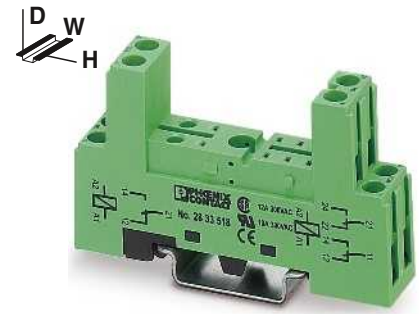

2/2-level design with screw connection

| | |
|--|---|
| Nominal voltage U_N | 300 V AC/DC |
| Nominal current at U_N | 12 A |
| General data | |
| Ambient temperature (operation) | -25°C ... 85°C |
| Connection data solid / stranded / AWG | 0.2 ... 2.5 mm ² / 0.2 ... 2.5 mm ² / 26 - 14 |
| Dimensions | |
| Width | 16 mm |
| Depth with retaining bracket | 63 mm (EL1-P16) 71 mm (EL1-P25) |
| Height | 75 mm |



Technical data

| | |
|--|---|
| Nominal voltage U_N | 300 V AC/DC |
| Nominal current at U_N | 12 A |
| General data | |
| Ambient temperature (operation) | -25°C ... 85°C |
| Connection data solid / stranded / AWG | 0.2 ... 2.5 mm ² / 0.2 ... 2.5 mm ² / 26 - 14 |
| Dimensions | |
| Width | 16 mm |
| Depth with retaining bracket | 63 mm (EL1-P16) 71 mm (EL1-P25) |
| Height | 75 mm |

Ordering data

| Description |
|--|
| Relay base PR1 , 2/2-level design, plug-in option for input/interference suppression module, safe isolation I/O, including ten MP1 marking labels per pack |
| With screw connection Relay base PR1 , 1/3-level design, plug-in option for input/interference suppression module, safe isolation I/O, including ten MP1 marking labels per pack |
| With screw connection Relay base PR1 , 1/3-level design, plug-in option for input/interference suppression module, safe isolation I/O, including ten MP1 marking labels per pack |
| With spring-cage connection Relay retaining bracket , with ejector function and integrated equipment marking area (7.5 x 15 mm), suitable for relay socket PR1 |
| for 16 mm tall miniature power relay and solid-state relay |
| for 25 mm tall miniature switching relay and solid-state relay |

| Type | Order No. | Pcs. / Pkt. |
|---------------|-----------|-------------|
| PR1-BSC2/2X21 | 2833518 | 10 |
| EL1-P16 | 2833547 | 10 |
| EL1-P25 | 2833550 | 10 |

Accessories

| | |
|--|-----------------------|
| Equipment marking label , labeling surface 6 x 15 mm | |
| Device marking label , for thermal transfer printer, labeling surface 6 x 15 mm 2500 labels per roll | |
| Loop bridge , 50-pos., divisible, max. bridging distance 60 mm, 0.5 mm ² | blue black gray |

| | | |
|-----------------|---------|----|
| MP 1 | 2833631 | 10 |
| EML (15X6) R YE | 0819288 | 1 |
| DB 50- 90 BU | 2821180 | 1 |
| DB 50- 90 BK | 2820916 | 1 |
| DB 50- 90 GY | 2820929 | 1 |

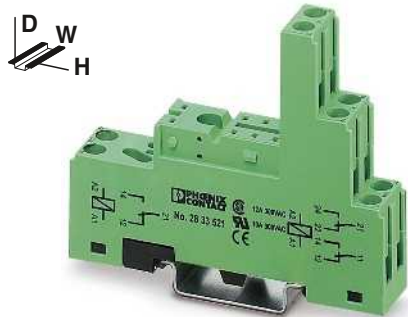

1/3-level design with screw connection

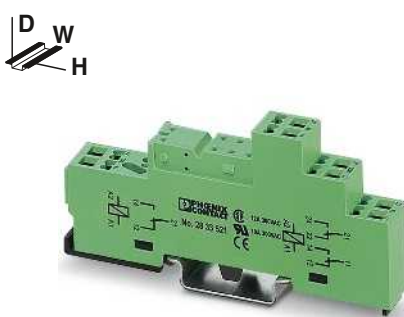

1/3-level design with spring-cage connection



Relay retaining bracket



| Technical data | | |
|---|--|--|
| 300 V AC/DC | | |
| 12 A | | |
| -25°C ... 85°C | | |
| 0.2 ... 2.5 mm ² / 0.2 ... 2.5 mm ² / 26 - 14 | | |
| 16 mm | | |
| 71 mm (EL1-P16) | | |
| 79 mm (EL1-P25) | | |
| 78.5 mm | | |

| Technical data | | |
|---|--|--|
| 300 V AC/DC | | |
| 10 A | | |
| -25°C ... 85°C | | |
| 0.5 ... 1.5 mm ² / 0.5 ... 1.5 mm ² / 26 - 16 | | |
| 16 mm | | |
| 72 mm (EL1-P16) | | |
| 80 mm (EL1-P25) | | |
| 97 mm | | |

| Technical data | | |
|----------------|---|---|
| - | - | - |
| - | - | - |
| - | - | - |
| - | - | - |
| - | - | - |

| Ordering data | | |
|---------------|-----------|-------------|
| Type | Order No. | Pcs. / Pkt. |
| PR1-BSC3/2X21 | 2833521 | 10 |
| EL1-P16 | 2833547 | 10 |
| EL1-P25 | 2833550 | 10 |

| Ordering data | | |
|---------------|-----------|-------------|
| Type | Order No. | Pcs. / Pkt. |
| PR1-BSP3/2X21 | 2833534 | 10 |
| EL1-P16 | 2833547 | 10 |
| EL1-P25 | 2833550 | 10 |

| Ordering data | | |
|---------------|-----------|-------------|
| Type | Order No. | Pcs. / Pkt. |
| EL1-P16 | 2833547 | 10 |
| EL1-P25 | 2833550 | 10 |

| Accessories | | |
|-----------------|-----------|-------------|
| Type | Order No. | Pcs. / Pkt. |
| MP 1 | 2833631 | 10 |
| EML (15X6) R YE | 0819288 | 1 |
| DB 50- 90 BU | 2821180 | 1 |
| DB 50- 90 BK | 2820916 | 1 |
| DB 50- 90 GY | 2820929 | 1 |

| Accessories | | |
|-----------------|-----------|-------------|
| Type | Order No. | Pcs. / Pkt. |
| MP 1 | 2833631 | 10 |
| EML (15X6) R YE | 0819288 | 1 |
| DB 50- 90 BU | 2821180 | 1 |
| DB 50- 90 BK | 2820916 | 1 |
| DB 50- 90 GY | 2820929 | 1 |

| Accessories | | |
|-------------|-----------|-------------|
| Type | Order No. | Pcs. / Pkt. |
| | | |
| | | |

Relay modules

PR series

Plug-in miniature power relays

Plug-in miniature power relays with 1 or 2 PDT contacts, suitable for RIF-1, PR1, and PLC-INTERFACE relay bases.

The advantages:

- Power contacts up to 16 A
- Multi-layer gold contact or power contact
- High degree of protection up to RT III (comparable with IP67) depending on type



1 PDT relay



2 PDT relay

Notes:
If the specified maximum values for multi-layer contact relays are exceeded, the gold plating is destroyed. The maximum values of the power contact relay are then valid. This can result in a shorter service life than with a pure power contact.



Technical data

| | ① | ② | ③ | ④ | ⑤ | ⑥ | ⑦ | ⑧ |
|---|----|----|-----|-----|-----|------|------|------|
| refer to the diagram | | | | | | | | |
| Typ. input current at U_N | 33 | 17 | 8.7 | 8.2 | 4.1 | 32 | 7 | 3 |
| Typ. response time at U_N | 7 | 7 | 7 | 7 | 7 | | | |
| Typ. response time at U_N (depending on phase relation) | | | | | | 3-12 | 3-12 | 3-12 |
| Typ. release time at U_N | 3 | 3 | 3 | 3 | 3 | | | |
| Typ. release time at U_N (depending on phase relation) | | | | | | 2-9 | 2-9 | 2-9 |

Technical data

| | ① | ② | ③ | ④ | ⑤ | ⑥ | ⑦ | ⑧ |
|---|----|----|-----|-----|-----|------|------|------|
| refer to the diagram | | | | | | | | |
| Typ. input current at U_N | 33 | 17 | 8.7 | 8.2 | 4.1 | 32 | 7 | 3 |
| Typ. response time at U_N | 7 | 7 | 7 | 7 | 7 | | | |
| Typ. response time at U_N (depending on phase relation) | | | | | | 3-12 | 3-12 | 3-12 |
| Typ. release time at U_N | 3 | 3 | 3 | 3 | 3 | | | |
| Typ. release time at U_N (depending on phase relation) | | | | | | 2-9 | 2-9 | 2-9 |

| Output data | |
|--------------------------------------|--------------------------------|
| Contact type | Single contact, 1-PDT |
| Contact material | AgNi |
| Max. switching voltage | 250 V AC/DC |
| Min. switching voltage | 12 V (at 10 mA) |
| Limiting continuous current | 16 A |
| Max. inrush current | 25 A (20 ms) |
| Min. switching current | 10 mA (at 12 V) |
| Max. interrupting rating, ohmic load | 250 V AC |
| General data | |
| Test voltage (winding / contact) | 5 kV AC (50 Hz, 1 min.) |
| Test voltage (contact/contact) | - |
| Ambient temperature (operation) | -40°C ... 85°C |
| Mechanical service life | 1 x 10 ⁷ cycles |
| Electrical service life | See diagram |
| Standards/regulations | IEC 60664, EN 50178, IEC 62103 |

| Output data | |
|--------------------------------------|--------------------------------|
| Contact type | Single contact, 1-PDT |
| Contact material | AgNi, hard gold-plated |
| Max. switching voltage | 30 V AC / 36 V DC |
| Min. switching voltage | 100 mV (at 10 mA) |
| Limiting continuous current | 50 mA |
| Max. inrush current | 50 mA |
| Min. switching current | 1 mA (at 24 V) |
| Max. interrupting rating, ohmic load | - |
| General data | |
| Test voltage (winding / contact) | 5 kV AC (50 Hz, 1 min.) |
| Test voltage (contact/contact) | - |
| Ambient temperature (operation) | -40°C ... 85°C |
| Mechanical service life | 1 x 10 ⁷ cycles |
| Electrical service life | See diagram |
| Standards/regulations | IEC 60664, EN 50178, IEC 62103 |

| Output data | |
|--------------------------------------|--------------------------------|
| Contact type | Single contact, 2-PDT |
| Contact material | AgNi |
| Max. switching voltage | 250 V AC/DC |
| Min. switching voltage | 5 V (at 10 mA) |
| Limiting continuous current | 8 A |
| Max. inrush current | 12 A (20 ms) |
| Min. switching current | 10 mA (At 5 V) |
| Max. interrupting rating, ohmic load | 2000 VA |
| General data | |
| Test voltage (winding / contact) | 5 kV AC (50 Hz, 1 min.) |
| Test voltage (contact/contact) | 2.5 kV AC (50 Hz, 1 min.) |
| Ambient temperature (operation) | -40°C ... 85°C |
| Mechanical service life | 1 x 10 ⁷ cycles |
| Electrical service life | See diagram |
| Standards/regulations | IEC 60664, EN 50178, IEC 62103 |

Ordering data

| Type | Order No. | Pcs. / Pkt. |
|----------------------|-----------|-------------|
| REL-MR- 12DC/21HC | 2961309 | 10 |
| REL-MR- 24DC/21HC | 2961312 | 10 |
| REL-MR- 48DC/21HC | 2834821 | 10 |
| REL-MR- 60DC/21HC | 2961325 | 10 |
| REL-MR-110DC/21HC | 2961338 | 10 |
| REL-MR- 24AC/21HC | 2961406 | 10 |
| REL-MR-120AC/21HC | 2961419 | 10 |
| REL-MR-230AC/21HC | 2961422 | 10 |
| REL-MR- 12DC/21HC AU | 2961532 | 10 |
| REL-MR- 24DC/21HC AU | 2961545 | 10 |
| REL-MR-110DC/21HC AU | 2961561 | 10 |
| REL-MR- 24AC/21HC AU | 2961503 | 10 |
| REL-MR-120AC/21HC AU | 2961516 | 10 |
| REL-MR-230AC/21HC AU | 2961529 | 10 |

Ordering data

| Type | Order No. | Pcs. / Pkt. |
|----------------------|-----------|-------------|
| REL-MR- 12DC/21-21 | 2961257 | 10 |
| REL-MR- 24DC/21-21 | 2961192 | 10 |
| REL-MR- 48DC/21-21 | 2834834 | 10 |
| REL-MR- 60DC/21-21 | 2961273 | 10 |
| REL-MR-110DC/21-21 | 2961202 | 10 |
| REL-MR- 24AC/21-21 | 2961435 | 10 |
| REL-MR-120AC/21-21 | 2961448 | 10 |
| REL-MR-230AC/21-21 | 2961451 | 10 |
| REL-MR- 12DC/21-21AU | 2961299 | 10 |
| REL-MR- 24DC/21-21AU | 2961215 | 10 |
| REL-MR- 48DC/21-21AU | 2834847 | 10 |
| REL-MR- 60DC/21-21AU | 2961286 | 10 |
| REL-MR-110DC/21-21AU | 2961228 | 10 |
| REL-MR- 24AC/21-21AU | 2961464 | 10 |
| REL-MR-120AC/21-21AU | 2961477 | 10 |
| REL-MR-230AC/21-21AU | 2961480 | 10 |

| Description | Input voltage U_N |
|---------------------------------------|---------------------|
| Plug-in miniature power relays | |
| with power contact | ① 12 V DC |
| with power contact | ② 24 V DC |
| with power contact | ③ 48 V DC |
| with power contact | ④ 60 V DC |
| with power contact | ⑤ 110 V DC |
| with power contact | ⑥ 24 V AC |
| with power contact | ⑦ 120 V AC |
| with power contact | ⑧ 230 V AC |
| Plug-in miniature power relays | |
| with gold contact | ① 12 V DC |
| with gold contact | ② 24 V DC |
| with gold contact | ③ 48 V DC |
| with gold contact | ④ 60 V DC |
| with gold contact | ⑤ 110 V DC |
| with gold contact | ⑥ 24 V AC |
| with gold contact | ⑦ 120 V AC |
| with gold contact | ⑧ 230 V AC |

REL-MR...21HC... (1 PDT)

Operating voltage range

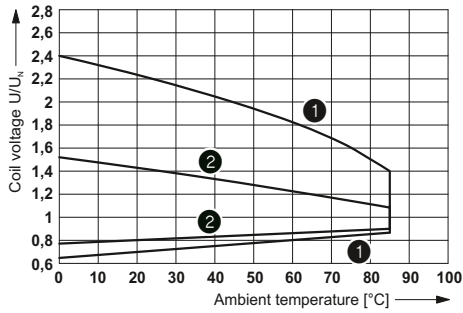

- 1 DC coils
- 2 AC coils

Interrupting rating

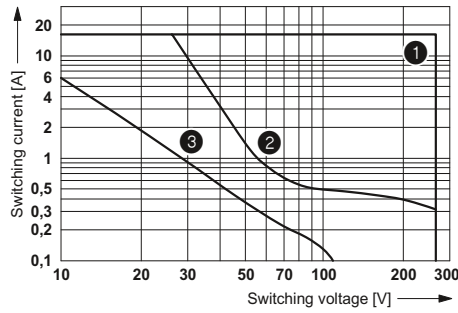

- 1 AC, ohmic load
- 2 DC, ohmic load
- 3 DC, L/R = 40 ms

Electrical service life

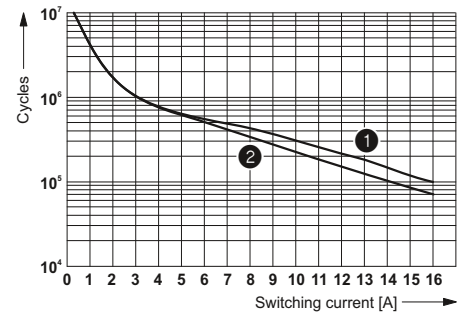

- 1 250 V AC, ohmic load (DC coils)
- 2 250 V AC, ohmic load (AC coils)

Service life reduction factor with various cos phi

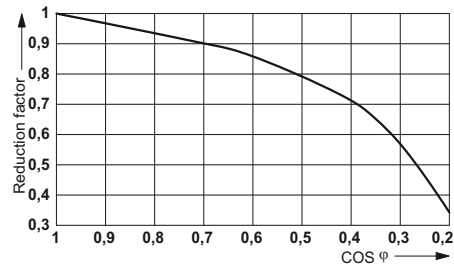

REL-MR...21-21... (2 PDTs)

Operating voltage range

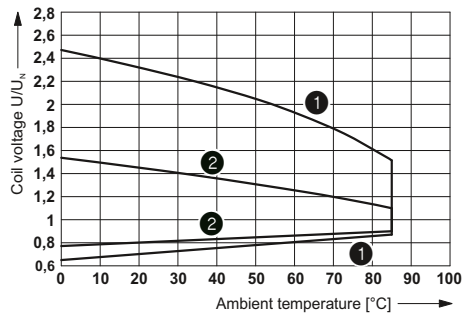

- 1 DC coils
- 2 AC coils

Interrupting rating

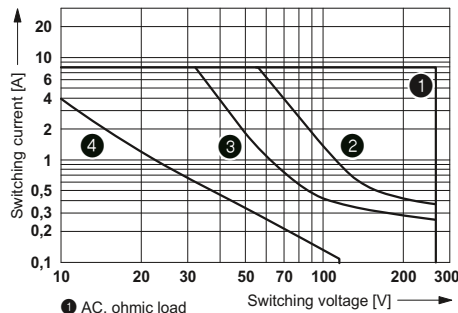

- 1 AC, ohmic load
- 2 DC, ohmic load, contacts in series
- 3 DC, ohmic load
- 4 DC, L/R = 40 ms

Electrical service life

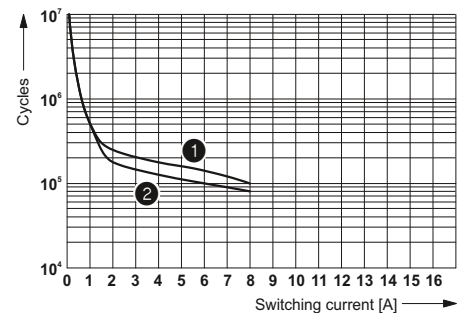

- 1 250 V AC, ohmic load (DC coils)
- 2 250 V AC, ohmic load (AC coils)

Service life reduction factor with various cos phi

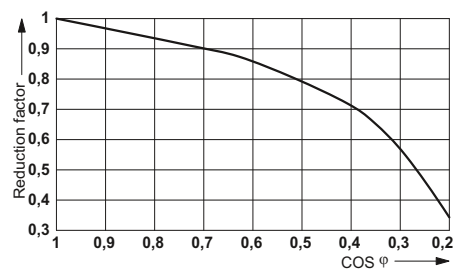

Relay modules

PR series

Plug-in miniature power relays

Plug-in miniature power relays with 1 or 2 PDT contacts, suitable for RIF-1 and PR1 relay bases.

The advantages:

- Switching current of up to 16 A
- With lockable manual operation
- Mechanical switch position indicator
- Integrated status LED
- Multi-layer gold contact or power contact
- DC types with integrated freewheeling diode
- Can be soldered in on PCB



1 PDT relay



2 PDT relay

Notes:

If the specified maximum values for multi-layer contact relays are exceeded, the gold plating is destroyed. The maximum values of the power contact relay are then valid. This can result in a shorter service life than with a pure power contact.

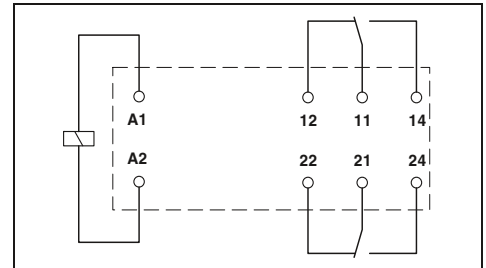
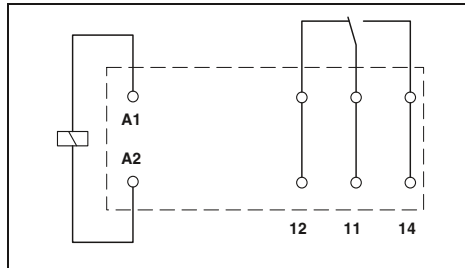

Technical data

| ① | ② | ③ | ④ |
|----------------------|----|--------|--------|
| refer to the diagram | | | |
| 18 | 32 | 7 | 3.5 |
| 9 | | 3 - 12 | 3 - 12 |
| 6 | | 2 - 8 | 2 - 8 |

Technical data

| ① | ② | ③ | ④ |
|----------------------|----|--------|--------|
| refer to the diagram | | | |
| 18 | 32 | 7 | 3.5 |
| 9 | | 3 - 12 | 3 - 12 |
| 6 | | 2 - 8 | 2 - 8 |

| Input data | |
|--|----------|
| Permissible range (with reference to U_N) | |
| Typ. input current at U_N | [mA] |
| Typ. response time at U_N | [ms] |
| Typ. response time at U_N (depending on phase relation) | [ms] |
| Typ. release time at U_N | [ms] |
| Typ. release time at U_N (depending on phase relation) | [ms] |
| Output data | |
| Contact type | |
| Contact material | |
| Max. switching voltage | |
| Min. switching voltage | |
| Limiting continuous current | |
| Max. inrush current | |
| Min. switching current | |
| Max. interrupting rating, ohmic load | 250 V AC |
| General data | |
| Test voltage (winding / contact) | |
| Test voltage (contact/contact) | |
| Ambient temperature (operation) | |
| Mechanical service life | |
| Electrical service life | |
| Standards/regulations | |

| Technical data | |
|--------------------------------------|---|
| Contact type | Single contact, 1-PDT |
| Contact material | AgNi |
| Max. switching voltage | 250 V AC/DC |
| Min. switching voltage | 12 V (at 10 mA) |
| Limiting continuous current | 16 A |
| Max. inrush current | 32 A (20 ms) |
| Min. switching current | 10 mA (at 12 V) |
| Max. interrupting rating, ohmic load | 4000 VA |
| General data | |
| Test voltage (winding / contact) | 5 kV AC (50 Hz, 1 min.) |
| Test voltage (contact/contact) | - |
| Ambient temperature (operation) | -40°C ... 70°C |
| Mechanical service life | 5 x 10 ⁶ cycles |
| Electrical service life | See diagram |
| Standards/regulations | DIN EN 61810-1, VDE 0435-201, EN 50178, IEC 62103 |

| Technical data | |
|--------------------------------------|---|
| Contact type | Single contact, 2-PDT |
| Contact material | AgNi |
| Max. switching voltage | 250 V AC/DC |
| Min. switching voltage | 12 V (at 10 mA) |
| Limiting continuous current | 8 A |
| Max. inrush current | 16 A (20 ms) |
| Min. switching current | 10 mA (at 12 V) |
| Max. interrupting rating, ohmic load | 2000 VA |
| General data | |
| Test voltage (winding / contact) | 5 kV AC (50 Hz, 1 min.) |
| Test voltage (contact/contact) | 2.5 kV AC (50 Hz, 1 min.) |
| Ambient temperature (operation) | -40°C ... 70°C |
| Mechanical service life | 5 x 10 ⁶ cycles |
| Electrical service life | See diagram |
| Standards/regulations | DIN EN 61810-1, VDE 0435-201, EN 50178, IEC 62103 |

Ordering data

| Description | Input voltage U_N |
|---|---------------------|
| Plug-in miniature power relays, with power contacts | |
| - Status LED, freewheeling diode A1+, A2- | ① 24 V DC |
| - Status LED | ② 24 V AC |
| - Status LED | ③ 120 V AC |
| - Status LED | ④ 230 V AC |
| Plug-in miniature power relays with manual test function, with hard gold-plated multi-layer contacts, mechanical switch position indicator | |
| - Status LED, freewheeling diode A1+, A2- | ① 24 V DC |
| - Status LED | ④ 230 V AC |

| Type | Order No. | Pcs. / Pkt. |
|-------------------------|-----------|-------------|
| REL-MR- 24DC/21HC/MS | 2987888 | 10 |
| REL-MR- 24AC/21HC/MS | 2987891 | 10 |
| REL-MR-120AC/21HC/MS | 2987901 | 10 |
| REL-MR-230AC/21HC/MS | 2987914 | 10 |
| REL-MR- 24DC/21HC AU/MS | 2987927 | 10 |
| REL-MR-230AC/21HC AU/MS | 2987930 | 10 |

Ordering data

| Type | Order No. | Pcs. / Pkt. |
|-------------------------|-----------|-------------|
| REL-MR- 24DC/21-21/MS | 2987943 | 10 |
| REL-MR- 24AC/21-21/MS | 2987956 | 10 |
| REL-MR-120AC/21-21/MS | 2987969 | 10 |
| REL-MR-230AC/21-21/MS | 2987972 | 10 |
| REL-MR- 24DC/21-21AU/MS | 2987985 | 10 |
| REL-MR-230AC/21-21AU/MS | 2987998 | 10 |

REL-MR...21HC...MS (1 PDT)

Operating voltage range



Interrupting rating



Electrical service life



Service life reduction factor with various cos phi



REL-MR...21-21...MS (2 PDTs)

Operating voltage range



Interrupting rating



Electrical service life



Service life reduction factor with various cos phi



Relay modules

PR series

Modular PR2 relay base

Range of relay bases that can be fitted with 2 PDT or 4 PDT relays

Range of accessories includes:

- Plug-in input modules/interference suppression modules
- Relay retaining bracket with labeling field and ejection function
- Marking labels
- Loop bridges

| Notes: |
|--|
| Type of housing: Polyamide fiber reinforced PA-F, color: green. |
| Marking systems and mounting material See Catalog 5 |

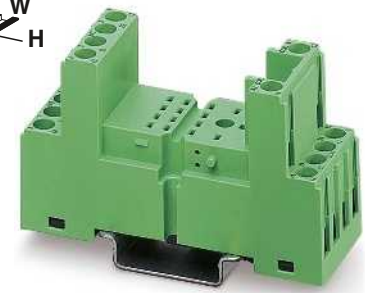

2/2-level design with screw connection



| Technical data | |
|--|---|
| Nominal voltage U_N | 300 V AC/DC |
| Nominal current at U_N | 12 A |
| General data | |
| Ambient temperature (operation) | -25°C ... 85°C |
| Connection data solid / stranded / AWG | 0.2 ... 1.5 mm ² / 0.2 ... 1.5 mm ² / 26 - 16 |
| Dimensions | |
| Width | 27 mm |
| Depth with retaining bracket | 84 mm (EL2-P35) |
| Height | 75 mm |

| Ordering data | | | |
|---|---------------|-----------|-------------|
| Description | Type | Order No. | Pcs. / Pkt. |
| Relay base PR2-B , for industrial relay, REL-IR with two or four PDTs, 2/2-level design, connection option for input/interference suppression module, including ten MP2 marking labels per packaging | | | |
| With screw connection | | | |
| Relay base PR2-B , for industrial relay, REL-IR with two or four PDTs, 1/3-level design, connection option for input/interference suppression module, including ten MP2 marking labels per packaging | PR2-BSC2/4X21 | 2833563 | 10 |
| With screw connection | | | |
| Relay base PR2-B , for industrial relay, REL-IR with two or four PDTs, 1/3-level design, connection option for input/interference suppression module, including ten MP1 marking labels per packaging | | | |
| With spring-cage connection | | | |
| Relay retaining bracket , with eject function and integrated device marking area (8 x 25 mm), to suit relay base PR2, for 35 mm high industrial relay | EL2-P35 | 2833592 | 10 |

| Accessories | | | |
|--|-----------------|-------------|----|
| Description | Order No. | Pcs. / Pkt. | |
| Equipment marking label , labeling surface 6 x 15 mm | | | |
| Equipment marking label , labeling surface 9 x 25 mm | | | |
| Device marking label , for thermal transfer printer, labeling surface 6 x 15 mm 2500 labels per roll | MP 2 | 2833644 | 10 |
| Loop bridge , 50-pos., divisible, max. bridging distance 60 mm, 0.5 mm ² | EML (15X6) R YE | 0819288 | 1 |
| blue | DB 50- 90 BU | 2821180 | 1 |
| black | DB 50- 90 BK | 2820916 | 1 |
| gray | DB 50- 90 GY | 2820929 | 1 |



1/3-level design with screw connection



1/3-level design with spring-cage connection



Relay retaining bracket



| Technical data | | |
|---|--|--|
| 300 V AC/DC | | |
| 12 A | | |
| -25°C ... 85°C | | |
| 0.2 ... 1.5 mm ² / 0.2 ... 1.5 mm ² / 26 - 16 | | |
| 27 mm | | |
| 86 mm (EL2-P35) | | |
| 78.5 mm | | |

| Technical data | | |
|---|--|--|
| 300 V AC/DC | | |
| 10 A | | |
| -25°C ... 85°C | | |
| 0.2 ... 1.5 mm ² / 0.2 ... 1.5 mm ² / 24 - 16 | | |
| 31 mm | | |
| 84 mm (EL2-P35) | | |
| 95 mm | | |

| Technical data | | |
|----------------|--|--|
| - | | |
| - | | |
| - | | |
| - | | |
| - | | |
| - | | |

| Ordering data | | |
|---------------|--|--|
|---------------|--|--|

| Ordering data | | |
|---------------|--|--|
|---------------|--|--|

| Ordering data | | |
|---------------|--|--|
|---------------|--|--|

| Type | Order No. | Pcs. / Pkt. |
|---------------|-----------|-------------|
| PR2-BSC3/4X21 | 2833576 | 10 |
| EL2-P35 | 2833592 | 10 |

| Type | Order No. | Pcs. / Pkt. |
|---------------|-----------|-------------|
| PR2-BSP3/4X21 | 2833589 | 10 |
| EL2-P35 | 2833592 | 10 |

| Type | Order No. | Pcs. / Pkt. |
|---------|-----------|-------------|
| EL2-P35 | 2833592 | 10 |

| Accessories | | |
|-------------|--|--|
|-------------|--|--|

| Accessories | | |
|-------------|--|--|
|-------------|--|--|

| Accessories | | |
|-------------|--|--|
|-------------|--|--|

| | | |
|-----------------|---------|----|
| MP 2 | 2833644 | 10 |
| EML (15X6) R YE | 0819288 | 1 |
| DB 50- 90 BU | 2821180 | 1 |
| DB 50- 90 BK | 2820916 | 1 |
| DB 50- 90 GY | 2820929 | 1 |

| | | |
|-----------------|---------|----|
| MP 1 | 2833631 | 10 |
| EML (15X6) R YE | 0819288 | 1 |
| DB 50- 90 BU | 2821180 | 1 |
| DB 50- 90 BK | 2820916 | 1 |
| DB 50- 90 GY | 2820929 | 1 |

| | | |
|--|--|--|
| | | |
| | | |
| | | |
| | | |
| | | |

Relay modules

PR series

Plug-in industrial relays suitable for PR2 relay base

Plug-in industrial relays with 2 or 4 PDT contacts, suitable for PR2 and RIF-2 relay bases.

The advantages:

- Lockable manual operation
- Mechanical switch position indicator
- Integrated status LED
- Multi-layer gold contact or power contact
- DC types with integrated freewheeling diode



2 PDT relay with power contacts



4 PDT relay with multi-layer gold contact

Notes:
For 48 V DC and 60 V DC types, see www.phoenixcontact.net/products



Technical data

| ① | ② | ③ | ④ | ⑤ | ⑥ | ⑦ | ⑧ |
|----------------------|----|----|-----|-----|----|--------|--------|
| refer to the diagram | | | | | | | |
| 75 | 38 | 10 | 7.2 | 3.6 | 54 | 11 | 5 |
| 13 | 13 | 13 | 13 | 13 | | 4 - 10 | 4 - 10 |
| | | | | | | | 4 - 10 |
| 5 | 5 | 5 | 5 | 5 | | 3 - 12 | 3 - 12 |

Technical data

| ① | ② | ③ | ④ | ⑤ | ⑥ | ⑦ | ⑧ |
|----------------------|----|----|-----|-----|----|--------|--------|
| refer to the diagram | | | | | | | |
| 75 | 38 | 10 | 7.2 | 3.6 | 54 | 11 | 5 |
| 13 | 13 | 13 | 13 | 13 | | 4 - 10 | 4 - 10 |
| | | | | | | | 4 - 10 |
| 5 | 5 | 5 | 5 | 5 | | 3 - 12 | 3 - 12 |

| | |
|--|---|
| Input data | |
| Permissible range (with reference to U_N) | |
| Typ. input current at U_N | [mA] |
| Typ. response time at U_N | [ms] |
| Typ. response time at U_N (AC, depending on phase relation) | [ms] |
| Typ. release time at U_N | [ms] |
| Typ. release time at U_N (AC, depending on phase relation) | [ms] |
| Output data | |
| Contact type | Single contact, 2-PDT |
| Contact material | Ag |
| Max. switching voltage | 250 V AC/DC |
| Min. switching voltage | 5 V |
| Limiting continuous current | 10 A |
| Min. switching current | 1 mA |
| Max. interrupting rating, ohmic load | 250 V AC |
| General data | |
| Test voltage (winding / contact) | 2 kV AC (50 Hz, 1 min.) |
| Test voltage (contact/contact) | 2 kV AC (50 Hz, 1 min.) |
| Ambient temperature (operation) | -55°C ... 70°C |
| Nominal operating mode | 100% operating factor |
| Mechanical service life | 5 x 10 ⁷ cycles |
| Electrical service life | See diagram |
| Standards/regulations | DIN EN 61810-1, VDE 0435-201, EN 50178, IEC 62103 |
| Mounting position/mounting | Any / On relay base PR2 |

| | |
|--|---|
| Input data | |
| Permissible range (with reference to U_N) | |
| Typ. input current at U_N | [mA] |
| Typ. response time at U_N | [ms] |
| Typ. response time at U_N (AC, depending on phase relation) | [ms] |
| Typ. release time at U_N | [ms] |
| Typ. release time at U_N (AC, depending on phase relation) | [ms] |
| Output data | |
| Contact type | Single contact, 4-PDT |
| Contact material | AgNi, hard gold-plated |
| Max. switching voltage | 250 V AC/DC |
| Min. switching voltage | 1 V |
| Limiting continuous current | 5 A |
| Min. switching current | 1 mA |
| Max. interrupting rating, ohmic load | 1250 VA |
| General data | |
| Test voltage (winding / contact) | 2 kV AC (50 Hz, 1 min.) |
| Test voltage (contact/contact) | 2 kV AC (50 Hz, 1 min.) |
| Ambient temperature (operation) | -55°C ... 70°C |
| Nominal operating mode | 100% operating factor |
| Mechanical service life | 5 x 10 ⁷ cycles |
| Electrical service life | See diagram |
| Standards/regulations | DIN EN 61810-1, VDE 0435-201, EN 50178, IEC 62103 |
| Mounting position/mounting | Any / On relay base PR2 |

Ordering data

| Description | Input voltage U_N |
|--|---------------------|
| Plug-in industrial relay with a test button, status LED, mechanical switch position indicator | |
| with freewheeling diode, A1 + , A2 - | ① 12 V DC |
| with freewheeling diode, A1 + , A2 - | ② 24 V DC |
| with freewheeling diode, A1 + , A2 - | ③ 110 V DC |
| with freewheeling diode, A1 + , A2 - | ④ 125 V DC |
| with freewheeling diode, A1 + , A2 - | ⑤ 220 V DC |
| with freewheeling diode, A1 + , A2 - | ⑥ 24 V AC |
| with freewheeling diode, A1 + , A2 - | ⑦ 120 V AC |
| with freewheeling diode, A1 + , A2 - | ⑧ 230 V AC |
| Plug-in industrial relay with a test button, status LED, mechanical switch position indicator (Japanese standard) | |
| with freewheeling diode, A1 - , A2 + | ① 12 V DC |
| with freewheeling diode, A1 - , A2 + | ② 24 V DC |
| with freewheeling diode, A1 - , A2 + | ③ 48 V DC |
| with freewheeling diode, A1 - , A2 + | ④ 110 V DC |

| Type | Order No. | Pcs. / Pkt. |
|-----------------------|-----------|-------------|
| REL-IR/LDP- 12DC/2X21 | 2834012 | 10 |
| REL-IR/LDP- 24DC/2X21 | 2834025 | 10 |
| REL-IR/LDP-110DC/2X21 | 2834041 | 10 |
| REL-IR/LDP-125DC/2X21 | 2834960 | 10 |
| REL-IR/LDP-220DC/2X21 | 2834957 | 10 |
| REL-IR/L- 24AC/2X21 | 2834054 | 10 |
| REL-IR/L-120AC/2X21 | 2834067 | 10 |
| REL-IR/L-230AC/2X21 | 2834070 | 10 |
| REL-IR/LDM- 12DC/2X21 | 2834151 | 10 |
| REL-IR/LDM- 24DC/2X21 | 2834164 | 10 |
| REL-IR/LDM- 48DC/2X21 | 2834177 | 10 |
| REL-IR/LDM-110DC/2X21 | 2834180 | 10 |

Ordering data

| Type | Order No. | Pcs. / Pkt. |
|-------------------------|-----------|-------------|
| REL-IR/LDP- 12DC/4X21AU | 2834083 | 10 |
| REL-IR/LDP- 24DC/4X21AU | 2834096 | 10 |
| REL-IR/LDP-110DC/4X21AU | 2834119 | 10 |
| REL-IR/LDP-125DC/4X21AU | 2834313 | 10 |
| REL-IR/LDP-220DC/4X21AU | 2834973 | 10 |
| REL-IR/L- 24AC/4X21AU | 2834122 | 10 |
| REL-IR/L-120AC/4X21AU | 2834135 | 10 |
| REL-IR/L-230AC/4X21AU | 2834148 | 10 |
| REL-IR/LDM- 12DC/4X21AU | 2834193 | 10 |
| REL-IR/LDM- 24DC/4X21AU | 2834203 | 10 |
| REL-IR/LDM- 48DC/4X21AU | 2834216 | 10 |
| REL-IR/LDM-110DC/4X21AU | 2834229 | 10 |

REL-IR...2x21 (2 PDTs)

Operating voltage range

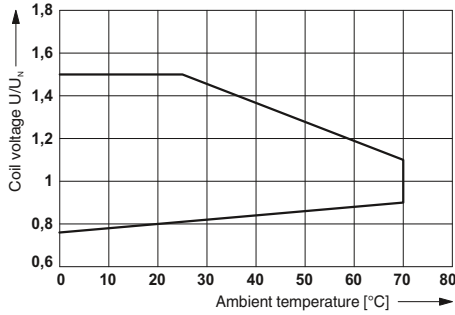

AC interrupting rating

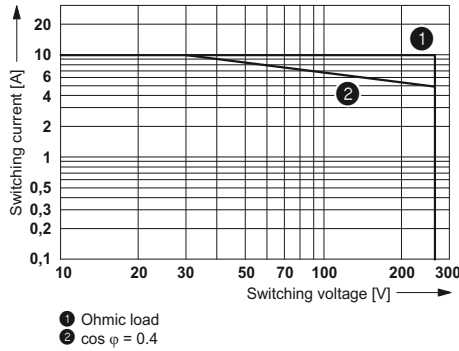

DC interrupting rating

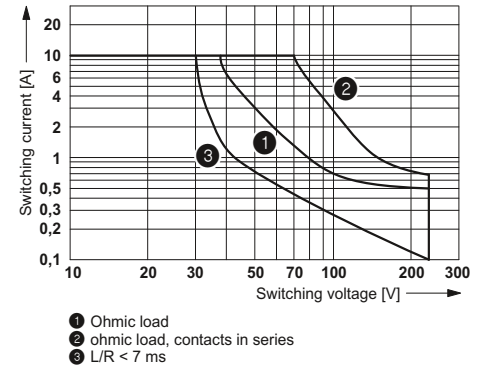

Electrical service life

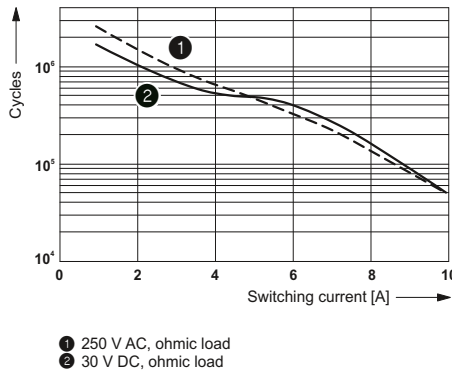

Service life reduction factor

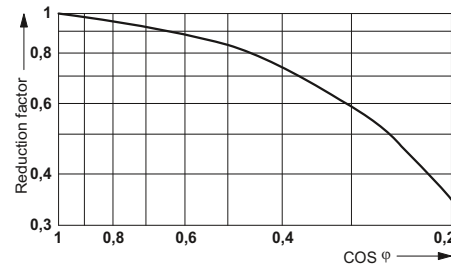

REL-IR...4x21AU (4 PDTs)

Operating voltage range

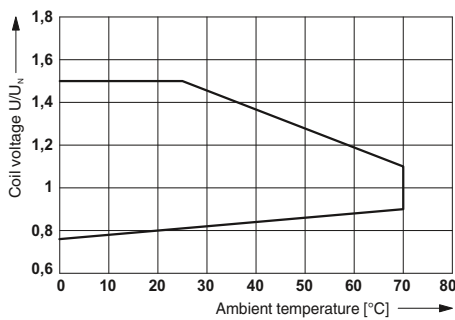

AC interrupting rating

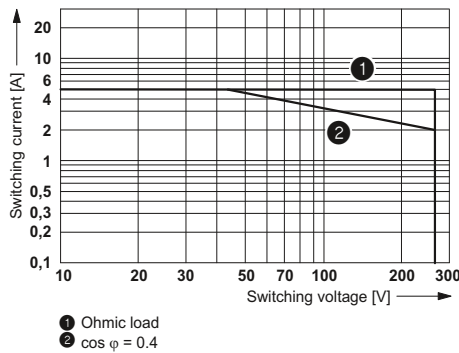

DC interrupting rating

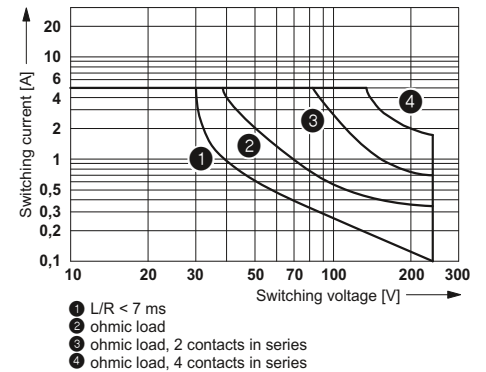

Electrical service life

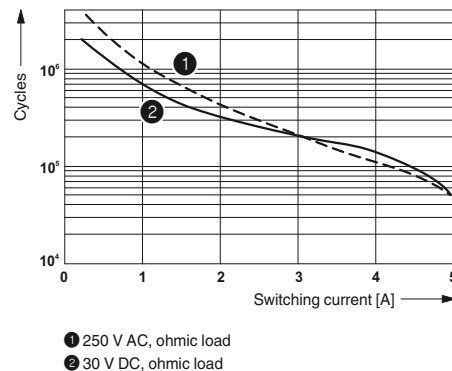

Service life reduction factor

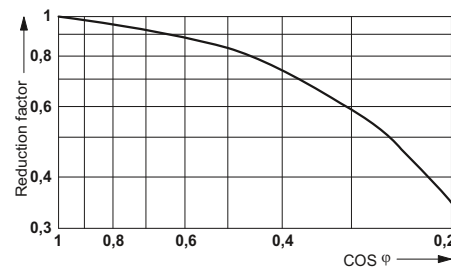

Relay modules

PR series

Modular PR3 relay base

Range of relay bases that can be fitted with 2 PDT or 3 PDT relays

Range of accessories includes:

- Plug-in input modules/interference suppression modules
- Relay retaining bracket
- Loop bridges

| Notes: |
|--|
| Type of housing: Polyamide fiber reinforced PA-F, color: green. |
| Marking systems and mounting material See Catalog 5 |



Relay base for 2 PDT octal relay

| Technical data | |
|--|---|
| Nominal voltage U_N | 400 V AC/DC |
| Nominal current at U_N | 10 A |
| General data | |
| Ambient temperature (operation) | -40°C ... 85°C |
| Connection data solid / stranded / AWG | 0.2 ... 2.5 mm ² / 0.2 ... 2.5 mm ² / 26 - 14 |
| Dimensions | |
| Width | 38 mm |
| Depth with retaining bracket | 84 mm (EL3-M52) |
| Height | 75 mm |

| Ordering data | | |
|---|----------------------|-------------|
| Type | Order No. | Pcs. / Pkt. |
| Relay base PR3 , for octal relay REL-OR with two PDTs, plug-in option for input/interference suppression modules | | |
| With screw connection | | |
| Relay base PR3 , for octal relay REL-OR with three PDTs, plug-in option for input/interference suppression modules | PR3-BSC1/2X21 | 2833602 10 |
| With screw connection | | |
| Relay retaining bracket , wiring to suit relay base PR3, for 52 mm high octal relay | EL3-M52 | 2833628 10 |

| Accessories | | |
|--|-------|-------------------------------|
| | | |
| Loop bridge , 50-pos., divisible, max. bridging distance 60 mm, 0.5 mm ² | blue | DB 50- 90 BU 2821180 1 |
| | black | DB 50- 90 BK 2820916 1 |
| | gray | DB 50- 90 GY 2820929 1 |



Relay base for
3 PDT octal relay



Relay retaining bracket



| Technical data | | | Technical data | | |
|---|-----------|-------------|----------------|-----------|-------------|
| 400 V AC/DC | | | - | | |
| 10 A | | | - | | |
| -40°C ... 85°C | | | - | | |
| 0.2 ... 2.5 mm ² / 0.2 ... 2.5 mm ² / 26 - 14 | | | - | | |
| 38 mm | | | - | | |
| 84 mm (EL3-M52) | | | - | | |
| 75 mm | | | - | | |
| Ordering data | | | Ordering data | | |
| Type | Order No. | Pcs. / Pkt. | Type | Order No. | Pcs. / Pkt. |
| PR3-BSC1/3X21 | 2833615 | 10 | | | |
| EL3-M52 | 2833628 | 10 | EL3-M52 | 2833628 | 10 |
| Accessories | | | Accessories | | |
| DB 50- 90 BU | 2821180 | 1 | | | |
| DB 50- 90 BK | 2820916 | 1 | | | |
| DB 50- 90 GY | 2820929 | 1 | | | |

Relay modules

PR series

Plug-in octal relays suitable for PR3 relay base

Plug-in octal relays with 2 or 3 PDT contacts, suitable for PR3 and RIF-3 relay bases.

The advantages:

- Lockable manual operation
- Mechanical switch position indicator
- Extremely robust design



2 PDT relay with power contacts



3 PDT relay with power contacts

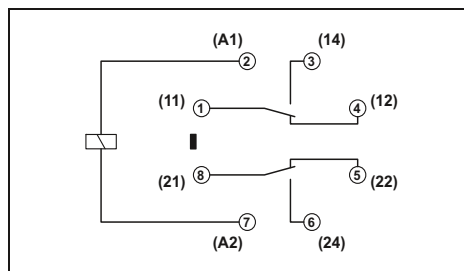

Technical data

| Input data | | ① | ② | ③ | ④ |
|--|------|----|--------|--------|--------|
| Typ. input current at U_N | [mA] | 56 | 110 | 22 | 10 |
| Typ. response time at U_N | [ms] | 12 | | | |
| Typ. response time at U_N (AC, depending on phase relation) | [ms] | | 5 - 20 | 5 - 20 | 5 - 20 |
| Typ. release time at U_N | [ms] | 6 | | | |
| Typ. release time at U_N (AC, depending on phase relation) | [ms] | | 5 - 20 | 5 - 20 | 5 - 20 |

| Output data | |
|--------------------------------------|-----------------------|
| Contact type | Single contact, 2-PDT |
| Contact material | AgSnIn |
| Max. switching voltage | 250 V AC/DC |
| Min. switching voltage | 1 V |
| Limiting continuous current | 10 A (N/O contact) |
| Min. switching current | 10 mA |
| Max. interrupting rating, ohmic load | 250 V AC |

| General data | |
|----------------------------------|-----------------------------|
| Test voltage (winding / contact) | 2.5 kV AC (50 Hz, 1 min.) |
| Test voltage (contact/contact) | 2.5 kV AC (50 Hz, 1 min.) |
| Ambient temperature (operation) | -40°C ... 60°C |
| Nominal operating mode | 100% operating factor |
| Mechanical service life | 10 x 10 ⁶ cycles |
| Electrical service life | See diagram |
| Standards/regulations | IEC 60664 |
| Mounting position/mounting | Any / On relay base PR3 |

Ordering data

| Description | Input voltage U_N |
|--|---------------------|
| Plug-in octal relay with power contacts , with a test button and mechanical switch position indicator | ① 24 V DC |
| | ② 24 V AC |
| | ③ 120 V AC |
| | ④ 230 V AC |

| Type | Order No. | Pcs. / Pkt. |
|-------------------|-----------|-------------|
| REL-OR- 24DC/2X21 | 2834232 | 10 |
| REL-OR- 24AC/2X21 | 2834245 | 10 |
| REL-OR-120AC/2X21 | 2834258 | 10 |
| REL-OR-230AC/2X21 | 2834261 | 10 |

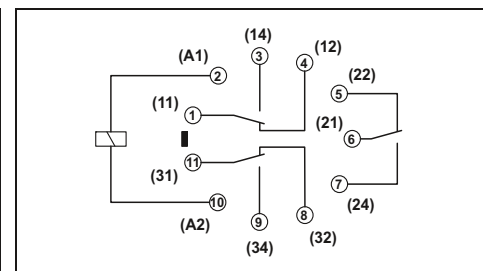

Technical data

| Input data | | ① | ② | ③ | ④ |
|--|------|----|--------|--------|--------|
| Typ. input current at U_N | [mA] | 56 | 110 | 22 | 10 |
| Typ. response time at U_N | [ms] | 12 | | | |
| Typ. response time at U_N (AC, depending on phase relation) | [ms] | | 5 - 20 | 5 - 20 | 5 - 20 |
| Typ. release time at U_N | [ms] | 6 | | | |
| Typ. release time at U_N (AC, depending on phase relation) | [ms] | | 5 - 20 | 5 - 20 | 5 - 20 |

| Output data | |
|--------------------------------------|----------------------------|
| Contact type | Single contact, three PDTs |
| Contact material | AgSnIn |
| Max. switching voltage | 250 V AC/DC |
| Min. switching voltage | 1 V |
| Limiting continuous current | 10 A (N/O contact) |
| Min. switching current | 10 mA |
| Max. interrupting rating, ohmic load | 2500 VA |

| General data | |
|----------------------------------|-----------------------------|
| Test voltage (winding / contact) | 2.5 kV AC (50 Hz, 1 min.) |
| Test voltage (contact/contact) | 2.5 kV AC (50 Hz, 1 min.) |
| Ambient temperature (operation) | -40°C ... 60°C |
| Nominal operating mode | 100% operating factor |
| Mechanical service life | 10 x 10 ⁶ cycles |
| Electrical service life | See diagram |
| Standards/regulations | IEC 60664 |
| Mounting position/mounting | Any / On relay base PR3 |

Ordering data

| Type | Order No. | Pcs. / Pkt. |
|-------------------|-----------|-------------|
| REL-OR- 24DC/3X21 | 2834274 | 10 |
| REL-OR- 24AC/3X21 | 2834287 | 10 |
| REL-OR-120AC/3X21 | 2834290 | 10 |
| REL-OR-230AC/3X21 | 2834300 | 10 |

REL-OR...2x21 (2 PDTs)

Interrupting rating

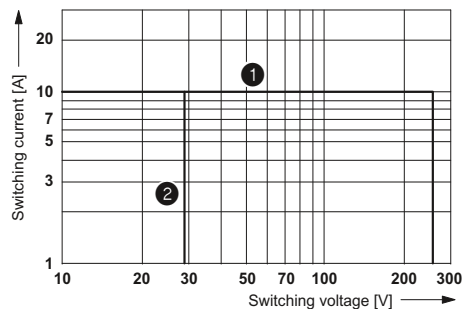

- 1 AC, ohmic load
- 2 DC, ohmic load

Electrical service life

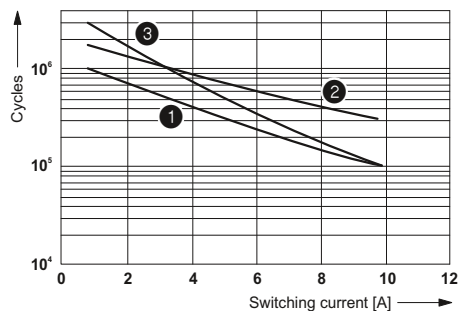

- 1 250V AC, ohmic load
- 2 120VDC, ohmic load
- 3 28V DC, ohmic load

Service life reduction factor with various cos phi

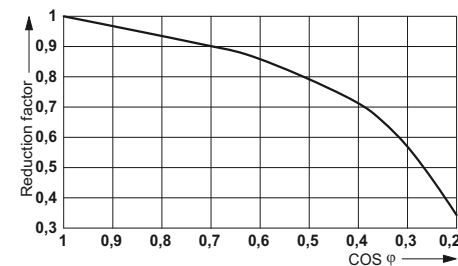

REL-OR...3x21 (3 PDTs)

Interrupting rating

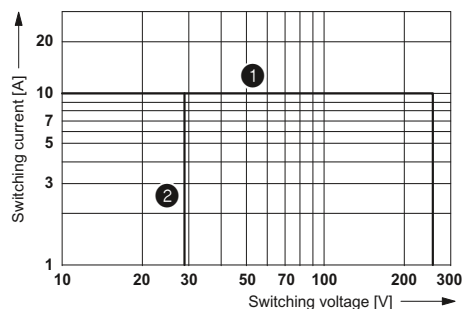

- 1 AC, ohmic load
- 2 DC, ohmic load

Electrical service life

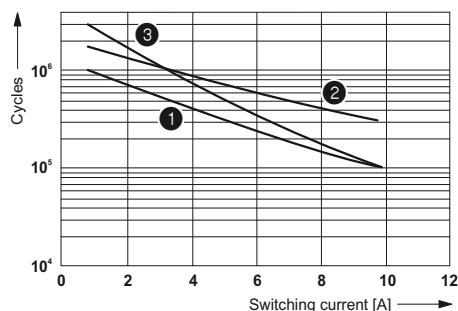

- 1 250V AC, ohmic load
- 2 120VDC, ohmic load
- 3 28V DC, ohmic load

Service life reduction factor with various cos phi

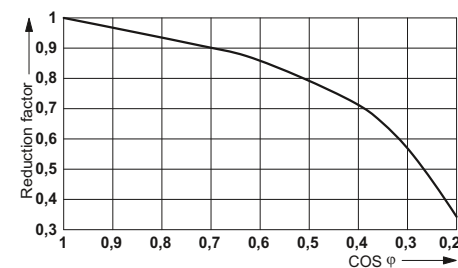

Relay modules

PR series

Plug-in octal relays for high DC loads

Plug-in octal relays with two N/O contacts connected in series suitable for PR3 and RIF-3 relay bases.

The relays are specially designed for switching high DC loads.

Further advantages:

- Full shutdown by means of 2 x 1.7 mm contact opening
- With lockable manual operation
- Integrated status LED
- Integrated freewheeling diode with DC types



1 N/O contact, with blow magnet



1 N/O contact



Technical data

| ① | ② | ③ | ④ | ⑤ | ⑥ |
|----------------------|----|----|--------|--------|--------|
| refer to the diagram | | | | | |
| 55 | 13 | 7 | 100 | 22 | 11 |
| 20 | 20 | 20 | 5 - 20 | 5 - 20 | 5 - 20 |
| 30 | 30 | 30 | 5 - 20 | 5 - 20 | 5 - 20 |



Technical data

| ① | ② | ③ | ④ | ⑤ | ⑥ |
|----------------------|----|----|--------|--------|--------|
| refer to the diagram | | | | | |
| 55 | 13 | 7 | 100 | 22 | 11 |
| 20 | 20 | 20 | 5 - 20 | 5 - 20 | 5 - 20 |
| 30 | 30 | 30 | 5 - 20 | 5 - 20 | 5 - 20 |

| | |
|--|---------------------------------------|
| Input data | |
| Permissible range (with reference to U_N) | |
| Typ. input current at U_N | [mA] |
| Typ. response time at U_N | [ms] |
| Typ. response time at U_N (depending on phase relation) | [ms] |
| Typ. release time at U_N | [ms] |
| Typ. release time at U_N (depending on phase relation) | [ms] |
| Output data | |
| Contact type | |
| 250 V AC | 2500 VA |
| General data | |
| Test voltage (winding / contact) | 2.5 kV _{rms} (50 Hz, 1 min.) |
| Ambient temperature (operation) | -40°C ... 60°C |
| Nominal operating mode | 100% operating factor |
| Mechanical service life | Approx. 10 ⁷ cycles |
| Standards/regulations | IEC 61810, EN 60947 |
| Mounting position/mounting | Any / On relay base PR3 |

| | |
|---|--|
| Single contact, 1 N/O contact (series connection, 2 N/O contacts) with blowout magnet | |
| AgNi | |
| 250 V AC / 220 V DC | |
| 10 V (at 10 mA) | |
| 10 A | |
| 10 mA (at 10 V) | |
| 2500 VA | |
| 2.5 kV _{rms} (50 Hz, 1 min.) | |
| -40°C ... 60°C | |
| 100% operating factor | |
| Approx. 10 ⁷ cycles | |
| IEC 61810, EN 60947 | |
| Any / On relay base PR3 | |

| | |
|---|--|
| Single contact, 1 N/O contact (series connection, 2 N/O contacts) | |
| AgNi | |
| 250 V AC / 220 V DC | |
| 10 V (at 10 mA) | |
| 10 A | |
| 10 mA (at 10 V) | |
| 2500 VA | |
| 2.5 kV _{rms} (50 Hz, 1 min.) | |
| -40°C ... 60°C | |
| 100% operating factor | |
| Approx. 10 ⁷ cycles | |
| IEC 61810, EN 60947 | |
| Any / On relay base PR3 | |

Ordering data

| Description | Input voltage U_N | Type | Order No. | Pcs. / Pkt. |
|---------------------------------------|---------------------|-----------------------|-----------|-------------|
| Plug-in octal relay for high DC loads | ① 24 V DC | REL-OR/LDP- 24DC/1/MB | 2901901 | 10 |
| | ② 110 V DC | REL-OR/LDP-110DC/1/MB | 2901902 | 10 |
| | ③ 220 V DC | REL-OR/LDP-220DC/1/MB | 2901904 | 10 |
| | ④ 24 V AC | REL-OR/L- 24AC/1/MB | 2901905 | 10 |
| | ⑤ 120 V AC | REL-OR/L-120AC/1/MB | 2901906 | 10 |
| | ⑥ 230 V AC | REL-OR/L-230AC/1/MB | 2901907 | 10 |

Ordering data

| Type | Order No. | Pcs. / Pkt. |
|--------------------|-----------|-------------|
| REL-OR/LDP- 24DC/1 | 2901908 | 10 |
| REL-OR/LDP-110DC/1 | 2901909 | 10 |
| REL-OR/LDP-220DC/1 | 2901910 | 10 |
| REL-OR/L- 24AC/1 | 2901911 | 10 |
| REL-OR/L-120AC/1 | 2901912 | 10 |
| REL-OR/L-230AC/1 | 2901913 | 10 |

REL-OR.../1/MB (1 N/O contact with blow magnet)

Operating voltage range of the relay

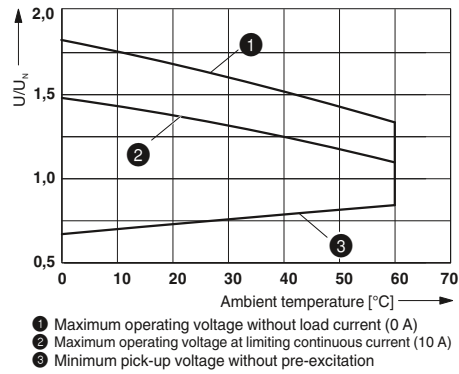

DC interrupting rating



REL-OR.../1 (1 N/O contact)

Operating voltage range of the relay



DC interrupting rating



Relay modules

PR series

Input modules/interference suppression modules for PR1, PR2, and PR3

Plug-in input modules/interference suppression modules for optional fitting of PR... relay base

The advantages:

- Attenuation of reverse voltage induced in coil
- Mechanical coding to protect against incorrect connection



Input/interference suppression module to match PR1 and PR2



Input/interference suppression module to match PR3



| Description | Ordering data | | | Ordering data | | |
|--|--------------------|-----------|-------------|---------------------|-----------|-------------|
| | Type | Order No. | Pcs. / Pkt. | Type | Order No. | Pcs. / Pkt. |
| Plug-in module , for mounting on PR..., with LED status indicator and freewheeling diode to limit the coil induction voltage effectively, polarity: A1 +, A2 - , Input voltage: - 12-24 V DC $\pm 20\%$ - 48-60 V DC $\pm 20\%$ - 110 V DC $\pm 20\%$ | LDP- 12- 24DC | 2833657 | 10 | LDP3- 12- 24DC | 2833770 | 10 |
| | LDP- 48- 60DC | 2833660 | 10 | LDP3- 48- 60DC | 2833783 | 10 |
| | LDP-110DC | 2833673 | 10 | LDP3-110DC | 2833796 | 10 |
| Plug-in module , for mounting on PR..., with LED status indicator and freewheeling diode to limit the coil induction voltage effectively, polarity: A1 -, A2 + (Japanese standard), Input voltage: - 12-24 V DC $\pm 20\%$ - 48-60 V DC $\pm 20\%$ - 110 V DC $\pm 20\%$ | LDM- 12- 24DC | 2833686 | 10 | LDM3- 12- 24DC | 2833806 | 10 |
| | LDM- 48- 60DC | 2833699 | 10 | LDM3- 48- 60DC | 2833819 | 10 |
| | LDM-110DC | 2833709 | 10 | LDM3-110DC | 2833822 | 10 |
| Plug-in module , for mounting on PR..., with LED status indicator and varistor to limit the coil induction voltage and/or external interference peaks, Input voltage: - 12-24 V AC/DC $\pm 20\%$ (30-V-varistor) - 48-60 V AC/DC $\pm 20\%$ (75-V-varistor) - 120-230 V AC/110 V DC $\pm 20\%$ (275-V-varistor) | LV- 12- 24UC | 2833712 | 10 | LV3- 12- 24UC | 2833835 | 10 |
| | LV- 48- 60UC | 2833725 | 10 | LV3- 48- 60UC | 2833848 | 10 |
| | LV-120-230AC/110DC | 2833738 | 10 | LV3-120-230AC/110DC | 2833851 | 10 |
| Plug-in module , for mounting on PR..., with varistor to limit the coil induction voltage and/or external interference peaks, Input voltage: - 12-24 V AC/DC $\pm 20\%$ (30-V-varistor) - 48-60 V AC/DC $\pm 20\%$ (75-V-varistor) - 120-230 V AC/DC $\pm 20\%$ (275-V-varistor) | V- 12- 24UC | 2833864 | 10 | V3- 12- 24UC | 2833929 | 10 |
| | V- 48- 60UC | 2833877 | 10 | V3- 48- 60UC | 2833932 | 10 |
| | V-120-230UC | 2833880 | 10 | V3-120-230UC | 2833945 | 10 |
| Plug-in module , for mounting on PR..., with RD-element to attenuate the coil induction voltage and/or external interference peaks, Input voltage: - 12-24 V AC/DC $\pm 20\%$ (220 nF/100 Ω) - 48-60 V AC/DC $\pm 20\%$ (220 nF/220 Ω) - 120-230 V AC/DC $\pm 20\%$ (100 nF/470 Ω) | RC- 12- 24UC | 2833741 | 10 | RC3- 12- 24UC | 2833893 | 10 |
| | RC- 12- 24UC | 2833754 | 10 | RC3- 48- 60UC | 2833903 | 10 |
| | RC-120-230UC | 2833767 | 10 | RC3-120-230UC | 2833916 | 10 |

| Terminal assignment PR1 base / Solid-state relay | | | | | | | | |
|--|---------------------------|--------|----|----|----|----|----|----|
| | Terminal blocks, PR1 base | | | | | | | |
| | A1 | A2 | 11 | 12 | 14 | 21 | 22 | 24 |
| Solid-state relays | | | | | | | | |
| SIM-EI...48DC/100 | A2 (-) | A1 (+) | | | A | + | | |
| SIM-EI...TTL/100 | A2 (-) | A1 (+) | | | A | + | 0 | |
| SIM-EI...48DC/100RC | A2 (-) | A1 (+) | | | A | + | | |
| SIM-EI-OV-24DC/24DC/3 | A2 (-) | A1 (+) | | | A | + | | |
| OPT-...24DC/5 | A1 (+) | A2 (-) | 13 | | 14 | | | |
| OPT-...230AC/2 | A1 (+) | A2 (-) | 13 | | 14 | | | |

The relay bases of the PR1 series can also be equipped with wear-free solid-state relays (OPT... or SIM-EI...) as an alternative to the electromechanical relay.
LDP... and LV... plug-in modules cannot be used in conjunction with SIM-EI... solid-state relays

Relay modules

PR series

Fully mounted PR1 relay modules with screw connection

Fully mounted PR1 relay modules, consisting of:

- Relay base
- 1/2 PDT relay
- Relay retaining bracket
- Input module/interference suppr. module
- Marking labels

The advantages:

- Logical contact arrangement thanks to 1/3-level relay base
- Operational reliability thanks to sealed relay
- Safe isolation between coil and contact side

| Notes: | |
|---|--|
| Type of housing: | Polyamide fiber reinforced PA-F, color: green. |
| For the protection of input and output, inductive loads must be dampened with an effective protection circuit. | |
| If the specified maximum values for multi-layer contact relays are exceeded, the gold plating is destroyed. The maximum values of the power contact relay are then valid. This can result in a shorter service life than with a pure power contact. | |
| Other input voltages on request. | |
| 1) EMC: Class A product, see page 571 | |

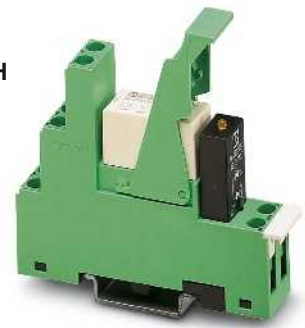

PR1 relay module with 1 PDT relay



| Input data | |
|--|---------------------------------------|
| Permissible range (with reference to U_N) | |
| Typ. input current with U_N (for AC: 50/60 Hz) | [mA] |
| Typ. response time at U_N | [ms] |
| Typ. release time at U_N | [ms] |
| Input protection: | 24 V DC 24, 120, 230 V AC |
| Output data | |
| Contact type | |
| Contact material | |
| Maximum switching voltage | |
| Minimum switching voltage | |
| Limiting continuous current | |
| Maximum inrush current | |
| Min. switching current | |
| Interrupting rating (ohmic load) max. | |
| General data | |
| Test voltage | Winding to contact Contact/contact |
| Ambient temperature (operation) | |
| Nominal operating mode | |
| Mechanical service life | |
| Service life, electrical | |
| Standards/regulations | |
| Pollution degree/surge voltage category | |
| Mounting position / Mounting | |
| Connection data solid / stranded / AWG | |
| Dimensions | W / H / D |

| Technical data | | | |
|---|------------|------------------------|----------|
| 24 V DC | 24 V AC | 120 V AC | 230 V AC |
| See diagram | | | |
| 19 | 34 / 26 | 9 / 7 | 6 / 5.5 |
| 8 | 3 ... 12 | 3 ... 12 | 3 ... 12 |
| 10 | 1.5 ... 14 | 1.5 ... 16 | 2 ... 22 |
| Damping diode, Yellow LED Varistor, Yellow LED | | | |
| PR... | PR...AU | | |
| Single contact, 1-PDT | | Single contact, 1-PDT | |
| AgNi | | AgNi, hard gold-plated | |
| 250 V AC/DC | | 30 V AC / 36 V DC | |
| 12 V (at 10 mA) | | 100 mV (at 10 mA) | |
| 12 A | | 50 mA | |
| 30 A (300 ms) | | 50 mA | |
| 100 mA | | 1 mA (at 24 V) | |
| 3000 VA (for 250 V AC) | | - | |
| For more data, see diagram | | | |

| Description | Input voltage U_N |
|--|---------------------|
| Pre-assembled coupling relay modules with miniature power contact relay | 24 V DC |
| | 24 V AC |
| | 120 V AC |
| | 230 V AC |
| Pre-assembled coupling relay modules with multi-layer contact relay | 24 V DC |
| | 24 V AC |
| | 120 V AC |
| | 230 V AC |

| Ordering data | | |
|--------------------------------------|-----------|-------------|
| Type | Order No. | Pcs. / Pkt. |
| PR1-RSC3-LDP-24DC/21 ¹⁾ | 2834326 | 5 |
| PR1-RSC3-LV- 24AC/21 ¹⁾ | 2834339 | 5 |
| PR1-RSC3-LV-120AC/21 ¹⁾ | 2834342 | 5 |
| PR1-RSC3-LV-230AC/21 ¹⁾ | 2834355 | 5 |
| PR1-RSC3-LDP-24DC/21AU ¹⁾ | 2834368 | 5 |
| PR1-RSC3-LV- 24AC/21AU ¹⁾ | 2834371 | 5 |
| PR1-RSC3-LV-120AC/21AU ¹⁾ | 2834384 | 5 |
| PR1-RSC3-LV-230AC/21AU ¹⁾ | 2834397 | 5 |

Device marking label, for thermal transfer printer, labeling surface 6 x 15 mm

| Accessories | | |
|-----------------|---------|---|
| EML (15X6) R YE | 0819288 | 1 |
| | | |



PR1 relay module with 2 PDT contact relay

PR1-RSC3.../21 (1 PDT)

Operating voltage range of the relay



- 1 DC coils
- 2 AC coils

Interrupting rating

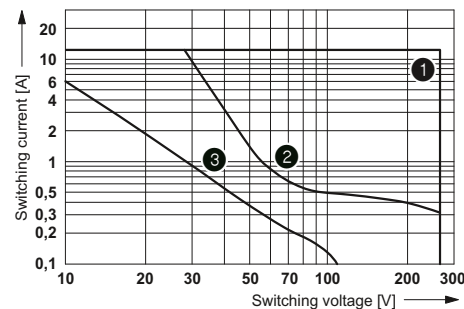

- 1 AC, ohmic load
- 2 DC, ohmic load
- 3 DC, L/R = 40 ms



Service life reduction factor

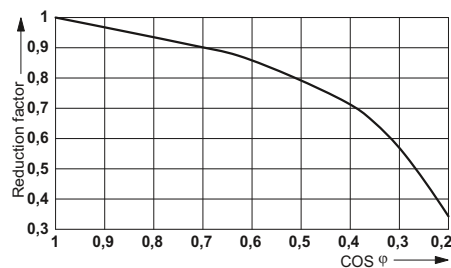

Electrical service life

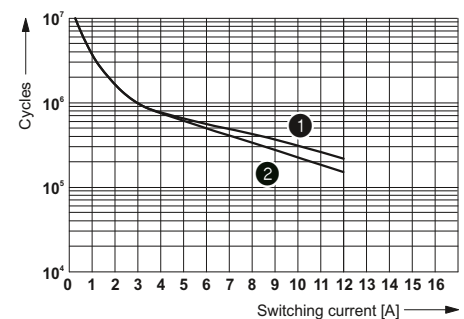

- 1 250 V AC, ohmic load (DC coils)
- 2 250 V AC, ohmic load (AC coils)

Technical data

| 24 V DC | 24 V AC | 120 V AC | 230 V AC |
|-------------|------------|------------|----------|
| See diagram | | | |
| 19 | 34 / 26 | 9 / 7 | 6 / 5.5 |
| 8 | 3 ... 12 | 3 ... 12 | 3 ... 12 |
| 10 | 1.5 ... 14 | 1.5 ... 16 | 2 ... 22 |

Damping diode, Yellow LED
Varistor, Yellow LED

| PR... | PR...AU |
|-----------------------|-----------------------|
| Single contact, 2-PDT | Single contact, 2-PDT |

AgNi
250 V AC/DC
5 V (at 10 mA)
8 A
15 A (300 ms)
10 mA (At 5 V)
2000 VA (for 250 V AC)
For more data, see diagram

4 kV (50 Hz, 1 min.)
2.5 kV (50 Hz, 1 min.)
-25°C ... 60°C
100% operating factor
3 x 10⁷ cycles
See diagram
IEC 60664, EN 50178, IEC 62103
3 / III
Any / In rows with zero spacing
0.14 - 2.5 mm² / 0.14 - 2.5 mm² / 26 - 14
16 mm / 78.5 mm / 71 mm

Ordering data

| Type | Order No. | Pcs. / Pkt. |
|--|-----------|-------------|
| PR1-RSC3-LDP-24DC/2X21 ¹⁾ | 2834481 | 5 |
| PR1-RSC3-LV- 24AC/2X21 ¹⁾ | 2834494 | 5 |
| PR1-RSC3-LV-120AC/2X21 ¹⁾ | 2834504 | 5 |
| PR1-RSC3-LV-230AC/2X21 ¹⁾ | 2834517 | 5 |
| PR1-RSC3-LDP-24DC/2X21AU ¹⁾ | 2834520 | 5 |
| PR1-RSC3-LV- 24AC/2X21AU ¹⁾ | 2834533 | 5 |
| PR1-RSC3-LV-120AC/2X21AU ¹⁾ | 2834546 | 5 |
| PR1-RSC3-LV-230AC/2X21AU ¹⁾ | 2834559 | 5 |

Accessories

| EML (15X6) R YE | 0819288 | 1 |
|-----------------|---------|---|
|-----------------|---------|---|

PR1-RSC3.../2x21 (2 PDT)

Operating voltage range of the relay

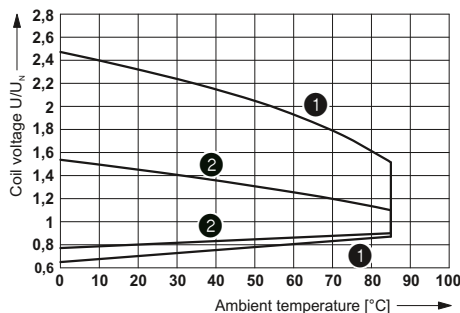

- 1 DC coils
- 2 AC coils

Interrupting rating

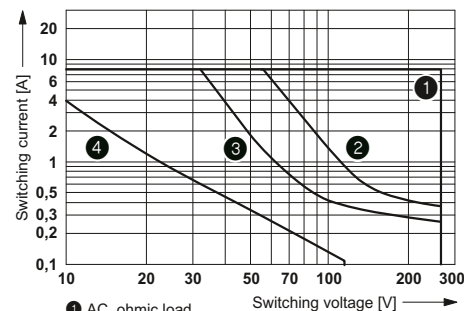

- 1 AC, ohmic load
- 2 DC, ohmic load, contacts in series
- 3 DC, ohmic load
- 4 DC, L/R = 40 ms

Service life reduction factor with various cos phi

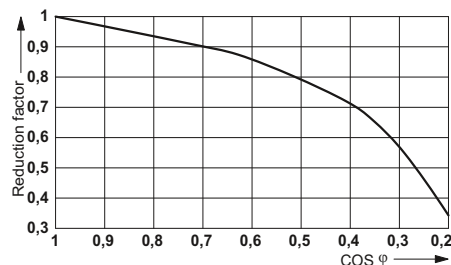

Electrical service life

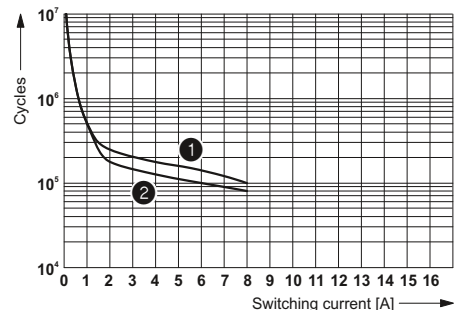

- 1 250 V AC, ohmic load (DC coils)
- 2 250 V AC, ohmic load (AC coils)

Relay modules

PR series

Fully mounted PR1 relay modules with spring-cage connection

Fully mounted PR1 relay modules, consisting of:

- Relay base
- 1/2 PDT relay
- Relay retaining bracket
- Input module/interference suppr. module
- Marking labels

The advantages:

- Logical contact arrangement thanks to 1/3-level relay base
- Operational reliability thanks to sealed relay
- Safe isolation between coil and contact side

| Notes: |
|---|
| Type of housing: Polyamide fiber reinforced PA-F, color: green. |
| For the protection of input and output, inductive loads must be dampened with an effective protection circuit. |
| If the specified maximum values for multi-layer contact relays are exceeded, the gold plating is destroyed. The maximum values of the power contact relay are then valid. This can result in a shorter service life than with a pure power contact. |
| There is a double spring-cage for each terminal point. |
| Other input voltages on request. |
| 1) EMC: Class A product, see page 571 |



PR1 relay module with 1 PDT relay



| | |
|--|---------------------------------------|
| Input data | |
| Permissible range (with reference to U_N) | |
| Typ. input current with U_N (for AC: 50/60 Hz) | [mA] |
| Typ. response time at U_N | [ms] |
| Typ. release time at U_N | [ms] |
| Input protection: | 24 V DC 24, 120, 230 V AC |
| Output data | |
| Contact type | |
| Contact material | |
| Maximum switching voltage | |
| Minimum switching voltage | |
| Limiting continuous current | |
| Maximum inrush current | |
| Min. switching current | |
| Interrupting rating (ohmic load) max. | |
| General data | |
| Test voltage | Winding to contact Contact/contact |
| Ambient temperature (operation) | |
| Nominal operating mode | |
| Mechanical service life | |
| Service life, electrical | |
| Standards/regulations | |
| Pollution degree/surge voltage category | |
| Mounting position / Mounting | |
| Connection data solid / stranded / AWG | |
| Dimensions | W / H / D |

| Technical data | | | |
|---|------------|------------------------|----------|
| 24 V DC | 24 V AC | 120 V AC | 230 V AC |
| See diagram | | | |
| 19 | 34 / 26 | 9 / 7 | 6 / 5.5 |
| 8 | 3 ... 12 | 3 ... 12 | 3 ... 12 |
| 10 | 1.5 ... 14 | 1.5 ... 16 | 2 ... 22 |
| Damping diode, Yellow LED Varistor, Yellow LED | | | |
| PR... | | PR...AU | |
| Single contact, 1-PDT | | Single contact, 1-PDT | |
| AgNi | | AgNi, hard gold-plated | |
| 250 V AC/DC | | 30 V AC / 36 V DC | |
| 12 V (at 10 mA) | | 100 mV (at 10 mA) | |
| 10 A | | 50 mA | |
| 30 A (300 ms) | | 50 mA | |
| 100 mA | | 1 mA (at 24 V) | |
| 2500 VA | | - | |
| For more data, see diagram | | | |

| Description | Input voltage U_N |
|--|---------------------|
| Pre-assembled coupling relay modules with miniature power contact relay | 24 V DC |
| | 24 V AC |
| | 120 V AC |
| | 230 V AC |
| Pre-assembled coupling relay modules with multi-layer contact relay | 24 V DC |
| | 24 V AC |
| | 120 V AC |
| | 230 V AC |

| Ordering data | | |
|---------------------------------------|-----------|-------------|
| Type | Order No. | Pcs. / Pkt. |
| PR1-RSP3-LDP-24DC/21 ¹) | 2834407 | 5 |
| PR1-RSP3-LV- 24AC/21 ¹) | 2834410 | 5 |
| PR1-RSP3-LV-120AC/21 ¹) | 2834423 | 5 |
| PR1-RSP3-LV-230AC/21 ¹) | 2834436 | 5 |
| PR1-RSP3-LDP-24DC/21AU ¹) | 2834449 | 5 |
| PR1-RSP3-LV- 24AC/21AU ¹) | 2834452 | 5 |
| PR1-RSP3-LV-120AC/21AU ¹) | 2834465 | 5 |
| PR1-RSP3-LV-230AC/21AU ¹) | 2834478 | 5 |

Device marking label, for thermal transfer printer, labeling surface 6 x 15 mm

| Accessories | | |
|-----------------|---------|---|
| EML (15X6) R YE | 0819288 | 1 |
| | | |



PR1 relay module with 2 PDT contact relay

PR1-RSP3.../21 (1 PDT)

Operating voltage range of the relay



- 1 DC coils
- 2 AC coils

Electrical service life

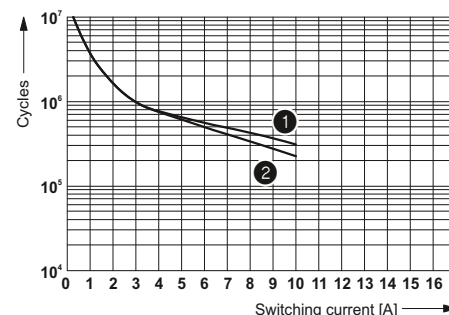

- 1 250 V AC, ohmic load (DC coils)
- 2 250 V AC, ohmic load (AC coils)

Interrupting rating



- 1 AC, ohmic load
- 2 DC, ohmic load
- 3 DC, L/R = 40 ms

Service life reduction factor with various cos phi



DC coils

AC coils

Technical data

| 24 V DC | 24 V AC | 120 V AC | 230 V AC |
|---------------------------|-----------------------|------------|----------|
| See diagram | | | |
| 19 | 34 / 26 | 9 / 7 | 6 / 5.5 |
| 8 | 3 ... 12 | 3 ... 12 | 3 ... 12 |
| 10 | 1.5 ... 14 | 1.5 ... 16 | 2 ... 22 |
| Damping diode, Yellow LED | | | |
| Varistor, Yellow LED | | | |
| PR... | PR...AU | | |
| Single contact, 2-PDT | Single contact, 2-PDT | | |

AgNi
250 V AC/DC
5 V (at 10 mA)
8 A
15 A (300 ms)
10 mA (At 5 V)
2000 VA
For more data, see diagram

4 kV (50 Hz, 1 min.)
2.5 kV (50 Hz, 1 min.)
-25°C ... 60°C
100% operating factor
3 x 10⁷ cycles
See diagram
IEC 60664, EN 50178, IEC 62103
3 / III
Any / In rows with zero spacing
0.2 - 1.5 mm² / 0.2 - 1.5 mm² / 24 - 16
16 mm / 97 mm / 72 mm

Ordering data

| Type | Order No. | Pcs. / Pkt. |
|--|-----------|-------------|
| PR1-RSP3-LDP-24DC/2X21 ¹⁾ | 2834562 | 5 |
| PR1-RSP3-LV- 24AC/2X21 ¹⁾ | 2834575 | 5 |
| PR1-RSP3-LV-120AC/2X21 ¹⁾ | 2834588 | 5 |
| PR1-RSP3-LV-230AC/2X21 ¹⁾ | 2834591 | 5 |
| PR1-RSP3-LDP-24DC/2X21AU ¹⁾ | 2834601 | 5 |
| PR1-RSP3-LV- 24AC/2X21AU ¹⁾ | 2834614 | 5 |
| PR1-RSP3-LV-120AC/2X21AU ¹⁾ | 2834627 | 5 |
| PR1-RSP3-LV-230AC/2X21AU ¹⁾ | 2834630 | 5 |

Accessories

| EML (15X6) R YE | 0819288 | 1 |
|-----------------|---------|---|
|-----------------|---------|---|

PR1-RSP3.../2x21 (2 PDT)

Operating voltage range of the relay

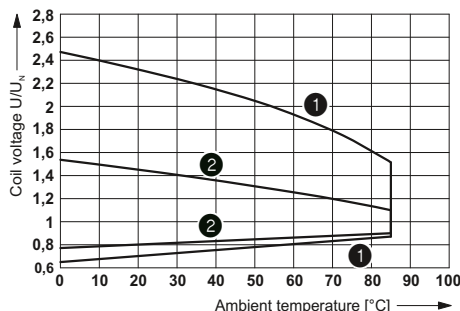

- 1 DC coils
- 2 AC coils

Interrupting rating

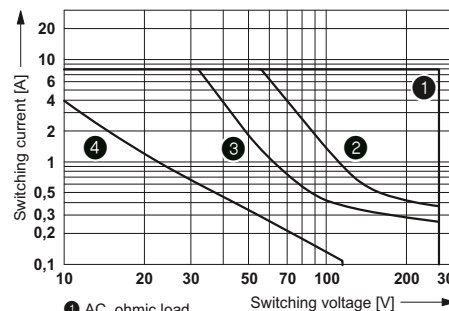

- 1 AC, ohmic load
- 2 DC, ohmic load, contacts in series
- 3 DC, ohmic load
- 4 DC, L/R = 40 ms

Service life reduction factor with various cos phi

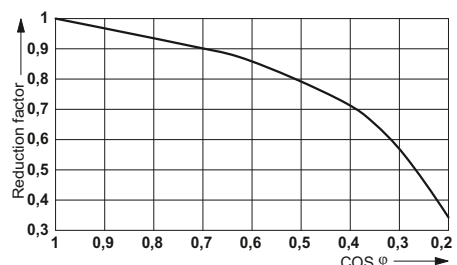

Electrical service life



- 1 250 V AC, ohmic load (DC coils)
- 2 250 V AC, ohmic load (AC coils)

Relay modules

PR series

Fully mounted PR2 relay modules

Fully mounted PR2 relay modules, consisting of:

- Relay base
 - 2/4 PDT relay
 - Relay retaining bracket
 - Input module/interference suppr. module (AC types only)
 - Marking labels
- The advantages:
- Relay with lockable manual operation and status LED
 - With DC types, freewheeling diode is integrated into relay
 - Mechanical switch position indicator
 - Logical contact arrangement thanks to 1/3-level relay base
 - Screw or spring-cage connection
 - 4 PDT types with multi-layer gold contacts

| Notes: |
|---|
| Type of housing: Polyamide fiber reinforced PA-F, color: green. |
| For the protection of input and output, inductive loads must be dampened with an effective protection circuit. |
| If the specified maximum values for multi-layer contact relays are exceeded, the gold plating is destroyed. The maximum values of the power contact relay are then valid. This can result in a shorter service life than with a pure power contact. |
| Other input voltages on request. |
| The DC types do not have a plug-in module because the status LED and the freewheeling diode are integrated directly into the relay. |
| 1) EMC: Class A product, see page 571 |



PR2 relay module with screw connection



| Input data | |
|--|---------------------------------------|
| Permissible range (with reference to U_N) | |
| Typ. input current with U_N (for AC: 50/60 Hz) | [mA] |
| Typ. response time at U_N | [ms] |
| Typ. release time at U_N | [ms] |
| Input protection: | 24 V DC 24, 120, 230 V AC |
| Output data | |
| Contact type | |
| Contact material | |
| Maximum switching voltage | |
| Minimum switching voltage | |
| Limiting continuous current | |
| Maximum inrush current | |
| Min. switching current | |
| Interrupting rating (ohmic load) max. | |
| General data | |
| Test voltage | Winding to contact Contact/contact |
| Ambient temperature (operation) | |
| Nominal operating mode | |
| Mechanical service life | |
| Service life, electrical | |
| Standards/regulations | |
| Pollution degree/surge voltage category | |
| Mounting position / Mounting | |
| Connection data solid / stranded / AWG | |
| Dimensions | W / H / D |

| Technical data | | | |
|---|----------|------------------------|----------|
| 24 V DC | 24 V AC | 120 V AC | 230 V AC |
| See diagram | | | |
| 38 | 54 / 46 | 11 / 9 | 5 / 4 |
| 13 | 4 ... 10 | 4 ... 10 | 4 ... 10 |
| 5 | 3 ... 12 | 3 ... 12 | 3 ... 12 |
| Damping diode, Green LED Varistor, LED red | | | |
| PR... | | PR...AU | |
| Single contact, 2-PDT | | Single contact, 4-PDT | |
| Ag | | AgNi, hard gold-plated | |
| 250 V AC / 125 V DC | | 250 V AC / 125 V DC | |
| 5 V | | 1 V | |
| 10 A | | 5 A | |
| 20 A (15 ms) | | 12 A (15 ms) | |
| 1 mA | | 1 mA | |
| 2500 VA | | 1250 VA | |
| For more data, see diagram | | | |

| Description | Input voltage U_N |
|---|---------------------|
| Pre-assembled coupling relay modules with 2-PDT contact relay | 24 V DC |
| | 24 V AC |
| | 120 V AC |
| | 230 V AC |
| Pre-assembled coupling relay modules with 4-PDT contact relay and additional hard gold-plating | 24 V DC |
| | 24 V AC |
| | 120 V AC |
| | 230 V AC |

| Ordering data | | |
|---|-----------|-------------|
| Type | Order No. | Pcs. / Pkt. |
| PR2-RSC3-LDP-24DC/2X21 ¹) | 2834643 | 5 |
| PR2-RSC3-LV- 24AC/2X21 ¹) | 2834656 | 5 |
| PR2-RSC3-LV-120AC/2X21 ¹) | 2834669 | 5 |
| PR2-RSC3-LV-230AC/2X21 ¹) | 2834672 | 5 |
| PR2-RSC3-LDP-24DC/4X21AU ¹) | 2834724 | 5 |
| PR2-RSC3-LV- 24AC/4X21AU ¹) | 2834737 | 5 |
| PR2-RSC3-LV-120AC/4X21AU ¹) | 2834740 | 5 |
| PR2-RSC3-LV-230AC/4X21AU ¹) | 2834753 | 5 |

| Accessories | | |
|-----------------|---------|---|
| EML (15X6) R YE | 0819288 | 1 |

Device marking label, for thermal transfer printer, labeling surface 6 x 15 mm



PR2 relay module with spring-cage connection

PR2-RS.../2x21 (2 PDT)

Operating voltage range of relay $T_u=T_{coil}$



AC interrupting rating



- 1 Ohmic load
- 2 $\cos \varphi = 0.4$



DC coils

AC coils

Technical data

| 24 V DC | 24 V AC | 120 V AC | 230 V AC |
|-------------|----------|----------|----------|
| See diagram | | | |
| 38 | 54 / 46 | 11 / 9 | 5 / 4 |
| 13 | 4 ... 10 | 4 ... 10 | 4 ... 10 |
| 5 | 3 ... 12 | 3 ... 12 | 3 ... 12 |

Damping diode, Green LED
Varistor, LED red

PR... AU
Single contact, 2-PDT Single contact, 4-PDT

Ag
250 V AC / 125 V DC
5 V
10 A
20 A (15 ms)
1 mA
2500 VA
For more data, see diagram

AgNi, hard gold-plated
250 V AC / 125 V DC
1 V
5 A
12 A (15 ms)
1 mA
1250 VA

2 kV (50 Hz, 1 min.)
2 kV (50 Hz, 1 min.)
-25°C ... 60°C
100% operating factor
5 x 10⁷ cycles
See diagram
IEC 60664, EN 50178, IEC 62103
3 / II
Any / In rows with zero spacing
0.2 - 1.5 mm² / 0.2 - 1.5 mm² / 24 - 16
31 mm / 95 mm / 84 mm

Ordering data

| Type | Order No. | Pcs. / Pkt. |
|--|-----------|-------------|
| PR2-RSP3-LDP-24DC/2X21 ¹⁾ | 2834685 | 5 |
| PR2-RSP3-LV- 24AC/2X21 ¹⁾ | 2834698 | 5 |
| PR2-RSP3-LV-120AC/2X21 ¹⁾ | 2834708 | 5 |
| PR2-RSP3-LV-230AC/2X21 ¹⁾ | 2834711 | 5 |
| PR2-RSP3-LDP-24DC/4X21AU ¹⁾ | 2834766 | 5 |
| PR2-RSP3-LV- 24AC/4X21AU ¹⁾ | 2834779 | 5 |
| PR2-RSP3-LV-120AC/4X21AU ¹⁾ | 2834782 | 5 |
| PR2-RSP3-LV-230AC/4X21AU ¹⁾ | 2834795 | 5 |

Accessories

| | | |
|-----------------|---------|---|
| EML (15X6) R YE | 0819288 | 1 |
|-----------------|---------|---|

DC interrupting rating

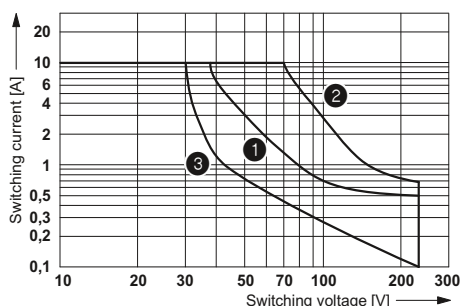

- 1 Ohmic load
- 2 ohmic load, contacts in series
- 3 L/R < 7 ms

Electrical service life

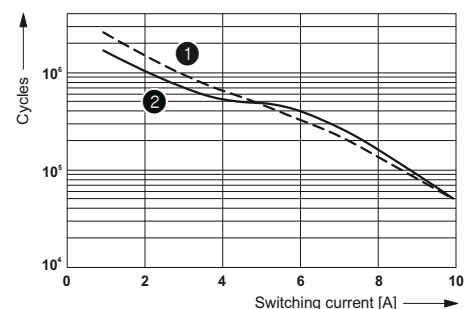

- 1 250 V AC, ohmic load
- 2 30 V DC, ohmic load

PR2-RS.../4x21 (4 PDT)

Operating voltage range of relay $T_u=T_{coil}$

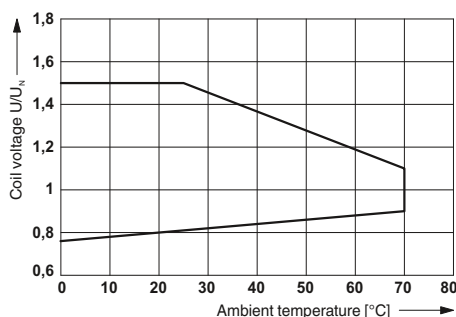

AC interrupting rating

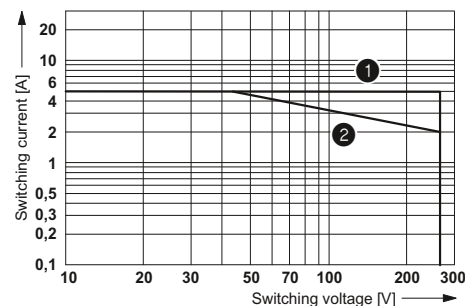

- 1 Ohmic load
- 2 $\cos \varphi = 0.4$

DC interrupting rating

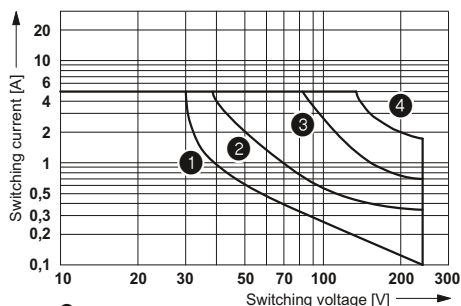

- 1 L/R < 7 ms
- 2 ohmic load
- 3 ohmic load, 2 contacts in series
- 4 ohmic load, 4 contacts in series

Electrical service life

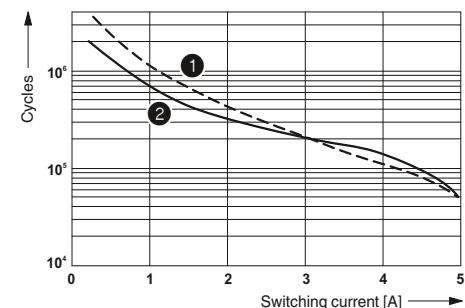

- 1 250 V AC, ohmic load
- 2 30 V DC, ohmic load



The Phoenix Contact DEK interface terminal blocks provide complete interface functions in modular terminal block housing that is just 6.2 mm wide. In conjunction with standard terminal block accessories, these high-capacity interfaces have not only the design but also the high level of user convenience of modular terminal blocks.

The main common feature of all Phoenix Contact interface terminal blocks is their width of just 6.2 mm. This saves 60% space in the control cabinet in comparison to conventional 15 mm wide coupling relays from modular systems.

The DEK range offers the best solution for all industrial voltages both for signal input and output.

High switching capacities are a matter of course for the DEK-REL... relay terminal block and the DEK-OV... solid-state relay terminal block.

The wear-free DEK-OV... power solid-state relay terminal block is used for applications that require a greater switching frequency in which electromechanical relays reach the end of their service life in a short time.

Integrated LEDs clearly indicate the switching status of the electronic terminal blocks and provide an excellent overview of the coupling level and the system.

Colored EB-DIK insertion bridges for the supply and ground signals make it possible to design the circuit simply and effectively.

Integrated protective circuits such as free-wheeling diodes, polarity reversal protection diodes, and surge protection elements protect the coupling modules and ensure optimum availability of the system.

DEK-REL-... relay terminal block

The Phoenix Contact relay terminal block with PDT contact offers the following advantages:

- Width of only 6.2 mm
- High switching capacity of 250 V AC/6 A
- Less storage, since PDT, N/O or N/C contacts can be wired
- Little wiring expense due to the use of EB-DIK insertion bridges
- IP67 protected relay housing
- Cadmium-free relay contacts
- 4 kV electrical isolation of input and output
- Safe isolation according to DIN EN 50178 (VDE 0160)
- Light indicator for signaling the switching status.

| |
|--|
| Notes: |
| Type of housing: Polyamide PA non-reinforced, color: green. |
| Marking systems and mounting material See Catalog 5 |
| For the protection of relay coils and contacts, inductive loads must be dampened with an efficient protection circuit. |
| For further EB...DIK... insertion bridges, refer to page 403 |
| 1) EMC: Class A product, see page 571 |



**For medium to large power
1 PDT (21)**



Technical data

| | |
|--|--|
| Input data | ① |
| Permissible range (with reference to U_N) | 0.8 - 1.1 |
| Typ. input current at U_N [mA] | 9 |
| Response/release time at U_N [ms] | 8 / 5 |
| Input protection: | Yellow LED, Protection against polarity reversal, freewheeling diode |
| Output data | |
| Contact type | Single contact, 1-PDT |
| Contact material | AgSnO |
| Max. switching voltage | 250 V AC/DC |
| Min. switching voltage | 12 V AC/DC |
| Limiting continuous current | 6 A |
| Max. inrush current | 6 A |
| Min. switching current | 10 mA |
| Max. interrupting rating, ohmic load | |
| | 24 V DC 140 W |
| | 48 V DC 20 W |
| | 60 V DC 18 W |
| | 110 V DC 23 W |
| | 220 V DC 40 W |
| | 250 V AC 1500 VA |
| General data | |
| Test voltage (winding / contact) | 4 kV AC (50 Hz, 1 min.) |
| Ambient temperature (operation) | -20°C ... 50°C |
| Mechanical service life | Approx. 10^7 cycles |
| Standards/regulations | IEC 60664, EN 50178, IEC 62103 |
| Connection data solid / stranded / AWG | 0.2 - 2.5 mm ² / 0.2 - 2.5 mm ² / 24 - 14 |
| Dimensions W / H / D | 6.2 mm / 80 mm / 56 mm |

Ordering data

| Description | Input voltage U_N | Type | Order No. | Pcs. / Pkt. |
|--|---------------------|------------------------------|-----------|-------------|
| Relay terminal block with power relay | ① 24 V DC | DEK-REL-G24/21 ¹⁾ | 2964500 | 10 |

Accessories

| Cover | No. of pos. | Color | D-DEK 1,5 GN | 2716949 | 10 | |
|--|-------------|-------|---------------|---------|---------|---|
| Insertion bridge, for middle and lower levels | 80 | blue | EB 80- DIK BU | 26 A | 2715940 | 1 |
| | 80 | red | EB 80- DIK RD | 26 A | 2715953 | 1 |
| | 80 | white | EB 80- DIK WH | 26 A | 2715788 | 1 |

Relay modules

DEK series

DEK-REL-24/1/SEN input interface and DEK-REL-24/1/AKT output interface

In addition to the familiar advantages of the DEK-REL... electronic terminal blocks, such as

- 2-layer contact with hard gold-plating for universal applications from 1 mA to 5 A continuous current
- 2 kV_{rms} electrical isolation of input and output
- Integrated input circuit

With this terminal block, "ALL" connections for a sensor or actuator are provided over a width of just 6.2 mm!

This means that 16 outputs take up a total constructional width of just 105.4 mm (including the power terminal block).

Advantages:

- Lower costs as the N terminal block is no longer required
- Wiring is reduced to a minimum
- Up to 73% more space

| Notes: | |
|--|--|
| Type of housing: | Polyamide PA non-reinforced, color: green. |
| Marking systems and mounting material | See Catalog 5 |
| For the protection of relay coils and contacts, inductive loads must be dampened with an efficient protection circuit. | |
| For further EB...DIK... insertion bridges, refer to page 403 | |
| 1) EMC: Class A product, see page 571 | |



for small to medium loads
1 N/O contact (1)



Technical data

| Input data | | ① | ② |
|---|------|---|-----------|
| Permissible range (with reference to U _N) | | 0.9 - 1.1 | 0.8 - 1.1 |
| Typ. input current at U _N | [mA] | 23 | 6.5 |
| Response/release time at U _N | [ms] | 8 / 15 | 5 / 15 |
| Input protection: | | Yellow LED, Bridge rectifier | |
| Output data | | | |
| Contact type | | Double contact, 1 N/O contact | |
| Contact material | | AgNi, hard gold-plated | |
| Max. switching voltage | | 250 V AC / 125 V DC | |
| Min. switching voltage | | 0.1 V | |
| Limiting continuous current | | 3 A (5 A up to 35°C at 24 V DC) | |
| Max. inrush current | | 5 A | |
| Min. switching current | | 1 mA | |
| Max. interrupting rating, ohmic load | | 24 V DC | 72 W |
| | | 48 V DC | 60 W |
| | | 60 V DC | 50 W |
| | | 110 V DC | 50 W |
| | | 250 V AC | 750 VA |
| General data | | | |
| Test voltage (winding / contact) | | 2 kV AC (50 Hz, 1 min.) | |
| Ambient temperature (operation) | | -20°C ... 50°C | |
| Mechanical service life | | Approx. 2 x 10 ⁷ cycles | |
| Standards/regulations | | IEC 60664, EN 50178, IEC 62103 | |
| Connection data solid / stranded / AWG | | 0.2 - 2.5 mm ² / 0.2 - 2.5 mm ² / 24 - 14 | |
| Dimensions | | W / H / D 6.2 mm / 80 mm / 56 mm | |



Pin configuration, DEK-REL...AKT

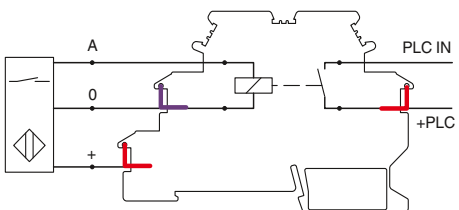

Pin configuration, DEK-REL...SEN

| General data | |
|--|---|
| Test voltage (winding / contact) | 2 kV AC (50 Hz, 1 min.) |
| Ambient temperature (operation) | -20°C ... 50°C |
| Mechanical service life | Approx. 2 x 10 ⁷ cycles |
| Standards/regulations | IEC 60664, EN 50178, IEC 62103 |
| Connection data solid / stranded / AWG | 0.2 - 2.5 mm ² / 0.2 - 2.5 mm ² / 24 - 14 |
| Dimensions | W / H / D 6.2 mm / 80 mm / 56 mm |

Ordering data

| Description | Input voltage U _N | Type | Order No. | Pcs. / Pkt. |
|---|------------------------------|-------------------|-----------|-------------|
| Relay terminal block with miniature relay | ① 5 V AC/DC | DEK-REL- 5/I(1') | 2941183 | 10 |
| | ② 24 V AC/DC | DEK-REL- 24/I(1') | 2940171 | 10 |

Accessories

| Terminal block, with three through contacts, for mounting on NS 35... For busbar feeding | No. of pos. | Color | Order No. | Pcs. / Pkt. |
|--|-------------|-------|-----------|-------------|
| Insertion bridge, for middle and lower levels | 80 | blue | 2715940 | 1 |
| | 80 | red | 2715953 | 1 |
| | 80 | white | 2715788 | 1 |

| | | |
|---------------|--------------|----|
| D-DEK 1,5 GN | 2716949 | 10 |
| EB 80- DIK BU | 26 A 2715940 | 1 |
| EB 80- DIK RD | 26 A 2715953 | 1 |
| EB 80- DIK WH | 26 A 2715788 | 1 |



for small to medium loads
1 N/O contact (1)



for small to medium loads
1 N/O contact (1)



for small to medium loads
1 N/O contact (1)



Technical data

① 0.9 - 0.8 -
1.1 1.1
23 6.5
8 / 15 5 / 15
Yellow LED, Bridge rectifier

Double contact, 1 N/O contact
AgNi, hard gold-plated
250 V AC / 125 V DC
0.1 V
3 A (5 A up to 35°C at 24 V DC)
5 A
1 mA

72 W
60 W
50 W
50 W
750 VA

2 kV AC (50 Hz, 1 min.)
-20°C ... 50°C
Approx. 2 x 10⁷ cycles
IEC 60664, EN 50178, IEC 62103
0.2 - 2.5 mm² / 0.2 - 2.5 mm² / 24 - 14
6.2 mm / 80 mm / 56 mm

Ordering data

| Type | Order No. | Pcs. / Pkt. |
|--------------------|-----------|-------------|
| DEK-REL- 5/O/1'1) | 2941170 | 10 |
| DEK-REL- 24/O/1'1) | 2941154 | 10 |

Accessories

| Accessories | Order No. | Pcs. / Pkt. |
|---------------|--------------|-------------|
| D-DEK 1,5 GN | 2716949 | 10 |
| EB 80- DIK BU | 26 A 2715940 | 1 |
| EB 80- DIK RD | 26 A 2715953 | 1 |
| EB 80- DIK WH | 26 A 2715788 | 1 |

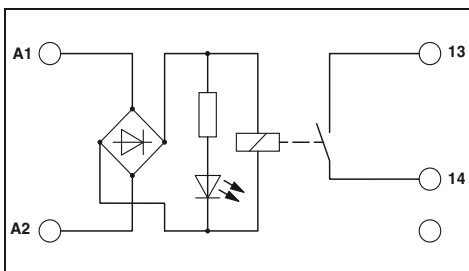

Technical data

① 0.8 -
1.1
6.5
5 / 15
Yellow LED, Bridge rectifier

Double contact, 1 N/O contact
AgNi, hard gold-plated
250 V AC / 125 V DC
0.1 V
3 A (5 A up to 35°C at 24 V DC)
5 A
1 mA

72 W
60 W
50 W
50 W
750 VA

2 kV AC (50 Hz, 1 min.)
-20°C ... 50°C
Approx. 2 x 10⁷ cycles
IEC 60664, EN 50178, IEC 62103
0.2 - 2.5 mm² / 0.2 - 2.5 mm² / 24 - 14
6.2 mm / 80 mm / 56 mm

Ordering data

| Type | Order No. | Pcs. / Pkt. |
|----------------------|-----------|-------------|
| DEK-REL- 24/1/AKT'1) | 2964063 | 10 |

Accessories

| Accessories | Order No. | Pcs. / Pkt. |
|---------------|--------------|-------------|
| DIKD 1,5 | 2715979 | 50 |
| D-DEK 1,5 GN | 2716949 | 10 |
| EB 80- DIK BU | 26 A 2715940 | 1 |
| EB 80- DIK RD | 26 A 2715953 | 1 |
| EB 80- DIK WH | 26 A 2715788 | 1 |

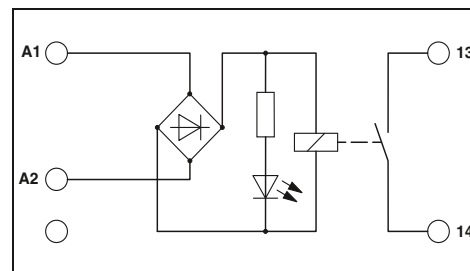

Technical data

① 0.8 -
1.1
6.5
5 / 15
Yellow LED, Bridge rectifier

Double contact, 1 N/O contact
AgNi, hard gold-plated
250 V AC / 125 V DC
0.1 V
3 A (5 A up to 35°C at 24 V DC)
5 A
1 mA

72 W
60 W
50 W
50 W
750 VA

2 kV AC (50 Hz, 1 min.)
-20°C ... 50°C
Approx. 2 x 10⁷ cycles
IEC 60664, EN 50178, IEC 62103
0.2 - 2.5 mm² / 0.2 - 2.5 mm² / 24 - 14
6.2 mm / 80 mm / 56 mm

Ordering data

| Type | Order No. | Pcs. / Pkt. |
|----------------------|-----------|-------------|
| DEK-REL- 24/1/SEN'1) | 2964050 | 10 |

Accessories

| Accessories | Order No. | Pcs. / Pkt. |
|---------------|--------------|-------------|
| DIKD 1,5 | 2715979 | 50 |
| D-DEK 1,5 GN | 2716949 | 10 |
| EB 80- DIK BU | 26 A 2715940 | 1 |
| EB 80- DIK RD | 26 A 2715953 | 1 |
| EB 80- DIK WH | 26 A 2715788 | 1 |

Relay modules

DEK series

DEK-OE... and DEK-OV... solid-state relay terminal blocks

Phoenix Contact DEK-OE and DEK-OV interface terminal blocks are only 6.2 mm wide but still provide a complete input or output interface with:

- Electrical isolation between input and output at up to 2.5 kV_{rms}
- Integrated input circuit
- Status display
- EB-DIK insertion bridges
- Labeling and mounting with modular terminal block convenience
- Wear-free switching up to 24 V DC/10 A and 240 V AC/800 mA
- Integrated output protection circuit
- Zero voltage switch at AC output
- Actuator version available.

| Notes: |
|--|
| Type of housing: Polyamide PA non-reinforced, color: green. |
| Marking systems and mounting material See Catalog 5 |
| For the protection of input and output, inductive loads must be damped with an effective protection circuit. |
| For further EB...DIK... insertion bridges, refer to page 403 |
| 1) EMC: Class A product, see page 571 |



with DC voltage output
max. = 100 mA



Derating curve for DEK-OV...24DC/3 and DEK-OV-24DC/24DC/3/AKT



- 1 Horizontal mounting
- 2 Vertical mounting

Derating curve for DEK-OV-24DC/24DC/10



Derating curve for DEK-OV...240AC/800



| | |
|---|----------------------------------|
| Input data | |
| Permissible range (with reference to U _N) | |
| Switching level with reference to U _N | 1 signal ("H") 0 signal ("L") |
| Typ. input current at U _N | [mA] |
| Transmission frequency f _{limit} | [Hz] |
| Input circuit AC | |
| Input circuit DC | |
| Output data | |
| Operating voltage range | |
| Periodic peak reverse voltage | |
| Limiting continuous current | |
| Min. load current | |
| Surge current | |
| Leakage current in off state | |
| Max. load value | |
| Output protection | |
| Voltage drop at max. limiting continuous current | |
| General data | |
| Test voltage input/output | |
| Ambient temperature (operation) | |
| Standards/regulations | |
| Pollution degree/surge voltage category | |
| Connection data solid / stranded / AWG | |
| Dimensions | W / H / D |

| Technical data | | | | | |
|----------------|-----------|-----------|-----------|-----------|-----------|
| ① | ② | ③ | ④ | ⑤ | ⑥ |
| 0.9 - 1.1 | 0.8 - 1.2 | 0.8 - 1.2 | 0.8 - 1.2 | 0.9 - 1.1 | 0.9 - 1.1 |
| ≥ 0.8 | ≥ 0.8 | ≥ 0.8 | ≥ 0.8 | ≥ 0.8 | ≥ 0.9 |
| ≤ 0.4 | ≤ 0.4 | ≤ 0.4 | ≤ 0.4 | ≤ 0.4 | ≤ 0.4 |
| 6.5 | 11 | 7 | 4 | 3.2 | 2.5 |
| 300 | 300 | 300 | 300 | 3 | 3 |

Yellow LED, Protection against polarity reversal, Surge protection

Yellow LED, Protection against polarity reversal

| |
|--|
| 3 V DC ... 48 V DC |
| - |
| 100 mA |
| - |
| - |
| - |
| - |
| Protection against polarity reversal, freewheeling diode |
| ≤ 0.9 V |

| |
|---|
| 2.5 kV (50 Hz, 1 min.) |
| -20°C ... 60°C |
| IEC 60664, EN 50178, IEC 62103 |
| 2 / III |
| 0.2 - 2.5 mm ² / 0.2 - 2.5 mm ² / 24 - 14 |
| 6.2 mm / 80 mm / 56 mm |

| Description | Input voltage U _N |
|---------------------------------|------------------------------|
| Solid-state input relays | |
| ① | 5 V DC |
| ② | 12 V DC |
| ③ | 24 V DC |
| ④ | 60 V DC |
| ⑤ | 120 V AC |
| ⑥ | 230 V AC |
| Solid-state power relays | |
| ① | 5 V DC |
| ② | 12 V DC |
| ③ | 24 V DC |
| Actuator principle | ⑦ 24 V DC |

Ordering data

| Type | Order No. | Pcs. / Pkt. |
|--------------------------------------|-----------|-------------|
| DEK-OE- 5DC/ 48DC/100 ¹⁾ | 2940223 | 10 |
| DEK-OE- 12DC/ 48DC/100 ¹⁾ | 2964487 | 10 |
| DEK-OE- 24DC/ 48DC/100 ¹⁾ | 2940207 | 10 |
| DEK-OE- 60DC/ 48DC/100 ¹⁾ | 2941536 | 10 |
| DEK-OE-120AC/ 48DC/100 | 2941659 | 10 |
| DEK-OE-230AC/ 48DC/100 | 2940210 | 10 |

Accessories

| Insertion bridge, for middle and lower levels | No. of pos. | Color | Accessories | Order No. | Pcs. / Pkt. |
|---|-------------|-------|---------------|--------------|-------------|
| | 80 | blue | EB 80- DIK BU | 26 A 2715940 | 1 |
| | 80 | red | EB 80- DIK RD | 26 A 2715953 | 1 |
| | 80 | white | EB 80- DIK WH | 26 A 2715788 | 1 |



with DC voltage output
max. = 3 A



with DC voltage output
max. = 10 A



with AC voltage output
max. = 800 mA

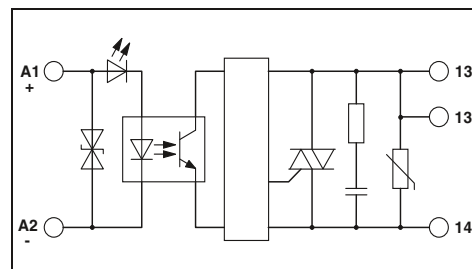
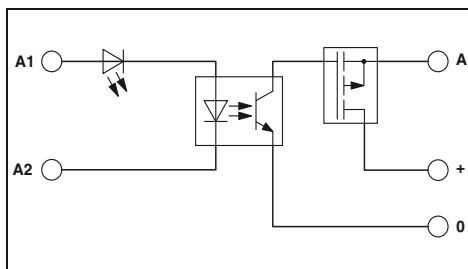
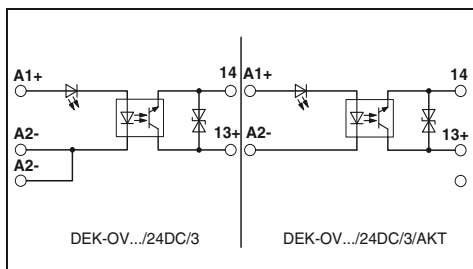

| Technical data | | | | | | |
|----------------|-----------|-----------|-----------|-------|-------|-----|
| ① | ② | ③ | ⑦ | ⑧ | ⑨ | ⑩ |
| 0.8 - 1.2 | 0.8 - 1.2 | 0.8 - 1.2 | 0.8 - 1.2 | ≥ 0.8 | ≤ 0.4 | 300 |
| ≥ 0.8 | ≥ 0.8 | ≥ 0.8 | ≥ 0.8 | ≤ 0.4 | ≤ 0.4 | 300 |
| 11 | 8.5 | 7 | 7 | | | |
| 300 | 300 | 300 | 300 | | | |

| Technical data | | | | | | |
|----------------|-----------|-----------|-----------|-------|-------|-----|
| ① | ② | ③ | ⑦ | ⑧ | ⑨ | ⑩ |
| 0.8 - 1.2 | 0.8 - 1.2 | 0.8 - 1.2 | 0.8 - 1.2 | ≥ 0.8 | ≤ 0.4 | 100 |
| ≥ 0.8 | ≥ 0.8 | ≥ 0.8 | ≥ 0.8 | ≤ 0.4 | ≤ 0.4 | 100 |
| 5.1 | 4.7 | 3.5 | 3.5 | | | |
| 100 | 100 | 100 | 100 | | | |

| Technical data | | | | | | |
|----------------|-----------|-----------|-----------|-------|-------|----|
| ① | ② | ③ | ⑦ | ⑧ | ⑨ | ⑩ |
| 0.8 - 1.2 | 0.8 - 1.2 | 0.8 - 1.2 | 0.8 - 1.2 | ≥ 0.8 | ≤ 0.4 | 10 |
| ≥ 0.8 | ≥ 0.8 | ≥ 0.8 | ≥ 0.8 | ≤ 0.4 | ≤ 0.4 | 10 |
| 10.2 | 10.5 | 10.7 | 10.7 | | | |
| 10 | 10 | 10 | 10 | | | |

Yellow LED, Protection against polarity reversal

Yellow LED, Protection against polarity reversal, Surge protection

Yellow LED, Protection against polarity reversal, Surge protection

| |
|---|
| 3 V DC ... 30 V DC |
| - |
| 3 A (see derating curve) |
| - |
| - |
| - |
| Protection against polarity reversal, Surge protection ≤ 0.2 V |

| |
|---|
| 5 V DC ... 30 V DC |
| - |
| 10 A (see derating curve) |
| - |
| 100 A (t = 20 ms) |
| - |
| - |
| Protection against polarity reversal, Surge protection < 50 mV |

| |
|---------------------------------|
| 10 V AC ... 253 V AC (50/60 Hz) |
| 600 V |
| 0.8 A (see derating curve) |
| 10 mA |
| 30 A (t = 10 ms) |
| 1.2 mA |
| 4.5 A ^{2s} |
| RCV circuit |
| ≤ 1 V |

| |
|---|
| 2.5 kV (50 Hz, 1 min.) |
| -20°C ... 60°C |
| IEC 60664, EN 50178, IEC 62103 |
| 2 / III |
| 0.2 - 2.5 mm ² / 0.2 - 2.5 mm ² / 24 - 14 |
| 6.2 mm / 80 mm / 56 mm |

| |
|---|
| 2.5 kV (50 Hz, 1 min.) |
| -20°C ... 60°C |
| IEC 60664, EN 50178, IEC 62103 |
| 2 / III |
| 0.2 - 2.5 mm ² / 0.2 - 2.5 mm ² / 24 - 14 |
| 6.2 mm / 80 mm / 56 mm |

| |
|---|
| 2.5 kV (50 Hz, 1 min.) |
| -20°C ... 60°C |
| IEC 60664, EN 50178, IEC 62103 |
| 2 / III |
| 0.2 - 4 mm ² / 0.2 - 2.5 mm ² / 24 - 12 |
| 6.2 mm / 80 mm / 56 mm |

| Ordering data | | |
|-------------------------------------|-----------|-------------|
| Type | Order No. | Pcs. / Pkt. |
| DEK-OV- 5DC/ 24DC/ 3 ¹⁾ | 2941361 | 10 |
| DEK-OV- 12DC/ 24DC/ 3 ¹⁾ | 2941387 | 10 |
| DEK-OV- 24DC/ 24DC/ 3 ¹⁾ | 2941374 | 10 |
| DEK-OV- 24DC/ 24DC/ 3/AKT | 2964296 | 10 |

| Ordering data | | |
|--------------------------------------|-----------|-------------|
| Type | Order No. | Pcs. / Pkt. |
| DEK-OV- 5DC/ 24DC/ 10 ¹⁾ | 2961752 | 10 |
| DEK-OV- 12DC/ 24DC/ 10 ¹⁾ | 2961749 | 10 |
| DEK-OV- 24DC/ 24DC/ 10 ¹⁾ | 2964322 | 10 |

| Ordering data | | |
|------------------------|-----------|-------------|
| Type | Order No. | Pcs. / Pkt. |
| DEK-OV- 5DC/240AC/800 | 2964623 | 10 |
| DEK-OV- 12DC/240AC/800 | 2964636 | 10 |
| DEK-OV- 24DC/240AC/800 | 2964649 | 10 |

| Accessories | | | |
|---------------|-----------|-----------|-------------|
| Type | Order No. | Order No. | Pcs. / Pkt. |
| EB 80- DIK BU | 26 A | 2715940 | 1 |
| EB 80- DIK RD | 26 A | 2715953 | 1 |
| EB 80- DIK WH | 26 A | 2715788 | 1 |

| Accessories | | | |
|---------------|-----------|-----------|-------------|
| Type | Order No. | Order No. | Pcs. / Pkt. |
| EB 80- DIK BU | 26 A | 2715940 | 1 |
| EB 80- DIK RD | 26 A | 2715953 | 1 |
| EB 80- DIK WH | 26 A | 2715788 | 1 |

| Accessories | | | |
|---------------|-----------|-----------|-------------|
| Type | Order No. | Order No. | Pcs. / Pkt. |
| EB 80- DIK BU | 26 A | 2715940 | 1 |
| EB 80- DIK RD | 26 A | 2715953 | 1 |
| EB 80- DIK WH | 26 A | 2715788 | 1 |



DEK-REL-24/1/S switch/relay terminal block

The functions “Manual”, “0”, “Automatic” are provided in a 6.2 mm narrow relay terminal block.

Interference-free relay and solid-state relay interfaces

Coupled interference voltages on the coil lines or leakage currents can cause malfunctions in conventional modules. These special interface modules, equipped with high switching thresholds and/or effective filters, ensure good functioning.

ST-REL... and EMG 17-REL... relay interfaces for switching lamp loads

Lamp loads and capacitive consumers produce extremely high inrush currents which weld conventional relay contacts. To prevent this, Phoenix Contact uses an arc-resistant contact optimized for these applications, which keeps these peaks under control.

ST-OV 3-24DC/400/3 plug-in solid-state power relay

The output of this component, dimensioned with a peak reverse voltage of 800 V, allows, for example, 230 V motors to be driven in simple reversible mode.

Power circuit breaker solid-state relay, with signal logic

These modules combine the features of a short-circuit-proof power solid-state relay and those of a thermomagnetic protection element.

DEK-OE-...100KHZ 100 kHz input solid-state relay

Input solid-state relay for reliable transmission of high frequency signals of the type that occur with, for example, incremental encoders.

Electronic sensor terminal block for NAMUR proximity sensors

For converting the changeable resistance of a NAMUR sensor into a digital signal that can be read by a PLC.

DEK-TR/INV inverter module

Module for converting NPN outputs to PNP outputs and PNP to NPN.

Relay module with manual switch

Relay module with manual switch and integrated power relay for manual, zero, and automatic functions

The advantages:

- Max. switching current of 5 A
- Only 6.2 mm wide
- Increased contact stability thanks to double contact
- Safe isolation according to DIN EN 50178 between coil and contact

| |
|--|
| Notes: |
| Type of housing: Polyamide PA non-reinforced, color: green. |
| Marking systems and mounting material See Catalog 5 |
| For the protection of input and output, inductive loads must be damped with an effective protection circuit. |
| 1) EMC: Class A product, see page 571 |



Relay module with manual switch and integrated relay



Technical data

| | |
|--|---|
| Input data | ① |
| Permissible range (with reference to U_N) | 0.8 - 1.1 |
| Typ. input current at U_N [mA] | 6.5 |
| Response/release time at U_N [ms] | 5 / 15 |
| Input protection: | Yellow LED, Bridge rectifier |
| Output data | |
| Contact type | Double contact, 1 N/O contact |
| Contact material | AgNi, hard gold-plated |
| Max. switching voltage | 250 V AC / 125 V DC |
| Min. switching voltage | 0.1 V |
| Limiting continuous current | 3 A (5 A up to 35°C at 24 V DC) |
| Max. inrush current | 5 A |
| Min. switching current | 1 mA |
| Max. interrupting rating, ohmic load | |
| | 24 V DC 72 W |
| | 48 V DC 60 W |
| | 60 V DC 50 W |
| | 110 V DC 50 W |
| | 250 V AC 750 VA |
| General data | |
| Test voltage (winding / contact) | 2 kV AC (50 Hz, 1 min.) |
| Ambient temperature (operation) | -20°C ... 50°C |
| Mechanical service life | Approx. 2×10^7 cycles |
| Standards/regulations | IEC 60664, EN 50178, IEC 62103 |
| Connection data solid / stranded / AWG | 0.2 - 2.5 mm ² / 0.2 - 2.5 mm ² / 24 - 14 |
| Dimensions | W / H / D 6.2 mm / 80 mm / 61 mm |

Ordering data

| Description | Input voltage U_N | Type | Order No. | Pcs. / Pkt. |
|-------------------------------|---------------------|--------------------------------|-----------|-------------|
| Relay module with power relay | ① 24 V AC/DC | DEK-REL- 24/1/S ¹) | 2964131 | 10 |

Accessories

| Cover | No. of pos. | Color | D-DEK 1,5 GN | 2716949 | 10 |
|------------------|-------------|-------|---------------|---------|----|
| Insertion bridge | 2 | red | EB 2- DIK RD | 2716693 | 10 |
| | 3 | red | EB 3- DIK RD | 2716745 | 10 |
| | 4 | red | EB 4- DIK RD | 2716758 | 10 |
| | 5 | red | EB 5- DIK RD | 2716761 | 10 |
| | 10 | red | EB 10- DIK RD | 2716774 | 10 |
| | 2 | blue | EB 2- DIK BU | 2716648 | 10 |
| | 3 | blue | EB 3- DIK BU | 2716651 | 10 |
| | 4 | blue | EB 4- DIK BU | 2716664 | 10 |
| | 5 | blue | EB 5- DIK BU | 2716677 | 10 |
| | 10 | blue | EB 10- DIK BU | 2716680 | 10 |
| | 80 | blue | EB 80- DIK BU | 2715940 | 1 |
| | 80 | red | EB 80- DIK RD | 2715953 | 1 |
| | 80 | white | EB 80- DIK WH | 2715788 | 1 |

Relay modules

Special relays and solid-state relays

Relay modules with interference current filter

Relay and solid-state relay modules with integrated filter to protect against interference voltages or currents due, for example, to long control lines

The advantages:

- Resistant to interference currents
- High relay release voltage

Typical applications:

- Applications with long control lines
- Use of AC output boards, resulting in residual AC currents



1 PDT, plug-in relay



1 PDT, soldered-in relay

Notes:
Load current diagrams, see page 347

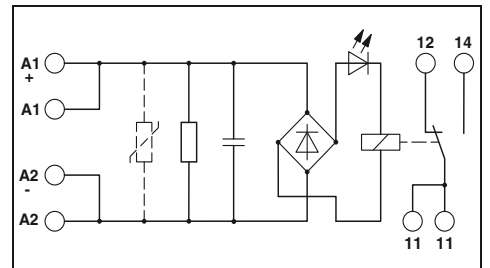
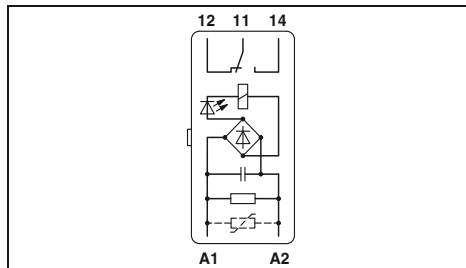

Technical data

| | | | |
|--|-----------|------------|-----------|
| Input data | | | |
| Permissible range (with reference to U_N) | ① | ② | ③ |
| Typ. input current at U_N | 0.9 - 1.1 | 0.85 - 1.1 | 0.9 - 1.1 |
| Response/release time at U_N | 26 | 19 | 18 |
| Input protection: | 8 / 10 | 8 / 11 | 10 / 8 |

| | | |
|-----------|------------|-----------|
| ① | ② | ③ |
| 0.9 - 1.1 | 0.85 - 1.1 | 0.9 - 1.1 |
| 26 | 19 | 18 |
| 8 / 10 | 8 / 11 | 10 / 8 |

Yellow LED, Bridge rectifier, Surge protection

Technical data

| |
|-----------|
| ③ |
| 0.9 - 1.1 |
| 18 |
| 10 / 8 |

Yellow LED, Bridge rectifier, Surge protection

| | | | |
|--------------------------------------|---|-----------------------|--|
| Output data | | | |
| Contact type | Single contact, 1-PDT | Double contact, 1 PDT | |
| Contact material | AgNi | Au | |
| Max. switching voltage | 250 V AC/DC | 30 V AC / 36 V DC | |
| Limiting continuous current | 6 A | 0.5 A | |
| Max. inrush current | 8 A | 0.2 A | |
| Max. interrupting rating, ohmic load | 24 V DC 140 W 48 V DC 60 W 60 V DC 45 W 110 V DC 35 W 220 V DC 55 W 250 V AC 1500 VA | 5 W | |

| | |
|---|-----------------------|
| Single contact, 1-PDT | Double contact, 1 PDT |
| AgNi | Au |
| 250 V AC/DC | 30 V AC / 36 V DC |
| 6 A | 0.5 A |
| 8 A | 0.2 A |
| 24 V DC 140 W 48 V DC 60 W 60 V DC 45 W 110 V DC 35 W 220 V DC 55 W 250 V AC 1500 VA | 5 W |

| | |
|---|--------------------------|
| Single contact, 1-PDT | Double contact, 1 PDT |
| AgNi | AgPd60, hard gold-plated |
| 250 V AC/DC | 30 V AC / 36 V DC |
| 6 A | 0.5 A |
| 8 A | 0.2 A |
| 95 W 50 W 45 W 35 W 55 W 1500 VA | 5 W |

| | |
|--|---|
| General data | |
| Test voltage (winding / contact) | 2.5 kV AC (50 Hz, 1 min.) |
| Ambient temperature (operation) | -20°C ... 50°C |
| Mechanical service life | Approx. 2 x 10 ⁷ cycles |
| Standards/regulations | IEC 60664, EN 50178, IEC 62103 |
| Connection data solid / stranded / AWG | - / - / - |
| Dimensions | W / H / D 20.8 mm / 42.5 mm / 112 mm |

| |
|------------------------------------|
| 2.5 kV AC (50 Hz, 1 min.) |
| -20°C ... 50°C |
| Approx. 2 x 10 ⁷ cycles |
| IEC 60664, EN 50178, IEC 62103 |
| - / - / - |
| 20.8 mm / 42.5 mm / 112 mm |

| |
|---|
| 2.5 kV AC (50 Hz, 1 min.) |
| -20°C ... 40°C |
| Approx. 2 x 10 ⁷ cycles |
| IEC 60664, EN 50178, IEC 62103 |
| 0.2 - 4 mm ² / 0.2 - 2.5 mm ² / 24 - 12 |
| 22.5 mm / 75 mm / 62.5 mm |

Ordering data

| Description | Input voltage U_N | Type | Order No. | Pcs. / Pkt. |
|---|---------------------|--------------------------|-----------|-------------|
| Relay module with power contact relay | ① 24 V AC | ST-REL3-KG 24/21/SO46 | 2826091 | 10 |
| | ② 120 V AC | ST-REL3-KG120/21/SO46 | 2833026 | 10 |
| | ③ 230 V AC | ST-REL3-KG230/21/SO46 | 2832027 | 10 |
| Relay module with multi-layer contact relay | ① 24 V AC | ST-REL3-KG 24/21/AU/SO46 | 2826981 | 10 |
| | ② 120 V AC | ST-REL3-KG120/21/AU/SO46 | 2829797 | 10 |
| | ③ 230 V AC | ST-REL3-KG230/21/AU/SO46 | 2826266 | 10 |

| Type | Order No. | Pcs. / Pkt. |
|--------------------------|-----------|-------------|
| ST-REL3-KG 24/21/SO46 | 2826091 | 10 |
| ST-REL3-KG120/21/SO46 | 2833026 | 10 |
| ST-REL3-KG230/21/SO46 | 2832027 | 10 |
| ST-REL3-KG 24/21/AU/SO46 | 2826981 | 10 |
| ST-REL3-KG120/21/AU/SO46 | 2829797 | 10 |
| ST-REL3-KG230/21/AU/SO46 | 2826266 | 10 |

Ordering data

| Type | Order No. | Pcs. / Pkt. |
|-------------------------------|-----------|-------------|
| EMG 22-REL/KSR-230/21/ SO46 | 2940760 | 10 |
| EMG 22-REL/KSR-230/21/AU/SO46 | 2940061 | 10 |

Accessories

| | | | |
|---|---------|---------|----|
| Basic terminal block, complete with end cover | URELG 3 | 2820136 | 10 |
| Equipment marker | | | |

| | | |
|---------|---------|----|
| URELG 3 | 2820136 | 10 |
|---------|---------|----|

Accessories

| | | |
|------------|---------|----|
| EMG-GKS 12 | 2947035 | 50 |
|------------|---------|----|

| | |
|---|--|
| Notes: | |
| Type of housing: | |
| ST-REL: Polyamide non-reinforced PA, color: bottom part gray, hood green | |
| EMG: Polyamide fiber reinforced PA-F, color: green. | |
| DEK: Polyamide non-reinforced PA, color: green. | |
| Marking systems and mounting material See Catalog 5 | |
| For derating curve, refer to page 345 | |
| 1) EMC: Class A product, see page 571 | |

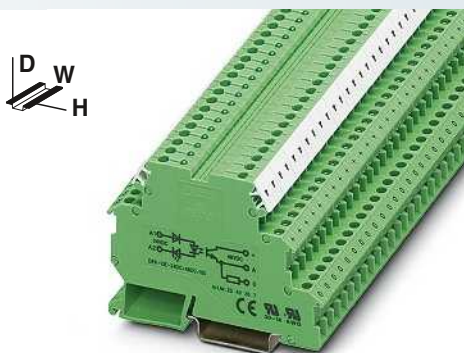

Solid-state input relay
100 mA, maximum



Solid-state power relay
Max. 2 A

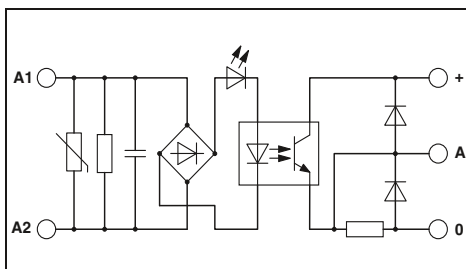

Technical data

| | |
|--|---|
| Input data | ② |
| Permissible range (with reference to U_N) | 0.9 - 1.1 |
| Switching level | 1 signal ("H") [V DC] \geq 207 0 signal ("L") [V DC] \leq 92 |
| Typ. input current at U_N | [mA] 2.5 |
| Typ. switch-on time at U_N | [ms] 4.4 |
| Typ. switch-off time at U_N | [ms] 14 |
| Transmission frequency f_{limit} | [Hz] 5 |
| Input circuit AC | Yellow LED, Surge protection, RC element |
| Input circuit DC | |
| Output data | |
| Max. switching voltage | 48 V DC |
| Min. switching voltage | 3 V DC |
| Limiting continuous current | 100 mA |
| Max. inrush current | - |
| Output circuit | 3-conductor, ground-referenced |
| Output protection | Protection against polarity reversal, Free running |
| Voltage drop at max. limiting continuous current | ≤ 0.9 V |
| General data | |
| Test voltage input/output | 2.5 kV AC |
| Ambient temperature (operation) | 0°C ... 50°C |
| Standards/regulations | IEC 60664, EN 50178, IEC 62103 |
| Pollution degree/surge voltage category | 2 / III |
| Mounting position/mounting | Any / In rows with zero spacing |
| Connection data solid / stranded / AWG | 0.2 - 4 mm ² / 0.2 - 2.5 mm ² / 24 - 12 |
| Dimensions | 6.2 mm / 80 mm / 56 mm |

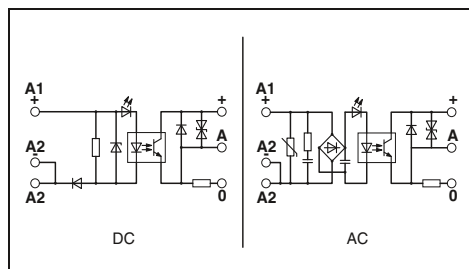

Technical data

| | |
|--|--|
| Input data | ① |
| Permissible range (with reference to U_N) | 0.8 - 1.2 |
| Switching level | 16.8 |
| Typ. input current at U_N | 16 |
| Typ. switch-on time at U_N | 8 |
| Typ. switch-off time at U_N | 0.02 |
| Transmission frequency f_{limit} | 0.2 |
| Input circuit AC | 300 |
| Input circuit DC | Protection against polarity reversal |
| Output data | |
| Max. switching voltage | 48 V DC |
| Min. switching voltage | 12 V DC |
| Limiting continuous current | 2 A (see derating curve) |
| Max. inrush current | 5 A ($t = 1$ s) |
| Output circuit | 3-conductor, ground-referenced |
| Output protection | Protection against polarity reversal, Surge protection |
| Voltage drop at max. limiting continuous current | 1.1 V |
| General data | |
| Test voltage input/output | 3.5 kV AC |
| Ambient temperature (operation) | -10°C ... 55°C |
| Standards/regulations | IEC 60664, EN 50178, IEC 62103 |
| Pollution degree/surge voltage category | 2 / III |
| Mounting position/mounting | - / Mounted in rows with zero spacing; Horizontal/not in rows: Any |
| Connection data solid / stranded / AWG | 0.2 - 4 mm ² / 0.2 - 2.5 mm ² / 24 - 12 |
| Dimensions | 17.5 mm / 75 mm / 102 mm |

Ordering data

| Type | Order No. | Pcs. / Pkt. |
|------------------------------|-----------|-------------|
| DEK-OE-230AC/ 48DC/100/SO 46 | 2964678 | 10 |

Accessories

| | | |
|--|--|--|
| | | |
|--|--|--|

Ordering data

| Type | Order No. | Pcs. / Pkt. |
|--|-----------|-------------|
| EMG 17-OV- 24DC/ 48DC/2 ¹) | 2942810 | 10 |

Accessories

| | | |
|------------|---------|----|
| EMG-GKS 12 | 2947035 | 50 |
|------------|---------|----|

| Description | Input voltage U_N |
|---------------------------------|-------------------------|
| Solid-state power relays | ① 24 V DC ② 230 V AC |

| | |
|-------------------------|--|
| Equipment marker | |
|-------------------------|--|

Relay modules

Special relays and solid-state relays

Relay modules for high inrush currents

The Phoenix Contact relay modules of the type SO 38 have been designed for switching electrical equipment with high inrush currents.

Areas of application are:

- Inductive loads (motors, power contactors, etc.)
- Inductive/capacitive loads (fluorescent lamps, etc.)
- Ohmic loads (glow lamps, heaters).

The module is based on a relay with a special arc-resistant tungsten lead contact. This takes over the high inrush and interrupting current capacitively. The inductive main contact made of AgCdO takes over the continuous current up to 10 A reliably. With the EMG 17-REL...2E/SO38 model, this switching capacity is reached using a power relay with a set of silver tin oxide (AgSnO) contacts.

The module is available in two versions:

- Modular EMG rail-mountable housing with a design width of 17.5 mm
- Convenient ST-REL plug-in housing from the Phoenix ST series for mounting on the URELG or UDK-RELG basic terminal blocks.

Further features are:

- Snap-on mounting on the common EN rails
- Easy maintenance
- Clear labeling of the terminal blocks using Phoenix Contact marking material.

| Notes: |
|---|
| Type of housing: Polycarbonate fiber reinforced PC-F, color: green or black. |
| Marking systems and mounting material See Catalog 5 |



medium to large loads
1 N/O contact (1)



Technical data

| | |
|--|---|
| Input data | ① |
| Permissible range (with reference to U_N) | 0.85 - 1.1 |
| Typ. input current at U_N | 28 [mA] |
| Response/release time at U_N | 13 / 15 [ms] |
| Input protection: | Yellow LED, freewheeling diode |
| Output data | |
| Contact type | 1 N/O contact with lead contact |
| Contact material | AgCdO |
| Max. switching voltage | 250 V AC |
| Limiting continuous current | 10 A |
| Max. inrush current | 80 A (20 ms) |
| Max. interrupting rating, ohmic load | |
| | 24 V DC - |
| | 48 V DC - |
| | 60 V DC - |
| | 110 V DC - |
| | 220 V DC - |
| | 250 V AC 2500 VA |
| General data | |
| Test voltage (winding / contact) | 2.5 kV AC (50 Hz, 1 min.) |
| Ambient temperature (operation) | -20°C ... 50°C |
| Mechanical service life | Approx. 10 ⁷ cycles |
| Standards/regulations | IEC 60664, EN 50178, IEC 62103 |
| Mounting position/mounting | - / Horizontal with zero spacing, vertical with spacing |
| Connection data solid / stranded / AWG | - / - / - |
| Dimensions | W / H / D 20.8 mm / 42.5 mm / 112 mm |

Ordering data

| Description | Input voltage U_N | Type | Order No. | Pcs. / Pkt. |
|--|---------------------|-----------------------|-----------|-------------|
| Relay module with power contact relay + wolfram lead contact | | | | |
| | ① 24 V DC | | | |
| Relay module with power contact relay, with two inputs for manual, automatic | | | | |
| | ① 24 V DC | ST-REL3-KG 24/ 1/SO38 | 2829564 | 10 |

Accessories

| | | | |
|---|---------|---------|----|
| Basic terminal block, complete with end cover | URELG 3 | 2820136 | 10 |
| Equipment marker | | | |



medium to large loads
1 N/O contact (1)



medium to large loads
1 N/O contact (1)

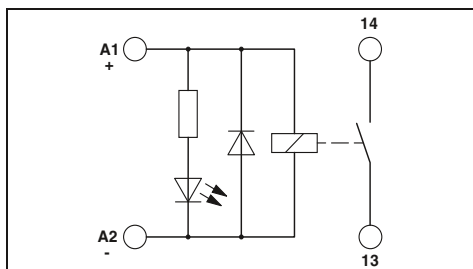

Technical data

①
0.85 -
1.1
28
13 /
15
Yellow LED, freewheeling diode

1 N/O contact with lead contact
AgCdO
250 V AC
10 A
80 A (20 ms)

-
-
-
-
-
2500 VA

4 kV AC (50 Hz, 1 min.)
-20°C ... 50°C
Approx. 10⁷ cycles
IEC 60664, EN 50178, IEC 62103
Any

0.2 - 4 mm² / 0.2 - 2.5 mm² / 24 - 12
17.5 mm / 75 mm / 62.5 mm

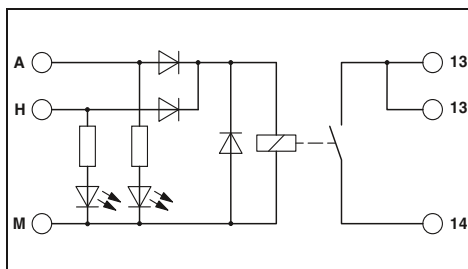

Technical data

①
0.9 -
1.1
23
9 / 10
Automatic: Yellow LED, Manual: Red LED, freewheeling diode, Protection against polarity reversal

Single contact, 1 N/O contact
AgSnO
250 V AC/DC
10 A
120 A (20 ms)

240 W
120 W
85 W
70 W
90 W
2500 VA

4 kV AC (50 Hz, 1 min.)
-20°C ... 50°C
3 x 10⁷ cycles
IEC 60664, EN 50178, IEC 62103
Any

0.2 - 4 mm² / 0.2 - 2.5 mm² / 24 - 12
17.5 mm / 75 mm / 62.5 mm

Ordering data

| Type | Order No. | Pcs. / Pkt. |
|-----------------------------|-----------|-------------|
| EMG 17-REL/KSR-G 24/SO38 BK | 2949994 | 10 |

Accessories

| | | |
|------------|---------|----|
| EMG-GKS 12 | 2947035 | 50 |
|------------|---------|----|

Ordering data

| Type | Order No. | Pcs. / Pkt. |
|-----------------------------|-----------|-------------|
| EMG 17-REL/KSR-G 24/2E/SO38 | 2941646 | 10 |

Accessories

| | | |
|------------|---------|----|
| EMG-GKS 12 | 2947035 | 50 |
|------------|---------|----|

Relay modules

Special relays and solid-state relays

ST-OV 3 plug-in solid-state power relays

The plug-in version of the module provides all the advantages of the ST series, such as:

- Switching of up to 400 V AC/3 A
- Control of 230 V motors in straightforward reversing mode (e.g., synchronous motor in single-phase operation, see illustration)
- Plug-in

| Notes: | |
|--|--|
| Type of insulating housing: polyamide PA non-reinforced, color: bottom part gray, hood green | |
| Ground (minus) potential from the input and output of the optocoupler should not be connected. | |
| AC loads must be protected with a varistor or an RC element. | |



with AC voltage output
max. = 3 A



Technical data

| | | |
|---|----------------|--|
| Input data | | ① |
| Switching level with reference to U_N | 1 signal ("H") | ≥ 0.8 |
| | 0 signal ("L") | ≤ 0.4 |
| Typ. input current at U_N | | [mA] 7 |
| Transmission frequency f_{limit} | | [Hz] 10 |
| Input protection: | | Yellow LED, Protection against polarity reversal, RC element |
| Output data | | |
| Operating voltage | | 400 V AC |
| Operating voltage range | | 24 V AC ... 420 V AC |
| Periodic peak reverse voltage | | 800 V |
| Limiting continuous current | | 3 A (see derating curve) |
| Min. load current | | 50 mA |
| Surge current | | 125 A ($t = 10$ ms) |
| Residual voltage drop at "H" | | ≤ 1.2 V |
| Leakage current in off state | | Approx. 12 mA |
| Output protection | | Surge protection, RC element |
| General data | | |
| Test voltage input/output | | 2.5 kV AC |
| Ambient temperature (operation) | | 0°C ... 60°C |
| Standards/regulations | | IEC 60664, EN 50178, IEC 62103 |
| Pollution degree/surge voltage category | | 2 / III |
| Mounting position/mounting | | Horizontal DIN rail / - |
| Dimensions | W / H / D | 20.8 mm / 42.5 mm / 112 mm |

Ordering data

| Description | Input voltage U_N | Type | Order No. | Pcs. / Pkt. |
|---------------------------------|---------------------|----------------------|-----------|-------------|
| Solid-state power relays | ① 24 V DC | ST-OV3- 24DC/400AC/3 | 2905417 | 10 |

Accessories

| | | | |
|--|---------|---------|----|
| Basic terminal block, complete with end cover | URELG 3 | 2820136 | 10 |
|--|---------|---------|----|

Derating curve for ST-OV 3-24DC/400AC/3



- ① Aligned without spacing
- ② Aligned with ≥ 20 mm spacing

ST-OV 4-24DC/24DC/...-PRO power protection circuit solid-state relay with signal logic

The ST-OV 4-...PRO provides protection and monitoring functions that are otherwise only known from thermomagnetic protection elements.

The PROtect modules have the following features:

- Fast disconnection with short-circuits and simultaneous current limitation
- Time-dependent overload shutdown for reliable protection against continuous overloads
- Brief inrush peaks are ignored
- After an overload or short-circuit has been triggered, a defined reset of the control voltage must be carried out
- Reliable recognition and indication of a line break on the load side
- Feedback in the event of an error

| | |
|---|--|
| Notes: | |
| Type of housing: | Polyamide PA non-reinforced, color: bottom part gray, hood green |
| Marking systems and mounting material | See Catalog 5 |
| For load current diagram, see page 347 | |
| Derating curve, time/current characteristic curves, and state diagram, see page 347 | |



with short-circuit-proof DC voltage output
max. = 1 A or 4 A

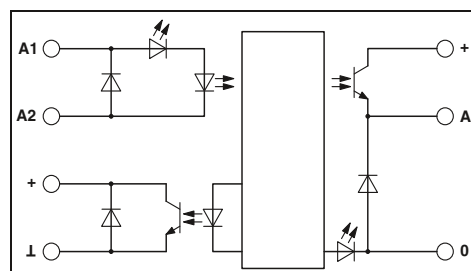

Technical data

| Input data | ST-OV4- 24DC/ 24DC/1-PRO | ST-OV4- 24DC/ 24DC/4-PRO |
|---|---|--------------------------|
| Operating voltage | 24 V DC ±50% | |
| Switching level | 8.5 V DC | |
| | 5 V DC | |
| Typ. input current at U _N | 6.5 mA | |
| Transmission frequency f _{limit} | 100 Hz | |
| Reset period after short-circuit / overload shut down | 1 ms | |
| Input circuit | Yellow LED, Polarity protection diode | |
| Output data signaling contact / CONTROL | | |
| Operating voltage range | 5 V DC ... 36 V DC | |
| Limiting continuous current | 50 mA | |
| Residual voltage drop at "H" | ≤ 1.5 V | |
| Output protection | Polarity protection diode | |
| Output circuit | 3-conductor, ground-referenced | |
| Output data load contact | | |
| Operating voltage range | 18 V DC ... 36 V DC | |
| Limiting continuous current | 1 A (see derating curve) | 4 A (see derating curve) |
| Min. load current | 1 mA | |
| Residual voltage drop at "H" | 300 mV | 200 mV |
| Open circuit alarm with load current | < 100 µA | |
| Overload disconnection (~ 1.4 x continuous current) | ≤ 100 ms (See the time-current characteristic curve) | |
| Short-circuit disconnection | < 200 µs (See the time-current characteristic curve) | |
| Current limitation at short-circuits | Approx. 25 A | Approx. 70 A |
| Switching time t _{in} / t _{out} | 300 µs / 700 µs | |
| Output protection | Red LED, Damping diode | |
| Output circuit | 3-conductor, ground-referenced | |
| General data | | |
| Test voltage input/output | 2.5 kV AC | |
| Test voltage output/output | 2.5 kV AC | |
| Rated surge voltage | Basic insulation | |
| Ambient temperature (operation) | 0°C ... 60°C | |
| Standards/regulations | IEC 60664 / EN 50178 / IEC 62103 | |
| Screw connection solid / stranded / AWG | 0.2 - 4 mm ² / 0.2 - 4 mm ² / 24 - 12 | |
| Dimensions | W / H / D 27 mm / 63.5 mm / 114 mm | |

Ordering data

| Description | Output current | Type | Order No. | Pcs. / Pkt. |
|---|----------------|--------------------------|-----------|-------------|
| Power circuit breaker solid-state relay, with signal logic | 1 A | ST-OV4- 24DC/ 24DC/1-PRO | 2905572 | 10 |
| | 4 A | ST-OV4- 24DC/ 24DC/4-PRO | 2905585 | 10 |

Accessories

| | | | |
|--|------------|---------|----|
| Basic terminal block, complete with end cover | UDK-RELG 4 | 2777056 | 10 |
|--|------------|---------|----|

Relay modules

Special relays and solid-state relays

DEK-OE 100 kHz input solid-state relay

A solid-state relay for the reliable detection of short pulses

- Limit frequency of up to 100 kHz
- Push-pull stage on output side
- Includes signal inputs on PLC counter boards
- Features a capacitor on the input side for interference suppression

| Notes: |
|--|
| Type of housing: Polyamide PA non-reinforced, color: green. |
| Marking systems and mounting material See Catalog 5 |
| 1) EMC: Class A product, see page 571 |

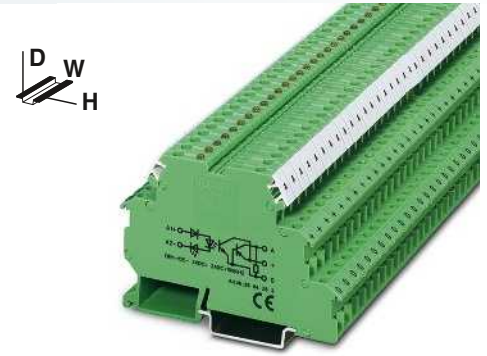

with DC voltage output
Transmission frequency 100 kHz

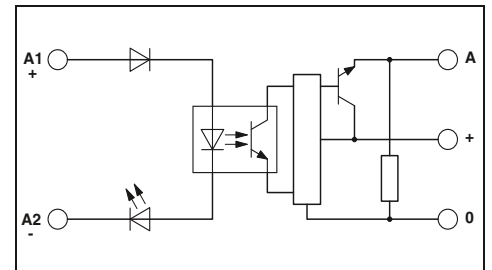

Technical data

| Input data | | ① | ② |
|--|----------------|--|------------|
| Permissible range (with reference to U_N) | | 0.8 - 1.2 | 0.8 - 1.2 |
| Switching level with reference to U_N | 1 signal ("H") | ≥ 0.8 | ≥ 0.8 |
| | 0 signal ("L") | ≤ 0.4 | ≤ 0.4 |
| Typ. input current at U_N | [mA] | 7 | 6 |
| Typ. switch-on time at U_N | [μ s] | 1.5 | 1.5 |
| Typ. switch-off time at U_N | [μ s] | 2 | 2 |
| Transmission frequency f_{limit} | [kHz] | 100 | 100 |
| Input protection: | | Yellow LED, Protection against polarity reversal, Surge protection | |
| Output data | | 4 V DC ... 30 V DC | |
| Operating voltage range | | 50 mA | |
| Limiting continuous current | | 4.3 mA | |
| Quiescent current | | ≤ 0.5 V DC | |
| Residual voltage drop at "H" | | 3-conductor, ground-referenced | |
| Output circuit | | Surge protection | |
| Output protection | | 2.5 kV AC | |
| General data | | -20°C ... 60°C | |
| Test voltage input/output | | IEC 60664, EN 50178, IEC 62103 | |
| Ambient temperature (operation) | | 2 / II | |
| Standards/regulations | | 0.2 - 4 mm ² / 0.2 - 2.5 mm ² / 24 - 12 | |
| Pollution degree/surge voltage category | | 6.2 mm / 80 mm / 56 mm | |
| Connection data solid / stranded / AWG | | W / H / D | |
| Dimensions | | | |

Ordering data

| Description | Input voltage U_N | Type | Order No. | Pcs. / Pkt. |
|---------------------------------|---------------------|---|-----------|-------------|
| Solid-state input relays | ① 5 V DC | DEK-OE- 5DC/ 24DC/100KHZ ¹⁾ | 2964270 | 10 |
| | ② 24 V DC | DEK-OE- 24DC/ 24DC/100KHZ ¹⁾ | 2964283 | 10 |



with DC voltage output push-pull
Transmission frequency 100 kHz



with DC voltage output push-pull
Transmission frequency 100 kHz

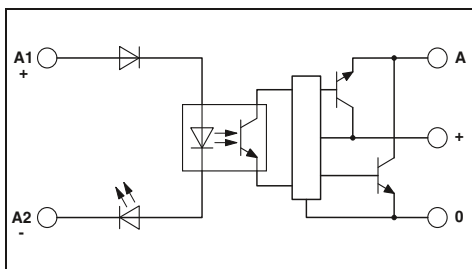

Technical data

| ① | ② |
|-----------|-----------|
| 0.5 - 1.2 | 0.8 - 1.2 |
| ≥ 0.5 | ≥ 0.8 |
| ≤ 0.3 | ≤ 0.4 |
| 8 | 8 |
| 1 | 1 |
| 2 | 2 |
| 100 | 100 |

Yellow LED, Protection against polarity reversal, Surge protection

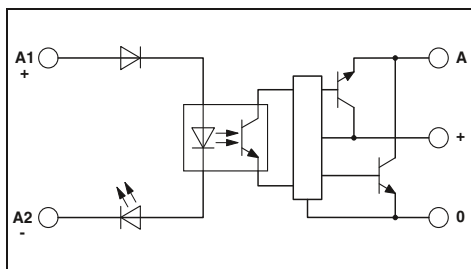

Technical data

| ① | ② |
|-----------|-----------|
| 0.5 - 1.2 | 0.8 - 1.2 |
| ≥ 0.5 | ≥ 0.8 |
| ≤ 0.3 | ≤ 0.4 |
| 8 | 8 |
| 1 | 1 |
| 2 | 2 |
| 100 | 100 |

Yellow LED, Protection against polarity reversal, Surge protection

4 V DC ... 18 V DC
50 mA
8.5 mA
≤ 1.2 V DC
3-conductor push-pull, ground referenced
Surge protection

14 V DC ... 30 V DC
50 mA
15 mA
≤ 2.2 V DC
3-conductor push-pull, ground referenced
Surge protection

2.5 kV AC
-20°C ... 60°C
IEC 60664, EN 50178, IEC 62103
2 / II
0.2 - 4 mm² / 0.2 - 2.5 mm² / 24 - 12
6.2 mm / 80 mm / 56 mm

2.5 kV AC
-20°C ... 60°C
IEC 60664, EN 50178, IEC 62103
2 / II
0.2 - 4 mm² / 0.2 - 2.5 mm² / 24 - 12
6.2 mm / 80 mm / 56 mm

Ordering data

| Type | Order No. | Pcs. / Pkt. |
|---|-----------|-------------|
| DEK-OE- 5DC/ 5DC/100KHZ-G ¹) | 2964542 | 10 |
| DEK-OE- 24DC/ 5DC/100KHZ-G ¹) | 2964364 | 10 |

Ordering data

| Type | Order No. | Pcs. / Pkt. |
|--|-----------|-------------|
| DEK-OE- 5DC/ 24DC/100KHZ-G ¹) | 2964555 | 10 |
| DEK-OE- 24DC/ 24DC/100KHZ-G ¹) | 2964348 | 10 |

Relay modules

Special relays and solid-state relays

Electronic sensor terminal block for NAMUR proximity sensors

- The EIK 1-SVN 24-P electronic sensor terminal block from Phoenix Contact converts the changeable resistance of a NAMUR sensor unit into a digital signal that can be read by all PLCs.
- Monitoring of initiator side for short circuits or strand breaks
 - Suitable resistance circuit to enable monitoring of mechanical switches (see application 2)
 - LED error display
 - Status display (high signal) via green LED
 - 24 V/50 mA digital output
 - Bridging and marking with standard terminal accessories.

| |
|--|
| Notes: |
| Type of housing: Polyamide PA non-reinforced, color: green. |
| Marking systems and mounting material See Catalog 5 |
| 1) EMC: Class A product, see page 571 |



For inductive proximity sensors according to NAMUR

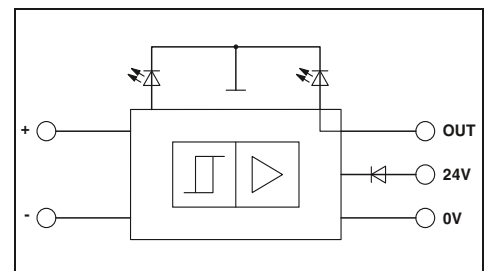

Derating curve for EIK 1-SVN 24 P

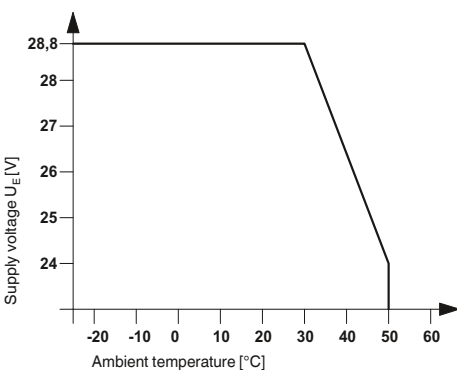

| | |
|-----------------------------|---|
| Supply | Input supply nominal voltage U _{VN} |
| Ripple | Current consumption I _{Imax} Input circuit |
| Control circuit | Non-load voltage Switching points in accordance with EN 60947-5-6: |
| Switching hysteresis | |
| Internal resistance | |
| Output protection | |
| Signal output | Max. output current I _{Omax} Residual voltage U _R with I _{Omax} Output voltage U _O |
| Output protection | |
| General data | Ambient temperature (operation) Transmission frequency (INPUT/OUTPUT) Input pulse length Input pause length Standards/regulations Pollution degree / Surge voltage category Screw connection solid / stranded / AWG Dimensions |

| | |
|-----------------------|--|
| Technical data | 18.5 V DC ... 28.8 V DC (U _{VN} , see derating curve) |
| | according to DIN 19240 70 mA (at 50 mA output current) Green LED, Polarity protection diode |
| | 8.2 V DC ±10% ≥ 2.1 mA (In conductive state) ≤ 1.2 mA (In blocking state) 6.3 mA ... 10 mA (in the event of a short-circuit) 0 mA ... 0.35 mA (In the event of a wire break) Approx. 0.2 mA Approx. 1 kΩ visual short-circuit and wire break control with LED (red), 12 V Zener diode |
| | 50 mA ≤ 1.5 V (U _R) ≤ 100 mV (In conductive state) (U _{VN} - U _R) in blocking state 36 V Zener diode as freewheeling diode |
| | -25°C ... 50°C 1 kHz ≥ 0.5 ms ≥ 0.5 ms IEC 60664, EN 61000-6-2, EN 61000-6-4 2 / III 0.2 - 4 mm ² / 0.2 - 2.5 mm ² / 24 - 12 6.2 mm / 80 mm / 56 mm |

Application 1

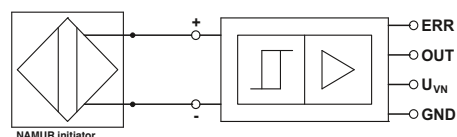

Application 2

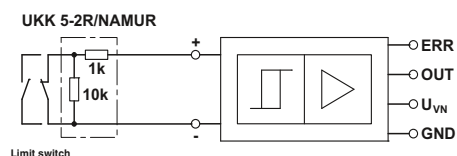

| | |
|---|--|
| Description | Switching amplifier electronic terminal block , for inductive proximity initiators as per NAMUR, with light indicators for sensor signal and faults |
| Terminal block , with three through contacts, for mounting on NS 35... | |
| Double-level terminal block , with pre-assembled resistors | |
| Insertion bridge | |

| Ordering data | | |
|----------------------------|-----------|-------------|
| Type | Order No. | Pcs. / Pkt. |
| EIK1-SVN-24P ¹⁾ | 2940799 | 10 |

| Accessories | | |
|-----------------------------|---------|----|
| DIKD 1,5 | 2715979 | 50 |
| UKK 5-2R/NAMUR | 2941662 | 50 |
| EB...DIK... | | |
| Ordering data at DEK-REL... | | |

DEK-TR/INV inverter module

| Notes: |
|--|
| Type of housing: Polyamide PA non-reinforced, color: green. |
| Marking systems and mounting material See Catalog 5 |

The Phoenix Contact DEK-TR/INV inverter module inverts the signals of ground switching NPN transistor outputs into positive switching PNP outputs, and vice versa (see application example).

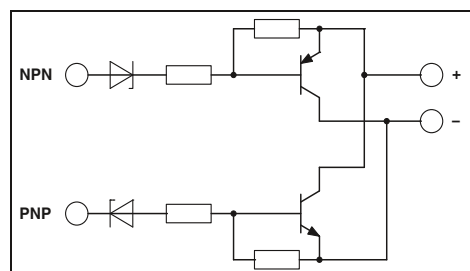
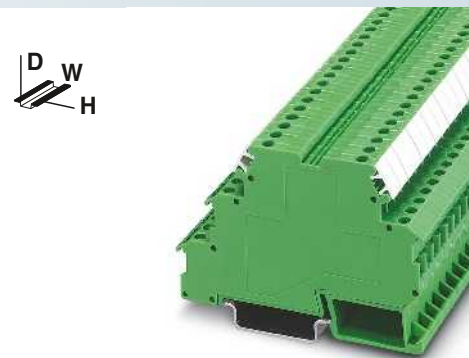

Technical data

| | |
|---|---|
| Supply voltage | 20 V DC ... 30 V DC (U_V) |
| Continuous current | 200 mA |
| Residual voltage drop | < 1 V |
| Leakage current | < 1 mA |
| Max. transmission frequency | 15 kHz |
| NPN input/PNP output | |
| Switch-on threshold | < 5 V (at $U_V = 24$ V; < ($U_V - 19$ V)) |
| Switch-off threshold | > 15 V (at $U_V = 24$ V; > ($U_V - 9$ V)) |
| Min. limit values | -2 V |
| Max. limit values | 26 V (at $U_V = 24$ V; $U_V + 2$ V) |
| Control circuit | |
| Switch-on threshold | > 19 V |
| Switch-off threshold | < 9 V |
| Min. limit values | -2 V |
| Max. limit values | 26 V (at $U_V = 24$ V; $U_V + 2$ V) |
| General data | |
| Ambient temperature (operation) | -20°C ... 50°C |
| Standards/regulations | IEC 60664 |
| | Basic insulation |
| | 2 / II |
| Pollution degree / Surge voltage category | 0.2 - 4 mm ² / 0.2 - 2.5 mm ² / 24 - 12 |
| Screw connection solid / stranded / AWG | |
| Dimensions | 6.2 mm / 80 mm / 56 mm |

Ordering data

| Description | Type | Order No. | Pcs. / Pkt. |
|-----------------|------------|-----------|-------------|
| Inverter module | DEK-TR/INV | 2964319 | 10 |

Connection examples:

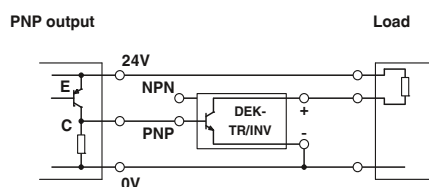
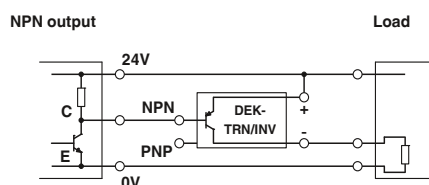

Relay modules

Special relays and solid-state relays

Hybrid relay modules

With its integrated transistor level, the hybrid relay module is able to amplify weak input signals. This serves as the basis for reliable relay operation.

The advantages:

- Low control current (terminal B), type-dependent as of 0.5 mA
- Type-dependent positive or negative control current
- Integrated input and interference suppression circuit
- Safe isolation according to DIN EN 50178 between coil and contact

| Notes: |
|--|
| Type of housing: Polycarbonate fiber reinforced PC-F, color: green. |
| Marking systems and mounting material See Catalog 5 |
| For the protection of relay coils and contacts, inductive loads must be dampened with an efficient protection circuit. |
| 1) EMC: Class A product, see page 571 |

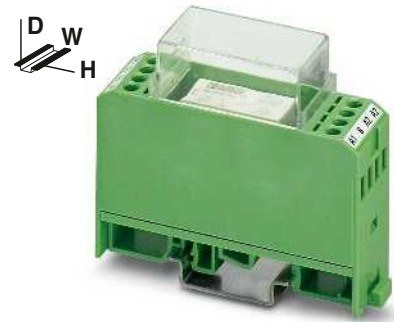

Positive switching hybrid relay

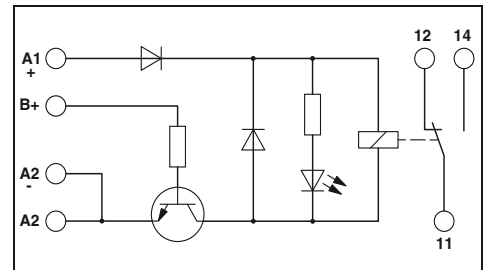

Technical data

| Input data | ① | ② | ③ |
|---|--|---------|--------|
| Relay supply voltage $U_N \pm 10\%$ | [V DC] 24 | 24 | 24 |
| Min. control voltage | [V DC] 2.7 | 5 | 15 |
| Max. control voltage | [V DC] 5.25 | 13.2 | 35 |
| Min. control current | [mA] 2.6 | 0.5 | 0.5 |
| Max. control current | [mA] 7.7 | 1 | 1 |
| Typ. input current at U_N | [mA] 21 | 21 | 21 |
| Response/release time at U_N | [ms] 9 / 10 | 9 / 10 | 9 / 10 |
| Input protection: | Yellow LED, Protection against polarity reversal, freewheeling diode | | |
| Output data | | | |
| Contact type | Single contact, 1-PDT | | |
| Contact material | AgNi | | |
| Max. switching voltage | 250 V AC/DC | | |
| Limiting continuous current | 5 A | | |
| Max. inrush current | 8 A | | |
| Max. interrupting rating, ohmic load | 24 V DC | 120 W | |
| | 48 V DC | 60 W | |
| | 60 V DC | 50 W | |
| | 110 V DC | 50 W | |
| | 220 V DC | 80 W | |
| | 250 V AC | 1250 VA | |
| General data | | | |
| Test voltage (winding / contact) | 4 kV AC (50 Hz, 1 min.) | | |
| Ambient temperature (operation) | -20°C ... 50°C | | |
| Mechanical service life | Approx. 5×10^7 cycles | | |
| Standards/regulations | IEC 60664, EN 50178, IEC 62103 | | |
| Pollution degree/surge voltage category | 2 / III | | |
| Connection data solid / stranded / AWG | 0.2 - 4 mm ² / 0.2 - 2.5 mm ² / 24 - 12 | | |
| Dimensions | W / H / D 22.5 mm / 75 mm / 62.5 mm | | |

Ordering data

| Description | Nominal control voltage | Type | Order No. | Pcs. / Pkt. |
|---|-------------------------|---|--|----------------|
| Relay module with miniature power contact relay with integrated NPN transistor control, for low control currents | ① 5 V DC | EMG 22-REL/KSR-G 24/TRN 5¹⁾ EMG 22-REL/KSR-G 24/TRN 12¹⁾ EMG 22-REL/KSR-G 24/TRN 35¹⁾ | 2949787 2952363 2952350 | 10 10 10 |
| | ② 12 V DC | | | |
| | ③ 24 V DC | | | |
| Relay module with miniature power contact relay with integrated PNP transistor control, for low control currents | ① 5 V DC | | | |
| | ② 12 V DC | | | |
| | ③ 24 V DC | | | |

Accessories

| Equipment marker | EMG-GKS 12 | 2947035 | 50 |
|------------------|------------|---------|----|
|------------------|------------|---------|----|



Negative switching hybrid relay

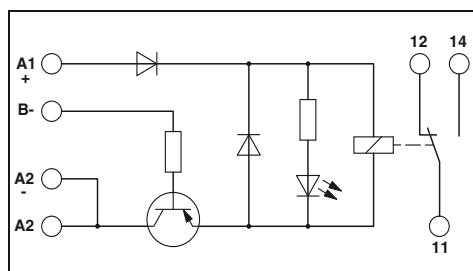

Technical data

| ① | ② | ③ |
|--------|--------|--------|
| 24 | 24 | 24 |
| -2.4 | -6.9 | -17.5 |
| -5.25 | -13.2 | -38.5 |
| 1.2 | 0.6 | 0.6 |
| 1.7 | 1 | 1.4 |
| 21 | 21 | 21 |
| 9 / 10 | 9 / 10 | 9 / 10 |

Yellow LED, Protection against polarity reversal, freewheeling diode

Single contact, 1-PDT

AgNi
250 V AC/DC
5 A
8 A

120 W
60 W
50 W
50 W
80 W
1250 VA

4 kV AC (50 Hz, 1 min.)
-20°C ... 50°C
Approx. 5 x 10⁷ cycles
IEC 60664, EN 50178, IEC 62103
2 / III
0.2 - 4 mm² / 0.2 - 2.5 mm² / 24 - 12
22.5 mm / 75 mm / 62.5 mm

Ordering data

| Type | Order No. | Pcs. / Pkt. |
|---|-----------|-------------|
| EMG 22-REL/KSR-G 24/TRP 5 ¹⁾ | 2949790 | 10 |
| EMG 22-REL/KSR-G 24/TRP12 ¹⁾ | 2952156 | 10 |
| EMG 22-REL/KSR-G 24/TRP35 ¹⁾ | 2952169 | 10 |

Accessories

| | | |
|------------|---------|----|
| EMG-GKS 12 | 2947035 | 50 |
|------------|---------|----|



System cabling for controllers

Wiring I/O modules with individual wires is an extremely time-consuming process. Wiring errors and tedious troubleshooting cannot be ruled out.

Interface cabling reduces assembly costs by using plug-in components to carry out wiring quickly, clearly, and without errors.

The new interface modules in the VIP - VARIOFACE Professional series, which feature a modern housing design, offer the following advantages:

- Space-saving
- Vibration resistant up to 5g thanks to metal feet
- Reliable connection technology, either with screw or push-in connections
- Wide range of marking options

VIP modules are available for both product segments:

VARIOFACE system cabling is a cabling concept that has been specially developed to allow connection to the I/O modules of a wide range of automation devices.

The VIP series is rounded off by new front adapters with encapsulated system cables for the SIMATIC S7 300.

VARIOFACE wiring interfaces are suitable for universal use. Various VIP - VARIOFACE Professional modules with a 1:1 connection from a high-position plug-in connector to a different connection technology are available. The encapsulated system cables provide an effective and efficient means of establishing a connection to a control device with protection against polarity reversal.

A variety of potential distributors are available for splitting the control and operating voltage.

Product range overview

| | |
|---|------------|
| Introduction to VARIOFACE system cabling | 418 |
| <hr/> | |
| Overview of VARIOFACE system cabling | 420 |
| <hr/> | |
| Front adapter | |
| For ABB S800 I/O | 422 |
| For Allen-Bradley, ControlLogix, PLC 5, SLC 500, and PlantScape | 424 |
| For Emerson DeltaV | 432 |
| For GE Fanuc RX3i and Series 90-30 | 436 |
| For Honeywell C300 Series CI/O and PlantScape | 438 |
| For Mitsubishi A1S and Q, Melsec L, Honeywell ML 200 | 440 |
| For Omron CJ1, CS1, and C200H | 442 |
| For Phoenix Contact Axioline and Inline | 443 |
| For Schneider Electric MODICON® | 445 |
| For Siemens SIMATIC® S7-300 | 450 |
| For Siemens SIMATIC® S7-1500 | 456 |
| For Siemens SIMATIC® S7-400 | 458 |
| For Siemens SIMATIC® S5-S7 conversion | 459 |
| For Yokogawa CS3000 R3 | 466 |
| <hr/> | |
| Termination boards | |
| With passive transfer | 470 |
| With relay | 490 |
| <hr/> | |
| PLC-INTERFACE via V8 adapter | |
| V8 adapter | 484 |
| Feed-through terminal blocks | 486 |
| Relays/solid-state relays | 320 |
| Cross-reference list | 488 |
| <hr/> | |
| System cables | |
| With flat-ribbon cable and D-SUB plug-in connectors | 500 |
| <hr/> | |
| Introduction to VARIOFACE wiring interface | 520 |
| <hr/> | |
| Overview of VIP - VARIOFACE Professional | 522 |
| <hr/> | |
| Passive universal interface modules | |
| VIP modules with flat-ribbon cable plug-in connectors | 524 |
| VIP modules with D-SUB plug-in connectors | 532 |
| VIP modules with high-density D-SUB plug-in connectors | 539 |
| With DIN strips | 540 |
| With ELCO plug-in connectors | 542 |
| With RJ45 plug-in connectors | 546 |
| With COMBICON connection | 547 |
| VIP potential distributors | 548 |
| <hr/> | |
| Active interface modules | |
| For relay couplers/optocouplers | 550 |
| For solid-state relays | 553 |
| Accessories (relays, optocouplers) | 554 |



A large part of the costs incurred in automation systems today results from the cabling for the actuators and signaling units. On top of this, machines and systems are becoming more and more complex, which means that the cabling costs for the input and output stations are also steadily on the increase. In addition to cabling material costs, the costs associated with planning, assembly, startup, and documentation must also be considered.

VARIOFACE system cabling is a system concept that reduces manufacturing costs through fast, error-free, and uniform wiring of the input and output signals of a PLC.

The system design comprises three components:

- VARIOFACE front adapters
- VARIOFACE system cables
- VARIOFACE termination board

VARIOFACE system cabling is available for controllers from:

- **ABB**
- **Allen-Bradley**
- **Emerson**
- **Honeywell**
- **GE Fanuc**
- **Mitsubishi Electric**
- **OMRON**
- **Schneider Electric**
- **Siemens**
- **Yokogawa**
- **Phoenix Contact**

VIP - VARIOFACE Professional

The new front adapters with encapsulated system cables for the S7 300 and new compact termination boards make the system cabling even more robust. VARIOFACE Professional means:

- New front adapters
- **Optimized housing concept**
- **Power supplied via PCB terminal blocks**
- **Plug-in bridges for electrical isolation**
- **Directly connected system cables with encapsulated plugs**
- New termination boards
- **Space saving**
- **Vibration resistant up to 5g**
- **Optional marking**
- **New housing design**

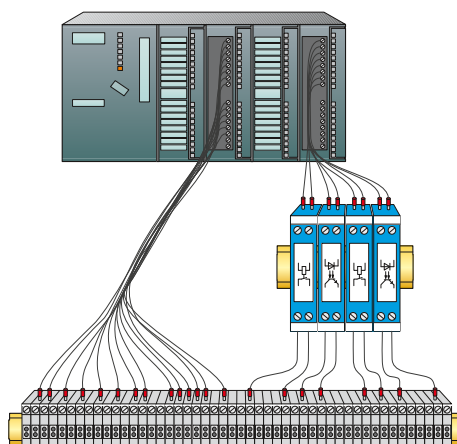

The conventional wiring of input and output cards of programmable logic controls requires a lot of time.

Signals are transferred from the control system to modular terminal blocks or coupling modules such as relays or optocouplers by means of single conductor wiring.

This requires a complex wiring process. At the same time, errors in wiring are always possible with this connection method. Wiring errors are often only noticed when the system is put into operation and they then cause additional costs.

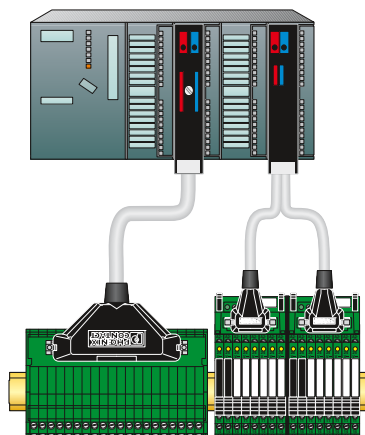

Wiring with the system cabling considerably reduces the assembly time and guarantees protection against polarity reversal.

Front adapters with an integrated pin strip (IEC 60603-13) are plugged onto the PLC I/O cards. They replace connection technologies such as those involving a screw or crimp connection.

The controller boards are simply snapped onto the DIN rail instead of modular terminal blocks or coupling modules. On the control side they also have a multi-position pin strip.

The controller boards are connected to the front adapters using multi-position and pre-assembled system cables.

Actuators and sensors from the field level are connected to the termination boards by means of screw or spring-cage connections or knife disconnect terminal blocks. The termination boards are marked on the field side according to the application, so that the signals can be clearly assigned.



The configuration cross-reference list (a quick reference guide to the VARIOFACE system components) is extremely useful when selecting the required components. What's more, matching components can be configured using the INTERFACE search assistant.

See www.phoenixcontact.net/products.

Rationalize your application with the aid of VARIOFACE system cabling:

- **Easy planning with configuration cross-reference list or online selector**
- **Cost reductions thanks to time-saving wiring**
- **Fault minimization through protection against polarity reversal**
- **Easy maintenance thanks to modular system components**

System cabling for controllers

VARIOFACE system cabling

Product overview of VARIOFACE system cabling

| System component | | Controller | | | | | | | | | |
|--------------------|---|------------------|---------------|---------|------|-------------------|----------|--------------------------------|------------|------|--|
| | | ABB S800 I/O | Allen-Bradley | | | Emerson DeltaV | GE FANUC | | Honeywell | | |
| Version | | Control Logix | PLC 5 | SLC 500 | | RX3i | 90-30 | C300 CI/O, ML 200 series | PlantScape | | |
| | | Page | Page | Page | Page | Page | Page | Page | Page | Page | |
| Front adapters |  | Not required | 424 | 426 | 428 | Not required | 436 | 437 | 438 | 424 | |
| System cables |  Standard | 512 | 504 | 504 | 504 | 506 | 504 | 504 | 512 | 504 | |
| | Controller-specific | 423 | | | 430 | 432 | | | 441 | | |
| Termination boards |  Passive Standard | 470 | 470 | 470 | 470 | 470 | 470 | 470 | 439 | 470 | |
| | Passive Controller-specific | 422 | 473 | | 429 | 433 | | | | | |
| |  Active Standard | 490 | 490 | 490 | 490 | 490 | 490 | 490 | 490 | 490 | |
| |  V8 adapter/ feed-through terminal block | 484 | 484 | 484 | 484 | 484 | 484 | 484 | 484 | 484 | |
| | Relay/ optocoupler | 320 | 320 | 320 | 320 | 320 | 320 | 320 | 320 | 320 | |
| |  MINI Analog system adapter | | | | | | | | | | |
| MINI Analog | | | | | | | | | | | |

| | Mitsubishi | OMRON CJ1 | Phoenix Contact | Schneider | | Siemens | | | | Yokogawa |
|--|---------------------|------------------|-----------------|------------|------|---------|--------------|--------|---------------------|---------------|
| | MELSEC A, A1S, Q, L | CS1, CQM1, C200H | Axioline Inline | TSX Qantum | M340 | S7 300 | S7 1500 | S7 400 | S5 to S7 conversion | Centum CS3000 |
| | Page | Page | Page | Page | Page | Page | Page | Page | Page | Page |
| | Not required | Not required | 444 | 445 | 446 | 448 | Not required | 458 | 459 | Not required |
| | | | 504 | 504 | 504 | 504 | | 504 | | |
| | 440 | 442 | | | 447 | 453 | 456 | | | 466 |
| | 470 | 470 | 470 | 470 | 470 | 470 | 470 | 470 | | |
| | | | | 473 | | 472 | | 472 | | 468 |
| | 490 | 490 | 490 | 490 | 490 | 490 | 490 | 490 | | |
| | 484 | 484 | 484 | 484 | 484 | 484 | 484 | 484 | | 484 |
| | 320 | 320 | 320 | 320 | 320 | 320 | 320 | 320 | | 320 |
| | | | | | | 94 | | | | 94 |
| | | | | | | 92 | | | | 92 |

System cabling for controllers

VARIOFACE system cabling

ABB S800 I/O Termination boards with knife disconnection

The ABB S800 I/O system offers the possibility of realizing the process wiring with D-SUB plug-in connectors. ABB TU 812 Compact MTU are available for this purpose.

The FLKM-D25SUB/B/KDS3-MT/... modules are connected to the I/O modules using assembled D-SUB cables (refer to "System cables" chapter).

In addition to screw connection with knife disconnection for every channel and ABB S800-specific labeling, the modules have the following features:

- Eight negative terminals with knife disconnection (TU810)
- Eight positive terminals with knife disconnection (TU810/P)
- For each channel, there is a positive and negative terminal with knife disconnection (TU830)

Passive interface modules can also be used for signal transmission (e.g., VIP-3/SC/D25SUB/F, 2315188), see page 533.



Interface module with knife disconnect terminal blocks

Technical data

| | |
|--|---|
| Max. perm. operating voltage | 50 V AC/DC |
| Max. perm. current (per branch) | 2 A |
| Max total current (voltage supply) | 4 A (8 A L1-/L2-) |
| Rated surge voltage | 1.4 kV |
| Ambient temperature (operation) | -20°C ... 50°C |
| Mounting position | Any |
| Standards/regulations | DIN EN 50178, IEC 62103 |
| Connection method | Field level Screw connection with disconnect knife Control system level |
| Connection data solid / stranded / AWG | 0.2 ... 4 mm ² / 0.2 ... 2.5 mm ² / 24 - 12 |
| Dimensions | 90 mm / 61 mm H / D |

Ordering data

| Type | Order No. | Pcs. / Pkt. |
|--------------------------------|-----------|-------------|
| FLKM-D25 SUB/B/KDS3-MT/TU810 | 2304513 | 1 |
| FLKM-D25 SUB/B/KDS3-MT/TU810/P | 2304539 | 1 |
| FLKM-D25 SUB/B/KDS3-MT/TU830 | 2304526 | 1 |

Connectable I/O modules

| Card type | FLKM-D25SUB... |
|----------------|----------------|
| Digital input | DI 810 |
| | DI 811 |
| | DI 814 |
| | DI 830 |
| | DI 831 |
| | DI 885 |
| Digital output | DO 810 |
| | DO 814 |
| Analog input | AI 810 |
| | AI 820 |
| | AI 830 |
| | AI 835 |
| Analog output | AO 810 |
| | AO 820 |

| Description | No. of pos. | Module width W |
|---|-------------|----------------|
| VARIOFACE module, with knife disconnect terminal blocks for: | | |
| - S800 I/O output modules | 25 | 126.5 mm |
| - S800 I/O input modules | 25 | 126.5 mm |
| - S800 I/O universal module | 25 | 247.5 mm |



Explanation:

- Flat-ribbon cable strip
- Connection to I/O card
- Screw terminal blocks for separate supply

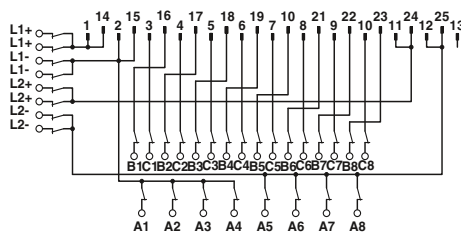

FLKM-D25 SUB/B/KDS3-MT/TU810 connection scheme

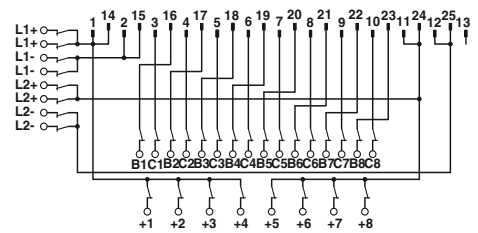

FLKM-D25 SUB/B/KDS3-MT/TU810/P connection scheme

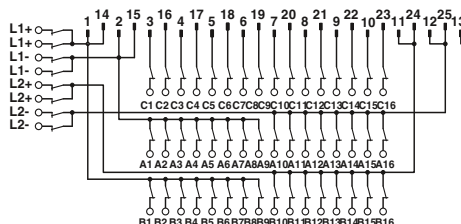

FLKM-D25 SUB/B/KDS3-MT/TU830 connection scheme

ABB S800 I/O
System cable

The ABB S800 I/O system offers the possibility of realizing the process wiring with D-SUB plug-in connectors. ABB TU 812 Compact MTU are available for this purpose.

The CABLE-D25SUB/B/2X14/.../TU812 system cables convert from a D-SUB socket strip to two flat-ribbon cable plugs. Therefore, all 8-channel controller boards of the system cabling can be connected to S800 I/O modules. Two controller boards are used per module.



System cable

Color code and pin assignment
CABLE-D25SUB/B/2X14...TU812

| D-SUB connector 25-pos. | FLK 14 1. Connector | FLK 14 2. Connector | Conductor color |
|-------------------------|---------------------|---------------------|-----------------|
| 1 | 9 | | Gray |
| 2 | 10 | | White |
| 3 | 1 | | Black |
| 4 | 3 | | Red |
| 5 | 5 | | Yellow |
| 6 | 7 | | Blue |
| 7 | | 1 | Black |
| 8 | | 3 | Red |
| 9 | | 5 | Yellow |
| 10 | | 7 | Blue |
| 11 | | 9 | Orange |
| 12 | | 10 | White |
| 13 | NC | NC | - |
| 14 | 11 | | White-black |
| 15 | 12 | | White-brown |
| 16 | 2 | | Brown |
| 17 | 4 | | Orange |
| 18 | 6 | | Green |
| 19 | 8 | | Violet |
| 20 | | 2 | Brown |
| 21 | | 4 | Orange |
| 22 | | 6 | Green |
| 23 | | 8 | Violet |
| 24 | | 11 | White-black |
| 25 | | 12 | White-brown |

Max. perm. operating voltage
Max. perm. current carrying capacity per path
Ambient temperature (operation)
Assembly

Conductor cross section
Conductor structure: stranded wires / material
Outside diameter

25 -position

Technical data

< 50 V AC / 60 V DC
1 A
-20°C ... 50°C
Insulation displacement, IEC 60352-4/DIN EN 60352-4

AWG - / 0.14 mm²
7 / Cu tin-plated

6.3 mm

Ordering data

Description

No. of pos. Cable length

VARIOFACE system cable, for S800 I/O, with a 25-pos. D-SUB socket strip and two 14-pos. flat-ribbon cable plugs, in standard lengths

25 1 m
25 2 m
25 3 m
25 5 m

VARIOFACE system cable for S800 I/O, with a 25-pos. D-SUB socket strip and two 14-pos. flat-ribbon cable plugs, in variable lengths

25

Type

Order No.

Pcs. / Pkt.

CABLE-D25SUB/B/2X14/100/TU812 2304649 1
CABLE-D25SUB/B/2X14/200/TU812 2304652 1
CABLE-D25SUB/B/2X14/300/TU812 2304665 1
CABLE-D25SUB/B/2X14/500/TU812 2304678 1

CABLE-D25SUB/B/2X14/TU812/... 2304681 1

Ordering example for system cable:

- Cable for ABB S800, 12.75 m long

| Quantity | Order No. | Length [m] ¹⁾ |
|----------|-----------|--------------------------|
| 1 | 2304681 | 12.75 |

¹⁾ min. 0.20 m

System cabling for controllers

VARIOFACE system cabling

Allen-Bradley ControlLogix, Honeywell PlantScape Front adapter

I/O modules with 32 channels or with this design

The front adapters are pushed into the tall 1756-TBE covers (not supplied as standard, original accessories must be ordered directly from manufacturer) of the controller. A 50-pos. system cable can connect a maximum of 32 channels to the field level.

Perfectly-fitting VARIOFACE termination boards round off this system concept.

| Notes: |
|---|
| Front adapters can also be used without cover. |
| Suitable system cabling components can be configured in the INTERFACE search wizard. See www.phoenixcontact.net/products |



32-channel front adapter with 50-pos. FLK strip



Technical data

| | |
|---|--|
| Max. perm. operating voltage | < 50 V AC / 60 V DC |
| Max. permissible current | 1 A (per path) 8 A (per connection, supply via separate power supply) |
| Ambient temperature (operation) | -20°C ... 50°C |
| Ambient temperature (storage/transport) | -20°C ... 70°C |
| Connection data solid / stranded / AWG | 0.14 ... 1.5 mm ² / 0.14 ... 1.5 mm ² / 28 - 16 |
| Standards/regulations | IEC 60664 / IEC 60664 / IEC 60664 |

Ordering data

| Description | No. of pos. | Type | Order No. | Pcs. / Pkt. |
|--|-------------|-----------------------------------|----------------|-------------|
| VARIOFACE front adapters, for ControlLogix: | | | | |
| - A maximum of 1 x 32 channels can be connected | 50 | FLKM 50-PA-AB/1756/EXTC | 2302735 | 1 |
| - IB 32 input board | 50 | FLKM 50-PA-AB/1756/IN/EXTC | 2302748 | 1 |

Front adapters for I/O modules of Allen-Bradley ControlLogix and Honeywell PlantScape automation devices

| Card type | FLKM 50-PA-AB/1756/EXTC |
|----------------|---|
| Digital input | 1756-IA 16 I* or TC-TDK 161* 1756-IB 16 D* or TC-TDX 161* 1756-IB 16 I* or TC-TDJ 161* 1756-IH 16 I* |
| Digital output | 1756-OB 32 or TC-ODD 321 |
| Analog input | 1756-IF 8* 1756-IF 16 I* or TC-IAH 161* 1756-IF 8H* or TC-HAI 081* |
| Counter | 1756-HSC* |
| Servo | 1756-M02 AE* |
| Card type | FLKM 50-PA-AB/1756/IN/EXTC |
| Digital input | 1756-IB 32 or TC-IDD 321 |

* Only in conjunction with VIP-2/SC/FLK50/AB-1756, Order No. 2322317. There must be no voltage supply at the front adapter. Risk of short circuit!

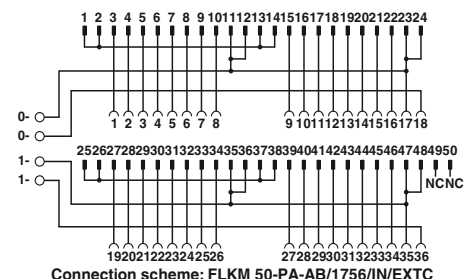
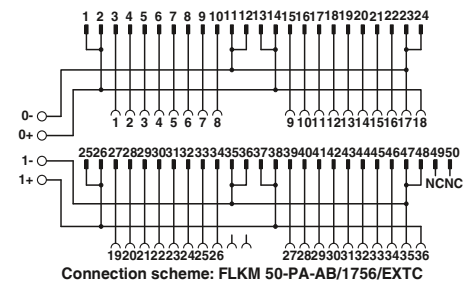

Explanation:

- Flat-ribbon cable strip
- Connection to I/O card
- Screw terminal blocks for separate supply

Allen-Bradley ControlLogix, Honeywell PlantScope Front adapter

I/O modules with 16 channels or with this design

The front adapters are pushed into the tall 1756-TBE covers (not supplied as standard, original accessories must be ordered directly from manufacturer) of the controller. Two 14-pos. system cables are used to connect up to 2 x 8 channels to the field level.

Perfectly-fitting VARIOFACE termination boards round off this system concept.

Notes:

Front adapters can also be used without cover.

Suitable system cabling components can be configured in the INTERFACE search wizard. See www.phoenixcontact.net/products



16-channel front adapter with two 14-pos. FLK strips



Technical data

Max. perm. operating voltage
Max. permissible current

< 50 V AC / 60 V DC
1 A (per path)
8 A (per connection, supply via separate power supply)

Ambient temperature (operation)
Ambient temperature (storage/transport)
Connection data solid / stranded / AWG
Standards/regulations

-20°C ... 50°C
-20°C ... 70°C
0.14 ... 1.5 mm² / 0.14 ... 1.5 mm² / 28 - 16
IEC 60664 / IEC 60664 / IEC 60664

Ordering data

| Description | No. of pos. |
|---|-------------|
| VARIOFACE front adapters, for ControlLogix: | |
| - Up to 2 x 8 channels can be connected | 14 |
| - IA 16, IB 16, IC 16, IN 16 input card | 14 |
| - IF6 I input card (only suitable for measuring current; no power terminals on adapter) | 14 |

| Type | Order No. | Pcs. / Pkt. |
|------------------------------|-----------|-------------|
| FLKM 14-PA-AB/1756/EXTC | 2302861 | 1 |
| FLKM 14-PA-AB/1756/IN/EXTC | 2302874 | 1 |
| FLKM 14-PA-AB/1756/IF6I/EXTC | 2901037 | 1 |

Front adapter for I/O modules of Allen Bradley ControlLogix and Honeywell PlantScope automation devices

| Card type | FLKM 14-PA-AB/1756/EXTC |
|----------------|---|
| Digital input | 1756-IA 8 D** or TC-IDX 081** |
| Digital output | 1756-OB 16 E |
| Analog input | 1756-IF 6 CIS** 1756-IF 6 I** or TC-IAH 061** 1756-IR 6 I** or TC-IXR 061** 1756-IT 6 I** or TC-IXL 061** |
| Analog output | 1756-OF 4 I** 1756-OF 6 CI** or TC-OAH 061** 1756-OF 6 VI** or TC-OAV 061** 1756-OF 8** or TC-OAV 081** 1756-OF 8 H** |
| Switch | 1756-PLS** |

| Card type | FLKM 14-PA-AB/1756/IN/EXTC |
|---------------|--|
| Digital input | 1756-IN 16** 1756-IA 16 or TC-IDA 161** 1756-IB 16 1756-IC 16** |

| Card type | FLKM 14-PA-AB/1756/IF6I/EXTC |
|--------------|------------------------------|
| Analog input | IF6I** |

** Only in conjunction with VIP-2/SC/2FLK14/AB-1756, Order No.: 2322333. There must be no voltage supply at the front adapter. Risk of short circuit!!!



Connection scheme: FLKM 14-PA-AB/1756/IF6I/EXTC

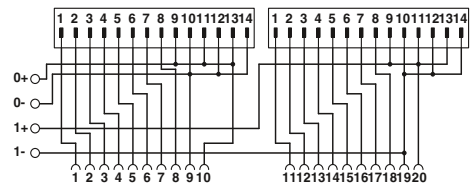

Connection scheme: FLKM 14-PA-AB/1756/EXTC

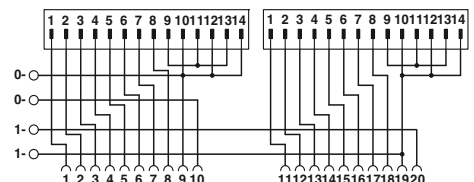

Connection scheme: FLKM 14-PA-AB/1756/IN/EXTC

Explanation:

- Flat-ribbon cable strip
- Connection to I/O card
- Screw terminal blocks for separate supply

System cabling for controllers

VARIOFACE system cabling

Allen-Bradley, PLC 5 series 1771 Front adapter

The front adapters mean that pre-assembled system cables can be directly connected to I/O modules.

Up to 32 channels are connected via 50-pos. system cables.

Perfectly-fitting VARIOFACE termination boards with a variety of functions and connection possibilities round off this system concept.

Notes:

Suitable system cabling components can be configured in the INTERFACE search wizard. See www.phoenixcontact.net/products



Front adapter for Allen-Bradley PLC 5, 1771



Technical data

| | |
|---|--|
| Max. perm. operating voltage | < 50 V AC / 60 V DC |
| Max. permissible current | 1 A (per path) |
| Max. perm. total current | 2 A (Per Byte, for supply via connector) |
| Ambient temperature (operation) | -20°C ... 50°C |
| Ambient temperature (storage/transport) | -20°C ... 70°C |
| Standards/regulations | IEC 60664 / IEC 60664 / IEC 60664 |

Ordering data

| Description | No. of pos. |
|--|-------------|
| VARIOFACE front adapters, for Allen-Bradley PLC 5, 1771 | |
| - IBN 32 channels input | 50 |
| - OBN 32 channels output | 50 |

| Type | Order No. | Pcs. / Pkt. |
|-------------------|-----------|-------------|
| FLKM 50-PA-AB/IBN | 2289816 | 2 |
| FLKM 50-PA-AB/OBN | 2289829 | 2 |

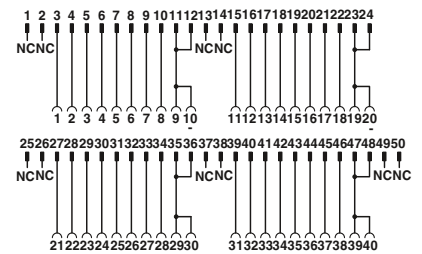

Connection scheme FLKM 50-PA-AB/IBN

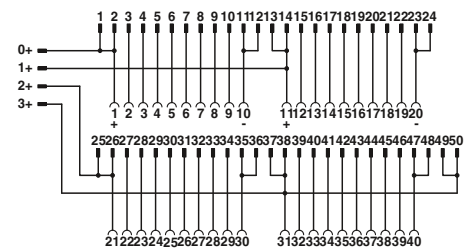

Connection scheme FLKM 50-PA-AB/OBN

Explanation:

- Flat-ribbon cable strip
- Connection to I/O card
- Screw terminal blocks for separate supply

VARIOFACE system cabling

Allen-Bradley SLC 500 Front adapter

The front adapters mean that pre-assembled system cables can be directly connected to I/O modules.

- The FLKM 14-PA-SLC500... adapters connect max. 2 x 8 channels via two 14-pos. system cables. Perfectly-fitting VARIOFACE termination boards with a variety of functions and connection possibilities round off this system concept.
- With the FLKM50-PA-SLC500 OUT/2A front adapters, the FLKM 50/16/SLC500 termination board and 50-pos. system cables, the VARIOFACE system cabling can also be coupled to the OA16 and OW16 power output cards.

Notes:

Suitable system cabling components can be configured in the INTERFACE search wizard. See www.phoenixcontact.net/products



Front adapter for SLC 500 1746, 2 x 8 channels can be connected



Technical data

| FLKM 14-PA... | FLKM 50-PA... |
|--|--|
| < 50 V AC / 60 V DC | < 50 V AC / 60 V DC |
| 1 A (per path) | 2 A (per path) |
| 2 A (Per Byte, for supply via connector) | 7 A (Per Byte, for supply via connector) |
| -20°C ... 50°C | -20°C ... 50°C |
| -20°C ... 70°C | -20°C ... 70°C |
| Any | Any |
| IEC 60664 / IEC 60664 / IEC 60664 | IEC 60664 / IEC 60664 / IEC 60664 |

Ordering data

| Type | Order No. | Pcs. / Pkt. |
|--------------------------|-----------|-------------|
| FLKM 14-PA-SLC500/OUT | 2293459 | 1 |
| FLKM 14-PA-SLC500/IN | 2293462 | 1 |
| FLKM 14-PA-SLC500/IN/M | 2293475 | 1 |
| FLKM 50-PA-SLC500/OUT/2A | 2293446 | 1 |

| | |
|---|--|
| Max. perm. operating voltage | |
| Max. permissible current | |
| Max. perm. total current | |
| Ambient temperature (operation) | |
| Ambient temperature (storage/transport) | |
| Mounting position | |
| Standards/regulations | |

| Description | No. of pos. |
|---|-------------|
| VARIOFACE front adapter, 2 x 8 channels can be connected for Allen-Bradley SLC 500 for: | |
| - 1746 OB16, OV16, OG16 and IG16 | 14 |
| - 1746 IA16, IB16, ITB16 and IN16 | 14 |
| - 1746 IV16 and IVT16 | 14 |
| VARIOFACE front adapter, 1 x 16 channels can be connected for Allen-Bradley SLC 500 1746 OA16 and OW16 | 50 |

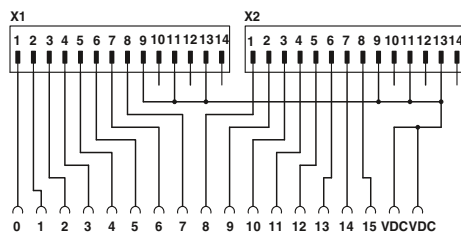

Connection scheme FLKM 14-PA-SLC500/IN/M

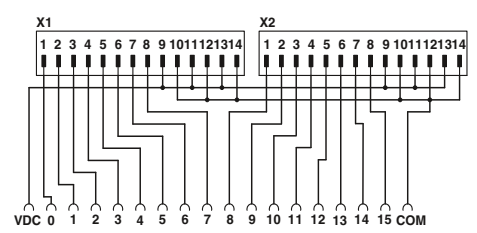

Connection scheme FLKM 14-PA-SLC500/OUT

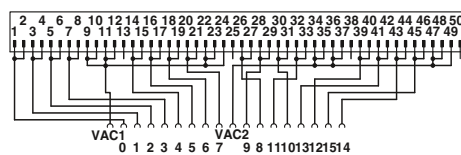

Connection scheme FLKM 50-PA-SLC500/OUT/2A

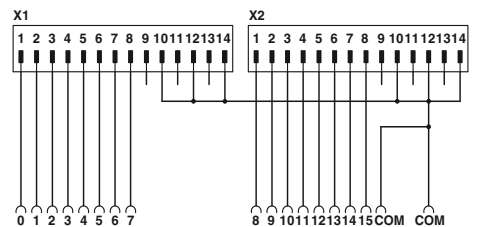

Connection scheme FLKM 14-PA-SLC500/IN

Explanation:

- Flat-ribbon cable strip
- Connection to I/O card
- Screw terminal blocks for separate supply

VIP termination board for Allen-Bradley SLC 500, 2 A output cards

The VIP-2/.../FLK50/16/SLC500 VARIOFACE Professional (VIP) module has been designed specifically for OA16 and OW16 output modules. When used in conjunction with the FLKM 50-PA-SLC500/OUT/2A front adapter, currents up to 2 A per channel can be transferred with the system cabling.

Notes:
For marking systems (e.g., "ZB 22:UNBEDRUCKT"; Order No. 0811862) and mounting material, see Catalog 5.

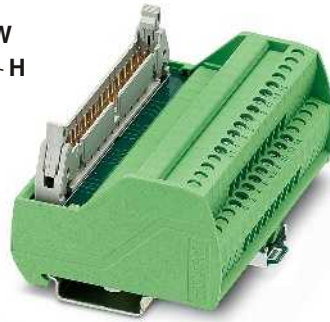

VARIOFACE termination board for 16 channels with screw connection

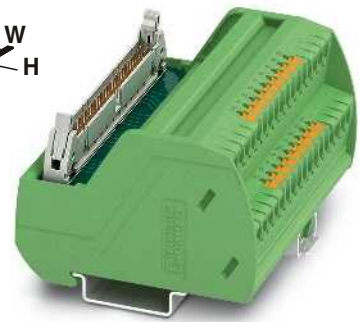

VARIOFACE termination board for 16 channels with push-in connection



| | |
|--|--|
| Max. perm. operating voltage | 120 V AC/DC |
| Max. perm. current (per branch) | 1 A |
| Max total current (voltage supply) | 2 A (per channel) |
| Ambient temperature (operation) | -20°C ... 50°C |
| Mounting position | Any |
| Standards/regulations | IEC 60664, DIN EN 50178, IEC 62103 |
| Connection method | Screw connection |
| | Field level |
| | Control system level |
| Connection data solid / stranded / AWG | IDC/FLK pin strip (2.54 mm) 0.2 ... 4 mm ² / 0.2 ... 2.5 mm ² / 24 - 12 |
| Dimensions | 65.5 mm / 56 mm |

Technical data

| | |
|--|--|
| Max. perm. operating voltage | 120 V AC/DC |
| Max. perm. current (per branch) | 1 A |
| Max total current (voltage supply) | 2 A (per channel) |
| Ambient temperature (operation) | -20°C ... 50°C |
| Mounting position | Any |
| Standards/regulations | IEC 60664, DIN EN 50178, IEC 62103 |
| Connection method | Push-in connection |
| | Field level |
| | Control system level |
| Connection data solid / stranded / AWG | IDC/FLK pin strip (2.54 mm) 0.14 ... 2.5 mm ² / 0.14 ... 2.5 mm ² / 26 - 14 |
| Dimensions | 72.1 mm / 56 mm |

Technical data

| | |
|--|--|
| Max. perm. operating voltage | 120 V AC/DC |
| Max. perm. current (per branch) | 1 A |
| Max total current (voltage supply) | 2 A (per channel) |
| Ambient temperature (operation) | -20°C ... 50°C |
| Mounting position | Any |
| Standards/regulations | EN 50178, |
| Connection method | Push-in connection |
| | Field level |
| | Control system level |
| Connection data solid / stranded / AWG | IDC/FLK pin strip (2.54 mm) 0.14 ... 2.5 mm ² / 0.14 ... 2.5 mm ² / 26 - 14 |
| Dimensions | 72.1 mm / 56 mm |

Ordering data

| Type | Order No. | Pcs. / Pkt. |
|--------------------------|-----------|-------------|
| VIP-2/SC/FLK50/16/SLC500 | 2322320 | 1 |

Ordering data

| Type | Order No. | Pcs. / Pkt. |
|--------------------------|-----------|-------------|
| VIP-2/PT/FLK50/16/SLC500 | 2904287 | 1 |

| Description | No. of pos. | Module width W |
|--|-------------|----------------|
| VARIOFACE controller board , for transfer of max. 16 channels, only in connection with FLKM 50-PA-SLC500 OUT/2A | | |
| - with screw connection | | 90.8 mm |
| - with push-in connection | 50 | 92.7 mm |

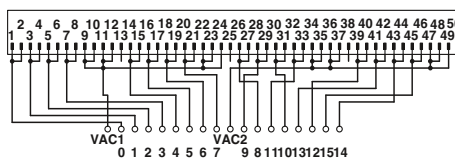

Connection scheme VIP-2/.../FLK50/16/SLC500

System cabling for controllers

VARIOFACE system cabling

Allen-Bradley SLC 500 System cable for 32 channels

The 32-channel I/O cards of the SLC 500 are connected using 40-pos. plug-in connectors (already integrated into the I/O modules). Passive interface modules (-3/SC/FLK40, etc.) are connected to the I/O cards using the **FLK 40/EZ-DR/.../SLC** system cables.

32 channels are split into 4x8 channels using the **FLK 40/4X14/EZ-DR/...** system cables.

The following 8-channel system cabling modules can be coupled:

- OB32 and IB32
passive and active modules plus V8 adapter
- OV32 and IV32
passive modules without status indicator

Notes:
Suitable system cabling components can be configured in the INTERFACE search wizard. See www.phoenixcontact.net/products



System cable for 32-channel I/O cards of the SLC 500 (OB32, OV32, IB32, IV32)



Max. perm. operating voltage
Max. perm. current carrying capacity per path
Ambient temperature (operation)
Assembly

Conductor cross section
Conductor structure: stranded wires / material
Outside diameter

| Technical data | |
|---|-------|
| < 50 V AC / 60 V DC | |
| 1 A | |
| -20°C ... 50°C | |
| Insulation displacement, IEC 60352-4/DIN EN 60352-4 | |
| AWG 26 / 0.14 mm ² | |
| 7 / Cu tin-plated | |
| 40 -position | 10 mm |

| Description | No. of pos. | Cable length |
|--|-------------|--------------|
| Assembled round cables , with two 40-pos. socket strips in fixed lengths (50 cm steps) for connection with 32-channel I/O cards of the SLC 500 | | |
| | 40 | 0.5 m |
| | 40 | 1 m |
| | 40 | 1.5 m |
| | 40 | 2 m |
| | 40 | 3 m |
| Round cable sets , for connection to Allen-Bradley SLC500, OB32 and IB32, with one 40-pos. socket strip and four 14-pos. socket strips, for splitting max. 32 channels into 4 x 8 channels. | | |
| for OB32 | 40 | 0.5 m |
| | 40 | 1 m |
| | 40 | 2 m |
| | 40 | 3 m |
| for IB32 | 40 | 0.5 m |
| | 40 | 1 m |
| | 40 | 2 m |
| | 40 | 3 m |

| Ordering data | | |
|-----------------------|-----------|-------------|
| Type | Order No. | Pcs. / Pkt. |
| FLK 40/EZ-DR/ 50/SLC | 2294610 | 1 |
| FLK 40/EZ-DR/ 100/SLC | 2294623 | 1 |
| FLK 40/EZ-DR/ 150/SLC | 2294636 | 1 |
| FLK 40/EZ-DR/ 200/SLC | 2294649 | 1 |
| FLK 40/EZ-DR/ 300/SLC | 2294652 | 1 |



**System cable for
splitting max. 32 channels into 4 x 8 channels
(OB32, IB32)**



Technical data

< 50 V AC / 60 V DC
1 A
-20°C ... 50°C
Insulation displacement, IEC 60352-4/DIN EN 60352-4

AWG 26 / 0.14 mm²
7 / Cu tin-plated

7.8 mm

Ordering data

| Type | Order No. | Pcs. / Pkt. |
|-----------------------------|-----------|----------------|
| ... | | |
| FLK 40/4X14/EZ-DR/ 50/OB32 | 2296786 | 1 |
| FLK 40/4X14/EZ-DR/ 100/OB32 | 2298483 | 1 |
| FLK 40/4X14/EZ-DR/ 200/OB32 | 2298522 | 1 |
| FLK 40/4X14/EZ-DR/ 300/OB32 | 2298535 | 1 |
| FLK 40/4X14/EZ-DR/ 50/IB32 | 2296812 | 1 |
| FLK 40/4X14/EZ-DR/ 100/IB32 | 2296825 | 1 |
| FLK 40/4X14/EZ-DR/ 200/IB32 | 2296838 | 1 |
| FLK 40/4X14/EZ-DR/ 300/IB32 | 2296841 | 1 |

VARIOFACE system cabling

Emerson DeltaV System cable

The DeltaV system allows you to install the process wiring through “Mass termination blocks” (MTB) using flat-ribbon cable connectors. Besides the 10-, 16-, and 20-pos. system cables of system cabling (refer to the System cables chapter), the following system-specific lines are also available:

- **FLK 16/14/DV-OUT/...**, for digital assemblies with 16-pos. MTB for connection to PLC-INTERFACE
- **FLK 16/14/DV-IN/...**, for digital assemblies with 16-pos. MTB for connection to PLC-INTERFACE
- **FLK 20/2FLK14/EZ-DR/...**, for digital assemblies with 40-pos. MTB for connection to PLC-INTERFACE
- **FLK 16/24/DV-AI/EZ-DR/...**, for analog assemblies with 24-pos. MTB
- **FLK 50/2FLK20/EZ-DR/.../DV** system cables are specifically designed for 32-channel I/O modules with 40-pin MTB for the purpose of connecting I/O modules to 32-channel VARIOFACE interface modules



System cable for DeltaV

| | | Technical data | |
|---|--|-------------------------------|---------|
| Max. perm. operating voltage | | < 50 V AC / 60 V DC | |
| Max. perm. current carrying capacity per path | | 1 A | |
| Max. conductor resistance | | 0.16 Ω/m | |
| Ambient temperature (operation) | | -20°C ... 50°C | |
| Conductor cross section | | AWG 26 / 0.14 mm ² | |
| Outside diameter | | 16 -position | 6.8 mm |
| | | 20 -position | 7.6 mm |
| | | 24 -position | 6.5 mm |
| | | 20 -position | 10.3 mm |

| Description | No. of pos. | Cable length |
|---|-------------|--------------|
| System cable , for 16-pos. "mass termination blocks" with a 16-pos. and a 14-pos. flat-ribbon cable plug for connection with PLC-INTERFACE | | |
| | 16 | 0.3 m |
| | 16 | 0.5 m |
| | 16 | 1 m |
| | 16 | 2 m |
| | 16 | 3 m |
| Variable cable length | 16 | |
| System cable , for 16-pos. "mass termination blocks" with a 16-pos. and a 14-pos. flat-ribbon cable plug for connection with PLC-INTERFACE | | |
| | 16 | 0.5 m |
| | 16 | 1 m |
| | 16 | 2 m |
| | 16 | 3 m |
| | 16 | 4 m |
| Variable cable length | 16 | |
| System cable , for 40-pos. (2 x 20) "mass termination blocks" with a 20-pos. and two 14-pos. flat-ribbon cable plugs for connection with PLC-INTERFACE (two cables should be used per 32-channel I/O card) | | |
| | 20 | 1 m |
| | 20 | 2 m |
| | 20 | 3 m |
| Variable cable length | 20 | |
| System cable , for 24-pos. "mass termination blocks" with a 24-pos. and a 16-pos. flat-ribbon cable plug for connection with UM-DELTA/... modules | | |
| | 24 | 0.3 m |
| | 24 | 0.5 m |
| | 24 | 1 m |
| | 24 | 2 m |
| | 24 | 3 m |
| Variable cable length | 24 | |
| System cable , for 40-pos. "mass termination blocks" with two 20-pos. and one 50-pos. flat-ribbon cable plugs for connecting with 32-channel interface modules | | |
| | 20 | 0.5 m |
| | 20 | 1 m |
| | 20 | 2 m |
| | 20 | 3 m |
| | 20 | 6 m |
| | 20 | 8 m |
| | 20 | 10 m |
| Variable cable length | 20 | |

| Ordering data | | |
|--------------------------------|-----------|-------------|
| Type | Order No. | Pcs. / Pkt. |
| FLK 16/14/DV-OUT/ 30 | 2304348 | 1 |
| FLK 16/14/DV-OUT/ 50 | 2304351 | 1 |
| FLK 16/14/DV-OUT/100 | 2300575 | 1 |
| FLK 16/14/DV-OUT/200 | 2300588 | 1 |
| FLK 16/14/DV-OUT/300 | 2304364 | 1 |
| FLK 16-14-DV-OUT/... | 2304377 | 1 |
| FLK 16/14/DV-IN/ 50 | 2304393 | 1 |
| FLK 16/14/DV-IN/100 | 2300559 | 1 |
| FLK 16/14/DV-IN/200 | 2300562 | 1 |
| FLK 16/14/DV-IN/300 | 2304403 | 1 |
| FLK 16/14/DV-IN/400 | 2305185 | 1 |
| FLK 16-14-DV-IN/... | 2304416 | 1 |
| FLK 20/2FLK14/EZ-DR/100/KONFEK | 2298470 | 1 |
| FLK 20/2FLK14/EZ-DR/200/KONFEK | 2298438 | 1 |
| FLK 20/2FLK14/EZ-DR/300/KONFEK | 2300818 | 1 |
| FLK 20/2FLK14/EZ-DR/... | 2304487 | 1 |
| FLK 16/24/DV-AI/EZ-DR/ 30 | 2304319 | 1 |
| FLK 16/24/DV-AI/EZ-DR/ 50 | 2304296 | 1 |
| FLK 16/24/DV-AI/EZ-DR/100 | 2301134 | 1 |
| FLK 16/24/DV-AI/EZ-DR/200 | 2301545 | 1 |
| FLK 16/24/DV-AI/EZ-DR/300 | 2304322 | 1 |
| FLK 16-24-DV-AI-EZ-DR/... | 2304335 | 1 |
| FLK 50/2FLK20/EZ-DR/ 50/DV | 2304872 | 1 |
| FLK 50/2FLK20/EZ-DR/ 100/DV | 2304898 | 1 |
| FLK 50/2FLK20/EZ-DR/ 200/DV | 2304908 | 1 |
| FLK 50/2FLK20/EZ-DR/ 300/DV | 2304911 | 1 |
| FLK 50/2FLK20/EZ-DR/ 600/DV | 2304937 | 1 |
| FLK 50/2FLK20/EZ-DR/ 800/DV | 2304940 | 1 |
| FLK 50/2FLK20/EZ-DR/1000/DV | 2304953 | 1 |
| FLK 50-2FLK20-EZ-DR-DV/... | 2304966 | 1 |



**Emerson DeltaV
Controller board for eight channels**

These system-specific interface modules for DeltaV assemblies are used in combination with the respective system cables. The controller board is connected to 8-channel modules through “mass termination blocks” with flat-ribbon cable connection.

FLKM 16/DV

- Universal module
- 1:1 connection

FLKM 16/AI/DV

- 1:1 connection
- Separate equipotential terminals per channel

FLKM 16/AO/SI/DV

- 1:1 connection
- Fuse 5 x 20, 50 mA T, IEC60127-2/3 per channel

FLKM 16/DI/SI/LA/DV

- 1:1 connection
- Fuse 5 x 20, 50 mA T, IEC60127-2/3 per channel
- LED status indicator per signal path

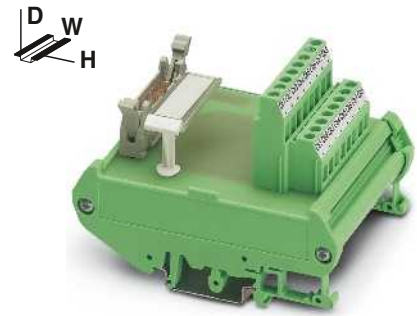

Interface module for 8 channels

Max. perm. operating voltage
Max. perm. current (per branch)

Rated surge voltage
Ambient temperature (operation)
Mounting position
Standards/regulations
Connection method

Field level
Control system level

Connection data solid / stranded / AWG
Dimensions

| Technical data | |
|--|---|
| FLKM 16/.../DV < 50 V AC 1 A (per signal path) | FLKM 16/.../SI/.../DV < 50 V AC 50 mA (In delivered state, with one 50 mA fuse, max. 1 A permitted) |
| 0.8 kV -20°C ... 50°C Any IEC 60664, DIN EN 50178, IEC 62103 | 0.8 kV -20°C ... 50°C Any IEC 60664, DIN EN 50178, IEC 62103 |
| Screw connection IDC/FLK pin strip (2.54 mm) | Screw connection IDC/FLK pin strip (2.54 mm) |
| 0.2 ... 4 mm ² / 0.2 ... 2.5 mm ² / 24 - 12 90 mm / 68 mm | |

| Ordering data | | |
|---------------------|-----------|-------------|
| Type | Order No. | Pcs. / Pkt. |
| FLKM 16/DV | 2304432 | 1 |
| FLKM 16/AI/DV | 2304429 | 1 |
| FLKM 16/AO/SI/DV | 2304445 | 1 |
| FLKM 16/DI/SI/LA/DV | 2304458 | 1 |

| Description | No. of pos. | Module width W |
|--|-------------|----------------|
| Interface module, with 1:1 connection | 16 | 45 mm |
| Interface module, with 1:1 connection and separate potential terminal blocks per channel | 16 | 57 mm |
| Interface module, with fuses per channel | 16 | 90 mm |
| Interface module, with LED and fuses per channel | 16 | 90 mm |

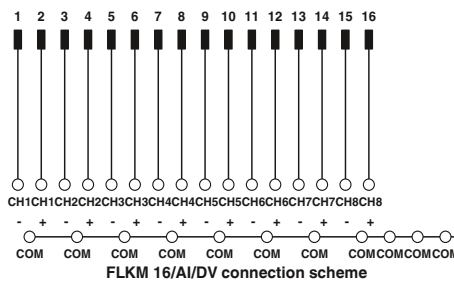
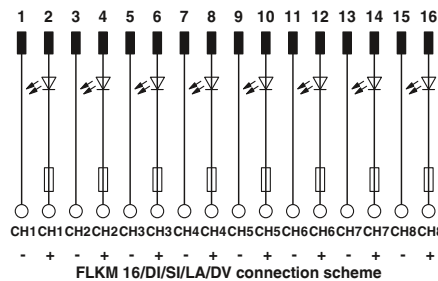
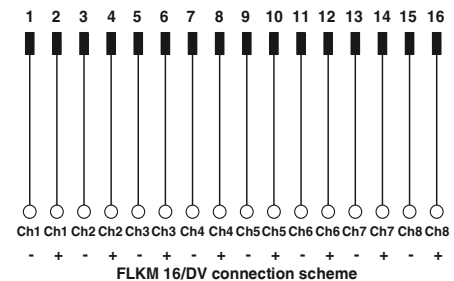
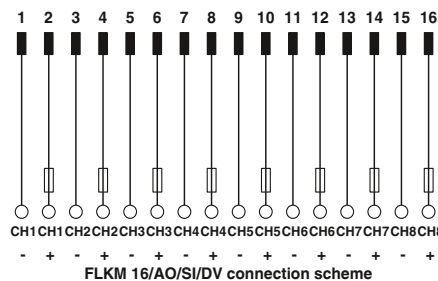

VARIOFACE system cabling

Emerson DeltaV Controller board for 32 channels

These system-specific interface modules for DeltaV assemblies are used in combination with the FLK 50/2FLK20/EZ-DR/.../DV system cables. The controller board is connected to 32-channel modules through 40-pos. "mass termination blocks" with flat-ribbon cable connection.

FLKM 50/32M/DV

- Can be used for 32-channel input and output cards
- Two-conductor connection with a separate negative terminal per channel

FLKM 50/32M/IN/LA/DV

- Can be used for 32-channel input modules
- LED status display per channel
- Two-conductor connection with a separate negative terminal per channel (Dry Contact)



Interface module with two-conductor connection method for DeltaV

| | |
|--|---|
| Max. perm. operating voltage | < 50 V AC |
| Max. perm. current (per branch) | 1 A |
| Rated surge voltage | 0.8 kV |
| Ambient temperature (operation) | -20°C ... 50°C |
| Mounting position | Any |
| Standards/regulations | IEC 60664, DIN EN 50178, IEC 62103 |
| Connection method | Screw connection |
| | Field level |
| | Control system level |
| Connection data solid / stranded / AWG | 0.2 ... 4 mm ² / 0.2 ... 2.5 mm ² / 24 - 12 |
| Dimensions | 90 mm / 68 mm |

| Technical data | | |
|---|-----------------------------|--|
| FLKM 50/32M/DV | FLKM 50/32M/IN/LA/DV | |
| < 50 V AC | 30 V DC | |
| 1 A | 1 A | |
| 0.8 kV | 0.8 kV | |
| -20°C ... 50°C | -20°C ... 50°C | |
| Any | Any | |
| IEC 60664, DIN EN 50178, IEC 62103 | | |
| Screw connection | Screw connection | |
| IDC/FLK pin strip (2.54 mm) | IDC/FLK pin strip (2.54 mm) | |
| 0.2 ... 4 mm ² / 0.2 ... 2.5 mm ² / 24 - 12 | | |
| 90 mm / 68 mm | | |

| Description | No. of pos. | Module width W |
|---|-------------|----------------|
| VARIOFACE interface modules, for 32-channel I/O modules: | | |
| - Input/Output | 50 | 169 mm |
| - Input with LED per signal | 50 | 169 mm |

| Ordering data | | |
|----------------------|-----------|-------------|
| Type | Order No. | Pcs. / Pkt. |
| FLKM 50/32M/DV | 2304869 | 1 |
| FLKM 50/32M/IN/LA/DV | 2304856 | 1 |



FLKM 50/32M/DV connection scheme

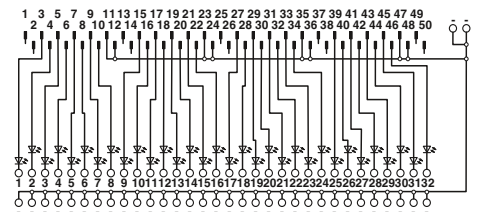

FLKM 50/32M/IN/LA/DV connection scheme

**Emerson DeltaV
Controller boards with fuses for
8 channels**

These system-specific interface modules for DeltaV assemblies are used in combination with the respective system cables. The controller board is connected to 8-channel modules through 16-pos. or 24-pos. "mass termination blocks" with flat-ribbon cable connection.

UM-DELTA V/D/SI

- Fuse per channel
- Separate equipotential terminals per channel

UM-DELTA V/D/SI

- Fuse per channel
- Separate equipotential terminals per channel
- Knife disconnection for each channel

UM-DELTA V/D/SI/BFI/TP

- Fuse and LED status indicator per channel
- Separate equipotential terminals per channel

UM-DELTA V/D/SI

- Fuse and LED status indicator per channel
- Separate equipotential terminals per channel
- Knife disconnection for each channel

| | |
|--|--|
| Max. perm. operating voltage | 24 V DC |
| Max. perm. current (per branch) | 50 mA (in as-supplied state, with one 50 mA fuse, max. 1 A permitted) |
| Ambient temperature (operation) | -20°C ... 50°C |
| Mounting position | Any |
| Standards/regulations | IEC 60664, DIN EN 50178, IEC 62103 |
| Connection method | Field level Control system level |
| Connection data solid / stranded / AWG | Screw connection IDC/FLK pin strip (2.54 mm) 0.2 ... 4 mm ² / 0.2 ... 2.5 mm ² / 24 - 12 |
| Dimensions | 126 mm / 71 mm |

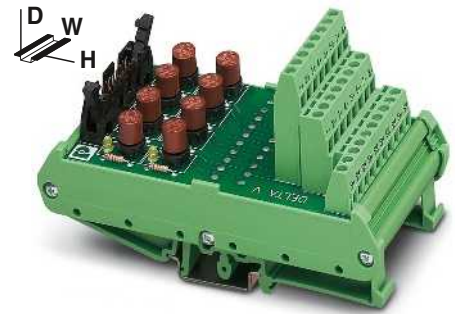

Interface module with fuses for 16-pos. and 24-pos. "mass termination blocks"



Technical data

| | |
|--|--|
| Max. perm. operating voltage | 24 V DC |
| Max. perm. current (per branch) | 50 mA (in as-supplied state, with one 50 mA fuse, max. 1 A permitted) |
| Ambient temperature (operation) | -20°C ... 50°C |
| Mounting position | Any |
| Standards/regulations | IEC 60664, DIN EN 50178, IEC 62103 |
| Connection method | Field level Control system level |
| Connection data solid / stranded / AWG | Screw connection IDC/FLK pin strip (2.54 mm) 0.2 ... 4 mm ² / 0.2 ... 2.5 mm ² / 24 - 12 |
| Dimensions | 126 mm / 71 mm |

Ordering data

| Description | No. of pos. | Module width W |
|--|-------------|----------------|
| Interface modules for 16-pos. and 24-pos. "mass termination blocks" with: | | |
| - Fuses | 16 | 61 mm |
| - Fuses and knife disconnect terminal blocks | 16 | 61 mm |
| - Fuses and fuse failure display | 16 | 61 mm |
| - Fuses, fuse failure display, and knife disconnect terminal blocks | 16 | 61 mm |

| Type | Order No. | Pcs. / Pkt. |
|------------------------|-----------|-------------|
| UM-DELTA V/D/SI | 5603255 | 1 |
| UM-DELTA V/D/SI/BFI/TP | 5603257 | 1 |
| UM-DELTA V/A/SI | 5603256 | 1 |
| UM-DELTA V/A/SI/BFI/TP | 5603258 | 1 |

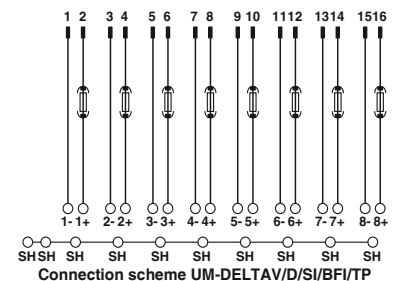
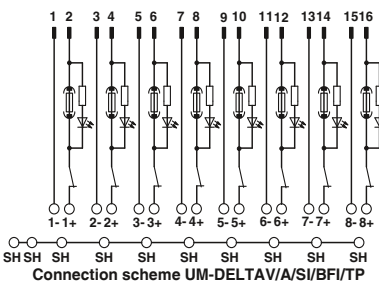
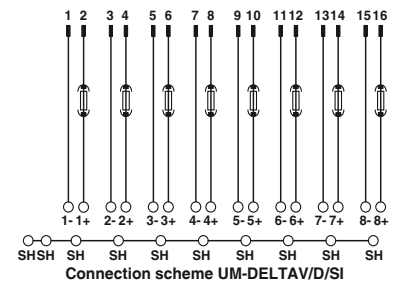
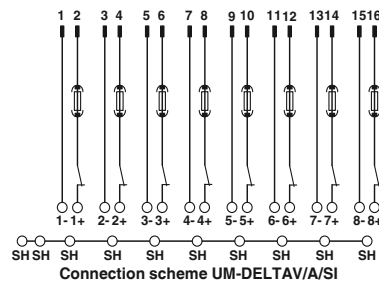

Explanation:
 Flat-ribbon cable strip
 Connection to I/O card
 Screw terminal blocks for separate supply

GE Fanuc/RX3i Front adapters

The front adapters mean that pre-assembled system cables can be directly connected to I/O modules.

- Transfer of max. 32 channels over one 50-pos. system cable
- Can be plugged onto I/O modules
- Connection via suitable VARIOFACE termination boards

Notes:

Suitable system cabling components can be configured in the INTERFACE search wizard. See www.phoenixcontact.net/products



Front adapter for GE Fanuc
RX3i

Technical data

| | |
|---|--|
| Max. perm. operating voltage | < 50 V AC / 60 V DC |
| Max. permissible current | 1 A (per path) 8 A (per connection, supply via separate power supply) |
| Ambient temperature (operation) | -20°C ... 50°C |
| Ambient temperature (storage/transport) | -20°C ... 70°C |
| Mounting position | Any |
| Standards/regulations | DIN EN 50178 / DIN EN 50178 / DIN EN 50178 |

Ordering data

| Description | No. of pos. | Type | Order No. | Pcs. / Pkt. |
|--|-------------|---------------------------|-----------|-------------|
| VARIOFACE front adapter, for PACSystems RX3i, | | | | |
| For digital output and analog modules | 50 | FLKM 50-PA-GE/TKFC/RXI | 2321473 | 1 |
| For digital input modules | 50 | FLKM 50-PA-GE/TKFC/RXI/IN | 2321486 | 1 |

Front adapter for I/O modules of RX3i series

| Card type | FLKM 50-PA/GE/TKFC/RXI |
|----------------|---|
| Digital output | IC 694 MDL 754 |
| Analog | IC 695 ALG 608* IC 695 ALG 616* IC 695 ALG 626* IC 695 ALG 629* IC 695 ALG 704* IC 695 ALG 708* IC 695 ALG 728* |

| Card type | FLKM 50-PA/GE/TKFC/RXI/IN |
|---------------|---------------------------|
| Digital input | IC 694 MDL 660 |

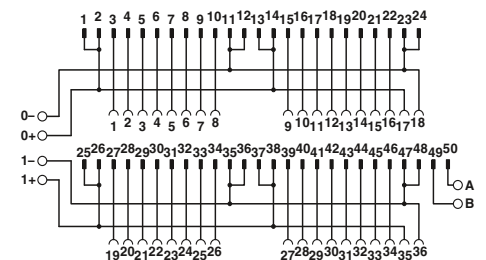

Connection scheme for FLKM 50-PA-GE/TKFC/RXI

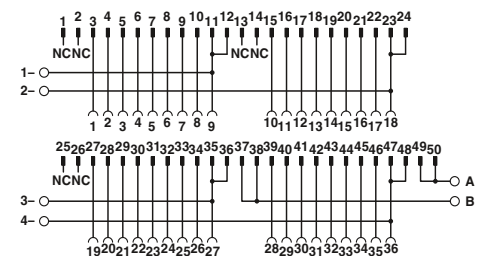

Connection scheme for FLKM 50-PA-GE/TKFC/RXI/IN

* Only in connection with VIP-3/SC/FLK50, Order No. 2315081. No voltage may be supplied through the slip-on connections on the front adapter.

Explanation:

- Flat-ribbon cable strip
- Connection to I/O card
- Screw terminal blocks for separate supply

GE-FANUC, series 90-30 Front adapter

The front adapters mean that pre-assembled system cables can be directly connected to I/O modules.

Up to 2 x 8 channels are connected via two 14-pos. system cables.

Perfectly-fitting VARIOFACE termination boards with a variety of functions and connection possibilities round off this system concept.

Notes:

Suitable system cabling components can be configured in the INTERFACE search wizard. See www.phoenixcontact.net/products



Front adapter for GE-FANUC series 90-30



Technical data

Max. perm. operating voltage
Max. permissible current

< 50 V AC / 60 V DC
1 A (per path)
4 A (per connection, supply via separate power supply)

Max. perm. total current

3 A (Per Byte, for supply via connector)

Ambient temperature (operation)
Ambient temperature (storage/transport)
Mounting position
Standards/regulations

-20°C ... 50°C
-20°C ... 70°C
Any
IEC 60664 / IEC 60664 / IEC 60664

Ordering data

Front adapter for 90-30 series I/O modules

Card type | FLKM 14-PA/GE/DO

Digital output
IC 693 MDL 732
IC 693 MDL 733*
IC 693 MDL 740
IC 693 MDL 741*
IC 693 MDL 742

Analog
IC 693 ALG 220*
IC 693 ALG 221*
IC 693 ALG 222*
IC 693 ALG 223*
IC 693 ALG 390*
IC 693 ALG 391*
IC 693 ALG 392*
IC 693 ALG 442*

| Description | No. of pos. |
|---|-------------|
| VARIOFACE front adapter , for 90-30 series, max. 2 x 8 channels can be connected, digital output | 14 |
| VARIOFACE front adapter , for 90-30 series, max. 2 x 8 channels can be connected, digital input | 14 |

| Type | Order No. | Pcs. / Pkt. |
|------------------|-----------|-------------|
| FLKM 14-PA/GE/DO | 2290009 | 2 |
| FLKM 14-PA/GE/DI | 2290038 | 5 |

Card type | FLKM 14-PA/GE/DI

Digital input
IC 693 MDL 241
IC 693 MDL 634
IC 693 MDL 645
IC 693 MDL 646

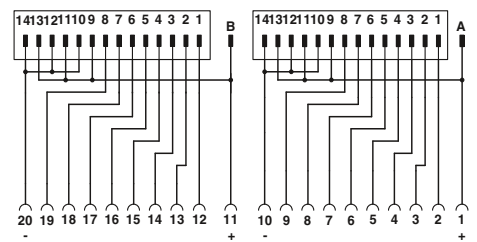

Connection scheme FLKM 14-PA/GE/DO

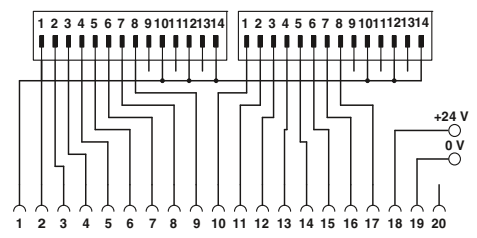

Connection scheme FLKM 14-PA/GE/DI

* Only in conjunction with VIP-2/SC/2FLK14(1-20)/S7, Order No.: 2315230 and UM 45-2FLK14/ZFKDS/S7, Order No.: 2965156. All wire bridges (DR) on the adapter must be disconnected. There must be no voltage supply at the front adapter (flowing via the slip-on connections)!

Explanation:

- Flat-ribbon cable strip
- Connection to I/O card
- Screw terminal blocks for separate supply

System cabling for controllers

VARIOFACE system cabling

Honeywell C300, Series C I/O Front adapters

The front adapters mean that pre-assembled system cables can be directly connected to I/O modules.

FLKM-PA-D37/HW/DIO/C300

- Front adapter with D-SUB plug-in connector
- Connection of a maximum of 16 digital channels
- Specifically for digital I/O cards

FLKM-PA-D37/HW/AN/C300

- Front adapter with D-SUB plug-in connector
- Connection of analog modules

FLKM-PA-2D15/HW/.../C300

- Front adapter with two 15-pos. D-SUB plug-in connectors
- Connection of a maximum of 2 x 8 digital inputs/outputs per adapter
- Specifically for connecting PLC-V8/D15.../OUT or PLC-V8/D15.../IN

Notes:

For matching system cable fitted with D-SUB socket strip at both ends, see page 513



Honeywell C300 front adapter

Technical data

24 V DC
1 A (per path)
-20°C ... 50°C
-20°C ... 70°C
Any
DIN EN 50178 / DIN EN 50178

Ordering data

| Type | Order No. | Pcs. / Pkt. |
|-------------------------|-----------|-------------|
| FLKM-PA-D37/HW/DIO/C300 | 2901423 | 1 |
| FLKM-PA-D37/HW/AN/C300 | 2900622 | 1 |
| FLKM-PA-2D15/HW/DO/C300 | 2900924 | 1 |
| FLKM-PA-2D15/HW/DI/C300 | 2901879 | 1 |

| Description | No. of pos. |
|--|-------------|
| VARIOFACE front adapter for C I/O series, with one D-SUB pin strip | |
| - For digital I/O modules | 37 |
| - For analog I/O modules | 37 |
| VARIOFACE front adapter for C I/O series, with two D-SUB pin strips | |
| - For digital output modules | 15 |
| - For digital input modules | 15 |

Front adapters for I/O modules of the C300 series, C I/O series

| Card type | FLKM-PA-D37/HW/DIO/C300 |
|----------------|-------------------------|
| Digital input | TDIL 11* TDIL 01* |
| Digital output | TDOB 11* TDOB 01* |

| Card type | FLKM-PA-D37/HW/AN/C300 |
|---------------|------------------------|
| Analog input | TAIX 01** TAIX 11** |
| Analog output | TAOX 01** TAOX 11** |

| Card type | FLKM-PA-2D15/HW/DO/C300 |
|----------------|-------------------------|
| Digital output | TDOB 01* TDOB 11* |

| Card type | FLKM-PA-2D15/HW/DI/C300 |
|---------------|-------------------------|
| Digital input | TDIL 01* TDIL 11* |

* Two front adapters are required for each module.

** For three-conductor operation (channels 13 - 16) of input modules: only in conjunction with VIP-3/SC/D37SUB/M/HW/C300, Order No. 2900675.

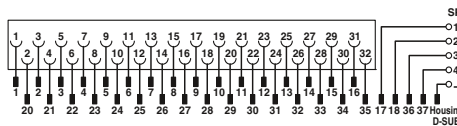

Connection scheme: FLKM-PA-D37/HW/AN/C300



Connection scheme: FLKM-PA-D37/HW/DIO/C300

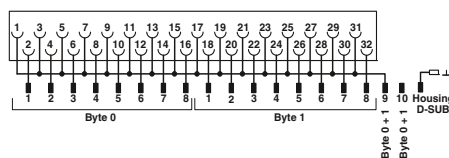

FLKM-PA-2D15/HW/DI/C300 connection scheme



Connection scheme: FLKM-PA-2D15/HW/DO/C300

Explanation:

- Plug-in connector
- Connection to I/O card
- Screw terminal blocks for separate supply

Honeywell C300, Series C I/O interface modules

These VARIOFACE modules are used in combination with 37-pos. D-SUB cables and the relevant front adapters. The three module versions are available with screw or push-in connection technology.

VIP-2/.../D37SUB/M

- In conjunction with FLKM-PA-D37/HW/C300 or FLKM-PA-D37/HW/AN/C300 front adapter
- Universal module
- Field connection via double-level terminal blocks

VIP-2/.../D37SUB/M/SO

- In conjunction with FLKM-PA-D37/HW/C300 front adapter
- System-specific labeling
- Field connection via double-level terminal blocks

VIP-3/.../D37SUB/M/HW/C300

- In conjunction with FLKM-PA- D37/HW/AN/C300 front adapter
- System-specific labeling
- For TAIX01, TAIX11 analog input modules
- Field connection via three-level terminal blocks

Notes:

For marking systems (e.g., "ZB 22:UNBEDRUCKT"; Order No., 0811862) and mounting material, see Catalog 5.

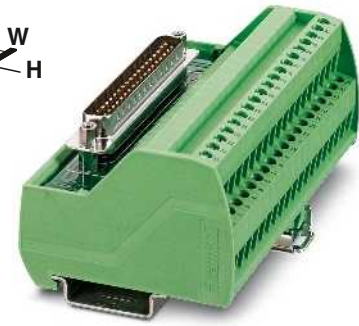

37-pos. with screw or push-in connection



Technical data

| VIP-2/... | VIP-3/...C300 |
|---|-----------------|
| 125 V AC/DC | 125 V AC/DC |
| 2 A | 2 A |
| -20°C ... 50°C | -20°C ... 50°C |
| Any | Any |
| DIN EN 50178, | |
| D-SUB pin strip | D-SUB pin strip |
| 72.1 mm / 46.6 mm | 75.8 mm / 63 mm |
| 0.2 ... 4 mm ² / 0.2 ... 2.5 mm ² / 24 - 12 | |
| 0.14 ... 4 mm ² / 0.14 ... 2.5 mm ² / 26 - 14 | |

Ordering data

| Description | No. of pos. | Module width W |
|--|-------------|----------------|
| VARIOFACE interface module , with D-SUB pin strip and universal labeling, | | |
| - with screw connection | 37 | 101 mm |
| - with push-in connection | 37 | 102.8 mm |
| VARIOFACE interface module , with D-SUB pin strip and system-specific labeling, | | |
| - with screw connection | 37 | 101 mm |
| - with push-in connection | 37 | 102.8 mm |
| VARIOFACE interface module , with D-SUB pin strip for analog input modules, | | |
| - with screw connection | 37 | 88 mm |
| - with push-in connection | 37 | 87.6 mm |

| Type | Order No. | Pcs. / Pkt. |
|----------------------------------|-----------|-------------|
| VIP-2/SC/D37SUB/M | 2900676 | 1 |
| VIP-2/PT/D37SUB/M | 2904277 | 1 |
| VIP-2/SC/D37SUB/M/SO | 2900786 | 1 |
| VIP-2/PT/D37SUB/M/SO | 2904278 | 1 |
| VIP-3/SC/D37SUB/M/HW/C300 | 2900675 | 1 |
| VIP-3/PT/D37SUB/M/HW/C300 | 2904276 | 1 |

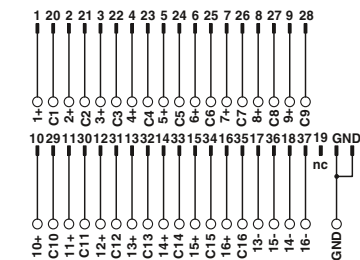

Connection scheme VIP-3/SC/D37SUB/M/HW/C300

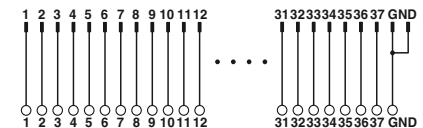

Connection scheme VIP-2/SC/D37SUB/M

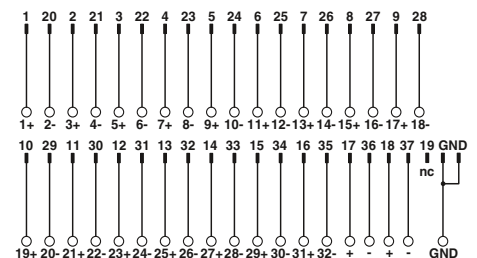

Connection scheme VIP-2/SC/D37SUB/M/SO

System cabling for controllers

VARIOFACE system cabling

Mitsubishi Electric MELSEC A, A1S, and Q System cable

For 32-/64-channel I/O boards with 37-pos. D-SUB plug-in connectors. System cables are available for connecting 1 x 32 channels or 4 x 8 channels.

Notes:

Suitable system cabling components can be configured in the INTERFACE search wizard. See www.phoenixcontact.net/products



**System cable,
D-SUB socket strip to FLK,
number of positions: 37 on 50**



**Splitting cable,
D-SUB socket strip to FLK,
number of positions: 37 on 4 x 14**



Technical data

| | |
|--|-------------------------------|
| Max. perm. operating voltage | < 50 V AC / 60 V DC |
| Max. perm. current carrying capacity per path | 1 A |
| Max. conductor resistance | 0.16 Ω/m |
| Ambient temperature (operation) | -20°C ... 50°C |
| Conductor cross section | AWG 26 / 0.14 mm ² |
| Conductor structure: stranded wires / material | 7 / Cu tin-plated |
| Outside diameter | 10.5 mm |

37-pos.



Technical data

| | |
|--|-------------------------------|
| Max. perm. operating voltage | < 50 V AC / 60 V DC |
| Max. perm. current carrying capacity per path | 1 A |
| Max. conductor resistance | 0.16 Ω/m |
| Ambient temperature (operation) | -20°C ... 50°C |
| Conductor cross section | AWG 26 / 0.14 mm ² |
| Conductor structure: stranded wires / material | 7 / Cu tin-plated |
| Outside diameter | 6.3 mm |

Ordering data

| Description | No. of pos. | Cable length | Type | Order No. | Pcs. / Pkt. |
|---|-------------|--------------|--------------------------------|-----------|-------------|
| Round cable for output module MELSEC Q Y81 P, MELSEC A1S Y81, and MELSEC A AY82EP, in standard lengths | | | | | |
| | 37 | 0.5 m | FLK 50/EZ-DR/D37SUB/ 50/Y81P-O | 2302599 | 1 |
| | 37 | 1 m | FLK 50/EZ-DR/D37SUB/100/Y81P-O | 2302609 | 1 |
| | 37 | 2 m | FLK 50/EZ-DR/D37SUB/200/Y81P-O | 2302612 | 1 |
| | 37 | 3 m | FLK 50/EZ-DR/D37SUB/300/Y81P-O | 2302638 | 1 |
| Round cable, same as before, however in variable lengths | | | | | |
| | 37 | | FLK 50-EZ-DR-D37SUB-Y81P-O/... | 2302625 | 1 |
| Round cable for input module MELSEC Q X81, MELSEC A1S X81, and MELSEC A AX82, in standard lengths | | | | | |
| | 37 | 0.5 m | FLK 50/EZ-DR/D37SUB/ 50/X81-I | 2302641 | 1 |
| | 37 | 1 m | FLK 50/EZ-DR/D37SUB/100/X81-I | 2302654 | 1 |
| | 37 | 2 m | FLK 50/EZ-DR/D37SUB/200/X81-I | 2302667 | 1 |
| | 37 | 3 m | FLK 50/EZ-DR/D37SUB/300/X81-I | 2302670 | 1 |
| Round cable, same as before, however in variable lengths | | | | | |
| | 37 | | FLK 50-EZ-DR-D37SUB-X81-I/... | 2302683 | 1 |

Ordering data

| Description | Order No. | Pcs. / Pkt. |
|---------------------------------------|-----------|-------------|
| CABLE-D37-M2,5/4X14/ 50/Y81P-O | 2302476 | 1 |
| CABLE-D37-M2,5/4X14/100/Y81P-O | 2302489 | 1 |
| CABLE-D37-M2,5/4X14/200/Y81P-O | 2302492 | 1 |
| CABLE-D37-M2,5/4X14/300/Y81P-O | 2302502 | 1 |
| CABLE-D37-M2,5-4X14-Y81P-O/... | 2302696 | 1 |
| CABLE-D37-M2,5/4X14/ 50/X81-I | 2302515 | 1 |
| CABLE-D37-M2,5/4X14/100/X81-I | 2302528 | 1 |
| CABLE-D37-M2,5/4X14/200/X81-I | 2302531 | 1 |
| CABLE-D37-M2,5/4X14/300/X81-I | 2302544 | 1 |
| CABLE-D37-M2,5-4X14-X81-I/... | 2302706 | 1 |

Ordering example for system cable:

– Cable for MELSEC Q Y81P, 12.75 m long

Quantity Order No. Length [m]¹⁾

| | | |
|---|---------|-------|
| 1 | 2302625 | 12.75 |
|---|---------|-------|

¹⁾ min. 0.20 m

Ordering example for splitting cable:

– Cable for MELSEC Q Y81P, 11.00 m long

Quantity Order No. Length [m]¹⁾

| | | |
|---|---------|-------|
| 1 | 2302696 | 11.00 |
|---|---------|-------|

¹⁾ min. 0.20 m

Mitsubishi Electric MELSEC L/Q and Honeywell ML 200 System cables

These system cables are plugged onto the I/O cards that are connected using Fujitsu plug-in connectors.

CABLE-FCN40/1X50/...

– Signal transmission of 32 channels

CABLE-FCN40/4X14/...

– Splitting up 32 channels into
4 x 8 channels

Notes:

Suitable system cabling components can be configured in the INTERFACE search wizard. See www.phoenixcontact.net/products



Fujitsu FCN plug-in connector to flat-ribbon cable, number of positions: 40 on 50



Fujitsu plug-in connector to flat-ribbon cable, number of positions: 40 on 4 x 14

Technical data

Max. perm. operating voltage
Max. perm. current carrying capacity per path
Max. conductor resistance
Ambient temperature (operation)
Conductor cross section
Conductor structure: stranded wires / material

< 50 V AC / 60 V DC
1 A
0.16 Ω/m
-20°C ... 50°C
AWG 26 / 0.14 mm²
7 / Cu tin-plated

Technical data

< 50 V AC / 60 V DC
1 A
0.16 Ω/m
-20°C ... 50°C
AWG 26 / 0.14 mm²
7 / Cu tin-plated

Ordering data

| Description | No. of pos. | Cable length |
|-------------|-------------|--------------|
|-------------|-------------|--------------|

Round cable in variable lengths for
Mitsubishi Melsec L
LX41C4, LX42C4 (common positive connection to B01, B02)
LY41NT1P, LY42NT1P, LY41PT1P, LY42PT1P
Mitsubishi Melsec Q
QX41, QX41-S1, QX42, QX42-S1
QX71 and QX72 (common positive connection to B01, B02)
QY41P, QY42P, QY71, QH42P

| Description | No. of pos. | Cable length |
|---|-------------|--------------|
| Honeywell ML 200 2MLQ-TR4A, 2MLQ-TR8A, 2MLQ-TR4B, 2MLQ-TR8B | 40 | 0.5 m |
| | 40 | 1 m |
| | 40 | 2 m |
| | 40 | 3 m |
| | 40 | 4 m |
| | 40 | 6 m |
| | 40 | 8 m |
| | 40 | 10 m |

Round cable in variable lengths for
Mitsubishi Melsec L
LX41C4 and LX42C4 (common negative connection to B01, B02)
Mitsubishi Melsec Q
QX71 and QX72 (common negative connection to B01, B02)
QX82, QX82-S1
Honeywell ML 200
2MLI-D24A, 2MLI-D28B, 2MLF-SOEA
(common negative connection to B01, B02)

| Description | No. of pos. | Cable length |
|-------------|-------------|--------------|
| | 40 | 0.5 m |
| | 40 | 1 m |
| | 40 | 2 m |
| | 40 | 3 m |
| | 40 | 4 m |
| | 40 | 6 m |
| | 40 | 8 m |
| | 40 | 10 m |

Round cable in variable lengths for
Mitsubishi Melsec L
LX41C4 and LX42C4 (common positive connection to B01, B02)
LY41NT1P, LY42NT1P, LY41PT1P, LY42PT1P
Mitsubishi Melsec Q
QX41, QX41-S1, QX42, QX42-S1
QY41P (24 V), QY42P (24 V), QH42P (24 V)
Honeywell ML 200
2MLQ-TR4A, 2MLQ-TR8A, 2MLQ-TR4B, 2MLQ-TR8B

| Description | No. of pos. | Cable length |
|-------------|-------------|--------------|
| | 40 | 0.5 m |
| | 40 | 1 m |
| | 40 | 2 m |
| | 40 | 3 m |
| | 40 | 4 m |
| | 40 | 6 m |
| | 40 | 8 m |
| | 40 | 10 m |

| Type | Order No. | Pcs. / Pkt. |
|------|-----------|-------------|
|------|-----------|-------------|

| | | |
|-------------------------------|---------|---|
| CABLE-FCN40/1X50/ 0,5M/IM/MEL | 2903468 | 1 |
| CABLE-FCN40/1X50/ 1,0M/IM/MEL | 2903469 | 1 |
| CABLE-FCN40/1X50/ 2,0M/IM/MEL | 2903470 | 1 |
| CABLE-FCN40/1X50/ 3,0M/IM/MEL | 2903471 | 1 |
| CABLE-FCN40/1X50/ 4,0M/IM/MEL | 2903472 | 1 |
| CABLE-FCN40/1X50/ 6,0M/IM/MEL | 2903473 | 1 |
| CABLE-FCN40/1X50/ 8,0M/IM/MEL | 2903474 | 1 |
| CABLE-FCN40/1X50/10,0M/IM/MEL | 2903475 | 1 |

| Type | Order No. | Pcs. / Pkt. |
|------|-----------|-------------|
|------|-----------|-------------|

| | | |
|-------------------------------|---------|---|
| CABLE-FCN40/1X50/ 0,5M/IP/MEL | 2903476 | 1 |
| CABLE-FCN40/1X50/ 1,0M/IP/MEL | 2903477 | 1 |
| CABLE-FCN40/1X50/ 2,0M/IP/MEL | 2903478 | 1 |
| CABLE-FCN40/1X50/ 3,0M/IP/MEL | 2903479 | 1 |
| CABLE-FCN40/1X50/ 4,0M/IP/MEL | 2903480 | 1 |
| CABLE-FCN40/1X50/ 6,0M/IP/MEL | 2903481 | 1 |
| CABLE-FCN40/1X50/ 8,0M/IP/MEL | 2903482 | 1 |
| CABLE-FCN40/1X50/10,0M/IP/MEL | 2903483 | 1 |
| CABLE-FCN40/4X14/ 0,5M/IM/MEL | 2903502 | 1 |
| CABLE-FCN40/4X14/ 1,0M/IM/MEL | 2903503 | 1 |
| CABLE-FCN40/4X14/ 2,0M/IM/MEL | 2903504 | 1 |
| CABLE-FCN40/4X14/ 3,0M/IM/MEL | 2903505 | 1 |
| CABLE-FCN40/4X14/ 4,0M/IM/MEL | 2903506 | 1 |
| CABLE-FCN40/4X14/ 6,0M/IM/MEL | 2903507 | 1 |
| CABLE-FCN40/4X14/ 8,0M/IM/MEL | 2903508 | 1 |
| CABLE-FCN40/4X14/10,0M/IM/MEL | 2903509 | 1 |

System cabling for controllers

VARIOFACE system cabling

OMRON CJ1, CS1, CQM1, and C200H System cable

These system cables are plugged onto the I/O cards that are connected using Fujitsu plug-in connectors.

FLK 50/EZ-DR/...

– Signal transmission of 32 channels

CABLE-FCN40...

– Splitting up 32 channels into 4 x 8 channels

CABLE-FCN24...

– Splitting up 16 channels into 2 x 8 channels



Fujitsu FCN plug-in connector to flat-ribbon cable, number of positions: 40 on 50



Fujitsu FCN plug-in connector to flat-ribbon cable, number of positions: 40 on 4 x 14 or 24 on 2 x 14



Max. perm. operating voltage
Max. perm. current carrying capacity per path
Max. conductor resistance
Ambient temperature (operation)
Conductor cross section
Conductor structure: stranded wires / material

< 50 V AC / 60 V DC
1 A
0.16 Ω/m
-20°C ... 50°C
AWG 26 / 0.14 mm²
7 / Cu tin-plated

< 50 V AC / 60 V DC
1 A
0.16 Ω/m
-20°C ... 50°C
AWG 26 / 0.14 mm²
7 / Cu tin-plated

Technical data

Technical data

Ordering data

Ordering data

| Description | No. of pos. | Cable length |
|---|-------------|--------------|
| Round cable in variable lengths for CJ1: OD231, OD261 CS1, C200H: OD218, OD219 CQM1: OD213 | 40 | 1 m |
| | 40 | 2 m |
| Round cable , same as before, however in variable lengths | 40 | |
| Round cable in variable lengths for CJ1: ID231, ID261 CS1 and C200H: ID111, ID216, ID217, CQM1: ID213; ID214; ID112 | 40 | 1 m |
| | 40 | 2 m |
| Round cable , same as before, however in variable lengths | 40 | |
| Round cable in variable lengths for CS1, C200H: OD215, MD115 (only output), MD215 (only output) | 24 | 1 m |
| | 24 | 2 m |
| Round cable , same as before, however in variable lengths | 24 | |
| Round cable in variable lengths for CS1, C200H: ID215, MD115 (only input), MD215 (only input) | 24 | 1 m |
| | 24 | 2 m |
| Round cable , same as before, however in variable lengths | 24 | |

| Type | Order No. | Pcs. / Pkt. |
|--------------------------------|-----------|-------------|
| FLK 50/EZ-DR/FCN40/100/OMR-OUT | 2304144 | 1 |
| FLK 50/EZ-DR/FCN40/200/OMR-OUT | 2304157 | 1 |
| FLK 50-EZ-DR-FCN40-OMR-OUT/... | 2302829 | 1 |
| FLK 50/EZ-DR/FCN40/100/OMR-IN | 2304160 | 1 |
| FLK 50/EZ-DR/FCN40/200/OMR-IN | 2304173 | 1 |
| FLK 50-EZ-DR-FCN40-OMR-IN/... | 2302803 | 1 |

| Type | Order No. | Pcs. / Pkt. |
|------------------------------|-----------|-------------|
| CABLE-FCN40/4X14/100/OMR-OUT | 2304186 | 1 |
| CABLE-FCN40/4X14/200/OMR-OUT | 2304199 | 1 |
| CABLE-FCN40-4X14-OMR-OUT/... | 2302832 | 1 |
| CABLE-FCN40/4X14/100/OMR-IN | 2304209 | 1 |
| CABLE-FCN40/4X14/200/OMR-IN | 2304212 | 1 |
| CABLE-FCN40-4X14-OMR-IN/... | 2302816 | 1 |
| CABLE-FCN24/2X14/100/OMR-OUT | 2304225 | 1 |
| CABLE-FCN24/2X14/200/OMR-OUT | 2304238 | 1 |
| CABLE-FCN24-2X14-OMR-OUT/... | 2302858 | 1 |
| CABLE-FCN24/2X14/100/OMR-IN | 2304241 | 1 |
| CABLE-FCN24/2X14/200/OMR-IN | 2304254 | 1 |
| CABLE-FCN24-2X14-OMR-IN/... | 2302845 | 1 |

Ordering example for system cable:

– Cable for OMRON CJ1, ID231, 12.75 m long

Quantity Order No. Length [m]¹⁾

| | | |
|---|---------|-------|
| 1 | 2302803 | 12.75 |
|---|---------|-------|

¹⁾ min. 0.20 m

Phoenix Contact Axioline real-time I/O System cables

These cables have been specifically developed for connecting VARIOFACE termination boards to the Axioline realtime I/O system. The push-in technology on the I/O system ensures rapid connection.

The cables have the following features:

- 1:1 connection
- 14-pos. plug-in connector, molded
- 8 pre-assembled open ends, for connection to the Axioline realtime I/O system
- Transmission of groups of 8 channels
- Labeling field on plug

Perfectly-fitting VARIOFACE termination boards round off this system concept.

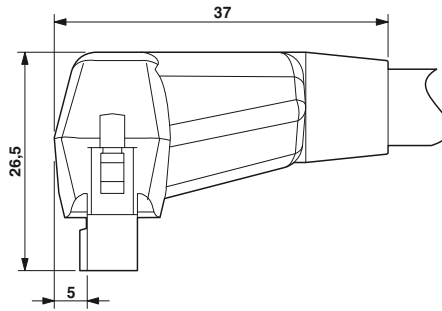

System cable for 8 channels

Notes:
 The following modules cannot be coupled due to the larger outer contour of the molded connectors:
 UM 45-FLK14/ 8IM/ZFKDS/PLC, 2965211
 UM 45- 8RM/MR-G24/1/PLC, 2962900

Max. perm. operating voltage
 Max. perm. current carrying capacity per path
 Max. conductor resistance
 Ambient temperature (operation)
 Assembly

Conductor cross section
 Conductor structure: stranded wires / material
 Outside diameter

14 -position

Technical data

< 50 V AC / 60 V DC
 1 A
 0.16 Ω/m
 -20°C ... 50°C
 Insulation displacement, IEC 60352-4/DIN EN 60352-4

AWG - / 0.14 mm²
 7 / Cu tin-plated

6.4 mm

Ordering data

| Description | No. of pos. | Cable length |
|--|-------------|--------------|
| Round cable with an open end (8 individual wires) | | |
| | 14 | 0.5 m |
| | 14 | 1 m |
| | 14 | 1.5 m |
| | 14 | 2 m |
| | 14 | 2.5 m |
| | 14 | 3 m |
| | 14 | 4 m |
| | 14 | 6 m |

| Type | Order No. | Pcs. / Pkt. |
|------------------------------|-----------|-------------|
| VIP-CAB-FLK14/AXIO/0,14/0,5M | 2901604 | 1 |
| VIP-CAB-FLK14/AXIO/0,14/1,0M | 2901605 | 1 |
| VIP-CAB-FLK14/AXIO/0,14/1,5M | 2901606 | 1 |
| VIP-CAB-FLK14/AXIO/0,14/2,0M | 2901607 | 1 |
| VIP-CAB-FLK14/AXIO/0,14/2,5M | 2901608 | 1 |
| VIP-CAB-FLK14/AXIO/0,14/3,0M | 2901609 | 1 |
| VIP-CAB-FLK14/AXIO/0,14/4,0M | 2901610 | 1 |
| VIP-CAB-FLK14/AXIO/0,14/6,0M | 2901611 | 1 |



System cabling for controllers

VARIOFACE system cabling

Phoenix Contact Inline Front adapters

The front adapters are used to connect pre-assembled system cables directly to In-line. Front adapters are simply plugged into the relevant Inline modules. Three connection options are available:

- Transfer of 8 channels via a 14-pos. system cable
 - Transmission of 2 x 8 channels over two 14-pos. system cables
 - Transmission of 4 x 8 channels over four 14-pos. system cables
- Perfectly-fitting VARIOFACE termination boards round off this system concept.

Notes:
Suitable system cabling components can be configured in the INTERFACE search wizard. See www.phoenixcontact.net/products



Front adapters for Inline



Max. perm. operating voltage
Max. permissible current
Ambient temperature (operation)
Ambient temperature (storage/transport)
Mounting position
Standards/regulations

< 50 V AC / 60 V DC
1 A (per path)
-20°C ... 50°C
-20°C ... 70°C
Any
IEC 60664 / IEC 60664 / IEC 60664

| Description | No. of pos. |
|---|-------------|
| VARIOFACE front adapter, for 8-channel Inline modules | |
| Input: IB IL 24 D 18/HD-PAC Output: IB IL 24 DO 8/HD-PAC | |
| VARIOFACE front adapter, for 16-channel Inline modules | |
| Input: IB IL 24 DI 16 Output: IB IL 24 DO 16 | |
| VARIOFACE front adapter, for 32-channel Inline modules | |
| Input: IB IL 24 DI 32/HD and Output: IB IL 24 DO 32/HD | |

Technical data

Ordering data

| Type | Order No. | Pcs. / Pkt. |
|--------------------------------|-----------|-------------|
| FLKM 14-PA-INLINE/DIO8 | 2900889 | 1 |
| FLKM 14-PA-INLINE/IN16 | 2302751 | 1 |
| FLKM 14-PA-INLINE/OUT16 | 2302764 | 1 |
| FLKM 14-PA-INLINE/32 | 2302777 | 1 |

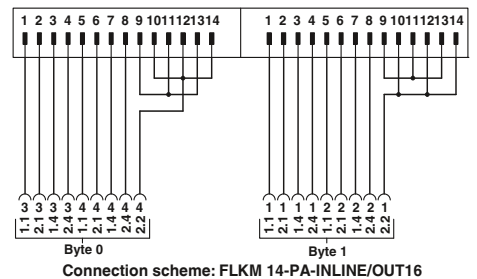
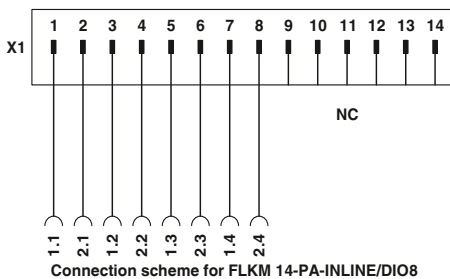

Explanation:

 Flat-ribbon cable strip
 Connection to I/O card
 Screw terminal blocks for separate supply

Schneider Electric MODICON® TSX Quantum Front adapter

The front adapters mean that pre-assembled system cables can be directly connected to I/O modules. There are two connection possibilities available:

- Transfer of max. 32 channels over one 50-pos. system cable
- Transmission of 4 x 8 channels over four 14-pos. system cables

Perfectly-fitting VARIOFACE termination boards with a variety of functions and connection possibilities round off this system concept.

Notes:

Suitable system cabling components can be configured in the INTERFACE search wizard. See www.phoenixcontact.net/products



Front adapter for MODICON TSX Quantum



Technical data

Max. perm. operating voltage
Max. permissible current

< 50 V AC / 60 V DC
1 A (per path)
4 A (per connection, supply via separate power supply)

Ambient temperature (operation)
Ambient temperature (storage/transport)
Mounting position
Standards/regulations

-20°C ... 50°C
-20°C ... 70°C
Any
DIN EN 50178 / DIN EN 50178 / DIN EN 50178

Ordering data

| Description | No. of pos. |
|---|-------------|
| VARIOFACE front adapter , for MODICON® TSX Quantum, 1 x 32 channels can be connected | 50 |
| VARIOFACE front adapter , for MODICON® TSX Quantum, 4 x 8 channels can be connected | 14 |

| Type | Order No. | Pcs. / Pkt. |
|--------------------------------|-----------|-------------|
| FLKM 50-PA-MODI-TSX/Q | 2294306 | 1 |
| FLKM 50/ 4-FLK14/PA-MODI-TSX/Q | 2294416 | 1 |

Front adapter for I/O modules of MODICON® TSX Quantum automation devices

| Card type | FLKM 50-PA-MODI-TSX/Q |
|-----------------------------|--|
| Digital input | DDI 353 DDI 841* DDI 853 DAI 340* DAI 353** DAI 440* DAI 453** |
| Digital output | DDO 353 |
| Digital input/output | DDM 390* |
| Analog input | ACI 030* ACI 040* ATI 030* ARI 030* AVI 030* |
| Analog output | ACO 020* ACO 130* AVO 020* |
| Analog input/output | AMM 090* |
| Counter | ECH 105* EHC 202* |

* Only in conjunction with VIP-2/SC/FLK50/MODI-TSX/Q, Order No. 2322304.

** Only in conjunction with passive termination boards without LED.

| Card type | FLKM 50/4-FLK14/PA-MODI-TSX/Q |
|-----------------------|--|
| Digital input | DDI 353 DDI 853 DAI 353** DAI 453** |
| Digital output | DDO 353 |

** Only in conjunction with passive termination boards without LED.

Explanation:

- Flat-ribbon cable strip
- Connection to I/O card
- Screw terminal blocks for separate supply

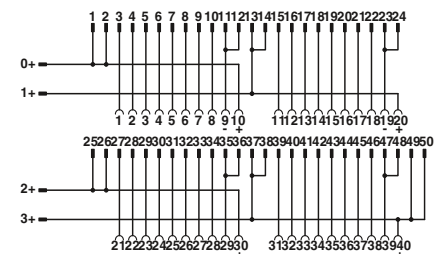

Connection scheme FLKM 50-PA-MODI-TSX/Q

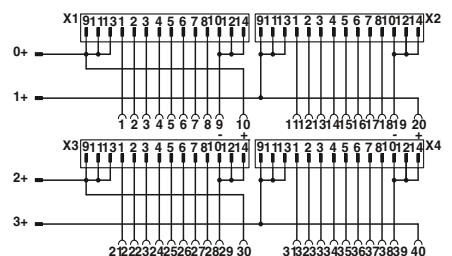

Connection scheme FLKM 50/ 4-FLK14/PA-MODI-TSX/Q

System cabling for controllers

VARIOFACE system cabling

Schneider Electric MODICON® M340 Front adapter

Pre-assembled system cables are connected directly to the 16-channel I/O modules using the front adapter. The adapters connect 2 x 8 channels of the controller via two 14-pos. system cables. Tailor-made VARIOFACE termination boards with a variety of functions and connection options are available for connection to field level and round off this system concept.



N

Front adapter for MODICON C340 series I/O modules

| Card type | FLKM 14-PA-MODI/M340 |
|----------------|--|
| Digital input | BMX DDI1602 BMX DDI1603 BMX DAI1602 BMX DAI1603 |
| Digital output | BMX DDO1602 BMX DDO1612 |

Assignment table

| Contacts of front adapter/ controller | Plug-in connector (byte 0) | Plug-in connector (byte 1) |
|---------------------------------------|----------------------------|----------------------------|
| 1 | 1 | |
| 2 | 2 | |
| 3 | 3 | |
| 4 | 4 | |
| 5 | 5 | |
| 6 | 6 | |
| 7 | 7 | |
| 8 | 8 | |
| 9 | | 1 |
| 10 | | 2 |
| 11 | | 3 |
| 12 | | 4 |
| 13 | | 5 |
| 14 | | 6 |
| 15 | | 7 |
| 16 | | 8 |
| 17 | 10, 12, 14 (-) | 10, 12, 14 (-) |
| 18 | 9, 11, 13 (+) | 9, 11, 13 (+) |
| 19 | 10, 12, 14 (-) | 10, 12, 14 (-) |
| 20 | 9, 11, 13 (+) | 9, 11, 13 (+) |

Max. perm. operating voltage
Max. permissible current
Max. perm. total current

Ambient temperature (operation)
Ambient temperature (storage/transport)
Mounting position
Standards/regulations

< 50 V AC / 60 V DC
1 A (per path)
3 A (Per system cable when supplying from the module side)
10 A (When supplying via the front adapter)

-20°C ... 60°C
-20°C ... 60°C
Any
DIN EN 50178

Technical data

Ordering data

| Description | No. of pos. |
|--|-------------|
| VARIOFACE front adapter, for MODICON® M340 with two FLK pin strips | 14 |

| Type | Order No. | Pcs. / Pkt. |
|----------------------|-----------|-------------|
| FLKM 14-PA-MODI/M340 | 2903208 | 1 |



Connection scheme FLKM 14-PA-MODI/M340

Schneider Electric MODICON® M340 System cable

These system cables are plugged onto the I/O cards that are connected using Fujitsu plug-in connectors.

CABLE-FCN40/1X50/...
– Signal transmission of 32 channels

CABLE-FCN40/4X14/...
– Splitting up 32 channels into 4 x 8 channels



Fujitsu FCN plug-in connector to flat-ribbon cable, number of positions: 40 on 50



Fujitsu FCN plug-in connector to flat-ribbon cable, number of positions: 40 on 4 x 14

Notes:
Suitable system cabling components can be configured in the INTERFACE search wizard. See www.phoenixcontact.net/products

| | | | Technical data | | | Technical data | | |
|---|-------------|--------------|-------------------------------|-----------|-------------|-------------------------------|-----------|-------------|
| Max. perm. operating voltage | | | < 50 V AC / 60 V DC | | | < 50 V AC / 60 V DC | | |
| Max. perm. current carrying capacity per path | | | 1 A | | | 1 A | | |
| Max. conductor resistance | | | 0.16 Ω/m | | | 0.16 Ω/m | | |
| Ambient temperature (operation) | | | -20°C ... 50°C | | | -20°C ... 50°C | | |
| Conductor cross section | | | AWG 26 / 0.14 mm ² | | | AWG 26 / 0.14 mm ² | | |
| Conductor structure: stranded wires / material | | | 7 / Cu tin-plated | | | 7 / Cu tin-plated | | |
| | | | Ordering data | | | Ordering data | | |
| Description | No. of pos. | Cable length | Type | Order No. | Pcs. / Pkt. | Type | Order No. | Pcs. / Pkt. |
| Round cable in variable lengths for BMX DDI 3202K, BMX DDI 6402K, BMX DD0 3202K, BMX DD0 6402K, BMX DDM 3202K | | | | | | | | |
| | 40 | 0,5 m | CABLE-FCN40/1X50/ 0,5M/M340 | 2321635 | 1 | CABLE-FCN40/4X14/ 0,5M/M340 | 2321716 | 1 |
| | 40 | 1 m | CABLE-FCN40/1X50/ 1,0M/M340 | 2321648 | 1 | CABLE-FCN40/4X14/ 1,0M/M340 | 2321729 | 1 |
| | 40 | 2 m | CABLE-FCN40/1X50/ 2,0M/M340 | 2321651 | 1 | CABLE-FCN40/4X14/ 2,0M/M340 | 2321732 | 1 |
| | 40 | 3 m | CABLE-FCN40/1X50/ 3,0M/M340 | 2321664 | 1 | CABLE-FCN40/4X14/ 3,0M/M340 | 2321745 | 1 |
| | 40 | 4 m | CABLE-FCN40/1X50/ 4,0M/M340 | 2321677 | 1 | CABLE-FCN40/4X14/ 4,0M/M340 | 2321758 | 1 |
| | 40 | 6 m | CABLE-FCN40/1X50/ 6,0M/M340 | 2321680 | 1 | CABLE-FCN40/4X14/ 6,0M/M340 | 2321761 | 1 |
| | 40 | 8 m | CABLE-FCN40/1X50/ 8,0M/M340 | 2321693 | 1 | CABLE-FCN40/4X14/ 8,0M/M340 | 2321774 | 1 |
| | 40 | 10 m | CABLE-FCN40/1X50/10,0M/M340 | 2321703 | 1 | CABLE-FCN40/4X14/10,0M/M340 | 2321787 | 1 |
| | 40 | 15 m | CABLE-FCN40/1X50/15,0M/M340 | 2903748 | 1 | CABLE-FCN40/4X14/15,0M/M340 | 2903749 | 1 |

System cabling for controllers

VARIOFACE system cabling

VIP – VARIOFACE Professional front adapters for SIMATIC S7-300

Three connection options are available:

- Transfer of max. 32 channels via two 50-pos. system cables (32-channel cards or this design)
- Transfer of 4 x 8 channels via two 14-pos. system cables (32-channel cards or this design)
- Transfer of 2 x 8 channels via two 14-pos. system cables (16-channel cards or this design)

The front adapters have the following features:

- Can be screwed with I/O module
- Voltage supply via terminal blocks with spring-cage double connection
- Encapsulated socket strips for module side
Special lengths can be configured using separate order numbers.

Ordering example:

A front adapter with a connected 50-pos. system cable (32-channel cards), 12.75 m in length:

1 pcs. 2900885/12,75

| Notes: |
|---|
| The following modules cannot be coupled due to the larger outer contour of the molded connectors: UM 45-FLK14/ 8IM/ZFKDS/PLC, 2965211 UM 45-FLK50/32IM/ZFKDS/PLC, 2965224 UM 45- 8RM/MR-G24/1/PLC, 2962900 UM 45-16RM/MR-G24/1/PLC, 2962913 |
| Suitable system cabling components can be configured in the INTERFACE search wizard. See www.phoenixcontact.net/products |

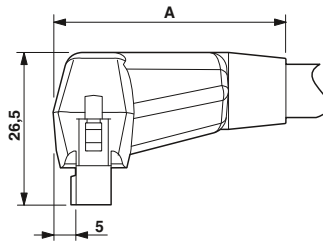

| | A |
|-------------|----|
| ...FLK14... | 37 |
| ...FLK50... | 42 |



Front adapter with system cable
1 x 32 channels can be connected

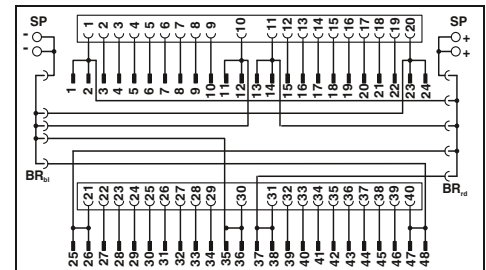

Technical data

| | |
|--|---|
| Max. perm. operating voltage | < 50 V AC / 60 V DC |
| Max. perm. current carrying capacity per path | 1 A (per path) |
| Max. perm. current (separate power supply) | 8 A |
| Rated surge voltage | 0.8 kV |
| Max. conductor resistance | 0.16 Ω/m |
| Conductor cross section | AWG 26 / 0.14 mm ² |
| Conductor structure: stranded wires / material | 7 / Cu tin-plated |
| Outside diameter | 10.3 mm |
| Ambient temperature range | -20°C ... 50°C |
| Standards/regulations | IEC 60664, IEC 62103, DIN EN 50178 |
| Connection method | Front adapter: Can be plugged onto 40-pos. I/O modules / separate power supply through terminal blocks with spring-cage double connection |
| | System cable: Flat-ribbon cable plug-in connector according to IEC 60603-13 |
| Connection data solid / stranded / AWG | 0.2 ... 2.5 mm ² / 0.2 ... 2.5 mm ² / 24 - 14 |

Ordering data

| Description | Cable length | Type | Order No. | Pcs. / Pkt. |
|--|--------------|-----------------------|-----------|-------------|
| VIP VARIOFACE front adapter, with connected system cables for SIMATIC S7 300 | 0.5 m | VIP-PA-FLK50/ 0,5M/S7 | 2322443 | 1 |
| | 1 m | VIP-PA-FLK50/ 1,0M/S7 | 2322456 | 1 |
| | 1.5 m | VIP-PA-FLK50/ 1,5M/S7 | 2322469 | 1 |
| | 2 m | VIP-PA-FLK50/ 2,0M/S7 | 2321800 | 1 |
| | 2.5 m | VIP-PA-FLK50/ 2,5M/S7 | 2322472 | 1 |
| | 3 m | VIP-PA-FLK50/ 3,0M/S7 | 2322485 | 1 |
| | 4 m | VIP-PA-FLK50/ 4,0M/S7 | 2322498 | 1 |
| | 5 m | VIP-PA-FLK50/ 5,0M/S7 | 2322508 | 1 |
| | 6 m | VIP-PA-FLK50/ 6,0M/S7 | 2322511 | 1 |
| | 7 m | VIP-PA-FLK50/ 7,0M/S7 | 2322524 | 1 |
| | 8 m | VIP-PA-FLK50/ 8,0M/S7 | 2322537 | 1 |
| | 10 m | VIP-PA-FLK50/10,0M/S7 | 2322540 | 1 |
| VIP VARIOFACE front adapter, as above, in variable lengths | | VIP-PA-FLK50-S7/... | 2900885 | 1 |



Front adapter with system cable
4 x 8 channels can be connected



Front adapter with system cable
2 x 8 channels can be connected

Front adapter for 32-channel cards of
SIMATIC® S7-300

| Card type | VIP-PA-FLK50/...M/S7 |
|----------------------|--|
| Digital input | 6ES7 321-1BL00-0AA0 |
| Digital output | 6ES7 322-1BL00-0AA0 |
| Digital input/output | 6ES7 323-1BL00-0AA0 |
| Analog input | 6ES7 331-7PF01-0AB0* 6ES7 331-7PF11-0AB0* 6ES7 331-7NF00-0AB0* 6ES7 331-7NF10-0AB0* 6ES7 331-1KF01-0AB0* |
| Analog output | 6ES7 332-5HF00-0AB0* |
| CPU | 312C, 313C, 314C, 313C-2PiP 313C-2DP, 314C-2DP, 314C-2PiP |
| Other modules | 6ES7 350-2AH01-0AE0* 6ES7 357-4AH01-0AE0* |

| Card type | VIP-PA-FLK50/4X14/...M/S7 |
|----------------------|--|
| Digital input | 6ES7 321-1BL00-0AA0 |
| Digital output | 6ES7 322-1BL00-0AA0 |
| Digital input/output | 6ES7 323-1BL00-0AA0 |
| CPU | 313C, 314C, 313C-2PiP 313C-2DP, 314C-2DP, 314C-2PiP |

* Only in conjunction with
VIP-2/SC/FLK50 (1-40)/S7, Order No.: 2315243,
UM 45-FLK50/ZFKDS/S7-300, Order No.: 2968111,
FLKM 50/KDS3-MT/PPA/S7-300, Order No.: 2304490.
All bridges (BR) at the adapter must be removed!

Front adapter for 16-channel cards of
SIMATIC® S7-300

| Card type | VIP-PA-FLK14/...M/S7 |
|----------------------|--|
| Digital input | 6ES7 321-1BH02-0AA0 6ES7 321-1BH10-0AA0 6ES7 321-1BH50-0AA0* 6ES7 321-7BH01-0AB0* |
| Digital output | 6ES7 322-1BH01-0AA0 6ES7 322-1BH10-0AA0 6ES7 322-8BF00-0AB0* |
| Digital input/output | 6ES7 323-1BH01-0AA0 |
| Analog input | 6ES7 331-7KF02-0AB0* 6ES7 331-7HF01-0AB0* 6ES7 331-7KB02-0AB0* 6ES7 331-7TF01-0AB0* |
| Analog output | 6ES7 332-5HD01-0AB0* 6ES7 332-5HB01-0AB0* 6ES7 332-7ND02-0AB0* |
| Analog input/output | 6ES7 334-0CE01-0AA0* 6ES7 334-0KE00-0AB0* 6ES7 335-7HG01-0AB0* |
| Other modules | 6ES7 338-4BC01-0AB0* 6ES7 350-1AH03-0AE0* 6ES7 351-1AH01-0AE0* 6ES7 352-1AH02-0AE0* 6ES7 353-1AH01-0AE0* 6ES7 354-1AH01-0AE0* 6ES7 355-0VH10-0AE0* 6ES7 355-1VH10-0AE0* |

* Only in conjunction with
IP-2/SC/2FLK14 (1-20)/S7, Order No.: 2315230
UM 45-2FLK14/ZFKDS/S7, Order No.: 2965156
FLKM-2FLK14/KDS 3-MT/PPA/S7, Order No.: 2295062
All bridges (BR) on the adapter must be disconnected.

Note:
The front adapters are non-isolated on delivery.
Removal of the bridges can achieve electrical isolation
(in groups of 8).

Explanation:

 Flat-ribbon cable strip
 Connection to I/O card

SP: Separate power terminals
BRbl: Blue plug-in bridge
BRrd: Red plug-in bridge

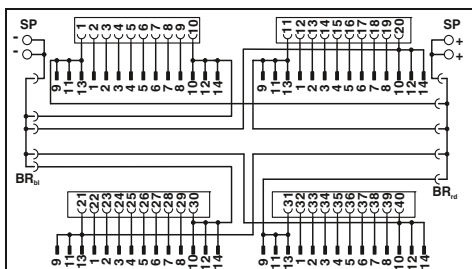

Technical data

< 50 V AC / 60 V DC
1 A (per path)
8 A

0.8 kV
0.16 Ω/m
AWG 26 / 0.14 mm²
7 / Cu tin-plated
6.4 mm
-20°C ... 50°C
IEC 60664, IEC 62103, DIN EN 50178
Can be plugged onto 40-pos. I/O modules / separate power supply
through terminal blocks with spring-cage double connection

Flat-ribbon cable plug-in connector according to IEC 60603-13

0.2 ... 2.5 mm² / 0.2 ... 2.5 mm² / 24 - 14

Ordering data

| Type | Order No. | Pcs. / Pkt. |
|----------------------------|-----------|-------------|
| VIP-PA-FLK50/4X14/ 0,5M/S7 | 2322553 | 1 |
| VIP-PA-FLK50/4X14/ 1,0M/S7 | 2322566 | 1 |
| VIP-PA-FLK50/4X14/ 1,5M/S7 | 2322579 | 1 |
| VIP-PA-FLK50/4X14/ 2,0M/S7 | 2321910 | 1 |
| VIP-PA-FLK50/4X14/ 2,5M/S7 | 2322582 | 1 |
| VIP-PA-FLK50/4X14/ 3,0M/S7 | 2322595 | 1 |
| VIP-PA-FLK50/4X14/ 4,0M/S7 | 2322605 | 1 |
| VIP-PA-FLK50/4X14/ 5,0M/S7 | 2322618 | 1 |
| VIP-PA-FLK50/4X14/ 6,0M/S7 | 2322621 | 1 |
| VIP-PA-FLK50/4X14/ 7,0M/S7 | 2322634 | 1 |
| VIP-PA-FLK50/4X14/ 8,0M/S7 | 2322647 | 1 |
| VIP-PA-FLK50/4X14/10,0M/S7 | 2322650 | 1 |
| VIP-PA-FLK50-4X14-S7/... | 2900886 | 1 |

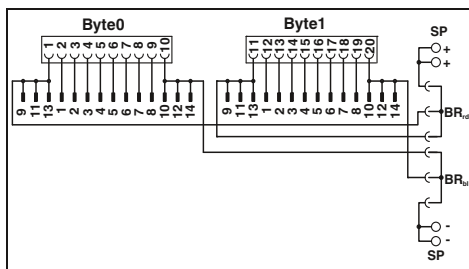

Technical data

< 50 V AC / 60 V DC
1 A (per path)
8 A

0.8 kV
0.16 Ω/m
AWG 26 / 0.14 mm²
7 / Cu tin-plated
6.4 mm
-20°C ... 50°C
IEC 60664, IEC 62103, DIN EN 50178
Can be plugged onto 20-pos. I/O modules / separate power supply
through terminal blocks with spring-cage double connection

Flat-ribbon cable plug-in connector according to IEC 60603-13

0.2 ... 2.5 mm² / 0.2 ... 2.5 mm² / 24 - 14

Ordering data

| Type | Order No. | Pcs. / Pkt. |
|-----------------------|-----------|-------------|
| VIP-PA-FLK14/ 0,5M/S7 | 2322663 | 1 |
| VIP-PA-FLK14/ 1,0M/S7 | 2322676 | 1 |
| VIP-PA-FLK14/ 1,5M/S7 | 2322689 | 1 |
| VIP-PA-FLK14/ 2,0M/S7 | 2321790 | 1 |
| VIP-PA-FLK14/ 2,5M/S7 | 2322692 | 1 |
| VIP-PA-FLK14/ 3,0M/S7 | 2322702 | 1 |
| VIP-PA-FLK14/ 4,0M/S7 | 2322715 | 1 |
| VIP-PA-FLK14/ 5,0M/S7 | 2322728 | 1 |
| VIP-PA-FLK14/ 6,0M/S7 | 2322731 | 1 |
| VIP-PA-FLK14/ 7,0M/S7 | 2322744 | 1 |
| VIP-PA-FLK14/ 8,0M/S7 | 2322757 | 1 |
| VIP-PA-FLK14/10,0M/S7 | 2322760 | 1 |
| VIP-PA-FLK14-S7/... | 2900887 | 1 |

System cabling for controllers

VARIOFACE system cabling

Siemens SIMATIC® S7-300 Front adapter

I/O modules with 32 channels or with this design

There are two connection possibilities available:

- Transfer of max. 32 channels over one 50-pos. system cable
- Transmission of 4 x 8 channels over four 14-pos. system cables

Perfectly-fitting VARIOFACE termination boards with a variety of functions and connection possibilities round off this system concept.

Notes:

Suitable system cabling components can be configured in the INTERFACE search wizard. See www.phoenixcontact.net/products



Front adapter for SIMATIC® S7-300, I/O cards with max. 32 channels



Technical data

Max. perm. operating voltage
Max. permissible current

< 50 V AC / 60 V DC
1 A (per path)
8 A (per connection, supply via separate power supply (2.8 x 0.8 mm))

Max. perm. total current

2 A (Per Byte, for supply via connector)
8 A (during supply via a separate bridged power supply)

Ambient temperature (operation)
Ambient temperature (storage/transport)
Standards/regulations
Connection method

-20°C ... 50°C
-20°C ... 70°C
IEC 60664 / IEC 60664 / IEC 60664
IDC/FLK pin strip (2.54 mm)

Ordering data

| Description | No. of pos. |
|--|-------------|
| VARIOFACE front adapters, for SIMATIC® S7-300 | |
| - 1 x 32 channels can be connected | 50 |
| - 4 x 8 channels can be connected | 14 |

| Type | Order No. | Pcs. / Pkt. |
|--------------------------------|----------------|-------------|
| FLKM 50-PA-S300 | 2294445 | 1 |
| FLKM 50/4-FLK14/PA-S300 | 2296281 | 1 |

Front adapter for 32-channel cards of SIMATIC® S7-300

| Card type | FLKM 50-PA-S300 |
|----------------------|--|
| Digital input | 6ES7 321-1BL00-0AA0 |
| Digital output | 6ES7 322-1BL00-0AA0 |
| Digital input/output | 6ES7 323-1BL00-0AA0 |
| Analog input | 6ES7 331-7PF01-0AB0* 6ES7 331-7PF11-0AB0* 6ES7 331-7NF00-0AB0* 6ES7 331-7NF10-0AB0* 6ES7 331-1KF01-0AB0* |
| Analog output | 6ES7 332-5HF00-0AB0* |
| CPU | 312C, 313C, 314C, 313C-2PiP 313C-2DP, 314C-2DP, 314C-2PiP |
| Other modules | 6ES7 350-2AH01-0AE0* 6ES7 357-4AH01-0AE0* |

| Card type | FLKM 50/4-FLK14/PA-S300 |
|----------------------|--|
| Digital input | 6ES7 321-1BL00-0AA0 |
| Digital output | 6ES7 322-1BL00-0AA0 |
| Digital input/output | 6ES7 323-1BL00-0AA0 |
| CPU | 313C, 314C, 313C-2PiP 313C-2DP, 314C-2DP, 314C-2PiP |

* Only in conjunction with
VIP-2/SC/FLK50 (1-40)/S7, Order No.: 2315243,
UM 45-FLK50/ZFKDS/S7-300, Order No.: 2968111,
FLKM 50/KDS3-MT/PPA/S7-300, Order No.: 2304490.
All wire bridges (DR) on the adapter must be disconnected!
There must be no voltage supply at the front adapter (flowing via the slip-on connections)!

Note:

The front adapters are non-isolated on delivery. Removal of the bridges can achieve electrical isolation (in groups of 8).

Explanation:

- Flat-ribbon cable strip
- Connection to I/O card
- Screw terminal blocks for separate supply

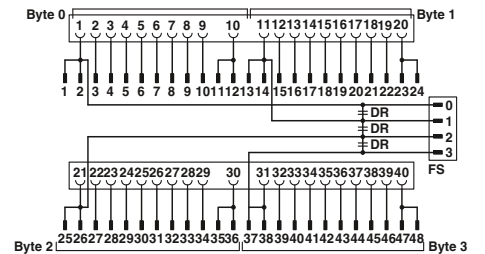

Connection scheme FLKM 50-PA-S300

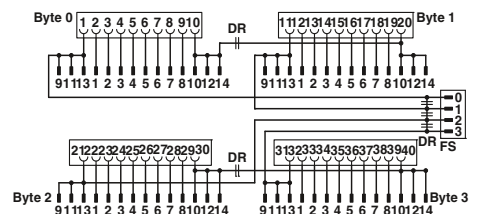

Connection scheme FLKM 50/4-FLK14/PA-S300

Siemens SIMATIC® S7-300
Front adapter

I/O modules with 16 channels or with this design

– Up to 2 x 8 channels are connected via two 14-pos. system cables.

Perfectly-fitting VARIOFACE termination boards with a variety of functions and connection possibilities round off this system concept.

Notes:
Suitable system cabling components can be configured in the INTERFACE search wizard. See www.phoenixcontact.net/products



Front adapter for SIMATIC® S7-300, I/O cards with max. 16 channels



Technical data

| | |
|---|---|
| Max. perm. operating voltage | < 50 V AC / 60 V DC |
| Max. permissible current | 1 A (per path) 8 A (per connection, supply via separate power supply (2.8 x 0.8 mm)) |
| Max. perm. total current | 2 A (Per Byte, for supply via connector) 8 A (during supply via a separate bridged power supply) |
| Ambient temperature (operation) | -20°C ... 50°C |
| Ambient temperature (storage/transport) | -20°C ... 70°C |
| Standards/regulations | IEC 60664 / IEC 60664 / IEC 60664 |
| Connection method | IDC/FLK pin strip (2.54 mm) |

Ordering data

| Description | No. of pos. | Type | Order No. | Pcs. / Pkt. |
|--|-------------|------------------------|----------------|-------------|
| VARIOFACE front adapters, for SIMATIC® S7-300 | | | | |
| - 2 x 8 channels can be connected | 14 | FLKM 14-PA-S300 | 2299770 | 1 |

Front adapter for 16-channel cards of SIMATIC® S7-300

| Card type | FLKM 14-PA-S300 |
|-----------------------------|--|
| Digital input | 6ES7 321-1BH02-0AA0 6ES7 321-1BH10-0AA0 6ES7 321-1BH50-0AA0* 6ES7 321-7BH01-0AB0* |
| Digital output | 6ES7 322-1BH01-0AA0 6ES7 322-1BH10-0AA0 6ES7 322-6BF00-0AB0* |
| Digital input/output | 6ES7 323-1BH01-0AA0 |
| Analog input | 6ES7 331-7KF02-0AB0* 6ES7 331-7HF01-0AB0* 6ES7 331-7KB02-0AB0* 6ES7 331-7TF01-0AB0* |
| Analog output | 6ES7 332-5HD01-0AB0* 6ES7 332-5HB01-0AB0* 6ES7 332-7ND02-0AB0* |
| Analog input/output | 6ES7 334-0CE01-0AA0* 6ES7 334-0KE00-0AB0* 6ES7 335-7HG01-0AB0* |
| Other modules | 6ES7 338-4BC01-0AB0* 6ES7 350-1AH03-0AE0* 6ES7 351-1AH01-0AE0* 6ES7 352-1AH02-0AE0* 6ES7 353-1AH01-0AE0* 6ES7 354-1AH01-0AE0* 6ES7 355-0VH10-0AE0* 6ES7 355-1VH10-0AE0* |

* Only in conjunction with
VIP-2/SC/2FLK14 (1-20)/S7, Order No.: 2315230
UM 45-2FLK14/ZFKDS/S7, Order No.: 2965156
FLKM-2FLK14/KDS 3-MT/PPA/S7, Order No.: 2295062
All wire bridges (DR) on the adapter must be disconnected.
There must be no voltage supply at the front adapter (flowing via the slip-on connections)!

Note:
The front adapters are non-isolated on delivery.
Removal of the bridges can achieve electrical isolation (in groups of 8).

Explanation:

 Flat-ribbon cable strip
 Connection to I/O card
 Screw terminal blocks for separate supply



Connection scheme FLKM 14-PA-S300

System cabling for controllers

VARIOFACE system cabling

Siemens SIMATIC® S7-300 Front adapter for failsafe modules

The front adapters are coupled using 50-pos. system cables and convert the signals for passive modules.



Siemens SIMATIC S7-300 front adapter for failsafe I/O cards

Technical data

| | |
|---|---|
| Max. perm. operating voltage | 30 V DC |
| Max. permissible current | 1 A (per path) |
| Max. perm. total current | 2 A |
| Ambient temperature (operation) | -20°C ... 50°C |
| Ambient temperature (storage/transport) | -20°C ... 70°C |
| Standards/regulations | EN 50178 |
| Connection method | Flat-ribbon cable plug-in connector according to IEC 60603-13 |

Ordering data

| Description | No. of pos. | Type | Order No. | Pcs. / Pkt. |
|---|-------------|-------------------------|-----------|-------------|
| VARIOFACE front adapter for failsafe I/O cards | | | | |
| 6ES7 326-1BK02-0AB0 6ES7 326-1RF00-0AB0 6ES7 336-1HE00-0AB0 | 50 | FLKM 50-PA-S300/SO167 | 2307662 | 1 |
| VARIOFACE front adapter for failsafe I/O cards | | | | |
| 6ES7 326-2BF01-0AB0 | 50 | FLKM 50-PA/DO326/S7-300 | 2321952 | 1 |

Front adapter for I/O modules of SIMATIC® S7-300

| Card type | FLKM 50-PA-S300/SO167 |
|----------------|--|
| Digital input | 6ES7 326-1BK02-0AB0* 6ES7 326-1RF00-0AB0**) |
| Analog input | 6ES7 336-1HE00-0AB0* |
| Card type | FLKM 50-PA/DO326/S7-300 |
| Digital output | 6ES7 326-2BF01-0AB0** 6ES7 326-2BF10-0AB0** |

* Only in conjunction with
VIP-2/SC/FLK50 (1-40)/S7, Order No. 2315243,
UM 45-FLK50/ZFKDS/S7-300, Order No. 2968111,
FLKM 50/KDS3-MT/PPA/S7-300, Order No. 2304490.

** Only in conjunction with
FLKM 50/DO326/S7-300, Order No. 2321965.

1) Not suitable for signals from the Ex area.

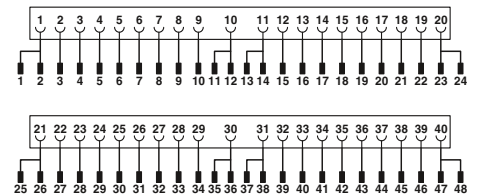

Connection scheme FLKM 50-PA-S300/SO167

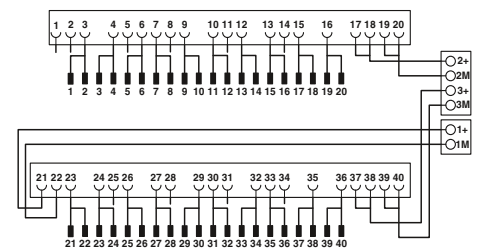

Connection scheme FLKM 50-PA/DO326/S7-300

Explanation:

- Flat-ribbon cable strip
- Connection to I/O card
- Screw terminal blocks for separate supply

Siemens SIMATIC S7 -300
System cables for 64-channel I/O cards

These system cables are plugged onto the 64-channel (2x32) I/O cards that are directly connected using plug-in connectors.

CABLE-FCN40/1X50/...

- Signal transmission of 1 x 32 channels
- System cable: 40-pos. plug-in connector on 50-pos. flat-ribbon cable strip

CABLE-FCN40/4X14/...

- Signal transmission of 4 x 8 channels
- Splitting cable: 40-pos. plug-in connector on four 14-pos. flat-ribbon cable strips



System cable



Splitting cable

Max. perm. operating voltage
 Max. perm. current carrying capacity per path
 Max. conductor resistance
 Ambient temperature (operation)
 Conductor cross section
 Conductor structure: stranded wires / material

| Technical data | |
|-------------------------------|--|
| < 50 V AC / 60 V DC | |
| 1 A | |
| 0.16 Ω/m | |
| -20°C ... 50°C | |
| AWG 26 / 0.14 mm ² | |
| 7 / Cu tin-plated | |

| Technical data | |
|-------------------------------|--|
| < 50 V AC / 60 V DC | |
| 1 A | |
| 0.16 Ω/m | |
| -20°C ... 50°C | |
| AWG 26 / 0.14 mm ² | |
| 7 / Cu tin-plated | |

| Description | No. of pos. | Cable length |
|---|-------------|--------------|
| Round cable, for output module 6ES7 322-1BP00-0AA0 and 6ES7 322-1BP50-0AA0 (two cables per module) | | |
| | 40 | 0.5 m |
| | 40 | 1 m |
| | 40 | 2 m |
| | 40 | 3 m |
| | 40 | 4 m |
| | 40 | 6 m |
| | 40 | 8 m |
| | 40 | 10 m |
| Round cable, for input module 6ES7 321-1BP00-0AA0 (two cables per module). Plus-reading operation (sinking mode) of the module | | |
| | 40 | 0.5 m |
| | 40 | 1 m |
| | 40 | 2 m |
| | 40 | 3 m |
| | 40 | 4 m |
| | 40 | 6 m |
| | 40 | 8 m |
| | 40 | 10 m |

| Ordering data | | |
|-------------------------------|-----------|-------------|
| Type | Order No. | Pcs. / Pkt. |
| CABLE-FCN40/1X50/ 0,5M/S7-OUT | 2321017 | 1 |
| CABLE-FCN40/1X50/ 1,0M/S7-OUT | 2321020 | 1 |
| CABLE-FCN40/1X50/ 2,0M/S7-OUT | 2321033 | 1 |
| CABLE-FCN40/1X50/ 3,0M/S7-OUT | 2321046 | 1 |
| CABLE-FCN40/1X50/ 4,0M/S7-OUT | 2321059 | 1 |
| CABLE-FCN40/1X50/ 6,0M/S7-OUT | 2321062 | 1 |
| CABLE-FCN40/1X50/ 8,0M/S7-OUT | 2321075 | 1 |
| CABLE-FCN40/1X50/10,0M/S7-OUT | 2321088 | 1 |
| CABLE-FCN40/1X50/ 0,5M/S7-IN | 2321091 | 1 |
| CABLE-FCN40/1X50/ 1,0M/S7-IN | 2321101 | 1 |
| CABLE-FCN40/1X50/ 2,0M/S7-IN | 2321114 | 1 |
| CABLE-FCN40/1X50/ 3,0M/S7-IN | 2321127 | 1 |
| CABLE-FCN40/1X50/ 4,0M/S7-IN | 2321130 | 1 |
| CABLE-FCN40/1X50/ 6,0M/S7-IN | 2321143 | 1 |
| CABLE-FCN40/1X50/ 8,0M/S7-IN | 2321156 | 1 |
| CABLE-FCN40/1X50/10,0M/S7-IN | 2321169 | 1 |

| Ordering data | | |
|-------------------------------|-----------|-------------|
| Type | Order No. | Pcs. / Pkt. |
| CABLE-FCN40/4X14/ 0,5M/S7-OUT | 2321172 | 1 |
| CABLE-FCN40/4X14/ 1,0M/S7-OUT | 2321185 | 1 |
| CABLE-FCN40/4X14/ 2,0M/S7-OUT | 2321198 | 1 |
| CABLE-FCN40/4X14/ 3,0M/S7-OUT | 2321208 | 1 |
| CABLE-FCN40/4X14/ 4,0M/S7-OUT | 2321211 | 1 |
| CABLE-FCN40/4X14/ 6,0M/S7-OUT | 2321224 | 1 |
| CABLE-FCN40/4X14/ 8,0M/S7-OUT | 2321237 | 1 |
| CABLE-FCN40/4X14/10,0M/S7-OUT | 2321240 | 1 |
| CABLE-FCN40/4X14/ 0,5M/S7-IN | 2321253 | 1 |
| CABLE-FCN40/4X14/ 1,0M/S7-IN | 2321266 | 1 |
| CABLE-FCN40/4X14/ 2,0M/S7-IN | 2321279 | 1 |
| CABLE-FCN40/4X14/ 3,0M/S7-IN | 2321282 | 1 |
| CABLE-FCN40/4X14/ 4,0M/S7-IN | 2321295 | 1 |
| CABLE-FCN40/4X14/ 6,0M/S7-IN | 2321305 | 1 |
| CABLE-FCN40/4X14/ 8,0M/S7-IN | 2321318 | 1 |
| CABLE-FCN40/4X14/10,0M/S7-IN | 2321321 | 1 |

System cabling for controllers

VARIOFACE system cabling

Siemens SIMATIC® S7-300 Front adapter for MINI MCR

This front adapter is used exclusively for coupling the MINI MCR-SL-V8-FLK 16 A adapter. Changed analog standard signals can be transmitted with the help of these components.

Suitable isolators can be seen from page 66.

For suitable 16-pos. system cable (FLK 16/EZ-DR/...), refer to page 506.



Front adapter for SIMATIC® S7-300,
20-pos. analog I/O boards



Max. perm. operating voltage
Max. permissible current

Ambient temperature (operation)
Ambient temperature (storage/transport)
Standards/regulations

| Certification data | |
|-------------------------|-----------|
| Nominal voltage/current | CUL - / - |
| Nominal voltage/current | UL - / - |

Technical data

FLKM 16-PA-S300/MINI-MCR
30 V AC/DC
50 mA (per path)
500 mA (per connection, supply via separate power supply)

-20°C ... 60°C
-20°C ... 70°C
DIN EN 50178 / DIN EN 50178

Ordering data

| Description | No. of pos. |
|---|-------------|
| VARIOFACE front adapter , for SIMATIC® S7-300, only in connection with MINI MCR-SL-V8-FLK 16-A | 16 |

| Type | Order No. | Pcs. / Pkt. |
|--------------------------|-----------|-------------|
| FLKM 16-PA-S300/MINI-MCR | 2314749 | 1 |

Accessories

Assembled round cable, with two 16-pos. socket strips
System adapter, for MINI analog modules with screw connection

| | | |
|--------------------------|---------|---|
| FLK 16/EZ-DR/ 300/KONFEK | 2299330 | 1 |
| MINI MCR-SL-V8-FLK 16-A | 2811268 | 1 |

Front adapter for analog cards of SIMATIC® S7-300

| Card type | FLKM 16-PA-S300/MINI-MCR |
|---------------|--|
| Analog input | 6ES7 331-7KF02-0AB0 6ES7 331-7KB02-0AB0 6ES7 331-7KB81-0AB0 6ES7 331-7TF00-0AB0 |
| Analog output | 6ES7 332-8TF01-0AB0 |

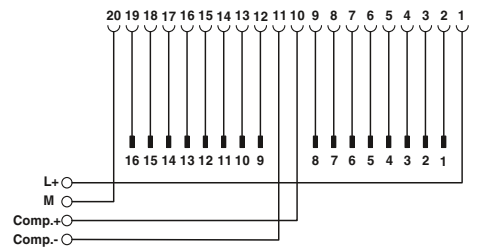
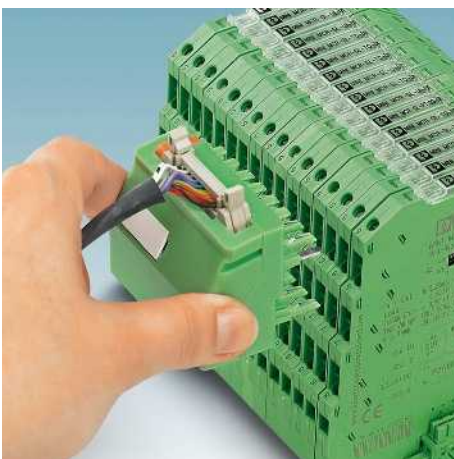

FLKM 16-PA-S300/MINI-MCR connection scheme

Explanation:

- Flat-ribbon cable strip
- Connection to I/O card
- Screw terminal blocks for separate supply

Siemens SIMATIC® S7-300 Front adapter for MINI analog system cabling

The FLKM 16-PA-331-1KF//MINI-MCR front adapter is used for implementing system cabling in conjunction with the MINI Analog system adapter and a 16-pos. system cable FLK 16/EZ-DR/.../KONFEK; refer to page 506.

Instead of the conventional front plug, screw terminal blocks are used to snap this component onto the analog module.

The DIP switches can be used to connect "M-" connections to each other and to the central ground of the system.

The front adapter supports **only current signals**.

The front adapter is suitable for the following analog input card:

– 6ES7 331-1KF02-0AB0

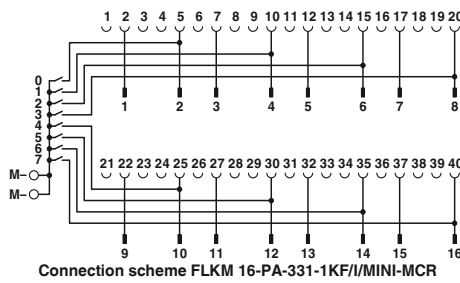

Max. perm. operating voltage
Max. permissible current
Rated surge voltage / insulation
Ambient temperature (operation)
Ambient temperature (storage/transport)
Standards/regulations

30 V AC/DC
50 mA (per path)
0.5 kV / basic insulation
-20°C ... 60°C
-20°C ... 70°C
DIN EN 50178 / DIN EN 50178

| Description | No. of pos. |
|---|-------------|
| VARIOFACE front adapter , for SIMATIC® S7-300, only in connection with MINI MCR-SL-V8-FLK 16-A | 16 |

| Ordering data | | |
|-------------------------------|-----------|-------------|
| Type | Order No. | Pcs. / Pkt. |
| FLKM 16-PA- 331-1KF//MINI-MCR | 2318237 | 1 |



Front adapter for SIMATIC® S7-300,
6ES7 331-1KF02-0AB0 analog I/O board

Technical data

Siemens SIMATIC® S7-300 Front adapter for MINI analog system cabling

The FLKM 16-PA-332-5HF//MINI-MCR front adapter is used for implementing system cabling in conjunction with the MINI Analog system adapter and a 16-pos. system cable FLK 16/EZ-DR/.../KONFEK; refer to page 506.

Instead of the conventional front plug, screw terminal blocks are used to snap this component on to the analog module.

The front adapter supports **only current signals**.

The front adapter is suitable for the following analog output cards:

– 6ES7 332-5HF00-0AB0

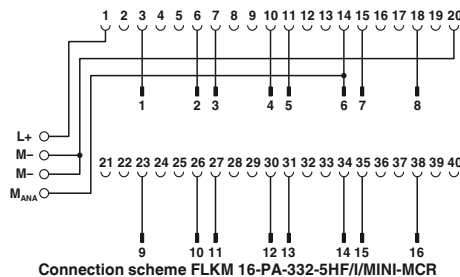

Max. perm. operating voltage
Max. permissible current
Rated surge voltage / insulation
Ambient temperature (operation)
Ambient temperature (storage/transport)
Standards/regulations

30 V AC/DC
50 mA (per path)
500 mA (per connection, supply via separate power supply)
0.5 kV / basic insulation
-20°C ... 60°C
-20°C ... 70°C
DIN EN 50178 / DIN EN 50178

| Description | No. of pos. |
|---|-------------|
| VARIOFACE front adapter , for SIMATIC® S7-300, only in connection with MINI MCR-SL-V8-FLK 16-A | 16 |

| Ordering data | | |
|-------------------------------|-----------|-------------|
| Type | Order No. | Pcs. / Pkt. |
| FLKM 16-PA- 332-5HF//MINI-MCR | 2318240 | 1 |



Front adapter for SIMATIC® S7-300,
6ES7 332-5HF00-0AB0 analog I/O board

Technical data

VARIOFACE system cabling

Siemens SIMATIC® S7-1500 System cables for front plugs from the “TOP connect” series

These system cables are connected directly to Siemens “SIMATIC TOP connect” front plugs. A VARIOFACE front adapter is not required. The cables can be used to connect existing 8-channel Phoenix Contact termination boards.

- For passive signal transmission, e.g., VIP-2/SC/FLK14/PLC; Order No. 2315214, see page 470.
- For relay or solid-state relay connection via V8 adapters, e.g., PLC-V8/FLK14/OUT; Order No. 2295554, see page 369.

The system cables are available in the following versions:

- Unshielded
- Shielded
- Halogen-free
- Encapsulated plug-in connector

Details regarding assignment to Siemens modules are provided with the system cable order numbers at www.phoenixcontact.net/products.



N



Technical data

| | |
|--|---|
| Max. perm. operating voltage | < 50 V AC / 60 V DC |
| Max. perm. current carrying capacity per path | 1 A |
| Max. conductor resistance | 0.16 Ω/m |
| Ambient temperature (operation) | -20°C ... 50°C |
| Assembly | Insulation displacement, IEC 60352-4/DIN EN 60352-4 |
| Number of positions, control side | 16 |
| Number of positions, module side | 14 |
| Conductor cross section | AWG 26 / 0.14 mm ² |
| Conductor structure: stranded wires / material | 7 / Cu tin-plated |
| Outside diameter | 6.4 mm |

Ordering data

| Description | Cable length | Type | Order No. | Pcs. / Pkt. |
|---|--------------|-------------------------|-----------|-------------|
| Unshielded round cables , with one 16-pos. and one 14-pos. socket strip in fixed lengths for transmitting 8 channels | | | | |
| | 0.5 m | FLK 14/16/EZ-DR/ 50/S7 | 2293815 | 5 |
| | 1 m | FLK 14/16/EZ-DR/ 100/S7 | 2293828 | 1 |
| | 1.5 m | FLK 14/16/EZ-DR/ 150/S7 | 2293831 | 1 |
| | 2 m | FLK 14/16/EZ-DR/ 200/S7 | 2293844 | 1 |
| | 2.5 m | FLK 14/16/EZ-DR/ 250/S7 | 2293857 | 1 |
| | 3 m | FLK 14/16/EZ-DR/ 300/S7 | 2293860 | 1 |
| | 4 m | FLK 14/16/EZ-DR/ 400/S7 | 2293886 | 1 |
| | 5 m | FLK 14/16/EZ-DR/ 500/S7 | 2293899 | 1 |
| | 6 m | FLK 14/16/EZ-DR/ 600/S7 | 2293909 | 1 |
| | 7 m | FLK 14/16/EZ-DR/ 700/S7 | 2293912 | 1 |
| | 8 m | FLK 14/16/EZ-DR/ 800/S7 | 2293925 | 1 |
| | 9 m | FLK 14/16/EZ-DR/ 900/S7 | 2293938 | 1 |
| | 10 m | FLK 14/16/EZ-DR/1000/S7 | 2293941 | 1 |
| Unshielded round cables , as above, but in variable lengths of type “FLK EZ-DR/14U/C52/...” | | | | |
| | | FLK EZ-DR.../.../... | 2295059 | 1 |
| Shielded round cables , with one 16-pos. and one 14-pos. socket strip, for transmitting 8 channels in variable lengths of type “FLK EZ-DR-S/14S/C52/...” | | | | |
| | | FLK EZ-DR-S.../.../... | 2295046 | 1 |
| Unshielded halogen-free round cables , with one 16-pos. and one 14-pos. socket strip, for transmitting 8 channels in variable lengths | | | | |

N



Halogen-free
(only the cable)

N



One encapsulated plug-in connector
(on module side, 14-pos.)

Pin assignment and color code:

- FLK 14/16/EZ-DR/.../S7
- FLK 14/16/EZ-DR/HF/.../S7
- VIP-CAB-FLK14/16/.../S7

| 14-pos. socket strip PIN | 16-pos. socket strip PIN | Wire color |
|--------------------------|--------------------------|--------------|
| 1 | 16 | Black |
| 2 | 14 | Brown |
| 3 | 12 | Red |
| 4 | 10 | Orange |
| 5 | 8 | Yellow |
| 6 | 6 | Green |
| 7 | 4 | Blue |
| 8 | 2 | Violet |
| 9 | 9 | Gray |
| 10 | 1 | White |
| 11 | 11 | White-black |
| 12 | 3 | White-brown |
| 13 | 13 | White-red |
| 14 | 5 | White-orange |
| Not used | 7 | - |
| Not used | 15 | - |

Technical data

< 50 V AC / 60 V DC
1 A
0.16 Ω/m
-20°C ... 50°C
Insulation displacement, IEC 60352-4/DIN EN 60352-4

16
14
AWG 26 / 0.14 mm²
7 / Cu tin-plated
6.4 mm

Technical data

< 50 V AC / 60 V DC
1 A
0.16 Ω/m
-20°C ... 50°C
Insulation displacement, IEC 60352-4/DIN EN 60352-4

16
14
AWG 26 / 0.14 mm²
7 / Cu tin-plated
6.4 mm

Ordering data

| Type | Order No. | Pcs. / Pkt. |
|----------------------------|-----------|-------------|
| FLK 14/16/EZ-DR/HF/ 50/S7 | 2296919 | 1 |
| FLK 14/16/EZ-DR/HF/ 100/S7 | 2296922 | 1 |
| FLK 14/16/EZ-DR/HF/ 150/S7 | 2296935 | 1 |
| FLK 14/16/EZ-DR/HF/ 200/S7 | 2296948 | 1 |
| FLK 14/16/EZ-DR/HF/ 250/S7 | 2296951 | 1 |
| FLK 14/16/EZ-DR/HF/ 300/S7 | 2296964 | 1 |
| FLK 14/16/EZ-DR/HF/ 400/S7 | 2904525 | 1 |
| FLK 14/16/EZ-DR/HF/ 500/S7 | 2304704 | 1 |
| FLK 14/16/EZ-DR/HF/ 600/S7 | 2904526 | 1 |
| FLK 14/16/EZ-DR/HF/ 800/S7 | 2904527 | 1 |
| FLK 14/16/EZ-DR/HF/1000/S7 | 2904528 | 1 |
| FLK 14-16-EZ-DR-HF-S7/... | 2295693 | 1 |

Ordering data

| Type | Order No. | Pcs. / Pkt. |
|---------------------------|-----------|-------------|
| VIP-CAB-FLK14/16/0,5M/S7 | 2904514 | 1 |
| VIP-CAB-FLK14/16/1,0M/S7 | 2904515 | 1 |
| VIP-CAB-FLK14/16/1,5M/S7 | 2904516 | 1 |
| VIP-CAB-FLK14/16/2,0M/S7 | 2904517 | 1 |
| VIP-CAB-FLK14/16/2,5M/S7 | 2904518 | 1 |
| VIP-CAB-FLK14/16/3,0M/S7 | 2904519 | 1 |
| VIP-CAB-FLK14/16/4,0M/S7 | 2904520 | 1 |
| VIP-CAB-FLK14/16/5,0M/S7 | 2904521 | 1 |
| VIP-CAB-FLK14/16/6,0M/S7 | 2904522 | 1 |
| VIP-CAB-FLK14/16/8,0M/S7 | 2904523 | 1 |
| VIP-CAB-FLK14/16/10,0M/S7 | 2904524 | 1 |

Encapsulated 14-pos. plug-in connector:

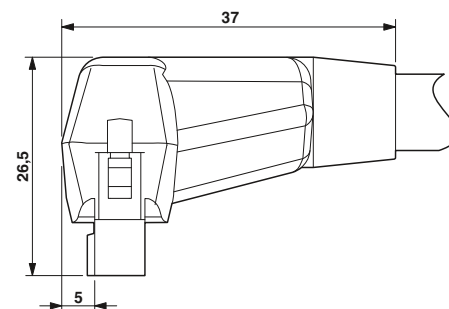

Note:
The following modules cannot be coupled due to the larger outer contour of the molded 14-pos. plug-in connector:
UM 45-FLK14/ 8IM/ZFKDS/PLC, 2965211
UM 45- 8RM/MR-G24/1/PLC, 2962900

Ordering example for unshielded round cable:
Unshielded round cable, assembled with one 14-pos. and one 16-pos. socket strip, 12.70 m long
Type: FLK EZ-DR /14U/C52/...

| Quantity | Order No. | Length [m] ¹⁾ |
|----------|-----------------|--------------------------|
| 1 | 2295059/14U/C52 | 12.70 |

¹⁾ Min. 0.20 m

14U ≙ 14-pos. unshielded cable
C52 ≙ S7-1500 assembly with 14-pos. socket strip at one end and 16-pos. socket strip at the other

Ordering example for shielded round cable:
Unshielded round cable, assembled with one 14-pos. and one 16-pos. socket strip, 13.20 m long
Type: FLK EZ-DR-S /14S/C52/...

| Quantity | Order No. | Length [m] ¹⁾ |
|----------|-----------------|--------------------------|
| 1 | 2295046/14S/C52 | 13.20 |

¹⁾ Min. 0.20 m

14S ≙ 14-pos. shielded cable
C52 ≙ S7-1500 assembly with 14-pos. socket strip at one end and 16-pos. socket strip at the other

Ordering example for halogen-free round cable:
Halogen-free round cable, assembled with one 14-pos. and one 16-pos. socket strip, 15.50 m long
Type: FLK 14-16-EZ-DR-HF-S7/...

| Quantity | Order No. | Length [m] ¹⁾ |
|----------|-----------|--------------------------|
| 1 | 2295693 | 15.50 |

¹⁾ Min. 0.20 m

System cabling for controllers

VARIOFACE system cabling

Siemens SIMATIC® S7-400 Front adapter

The front adapters mean that pre-assembled system cables can be directly connected to I/O modules.

FLKM 50-PA-S400

– Transmission of max. 32 digital channels over one 50-pos. system cable.

FLKM 50/4-FLK14/PA-S400

– Transmission of max. 32 digital channels via one 14-pos. system cable.

Perfectly-fitting VARIOFACE termination boards with a variety of functions and connection possibilities round off this system concept.

FLKM 50-PA-S400 (3-48)

– Analog channels are connected via a 50-pos. system cable.

The 1:1 connection of the adapter means that corresponding 1:1 interface modules are connected here



Front adapter for SIMATIC® S7-400



Technical data

Max. perm. operating voltage
Max. permissible current

< 50 V AC / 60 V DC
1 A (per path)
8 A (per connection, supply via separate power supply)

Max. perm. total current

2 A (Per Byte, for supply via connector)
8 A (during supply via a separate bridged power supply)

Ambient temperature (operation)
Ambient temperature (storage/transport)
Mounting position
Standards/regulations

-20°C ... 50°C
-20°C ... 70°C
Any
IEC 60664 / IEC 60664 / IEC 60664

Ordering data

| Description | No. of pos. |
|---|-------------|
| VARIOFACE front adapter, for | |
| - SIMATIC® S7-400, 1 x 32 channels can be connected | 50 |
| - SIMATIC® S7-400, 4 x 8 channels can be connected | 14 |
| - SIMATIC® S7-400, only analog | 50 |

| Type | Order No. | Pcs. / Pkt. |
|---------------------------------|----------------|-------------|
| FLKM 50-PA-S400 | 2294500 | 2 |
| FLKM 50/ 4-FLK14/PA-S400 | 2294429 | 2 |
| FLKM 50-PA-S400(3-48) | 2294908 | 2 |

Front adapter for I/O modules of the Siemens automation equipment SIMATIC® S7-400

| Card type | FLKM 50-PA-S400 |
|----------------|---|
| Digital input | 6ES7 421-1BL01-0AA0 6ES7 421-7BH01-0AB0* 6ES7 421-7DH00-0AB0* |
| Digital output | 6ES7 422-1BL00-0AA0 6ES7 422-7BL00-0AB0 |

| Card type | FLKM 50/4-FLK14/PA-S400 |
|----------------|--|
| Digital input | 6ES7 421-1BL01-0AA0 |
| Digital output | 6ES7 422-1BL00-0AA0 6ES7 422-7BL00-0AB0 |

| Card type | FLKM 50-PA-S400 (3-48) |
|---------------|---|
| Analog input | 6ES7 431-0HH00-0AB0** 6ES7 431-1KF00-0AB0** 6ES7 431-1KF10-0AB0** 6ES7 431-1KF20-0AB0** 6ES7 431-7KF00-0AB0** 6ES7 431-7KF10-0AB0** 6ES7 431-7QH00-0AB0** |
| Analog output | 6ES7 432-1HF00-0AB0** |

* Only in connection with VIP-2/SC/FLK50/S7/A-S400, Order No.: 2322359
All wire bridges (DR) on the adapter must be disconnected.

** Only in connection with VIP-3/SC/FLK50, Order No.: 2315081
UM 45-FLK 50/ZFKDS, Order No.: 2293585
UM 45-FLKS 50/ZFKDS, Order No.: 2968470
FLKM 50/KDS 3-MT/PPA/AN/PLC, Order No.: 2291587

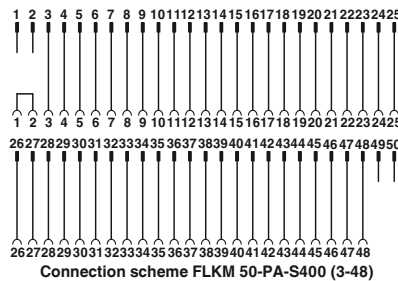

Connection scheme FLKM 50-PA-S400 (3-48)

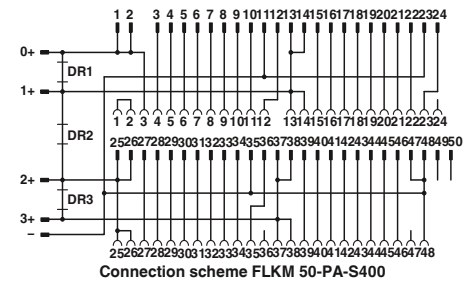

Connection scheme FLKM 50-PA-S400

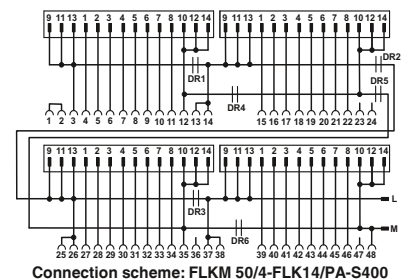

Connection scheme: FLKM 50/4-FLK14/PA-S400

Explanation:

- Flat-ribbon cable strip
- Connection to I/O card
- Screw terminal blocks for separate supply

**Siemens SIMATIC® S7-400
Adapter for conversion from S5-135/155 to S7-400**

The FLKM S135/... adapters connect a SIMATIC® S5 connector wired with individual conductors directly to the SIMATIC® S7-400 basic card.

The SIMATIC® S5 connector is plugged directly onto an S7-400-I/O card with the help of an FFLKM S135/... intermediate adapter.

A new SIMATIC® S7-400 is installed in place of the SIMATIC® S5. The existing field wiring remains intact.

Attention:

The LEDs of the S7-400 module are hidden.



Adapter for Siemens SIMATIC® S5-135/S7-400



| | |
|---------------------------------|-----------------------|
| Max. perm. operating voltage | 24 V AC/DC |
| Max. permissible current | 4 A (per path) |
| Test voltage (contact/contact) | 500 V (50 Hz, 1 min.) |
| Ambient temperature (operation) | -20°C ... 50°C |
| Mounting position | Any |
| Standards/regulations | - |

| Technical data | | | |
|-----------------------|-------------------------|-------------------------|-------------------------|
| ① | ② | ③ | ④ |
| 24 V AC/DC | 60 V DC | 24 V DC | 24 V AC/DC |
| 4 A (per path) | 2 A (per path) | 4 A (per path) | 4 A (per path) |
| 500 V (50 Hz, 1 min.) | 1.25 kV (50 Hz, 1 min.) | 1.25 kV (50 Hz, 1 min.) | 1.25 kV (50 Hz, 1 min.) |
| -20°C ... 50°C | -20°C ... 50°C | -20°C ... 50°C | -20°C ... 50°C |
| Any | Any | Any | Any |
| - | - | - | - |

| Description | No. of pos. |
|--|-------------|
| Digital IN 24 V from S5-135/155 to S7-400 | |
| 6ES5 420-4UA14 on 6ES7 421-1BL01-0AA0 | ① |
| 6ES5 430-4UA14 on 6ES7 421-1BL01-0AA0 | ② |
| 6ES5 431-4UA12 to 6ES7 421-7DH00-0AB0 | ③ |
| 6ES5 432-4UA12 on 6ES7 421-1BL01-0AA0 | ④ |

| Ordering data | | | |
|------------------------|-----------|-------------|--|
| Type | Order No. | Pcs. / Pkt. | |
| FLKM S135/S400/SO120 | 2301723 | 1 | |
| FLKM S135/S400/SO121 | 2301736 | 1 | |
| FLKM S135-431-4UA/S400 | 2314846 | 1 | |
| FLKM S135/S400/SO122 | 2301749 | 1 | |



FLKM S135-431-UA/S400 connection scheme

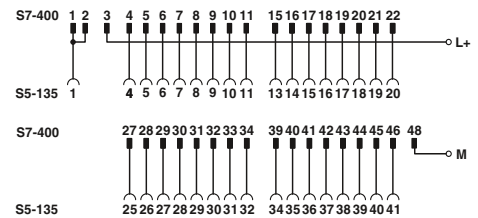

Connection scheme: FLKM S135/S400/SO120



Connection scheme: FLKM S135/S400/SO122

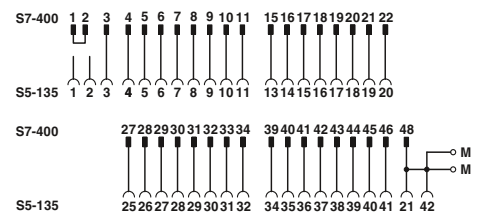

Connection scheme: FLKM S135/S400/SO121

System cabling for controllers

VARIOFACE system cabling

Siemens SIMATIC® S7-400 Adapter for conversion from S5-135/155 to S7-400

The FLKM S135/... adapters connect a SIMATIC® S5 connector wired with individual conductors directly to the SIMATIC® S7-400 basic card.

The SIMATIC® S5 connector is plugged directly onto an S7-400-I/O card to the help of an FFLKM S135/... intermediate adapter.

A new SIMATIC® S7-400 is installed in place of the SIMATIC® S5. The existing field wiring remains intact.

Attention:

The LEDs of the S7-400 module are hidden.



Front adapter for SIMATIC S5-135/S7-400



| | | | | | |
|------------------------------|--------------------------|--------------------------------|---------------------------------|-------------------|-----------------------|
| Max. perm. operating voltage | Max. permissible current | Test voltage (contact/contact) | Ambient temperature (operation) | Mounting position | Standards/regulations |
|------------------------------|--------------------------|--------------------------------|---------------------------------|-------------------|-----------------------|

| Technical data | | | |
|---------------------------|--------------------------|----------------------------|--------------------------|
| ① | ② | ③ | ④ |
| 230 V AC/DC | 24 V AC/DC | 24 V DC | 24 V DC |
| 4 A (per path) | 4 A (per path) | 4 A (per path) | 4 A (per path) |
| 1.5 kV (50 Hz, 1 min.) | 500 V (50 Hz, 1 min.) | 1.25 kV (50 Hz, 1 min.) | 500 V (50 Hz, 1 min.) |
| -20°C ... 50°C | -20°C ... 50°C | -20°C ... 50°C | -20°C ... 50°C |
| Any | Any | Any | Any |
| - | - | - | - |

| Description | No. of pos. |
|--|-------------|
| Digital IN 120/230 V UC from S5-135/155 to S7-400 | |
| 6ES5 436-4UA12 to 6ES7 421-1FH20-0AA0 | ① |
| Digital OUT 24 V from S5-135/155 to S7-400 | |
| 6ES5 441-4UA12 to 6ES7 422-1BL00-0AA0 | ② |
| 6ES5 451-4UA14 to 6ES7 422-1BL00-0AA0 | ③ |
| Digital OUT 24 V DC / 2 A from S5-135/155 to S7-400 | |
| 6ES5 453-4UA12 to 6ES7 422-1HH00-0AA0 | ④ |

| Ordering data | | |
|----------------------|-----------|-------------|
| Type | Order No. | Pcs. / Pkt. |
| FLKM S135/S400/SO123 | 2301752 | 1 |
| FLKM S135/S400/SO125 | 2301778 | 1 |
| FLKM S135/S400/SO126 | 2301781 | 1 |
| FLKM S135/S400/SO127 | 2301794 | 1 |

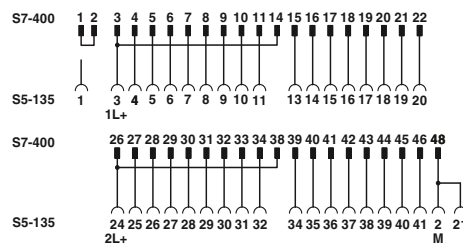

Connection scheme: FLKM S135/S400/SO126

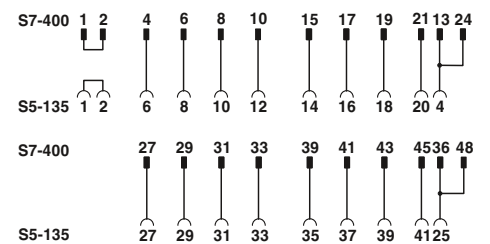

Connection scheme: FLKM S135/S400/SO123



Connection scheme: FLKM S135/S400/SO127



Connection scheme: FLKM S135/S400/SO125

Siemens SIMATIC® S7-400 Adapter for conversion from S5-135/155 to S7-400

The FLKM S135/... adapters connect a SIMATIC® S5 connector wired with individual conductors directly to the SIMATIC® S7-400 basic card.

The SIMATIC® S5 connector is plugged directly onto an S7-400-I/O card to the help of an FFLKM S135/... intermediate adapter.

A new SIMATIC® S7-400 is installed in place of the SIMATIC® S5. The existing field wiring remains intact.

Attention:

The LEDs of the S7-400 module are hidden.



Adapter for Siemens SIMATIC® S5-135/S7-400

| | |
|---------------------------------|-------------------------|
| Max. perm. operating voltage | 24 V DC |
| Max. permissible current | 4 A (per path) |
| Test voltage (contact/contact) | 1.25 kV (50 Hz, 1 min.) |
| Ambient temperature (operation) | -20°C ... 50°C |
| Mounting position | Vertical |
| Standards/regulations | - |

| Technical data | | | |
|-------------------------|------------------------|-----------------------|-----------------------|
| ① | ② | ③ | ④ |
| 24 V DC | 230 V AC | 24 V DC | 24 V DC |
| 4 A (per path) | 4 A (per path) | 4 A (per path) | 4 A (per path) |
| 1.25 kV (50 Hz, 1 min.) | 1.5 kV (50 Hz, 1 min.) | 500 V (50 Hz, 1 min.) | 500 V (50 Hz, 1 min.) |
| -20°C ... 50°C | -20°C ... 50°C | -20°C ... 50°C | -20°C ... 50°C |
| Vertical | Vertical | Vertical | Vertical |
| - | - | - | - |

| Description | No. of pos. |
|---|-------------|
| Digital OUT 24 V DC / 2 A from S5-135/155 to S7-400 | |
| 6ES5 454-4UA14 to 6ES7 422-1BH11-0AA0 | ① |
| Digital OUT 230 V UC / 2 A from S5-135/155 to S7-400 | |
| 6ES5 456-4UA12 to 6ES7 422-1FH00-0AA0 | ② |
| Analog IN (only current measurement) from S5-135/155 to S7-400 | |
| 6ES5 460-4UA13 to 6ES7 431-1KF00-0AB0 | ③ |
| Analog IN (only voltage measurement) from S5-135/155 to S7-400 | |
| 6ES5 460-4UA13 to 6ES7 431-1KF00-0AB0 | ④ |

| Ordering data | | |
|--------------------------|-----------|-------------|
| Type | Order No. | Pcs. / Pkt. |
| FLKM S135-454-4UA/S400 | 2314859 | 1 |
| FLKM S135/S400/SO124 | 2301765 | 1 |
| FLKM S135-460-4UA/I/S400 | 2314613 | 1 |
| FLKM S135-460-4UA/U/S400 | 2314862 | 1 |



FLKM S135-460-4UA/I/S400 connection scheme



FLKM S135-454-4UA/S400 connection scheme

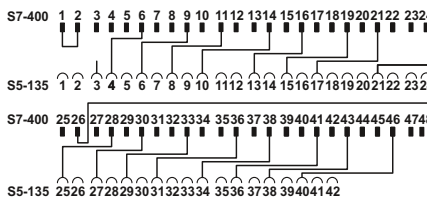

Connection scheme: FLKM S135-460-4UA/U/S400

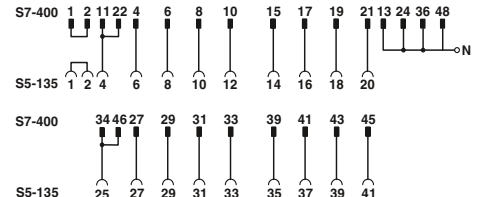

Connection scheme: FLKM S135/S400/SO124

System cabling for controllers

VARIOFACE system cabling

Siemens SIMATIC® S7-400 Adapter for conversion from S5-135/155 to S7-400

The FLKM S135/... adapters connect a SIMATIC® S5 connector wired with individual conductors directly to the SIMATIC® S7-400 basic card.

The SIMATIC® S5 connector is plugged directly onto an S7-400-I/O card to the help of an FFLKM S135/... intermediate adapter.

A new SIMATIC® S7-400 is installed in place of the SIMATIC® S5. The existing field wiring remains intact.

Attention:

The LEDs of the S7-400 module are hidden.



Adapter for Siemens SIMATIC® S5-135/S7-400



| | |
|---------------------------------|-----------------------|
| Max. perm. operating voltage | 24 V DC |
| Max. permissible current | 2 A (per path) |
| Test voltage (contact/contact) | 500 V (50 Hz, 1 min.) |
| Ambient temperature (operation) | -20°C ... 50°C |
| Mounting position | Any |
| Standards/regulations | - |

| Technical data | | | |
|-----------------------|-----------------------|-----------------------|-----------------------|
| ① | ② | ③ | ④ |
| 24 V DC | 24 V DC | 24 V DC | 24 V DC |
| 2 A (per path) | 4 A (per path) | 4 A (per path) | 4 A (per path) |
| 500 V (50 Hz, 1 min.) | 500 V (50 Hz, 1 min.) | 500 V (50 Hz, 1 min.) | 500 V (50 Hz, 1 min.) |
| -20°C ... 50°C | -20°C ... 50°C | -20°C ... 50°C | -20°C ... 50°C |
| Any | Any | Any | Any |
| - | - | - | - |

| Description | No. of pos. |
|---|-------------|
| Analog IN (only Pt 100) from S5-135/155 to S7-400 | |
| 6ES5 465-4UA13 to 6ES7 431-7KF10-0AB0 | ① |
| Analog IN (only current and voltage measurement) from S5-135/155 to S7-400 | |
| 6ES5 465-4UA13 to 6ES7 431-0HH00-0AB0 | ② |
| 6ES5 465-4UA13 to 6ES7 431-7QH00-0AB0 | |
| Analog OUT (only current output) from S5-135/155 to S7-400 | |
| 6ES5 470-4UA13 to 6ES7 432-1HF00-0AB0 | ③ |
| 6ES5 470-4UC13 to 6ES7 432-1HF00-0AB0 | |
| Analog OUT (only voltage output) from S5-135/155 to S7-400 | |
| 6ES5 470-4UA13 to 6ES7 432-1HF00-0AB0 | ④ |
| 6ES5 470-4UB13 to 6ES7 432-1HF00-0AB0 | |
| 6ES5 470-4UC13 to 6ES7 432-1HF00-0AB0 | |

| Ordering data | | | |
|---------------------------|-----------|-------------|--|
| Type | Order No. | Pcs. / Pkt. | |
| FLKM S135-465-4UA/T/S400 | 2314875 | 1 | |
| FLKM S135-465-4UA/UI/S400 | 2314888 | 1 | |
| FLKM S135-470-4UC/I/S400 | 2314626 | 1 | |
| FLKM S135-470-4UC/U/S400 | 2314891 | 1 | |

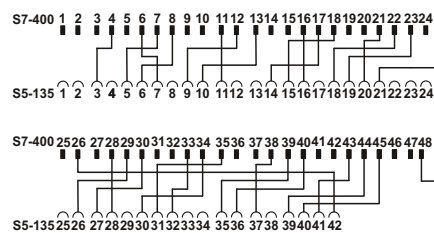

Connection scheme FLKM S135-470-4UC/I/S400

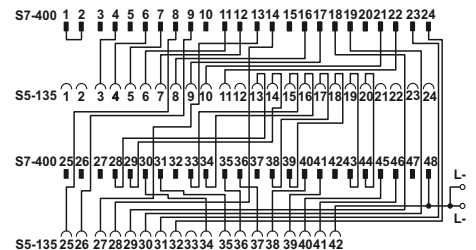

FLKM S135-465-4UA/T/S400 connection scheme

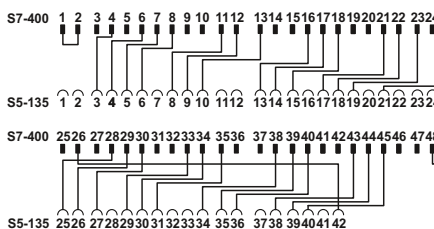

Connection scheme FLKM S135-470-4UC/U/S400

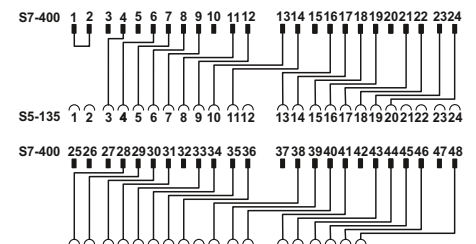

FLKM S135-465-4UA/UI/S400 connection scheme

**Siemens SIMATIC® S7-300
Adapter for conversion from
S5-135/155 to S7-300**

S5-S7 adapters connect the S5-135 front adapters wired with individual wires to the I/O modules of the S7.

With the help of the FLKM S135/S7/FLK50 converter module, the signals of the S5-135 front adapter can be converted to a 50-pos. strip. A 50-pos. system cable FLK 50/EZ-DR/.../KONFEK and a front adapter for the SIMATIC® S7 (FLKM 50-PA-S300) now connect the signals with the I/O module.



Max. perm. operating voltage
Max. permissible current
Ambient temperature (operation)
Ambient temperature (storage/transport)
Mounting position
Standards/regulations

Converter for Siemens SIMATIC® S5-135 to 50-pos. FLK strip.

Technical data

50 V AC/DC
1 A (per path)
-20°C ... 50°C
-20°C ... 70°C
Any
DIN EN 50178 / DIN EN 50178

Ordering data

| Description |
|--|
| Digital IN or OUT 24 V DC from S5-135 to S7-300 |
| IN 6ES5 420-4UA14 to 6ES7 321-1BL00-0AA0 6ES5 430-4UA14 to 6ES7 321-1BL00-0AA0 |
| OUT 6ES5 441-4UA14 to 6ES7 322-1BL00-0AA0 6ES5 451-4UA14 to 6ES7 322-1BL00-0AA0 |

| Type | Order No. | Pcs. / Pkt. |
|------------------------|-----------|-------------|
| FLKM S135/S7/FLK50/PLC | 2314736 | 1 |

Notes:
Due to the geometry, it is not possible to couple any molded FLK connectors (e.g., VIP-PA...S7).

Startup adapter for extending the existing S5-135/155 field wiring.

All signals of the existing S5-135 wiring 3 or 5 are extended with the help of the universal commissioning adapters. The open cable end can be connected to various controllers such as S7-400 or S7-300. This means that the existing field wiring of S5-135 can communicate with the new controller for test purposes. Since the new control unit is temporarily arranged before the control cabinet, the original status of the system can be restored if required.

If the system functions with the new controller without problems, the S5-135 can now be replaced.

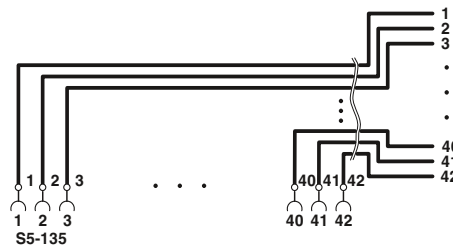

Max. perm. operating voltage
Max. permissible current
Ambient temperature (operation)
Ambient temperature (storage/transport)
Mounting position
Standards/regulations

Technical data

250 V AC/DC
6 A (per path)
-20°C ... 50°C
-20°C ... 80°C
Any
EN 60664-1

Ordering data

| Description |
|---|
| Connection of all S5-135 connections (1 to 42) at the open cable end |

| Type | Order No. | Pcs. / Pkt. |
|---------------------------|-----------|-------------|
| FLKM S135/42X0,75/3,0M/OE | 2315007 | 1 |
| FLKM S135/42X0,75/5,0M/OE | 2318017 | 1 |



VARIOFACE system cabling

Siemens SIMATIC® S7-400 Adapter for conversion from S5-115 to S7-400

The FLKM S115/... adapters connect a SIMATIC® S5 connector wired with individual conductors directly to the SIMATIC® S7-400 basic card.

The SIMATIC® S5 connector is plugged directly onto an S7-400-I/O card to the help of an FFLKM S115/... intermediate adapter.

A new SIMATIC® S7-400 is installed in place of the SIMATIC® S5. The existing field wiring remains intact.

Attention:

Due to the geometry, it is only possible to use every second slot. The LEDs of the S7-400 module are hidden by the S5-115 adapter.



Adapter for Siemens SIMATIC® S5-115/S7-400

Max. perm. operating voltage
Max. permissible current

Ambient temperature (operation)
Ambient temperature (storage/transport)
Mounting position
Standards/regulations

24 V AC/DC
4 A (per path)
4 A (per connection, supply via separate power supply)

-20°C ... 50°C
-20°C ... 70°C
Vertical
DIN EN 50178 / DIN EN 50178

Technical data

Ordering data

| Description |
|--|
| Digital IN or OUT 24 V DC from S5-115 to S7-400 |
| IN 6ES5 420-7LA11 to 6ES7 421-1BL01-0AA0 6ES5 430-7LA11 to 6ES7 421-1BL01-0AA0 |
| OUT 6ES5 441-7LA11 to 6ES7 422-1BL00-0AA0 6ES5 451-7LA11 to 6ES7 422-1BL00-0AA0 |
| Digital OUT 24 V DC from S5-115 to S7-400 |
| 6ES5 454-7LA12 to 6ES7 422-1BH11-0AA0 |
| Analog IN (only current and voltage measurement) from S5-115 to S7-400 |
| 6ES5 465-7LA13 to 6ES7 431-0HH00-0AB0 6ES5 465-7LA13 to 6ES7 431-7QH00-0AB0 |

| Type | Order No. | Pcs. / Pkt. |
|---------------------------|-----------|-------------|
| FLKM S115/S400/SO155 | 2307248 | 1 |
| FLKM S115-454-7LA/S400 | 2314901 | 1 |
| FLKM S115-465-7LA/UI/S400 | 2314914 | 1 |

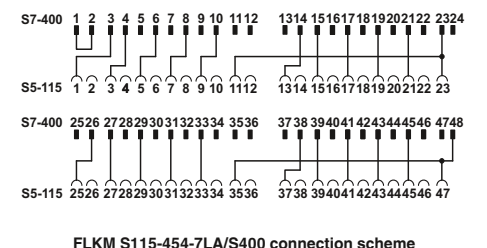
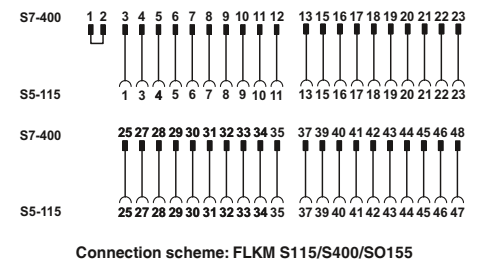

**Siemens SIMATIC® S7-300
Adapter for conversion from
S5-115 to S7-300**

S5-S7 adapters connect the S5-115 front adapters wired with individual wires to the I/O modules of S7-300.

With the aid of the FLKM S115/S7/FLK50/SO137 converter module, the signals of the S5-115 front adapter can be converted to a 50-pos. strip. A 50-pos. system cable FLK 50/EZ-DR/.../KONFEK and a front adapter for the SIMATIC® S7 (FLKM 50-PA-S300) now connect the signals with the I/O module.

Notes:
Due to the geometry, it is not possible to couple any molded FLK connectors (e.g., VIP-PA...S7).



Connection scheme: FLKM S115/S7/FLK50/PLC/SO137

Max. perm. operating voltage
Max. permissible current
Max. perm. total current
Ambient temperature (operation)
Ambient temperature (storage/transport)
Standards/regulations



Converter for Siemens SIMATIC® S5-115 to 50-pos. FLK strip.

Technical data

24 V AC/DC
1 A (per path)
2 A (per byte)
-20°C ... 50°C
-20°C ... 70°C
DIN EN 50178 / DIN EN 50178

Ordering data

| Type | Order No. | Pcs. / Pkt. |
|------------------------------|-----------|-------------|
| FLKM S115/S7/FLK50/PLC/SO137 | 2306294 | 1 |

| Description |
|--|
| Digital IN or OUT 24 V DC from S5-115 through converters, system cables, and front adapters to S7-300 |
| IN 6ES5 420-7LA11 on 6ES7 321-1BL00-0AA0 6ES5 430-7LA11 on 6ES7 321-1BL00-0AA0 |
| OUT 6ES5 441-7LA11 on 6ES7 322-1BL00-0AA0 6ES5 451-7LA11 on 6ES7 322-1BL00-0AA0 |

Commissioning adapters for extending the existing S5-115 field wiring

All signals of the existing S5-115 wiring 3 or 5 are extended with the help of the universal commissioning adapters. The open cable end can be connected to various controllers such as S7-400 or S7-300. This means that the existing field wiring of S5-115 can communicate with the new controller for test purposes. Since the new control unit is temporarily arranged before the control cabinet, the original status of the system can be restored if required.

If the system functions with the new controller without problems, the S5-115 can now be replaced.



Max. perm. operating voltage
Max. permissible current
Ambient temperature (operation)
Ambient temperature (storage/transport)
Mounting position
Standards/regulations



Technical data

250 V AC/DC
6 A (per path)
-20°C ... 50°C
-20°C ... 80°C
Any
EN 60664-1

Ordering data

| Type | Order No. | Pcs. / Pkt. |
|---------------------------|-----------|-------------|
| FLKM S115/47X0,75/3,0M/OE | 2314985 | 1 |
| FLKM S115/47X0,75/5,0M/OE | 2314998 | 1 |

| Description |
|---|
| Connection of all S5-115 connections (1 to 23, 25 to 47) at the open cable end |

System cabling for controllers

VARIOFACE system cabling

YOKOGAWA Centum CS3000 R3 System cable

These shielded system cables for digital (50-pos.) and analog (40-pos.) I/O modules are connected directly to the modules. An intermediate adapter is not required. Features:

- Molded plug-in connector
- Can be screwed
- Lateral cable outlet of the I/O module
- KS/AKB-compatible plug-in connectors on the module side



| | | | Technical data | | |
|--|--------------|--------------|-------------------------------|-----------|-------------|
| Max. perm. operating voltage | | | 30 V DC | | |
| Max. perm. current carrying capacity per path | | | 500 mA | | |
| Max. conductor resistance | | | 0.16 Ω/m | | |
| Ambient temperature (operation) | | | -20°C ... 50°C | | |
| Conductor cross section | | | AWG 26 / 0.14 mm ² | | |
| Conductor structure: stranded wires / material | | | 7 / Cu tin-plated | | |
| Outside diameter | | | | | |
| | 50 -position | | 11 mm | | |
| | 40 -position | | 11 mm | | |
| | | | Ordering data | | |
| Description | No. of pos. | Cable length | Type | Order No. | Pcs. / Pkt. |
| 50-pos. YUC cables, for digital I/O modules | | | | | |
| | 50 | 2 m | FLK 50-PA/EZ-DR/KS/ 200/YUC | 2314299 | 1 |
| | 50 | 3 m | FLK 50-PA/EZ-DR/KS/ 300/YUC | 2314309 | 1 |
| | 50 | 4 m | FLK 50-PA/EZ-DR/KS/ 400/YUC | 2314312 | 1 |
| | 50 | 5 m | FLK 50-PA/EZ-DR/KS/ 500/YUC | 2321499 | 1 |
| | 50 | 6 m | FLK 50-PA/EZ-DR/KS/ 600/YUC | 2314927 | 1 |
| | 50 | 7 m | FLK 50-PA/EZ-DR/KS/ 700/YUC | 2321509 | 1 |
| | 50 | 8 m | FLK 50-PA/EZ-DR/KS/ 800/YUC | 2314930 | 1 |
| | 50 | 9 m | FLK 50-PA/EZ-DR/KS/ 900/YUC | 2321512 | 1 |
| | 50 | 10 m | FLK 50-PA/EZ-DR/KS/1000/YUC | 2314325 | 1 |
| | 50 | 11 m | FLK 50-PA/EZ-DR/KS/1100/YUC | 2321389 | 1 |
| | 50 | 12 m | FLK 50-PA/EZ-DR/KS/1200/YUC | 2321525 | 1 |
| | 50 | 13 m | FLK 50-PA/EZ-DR/KS/1300/YUC | 2321392 | 1 |
| | 50 | 14 m | FLK 50-PA/EZ-DR/KS/1400/YUC | 2321402 | 1 |
| | 50 | 15 m | FLK 50-PA/EZ-DR/KS/1500/YUC | 2314338 | 1 |
| | 50 | 16 m | FLK 50-PA/EZ-DR/KS/1600/YUC | 2321538 | 1 |
| | 50 | 17 m | FLK 50-PA/EZ-DR/KS/1700/YUC | 2321541 | 1 |
| | 50 | 18 m | FLK 50-PA/EZ-DR/KS/1800/YUC | 2321554 | 1 |
| | 50 | 19 m | FLK 50-PA/EZ-DR/KS/1900/YUC | 2321567 | 1 |
| | 50 | 20 m | FLK 50-PA/EZ-DR/KS/2000/YUC | 2314503 | 1 |
| | 50 | 25 m | FLK 50-PA/EZ-DR/KS/2500/YUC | 2314516 | 1 |
| | 50 | 30 m | FLK 50-PA/EZ-DR/KS/3000/YUC | 2314529 | 1 |
| 40-pos. YUC cables, for analog I/O modules | | | | | |
| | 40 | 1 m | FLK 40-PA/EZ-DR/KS/ 100/YUC | 2322786 | 1 |
| | 40 | 2 m | FLK 40-PA/EZ-DR/KS/ 200/YUC | 2314341 | 1 |
| | 40 | 3 m | FLK 40-PA/EZ-DR/KS/ 300/YUC | 2314354 | 1 |
| | 40 | 4 m | FLK 40-PA/EZ-DR/KS/ 400/YUC | 2314367 | 1 |
| | 40 | 5 m | FLK 40-PA/EZ-DR/KS/ 500/YUC | 2321570 | 1 |
| | 40 | 6 m | FLK 40-PA/EZ-DR/KS/ 600/YUC | 2314943 | 1 |
| | 40 | 7 m | FLK 40-PA/EZ-DR/KS/ 700/YUC | 2321583 | 1 |
| | 40 | 8 m | FLK 40-PA/EZ-DR/KS/ 800/YUC | 2314956 | 1 |
| | 40 | 9 m | FLK 40-PA/EZ-DR/KS/ 900/YUC | 2321415 | 1 |
| | 40 | 10 m | FLK 40-PA/EZ-DR/KS/1000/YUC | 2314370 | 1 |
| | 40 | 11 m | FLK 40-PA/EZ-DR/KS/1100/YUC | 2321428 | 1 |
| | 40 | 12 m | FLK 40-PA/EZ-DR/KS/1200/YUC | 2321431 | 1 |
| | 40 | 13 m | FLK 40-PA/EZ-DR/KS/1300/YUC | 2321444 | 1 |
| | 40 | 14 m | FLK 40-PA/EZ-DR/KS/1400/YUC | 2321457 | 1 |
| | 40 | 15 m | FLK 40-PA/EZ-DR/KS/1500/YUC | 2314383 | 1 |
| | 40 | 16 m | FLK 40-PA/EZ-DR/KS/1600/YUC | 2321596 | 1 |
| | 40 | 17 m | FLK 40-PA/EZ-DR/KS/1700/YUC | 2321606 | 1 |
| | 40 | 18 m | FLK 40-PA/EZ-DR/KS/1800/YUC | 2321619 | 1 |
| | 40 | 19 m | FLK 40-PA/EZ-DR/KS/1900/YUC | 2321622 | 1 |
| | 40 | 20 m | FLK 40-PA/EZ-DR/KS/2000/YUC | 2314532 | 1 |
| | 40 | 25 m | FLK 40-PA/EZ-DR/KS/2500/YUC | 2314545 | 1 |
| | 40 | 30 m | FLK 40-PA/EZ-DR/KS/3000/YUC | 2314558 | 1 |

YOKOGAWA Centum CS3000 R3 System cable

These system cables for digital I/O modules are connected directly to the modules. An intermediate adapter is not required.

Features:

- Lateral cable outlet of the I/O module
- Four 14-pos. plug-in connectors on the module side for connection of four 8-channel VARIOFACE modules of the system cabling



| | | Technical data | |
|---|--------------|-------------------------------|--|
| Max. perm. operating voltage | | 30 V DC | |
| Max. perm. current carrying capacity per path | | 500 mA | |
| Max. conductor resistance | | 0.16 Ω/m | |
| Ambient temperature (operation) | | -20°C ... 50°C | |
| Conductor cross section | | AWG 26 / 0.14 mm ² | |
| Outside diameter | 50 -position | 11 mm | |

| | | | Ordering data | | |
|---|-------------|--------------|---------------------------|-----------|-------------|
| Description | No. of pos. | Cable length | Type | Order No. | Pcs. / Pkt. |
| System cable for digital I/O modules for coupling four 8-channel VARIOFACE modules | | | | | |
| | 50 | 2 m | CABLE-50/4FLK14/ 2,0M/YUC | 2314655 | 1 |
| | 50 | 4 m | CABLE-50/4FLK14/ 4,0M/YUC | 2314671 | 1 |
| | 50 | 6 m | CABLE-50/4FLK14/ 6,0M/YUC | 2318978 | 1 |
| | 50 | 10 m | CABLE-50/4FLK14/10,0M/YUC | 2314684 | 1 |
| | 50 | 15 m | CABLE-50/4FLK14/15,0M/YUC | 2322773 | 1 |
| | 50 | 20 m | CABLE-50/4FLK14/20,0M/YUC | 2314778 | 1 |

YOKOGAWA Centum CS3000 R3 System cable for MINI analog system cabling

The Yokogawa **CABLE-40/2FLK16/.../YUC** system cable makes it possible to connect 16 MINI analog modules to a Yokogawa control system. In conjunction with two MINI analog MINI MCR-SL-V8-FLK-16-A system adapters, the Yokogawa system cable provides a simple and economical “Plug and Play” solution.

The system cable is plugged directly into the Yokogawa module. Two 16-pos. flat-ribbon cable plug-in connectors are provided for connecting the module to the MINI analog system adapters.

The system cable in conjunction with **4-conductor measuring transducers** is suitable for the following analog cards:

- AAI 141
- AAI 143



| | | Technical data | |
|--|--------------|-------------------------------|--|
| Max. perm. operating voltage | | 30 V DC | |
| Max. perm. current carrying capacity per path | | 500 mA | |
| Max. conductor resistance | | 0.16 Ω/m | |
| Ambient temperature (operation) | | -20°C ... 50°C | |
| Conductor cross section | | AWG 26 / 0.14 mm ² | |
| Conductor structure: stranded wires / material | | 7 / Cu tin-plated | |
| Outside diameter | 40 -position | 11 mm | |

| | | | Ordering data | | |
|---|-------------|--------------|---------------------------|-----------|-------------|
| Description | No. of pos. | Cable length | Type | Order No. | Pcs. / Pkt. |
| System cable , for analog I/O modules for coupling two 8-channel MINI analog system adapters | | | | | |
| | 40 | 2 m | CABLE-40/2FLK16/ 2,0M/YUC | 2321334 | 1 |
| | 40 | 4 m | CABLE-40/2FLK16/ 4,0M/YUC | 2321347 | 1 |
| | 40 | 10 m | CABLE-40/2FLK16/10,0M/YUC | 2321350 | 1 |
| | 40 | 15 m | CABLE-40/2FLK16/15,0M/YUC | 2321376 | 1 |
| | 40 | 20 m | CABLE-40/2FLK16/20,0M/YUC | 2321363 | 1 |

System cabling for controllers

VARIOFACE system cabling

YOKOGAWA Centum CS3000 R3 Controller boards

These modules are connected to the I/O modules through the YUC system cable.

FLKM-KS40/YCS:

- For analog modules
- Universal interface module with 40 connection terminal blocks

For more cabling solutions for Yokogawa:
www.phoenixcontact.com

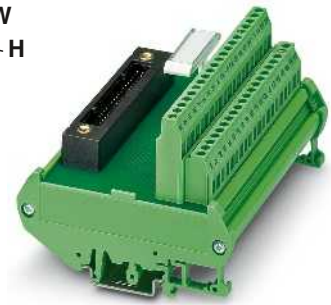

Passive interface modules

Technical data

| | |
|--|---|
| Max. perm. operating voltage | 24 V AC/DC ±10% |
| Max. perm. current (per branch) | 1 A |
| Test voltage (contact/contact) | 500 V (50 Hz, 1 min.) |
| Ambient temperature (operation) | -20°C ... 50°C |
| Mounting position | Any |
| Standards/regulations | DIN EN 50178, |
| Connection method | Screw connection |
| | Field level |
| | Control system level |
| Connection data solid / stranded / AWG | Yokogawa KS-compatible 0.2 ... 4 mm ² / 0.2 ... 2.5 mm ² / 24 - 12 |
| Dimensions | H / D 90 mm / 68 mm |

Ordering data

| Description | No. of pos. | Module width W | Type | Order No. | Pcs. / Pkt. |
|--|-------------|----------------|---------------|-----------|-------------|
| Controller board, for analog I/O modules | 40 | 112 mm | FLKM-KS40/YCS | 2314642 | 1 |

YOKOGAWA Centum CS3000 R3 Controller boards

These modules are connected to the I/O modules through the YUC system cable.

FLKMS-KS50/32IM/YCS:

- For digital modules ADV 151 and ADV 551
- Three-conductor connection (signal, plus, minus)
- Redundant voltage supply (fuse IEC 127-2, 5 x 20, 2 A)

For more cabling solutions for Yokogawa:
www.phoenixcontact.com

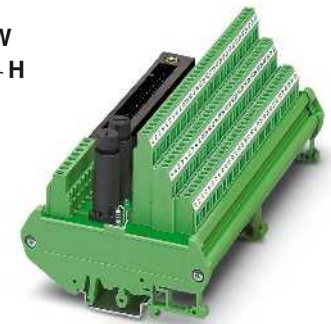

Passive interface modules

Technical data

| | |
|--|---|
| Max. perm. operating voltage | 24 V AC/DC ±10% |
| Max. perm. current (per branch) | 1 A |
| Test voltage (contact/contact) | 500 V (50 Hz, 1 min.) |
| Ambient temperature (operation) | -20°C ... 50°C |
| Mounting position | Any |
| Standards/regulations | DIN EN 50178, |
| Connection method | Screw connection |
| | Field level |
| | Control system level |
| Connection data solid / stranded / AWG | Yokogawa KS-compatible 0.2 ... 4 mm ² / 0.2 ... 2.5 mm ² / 24 - 12 |
| Dimensions | H / D 90 mm / 81 mm |

Ordering data

| Description | No. of pos. | Module width W | Type | Order No. | Pcs. / Pkt. |
|---|-------------|----------------|---------------------|-----------|-------------|
| Controller board, for digital I/O modules ADV 151 and ADV 551 | 50 | 174 mm | FLKMS-KS50/32IM/YCS | 2314451 | 1 |

YOKOGAWA Centum CS3000 R3 Controller boards

These modules are connected to the analog I/O modules through the 40-pos. YUC system cable.

The modules are designed for redundant signal transmission (two plug-in connectors in parallel). A separate connection to the HART multiplexer is possible.

FLKM-KS40/AO16/YCS

– For analog module AAI 543

FLKMS-KS40/SI/AI16/YCS

– For analog modules AAI 141 and AAI 143 (operation of modules in the 4-conductor mode)

- Transfer of 16 channels with separate positive and negative connections
- 16 plug-in fuses (IEC 127-2, 5 x 20, 0.1 A) per positive supply and LED status indicator
- Redundant voltage supply (fuse IEC 127-2, 5 x 20, 2 A)

FLKMS-KS40/AI/YCS

– For analog modules AAI 141 and AAI 143 (operation of modules in the 4-conductor mode)

- Transfer of 16 channels with separate positive and negative connections
- Redundant voltage supply (fuse IEC 127-2, 5 x 20, 2 A)

For more cabling solutions for Yokogawa:
www.phoenixcontact.com



Interface modules for analog I/O modules

| Technical data | |
|--|---|
| Max. perm. operating voltage | 24 V DC ±10% |
| Max. perm. current (per branch) | 100 mA |
| Test voltage (contact/contact) | 500 V (50 Hz, 1 min.) |
| Ambient temperature (operation) | -20°C ... 50°C |
| Mounting position | Any |
| Standards/regulations | DIN EN 50178, |
| Connection method | Screw connection |
| | Field level |
| | Control system level |
| Connection data solid / stranded / AWG | Yokogawa KS-compatible |
| Dimensions | 0.2 ... 4 mm ² / 0.2 ... 2.5 mm ² / 24 - 12 |
| | 126 mm / 68 mm |

| Description | No. of pos. | Module width W |
|---|-------------|----------------|
| Controller board , for analog output modules AAI 543 | 40 | 108 mm |
| Controller board , with fuses and LED, for analog input modules AAI 141 and AAI 143 | 40 | 214 mm |
| Controller board , for analog input modules AAI 141 and AAI 143, without fuses and LED | 40 | 214 mm |

| Ordering data | | |
|------------------------|-----------|-------------|
| Type | Order No. | Pcs. / Pkt. |
| FLKM-KS40/AO16/YCS | 2314260 | 1 |
| FLKMS-KS40/SI/AI16/YCS | 2314273 | 1 |
| FLKMS-KS40/AI/YCS | 2314286 | 1 |

System cabling for controllers

VARIOFACE system cabling

VIP termination boards for 8 channels

These VIP - VARIOFACE Professional modules are used in combination with 14-pos. system cables and the relevant front adapters.

Features:

- Byte-wise labeling
- For digital I/O modules
- Optionally with LED.

Notes:
For marking systems (e.g., "ZB 22:UNBEDRUCKT"; Order No. 0811862) and mounting material, see Catalog 5.



Passive interface modules for input/output with screw connection



Passive interface modules for input/output with push-in connection



| | |
|--|----------------------|
| Max. perm. operating voltage | |
| Max. perm. current (per branch) | |
| Max total current (voltage supply) | |
| Rated surge voltage | |
| Ambient temperature (operation) | |
| Mounting position | |
| Standards/regulations | |
| Connection method | Field level |
| | Control system level |
| Connection data solid / stranded / AWG | |
| Dimensions | H / D |

| Technical data | |
|---|---|
| VIP-2/.../FLK14/PLC | VIP-2/.../FLK14/LED/PLC |
| 60 V AC/DC | 24 V DC |
| 1 A | 1 A |
| 3 A | 3 A |
| 0.6 kV | 0.6 kV |
| -20°C ... 50°C | -20°C ... 50°C |
| Any | Any |
| IEC 60664, DIN EN 50178, IEC 62103 | IEC 60664, DIN EN 50178, IEC 62103 |
| Screw connection | Screw connection |
| IDC/FLK pin strip (2.54 mm) | IDC/FLK pin strip (2.54 mm) |
| 0.2 ... 4 mm ² / 0.2 ... 2.5 mm ² / 24 - 12 | 0.14 ... 2.5 mm ² / 0.14 ... 2.5 mm ² / 26 - 14 |
| 65.5 mm / 56 mm | 72.1 mm / 56 mm |

| Technical data | |
|---|---|
| VIP-2/.../FLK14/PLC | VIP-2/.../FLK14/LED/PLC |
| 60 V AC/DC | 24 V DC |
| 1 A | 1 A |
| 3 A | 3 A |
| 0.6 kV | 0.6 kV |
| -20°C ... 50°C | -20°C ... 50°C |
| Any | Any |
| IEC 60664, DIN EN 50178, IEC 62103 | IEC 60664, DIN EN 50178, IEC 62103 |
| Push-in connection | Push-in connection |
| IDC/FLK pin strip (2.54 mm) | IDC/FLK pin strip (2.54 mm) |
| 0.14 ... 2.5 mm ² / 0.14 ... 2.5 mm ² / 26 - 14 | 0.14 ... 2.5 mm ² / 0.14 ... 2.5 mm ² / 26 - 14 |
| 72.1 mm / 56 mm | 72.1 mm / 56 mm |

| Description | No. of pos. | Module width W |
|--|-------------|----------------|
| VARIOFACE interface module , for eight channels, | | |
| - with screw connection | 14 | 39.8 mm |
| - with push-in connection | 14 | 41.9 mm |
| VARIOFACE interface module , for eight channels with light indicator, | | |
| - with screw connection | 14 | 39.8 mm |
| - with push-in connection | 14 | 41.9 mm |

| Ordering data | | |
|------------------------|-----------|-------------|
| Type | Order No. | Pcs. / Pkt. |
| VIP-2/SC/FLK14/PLC | 2315214 | 1 |
| VIP-2/SC/FLK14/LED/PLC | 2322249 | 1 |

| Ordering data | | |
|------------------------|-----------|-------------|
| Type | Order No. | Pcs. / Pkt. |
| VIP-2/PT/FLK14/PLC | 2903801 | 1 |
| VIP-2/PT/FLK14/LED/PLC | 2904279 | 1 |

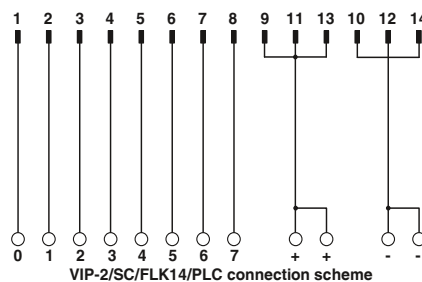

VIP termination boards for 32 channels

These VIP - VARIOFACE Professional modules are used in combination with 50-pos. system cables and the relevant front adapters.

Features:

- Byte-wise labeling
- For digital I/O modules
- Optionally with LED.

Notes:
For marking systems (e.g., "ZB 22:UNBEDRUCKT"; Order No. 0811862) and mounting material, see Catalog 5.



Passive interface modules for input/output with screw connection



Passive interface modules for input/output with push-in connection



| | |
|--|----------------------|
| Max. perm. operating voltage | |
| Max. perm. current (per branch) | |
| Max total current (voltage supply) | |
| Rated surge voltage | |
| Ambient temperature (operation) | |
| Mounting position | |
| Standards/regulations | |
| Connection method | Field level |
| | Control system level |
| Connection data solid / stranded / AWG | |
| Dimensions | H / D |

| Technical data | |
|---|------------------------------------|
| VIP-2/.../FLK50/PLC | VIP-2/.../FLK50/LED/PLC |
| 60 V AC/DC | 24 V DC |
| 1 A | 1 A |
| 2 A (per byte) | 2 A (per byte) |
| 0.6 kV | 0.6 kV |
| -20°C ... 50°C | -20°C ... 50°C |
| Any | Any |
| IEC 60664, DIN EN 50178, IEC 62103 | IEC 60664, DIN EN 50178, IEC 62103 |
| Screw connection | Screw connection |
| IDC/FLK pin strip (2.54 mm) | IDC/FLK pin strip (2.54 mm) |
| 0.2 ... 4 mm ² / 0.2 ... 2.5 mm ² / 24 - 12 | |
| 65.5 mm / 56 mm | |

| Technical data | |
|---|------------------------------------|
| VIP-2/.../FLK50/PLC | VIP-2/.../FLK50/LED/PLC |
| 60 V AC/DC | 24 V DC |
| 1 A | 1 A |
| 2 A (per byte) | 2 A (per byte) |
| 0.6 kV | 0.6 kV |
| -20°C ... 50°C | -20°C ... 50°C |
| Any | Any |
| IEC 60664, DIN EN 50178, IEC 62103 | IEC 60664, DIN EN 50178, IEC 62103 |
| Push-in connection | Push-in connection |
| IDC/FLK pin strip (2.54 mm) | IDC/FLK pin strip (2.54 mm) |
| 0.14 ... 2.5 mm ² / 0.14 ... 2.5 mm ² / 26 - 14 | |
| 72.1 mm / 56 mm | |

| Description | No. of pos. | Module width W |
|--|-------------|----------------|
| VARIOFACE interface module, for 32 channels, | | |
| - with screw connection | 50 | 106.1 mm |
| - with push-in connection | 50 | 107.9 mm |
| VARIOFACE interface module, for 32 channels with light indicator, | | |
| - with screw connection | 50 | 106.1 mm |
| - with push-in connection | 50 | 107.9 mm |

| Ordering data | | |
|------------------------|-----------|-------------|
| Type | Order No. | Pcs. / Pkt. |
| VIP-2/SC/FLK50/PLC | 2315227 | 1 |
| VIP-2/SC/FLK50/LED/PLC | 2322252 | 1 |

| Ordering data | | |
|------------------------|-----------|-------------|
| Type | Order No. | Pcs. / Pkt. |
| VIP-2/PT/FLK50/PLC | 2903803 | 1 |
| VIP-2/PT/FLK50/LED/PLC | 2904280 | 1 |



System cabling for controllers

VARIOFACE system cabling

VIP termination boards for SIMATIC® S7

These VIP - VARIOFACE Professional modules are used in combination with 50-pos. system cables and the relevant front adapters for SIMATIC® S7.

Features:

- Numerical marking
- Specifically for S7-300 or S7-400

Notes:
For marking systems (e.g., "ZB 22:UNBEDRUCKT"; Order No. 0811862) and mounting material, see Catalog 5.

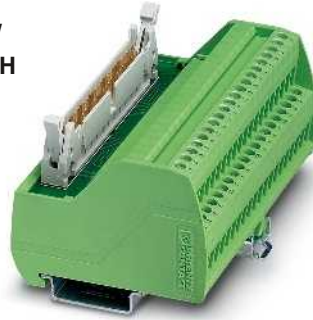

Passive interface modules for input/output, with SIMATIC®-specific marking and screw connection

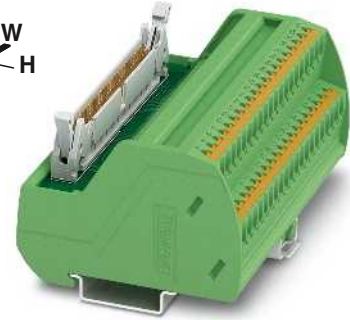

Passive interface modules for input/output, with SIMATIC®-specific marking and push-in connection

N



| | |
|--|---|
| Max. perm. operating voltage | 60 V AC/DC |
| Max. perm. current (per branch) | 1 A |
| Rated surge voltage | 0.6 kV |
| Ambient temperature (operation) | -20°C ... 50°C |
| Mounting position | Any |
| Standards/regulations | IEC 60664, DIN EN 50178, IEC 62103 |
| Connection method | Screw connection |
| | Field level |
| | Control system level |
| Connection data solid / stranded / AWG | 0.2 ... 4 mm ² / 0.2 ... 2.5 mm ² / 24 - 12 |
| Dimensions | 65.5 mm / 56 mm |

Technical data

Technical data

| | |
|--|---|
| Max. perm. operating voltage | 60 V AC/DC |
| Max. perm. current (per branch) | 1 A |
| Rated surge voltage | 0.6 kV |
| Ambient temperature (operation) | -20°C ... 50°C |
| Mounting position | Any |
| Standards/regulations | IEC 60664, DIN EN 50178, IEC 62103 |
| Connection method | Push-in connection |
| | Field level |
| | Control system level |
| Connection data solid / stranded / AWG | 0.14 ... 2.5 mm ² / 0.14 ... 2.5 mm ² / 26 - 14 |
| Dimensions | 72.1 mm / 56 mm |

Ordering data

Ordering data

| Description | No. of pos. | Module width W |
|---|-------------|----------------|
| VARIOFACE interface module, with SIMATIC® S7-300-specific marking from 1 to 40 | | |
| - with screw connection | 50 | 106.1 mm |
| - with push-in connection | 50 | 107.9 mm |
| VARIOFACE interface module, with SIMATIC® S7-400-specific marking from 3 to 48 | | |
| - with screw connection | 50 | 106.1 mm |
| - with push-in connection | 50 | 107.9 mm |

| Type | Order No. | Pcs. / Pkt. |
|---------------------------|-----------|-------------|
| VIP-2/SC/FLK50 (1-40) /S7 | 2315243 | 1 |
| VIP-2/SC/FLK50/S7/A-S400 | 2322359 | 1 |

| Type | Order No. | Pcs. / Pkt. |
|---------------------------|-----------|-------------|
| VIP-2/PT/FLK50 (1-40) /S7 | 2903804 | 1 |
| VIP-2/PT/FLK50/S7/A-S400 | 2904289 | 1 |

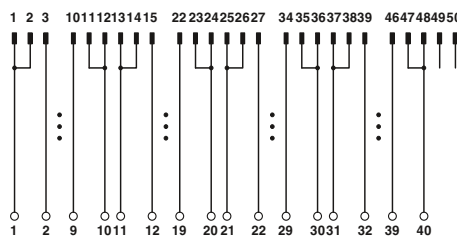

Connection scheme VIP-2/.../FLK50 (1-40) /S7

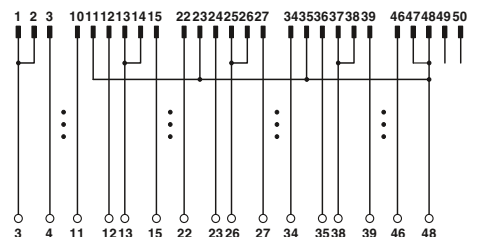

Connection scheme VIP-2/.../FLK50/S7/A-S400

VIP termination boards for MODICON® TSX Quantum and Allen-Bradley ControlLogix

These VIP - VARIOFACE Professional modules are used in combination with 50-pos. system cables and the relevant front adapters.

Features:

- Specific marking
- Specifically for MODICON TSX Quantum or ControlLogix

Notes:
For marking systems (e.g., "ZB 22:UNBEDRUCKT"; Order No. 0811862) and mounting material, see Catalog 5.



Passive interface modules for input/output, with specific marking and screw connection



Passive interface modules for input/output, with specific marking and push-in connection



| | |
|--|--|
| Max. perm. operating voltage | 60 V AC/DC |
| Max. perm. current (per branch) | 1 A |
| Rated surge voltage | 0.6 kV |
| Ambient temperature (operation) | -20°C ... 50°C |
| Mounting position | Any |
| Standards/regulations | IEC 60664, DIN EN 50178, IEC 62103 |
| Connection method | Screw connection |
| | Field level |
| | Control system level |
| Connection data solid / stranded / AWG | IDC/FLK pin strip (2.54 mm) 0.2 ... 4 mm ² / 0.2 ... 2.5 mm ² / 24 - 12 |
| Dimensions | 65.5 mm / 56 mm |

Technical data

| | |
|--|--|
| Max. perm. operating voltage | 60 V AC/DC |
| Max. perm. current (per branch) | 1 A |
| Rated surge voltage | 0.6 kV |
| Ambient temperature (operation) | -20°C ... 50°C |
| Mounting position | Any |
| Standards/regulations | IEC 60664, DIN EN 50178, IEC 62103 |
| Connection method | Push-in connection |
| | Field level |
| | Control system level |
| Connection data solid / stranded / AWG | IDC/FLK pin strip (2.54 mm) 0.14 ... 2.5 mm ² / 0.14 ... 2.5 mm ² / 26 - 14 |
| Dimensions | 72.1 mm / 56 mm |

Technical data

| | |
|--|--|
| Max. perm. operating voltage | 60 V AC/DC |
| Max. perm. current (per branch) | 1 A |
| Rated surge voltage | 0.6 kV |
| Ambient temperature (operation) | -20°C ... 50°C |
| Mounting position | Any |
| Standards/regulations | IEC 60664, DIN EN 50178, IEC 62103 |
| Connection method | Push-in connection |
| | Field level |
| | Control system level |
| Connection data solid / stranded / AWG | IDC/FLK pin strip (2.54 mm) 0.14 ... 2.5 mm ² / 0.14 ... 2.5 mm ² / 26 - 14 |
| Dimensions | 72.1 mm / 56 mm |

| Description | No. of pos. | Module width W |
|--|-------------|----------------|
| VARIOFACE interface module, with MODICON® TSX Quantum-specific marking from 1 to 40 | | |
| - with screw connection | 50 | 106.1 mm |
| - with push-in connection | 50 | 107.9 mm |
| VARIOFACE interface module, with ControlLogix-specific marking from 1 to 36 | | |
| - with screw connection | 50 | 95.9 mm |
| - with push-in connection | 50 | 97.7 mm |

Ordering data

| Type | Order No. | Pcs. / Pkt. |
|---------------------------|-----------|-------------|
| VIP-2/SC/FLK50/MODI-TSX/Q | 2322304 | 1 |
| VIP-2/SC/FLK50/AB-1756 | 2322317 | 1 |

Ordering data

| Type | Order No. | Pcs. / Pkt. |
|---------------------------|-----------|-------------|
| VIP-2/PT/FLK50/MODI-TSX/Q | 2904285 | 1 |
| VIP-2/PT/FLK50/AB-1756 | 2904286 | 1 |

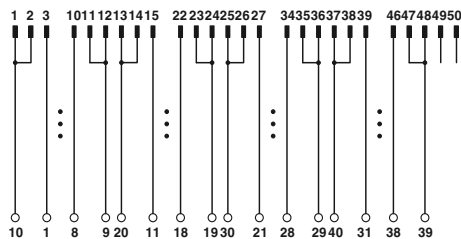

Connection scheme VIP-2/.../FLK50/MODI-TSX/Q

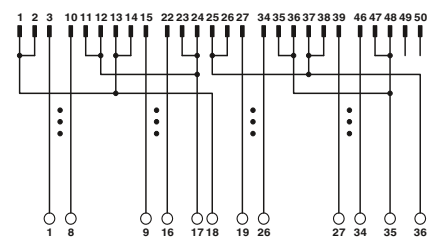

Connection scheme VIP-2/.../FLK50/AB-1756

System cabling for controllers

VARIOFACE system cabling

VIP termination boards for Siemens SIMATIC® S7-300

These VIP - VARIOFACE Professional modules are used in combination with two 14-pos. system cables and the relevant front adapters for Siemens SIMATIC® S7-300.

Features:

- Numerical labeling (1-20)
- Specifically for S7 300.

Notes:
For marking systems (e.g., "ZB 22:UNBEDRUCKT"; Order No, 0811862) and mounting material, see Catalog 5.

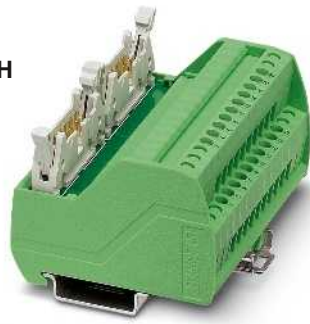

Passive interface modules for SIMATIC® S7-300 with screw connection



Passive interface modules for SIMATIC® S7-300 with push-in connection

N



| | |
|--|--|
| Max. perm. operating voltage | 60 V AC/DC |
| Max. perm. current (per branch) | 1 A |
| Rated surge voltage | 0.6 kV |
| Ambient temperature (operation) | -20°C ... 50°C |
| Mounting position | Any |
| Standards/regulations | IEC 60664, DIN EN 50178, IEC 62103 |
| Connection method | Screw connection |
| | Field level |
| | Control system level |
| Connection data solid / stranded / AWG | IDC/FLK pin strip (2.54 mm) 0.2 ... 4 mm ² / 0.2 ... 2.5 mm ² / 24 - 12 |
| Dimensions | 65.5 mm / 56 mm |

Technical data

Technical data

| | |
|--|--|
| Max. perm. operating voltage | 60 V AC/DC |
| Max. perm. current (per branch) | 1 A |
| Rated surge voltage | 0.6 kV |
| Ambient temperature (operation) | -20°C ... 50°C |
| Mounting position | Any |
| Standards/regulations | IEC 60664, DIN EN 50178, IEC 62103 |
| Connection method | Push-in connection |
| | Field level |
| | Control system level |
| Connection data solid / stranded / AWG | IDC/FLK pin strip (2.54 mm) 0.14 ... 2.5 mm ² / 0.14 ... 2.5 mm ² / 26 - 14 |
| Dimensions | 72.1 mm / 56 mm |

| Description | No. of pos. | Module width W |
|---|-------------|----------------|
| VARIOFACE interface module, with SIMATIC® S7-300-specific marking from 1 to 20 | | |
| - with screw connection | 14 | 80.6 mm |
| - with push-in connection | 14 | 82.5 mm |

Ordering data

Ordering data

| Type | Order No. | Pcs. / Pkt. |
|----------------------------|-----------|-------------|
| VIP-2/SC/2FLK14 (1-20) /S7 | 2315230 | 1 |

| Type | Order No. | Pcs. / Pkt. |
|----------------------------|-----------|-------------|
| VIP-2/PT/2FLK14 (1-20) /S7 | 2903802 | 1 |



Connection scheme: VIP-2/.../2FLK14 (1-20) /S7

VIP termination boards for Allen-Bradley

These VIP - VARIOFACE Professional modules are used in combination with two 14-pos. system cables and the relevant front adapters for Allen-Bradley.

Features:

- Numerical labeling (1-20)
- Specifically for ControlLogix.

Notes:
For marking systems (e.g., "ZB 22:UNBEDRUCKT"; Order No. 0811862) and mounting material, see Catalog 5.



Passive interface modules for Allen-Bradley ControlLogix with screw connection



Passive interface modules for Allen-Bradley ControlLogix with push-in connection



Technical data

| | |
|--|--|
| Max. perm. operating voltage | 60 V AC/DC |
| Max. perm. current (per branch) | 1 A |
| Rated surge voltage | 0.6 kV |
| Ambient temperature (operation) | -20°C ... 50°C |
| Mounting position | Any |
| Standards/regulations | IEC 60664, DIN EN 50178, IEC 62103 |
| Connection method | Screw connection |
| | Field level |
| | Control system level |
| Connection data solid / stranded / AWG | IDC/FLK pin strip (2.54 mm) 0.2 ... 4 mm ² / 0.2 ... 2.5 mm ² / 24 - 12 |
| Dimensions | 65.5 mm / 56 mm |

Technical data

| | |
|--|--|
| Max. perm. operating voltage | 60 V AC/DC |
| Max. perm. current (per branch) | 1 A |
| Rated surge voltage | 0.6 kV |
| Ambient temperature (operation) | -20°C ... 50°C |
| Mounting position | Any |
| Standards/regulations | IEC 60664, DIN EN 50178, IEC 62103 |
| Connection method | Push-in connection |
| | Field level |
| | Control system level |
| Connection data solid / stranded / AWG | IDC/FLK pin strip (2.54 mm) 0.2 ... 4 mm ² / 0.2 ... 2.5 mm ² / 24 - 12 |
| Dimensions | 72.1 mm / 56 mm |

Ordering data

| Description | No. of pos. | Module width W |
|--|-------------|----------------|
| VARIOFACE interface module, with ControlLogix-specific marking from 1 to 20 | | |
| - with screw connection | 14 | 80.6 mm |
| - with push-in connection | 14 | 82.5 mm |

| Type | Order No. | Pcs. / Pkt. |
|-------------------------|-----------|-------------|
| VIP-2/SC/2FLK14/AB-1756 | 2322333 | 1 |

Ordering data

| Type | Order No. | Pcs. / Pkt. |
|-------------------------|-----------|-------------|
| VIP-2/PT/2FLK14/AB-1756 | 2904288 | 1 |

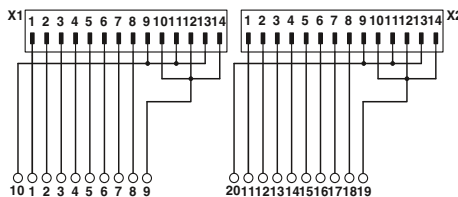

Connection scheme VIP-2.../2FLK14/AB-1756

System cabling for controllers

VARIOFACE system cabling

VIP termination boards with 2-conductor connection technology for 8 channels

These VIP VARIOFACE modules are used in combination with 14-pos. system cables and the relevant front adapters.

Features:

- Byte-wise labeling
- For digital I/O modules
- Negative or positive connection per signal.

Notes:
For marking systems (e.g., "ZB 22:UNBEDRUCKT"; Order No. 0811862) and mounting material, see Catalog 5.



Passive interface modules with screw connection



Passive interface modules with push-in connection



Technical data

| | |
|--|---|
| Max. perm. operating voltage | 60 V DC |
| Max. perm. current (per branch) | 1 A |
| Max total current (voltage supply) | 3 A (per byte) |
| Rated surge voltage | 0.6 kV |
| Ambient temperature (operation) | -20°C ... 50°C |
| Mounting position | Any |
| Standards/regulations | IEC 60664, DIN EN 50178, IEC 62103 |
| Connection method | Screw connection |
| | Field level |
| | Control system level |
| Connection data solid / stranded / AWG | 0.2 ... 4 mm ² / 0.2 ... 2.5 mm ² / 24 - 12 |
| Dimensions | 65.5 mm / 56 mm |

Ordering data

| Description | No. of pos. | Module width W |
|--|-------------|----------------|
| VARIOFACE interface module , for eight channels, each with an additional terminal block per signal for a common minus potential | | |
| - with screw connection | 14 | 50 mm |
| - with push-in connection | 14 | 52 mm |
| VARIOFACE interface module , for eight channels, each with an additional terminal block per signal for a common plus potential | | |
| - with screw connection | 14 | 50 mm |
| - with push-in connection | 14 | 52 mm |

| Type | Order No. | Pcs. / Pkt. |
|-----------------------|-----------|-------------|
| VIP-2/SC/FLK14/8M/PLC | 2322281 | 1 |
| VIP-2/SC/FLK14/8P/PLC | 2322294 | 1 |

Technical data

| | |
|--|---|
| Max. perm. operating voltage | 60 V DC |
| Max. perm. current (per branch) | 1 A |
| Max total current (voltage supply) | 3 A (per byte) |
| Rated surge voltage | 0.6 kV |
| Ambient temperature (operation) | -20°C ... 50°C |
| Mounting position | Any |
| Standards/regulations | IEC 60664, DIN EN 50178, IEC 62103 |
| Connection method | Push-in connection |
| | Field level |
| | Control system level |
| Connection data solid / stranded / AWG | 0.14 ... 2.5 mm ² / 0.14 ... 2.5 mm ² / 26 - 14 |
| Dimensions | 72.1 mm / 56 mm |

Ordering data

| Type | Order No. | Pcs. / Pkt. |
|-----------------------|-----------|-------------|
| VIP-2/PT/FLK14/8M/PLC | 2904283 | 1 |
| VIP-2/PT/FLK14/8P/PLC | 2904284 | 1 |

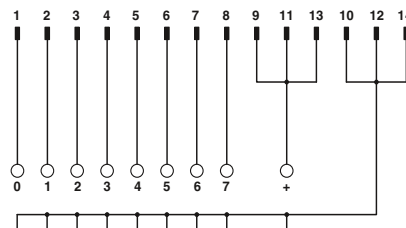

Connection scheme VIP-2/.../FLK14/8M/PLC

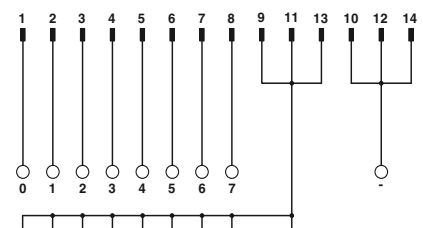

Connection scheme VIP-2/.../FLK14/8P/PLC

Termination boards with 2-conductor connection technology for 32 channels

These VARIOFACE modules are used in combination with 50-pos. system cables and the relevant front adapters.

The following module types with 2-conductor connection technology are available:

FLKM 50/32M/PLC

- Byte-wise labeling
- For digital I/O modules
- Negative connection for each signal.

FLKM 50/32P/PLC

- Byte-wise labeling
- For digital I/O modules
- Positive connection per signal.



Passive interface modules with screw connection



Technical data

| | |
|--|---|
| Max. perm. operating voltage | 60 V DC |
| Max. perm. current (per branch) | 1 A |
| Max total current (voltage supply) | 8 A (per byte) |
| Rated surge voltage | 0.8 kV |
| Ambient temperature (operation) | -20°C ... 50°C |
| Mounting position | Any |
| Standards/regulations | IEC 60664, DIN EN 50178, IEC 62103 |
| Connection method | Field level Control system level |
| Connection data solid / stranded / AWG | 0.2 ... 4 mm ² / 0.2 ... 2.5 mm ² / 24 - 12 |
| Dimensions | H / D 90 mm / 68 mm |

Ordering data

| Description | No. of pos. | Module width W | Type | Order No. | Pcs. / Pkt. |
|---|-------------|----------------|-----------------|-----------|-------------|
| VARIOFACE interface module, for 32 channels, each with an additional terminal block per signal for a common minus potential | 50 | 192 mm | FLKM 50/32M/PLC | 2289719 | 1 |
| VARIOFACE interface module, for 32 channels, each with an additional terminal block per signal for a common plus potential | 50 | 192 mm | FLKM 50/32P/PLC | 2291121 | 1 |

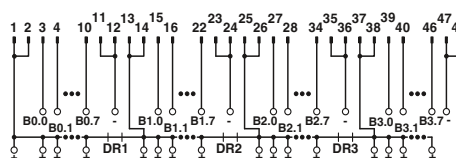

Connection scheme: FLKM 50/32P/PLC

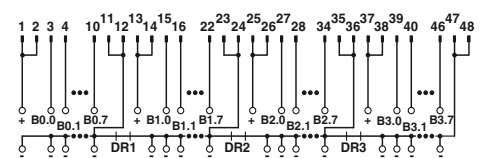

Connection scheme: FLKM 50/32M/PLC

System cabling for controllers

VARIOFACE system cabling

Termination boards with fuses with 2-conductor connection method

These VARIOFACE modules are used in combination with 14- or 50-pos. system cables and the relevant front adapters.

The following module types with fuses and 2-conductor connection technology are available:

FLKM 14/8M/SI/PLC (for 8 channels) FLKM 50/32M/SI/PLC (for 32 channels)

- Byte-wise labeling
- Can be used for digital I/O modules
- Plug-in fuse (IEC 127-3, 1AF) per signal path (F1)
- Plug-in fuse (IEC 127-3, 2AF) per voltage supply (F2)
- Negative connection for each signal.

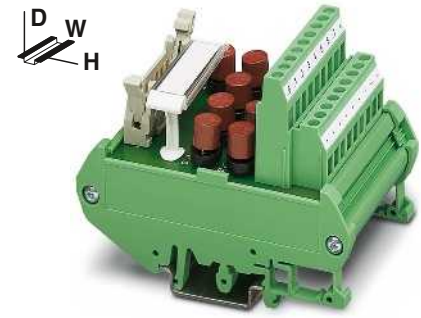

Passive fuse modules for 8 or 32 channels



Technical data

| FLKM 14/8M/SI/PLC | FLKM 50/32M/PLC |
|---|---|
| 60 V DC | 60 V DC |
| 1 A | 1 A |
| 2 A | 2 A (per byte) |
| 0.8 kV | 0.8 kV |
| -20°C ... 50°C | -20°C ... 50°C |
| Any | Any |
| IEC 60664, DIN EN 50178, IEC 62103 | IEC 60664, DIN EN 50178, IEC 62103 |
| Screw connection | Screw connection |
| Field level | Control system level |
| IDC/FLK pin strip (2.54 mm) | IDC/FLK pin strip (2.54 mm) |
| 0.2 ... 4 mm ² / 0.2 ... 2.5 mm ² / 24 - 12 | 0.2 ... 4 mm ² / 0.2 ... 2.5 mm ² / 24 - 12 |
| 90 mm / 68 mm | 90 mm / 68 mm |

| | |
|--|-------|
| Max. perm. operating voltage | |
| Max. perm. current (per branch) | |
| Max total current (voltage supply) | |
| Rated surge voltage | |
| Ambient temperature (operation) | |
| Mounting position | |
| Standards/regulations | |
| Connection method | |
| Connection data solid / stranded / AWG | |
| Dimensions | H / D |

Ordering data

| Description | No. of pos. | Module width W |
|--|-------------|----------------|
| VARIOFACE module, for eight channels, each with an additional terminal block and fuse per signal, (common minus potential) | 14 | 57 mm |
| VARIOFACE module, for 32 channels, each with an additional terminal block and fuse per signal, (common minus potential) | 50 | 192 mm |

| Type | Order No. | Pcs. / Pkt. |
|--------------------|-----------|-------------|
| FLKM 14/8M/SI/PLC | 2294487 | 1 |
| FLKM 50/32M/SI/PLC | 2294490 | 1 |

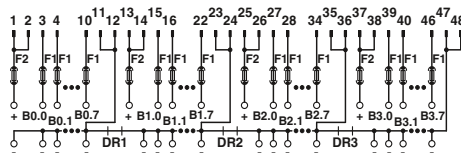

Connection scheme: FLKM 50/32M/SI/PLC

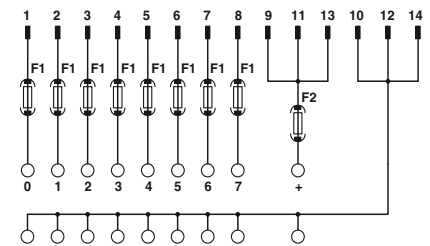

Connection scheme: FLKM 14/8M/SI/PLC

VIP initiator modules for 8 channels

These VIP - VARIOFACE Professional modules are used in combination with 14-pos. system cables and the relevant front adapters.

Features:

- Byte-wise labeling
- For digital I/O modules
- Positive and negative connection per signal
- Optionally with LED.

Notes:
For marking systems (e.g., "ZB 22:UNBEDRUCKT"; Order No. 0811862) and mounting material, see Catalog 5.



Initiator modules with screw connection

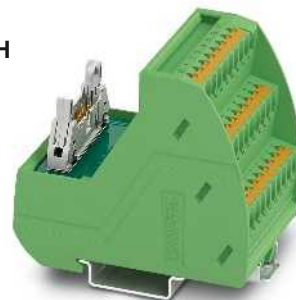

Initiator modules with push-in connection



| | |
|--|----------------------|
| Max. perm. operating voltage | |
| Max. perm. current (per branch) | |
| Max total current (voltage supply) | |
| Rated surge voltage | |
| Ambient temperature (operation) | |
| Mounting position | |
| Standards/regulations | |
| Connection method | Field level |
| | Control system level |
| Connection data solid / stranded / AWG | H / D |
| Dimensions | |

| Technical data | |
|---|-----------------------------|
| VIP-3/SC/FLK14/8IM/PLC | VIP-3/SC/FLK14/8IM/LED/PLC |
| 60 V DC | 24 V DC |
| 1 A | 1 A |
| 3 A | 3 A |
| 0.6 kV | 0.6 kV |
| -20°C ... 50°C | -20°C ... 50°C |
| Any | Any |
| IEC 60664, DIN EN 50178, IEC 62103 | |
| Screw connection | Screw connection |
| IDC/FLK pin strip (2.54 mm) | IDC/FLK pin strip (2.54 mm) |
| 0.2 ... 4 mm ² / 0.2 ... 2.5 mm ² / 24 - 12 | |
| 69 mm / 62 mm | |

| Technical data | |
|---|-----------------------------|
| VIP-3/PT/FLK14/8IM/PLC | VIP-3/PT/FLK14/8IM/LED/PLC |
| 60 V DC | 24 V DC |
| 1 A | 1 A |
| 3 A | 3 A |
| 0.6 kV | 0.6 kV |
| -20°C ... 50°C | -20°C ... 50°C |
| Any | Any |
| IEC 60664, DIN EN 50178, IEC 62103 | |
| Push-in connection | Push-in connection |
| IDC/FLK pin strip (2.54 mm) | IDC/FLK pin strip (2.54 mm) |
| 0.14 ... 2.5 mm ² / 0.14 ... 2.5 mm ² / 26 - 14 | |
| 75.8 mm / 63 mm | |

| Description | No. of pos. | Module width W |
|---|-------------|----------------|
| VARIOFACE initiator module , for connecting 8 PNP initiators, with an additional positive and negative terminal block each per signal | | |
| - with screw connection | 14 | 52.3 mm |
| - with push-in connection | 14 | 52 mm |
| VARIOFACE initiator module with LED , for connecting 8 PNP initiators, with an additional positive and negative terminal block each per signal | | |
| - with screw connection | 14 | 52.3 mm |
| - with push-in connection | 14 | 52 mm |

| Ordering data | | |
|----------------------------|-----------|-------------|
| Type | Order No. | Pcs. / Pkt. |
| VIP-3/SC/FLK14/8IM/PLC | 2322278 | 1 |
| VIP-3/SC/FLK14/8IM/LED/PLC | 2322265 | 1 |

| Ordering data | | |
|----------------------------|-----------|-------------|
| Type | Order No. | Pcs. / Pkt. |
| VIP-3/PT/FLK14/8IM/PLC | 2904282 | 1 |
| VIP-3/PT/FLK14/8IM/LED/PLC | 2904281 | 1 |

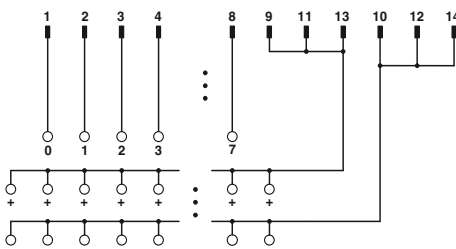

Connection scheme VIP-3/.../FLK14/8IM/PLC

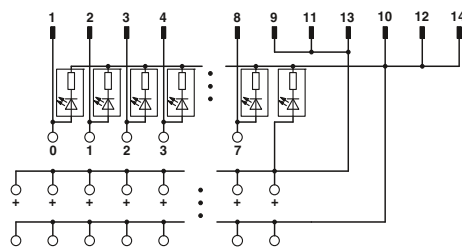

Connection scheme VIP-3/.../FLK14/8IM/LED/PLC

System cabling for controllers

VARIOFACE system cabling

Initiator modules for 32 channels

These VARIOFACE modules are used in combination with 50-pos. system cables and the relevant front adapters for digital I/O modules.

Features:

- Byte-wise labeling
- Positive and negative connection per signal
- Optionally with LED

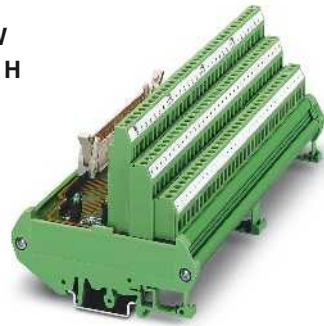

Initiator modules for 32 channels, with screw connection

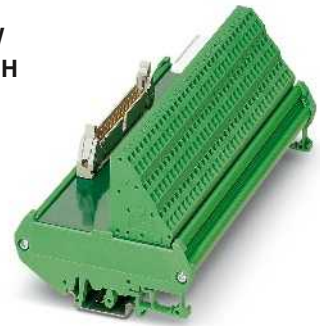

Initiator modules for 32 channels, with spring-cage connection



Max. perm. operating voltage
 Max. perm. current (per branch)
 Max total current (voltage supply)
 Status indication
 Rated surge voltage
 Ambient temperature (operation)
 Mounting position
 Standards/regulations
 Connection method

Field level
 Control system level

Connection data solid / stranded / AWG
 Dimensions

H / D

Technical data

| | |
|------------------------------------|------------------------------------|
| ... 50/32 IM | ... 50/32 IM/LA |
| 60 V DC | 20 V DC (up to 30 V DC) |
| 1 A | 1 A |
| 2 A (per byte) | 2 A (per byte) |
| No | LED |
| 0.8 kV | 0.8 kV |
| -20°C ... 50°C | -20°C ... 50°C |
| Any | Any |
| IEC 60664, DIN EN 50178, IEC 62103 | IEC 60664, DIN EN 50178, IEC 62103 |
| Screw connection | Screw connection |
| IDC/FLK pin strip (2.54 mm) | IDC/FLK pin strip (2.54 mm) |

0.2 ... 4 mm² / 0.2 ... 2.5 mm² / 24 - 12
 90 mm / 81 mm

Technical data

60 V DC
 1 A
 2 A (per byte)
 -
 0.6 kV
 -20°C ... 50°C
 Any
 DIN EN 50178,
 Spring-cage connection
 IDC/FLK pin strip (2.54 mm)

0.2 ... 2.5 mm² / 0.2 ... 1.5 mm² / 24 - 12
 90 mm / 73.5 mm

Ordering data

| Type | Order No. | Pcs. / Pkt. |
|----------------------|-----------|-------------|
| FLKMS 50/32IM/PLC | 2284523 | 1 |
| FLKMS 50/32IM/LA/PLC | 2284510 | 1 |

Ordering data

| Type | Order No. | Pcs. / Pkt. |
|-------------------------|-----------|-------------|
| FLKMS 50/32IM/ZFKDS/PLC | 2901389 | 1 |

| Description | No. of pos. | Module width W |
|--|-------------|----------------|
| VARIOFACE initiator module, for connection of 32 PNP initiators | 50 | 180 mm |
| VARIOFACE initiator module, same as before, however with light indicator | 50 | 180 mm |
| VARIOFACE initiator module, for connection of 32 PNP initiators | 50 | 180 mm |

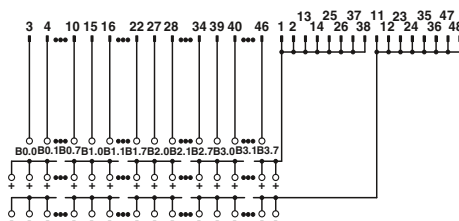

Connection scheme: FLKMS 50/32IM/PLC, ...50/32IM/ZFKDS/PLC

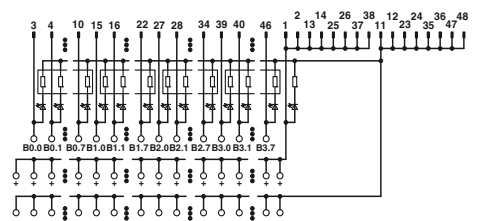

FLKMS 50/32IM/LA/PLC connection scheme

COMPACT-LINE initiator modules with spring-cage connection

These VARIOFACE modules are used in combination with 14- and 50-pos. system cables and the relevant front adapters.

The following COMPACT-LINE initiator modules are available:

UM 45-FLK14/8IM/.../PLC (for 8 channels)

UM 45-FLK 50/32IM/.../PLC (for 32 channels)

- Byte-wise labeling
- Can be used for digital I/O modules
- Positive and negative connection for every signal

Notes:
Due to the geometry, it is not possible to couple any molded FLK connectors (e.g., VIP-PA...S7).



Sensor modules for 8 or 32 channels With spring-cage connection



| | |
|--|---|
| Max. perm. operating voltage | 60 V DC |
| Max. perm. current (per branch) | 1 A |
| Max total current (voltage supply) | 3 A |
| Rated surge voltage | 0.8 kV |
| Ambient temperature (operation) | -20°C ... 50°C |
| Mounting position | Any |
| Standards/regulations | IEC 60664, DIN EN 50178, IEC 62103 |
| Connection method | Field level Control system level |
| Connection data solid / stranded / AWG | 0.2 ... 2.5 mm ² / 0.2 ... 1.5 mm ² / 24 - 14 |
| Dimensions | H / D 45 mm / 61 mm |

| Technical data | | |
|------------------------------------|-----------------------------|--|
| UM 45-FLK 14/.../PLC | UM 45-FLK 50/.../PLC | |
| 60 V DC | 60 V DC | |
| 1 A | 1 A | |
| 3 A | 2 A (per byte) | |
| 0.8 kV | 0.8 kV | |
| -20°C ... 50°C | -20°C ... 50°C | |
| Any | Any | |
| IEC 60664, DIN EN 50178, IEC 62103 | | |
| Spring-cage connection | Spring-cage connection | |
| IDC/FLK pin strip (2.54 mm) | IDC/FLK pin strip (2.54 mm) | |

| Description | No. of pos. | Module width W |
|---|-------------|----------------|
| VARIOFACE-COMPACT-LINE initiator module, for connection of eight PNP initiators | 14 | 75 mm |
| VARIOFACE-COMPACT-LINE initiator module, for connection of 32 PNP initiators | 50 | 197 mm |

| Ordering data | | |
|----------------------------|-----------|-------------|
| Type | Order No. | Pcs. / Pkt. |
| UM 45-FLK14/ 8IM/ZFKDS/PLC | 2965211 | 1 |
| UM 45-FLK50/32IM/ZFKDS/PLC | 2965224 | 1 |



UM 45-FLK50/32IM/ZFKDS/PLC connection scheme



UM 45-FLK14/8IM/ZFKDS/PLC connection scheme

System cabling for controllers

VARIOFACE system cabling

Controller boards with knife disconnect terminal blocks

These VARIOFACE modules with knife disconnection and test connection for each signal (2 or 2.3 mm Ø test plug) are used in combination with the respective front adapters.

FLKM14/KDS3-MT/PPA/PLC

(for 8 channels)

FLKM 50/KDS3-MT/PPA/PLC

(for 32 channels)

- Byte-wise labeling
- Can be used for digital I/O modules

FLKM-2FLK14/KDS3-MT/PPA/S7

- Numerical labeling (1-20)
- Specially for S7-300 (in conjunction with the front adapter FLKM 14-PA-S300, Order No.: 2299770)

FLKM 50/KDS3-MT/PPA/7-300

- Numerical labeling (1-40)
- Specially for S7-300 (in conjunction with the front adapter FLKM 50-PA-S300, Order No.: 2294445).

FLKM 50/KDS3-MT/PPA/AN/PLC

- Numerical labeling (1-50)
- Specially for S7-400 (in conjunction with the front adapter FLKM 50-PA-S400 (3-48) Order No.: 2294908).

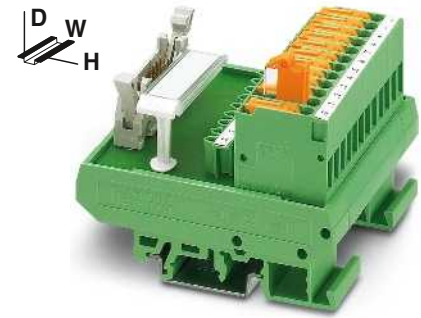

Passive interface modules for 8 or 32 channels with knife disconnect terminal blocks



Technical data

| FLKM...14/KDS 3-MT... | FLKM 50/KDS 3-MT... |
|---|--|
| 60 V DC | 60 V DC |
| 1 A | 1 A |
| 3 A | 2 A (per byte) |
| 0.8 kV | 0.8 kV |
| -20°C ... 50°C | -20°C ... 50°C |
| Any | Any |
| IEC 60664, DIN EN 50178, IEC 62103 | |
| Screw connection with disconnect knife | Screw connection with disconnect knife |
| IDC/FLK pin strip (2.54 mm) | IDC/FLK pin strip (2.54 mm) |
| 0.2 ... 4 mm ² / 0.2 ... 2.5 mm ² / 24 - 12 | |
| 77 mm / 61 mm | |

Ordering data

| Type | Order No. | Pcs. / Pkt. |
|----------------------------|-----------|-------------|
| FLKM 14/KDS3-MT/PPA/PLC | 2290423 | 1 |
| FLKM 50/KDS3-MT/PPA/PLC | 2290614 | 1 |
| FLKM-2FLK14/KDS3-MT/PPA/S7 | 2295062 | 1 |
| FLKM 50/KDS3-MT/PPA/S7-300 | 2304490 | 1 |
| FLKM 50/KDS3-MT/PPA/AN/PLC | 2291587 | 1 |

| | |
|--|----------------------|
| Max. perm. operating voltage | Field level |
| Max. perm. current (per branch) | Control system level |
| Max total current (voltage supply) | |
| Rated surge voltage | |
| Ambient temperature (operation) | |
| Mounting position | |
| Standards/regulations | |
| Connection method | |
| Connection data solid / stranded / AWG | H / D |
| Dimensions | |

| Description | No. of pos. | Module width W |
|--|-------------|----------------|
| VARIOFACE interface module , for eight channels, with knife disconnect terminal blocks and test sockets to the field and the system | 14 | 67 mm |
| VARIOFACE interface module , for 32 channels, with knife disconnect terminal blocks and test sockets to the field and the system | 50 | 214 mm |
| VARIOFACE interface module , for SIMATIC S7-300 with SIMATIC-specific labeling (1-20), knife disconnect terminal blocks, and test sockets to the field and the system | 14 | 113 mm |
| VARIOFACE interface module , same as before, however, with SIMATIC-specific labeling (1-40) | 50 | 214 mm |
| VARIOFACE interface module , same as before, however, for SIMATIC S7-400 with SIMATIC-specific labeling (3-48) | 50 | 259 mm |

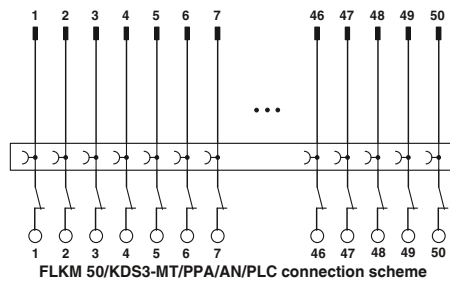

FLKM 50/KDS3-MT/PPA/AN/PLC connection scheme

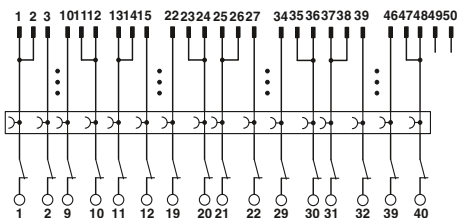

FLKM 50/KDS3-MT/PPA/S7-300 connection scheme

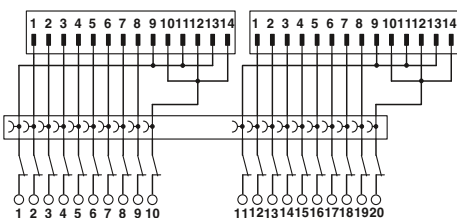

FLKM-2FLK14/KDS3-MT/PPA/S7 connection scheme

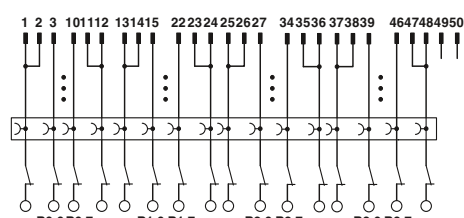

FLKM 50/KDS3-MT/PPA/PLC connection scheme

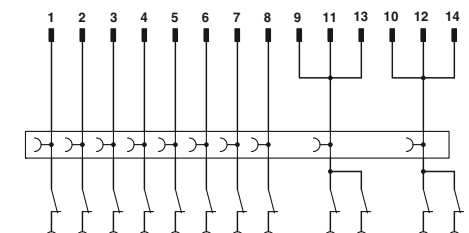

FLKM 14/KDS3-MT/PPA/PLC connection scheme

Simulation module with switches

These VARIOFACE modules enable simple simulation of the control and peripheral hardware for 8 signals.

The UM 45-DI/DO/S/LA/SIM8 switch module is assembled for signal transmission with COMBICON screw connector for single-conductor wiring. Alternatively, connection to the PLC system cabling is established through a 14-pos. flat-ribbon cable pin strip. Connection to the front adapters of the PLC system cabling is established through 14-pos. system cables with socket strips.

Each signal path is allocated an LED which signals the “high active” signal state. The supply voltage to the modules is signaled via a green LED.

| |
|---|
| Notes: |
| Type of housing: Terminal blocks: Polyamide PA non-reinforced, color: green. Housing: PVC |
| Marking systems and mounting material See Catalog 5 |

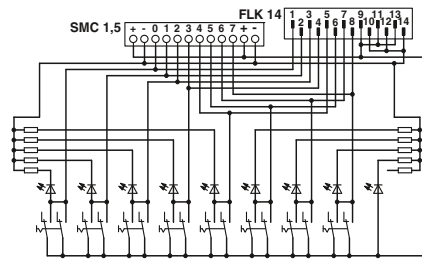

| | |
|--|---|
| Max. perm. operating voltage | 24 V DC |
| Max. perm. current (per branch) | 1 A |
| Max total current (voltage supply) | 8 A (+, - terminal block) |
| Rated surge voltage | 0.8 kV |
| Ambient temperature (operation) | -20°C ... 50°C |
| Mounting position | Any |
| Standards/regulations | IEC 60664, DIN EN 50178, IEC 62103 |
| Connection data solid / stranded / AWG | 0.14 ... 1.5 mm ² / 0.14 ... 1.5 mm ² / 28 - 16 |
| Dimensions | 45 mm / 51 mm |

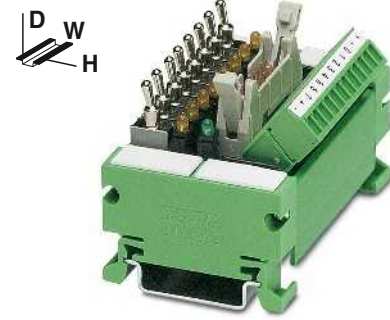

Switch module

Technical data

| Description | No. of pos. | Module width W |
|---|-------------|----------------|
| VARIOFACE switch module, for simulation | | 75 mm |

| Ordering data | | |
|-----------------------|-----------|-------------|
| Type | Order No. | Pcs. / Pkt. |
| UM 45-DI/DO/S/LA/SIM8 | 2968205 | 1 |

Simulation module for display

These VARIOFACE modules enable simple simulation of the control and peripheral hardware for 8 signals.

The UM 45-DO/LA/SIM8 display module is assembled for signal transmission with COMBICON screw connector for single-conductor wiring. Alternatively, connection to the PLC system cabling is established through a 14-pos. flat-ribbon cable pin strip. Connection to the front adapters of the PLC system cabling is established through 14-pos. system cables with socket strips.

Each signal path is allocated an LED which signals the “high active” signal state. The supply voltage to the modules is signaled via a green LED.

| |
|---|
| Notes: |
| Type of housing: Terminal blocks: Polyamide PA non-reinforced, color: green. Housing: PVC |
| Marking systems and mounting material See Catalog 5 |

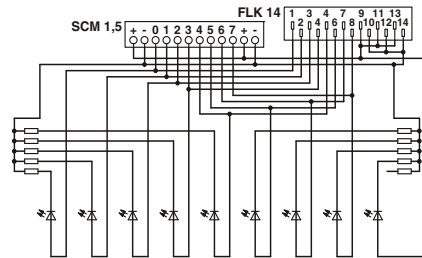

| | |
|--|---|
| Max. perm. operating voltage | 24 V DC |
| Max. perm. current (per branch) | 1 A |
| Max total current (voltage supply) | 8 A (+, - terminal block) |
| Rated surge voltage | 0.8 kV |
| Ambient temperature (operation) | -20°C ... 50°C |
| Mounting position | Any |
| Standards/regulations | IEC 60664, DIN EN 50178, IEC 62103 |
| Connection data solid / stranded / AWG | 0.14 ... 1.5 mm ² / 0.14 ... 1.5 mm ² / 28 - 16 |
| Dimensions | 45 mm / 51 mm |

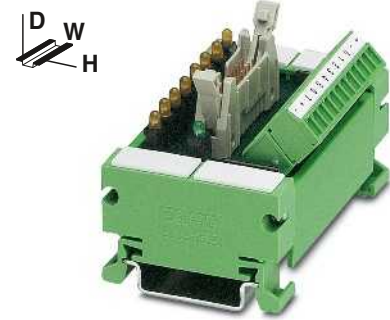

Indicator module

Technical data

| Description | No. of pos. | Module width W |
|--|-------------|----------------|
| VARIOFACE display module, for simulation | | 75 mm |

| Ordering data | | |
|------------------|-----------|-------------|
| Type | Order No. | Pcs. / Pkt. |
| UM 45-DO/LA/SIM8 | 2968195 | 1 |

VARIOFACE system cabling

Adapter for PLC-INTERFACE (6.2 mm)

PLC-V8/... are the VARIOFACE adapters connecting the eight slim 6.2 mm PLC-INTERFACE modules to the VARIOFACE system cabling:

- Can be plugged into the bridge shafts of eight aligned PLC-INTERFACE modules
- Freely definable configuration with relays, optocouplers, and passive feed-through terminal blocks
- With D-SUB connection as an option for universal connections

Notes:
For cross-reference list with matching PLC-INTERFACE modules, see page 488



VARIOFACE adapter for 6.2 mm PLC-INTERFACE



Technical data

| | |
|--|--|
| Max. perm. operating voltage | 24 V DC ±25% |
| Max. perm. current (per branch) | 1 A (per signal path) |
| Max total current (voltage supply) | 3 A |
| Rated surge voltage | 0.8 kV |
| Ambient temperature (operation) | -40°C ... 70°C |
| Standards/regulations | IEC 60664, DIN EN 50178, IEC 62103 |
| Connection method | Screw connection |
| | Power supply |
| | Signal level |
| Connection data solid / stranded / AWG | IDC/FLK pin strip (2.54 mm) 0.2 ... 4 mm ² / 0.2 ... 2.5 mm ² / 24 - 12 |
| Dimensions | 100 mm / 94 mm |

Ordering data

| Description | No. of pos. | Module width W | Type | Order No. | Pcs. / Pkt. |
|---|-------------|----------------|--------------------|-----------|-------------|
| V8 adapter, for 8 PLC interfaces (6.2 mm), with FLK connection, for PLC system cabling, positive switching | | | | | |
| OUTPUT | 14 | 49.6 mm | PLC-V8/FLK14/OUT | 2295554 | 1 |
| INPUT | 14 | 49.6 mm | PLC-V8/FLK14/IN | 2296553 | 1 |
| V8 adapter, for 8 PLC interfaces (6.2 mm), with FLK connection, for PLC system cabling, negative switching | | | | | |
| OUTPUT | 14 | 49.6 mm | PLC-V8/FLK14/OUT/M | 2304102 | 1 |
| INPUT | 14 | 49.6 mm | PLC-V8/FLK14/IN/M | 2304115 | 1 |
| V8 output adapter, for 8 PLC interfaces (6.2 mm), with 15-pos. D-SUB connection | | | | | |
| Pin strip | 15 | 49.6 mm | PLC-V8/D15S/OUT | 2296058 | 1 |
| Socket strip | 15 | 49.6 mm | PLC-V8/D15B/OUT | 2296061 | 1 |
| V8 input adapter, for 8 PLC interfaces (6.2 mm), with 15-pos. D-SUB connection | | | | | |
| Pin strip | 15 | 49.6 mm | PLC-V8/D15S/IN | 2296074 | 1 |
| Socket strip | 15 | 49.6 mm | PLC-V8/D15B/IN | 2296087 | 1 |

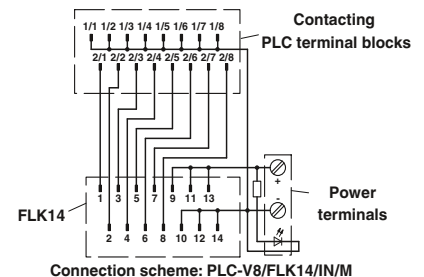
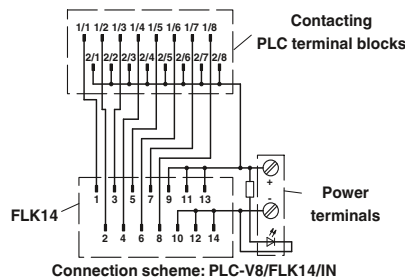
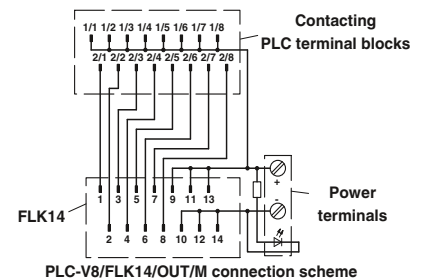
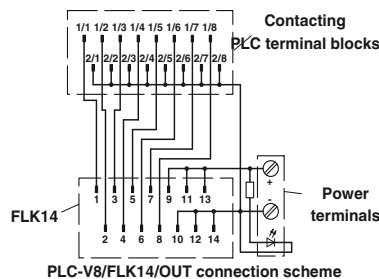

Adapter for PLC-INTERFACE (14 mm)

PLC-V8L/... are the VARIOFACE adapters connecting the eight 14 mm PLC-INTERFACE modules (2 PDT, HC, and IC types) to the system cabling:

- Can be plugged into the bridge shafts of eight aligned PLC-INTERFACE modules
- Freely selectable assembly with relays or optocouplers

Notes:
For cross-reference list with matching PLC-INTERFACE modules, see page 488



VARIOFACE adapter for 14 mm PLC-INTERFACE



Technical data

| | |
|--|---|
| Max. perm. operating voltage | 24 V DC ±25% |
| Max. perm. current (per branch) | 1 A (per signal path) |
| Max total current (voltage supply) | 3 A |
| Rated surge voltage | 0.8 kV |
| Ambient temperature (operation) | -40°C ... 70°C |
| Mounting position | Any |
| Standards/regulations | IEC 60664, DIN EN 50178, IEC 62103 |
| Connection method | Power supply Screw connection |
| | Signal level IDC/FLK pin strip (2.54 mm) |
| Connection data solid / stranded / AWG | 0.2 ... 4 mm ² / 0.2 ... 2.5 mm ² / 24 - 12 |
| Dimensions | H / D 100 mm / 94 mm |

Ordering data

| Description | No. of pos. | Module width W | Type | Order No. | Pcs. / Pkt. |
|--|-------------|----------------|---------------------|-----------|-------------|
| V8 adapter, for 8 PLC interfaces (14 mm), with FLK connection, for PLC system cabling, positive switching | 14 | 112.3 mm | PLC-V8L/FLK14/OUT | 2299660 | 1 |
| V8 adapter, for 8 PLC interfaces (14 mm), with FLK connection, for PLC system cabling, negative switching | 14 | 112.3 mm | PLC-V8L/FLK14/OUT/M | 2304306 | 1 |

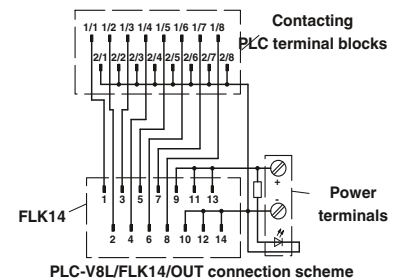

VARIOFACE system cabling

Feed-through terminal blocks for PLC-INTERFACE

The VARIOFACE PLC-VT terminals are passive feed-through terminal blocks, with the same shape as the 6.2 mm slim relay and PLC-INTERFACE optocoupler interfaces. This makes it possible to implement 8-channel interface blocks for the system cabling, which can be adapted to a bit for the particular application. For individual requirements, the relay, optocoupler or the PLC-VT terminal blocks for passive signal transmission can be combined as needed.

PLC-VT PLC-VT/LA

- Can be combined with PLC-INTERFACE universal series
- Signal path with additional potential level for free assignment (two-conductor connection)
- Optionally with LED

| | |
|--|-------|
| Max. perm. operating voltage | |
| Max. perm. current (per branch) | |
| Ambient temperature (operation) | |
| Mounting position | |
| Standards/regulations | |
| Connection data solid / stranded / AWG | |
| Dimensions | H / D |

| Description | No. of pos. | Module width W |
|---|-------------|----------------|
| VARIOFACE feed-through terminal block (two-conductor connection), for PLC-INTERFACE universal series | | 6.2 mm |
| VARIOFACE feed-through terminal block , same as before, however, with 24 V DC light indicator | | 6.2 mm |



VARIOFACE feed-through terminal blocks for PLC-INTERFACE universal series



| Technical data | |
|---|----------------------------|
| PLC-VT | PLC-VT/LA |
| max. 250 V AC/DC | 24 V DC |
| 6 A (per signal conductor) | 6 A (per signal conductor) |
| -40°C ... 70°C | -40°C ... 70°C |
| Any | Any |
| DIN EN 50178, IEC 62103 | |
| 0.2 ... 4 mm ² / 0.2 ... 2.5 mm ² / 24 - 12 | |
| 80 mm / 94 mm | |

| Ordering data | | |
|---------------|-----------|-------------|
| Type | Order No. | Pcs. / Pkt. |
| PLC-VT | 2296870 | 10 |
| PLC-VT/LA | 2296854 | 10 |



PLC-VT connection scheme

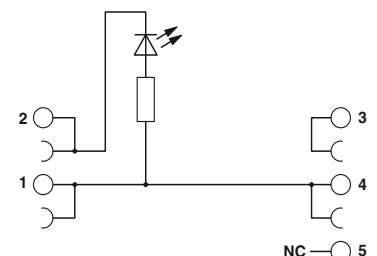

PLC-VT/LA connection scheme

Feed-through terminal blocks for PLC-INTERFACE

The VARIOFACE PLC-VT terminals are passive feed-through terminal blocks, with the same shape as the 6.2 mm slim relay and PLC-INTERFACE optocoupler interfaces. This makes it possible to implement 8-channel interface blocks for the system cabling, which can be adapted to a bit for the particular application. For individual requirements, the relay, optocoupler or the PLC-VT terminal blocks for passive signal transmission can be combined as needed.

PLC-VT/ACT PLC-VT/ACT/LA

- Can be combined with PLC-INTERFACE actuator series
- Signal path with two additional potential levels for free assignment (three-conductor connection)
- Optionally with LED

The system connection is made via the PLC-V8 adapter.



VARIOFACE feed-through terminal blocks for PLC-INTERFACE actuator series



| | |
|---------------------------------|--|
| Max. perm. operating voltage | Max. perm. current (per branch) |
| Ambient temperature (operation) | Mounting position |
| Standards/regulations | Connection data solid / stranded / AWG |
| Dimensions | H / D |

| Technical data | |
|--|--|
| PLC-VT/AKT max. 250 V AC/DC 6 A (per signal conductor) | PLC-VT/AKT/LA 24 V DC 6 A (per signal conductor) |
| -40°C ... 70°C Any DIN EN 50178, IEC 62103 0.2 ... 4 mm ² / 0.2 ... 2.5 mm ² / 24 - 12 80 mm / 94 mm | -40°C ... 70°C Any |

| Description | No. of pos. | Module width W |
|---|-------------|----------------|
| VARIOFACE feed-through terminal block (three-conductor connection), for PLC-INTERFACE actuator series | | 6.2 mm |
| VARIOFACE feed-through terminal block, same as before, however, with 24 V DC light indicator | | 6.2 mm |

| Ordering data | | |
|---------------|-----------|-------------|
| Type | Order No. | Pcs. / Pkt. |
| PLC-VT/ACT | 2295567 | 10 |
| PLC-VT/ACT/LA | 2296867 | 10 |



PLC-VT/ACT connection scheme



PLC-VT/ACT/LA connection scheme

Cross-reference list for PLC-V8 adapters with matching PLC-INTERFACE modules

Series



| Function | Contact | Input | Output | Page | Spring-cage connection | Order No.: | |
|-------------------|---------------|---------------------------------------|---------------------------------------|--------------------------------|--------------------------|----------------------------|-----------------------|
| Relay | 1 PDT | 24 V DC | 250 V AC/DC / 6 A | 322 | PLC-RSP-24DC/21 | 2966472 | |
| | | 24 V DC | 250 V AC/DC / 10 A | 333 | PLC-RSP-24DC/21HC | 2912277 | |
| | | 12 V DC | 30 V AC/36 V DC / 50 mA | 323 | PLC-RSP-12DC/21AU | 2967442 | |
| | | 24 V DC | 30 V AC/36 V DC / 50 mA | 323 | PLC-RSP-24DC/21AU | 2966540 | |
| | | 24 V AC/DC | 30 V AC/36 V DC / 50 mA | 323 | PLC-RSP-24UC/21AU | 2966553 | |
| | | 48 V DC | 30 V AC/36 V DC / 50 mA | 323 | PLC-RSP-48DC/21AU | 2966566 | |
| | | 60 V DC | 30 V AC/36 V DC / 50 mA | 323 | PLC-RSP-60DC/21AU | 2966579 | |
| | | 120 V AC/DC | 30 V AC/36 V DC / 50 mA | 323 | PLC-RSP-120UC/21AU | 2966582 | |
| | | 230 V AC/DC | 30 V AC/36 V DC / 50 mA | 323 | PLC-RSP-230UC/21AU | 2966647 | |
| | | 120 V AC | 30 V AC/36 V DC / 50 mA ¹⁾ | 334 | PLC-BSP-120UC/21/SO46 | 2980351 ³⁾ | |
| | 230 V AC | 30 V AC/36 V DC / 50 mA ¹⁾ | 334 | PLC-BSP-230UC/21/SO46 | 2980377 ³⁾ | | |
| | Relay switch | 1 N/O contact | 24 V DC | 250 V AC/DC / 6 A | 323 | PLC-RSP-24DC/21-21 | 2912507 |
| | | | 24 V DC | 30 V AC/DC / 50 mA | 323 | PLC-RSP-24DC/21-21AU | 2912578 |
| | Optocoupler | 1 N/O contact, electronic | 24 V DC | 24 V DC / 3 A | 325 | PLC-OSP-24DC/24DC/2 | 2967471 |
| 24 V DC | | | 24 V DC / 10 A | 353 | PLC-OSP-24DC/24DC/10/R | 2982715 | |
| 24 V DC | | | 250 V AC / 0.75 A | 325 | PLC-OSP-24DC/230AC/1 | 2967895 | |
| 24 V DC | | | 300 V DC / 1 A | 352 | PLC-OSP-24DC/300DC/1 | 2980830 | |
| 24 V DC | | | 48 V DC / 100 mA | 324 | PLC-OSP-24DC/48DC/100 | 2967549 | |
| 48 V DC | | | 48 V DC / 100 mA | 324 | PLC-OSP-48DC/48DC/100 | 2967743 | |
| 60 V DC | | | 48 V DC / 100 mA | 324 | PLC-OSP-60DC/48DC/100 | 2967756 | |
| 120 V AC/DC | | | 48 V DC / 100 mA | 324 | PLC-OSP-120UC/48DC/100 | 2967552 | |
| 230 V AC/DC | | | 48 V DC / 100 mA | 324 | PLC-OSP-230UC/48DC/100 | 2967565 | |
| NAMUR | | | 24 V DC / 50 mA | 364 | PLC-SP-EIK 1-SVN 24P/P | 2982676 | |
| 120 V AC | | 48 V DC / 100 mA ²⁾ | 334 | PLC-BSP-120UC/21/SO46 | 2980351 ³⁾ | | |
| 230 V AC | | 48 V DC / 100 mA ²⁾ | 334 | PLC-BSP-230UC/21/SO46 | 2980377 ³⁾ | | |
| 1 PDT, electronic | | 24 V DC | 48 V DC / 0.5 A | 353 | PLC-OSP-24DC/48DC/500/W | 2980649 | |
| Feed-through | | - | 250 V AC/DC | 250 V AC/DC | 486 | - | - |
| | 24 V DC | | 24 V DC | 486 | - | - | |
| Relay | 1 N/O contact | 24 V DC | 250 V AC/DC / 6 A | 326 | PLC-RSP-24DC/1/ACT | 2967345 | |
| | | 24 V DC | 250 V AC/DC / 10 A (80 A; 20 ms) | 332 | PLC-RSP-24DC/11C/ACT | 2912413 | |
| | | 24 V DC | 250 V AC/DC / 6 A | 327 | - | - | |
| | Optocoupler | 1 N/O contact, electronic | 24 V DC | 24 V DC / 3 A | 327 | PLC-OSP-24DC/24DC/2/ACT | 2967507 |
| | | | 24 V DC | 24 V DC / 5 A | 328 | - | - |
| | | | 24 V DC | 250 V AC / 0.75 A | 327 | - | - |
| | | | 24 V DC | 250 V AC / 2 A | 328 | - | - |
| Feed-through | - | 250 V AC/DC | 250 V AC/DC | 487 | - | - | |
| | | 24 V DC | 24 V DC | 487 | - | - | |
| Relay | 1 N/O contact | 24 V DC | 30 V AC/36 V DC / 50 mA | 330 | PLC-RSP-24DC/1AU/SEN | 2967374 | |
| | | 120 V AC/DC | 30 V AC/36 V DC / 50 mA | 330 | PLC-RSP-120UC/1AU/SEN | 2967390 | |
| | | 230 V AC/DC | 30 V AC/36 V DC / 50 mA | 330 | PLC-RSP-230UC/1AU/SEN | 2967413 | |
| | | 120 V AC | 30 V AC/36 V DC / 50 mA ¹⁾ | 335 | PLC-BSP-120UC/1/SEN/SO46 | 2980364 ³⁾ | |
| | | 230 V AC | 30 V AC/36 V DC / 50 mA ¹⁾ | 335 | PLC-BSP-230UC/1/SEN/SO46 | 2980380 ³⁾ | |
| | Optocoupler | 1 N/O contact, electronic | 24 V DC | 48 V DC / 100 mA | 331 | PLC-OSP-24DC/48DC/100/SEN | 2967578 |
| | | | 120 V AC/DC | 48 V DC / 100 mA | 331 | PLC-OSP-120UC/48DC/100/SEN | 2967581 |
| | | | 230 V AC/DC | 48 V DC / 100 mA | 331 | PLC-OSP-230UC/48DC/100/SEN | 2967594 |
| | | | 120 V AC | 48 V DC / 100 mA ²⁾ | 335 | PLC-BSP-120UC/1/SEN/SO46 | 2980364 ³⁾ |
| | | | 230 V AC | 48 V DC / 100 mA ²⁾ | 335 | PLC-BSP-230UC/1/SEN/SO46 | 2980380 ³⁾ |

¹⁾ Plug-in miniature relay insert: REL-MR-60DC/21AU, 2961134

²⁾ Plug-in solid-state relay insert: OPT-60DC/48DC/100, 2966621

³⁾ PLC-...SO46 is supplied as a basic terminal block with filter, but without relay or solid-state relay.

⁴⁾ Cannot be combined with the universal series (within a byte)



Push-in connection



Screw connection

| | Order No.: | | Order No.: | PLC-V8...OUT(M) | PLC-V8...IN(M) | PLC-V8L...OUT |
|----------------------------|-----------------------|----------------------------|-----------------------|-----------------|----------------|---------------|
| PLC-RPT-24DC/21 | 2900299 | PLC-RSC-24DC/21 | 2966171 | X | | |
| PLC-RPT-24DC/21HC | 2900291 | PLC-RSC-24DC/21HC | 2967620 | | | X |
| PLC-RPT-12DC/21AU | 2900317 | PLC-RSC-12DC/21AU | 2966919 | | X | |
| PLC-RPT-24DC/21AU | 2900306 | PLC-RSC-24DC/21AU | 2966265 | X | X | |
| PLC-RPT-24UC/21AU | 2900307 | PLC-RSC-24UC/21AU | 2966278 | X | X | |
| PLC-RPT-48DC/21AU | 2900308 | PLC-RSC-48DC/21AU | 2966126 | | X | |
| PLC-RPT-60DC/21AU | 2900309 | PLC-RSC-60DC/21AU | 2966142 | | X | |
| PLC-RPT-120UC/21AU | 2900310 | PLC-RSC-120UC/21AU | 2966281 | | X | |
| PLC-RPT-230UC/21AU | 2900311 | PLC-RSC-230UC/21AU | 2966294 | | X | |
| PLC-RPT-120UC/21/SO46 | 2900453 ³⁾ | PLC-BSC-120UC/21/SO46 | 2980319 ³⁾ | | X | |
| PLC-RPT-230UC/21/SO46 | 2900455 ³⁾ | PLC-BSC-230UC/21/SO46 | 2980335 ³⁾ | | X | |
| PLC-RPT-24DC/21-21 | 2900330 | PLC-RSC-24DC/21-21 | 2967060 | | | X |
| PLC-RPT-24DC/21-21AU | 2900338 | PLC-RSC-24DC/21-21AU | 2967125 | | | X |
| PLC-RPT-24UC/1/S/H | 2900328 | PLC-RSC-24UC/1/S/H | 2982236 | X | | |
| PLC-RPT-24UC/1/S/L | 2900327 | PLC-RSC-24UC/1/S/L | 2834876 | X | | |
| PLC-OPT-24DC/24DC/2 | 2900364 | PLC-OSC-24DC/24DC/2 | 2966634 | X | | |
| PLC-OPT-24DC/24DC/10/R | 2900398 | PLC-OSC-24DC/24DC/10/R | 2982702 | X | | |
| PLC-OPT-24DC/230AC/1 | 2900369 | PLC-OSC-24DC/230AC/1 | 2967840 | X | | |
| PLC-OPT-24DC/300DC/1 | 2900383 | PLC-OSC-24DC/300DC/1 | 2980678 | X | | |
| PLC-OPT-24DC/48DC/100 | 2900352 | PLC-OSC-24DC/48DC/100 | 2966728 | X | X | |
| PLC-OPT-48DC/48DC/100 | 2900353 | PLC-OSC-48DC/48DC/100 | 2966993 | | X | |
| PLC-OPT-60DC/48DC/100 | 2900354 | PLC-OSC-60DC/48DC/100 | 2967455 | | X | |
| PLC-OPT-120UC/48DC/100 | 2900355 | PLC-OSC-120UC/48DC/100 | 2966744 | | X | |
| PLC-OPT-230UC/48DC/100 | 2900356 | PLC-OSC-230UC/48DC/100 | 2966757 | | X | |
| PLC-PT-EIK 1-SVN 24P/P | 2900397 | PLC-SC-EIK 1-SVN 24P/P | 2982663 | | X | |
| PLC-BPT-120UC/21/SO46 | 2900453 ³⁾ | PLC-BSC-120UC/21/SO46 | 2980319 ³⁾ | | X | |
| PLC-BPT-230UC/21/SO46 | 2900455 ³⁾ | PLC-BSC-230UC/21/SO46 | 2980335 ³⁾ | | X | |
| PLC-OPT-24DC/48DC/500/W | 2900378 | PLC-OSC-24DC/48DC/500/W | 2980636 | X | | |
| - | | PLC-VT | 2296870 | X | X | |
| - | | PLC-VT/LA | 2296854 | X | X | |
| PLC-RPT-24DC/1/ACT | 2900312 | PLC-RSC-24DC/1/ACT | 2966210 | X | | |
| PLC-RPT-24DC/11C/ACT | 2900298 | PLC-RSC-24DC/11C/ACT | 2967604 | | | X |
| - | | PLC-RSC-24DC/1-1/ACT | 2967109 | | | X |
| PLC-OPT-24DC/24DC/2/ACT | 2900376 | PLC-OSC-24DC/24DC/2/ACT | 2966676 | X | | |
| - | | PLC-OSC-24DC/24DC/5/ACT | 2982786 | | | X |
| - | | PLC-OSC-24DC/230AC/1/ACT | 2967947 | X | | |
| - | | PLC-OSC-24DC/230AC/2/ACT | 2982760 | | | X |
| - | | PLC-VT/AKT | 2295567 | X | | |
| - | | PLC-VT/AKT/LA | 2296867 | X | | |
| PLC-RPT-24DC/1AU/SEN | 2900313 | PLC-RSC-24DC/1AU/SEN | 2966317 | | X | |
| PLC-RPT-120UC/1AU/SEN | 2900314 | PLC-RSC-120UC/1AU/SEN | 2966320 | | X | |
| PLC-RPT-230UC/1AU/SEN | 2900315 | PLC-RSC-230UC/1AU/SEN | 2966333 | | X | |
| PLC-BPT-120UC/1/SEN/SO46 | 2900456 ³⁾ | PLC-BSC-120UC/1/SEN/SO46 | 2980322 ³⁾ | | X | |
| PLC-BPT-230UC/1/SEN/SO46 | 2900457 ³⁾ | PLC-BSC-230UC/1/SEN/SO46 | 2980348 ³⁾ | | X | |
| PLC-OPT-24DC/48DC/100/SEN | 2900358 | PLC-OSC-24DC/48DC/100/SEN | 2966773 | | X | |
| PLC-OPT-120UC/48DC/100/SEN | 2900359 | PLC-OSC-120UC/48DC/100/SEN | 2966799 | | X | |
| PLC-OPT-230UC/48DC/100/SEN | 2900361 | PLC-OSC-230UC/48DC/100/SEN | 2966809 | | X | |
| PLC-BPT-120UC/1/SEN/SO46 | 2900456 ³⁾ | PLC-BSC-120UC/1/SEN/SO46 | 2980322 ³⁾ | | X | |
| PLC-BPT-230UC/1/SEN/SO46 | 2900457 ³⁾ | PLC-BSC-230UC/1/SEN/SO46 | 2980348 ³⁾ | | X | |



PLC universal series

The universal series of products can be used as either input or output interfaces. Each product consists of a basic terminal block with a plug-in miniature relay (PDT contact) or a plug-in solid-state relay.



PLC actuator series

When used as an interface between the PLC and actuators, such as motors, contactors or solenoid valves, only one N/O contact function is normally required. In such cases, the PLC...ACT output interface is used. All actuator connections, including the load return line, are connected directly. This eliminates the need for additional output terminal blocks.



PLC sensor series

When used as an interface between the PLC and sensors, such as proximity switches, limit switches or auxiliary contacts, only one N/O contact function is normally required. In such cases, the PLC...SEN input interface is used. All sensor connections, including the supply voltage for the sensors/switches, are connected directly. This eliminates the need for additional modular terminal blocks.

System cabling for controllers

VARIOFACE system cabling

COMPACT-LINE output modules with relays, one N/O contact

These VARIOFACE Compact Line output modules are used in combination with the respective front adapters.

Like the front adapters, the modules are connected via 14-pos. or 50-pos. system cables. The following features characterize these relay modules:

- Plug-in miniature relays, each with an N/O contact
- Universal applications from 1 mA to 3 A continuous current through 2-layer double contact with hard gold plating
- Low construction height of only 45 mm
- LED status display for each signal path and supply voltage
- Freewheeling and reverse polarity protection diode for each signal path.

With the 32-channel version, the system cable is connected to the UM 45-16RM/MR-G24/1/PLC 16-channel base module.

The UM 45-16RM/MR-G24/1/E/PLC output extension module with a further 16 channels is coupled to the base module via a 20-pos. flat-ribbon cable (length: 10 cm).

Notes:

The connection cable between the base and the extension modules is delivered with the extension unit.

Due to the geometry, it is not possible to couple any molded FLK connectors (e.g., VIP-PA...S7).



Output module with eight miniature relays, 1 N/O contact



Technical data

| | | |
|--|----------|---|
| Coil side | | 24 V DC |
| Operating voltage U_N | | 6.5 mA |
| Typ. input current at U_N | | 5 ms |
| Typ. response time at U_N | | 15 ms |
| Typ. release time at U_N | | Freewheeling diode, Protection against polarity reversal |
| Input circuit | | Yellow LED |
| Status display/channel | | IDC/FLK pin strip (2.54 mm) |
| Connection method | | 14 |
| No. of pos. | | |
| Contact side | | |
| Contact type | | 1 N/O contact (double contact) |
| Contact material | | AgNi, 5 µm hard gold-plated |
| Max. switching voltage | | 250 V AC / 125 V DC |
| Min. switching voltage | | 5 V |
| Max. inrush current | | 5 A |
| Limiting continuous current | | 3 A |
| Min. switching current | | 1 mA |
| Max. interrupting rating: | 24 V DC | 72 W |
| | 48 V DC | 60 W |
| | 60 V DC | 50 W |
| | 110 V DC | 50 W |
| | 250 V AC | 750 VA |
| Connection method | | Screw connection |
| Connection data solid / stranded / AWG | | 0.14 ... 1.5 mm ² / 0.14 ... 1.5 mm ² / 26 - 14 |
| General data | | |
| Test voltage | | 2 kV AC (50 Hz, 1 min.) |
| Ambient temperature (operation) | | -20°C ... 50°C |
| Nominal operating mode | | 100% operating factor |
| Mechanical service life | | 2 x 10 ⁷ cycles |
| Standards/regulations | | IEC 60664, DIN EN 50178, IEC 62103 |
| Mounting position | | Any |
| Mounting | | In rows with zero spacing |
| Dimensions | H / D | 45 mm / 50 mm |

Ordering data

| Description | Module width W | Type | Order No. | Pcs. / Pkt. |
|---|-------------------|--------------------------------|----------------|----------------|
| VARIOFACE COMPACT LINE output module, for 24 V DC (including relays) | | | | |
| - With 8 miniature relays | 103 | UM 45- 8RM/MR-G24/1/PLC | 2962900 | 1 |
| - With 16 miniature relays | 215 | | | |
| VARIOFACE COMPACT LINE output extension module, for 24 V DC (including relays) | | | | |
| - With 16 miniature relays | 200 | | | |

Accessories

| | | | |
|---------------------------------|----------------------|----------------|----------|
| Plug-in miniature relays | REL-MR-G 24/1 | 2961037 | 8 |
|---------------------------------|----------------------|----------------|----------|



Output base module with 16 miniature relays,
1 N/O contact



Output extension module with 16 miniature relays,
one N/O contact



Technical data

Technical data

24 V DC
6.5 mA
5 ms
15 ms
Freewheeling diode, Protection against polarity reversal
Yellow LED
IDC/FLK pin strip (2.54 mm)
50

24 V DC
6.5 mA
5 ms
15 ms
Freewheeling diode, Protection against polarity reversal
Yellow LED
IDC/FLK pin strip (2.54 mm)
20

1 N/O contact (double contact)

1 N/O contact (double contact)

AgNi, 5 µm hard gold-plated
250 V AC / 125 V DC
5 V
5 A
3 A
1 mA
72 W
60 W
50 W
50 W
750 VA
Screw connection
0.14 ... 1.5 mm² / 0.14 ... 1.5 mm² / 26 - 14

AgNi, 5 µm hard gold-plated
250 V AC / 125 V DC
5 V
5 A
3 A
1 mA
72 W
60 W
50 W
50 W
750 VA
Screw connection
0.14 ... 1.5 mm² / 0.14 ... 1.5 mm² / 26 - 14

2 kV (50 Hz, 1 min.)
-20°C ... 50°C
100% operating factor
2 x 10⁷ cycles
IEC 60664, DIN EN 50178, IEC 62103
Any
In rows with zero spacing
45 mm / 50 mm

2 kV (50 Hz, 1 min.)
-20°C ... 50°C
100% operating factor
2 x 10⁷ cycles
IEC 60664, DIN EN 50178, IEC 62103
Any
In rows with zero spacing
45 mm / 50 mm

Ordering data

Ordering data

| Type | Order No. | Pcs. / Pkt. |
|-------------------------|-----------|-------------|
| UM 45-16RM/MR-G24/1/PLC | 2962913 | 1 |

| Type | Order No. | Pcs. / Pkt. |
|---------------------------|-----------|-------------|
| UM 45-16RM/MR-G24/1/E/PLC | 2962926 | 1 |

Accessories

Accessories

| | | |
|---------------|---------|---|
| REL-MR-G 24/1 | 2961037 | 8 |
|---------------|---------|---|

| | | |
|---------------|---------|---|
| REL-MR-G 24/1 | 2961037 | 8 |
|---------------|---------|---|

System cabling for controllers

VARIOFACE system cabling

Output modules with relays, one N/O contact

These VARIOFACE output modules are used in combination with the respective front adapters.

- Plug-in miniature relays, each with an N/O contact
- Universal applications from 1 mA to 3 A continuous current through 2-layer double contact with hard gold plating
- Slim construction widths of only 55 mm (8 channels) or 202 mm (32 channels)
- LED status display for each signal path and supply voltage
- Freewheeling and reverse polarity protection diode for each signal path.



Output module with eight miniature relays, 1 N/O contact



Technical data

| | |
|--|--|
| Coil side | |
| Operating voltage U_N | 24 V DC |
| Typ. input current at U_N | 6.5 mA |
| Typ. response time at U_N | 5 ms |
| Typ. release time at U_N | 15 ms |
| Input circuit | Freewheeling diode, Protection against polarity reversal |
| Status display/channel | Yellow LED |
| Connection method | IDC/FLK pin strip (2.54 mm) |
| No. of pos. | 14 |
| Contact side | |
| Contact type | 1 N/O contact (double contact) |
| Contact material | AgNi, 5 µm hard gold-plated |
| Max. switching voltage | 250 V AC / 125 V DC |
| Min. switching voltage | 5 V |
| Max. inrush current | 5 A |
| Limiting continuous current | 3 A |
| Min. switching current | 1 mA |
| Max. interrupting rating: | 24 V DC 72 W 48 V DC 60 W 60 V DC 50 W 110 V DC 50 W 250 V AC 750 VA |
| Connection method | Screw connection |
| Connection data solid / stranded / AWG | 0.14 ... 1.5 mm ² / 0.14 ... 1.5 mm ² / 26 - 14 |
| General data | |
| Test voltage | 3 kV AC |
| Ambient temperature (operation) | -20°C ... 50°C |
| Nominal operating mode | 100% operating factor |
| Mechanical service life | 2 x 10 ⁷ cycles |
| Standards/regulations | IEC 60664, DIN EN 50178, IEC 62103 |
| Mounting position | Any |
| Mounting | In rows with zero spacing |
| Dimensions | 90 mm / 58 mm |

Ordering data

| | |
|---|----------------|
| Description | Module width W |
| VARIOFACE output module, with 8 miniature relays, plugged in, for 24 V DC (including relays) | 56 |
| VARIOFACE output module, with 32 miniature relays, plugged in, for 24 V DC (including relays) | 202 |

Accessories

| | | | |
|--------------------------|---------------|---------|---|
| Plug-in miniature relays | REL-MR-G 24/1 | 2961037 | 8 |
|--------------------------|---------------|---------|---|



Output modules with 32 miniature relays, 1 N/O contact



Technical data

| | |
|--|--|
| Coil side | |
| Operating voltage U_N | 24 V DC |
| Typ. input current at U_N | 6.5 mA |
| Typ. response time at U_N | 5 ms |
| Typ. release time at U_N | 15 ms |
| Input circuit | Freewheeling diode, Protection against polarity reversal |
| Status display/channel | Yellow LED |
| Connection method | IDC/FLK pin strip (2.54 mm) |
| No. of pos. | 50 |
| Contact side | |
| Contact type | 1 N/O contact (double contact) |
| Contact material | AgNi, 5 µm hard gold-plated |
| Max. switching voltage | 250 V AC / 125 V DC |
| Min. switching voltage | 5 V |
| Max. inrush current | 5 A |
| Limiting continuous current | 3 A |
| Min. switching current | 1 mA |
| Max. interrupting rating: | 24 V DC 72 W 48 V DC 60 W 60 V DC 50 W 110 V DC 50 W 250 V AC 750 VA |
| Connection method | Screw connection |
| Connection data solid / stranded / AWG | 0.14 ... 1.5 mm ² / 0.14 ... 1.5 mm ² / 26 - 14 |
| General data | |
| Test voltage | 3 kV AC |
| Ambient temperature (operation) | -20°C ... 50°C |
| Nominal operating mode | 100% operating factor |
| Mechanical service life | 2 x 10 ⁷ cycles |
| Standards/regulations | IEC 60664, DIN EN 50178, IEC 62103 |
| Mounting position | Any |
| Mounting | In rows with zero spacing |
| Dimensions | 90 mm / 58 mm |

Ordering data

| | | |
|------------------------|-----------|-------------|
| Type | Order No. | Pcs. / Pkt. |
| UMK-32 RM/MR-G24/1/PLC | 2979472 | 1 |

Accessories

| | | | |
|--------------------------|---------------|---------|---|
| Plug-in miniature relays | REL-MR-G 24/1 | 2961037 | 8 |
|--------------------------|---------------|---------|---|

Output modules with relay, 1 PDT

These VARIOFACE output modules are used in combination with the respective front adapters.

Like the front adapters, the modules are connected via 14-pos. or 50-pos. system cables. The following features characterize these relay modules:

- Plug-in miniature relays, each with a PDT contact
- Slim construction widths of only 80 mm (8 channels) or 271 mm (32 channels)
- LED status display for each signal path and supply voltage
- Freewheeling diode for each signal path



Output module with eight miniature relays, 1 PDT



Output module with 32 miniature relays, 1 PDT

Notes:
1) EMC: Class A product, see page 571



| | |
|--|---|
| Coil side | |
| Operating voltage U_N | 24 V DC |
| Typ. input current at U_N | 18 mA |
| Typ. response time at U_N | 8 ms |
| Typ. release time at U_N | 10 ms |
| Input circuit | Freewheeling diode |
| Status display/channel | Yellow LED |
| Connection method | IDC/FLK pin strip (2.54 mm) |
| No. of pos. | 14 |
| Contact side | |
| Contact type | Single contact, 1-PDT |
| Contact material | AgNi |
| Max. switching voltage | 250 V AC/DC |
| Min. switching voltage | 12 V AC/DC |
| Limiting continuous current | 5 A |
| Min. switching current | 100 mA |
| Max. interrupting rating: | 24 V DC 120 W 48 V DC 58 W 60 V DC 48 W 110 V DC 50 W 220 V DC 80 W 250 V AC 1250 VA |
| Connection method | Screw connection |
| Connection data solid / stranded / AWG | 0.2 ... 4 mm ² / 0.2 ... 2.5 mm ² / 24 - 12 |
| General data | |
| Test voltage | 2.5 kV (50 Hz, 1 min.) |
| Ambient temperature (operation) | -20°C ... 50°C |
| Nominal operating mode | 100% operating factor |
| Mechanical service life | 3 x 10 ⁷ cycles |
| Standards/regulations | IEC 60664, DIN EN 50178, IEC 62103 |
| Mounting position | Any |
| Mounting | In rows with zero spacing |
| Dimensions | 123 mm / 68 mm |

Technical data

| | |
|--|---|
| Technical data | |
| Operating voltage U_N | 24 V DC |
| Typ. input current at U_N | 18 mA |
| Typ. response time at U_N | 8 ms |
| Typ. release time at U_N | 10 ms |
| Input circuit | Freewheeling diode |
| Status display/channel | Yellow LED |
| Connection method | IDC/FLK pin strip (2.54 mm) |
| No. of pos. | 14 |
| Contact side | |
| Contact type | Single contact, 1-PDT |
| Contact material | AgNi |
| Max. switching voltage | 250 V AC/DC |
| Min. switching voltage | 12 V AC/DC |
| Limiting continuous current | 5 A |
| Min. switching current | 100 mA |
| Max. interrupting rating: | 24 V DC 120 W 48 V DC 58 W 60 V DC 48 W 110 V DC 50 W 220 V DC 80 W 250 V AC 1250 VA |
| Connection method | Screw connection |
| Connection data solid / stranded / AWG | 0.2 ... 4 mm ² / 0.2 ... 2.5 mm ² / 24 - 12 |
| General data | |
| Test voltage | 2.5 kV (50 Hz, 1 min.) |
| Ambient temperature (operation) | -20°C ... 50°C |
| Nominal operating mode | 100% operating factor |
| Mechanical service life | 3 x 10 ⁷ cycles |
| Standards/regulations | IEC 60664, DIN EN 50178, IEC 62103 |
| Mounting position | Any |
| Mounting | In rows with zero spacing |
| Dimensions | 123 mm / 68 mm |

Technical data

| | |
|--|---|
| Technical data | |
| Operating voltage U_N | 24 V DC |
| Typ. input current at U_N | 18 mA |
| Typ. response time at U_N | 8 ms |
| Typ. release time at U_N | 10 ms |
| Input circuit | Freewheeling diode |
| Status display/channel | Yellow LED |
| Connection method | IDC/FLK pin strip (2.54 mm) |
| No. of pos. | 50 |
| Contact side | |
| Contact type | Single contact, 1-PDT |
| Contact material | AgNi |
| Max. switching voltage | 250 V AC/DC |
| Min. switching voltage | 12 V AC/DC |
| Limiting continuous current | 5 A |
| Min. switching current | 100 mA |
| Max. interrupting rating: | 24 V DC 120 W 48 V DC 58 W 60 V DC 48 W 110 V DC 50 W 220 V DC 80 W 250 V AC 1250 VA |
| Connection method | Screw connection |
| Connection data solid / stranded / AWG | 0.2 ... 4 mm ² / 0.2 ... 2.5 mm ² / 24 - 12 |
| General data | |
| Test voltage | 2.5 kV (50 Hz, 1 min.) |
| Ambient temperature (operation) | -20°C ... 50°C |
| Nominal operating mode | 100% operating factor |
| Mechanical service life | 3 x 10 ⁷ cycles |
| Standards/regulations | IEC 60664, DIN EN 50178, IEC 62103 |
| Mounting position | Any |
| Mounting | In rows with zero spacing |
| Dimensions | 123 mm / 68 mm |

| Description | Module width W |
|---|----------------|
| VARIOFACE output module, with 8 miniature relays, plugged in, for 24 V DC (including relays) | 80 |
| VARIOFACE output module, with 32 miniature relays, plugged in, for 24 V DC (including relays) | 271 |

Ordering data

| Type | Order No. | Pcs. / Pkt. |
|------------------------|-----------|-------------|
| UM- 8 RM/RT-G24/21/PLC | 2968386 | 1 |

Ordering data

| Type | Order No. | Pcs. / Pkt. |
|--------------------------------------|-----------|-------------|
| UM-32 RM/RT-G24/21/PLC ¹⁾ | 2968373 | 1 |

Accessories

| | | | |
|--------------------------|-------------------|---------|----|
| Plug-in miniature relays | REL-MR- 24DC/21HC | 2961312 | 10 |
|--------------------------|-------------------|---------|----|

Accessories

| | | |
|-------------------|---------|----|
| REL-MR- 24DC/21HC | 2961312 | 10 |
|-------------------|---------|----|

Accessories

| | | |
|-------------------|---------|----|
| REL-MR- 24DC/21HC | 2961312 | 10 |
|-------------------|---------|----|

System cabling for controllers

VARIOFACE system cabling

Output modules with relay, 1 PDT

These VARIOFACE output modules are used in combination with the respective front adapters.

Like the front adapters, the modules are connected via 14-pos. or 50-pos. system cables. The following features characterize these relay modules:

- Plug-in miniature relays, each with a PDT contact
- LED status display for each signal path and supply voltage
- Freewheeling and reverse polarity protection diode for each signal path.

With the 32-channel version, the system cable is connected to the 16-channel UMK-16R.../KSR-G24/21/PLC base module. The UMK-16R.../KSR-G24/21/E/PLC output extension module with a further 16 channels is coupled to the base module via a 20-pos. flat-ribbon cable (length: 10 cm).

Notes:

The connection cable between the base and the extension modules is delivered with the extension unit.



Output module with eight miniature relays, 1 PDT



Technical data

| | |
|--|---|
| Coil side | |
| Operating voltage U_N | 24 V DC $\pm 10\%$ |
| Input circuit | Freewheeling diode, Protection against polarity reversal |
| Operating voltage display | Green LED |
| Status display/channel | Yellow LED |
| Connection method | IDC/FLK pin strip (2.54 mm) |
| No. of pos. | 14 |
| Contact side | |
| Contact type | 1 PDT |
| Max. switching voltage | 250 V AC/DC |
| Limiting continuous current | 5 A |
| Connection method | Screw connection |
| Connection data solid / stranded / AWG | 0.2 ... 4 mm ² / 0.2 ... 2.5 mm ² / 24 - 12 |
| General data | |
| Test voltage | 2.5 kV (50 Hz, 1 min.) |
| Ambient temperature (operation) | -20°C ... 50°C |
| Standards/regulations | IEC 60664, DIN EN 50178, IEC 62103 |
| Mounting position | Any |
| Mounting | In rows with zero spacing |
| Dimensions | 77 mm / 59 mm |

Ordering data

| Description | Module width W | Type | Order No. | Pcs. / Pkt. |
|--|----------------|----------------------------|-----------|-------------|
| VARIOFACE output module, with 8 miniature relays, plugged in, for 24 V DC (including relays) | 135 | UMK- 8 RM/KSR-G 24/21/PLC | 2979485 | 1 |
| VARIOFACE output module, with plug-in bases for eight miniature relays, for 24 V DC (without relays) | 135 | UMK- 8 RELS/KSR-G24/21/PLC | 2974914 | 1 |
| VARIOFACE output module, with 16 miniature relays, plugged in, for 24 V DC (base module, including relays) | 259 | | | |
| VARIOFACE output module, with plug-in bases for 16 miniature relays, for 24 V DC (base module, without relays) | 259 | | | |
| VARIOFACE output extension module, with 16 miniature relays, plugged in, for 24 V DC (including relays) | 259 | | | |
| VARIOFACE output extension module, with plug-in bases for 16 miniature relays, for 24 V DC (without relays) | 259 | | | |

Accessories

| | | | |
|--------------------------|-------------------|---------|----|
| Plug-in miniature relays | REL-MR- 24DC/21HC | 2961312 | 10 |
|--------------------------|-------------------|---------|----|



Output base module with 16 miniature relays,
1 PDT



Output extension module with 16 miniature relays,
1 PDT

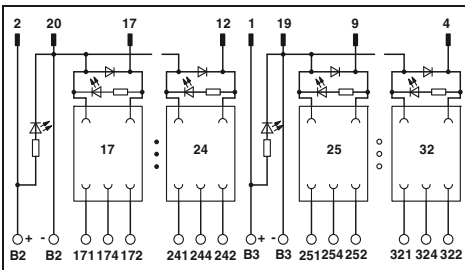

Technical data

24 V DC $\pm 10\%$
 Freewheeling diode, Protection against polarity reversal
 Green LED
 Yellow LED
 IDC/FLK pin strip (2.54 mm)
 50

1 PDT
 250 V AC/DC
 5 A
 Screw connection
 0.2 ... 4 mm² / 0.2 ... 2.5 mm² / 24 - 12

2.5 kV (50 Hz, 1 min.)
 -20°C ... 50°C
 IEC 60664, DIN EN 50178, IEC 62103
 Any
 In rows with zero spacing
 77 mm / 59 mm

Ordering data

| Type | Order No. | Pcs. / Pkt. |
|----------------------------|-----------|-------------|
| UMK-16 RM/KSR-G 24/21/PLC | 2979498 | 1 |
| UMK-16 RELS/KSR-G24/21/PLC | 2974901 | 1 |

Accessories

| | | |
|-------------------|---------|----|
| REL-MR- 24DC/21HC | 2961312 | 10 |
|-------------------|---------|----|

Technical data

24 V DC $\pm 10\%$
 Freewheeling diode, Protection against polarity reversal
 Green LED
 Yellow LED
 IDC/FLK pin strip (2.54 mm)
 20

1 PDT
 250 V AC/DC
 5 A
 Screw connection
 0.2 ... 4 mm² / 0.2 ... 2.5 mm² / 24 - 12

2.5 kV (50 Hz, 1 min.)
 -20°C ... 50°C
 IEC 60664, DIN EN 50178, IEC 62103
 Any
 In rows with zero spacing
 77 mm / 59 mm

Ordering data

| Type | Order No. | Pcs. / Pkt. |
|------------------------------|-----------|-------------|
| UMK-16 RM/KSR-G 24/21/E/PLC | 2979508 | 1 |
| UMK-16 RELS/KSR-G24/21/E/PLC | 2974891 | 1 |

Accessories

| | | |
|-------------------|---------|----|
| REL-MR- 24DC/21HC | 2961312 | 10 |
|-------------------|---------|----|

System cabling for controllers

VARIOFACE system cabling

Output module for relays

- 2 PDTs
- 1 PDT with disconnect terminal blocks

These VARIOFACE output modules are used in combination with the respective front adapters.

8 channels are controlled via 14-pos. cables. All modules feature the following:

- Plug-in miniature relays
- LED status indicator and freewheeling diode per signal path
- Supply voltage indicator (LED)
- Polarity protection diode

With the 32-channel version (1 PDT with knife disconnect terminal blocks), the 50-pos. system cable is connected to the base module with 16 channels.

The output extension module with a further 16 channels is coupled to the base module via a 20-pos. flat-ribbon cable (length: 10 cm).

Notes:

The connection cable between the base and the extension modules is delivered with the extension unit.

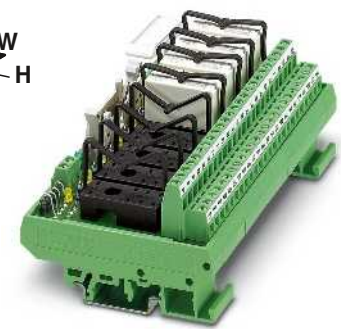

Output module for 8 miniature relays, 2 PDTs

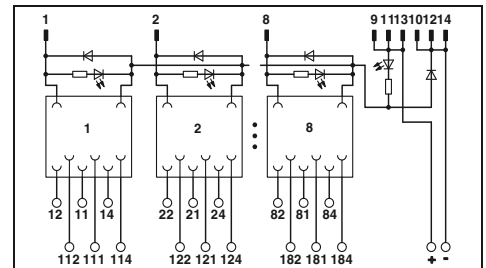

Technical data

| | |
|--|---|
| Coil side | |
| Operating voltage U_N | 24 V DC |
| Input circuit | Freewheeling diode |
| Operating voltage display | Green LED |
| Status display/channel | Yellow LED |
| Connection method | IDC/FLK pin strip (2.54 mm) |
| No. of pos. | 14 |
| Contact side | |
| Contact type | 2 PDT |
| Max. switching voltage | 250 V AC/DC |
| Limiting continuous current | 3 A |
| Connection method | Screw connection |
| Connection data solid / stranded / AWG | 0.14 ... 1.5 mm ² / 0.14 ... 1.5 mm ² / 26 - 14 |
| General data | |
| Test voltage | 2.5 kV AC |
| Ambient temperature (operation) | -20°C ... 50°C |
| Standards/regulations | IEC 60664, DIN EN 50178, IEC 62103 |
| Mounting position | Any |
| Mounting | In rows with zero spacing |
| Dimensions | 77 mm / 59 mm |

Ordering data

| Description | Module width W | Type | Order No. | Pcs. / Pkt. |
|---|-------------------|--------------------------------------|----------------|----------------|
| VARIOFACE output module , with plug-in bases for eight miniature relays, for 24 V DC, each with two PDTs (without relays) | 135 | UMK- 8 RELS/KSR-G24/21-21/PLC | 2976187 | 1 |
| VARIOFACE output module , with plug-in bases for 8 miniature relays, for 24 V DC and knife disconnect terminal blocks, each with 1 PDT (without relays) | 145 | | | |
| VARIOFACE output module , with plug-in bases for 16 miniature relays, for 24 V DC and knife disconnect terminal blocks, each with 1 PDT (without relays) | 285 | | | |
| VARIOFACE output extension module , with plug-in bases for 16 miniature relays, for 24 V DC and knife disconnect terminal blocks, each with 1 PDT (without relays) | 285 | | | |

Accessories

| | | | |
|---------------------------------|---------------------------|----------------|-----------|
| Plug-in miniature relays | REL-MR- 24DC/21-21 | 2961192 | 10 |
|---------------------------------|---------------------------|----------------|-----------|

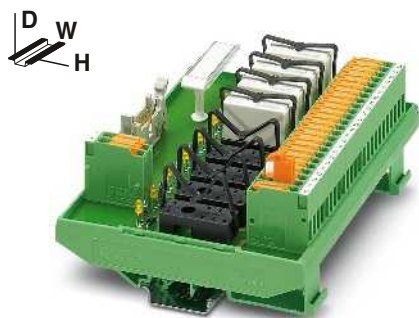

Output module for 8 miniature relays with knife/disconnect terminal blocks, 1 PDT



Output module for 16 miniature relays with knife/disconnect terminal blocks, 1 PDT



Output extension module for 16 miniature relays with knife/disconnect terminal blocks, 1 PDT

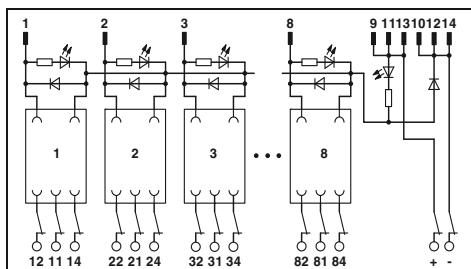

Technical data

24 V DC
 Freewheeling diode, Protection against polarity reversal
 Green LED
 Yellow LED
 IDC/FLK pin strip (2.54 mm)
 14

1 PDT
 250 V AC/DC
 5 A
 Screw connection with disconnect knife
 0.2 ... 4 mm² / 0.2 ... 2.5 mm² / 24 - 12

2.5 kV (50 Hz, 1 min.)
 -20°C ... 50°C
 IEC 60664, DIN EN 50178, IEC 62103
 Any
 In rows with zero spacing
 111.5 mm / 59 mm

Ordering data

| Type | Order No. | Pcs. / Pkt. |
|-----------------------------|-----------|-------------|
| UM-8 RELS/KSR-G24/21/MT/PLC | 2962463 | 1 |

Accessories

| | | |
|-------------------|---------|----|
| REL-MR-24DC/21-21 | 2961192 | 10 |
|-------------------|---------|----|



Technical data

24 V DC
 Freewheeling diode
 Green LED
 Yellow LED
 IDC/FLK pin strip (2.54 mm)
 50

1 PDT
 250 V AC/DC
 5 A
 Screw connection with disconnect knife
 0.2 ... 4 mm² / 0.2 ... 2.5 mm² / 24 - 12

2.5 kV (50 Hz, 1 min.)
 -20°C ... 50°C
 IEC 60664, DIN EN 50178, IEC 62103
 Any
 In rows with zero spacing
 111.5 mm / 59 mm

Ordering data

| Type | Order No. | Pcs. / Pkt. |
|------------------------------|-----------|-------------|
| UM-16 RELS/KSR-G24/21/MT/PLC | 2962382 | 1 |

Accessories

| | | |
|-------------------|---------|----|
| REL-MR-24DC/21-21 | 2961192 | 10 |
|-------------------|---------|----|



Technical data

24 V DC
 Freewheeling diode
 Green LED
 Yellow LED
 IDC/FLK pin strip (2.54 mm)
 20

1 PDT
 250 V AC/DC
 5 A
 Screw connection with disconnect knife
 0.2 ... 4 mm² / 0.2 ... 2.5 mm² / 24 - 12

2.5 kV (50 Hz, 1 min.)
 -20°C ... 50°C
 IEC 60664, DIN EN 50178, IEC 62103
 Any
 In rows with zero spacing
 111.5 mm / 59 mm

Ordering data

| Type | Order No. | Pcs. / Pkt. |
|--------------------------------|-----------|-------------|
| UM-16 RELS/KSR-G24/21/E/MT/PLC | 2962379 | 1 |

Accessories

| | | |
|-------------------|---------|----|
| REL-MR-24DC/21-21 | 2961192 | 10 |
|-------------------|---------|----|

System cabling for controllers

VARIOFACE system cabling

Output modules with relays, 1 PDT with detectable manual operation

These VARIOFACE output modules are used in combination with the respective front adapters.

The modules are connected via a 14- or 50-pos. system cable. These relay modules offer the following features:

- Plug-in miniature relays each with a PDT contact and detectable manual operation
- Slim design width of just 92 mm (8 channels) or 285 mm (32 channels)
- LED status indicator and freewheeling diode per signal path (integrated in relay)
- Supply voltage indicator (LED)



Output module with 8 miniature relays, 1 PDT with detectable manual operation



Output module with 32 miniature relays, 1 PDT with detectable manual operation

Notes:
1) EMC: Class A product, see page 571

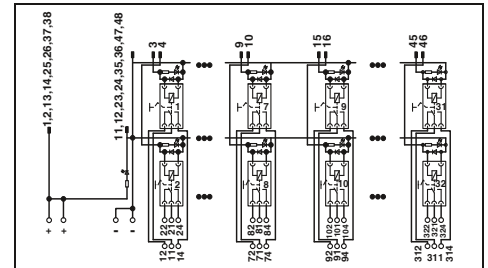
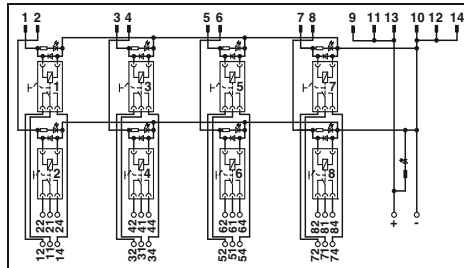

| | |
|---|---|
| Coil side | |
| Operating voltage U_N | 24 V DC |
| Typ. input current at U_N | 18 mA |
| Typ. response time at U_N | 9 ms |
| Typ. release time at U_N | 6 ms |
| Input circuit | Freewheeling diode (integrated in relay) |
| Status display/channel | Yellow LED (integrated in relay) |
| Connection method | Flat-ribbon cable plug-in connector according to IEC 60603-13 |
| No. of pos. | |
| 14 | |
| Contact side | |
| Contact type | Single contact, 1-PDT |
| Contact material | AgNi |
| Max. switching voltage | 250 V AC/DC |
| Min. switching voltage | 12 V AC/DC |
| Limiting continuous current | 5 A |
| Min. switching current | 100 mA |
| Max. interrupting rating: | 24 V DC 120 W 48 V DC 62 W 60 V DC 42 W 110 V DC 55 W 220 V DC 66 W 250 V AC 1250 VA |
| Connection method | Screw connection |
| Connection data solid / stranded / AWG | 0.2 ... 4 mm ² / 0.2 ... 2.5 mm ² / 24 - 12 |
| General data | |
| Rated insulation voltage | 260 V AC |
| Rated surge voltage | 4 kV |
| Pollution degree / Surge voltage category | 2 / III |
| Ambient temperature (operation) | -20°C ... 50°C |
| Nominal operating mode | 100% operating factor |
| Mechanical service life | 5 x 10 ⁶ cycles |
| Standards/regulations | DIN EN 50178 |
| Mounting position | Any |
| Mounting | In rows with zero spacing |
| Dimensions | 111 mm / 64 mm |

| Technical data | | |
|---|--|--|
| 24 V DC | | |
| 18 mA | | |
| 9 ms | | |
| 6 ms | | |
| Freewheeling diode (integrated in relay) | | |
| Yellow LED (integrated in relay) | | |
| Flat-ribbon cable plug-in connector according to IEC 60603-13 | | |
| 14 | | |
| Single contact, 1-PDT | | |
| AgNi | | |
| 250 V AC/DC | | |
| 12 V AC/DC | | |
| 5 A | | |
| 100 mA | | |
| 24 V DC 120 W | | |
| 48 V DC 62 W | | |
| 60 V DC 42 W | | |
| 110 V DC 55 W | | |
| 220 V DC 66 W | | |
| 250 V AC 1250 VA | | |
| Screw connection | | |
| 0.2 ... 4 mm ² / 0.2 ... 2.5 mm ² / 24 - 12 | | |
| 260 V AC | | |
| 4 kV | | |
| 2 / III | | |
| -20°C ... 50°C | | |
| 100% operating factor | | |
| 5 x 10 ⁶ cycles | | |
| DIN EN 50178 | | |
| Any | | |
| In rows with zero spacing | | |
| 111 mm / 64 mm | | |

| Technical data | | |
|---|--|--|
| 24 V DC | | |
| 18 mA | | |
| 9 ms | | |
| 6 ms | | |
| Freewheeling diode (integrated in relay) | | |
| Yellow LED (integrated in relay) | | |
| Flat-ribbon cable plug-in connector according to IEC 60603-13 | | |
| 50 | | |
| Single contact, 1-PDT | | |
| AgNi | | |
| 250 V AC/DC | | |
| 12 V AC/DC | | |
| 5 A | | |
| 100 mA | | |
| 24 V DC 120 W | | |
| 48 V DC 62 W | | |
| 60 V DC 42 W | | |
| 110 V DC 55 W | | |
| 220 V DC 66 W | | |
| 250 V AC 1250 VA | | |
| Screw connection | | |
| 0.2 ... 4 mm ² / 0.2 ... 2.5 mm ² / 24 - 12 | | |
| 260 V AC | | |
| 4 kV | | |
| 2 / III | | |
| -20°C ... 50°C | | |
| 100% operating factor | | |
| 5 x 10 ⁶ cycles | | |
| DIN EN 50178 | | |
| Any | | |
| In rows with zero spacing | | |
| 111 mm / 64 mm | | |

| Description | Module width W |
|---|----------------|
| VARIOFACE output module, with 8 miniature relays, plugged in, for 24 V DC (including relays) | 92 |
| VARIOFACE output module, with 32 miniature relays, plugged in, for 24 V DC (including relays) | 285 |

| Ordering data | | |
|---|-----------|-------------|
| Type | Order No. | Pcs. / Pkt. |
| UM- 8RM/KSR-G24/21/MS/PLC ¹⁾ | 2900890 | 1 |

| Ordering data | | |
|---|-----------|-------------|
| Type | Order No. | Pcs. / Pkt. |
| UM-32RM/KSR-G24/21/MS/PLC ¹⁾ | 2900891 | 1 |

| Accessories | | |
|---|----------------------|------------|
| Plug-in miniature power relays, with power contacts | REL-MR- 24DC/21HC/MS | 2987888 10 |

| Accessories | | |
|----------------------|---------|----|
| REL-MR- 24DC/21HC/MS | 2987888 | 10 |

| Accessories | | |
|----------------------|---------|----|
| REL-MR- 24DC/21HC/MS | 2987888 | 10 |

**Output modules with relays,
1 PDT with or without manual
operation and fuses**

These VARIOFACE output modules are used in combination with the respective front adapters.

The modules are connected via a 14-pos. system cable. These relay modules offer the following features:

- Plug-in miniature relays each with a PDT contact with or without manual operation
- Fuse per output circuit as short-circuit protection
- Slim design width of just 127 mm
- LED status indicator and freewheeling diode per signal path
- Supply voltage indicator (LED)
- Polarity protection diode



**Output module with 8 miniature relays,
1 PDT and fuse per output circuit**



**Output module with 8 miniature relays,
1 PDT with detectable manual operation
and fuse per output circuit**

Notes:

1) EMC: Class A product, see page 571

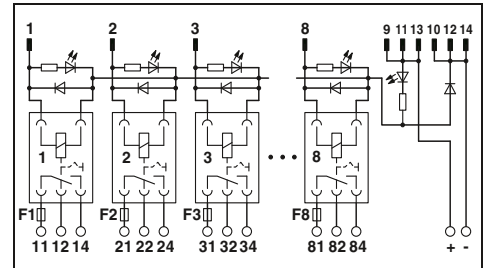
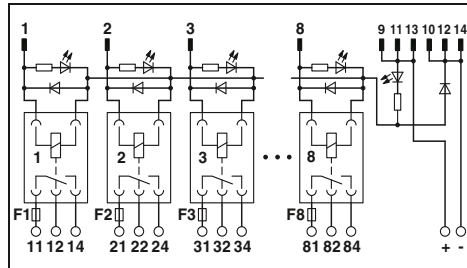

Technical data

| | |
|---|---|
| Coil side | |
| Operating voltage U_N | 24 V DC |
| Typ. input current at U_N | 17 mA |
| Typ. response time at U_N | 8 ms |
| Typ. release time at U_N | 10 ms |
| Input circuit | Freewheeling diode |
| Status display/channel | Yellow LED |
| Connection method | Flat-ribbon cable plug-in connector according to IEC 60603-13 |
| No. of pos. | |
| 14 | |
| Contact side | |
| Contact type | Single contact, 1-PDT |
| Contact material | AgNi |
| Max. switching voltage | 250 V AC/DC |
| Min. switching voltage | 12 V AC/DC |
| Output fuse | 4 A 5x20 fuse (slow-blow) |
| Limiting continuous current | 3.9 A (observe derating) |
| Min. switching current | 100 mA |
| Max. interrupting rating: | 24 V DC 93 W 48 V DC 58 W 60 V DC 48 W 110 V DC 50 W 220 V DC 80 W 250 V AC 975 VA |
| Connection method | Screw connection |
| Connection data solid / stranded / AWG | 0.2 ... 4 mm ² / 0.2 ... 2.5 mm ² / 24 - 12 |
| General data | |
| Rated insulation voltage | 260 V AC |
| Rated surge voltage | 4 kV |
| Pollution degree / Surge voltage category | 2 / III |
| Ambient temperature (operation) | -20°C ... 50°C |
| Nominal operating mode | 100% operating factor |
| Mechanical service life | 3 x 10 ⁷ cycles |
| Standards/regulations | DIN EN 50178 |
| Mounting position | Any |
| Mounting | In rows with zero spacing |
| Dimensions | 111 mm / 60 mm |

Technical data

| | |
|---|---|
| Coil side | |
| Operating voltage U_N | 24 V DC |
| Typ. input current at U_N | 18 mA |
| Typ. response time at U_N | 9 ms |
| Typ. release time at U_N | 6 ms |
| Input circuit | Freewheeling diode (integrated in relay) |
| Status display/channel | Yellow LED (integrated in relay) |
| Connection method | Flat-ribbon cable plug-in connector according to IEC 60603-13 |
| No. of pos. | |
| 14 | |
| Contact side | |
| Contact type | Single contact, 1-PDT |
| Contact material | AgNi |
| Max. switching voltage | 250 V AC/DC |
| Min. switching voltage | 12 V AC/DC |
| Output fuse | 4 A 5x20 fuse (slow-blow) |
| Limiting continuous current | 3.9 A (observe derating) |
| Min. switching current | 100 mA |
| Max. interrupting rating: | 24 V DC 93 W 48 V DC 62 W 60 V DC 42 W 110 V DC 55 W 220 V DC 66 W 250 V AC 975 VA |
| Connection method | Screw connection |
| Connection data solid / stranded / AWG | 0.2 ... 4 mm ² / 0.2 ... 2.5 mm ² / 24 - 12 |
| General data | |
| Rated insulation voltage | 260 V AC |
| Rated surge voltage | 4 kV |
| Pollution degree / Surge voltage category | 2 / III |
| Ambient temperature (operation) | -20°C ... 50°C |
| Nominal operating mode | 100% operating factor |
| Mechanical service life | 5 x 10 ⁶ cycles |
| Standards/regulations | DIN EN 50178 |
| Mounting position | Any |
| Mounting | In rows with zero spacing |
| Dimensions | 111 mm / 64 mm |

Ordering data

| Description | Module width W | Type | Order No. | Pcs. / Pkt. |
|--|-------------------|---|-----------|-------------|
| VARIOFACE output module, with 8 miniature relays, plugged in, for 24 V DC (including relays) | 127 | UM- 8RM/KSR-G24/21/SI/PLC ¹⁾ | 2900892 | 1 |

Ordering data

| Description | Module width W | Type | Order No. | Pcs. / Pkt. |
|--|-------------------|--|-----------|-------------|
| VARIOFACE output module, with 8 miniature relays, plugged in, for 24 V DC (including relays) | 127 | UM- 8RM/KSR-G24/21/MS/SI/PLC ¹⁾ | 2900893 | 1 |

Accessories

| Accessories | Order No. | Pcs. / Pkt. |
|-------------------|-----------|-------------|
| REL-MR- 24DC/21HC | 2961312 | 10 |

Accessories

| Accessories | Order No. | Pcs. / Pkt. |
|----------------------|-----------|-------------|
| REL-MR- 24DC/21HC/MS | 2987888 | 10 |

System cabling for controllers

VARIOFACE system cabling

VIP – VARIOFACE Professional system cables with flat-ribbon connectors

- 1:1 connection
- 10- to 20-pos.
- Plug-in connectors as per IEC 60603-13
- In the desired lengths
- Individual serial number

Note:

Due to the enlarged outer contour of the molded plug-in connectors, module types with UM45 profile and three-level terminal blocks cannot be connected with the VIP-CAB-FLK... system cable.

The following module types (10- to 50-pos.) can be connected.

For example, for 20 positions:

- VIP-2/SC/FLK 20
- VIP-2/SC/FLK20/LED
- FLKM 20/ZFKDS
- UM45-FLK 20/ZFKDS

(double-level connection)

The VIP-CAB-FLK... system cables are not suitable for front adapters (see the dimensional drawing).

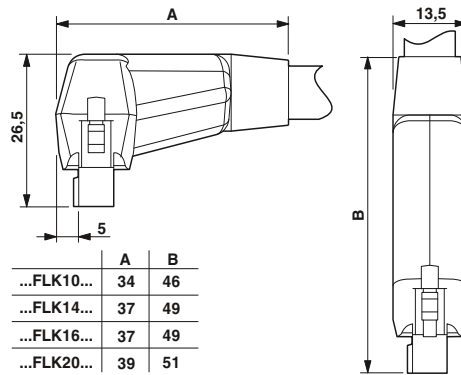

not shielded



Technical data

Max. perm. operating voltage
 Max. perm. current carrying capacity per path
 Max. conductor resistance
 Ambient temperature (operation)
 Assembly

< 50 V AC / 60 V DC
 1 A
 0.16 Ω/m
 -20°C ... 50°C
 Insulation displacement, IEC 60352-4/DIN EN 60352-4

Conductor cross section
 Outside diameter

AWG 26 / 0.14 mm²

10 -position 6.1 mm
 14 -position 6.4 mm
 16 -position 6.8 mm
 20 -position 7.6 mm

Ordering data

| Description | No. of pos. | Cable length | Type | Order No. | Pcs. / Pkt. |
|---|-------------|--------------|-------------------------|-----------|-------------|
| Round cable, with two molded socket strips | | | | | |
| | 10 | 0.5 m | VIP-CAB-FLK10/0,14/0,5M | 2318305 | 1 |
| | 10 | 1 m | VIP-CAB-FLK10/0,14/1,0M | 2318318 | 1 |
| | 10 | 1.5 m | VIP-CAB-FLK10/0,14/1,5M | 2318321 | 1 |
| | 10 | 2 m | VIP-CAB-FLK10/0,14/2,0M | 2318334 | 1 |
| | 10 | 3 m | VIP-CAB-FLK10/0,14/3,0M | 2318347 | 1 |
| | 10 | 4 m | VIP-CAB-FLK10/0,14/4,0M | 2318350 | 1 |
| | 10 | 6 m | VIP-CAB-FLK10/0,14/6,0M | 2318363 | 1 |
| Round cable, same as before, in variable lengths (minimum ordering quantity five pieces) | | | | | |
| | 10 | | VIP-CAB-FLK10-0,14/... | 2318376 | 1 |
| Round cable, with two molded socket strips | | | | | |
| | 14 | 0.5 m | VIP-CAB-FLK14/0,14/0,5M | 2318389 | 1 |
| | 14 | 1 m | VIP-CAB-FLK14/0,14/1,0M | 2318392 | 1 |
| | 14 | 1.5 m | VIP-CAB-FLK14/0,14/1,5M | 2318402 | 1 |
| | 14 | 2 m | VIP-CAB-FLK14/0,14/2,0M | 2318415 | 1 |
| | 14 | 3 m | VIP-CAB-FLK14/0,14/3,0M | 2318428 | 1 |
| | 14 | 4 m | VIP-CAB-FLK14/0,14/4,0M | 2318431 | 1 |
| | 14 | 6 m | VIP-CAB-FLK14/0,14/6,0M | 2318444 | 1 |
| Round cable, same as before, in variable lengths (minimum ordering quantity five pieces) | | | | | |
| | 14 | | VIP-CAB-FLK14-0,14/... | 2318457 | 1 |
| Round cable, with two molded socket strips | | | | | |
| | 16 | 0.5 m | VIP-CAB-FLK16/0,14/0,5M | 2318460 | 1 |
| | 16 | 1 m | VIP-CAB-FLK16/0,14/1,0M | 2318473 | 1 |
| | 16 | 1.5 m | VIP-CAB-FLK16/0,14/1,5M | 2318486 | 1 |
| | 16 | 2 m | VIP-CAB-FLK16/0,14/2,0M | 2318499 | 1 |
| | 16 | 3 m | VIP-CAB-FLK16/0,14/3,0M | 2318509 | 1 |
| | 16 | 4 m | VIP-CAB-FLK16/0,14/4,0M | 2318512 | 1 |
| | 16 | 6 m | VIP-CAB-FLK16/0,14/6,0M | 2318525 | 1 |
| Round cable, same as before, in variable lengths (minimum ordering quantity five pieces) | | | | | |
| | 16 | | VIP-CAB-FLK16-0,14/... | 2318538 | 1 |
| Round cable, with two molded socket strips | | | | | |
| | 20 | 0.5 m | VIP-CAB-FLK20/0,14/0,5M | 2318541 | 1 |
| | 20 | 1 m | VIP-CAB-FLK20/0,14/1,0M | 2318554 | 1 |
| | 20 | 1.5 m | VIP-CAB-FLK20/0,14/1,5M | 2318567 | 1 |
| | 20 | 2 m | VIP-CAB-FLK20/0,14/2,0M | 2318570 | 1 |
| | 20 | 3 m | VIP-CAB-FLK20/0,14/3,0M | 2318583 | 1 |
| | 20 | 4 m | VIP-CAB-FLK20/0,14/4,0M | 2318596 | 1 |
| | 20 | 6 m | VIP-CAB-FLK20/0,14/6,0M | 2318606 | 1 |
| Round cable, same as before, in variable lengths (minimum ordering quantity five pieces) | | | | | |
| | 20 | | VIP-CAB-FLK20-0,14/... | 2318619 | 1 |

Ordering example for system cable:

– 10-pos. cable, 7.6 m long

| Quantity | Order No. | Length [m] |
|----------|-----------|------------------|
| 1 | 2318376 | 7.6 |
| | | Min. 0.5 m |
| | | Max. 100.0 m |
| | | Step width 0.1 m |

VIP – VARIOFACE Professional system cables with flat-ribbon plug-in connectors

- 1:1 connection
- 26- to 50-pos.
- Plug-in connectors as per IEC 60603-13
- In the desired lengths
- Individual serial number

Note:

Due to the enlarged outer contour of the molded connectors, module types with UM45 profile and three-level terminal blocks cannot be connected with the VIP-CAB-FLK... system cable.

The following module types (10- to 50-pos.) can be connected.

For example, for 20 positions:

- VIP-2/SC/FLK 20
- VIP-2/SC/FLK20/LED
- FLKM 20/ZFKDS
- UM45-FLK 20/ZFKDS (double-level connection)

The VIP-CAB-FLK... system cables are not suitable for front adapters (see the dimensional drawing).



| | A | B |
|-------------|----|----|
| ...FLK26... | 39 | 51 |
| ...FLK34... | 40 | 52 |
| ...FLK40... | 40 | 52 |
| ...FLK50... | 42 | 55 |



not shielded



Max. perm. operating voltage
 Max. perm. current carrying capacity per path
 Max. conductor resistance
 Ambient temperature (operation)
 Assembly

Conductor cross section
 Outside diameter

26 -position
 34 -position
 40 -position
 50 -position

< 50 V AC / 60 V DC
 1 A
 0.16 Ω/m
 -20°C ... 50°C
 Insulation displacement, IEC 60352-4/DIN EN 60352-4

AWG 26 / 0.14 mm²

8.3 mm
 8.7 mm
 9.9 mm
 10.3 mm

Technical data

Ordering data

| Description | No. of pos. | Cable length | Type | Order No. | Pcs. / Pkt. |
|---|-------------|--------------|-------------------------|-----------|-------------|
| Round cable, with two molded socket strips | | | | | |
| | 26 | 0.5 m | VIP-CAB-FLK26/0,14/0,5M | 2318622 | 1 |
| | 26 | 1 m | VIP-CAB-FLK26/0,14/1,0M | 2318635 | 1 |
| | 26 | 1.5 m | VIP-CAB-FLK26/0,14/1,5M | 2318648 | 1 |
| | 26 | 2 m | VIP-CAB-FLK26/0,14/2,0M | 2318651 | 1 |
| | 26 | 3 m | VIP-CAB-FLK26/0,14/3,0M | 2318664 | 1 |
| | 26 | 4 m | VIP-CAB-FLK26/0,14/4,0M | 2318677 | 1 |
| | 26 | 6 m | VIP-CAB-FLK26/0,14/6,0M | 2318680 | 1 |
| Round cable, same as before, in variable lengths (minimum ordering quantity five pieces) | | | | | |
| | 26 | | VIP-CAB-FLK26-0,14/... | 2318693 | 1 |
| Round cable, with two molded socket strips | | | | | |
| | 34 | 0.5 m | VIP-CAB-FLK34/0,14/0,5M | 2318703 | 1 |
| | 34 | 1 m | VIP-CAB-FLK34/0,14/1,0M | 2318716 | 1 |
| | 34 | 1.5 m | VIP-CAB-FLK34/0,14/1,5M | 2318729 | 1 |
| | 34 | 2 m | VIP-CAB-FLK34/0,14/2,0M | 2318732 | 1 |
| | 34 | 3 m | VIP-CAB-FLK34/0,14/3,0M | 2318745 | 1 |
| | 34 | 4 m | VIP-CAB-FLK34/0,14/4,0M | 2318758 | 1 |
| | 34 | 6 m | VIP-CAB-FLK34/0,14/6,0M | 2318761 | 1 |
| Round cable, same as before, in variable lengths (minimum ordering quantity five pieces) | | | | | |
| | 34 | | VIP-CAB-FLK34-0,14/... | 2318774 | 1 |
| Round cable, with two molded socket strips | | | | | |
| | 40 | 0.5 m | VIP-CAB-FLK40/0,14/0,5M | 2318787 | 1 |
| | 40 | 1 m | VIP-CAB-FLK40/0,14/1,0M | 2318790 | 1 |
| | 40 | 1.5 m | VIP-CAB-FLK40/0,14/1,5M | 2318800 | 1 |
| | 40 | 2 m | VIP-CAB-FLK40/0,14/2,0M | 2318813 | 1 |
| | 40 | 3 m | VIP-CAB-FLK40/0,14/3,0M | 2318826 | 1 |
| | 40 | 4 m | VIP-CAB-FLK40/0,14/4,0M | 2318839 | 1 |
| | 40 | 6 m | VIP-CAB-FLK40/0,14/6,0M | 2318842 | 1 |
| Round cable, same as before, in variable lengths (minimum ordering quantity five pieces) | | | | | |
| | 40 | | VIP-CAB-FLK40-0,14/... | 2318855 | 1 |
| Round cable, with two molded socket strips | | | | | |
| | 50 | 0.5 m | VIP-CAB-FLK50/0,14/0,5M | 2318868 | 1 |
| | 50 | 1 m | VIP-CAB-FLK50/0,14/1,0M | 2318871 | 1 |
| | 50 | 1.5 m | VIP-CAB-FLK50/0,14/1,5M | 2318884 | 1 |
| | 50 | 2 m | VIP-CAB-FLK50/0,14/2,0M | 2318897 | 1 |
| | 50 | 3 m | VIP-CAB-FLK50/0,14/3,0M | 2318907 | 1 |
| | 50 | 4 m | VIP-CAB-FLK50/0,14/4,0M | 2318910 | 1 |
| | 50 | 6 m | VIP-CAB-FLK50/0,14/6,0M | 2318923 | 1 |
| Round cable, same as before, in variable lengths (minimum ordering quantity five pieces) | | | | | |
| | 50 | | VIP-CAB-FLK50-0,14/... | 2318936 | 1 |

Ordering example for system cable:

– 26-pos. cable, 12.6 m long

| Quantity | Order No. | Length [m] |
|----------|-----------|------------------|
| 1 | 2318693 | 12.6 |
| | | Min. 0.5 m |
| | | Max. 100.0 m |
| | | Step width 0.1 m |

System cabling for controllers

VARIOFACE system cabling

System cable with a flat-ribbon cable plug-in connector and an open end

- 1:1 connection
- 10-, 14-, and 16-pos.
- Plug-in connectors as per IEC 60603-13
- Open end at the other end

The individual wires at the open end are labeled (1, 2, 3, 4, ...) and equipped with a ferrule.



Molded plug-in connectors, not shielded



not shielded

Notes:
In the case of molded connectors, please observe the dimensional drawing and note, see page 500



| | Technical data | Technical data |
|--|---|---|
| Max. perm. operating voltage | < 50 V AC / 60 V DC | < 50 V AC / 60 V DC |
| Max. perm. current carrying capacity per path | 1 A | 1 A |
| Max. conductor resistance | 0.16 Ω/m | 0.16 Ω/m |
| Ambient temperature (operation) | -20°C ... 50°C | -20°C ... 50°C |
| Assembly | Insulation displacement, IEC 60352-4/DIN EN 60352-4 | Insulation displacement, IEC 60352-4/DIN EN 60352-4 |
| Conductor cross section | AWG 26 / 0.14 mm ² | AWG 26 / 0.14 mm ² |
| Conductor structure: stranded wires / material | 7 / Cu tin-plated | 7 / Cu tin-plated |
| Outside diameter | | |
| | 10 -position 6.1 mm | 6.1 mm |
| | 14 -position 6.4 mm | 6.4 mm |
| | 16 -position 6.5 mm | 6.5 mm |

| | | | Ordering data | | | Ordering data | | |
|---|-------------|--------------|-------------------------------|-----------|-------------|---------------------------|-----------|-------------|
| Description | No. of pos. | Cable length | Type | Order No. | Pcs. / Pkt. | Type | Order No. | Pcs. / Pkt. |
| Round cable with an open end | 10 | 0.5 m | | | | CABLE-FLK10/OE/0,14/ 0,5M | 2904073 | 1 |
| | 10 | 1 m | | | | CABLE-FLK10/OE/0,14/ 1,0M | 2904074 | 1 |
| | 10 | 1.5 m | | | | CABLE-FLK10/OE/0,14/ 1,5M | 2904075 | 1 |
| | 10 | 2 m | | | | CABLE-FLK10/OE/0,14/ 2,0M | 2904076 | 1 |
| | 10 | 2.5 m | | | | CABLE-FLK10/OE/0,14/ 2,5M | 2904077 | 1 |
| | 10 | 3 m | | | | CABLE-FLK10/OE/0,14/ 3,0M | 2904078 | 1 |
| | 10 | 4 m | | | | CABLE-FLK10/OE/0,14/ 4,0M | 2904079 | 1 |
| | 10 | 6 m | | | | CABLE-FLK10/OE/0,14/ 6,0M | 2904080 | 1 |
| | 10 | 8 m | | | | CABLE-FLK10/OE/0,14/ 8,0M | 2904081 | 1 |
| | 10 | 10 m | | | | CABLE-FLK10/OE/0,14/10,0M | 2904082 | 1 |
| Round cable, same as before, however in variable lengths | 10 | | | | | CABLE-FLK10-OE-0,14/... | 2904331 | 1 |
| Round cable with an open end | 14 | 0.5 m | VIP-CAB-FLK14/FR/OE/0,14/0,5M | 2900122 | 1 | CABLE-FLK14/OE/0,14/ 50 | 2305761 | 1 |
| | 14 | 1 m | VIP-CAB-FLK14/FR/OE/0,14/1,0M | 2900123 | 1 | CABLE-FLK14/OE/0,14/ 100 | 2305253 | 1 |
| | 14 | 1.5 m | VIP-CAB-FLK14/FR/OE/0,14/1,5M | 2900125 | 1 | CABLE-FLK14/OE/0,14/ 150 | 2305266 | 1 |
| | 14 | 2 m | VIP-CAB-FLK14/FR/OE/0,14/2,0M | 2900126 | 1 | CABLE-FLK14/OE/0,14/ 200 | 2305279 | 1 |
| | 14 | 2.5 m | | | | CABLE-FLK14/OE/0,14/ 250 | 2305282 | 1 |
| | 14 | 3 m | VIP-CAB-FLK14/FR/OE/0,14/3,0M | 2900127 | 1 | CABLE-FLK14/OE/0,14/ 300 | 2305295 | 1 |
| | 14 | 4 m | VIP-CAB-FLK14/FR/OE/0,14/4,0M | 2900128 | 1 | CABLE-FLK14/OE/0,14/ 400 | 2305774 | 1 |
| | 14 | 6 m | VIP-CAB-FLK14/FR/OE/0,14/6,0M | 2900129 | 1 | CABLE-FLK14/OE/0,14/ 600 | 2305787 | 1 |
| | 14 | 8 m | | | | CABLE-FLK14/OE/0,14/ 800 | 2305790 | 1 |
| | 14 | 10 m | | | | CABLE-FLK14/OE/0,14/1000 | 2305800 | 1 |
| Round cable, same as before, however in variable lengths | 14 | | | | | CABLE-FLK14/OE/0,14/... | 2305732 | 1 |
| Round cable with an open end | 16 | 0.5 m | VIP-CAB-FLK16/FR/OE/0,14/0,5M | 2900130 | 1 | CABLE-FLK16/OE/0,14/ 0,5M | 2318127 | 1 |
| | 16 | 1 m | VIP-CAB-FLK16/FR/OE/0,14/1,0M | 2900131 | 1 | CABLE-FLK16/OE/0,14/ 1,0M | 2318130 | 1 |
| | 16 | 1.5 m | VIP-CAB-FLK16/FR/OE/0,14/1,5M | 2900132 | 1 | CABLE-FLK16/OE/0,14/ 1,5M | 2318143 | 1 |
| | 16 | 2 m | VIP-CAB-FLK16/FR/OE/0,14/2,0M | 2900133 | 1 | CABLE-FLK16/OE/0,14/ 2,0M | 2318156 | 1 |
| | 16 | 2.5 m | | | | CABLE-FLK16/OE/0,14/ 2,5M | 2318169 | 1 |
| | 16 | 3 m | VIP-CAB-FLK16/FR/OE/0,14/3,0M | 2900134 | 1 | CABLE-FLK16/OE/0,14/ 3,0M | 2318172 | 1 |
| | 16 | 4 m | VIP-CAB-FLK16/FR/OE/0,14/4,0M | 2900135 | 1 | CABLE-FLK16/OE/0,14/ 4,0M | 2318185 | 1 |
| | 16 | 6 m | VIP-CAB-FLK16/FR/OE/0,14/6,0M | 2900136 | 1 | CABLE-FLK16/OE/0,14/ 6,0M | 2318198 | 1 |
| | 16 | 8 m | | | | CABLE-FLK16/OE/0,14/ 8,0M | 2318208 | 1 |
| | 16 | 10 m | | | | CABLE-FLK16/OE/0,14/10,0M | 2318211 | 1 |
| Round cable, same as before, however in variable lengths | 16 | | | | | CABLE-FLK16/OE/0,14/... | 2318224 | 1 |

System cable with a flat-ribbon cable plug-in connector and an open end

- 1:1 connection
- 20- and 50-pos.
- Plug-in connectors as per IEC 60603-13
- Open end at the other end

The individual wires at the open end are labeled (1, 2, 3, 4, ...) and equipped with a ferrule.

Notes:
In the case of molded connectors, please observe the dimensional drawing and note, see page 500



Molded plug-in connectors, not shielded



not shielded



Max. perm. operating voltage
Max. perm. current carrying capacity per path
Max. conductor resistance
Ambient temperature (operation)
Assembly

| Technical data | |
|--|---|
| Max. perm. operating voltage | < 50 V AC / 60 V DC |
| Max. perm. current carrying capacity per path | 1 A |
| Max. conductor resistance | 0.16 Ω/m |
| Ambient temperature (operation) | -20°C ... 50°C |
| Assembly | Insulation displacement, IEC 60352-4/DIN EN 60352-4 |
| Conductor cross section | AWG 26 / 0.14 mm ² |
| Conductor structure: stranded wires / material | 7 / Cu tin-plated |
| Outside diameter | 20 -position: 7.6 mm 50 -position: 10.3 mm |

| Technical data | |
|--|---|
| Max. perm. operating voltage | < 50 V AC / 60 V DC |
| Max. perm. current carrying capacity per path | 1 A |
| Max. conductor resistance | 0.16 Ω/m |
| Ambient temperature (operation) | -20°C ... 50°C |
| Assembly | Insulation displacement, IEC 60352-4/DIN EN 60352-4 |
| Conductor cross section | AWG 26 / 0.14 mm ² |
| Conductor structure: stranded wires / material | 7 / Cu tin-plated |
| Outside diameter | 7.6 mm 10.3 mm |

| Description | No. of pos. | Cable length |
|---|-------------|--------------|
| Round cable with an open end | 20 | 0.5 m |
| | 20 | 1 m |
| | 20 | 1.5 m |
| | 20 | 2 m |
| | 20 | 2.5 m |
| | 20 | 3 m |
| | 20 | 4 m |
| | 20 | 6 m |
| | 20 | 8 m |
| | 20 | 10 m |
| Round cable, same as before, however in variable lengths | 20 | |
| Round cable with an open end | 50 | 0.5 m |
| | 50 | 1 m |
| | 50 | 1.5 m |
| | 50 | 2 m |
| | 50 | 2.5 m |
| | 50 | 3 m |
| | 50 | 4 m |
| | 50 | 6 m |
| | 50 | 8 m |
| | 50 | 10 m |
| Round cable, same as before, however in variable lengths | 50 | |

| Ordering data | | |
|-------------------------------|-----------|-------------|
| Type | Order No. | Pcs. / Pkt. |
| VIP-CAB-FLK20/FR/OE/0,14/0,5M | 2900138 | 1 |
| VIP-CAB-FLK20/FR/OE/0,14/1,0M | 2900139 | 1 |
| VIP-CAB-FLK20/FR/OE/0,14/1,5M | 2900141 | 1 |
| VIP-CAB-FLK20/FR/OE/0,14/2,0M | 2900142 | 1 |
| VIP-CAB-FLK20/FR/OE/0,14/3,0M | 2900143 | 1 |
| VIP-CAB-FLK20/FR/OE/0,14/4,0M | 2900144 | 1 |
| VIP-CAB-FLK20/FR/OE/0,14/6,0M | 2900145 | 1 |
| VIP-CAB-FLK50/FR/OE/0,14/0,5M | 2900146 | 1 |
| VIP-CAB-FLK50/FR/OE/0,14/1,0M | 2900147 | 1 |
| VIP-CAB-FLK50/FR/OE/0,14/1,5M | 2900148 | 1 |
| VIP-CAB-FLK50/FR/OE/0,14/2,0M | 2900149 | 1 |
| VIP-CAB-FLK50/FR/OE/0,14/3,0M | 2900150 | 1 |
| VIP-CAB-FLK50/FR/OE/0,14/4,0M | 2900151 | 1 |
| VIP-CAB-FLK50/FR/OE/0,14/6,0M | 2900152 | 1 |

| Ordering data | | |
|--------------------------|-----------|-------------|
| Type | Order No. | Pcs. / Pkt. |
| CABLE-FLK20/OE/0,14/ 50 | 2305826 | 1 |
| CABLE-FLK20/OE/0,14/ 100 | 2305305 | 1 |
| CABLE-FLK20/OE/0,14/ 150 | 2305318 | 1 |
| CABLE-FLK20/OE/0,14/ 200 | 2305321 | 1 |
| CABLE-FLK20/OE/0,14/ 250 | 2305334 | 1 |
| CABLE-FLK20/OE/0,14/ 300 | 2305347 | 1 |
| CABLE-FLK20/OE/0,14/ 400 | 2305839 | 1 |
| CABLE-FLK20/OE/0,14/ 600 | 2305842 | 1 |
| CABLE-FLK20/OE/0,14/ 800 | 2305855 | 1 |
| CABLE-FLK20/OE/0,14/1000 | 2305868 | 1 |
| CABLE-FLK20/OE/0,14/... | 2305745 | 1 |
| CABLE-FLK50/OE/0,14/ 50 | 2305871 | 1 |
| CABLE-FLK50/OE/0,14/ 100 | 2305350 | 1 |
| CABLE-FLK50/OE/0,14/ 150 | 2305363 | 1 |
| CABLE-FLK50/OE/0,14/ 200 | 2305376 | 1 |
| CABLE-FLK50/OE/0,14/ 250 | 2305389 | 1 |
| CABLE-FLK50/OE/0,14/ 300 | 2305392 | 1 |
| CABLE-FLK50/OE/0,14/ 400 | 2305884 | 1 |
| CABLE-FLK50/OE/0,14/ 600 | 2305897 | 1 |
| CABLE-FLK50/OE/0,14/ 800 | 2305907 | 1 |
| CABLE-FLK50/OE/0,14/1000 | 2305910 | 1 |
| CABLE-FLK50/OE/0,14/... | 2305758 | 1 |

System cabling for controllers

VARIOFACE system cabling

System cable with flat-ribbon cable plug-in connector

Standard lengths

Round cable sets are used to connect the PLC front adapters to the corresponding VARIOFACE controller boards.

The following versions are available with 14 and 50 positions:

- Not shielded
- Shielded
- Halogen-free

Plug-in connector strips are fitted on both sides of the cables in accordance with IEC 60603-13/DIN 41651 (1:1 connection).

In case of shielded cables, a cable end with a ferrule is additionally provided as a shield connection (length: approx. 0.5 m; cable H05V-K 1 mm², black).

Special lengths are defined using an order key, refer to page 510.



not shielded



Technical data

| | |
|--|---|
| Max. perm. operating voltage | < 50 V AC / 60 V DC |
| Max. perm. current carrying capacity per path | 1 A |
| Max. conductor resistance | 0.16 Ω/m |
| Ambient temperature (operation) | -20°C ... 50°C |
| Shield | - |
| Assembly | Insulation displacement, IEC 60352-4/DIN EN 60352-4 |
| Conductor cross section | AWG 26 / 0.14 mm ² |
| Conductor structure: stranded wires / material | 7 / Cu tin-plated |
| Outside diameter | 14 -position: 6.4 mm 50 -position: 10.3 mm |

Ordering data

| Description | No. of pos. | Cable length | Type | Order No. | Pcs. / Pkt. |
|---|-------------|--------------|--------------------------|-----------|-------------|
| Assembled round cables¹⁾ , with two 14-pos. socket strips in fixed lengths, for transfer of eight channels among other things | | | | | |
| | 14 | 0.3 m | FLK 14/EZ-DR/ 30/KONFEK | 2295729 | 5 |
| | 14 | 0.5 m | FLK 14/EZ-DR/ 50/KONFEK | 2288901 | 5 |
| | 14 | 1 m | FLK 14/EZ-DR/ 100/KONFEK | 2288914 | 1 |
| | 14 | 1.5 m | FLK 14/EZ-DR/ 150/KONFEK | 2288927 | 1 |
| | 14 | 2 m | FLK 14/EZ-DR/ 200/KONFEK | 2288930 | 1 |
| | 14 | 2.5 m | FLK 14/EZ-DR/ 250/KONFEK | 2288943 | 1 |
| | 14 | 3 m | FLK 14/EZ-DR/ 300/KONFEK | 2288956 | 1 |
| | 14 | 3.5 m | FLK 14/EZ-DR/ 350/KONFEK | 2288969 | 1 |
| | 14 | 4 m | FLK 14/EZ-DR/ 400/KONFEK | 2288972 | 1 |
| | 14 | 4.5 m | FLK 14/EZ-DR/ 450/KONFEK | 2290847 | 1 |
| | 14 | 5 m | FLK 14/EZ-DR/ 500/KONFEK | 2290834 | 1 |
| | 14 | 5.5 m | FLK 14/EZ-DR/ 550/KONFEK | 2290850 | 1 |
| | 14 | 6 m | FLK 14/EZ-DR/ 600/KONFEK | 2290863 | 1 |
| | 14 | 7 m | | | |
| | 14 | 8 m | FLK 14/EZ-DR/ 800/KONFEK | 2299563 | 1 |
| | 14 | 10 m | FLK 14/EZ-DR/1000/KONFEK | 2299576 | 1 |
| Assembled round cables²⁾ , with two 50-pos. socket strips in fixed lengths, for transfer of 32 channels among other things | | | | | |
| | 50 | 0.5 m | FLK 50/EZ-DR/ 50/KONFEK | 2289065 | 5 |
| | 50 | 1 m | FLK 50/EZ-DR/ 100/KONFEK | 2289078 | 1 |
| | 50 | 1.5 m | FLK 50/EZ-DR/ 150/KONFEK | 2289081 | 1 |
| | 50 | 2 m | FLK 50/EZ-DR/ 200/KONFEK | 2289094 | 1 |
| | 50 | 2.5 m | FLK 50/EZ-DR/ 250/KONFEK | 2289104 | 1 |
| | 50 | 3 m | FLK 50/EZ-DR/ 300/KONFEK | 2289117 | 1 |
| | 50 | 3.5 m | FLK 50/EZ-DR/ 350/KONFEK | 2289120 | 1 |
| | 50 | 4 m | FLK 50/EZ-DR/ 400/KONFEK | 2289133 | 1 |
| | 50 | 4.5 m | FLK 50/EZ-DR/ 450/KONFEK | 2289573 | 1 |
| | 50 | 5 m | FLK 50/EZ-DR/ 500/KONFEK | 2289586 | 1 |
| | 50 | 5.5 m | FLK 50/EZ-DR/ 550/KONFEK | 2289599 | 1 |
| | 50 | 6 m | FLK 50/EZ-DR/ 600/KONFEK | 2289609 | 1 |
| | 50 | 6.5 m | FLK 50/EZ-DR/ 650/KONFEK | 2289612 | 1 |
| | 50 | 7 m | FLK 50/EZ-DR/ 700/KONFEK | 2289625 | 1 |
| | 50 | 7.5 m | FLK 50/EZ-DR/ 750/KONFEK | 2289638 | 1 |
| | 50 | 8 m | FLK 50/EZ-DR/ 800/KONFEK | 2289641 | 1 |
| | 50 | 8.5 m | FLK 50/EZ-DR/ 850/KONFEK | 2289654 | 1 |
| | 50 | 9 m | FLK 50/EZ-DR/ 900/KONFEK | 2289667 | 1 |
| | 50 | 9.5 m | FLK 50/EZ-DR/ 950/KONFEK | 2289670 | 1 |
| | 50 | 10 m | FLK 50/EZ-DR/1000/KONFEK | 2289683 | 1 |



Shielded



Halogen-free (only the cable)



Applied for: cUL / UL

| Technical data | |
|---|--|
| < 50 V AC / 60 V DC | |
| 1 A | |
| 0.16 Ω/m | |
| -20°C ... 50°C | |
| Tinned copper-braided shield, approx. 85% covering | |
| Insulation displacement, IEC 60352-4/DIN EN 60352-4 | |
| AWG 26 / 0.14 mm ² | |
| 7 / Cu tin-plated | |
| 6.7 mm | |
| 11 mm | |

| Technical data | |
|---|--|
| < 50 V AC / 60 V DC | |
| 1 A | |
| 0.16 Ω/m | |
| -20°C ... 50°C | |
| - | |
| Insulation displacement, IEC 60352-4/DIN EN 60352-4 | |
| AWG 26 / 0.14 mm ² | |
| 7 / Cu tin-plated | |
| 6.4 mm | |
| 10.3 mm | |

| Ordering data | | |
|----------------------------|-----------|-------------|
| Type | Order No. | Pcs. / Pkt. |
| FLK 14/EZ-DR/ 50/KONFEK/S | 2296977 | 1 |
| FLK 14/EZ-DR/ 100/KONFEK/S | 2296980 | 1 |
| FLK 14/EZ-DR/ 150/KONFEK/S | 2296993 | 1 |
| FLK 14/EZ-DR/ 200/KONFEK/S | 2297002 | 1 |
| FLK 14/EZ-DR/ 300/KONFEK/S | 2299013 | 1 |
| FLK 14/EZ-DR/ 400/KONFEK/S | 2299026 | 1 |
| FLK 14/EZ-DR/ 600/KONFEK/S | 2299039 | 1 |
| FLK 14/EZ-DR/ 800/KONFEK/S | 2299042 | 1 |
| FLK 14/EZ-DR/1000/KONFEK/S | 2299055 | 1 |
| FLK 50/EZ-DR/ 50/KONFEK/S | 2299097 | 1 |
| FLK 50/EZ-DR/ 100/KONFEK/S | 2299107 | 1 |
| FLK 50/EZ-DR/ 150/KONFEK/S | 2299110 | 1 |
| FLK 50/EZ-DR/ 200/KONFEK/S | 2299123 | 1 |
| FLK 50/EZ-DR/ 300/KONFEK/S | 2299136 | 1 |
| FLK 50/EZ-DR/ 400/KONFEK/S | 2299149 | 1 |
| FLK 50/EZ-DR/ 600/KONFEK/S | 2299152 | 1 |
| FLK 50/EZ-DR/ 800/KONFEK/S | 2299165 | 1 |
| FLK 50/EZ-DR/1000/KONFEK/S | 2299178 | 1 |

| Ordering data | | |
|-----------------------------|-----------|-------------|
| Type | Order No. | Pcs. / Pkt. |
| FLK 14/EZ-DR/HF/ 50/KONFEK | 2305952 | 1 |
| FLK 14/EZ-DR/HF/ 100/KONFEK | 2305965 | 1 |
| FLK 14/EZ-DR/HF/ 150/KONFEK | 2305978 | 1 |
| FLK 14/EZ-DR/HF/ 200/KONFEK | 2305981 | 1 |
| FLK 14/EZ-DR/HF/ 250/KONFEK | 2305994 | 1 |
| FLK 14/EZ-DR/HF/ 300/KONFEK | 2304759 | 1 |
| FLK 14/EZ-DR/HF/ 400/KONFEK | 2304762 | 1 |
| FLK 14/EZ-DR/HF/ 500/KONFEK | 2304717 | 1 |
| FLK 14/EZ-DR/HF/ 600/KONFEK | 2306003 | 1 |
| FLK 14/EZ-DR/HF/ 700/KONFEK | 2314011 | 1 |
| FLK 14/EZ-DR/HF/ 800/KONFEK | 2314024 | 1 |
| FLK 14/EZ-DR/HF/1000/KONFEK | 2314037 | 1 |
| CABLE-FLK50/0,14/HF/ 0,5M | 2314134 | 1 |
| CABLE-FLK50/0,14/HF/ 1,0M | 2314147 | 1 |
| CABLE-FLK50/0,14/HF/ 1,5M | 2314150 | 1 |
| CABLE-FLK50/0,14/HF/ 2,0M | 2314163 | 1 |
| CABLE-FLK50/0,14/HF/ 2,5M | 2314176 | 1 |
| CABLE-FLK50/0,14/HF/ 3,0M | 2314189 | 1 |
| CABLE-FLK50/0,14/HF/ 4,0M | 2314192 | 1 |
| CABLE-FLK50/0,14/HF/ 5,0M | 2314202 | 1 |
| CABLE-FLK50/0,14/HF/ 6,0M | 2314215 | 1 |
| CABLE-FLK50/0,14/HF/ 7,0M | 2314228 | 1 |
| CABLE-FLK50/0,14/HF/ 8,0M | 2314231 | 1 |
| CABLE-FLK50/0,14/HF/10,0M | 2314244 | 1 |

Color code of system cables

| No. of wires | PIN | Wire color |
|--------------|-----|---------------|
| | 1 | Black |
| | 2 | Brown |
| | 3 | Red |
| | 4 | Orange |
| | 5 | Yellow |
| | 6 | Green |
| | 7 | Blue |
| | 8 | Violet |
| | 9 | Gray |
| 10-pos. | 10 | White |
| | 11 | White-black |
| | 12 | White-brown |
| 14-pos. | 13 | White-red |
| | 14 | White-orange |
| | 15 | White-yellow |
| 16-pos. | 16 | White-green |
| | 17 | White-blue |
| | 18 | White-violet |
| 20-pos. | 19 | White-gray |
| | 20 | Brown-black |
| | 21 | Brown-red |
| | 22 | Brown-orange |
| | 23 | Brown-yellow |
| | 24 | Brown-green |
| 26-pos. | 25 | Brown-blue |
| | 26 | Brown-violet |
| | 27 | Brown-gray |
| | 28 | Brown-white |
| | 29 | Green-black |
| | 30 | Green-brown |
| | 31 | Green-red |
| | 32 | Green-orange |
| | 33 | Green-blue |
| 34-pos. | 34 | Green-violet |
| | 35 | Green-gray |
| | 36 | Green-white |
| | 37 | Yellow-black |
| | 38 | Yellow-brown |
| | 39 | Yellow-red |
| 40-pos. | 40 | Yellow-orange |
| | 41 | Yellow-blue |
| | 42 | Yellow-violet |
| | 43 | Yellow-gray |
| | 44 | Yellow-white |
| | 45 | Gray-black |
| | 46 | Gray-brown |
| | 47 | Gray-red |
| | 48 | Gray-orange |
| | 49 | Gray-yellow |
| 50-pos. | 50 | Gray-green |

1) Socket strips assembled straight at both ends.



2) Socket strips assembled straight at one end and angled at the other.



System cabling for controllers

VARIOFACE system cabling

System cable with flat-ribbon cable plug-in connector

Standard lengths

Pre-assembled round cables to couple the VARIOFACE interface modules.

Plug-in connector strips are fitted on both sides of the cables in accordance with IEC 60603-13/DIN 41651 (1:1 connection).

Special lengths are defined using an order key, refer to page 510.



not shielded

| Notes: |
|--------------------------------------|
| Outside diameter of the cable |
| 10-pos.: 6 mm |
| 16-pos.: 6.5 mm |
| 20-pos.: 7.6 mm |
| 26-pos.: 7.8 mm |
| 34-pos.: 10 mm |

Max. perm. operating voltage
 Max. perm. current carrying capacity per path
 Max. conductor resistance
 Ambient temperature (operation)
 Assembly

Conductor cross section
 Conductor structure: stranded wires / material



Applied for: cUL / UL

Technical data

< 50 V AC / 60 V DC
 1 A
 0.16 Ω/m
 -20°C ... 50°C
 Insulation displacement, IEC 60352-4/DIN EN 60352-4

AWG 26 / 0.14 mm²
 7 / Cu tin-plated

Ordering data

| Description | No. of pos. | Cable length | Type | Order No. | Pcs. / Pkt. |
|--|--|--------------|--------------------------|-------------------------|-------------|
| Round cable¹⁾ , with two socket strips | 10 | 0.5 m | FLK 10/EZ-DR/ 50/KONFEK | 2299204 | 1 |
| | 10 | 1 m | FLK 10/EZ-DR/ 100/KONFEK | 2299217 | 1 |
| | 10 | 1.5 m | FLK 10/EZ-DR/ 150/KONFEK | 2299220 | 1 |
| | 10 | 2 m | FLK 10/EZ-DR/ 200/KONFEK | 2299233 | 1 |
| | 10 | 3 m | FLK 10/EZ-DR/ 300/KONFEK | 2299246 | 1 |
| | 10 | 4 m | FLK 10/EZ-DR/ 400/KONFEK | 2299259 | 1 |
| | 10 | 6 m | FLK 10/EZ-DR/ 600/KONFEK | 2299262 | 1 |
| | 10 | 8 m | FLK 10/EZ-DR/ 800/KONFEK | 2299275 | 1 |
| | 10 | 10 m | FLK 10/EZ-DR/1000/KONFEK | 2299288 | 1 |
| | Round cable¹⁾ , with two socket strips | 16 | 0.5 m | FLK 16/EZ-DR/ 50/KONFEK | 2299291 |
| 16 | | 1 m | FLK 16/EZ-DR/ 100/KONFEK | 2299301 | 1 |
| 16 | | 1.5 m | FLK 16/EZ-DR/ 150/KONFEK | 2299314 | 1 |
| 16 | | 2 m | FLK 16/EZ-DR/ 200/KONFEK | 2299327 | 1 |
| 16 | | 3 m | FLK 16/EZ-DR/ 300/KONFEK | 2299330 | 1 |
| 16 | | 4 m | FLK 16/EZ-DR/ 400/KONFEK | 2299343 | 1 |
| 16 | | 6 m | FLK 16/EZ-DR/ 600/KONFEK | 2299356 | 1 |
| 16 | | 8 m | FLK 16/EZ-DR/ 800/KONFEK | 2299369 | 1 |
| 16 | | 10 m | FLK 16/EZ-DR/1000/KONFEK | 2299372 | 1 |
| Round cable¹⁾ , with two socket strips | | 20 | 0.5 m | FLK 20/EZ-DR/ 50KONFEK | 2296391 |
| | 20 | 1 m | FLK 20/EZ-DR/ 100KONFEK | 2296401 | 1 |
| | 20 | 1.5 m | FLK 20/EZ-DR/ 150KONFEK | 2296472 | 1 |
| | 20 | 2 m | FLK 20/EZ-DR/ 200KONFEK | 2296485 | 1 |
| | 20 | 3 m | FLK 20/EZ-DR/ 300KONFEK | 2296498 | 1 |
| | 20 | 4 m | FLK 20/EZ-DR/ 400KONFEK | 2296508 | 1 |
| | 20 | 6 m | FLK 20/EZ-DR/ 600KONFEK | 2296511 | 1 |
| | 20 | 8 m | FLK 20/EZ-DR/ 800KONFEK | 2296524 | 1 |
| | 20 | 10 m | FLK 20/EZ-DR/1000KONFEK | 2296537 | 1 |
| | Round cable¹⁾ , with two socket strips | 26 | 0.5 m | FLK 26/EZ-DR/ 50/KONFEK | 2299385 |
| 26 | | 1 m | FLK 26/EZ-DR/ 100/KONFEK | 2299398 | 1 |
| 26 | | 1.5 m | FLK 26/EZ-DR/ 150/KONFEK | 2299408 | 1 |
| 26 | | 2 m | FLK 26/EZ-DR/ 200/KONFEK | 2299411 | 1 |
| 26 | | 3 m | FLK 26/EZ-DR/ 300/KONFEK | 2299424 | 1 |
| 26 | | 4 m | FLK 26/EZ-DR/ 400/KONFEK | 2299437 | 1 |
| 26 | | 6 m | FLK 26/EZ-DR/ 600/KONFEK | 2299440 | 1 |
| 26 | | 8 m | FLK 26/EZ-DR/ 800/KONFEK | 2299453 | 1 |
| 26 | | 10 m | FLK 26/EZ-DR/1000/KONFEK | 2299466 | 1 |
| Round cable¹⁾ , with two socket strips | | 34 | 0.5 m | FLK 34/EZ-DR/ 50/KONFEK | 2299479 |
| | 34 | 1 m | FLK 34/EZ-DR/ 100/KONFEK | 2299482 | 1 |
| | 34 | 1.5 m | FLK 34/EZ-DR/ 150/KONFEK | 2299495 | 1 |
| | 34 | 2 m | FLK 34/EZ-DR/ 200/KONFEK | 2299505 | 1 |
| | 34 | 3 m | FLK 34/EZ-DR/ 300/KONFEK | 2299518 | 1 |
| | 34 | 4 m | FLK 34/EZ-DR/ 400/KONFEK | 2299521 | 1 |
| | 34 | 6 m | FLK 34/EZ-DR/ 600/KONFEK | 2299534 | 1 |
| | 34 | 8 m | FLK 34/EZ-DR/ 800/KONFEK | 2299547 | 1 |
| | 34 | 10 m | FLK 34/EZ-DR/1000/KONFEK | 2299550 | 1 |

System cable with flat-ribbon cable plug-in connector

Standard lengths

Round cable sets are used to connect the PLC front adapters to the corresponding VARIOFACE controller boards.

Plug-in connector strips are fitted on both sides of the cables in accordance with IEC 60603-13/DIN 41651 (1:1 connection).

Special lengths are defined using an order key, refer to page 510.



not shielded



Technical data

| | |
|--|---|
| Max. perm. operating voltage | < 50 V AC / 60 V DC |
| Max. perm. current carrying capacity per path | 1 A |
| Max. conductor resistance | 0.16 Ω/m |
| Ambient temperature (operation) | -20°C ... 50°C |
| Assembly | Insulation displacement, IEC 60352-4/DIN EN 60352-4 |
| Conductor cross section | AWG 26 / 0.14 mm ² |
| Conductor structure: stranded wires / material | 7 / Cu tin-plated |
| Outside diameter | 9.9 mm |
| | 40 -position |

Ordering data

| Description | No. of pos. | Cable length | Type | Order No. | Pcs. / Pkt. |
|--|-------------|--------------|--------------------------|-----------|-------------|
| Round cable ²⁾ , with two socket strips | 40 | 0.5 m | FLK 40/EZ-DR/ 50/KONFEK | 2288985 | 5 |
| | 40 | 1 m | FLK 40/EZ-DR/ 100/KONFEK | 2288998 | 1 |
| | 40 | 1.5 m | FLK 40/EZ-DR/ 150/KONFEK | 2289007 | 1 |
| | 40 | 2 m | FLK 40/EZ-DR/ 200/KONFEK | 2289010 | 1 |
| | 40 | 2.5 m | FLK 40/EZ-DR/ 250/KONFEK | 2289023 | 1 |
| | 40 | 3 m | FLK 40/EZ-DR/ 300/KONFEK | 2289036 | 1 |
| | 40 | 3.5 m | FLK 40/EZ-DR/ 350/KONFEK | 2289049 | 1 |
| | 40 | 4 m | FLK 40/EZ-DR/ 400/KONFEK | 2289052 | 1 |
| | 40 | 6 m | FLK 40/EZ-DR/ 600/KONFEK | 2299589 | 1 |
| | 40 | 8 m | FLK 40/EZ-DR/ 800/KONFEK | 2299592 | 1 |
| | 40 | 10 m | FLK 40/EZ-DR/1000/KONFEK | 2299602 | 1 |

1) Socket strips assembled straight at both ends.



2) Socket strips assembled straight at one end and angled at the other.



System cabling for controllers

VARIOFACE system cabling

System cable with flat-ribbon cable plug-in connector

The FLK 50... types are plugged onto the VARIOFACE front adapters for 32 channels and make it possible to split the channels into 4 x 8 channels. All 8-channel VARIOFACE modules and the PLC-V8 adapters for PLC-INTERFACE can therefore be connected.

In case of shielded cables, a cable end with a ferrule is additionally provided as a shield connection (length: approx. 0.5 m; cable H05V-K 1 mm², black).



Splitting cable unshielded
50 positions on 4 x 14



Splitting cable shielded
50 positions on 4 x 14



| | |
|--|---|
| Max. perm. operating voltage | < 50 V AC / 60 V DC |
| Max. perm. current carrying capacity per path | 1 A |
| Max. conductor resistance | 0.16 Ω/m |
| Ambient temperature (operation) | -20°C ... 50°C |
| Shield | - |
| Assembly | Insulation displacement, IEC 60352-4/DIN EN 60352-4 |
| Conductor cross section | AWG 26 / 0.14 mm ² |
| Conductor structure: stranded wires / material | 7 / Cu tin-plated |
| Number of connectors on the module side | 4 |
| Outside diameter | 6.3 mm |

50 -position

| Technical data | | |
|--|---|--|
| Max. perm. operating voltage | < 50 V AC / 60 V DC | |
| Max. perm. current carrying capacity per path | 1 A | |
| Max. conductor resistance | 0.16 Ω/m | |
| Ambient temperature (operation) | -20°C ... 50°C | |
| Shield | - | |
| Assembly | Insulation displacement, IEC 60352-4/DIN EN 60352-4 | |
| Conductor cross section | AWG 26 / 0.14 mm ² | |
| Conductor structure: stranded wires / material | 7 / Cu tin-plated | |
| Number of connectors on the module side | 4 | |
| Outside diameter | 6.3 mm | |

| Technical data | | |
|--|---|--|
| Max. perm. operating voltage | < 50 V AC / 60 V DC | |
| Max. perm. current carrying capacity per path | 1 A | |
| Max. conductor resistance | 0.16 Ω/m | |
| Ambient temperature (operation) | -20°C ... 50°C | |
| Shield | Tinned copper-braided shield, approx. 85% covering | |
| Assembly | Insulation displacement, IEC 60352-4/DIN EN 60352-4 | |
| Conductor cross section | AWG 26 / 0.14 mm ² | |
| Conductor structure: stranded wires / material | 7 / Cu tin-plated | |
| Number of connectors on the module side | 4 | |
| Outside diameter | 6.3 mm | |

| Description | No. of pos. | Cable length |
|---|-------------|--------------|
| Round cable sets , for connection to the VARIOFACE system cabling, with a 50-pos. socket strip and four 14-pos. socket strips, for splitting max. 32 channels into 4 x 8 channels. | 50 | 0.5 m |
| | 50 | 1 m |
| | 50 | 1.5 m |
| | 50 | 2 m |
| | 50 | 2.5 m |
| | 50 | 3 m |
| | 50 | 4 m |
| | 50 | 6 m |
| | 50 | 8 m |
| | 50 | 10 m |
| Assembled round cables , same as before, however in variable lengths | 50 | |
| Assembled round cables , same as before, however shielded and in variable lengths | 50 | |

| Ordering data | | |
|-------------------------------|-----------|-------------|
| Type | Order No. | Pcs. / Pkt. |
| FLK 50/4X14/EZ-DR/ 50/KONFEK | 2296689 | 1 |
| FLK 50/4X14/EZ-DR/ 100/KONFEK | 2296692 | 1 |
| FLK 50/4X14/EZ-DR/ 150/KONFEK | 2296702 | 1 |
| FLK 50/4X14/EZ-DR/ 200/KONFEK | 2296715 | 1 |
| FLK 50/4X14/EZ-DR/ 250/KONFEK | 2305402 | 1 |
| FLK 50/4X14/EZ-DR/ 300/KONFEK | 2296728 | 1 |
| FLK 50/4X14/EZ-DR/ 400/KONFEK | 2296731 | 1 |
| FLK 50/4X14/EZ-DR/ 600/KONFEK | 2296744 | 1 |
| FLK 50/4X14/EZ-DR/ 800/KONFEK | 2296757 | 1 |
| FLK 50/4X14/EZ-DR/1000/KONFEK | 2296773 | 1 |
| FLK 50-4X14-EZ-DR ... | 2302405 | 1 |

| Ordering data | | |
|-------------------------|-----------|-------------|
| Type | Order No. | Pcs. / Pkt. |
| FLK 50-4X14-EZ-DR-S ... | 2302447 | 1 |

Ordering example for system cable:

– Unshielded splitting cable 12.75 m long

| Quantity | Order No. | Length [m] ¹⁾ |
|----------|-----------|--------------------------|
| 1 | 2302405 | 12.75 |

¹⁾ min. 0.30 m

– Shielded splitting cable 11.00 m long

| Quantity | Order No. | Length [m] ¹⁾ |
|----------|-----------|--------------------------|
| 1 | 2302447 | 11.00 |

¹⁾ min. 0.30 m

System cabling for controllers

VARIOFACE system cabling

System cable with flat-ribbon cable plug-in connector

Special lengths

Pre-assembled **round cables** for connecting, e.g., PLC front adapters to the corresponding VARIOFACE termination boards. The cables are assembled with plug-in connector strips at both ends according to IEC 60603-13/DIN 41651. For shielded cables, a cable end with ferrule is available additionally as a shielded connection (length: approx. 0.5 m; cable: H05V-K 1 mm², black).

The order key for special lengths is described using three features.

The order of the features is as follows:

- Cable type
- Assembly
- Length in meters

There are two order keys, one for unshielded round cables, FLK EZ-DR/.../.../..., and one

for shielded round cables, FLK EZ-DR-S/.../.../.... To ensure clear specification when ordering, the features are described in detail below:

Cable type

- This specifies the number of individual cables within the specific cable.

Assembly

- None, the cable is not assembled at either end;
- 10-pos. socket strip at both ends, the cable is assembled with 10-pos. plug-in connectors at both ends (1:1 connection);
- 14-pos. socket strip at both ends, the cable is assembled with 14-pos. plug-in connectors at both ends

- (1:1 connection); and so on up to
- 50-pos. socket strip at both ends, the cable is assembled with 50-pos. plug-in connectors at both ends (1:1 connection);
- 14-pos. socket strip at one end, 16-pos. socket strip at one end, the cable is assembled with a 14-pos. plug-in connector at one end and a 16-pos. plug-in connector at the other end (for SIMATIC S7; no 1:1 connection).

Features of permissible assemblies:

| Cable type \ Assembly | Unshielded round cables FLK EZ-DR/.../.../... | | | | | | | Shielded round cables FLK EZ-DR-S/.../.../.... | | | | |
|---|--|---------------------------|---------------------------|---------------------------|---------------------------|---------------------------|---------------------------|---|---------------------------|---------------------------|---------------------------|---------------------------|
| | 10-pos. | 14-pos. | 16-pos. | 20-pos. | 26-pos. | 34-pos. | 40-pos. | 50-pos. | 14-pos. | 16-pos. | 40-pos. | 50-pos. |
| No assembly | 10U/C00/... | 14U/C00/... | 16U/C00/... | 20U/C00/... | 26U/C00/... | 34U/C00/... | 40U/C00/... | 50U/C00/... | 14S/C00/... | 16S/C00/... | 40S/C00/... | 50S/C00/... |
| 10-pos. socket strip at both ends | 10U/C55/... ¹⁾ | | | | | | | | | | | |
| 14-pos. socket strip at both ends | | 14U/C23/... ¹⁾ | | | | | | | 14S/C23/... ¹⁾ | | | |
| 16-pos. socket strip at both ends | | | 16U/C58/... ¹⁾ | | | | | | | 16S/C58/... ¹⁾ | | |
| 20-pos. socket strip at both ends | | | | 20U/C61/... ¹⁾ | | | | | | | | |
| 26-pos. socket strip at both ends | | | | | 26U/C63/... ¹⁾ | | | | | | | |
| 34-pos. socket strip at both ends | | | | | | 34U/C65/... ¹⁾ | | | | | | |
| 40-pos. socket strip at both ends | | | | | | | 40U/C30/... ²⁾ | | | | 40S/C30/... ²⁾ | |
| 50-pos. socket strip at both ends | | | | | | | | 50U/C38/... ²⁾ | | | | 50S/C38/... ²⁾ |
| 14-pos. socket strip at one end; 16-pos. socket strip at one end | | 14U/C52/... ¹⁾ | | | | | | | 14S/C52/... ¹⁾ | | | |

¹⁾ Socket strips assembled straight at both ends.

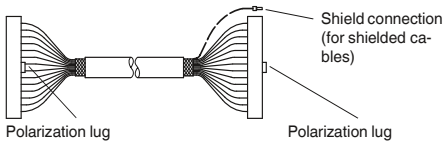

²⁾ Socket strips assembled straight at one end and angled at the other.

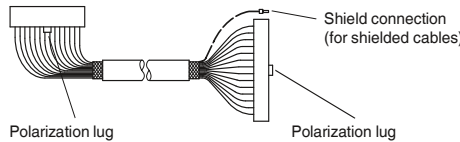

³⁾ Socket strips assembled straight at one end and angled at the other.

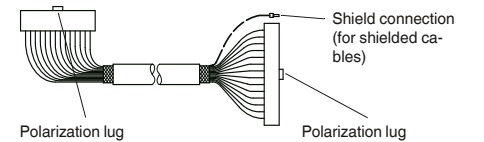

Ordering example for unshielded round cable:

- Unshielded 50-pos. round cable, assembled with two 50-pos. socket strips, 11.5 m long

| Quantity | Order No. | Cable type | Assembly | Length [m] ⁴⁾ |
|----------|-----------|---|---|------------------------------------|
| 1 | 2295059 | 50U 10U ≙ 10-pos. unshielded 14U ≙ 14-pos. unshielded 16U ≙ 16-pos. unshielded 20U ≙ 20-pos. unshielded 26U ≙ 26-pos. unshielded 34U ≙ 34-pos. unshielded 40U ≙ 40-pos. unshielded 50U ≙ 50-pos. unshielded | C38 C00 ≙ No assembly C55 ≙ 10-pos. socket strip at both ends C23 ≙ 14-pos. socket strip at both ends C52 ≙ 14-pos. socket strip at one end, 16-pos. socket strip at the other (for S7) C58 ≙ 16-pos. socket strip at both ends C61 ≙ 20-pos. socket strip at both ends C63 ≙ 26-pos. socket strip at both ends C65 ≙ 34-pos. socket strip at both ends C30 ≙ 40-pos. socket strip at both ends C38 ≙ 50-pos. socket strip at both ends | 11.50 ⁴⁾ Min. 0.20 m |

Ordering example for shielded round cable:

- Shielded 14-pos. round cable, assembled with two 14-pos. socket strips, 12.75 m long

| Quantity | Order No. | Cable type | Assembly | Length [m] ⁴⁾ |
|----------|-----------|---|---|------------------------------------|
| 1 | 2295046 | 14S 14S ≙ 14-pos. shielded 16S ≙ 16-pos. shielded 40S ≙ 40-pos. shielded 50S ≙ 50-pos. shielded | C23 C00 ≙ No assembly C23 ≙ 14-pos. socket strip at both ends C52 ≙ 14-pos. socket strip at one end, 16-pos. socket strip at the other (for S7) C58 ≙ 16-pos. socket strip at both ends C30 ≙ 40-pos. socket strip at both ends C38 ≙ 50-pos. socket strip at both ends | 12.75 ⁴⁾ Min. 0.20 m |



not shielded



shielded



Max. perm. operating voltage
 Max. perm. current carrying capacity per path
 Max. conductor resistance
 Ambient temperature (operation)
 Shield

Conductor cross section
 Conductor structure: stranded wires / material

Technical data

< 50 V AC / 60 V DC
 1 A
 0.16 Ω/m
 -20°C ... 50°C
 -

AWG 26 / 0.14 mm²
 7 / Cu tin-plated

Technical data

< 50 V AC / 60 V DC
 1 A
 0.16 Ω/m
 -20°C ... 50°C
 Tinned copper-braided shield, approx. 85% covering

AWG 26 / 0.14 mm²
 7 / Cu tin-plated

Ordering data

| Type | Order No. | Pcs. / Pkt. |
|----------------------|-----------|-------------|
| FLK EZ-DR.../.../... | 2295059 | 1 |

Ordering data

| Type | Order No. | Pcs. / Pkt. |
|------------------------|-----------|-------------|
| FLK EZ-DR-S.../.../... | 2295046 | 1 |

| Description | No. of pos. | Cable length |
|--|-------------|--------------|
| Unshielded round cables, as above, but in variable lengths of type "FLK EZ-DR/14U/C52/..." | | |

System cabling for controllers

VARIOFACE system cabling

System cable with D-SUB socket and pin strip

Standard lengths

Shielded round cable sets to connect the control level with the corresponding VARIOFACE interface modules.

Assembly with D-SUB strips as per IEC 60807-2/DIN 41652, (1:1 connection).

- D-SUB socket strip on one side and D-SUB pin strip on the other
- D-SUB sockets on both sides
- D-SUB pin strips on both sides
- Cable exit: straight
- Screw connection: 2 UNC 4-40 screws.

Special lengths and assembly versions are defined using an order key, refer to page 514.



Socket at one end and pin strip at the other



Technical data

| | | |
|---|--|---------|
| Max. perm. operating voltage | 125 V AC/DC | |
| Max. perm. current carrying capacity per path | 2 A | |
| Max. conductor resistance | 0.09 Ω/m | |
| Ambient temperature (operation) | -20°C ... 50°C | |
| Shield | Tinned copper-braided shield, approx. 85% covering | |
| Insertion/withdrawal cycles | > 200 | |
| Conductor cross section | AWG 24 / 0.25 mm ² | |
| Outside diameter | | |
| | 9 -position | 7.5 mm |
| | 15 -position | 9 mm |
| | 25 -position | 10.5 mm |
| | 37 -position | 12.5 mm |
| | 50 -position | 13.5 mm |

Ordering data

| Description | No. of pos. | Cable length | Type | Order No. | Pcs. / Pkt. |
|--|-------------|--------------|-------------------------------|-----------|-------------|
| Shielded round cable , fitted with two D-SUB strips, various numbers of positions and lengths | | | | | |
| | 9 | 0.5 m | CABLE-D 9SUB/B/S/ 50/KONFEK/S | 2299987 | 1 |
| | 9 | 1 m | CABLE-D 9SUB/B/S/100/KONFEK/S | 2299990 | 1 |
| | 9 | 1.5 m | CABLE-D 9SUB/B/S/150/KONFEK/S | 2300009 | 1 |
| | 9 | 2 m | CABLE-D 9SUB/B/S/200/KONFEK/S | 2302010 | 1 |
| | 9 | 3 m | CABLE-D 9SUB/B/S/300/KONFEK/S | 2302023 | 1 |
| | 9 | 4 m | CABLE-D 9SUB/B/S/400/KONFEK/S | 2302036 | 1 |
| | 9 | 6 m | CABLE-D 9SUB/B/S/600/KONFEK/S | 2302049 | 1 |
| | 15 | 0.5 m | CABLE-D15SUB/B/S/ 50/KONFEK/S | 2302052 | 1 |
| | 15 | 1 m | CABLE-D15SUB/B/S/100/KONFEK/S | 2302065 | 1 |
| | 15 | 1.5 m | CABLE-D15SUB/B/S/150/KONFEK/S | 2302078 | 1 |
| | 15 | 2 m | CABLE-D15SUB/B/S/200/KONFEK/S | 2302081 | 1 |
| | 15 | 3 m | CABLE-D15SUB/B/S/300/KONFEK/S | 2302094 | 1 |
| | 15 | 4 m | CABLE-D15SUB/B/S/400/KONFEK/S | 2302104 | 1 |
| | 15 | 6 m | CABLE-D15SUB/B/S/600/KONFEK/S | 2302117 | 1 |
| | 25 | 0.5 m | CABLE-D25SUB/B/S/ 50/KONFEK/S | 2302120 | 1 |
| | 25 | 1 m | CABLE-D25SUB/B/S/100/KONFEK/S | 2302133 | 1 |
| | 25 | 1.5 m | CABLE-D25SUB/B/S/150/KONFEK/S | 2302146 | 1 |
| | 25 | 2 m | CABLE-D25SUB/B/S/200/KONFEK/S | 2302159 | 1 |
| | 25 | 3 m | CABLE-D25SUB/B/S/300/KONFEK/S | 2302162 | 1 |
| | 25 | 4 m | CABLE-D25SUB/B/S/400/KONFEK/S | 2302175 | 1 |
| | 25 | 6 m | CABLE-D25SUB/B/S/600/KONFEK/S | 2302188 | 1 |
| | 37 | 0.5 m | CABLE-D37SUB/B/S/ 50/KONFEK/S | 2302191 | 1 |
| | 37 | 1 m | CABLE-D37SUB/B/S/100/KONFEK/S | 2302201 | 1 |
| | 37 | 1.5 m | CABLE-D37SUB/B/S/150/KONFEK/S | 2302214 | 1 |
| | 37 | 2 m | CABLE-D37SUB/B/S/200/KONFEK/S | 2302227 | 1 |
| | 37 | 3 m | CABLE-D37SUB/B/S/300/KONFEK/S | 2302230 | 1 |
| | 37 | 4 m | CABLE-D37SUB/B/S/400/KONFEK/S | 2302243 | 1 |
| | 37 | 6 m | CABLE-D37SUB/B/S/600/KONFEK/S | 2302256 | 1 |
| | 37 | 8 m | | | |
| | 37 | 10 m | | | |
| | 37 | 15 m | | | |
| | 37 | 20 m | | | |
| | 50 | 0.5 m | CABLE-D50SUB/B/S/ 50/KONFEK/S | 2302269 | 1 |
| | 50 | 1 m | CABLE-D50SUB/B/S/100/KONFEK/S | 2302272 | 1 |
| | 50 | 1.5 m | CABLE-D50SUB/B/S/150/KONFEK/S | 2302285 | 1 |
| | 50 | 2 m | CABLE-D50SUB/B/S/200/KONFEK/S | 2302298 | 1 |
| | 50 | 3 m | CABLE-D50SUB/B/S/300/KONFEK/S | 2302308 | 1 |
| | 50 | 4 m | CABLE-D50SUB/B/S/400/KONFEK/S | 2302311 | 1 |
| | 50 | 6 m | CABLE-D50SUB/B/S/600/KONFEK/S | 2302324 | 1 |

Color code of the system cables
CABLE-D...SUB/...



Socket strip at both ends



Pin strip at both ends



Technical data

125 V AC/DC
2 A
0.09 Ω/m
-20°C ... 50°C
Tinned copper-braided shield, approx. 85% covering

> 200
AWG 24 / 0.25 mm²

7.5 mm
9 mm
10.5 mm
12 mm
13.5 mm

Ordering data



Technical data

125 V AC/DC
2 A
0.09 Ω/m
-20°C ... 50°C
Tinned copper-braided shield, approx. 85% covering

> 200
AWG 24 / 0.25 mm²

7.5 mm
9 mm
10.5 mm
12 mm
13.5 mm

Ordering data

| No. of wires | PIN | Wire color |
|--------------|-----|--------------------|
| | 1 | white |
| | 2 | brown |
| | 3 | green |
| | 4 | yellow |
| | 5 | gray |
| | 6 | pink |
| | 7 | blue |
| | 8 | red |
| 9-pos. | 9 | black |
| | 10 | violet |
| | 11 | gray-pink |
| | 12 | red-blue |
| | 13 | white-green |
| | 14 | brown-green |
| 15-pos. | 15 | white-yellow |
| | 16 | yellow-brown |
| | 17 | white-gray |
| | 18 | gray-brown |
| | 19 | white-pink |
| | 20 | pink-brown |
| | 21 | white-blue |
| | 22 | brown-blue |
| | 23 | white-red |
| | 24 | brown-red |
| 25-pos. | 25 | white-black |
| | 26 | brown-black |
| | 27 | gray-green |
| | 28 | yellow-gray |
| | 29 | pink-green |
| | 30 | yellow-pink |
| | 31 | green-blue |
| | 32 | yellow-blue |
| | 33 | green-red |
| | 34 | yellow-red |
| | 35 | green-black |
| | 36 | yellow-black |
| 37-pos. | 37 | gray-blue |
| | 38 | pink-blue |
| | 39 | gray-red |
| | 40 | pink-red |
| | 41 | gray-black |
| | 42 | pink-black |
| | 43 | blue-black |
| | 44 | red-black |
| | 45 | white-brown-black |
| | 46 | yellow-green-black |
| | 47 | gray-pink-black |
| | 48 | blue-red-black |
| | 49 | white-green-black |
| 50-pos. | 50 | green-brown-black |

| Type | Order No. | Pcs. / Pkt. | Type | Order No. | Pcs. / Pkt. |
|--------------------------------|-----------|-------------|-------------------------------|-----------|-------------|
| CABLE-D 9SUB/B/B/100/KONFEK/S | 2305415 | 1 | CABLE-D 9SUB/S/S/100/KONFEK/S | 2305570 | 1 |
| CABLE-D 9SUB/B/B/200/KONFEK/S | 2305428 | 1 | CABLE-D 9SUB/S/S/200/KONFEK/S | 2305583 | 1 |
| CABLE-D 9SUB/B/B/300/KONFEK/S | 2305431 | 1 | CABLE-D 9SUB/S/S/300/KONFEK/S | 2305596 | 1 |
| CABLE-D15SUB/B/B/100/KONFEK/S | 2305444 | 1 | CABLE-D15SUB/S/S/100/KONFEK/S | 2305606 | 1 |
| CABLE-D15SUB/B/B/200/KONFEK/S | 2305457 | 1 | CABLE-D15SUB/S/S/200/KONFEK/S | 2305619 | 1 |
| CABLE-D15SUB/B/B/300/KONFEK/S | 2305460 | 1 | CABLE-D15SUB/S/S/300/KONFEK/S | 2305622 | 1 |
| CABLE-D25SUB/B/B/100/KONFEK/S | 2305473 | 1 | CABLE-D25SUB/S/S/100/KONFEK/S | 2305635 | 1 |
| CABLE-D25SUB/B/B/200/KONFEK/S | 2305486 | 1 | CABLE-D25SUB/S/S/200/KONFEK/S | 2305648 | 1 |
| CABLE-D25SUB/B/B/300/KONFEK/S | 2305499 | 1 | CABLE-D25SUB/S/S/300/KONFEK/S | 2305651 | 1 |
| CABLE-D37SUB/B/B/ 100/KONFEK/S | 2305509 | 1 | CABLE-D37SUB/S/S/100/KONFEK/S | 2305664 | 1 |
| CABLE-D37SUB/B/B/ 200/KONFEK/S | 2305512 | 1 | CABLE-D37SUB/S/S/200/KONFEK/S | 2305677 | 1 |
| CABLE-D37SUB/B/B/ 300/KONFEK/S | 2305525 | 1 | CABLE-D37SUB/S/S/300/KONFEK/S | 2305680 | 1 |
| CABLE-D37SUB/B/B/ 400/KONFEK/S | 2900759 | 1 | | | |
| CABLE-D37SUB/B/B/ 600/KONFEK/S | 2900760 | 1 | | | |
| CABLE-D37SUB/B/B/ 800/KONFEK/S | 2900761 | 1 | | | |
| CABLE-D37SUB/B/B/1000/KONFEK/S | 2900762 | 1 | | | |
| CABLE-D37SUB/B/B/1500/KONFEK/S | 2900763 | 1 | | | |
| CABLE-D37SUB/B/B/2000/KONFEK/S | 2900764 | 1 | | | |
| CABLE-D50SUB/B/B/100/KONFEK/S | 2305541 | 1 | CABLE-D50SUB/S/S/100/KONFEK/S | 2305693 | 1 |
| CABLE-D50SUB/B/B/200/KONFEK/S | 2305554 | 1 | CABLE-D50SUB/S/S/200/KONFEK/S | 2305703 | 1 |
| CABLE-D50SUB/B/B/300/KONFEK/S | 2305567 | 1 | CABLE-D50SUB/S/S/300/KONFEK/S | 2305716 | 1 |

System cabling for controllers

VARIOFACE system cabling

System cable with D-SUB sockets and pin strip

Special lengths

Pre-assembled shielded **round cables** for connecting VARIOFACE termination boards. The cables are assembled with D-SUB strips in accordance with IEC 60807-2/DIN 41652.

The order key is defined by three features.

The features in the appropriate sequence are:

- Cable type
- Assembly
- Length in meters

There are three assembly variants of the shielded round cable:

- CABLE D-SUB-S/.../.../... D-SUB socket strip on one end and D-SUB pin strip on the other
- CABLE D-SUB-B-B-S/.../.../... D-SUB

socket strip at both ends
 - CABLE D-SUB-S-S-S/.../.../... D-SUB pin strip at both ends
 The features necessary for clear identification of an order are described below:

Cable type

- The number of individual cables within the cable is defined here.

Assembly

- (example for CABLE D-SUB-S/.../.../...)
- None, the cable is not assembled at either end
- 9-pos. D-SUB socket strip at one end 9-pos. D-SUB pin strip at one end the cable connects (1:1) a 9-pos. D-SUB socket and pin strip

- 15-pos. D-SUB socket strip at one end 15-pos. D-SUB pin strip at one end the cable connects (1:1) a 15-pos. D-SUB socket and pin strip; or up to
- 50-pos. D-SUB socket strip at one end 50-pos. D-SUB pin strip at one end the cable connects (1:1) a 50-pos. D-SUB socket and pin strip.

Sample order for round cable set assembled with pin strip on one side and socket strip on one side

- unshielded 25-pos. round cable set, assembled with one 25-pos. D-SUB socket strip and one 25-pos. D-SUB pin strip, 11.5 mm long

| Quantity | Order No. | Cable type | Assembly | Length [m] ¹⁾ |
|----------|-----------|--|--|------------------------------------|
| 1 | 2302340 | 25S 09S ≙ 9-pos. shielded 15S ≙ 15-pos. shielded 25S ≙ 25-pos. shielded 37S ≙ 37-pos. shielded 50S ≙ 50-pos. shielded | C36 C00 ≙ no assembly C01 ≙ 9-pos. D-SUB socket strip at one end 9-pos. D-SUB pin strip at one end C28 ≙ 15-pos. D-SUB socket strip at one end 15-pos. D-SUB pin strip at one end C36 ≙ 25-pos. D-SUB socket strip at one end 25-pos. D-SUB pin strip at one end C43 ≙ 37-pos. D-SUB socket strip at one end 37-pos. D-SUB pin strip at one end C49 ≙ 50-pos. D-SUB socket strip at one end 50-pos. D-SUB pin strip at one end | 11.50 ¹⁾ min. 0.20 m |

Sample order for round cable set assembled with socket strip at both ends

- Shielded 37-pos. round cable, assembled with two 37-pos. D-SUB socket strips, 12.75 m long

| Quantity | Order No. | Cable type | Assembly | Length [m] ¹⁾ |
|----------|-----------|--|--|------------------------------------|
| 1 | 2302421 | 37S 09S ≙ 9-pos. shielded 15S ≙ 15-pos. shielded 25S ≙ 25-pos. shielded 37S ≙ 37-pos. shielded 50S ≙ 50-pos. shielded | C44 C00 ≙ no assembly C22 ≙ 9-pos. D-SUB socket strip at both ends C29 ≙ 15-pos. D-SUB socket strip at both ends C37 ≙ 25-pos. D-SUB socket strip at both ends C44 ≙ 37-pos. D-SUB socket strip at both ends C50 ≙ 50-pos. D-SUB socket strip at both ends | 12.75 ¹⁾ min. 0.20 m |

Sample order for round cable set assembled with pin strip at both ends

- Shielded 15-pos. round cable, assembled with two 15-pos. D-SUB pin strips, 8.5 m long

| Quantity | Order No. | Cable type | Assembly | Length [m] ¹⁾ |
|----------|-----------|--|---|-----------------------------------|
| 1 | 2302434 | 15S 09S ≙ 9-pos. shielded 15S ≙ 15-pos. shielded 25S ≙ 25-pos. shielded 37S ≙ 37-pos. shielded 50S ≙ 50-pos. shielded | C71 C00 ≙ no assembly C70 ≙ 9-pos. D-SUB pin strip at both ends C71 ≙ 15-pos. D-SUB pin strip at both ends C72 ≙ 25-pos. D-SUB pin strip at both ends C73 ≙ 37-pos. D-SUB pin strip at both ends C74 ≙ 50-pos. D-SUB pin strip at both ends | 8.50 ¹⁾ min. 0.20 m |



Shielded



Technical data

| | |
|---|--|
| Max. perm. operating voltage | 125 V AC/DC |
| Max. perm. current carrying capacity per path | 2 A |
| Max. conductor resistance | 0.09 Ω/m |
| Ambient temperature (operation) | -20°C ... 50°C |
| Shield | Tinned copper-braided shield, approx. 85% covering |
| Insertion/withdrawal cycles | > 200 |
| Conductor cross section | AWG 24 / 0.25 mm ² |

Ordering data

| Description | No. of pos. | Cable length | Type | Order No. | Pcs. / Pkt. |
|--|-------------|--------------|-------------------------------|-----------|-------------|
| Assembled round cables, in variable lengths, pin strip on one side and socket strip on one side | | | CABLE D-SUB-S/.../.../... | 2302340 | 1 |
| Assembled round cables, in variable lengths, socket strip on both sides | | | CABLE D-SUB-B-B-S/.../.../... | 2302421 | 1 |
| Assembled round cables, in variable lengths, pin strip on both sides | | | CABLE D-SUB-S-S-S/.../.../... | 2302434 | 1 |

System cabling for controllers

VARIOFACE system cabling

System cable with D-SUB socket or pin strip and one open end

- 1:1 connection
- D-SUB socket or pin strip at one end
- Connector according to IEC 60807-2/DIN 41652
- Gland: 2 UNC 4-40 screws
- Open end at the other end
- Individual wire marking: 1, 2, 3, 4, etc.
- Individual wires fitted with ferrules
- Shield connection: H05V-K 1 mm² cable, black, 0.5 m in length



Socket strip at one end and open end at the other end



Pin strip at one end and open end at the other end

| | | | Technical data | | | Technical data | | |
|--|--------------|--------------|--|-----------|-------------|--|-----------|-------------|
| Max. perm. operating voltage | | | 125 V AC/DC | | | 125 V AC/DC | | |
| Max. perm. current carrying capacity per path | | | 2 A | | | 2 A | | |
| Max. conductor resistance | | | 0.09 Ω/m | | | 0.09 Ω/m | | |
| Ambient temperature (operation) | | | -20°C ... 50°C | | | -20°C ... 50°C | | |
| Shield | | | Tinned copper-braided shield, approx. 85% covering | | | Tinned copper-braided shield, approx. 85% covering | | |
| Insertion/withdrawal cycles | | | > 200 | | | > 200 | | |
| Conductor cross section | | | AWG 24 / 0.25 mm ² | | | AWG 24 / 0.25 mm ² | | |
| Outside diameter | | | | | | | | |
| | 9 -position | 7.5 mm | | | | 7.5 mm | | |
| | 15 -position | 9 mm | | | | 9 mm | | |
| | 25 -position | 10.5 mm | | | | 10.5 mm | | |
| | | | Ordering data | | | Ordering data | | |
| Description | No. of pos. | Cable length | Type | Order No. | Pcs. / Pkt. | Type | Order No. | Pcs. / Pkt. |
| Round cable with an open end | 9 | 0.5 m | CABLE-D- 9SUB/F/OE/0,25/S/0,5M | 2926014 | 1 | CABLE-D- 9SUB/M/OE/0,25/S/0,5M | 2926360 | 1 |
| | 9 | 1 m | CABLE-D- 9SUB/F/OE/0,25/S/1,0M | 2926027 | 1 | CABLE-D- 9SUB/M/OE/0,25/S/1,0M | 2926373 | 1 |
| | 9 | 1.5 m | CABLE-D- 9SUB/F/OE/0,25/S/1,5M | 2926030 | 1 | CABLE-D- 9SUB/M/OE/0,25/S/1,5M | 2926386 | 1 |
| | 9 | 2 m | CABLE-D- 9SUB/F/OE/0,25/S/2,0M | 2926043 | 1 | CABLE-D- 9SUB/M/OE/0,25/S/2,0M | 2926399 | 1 |
| | 9 | 3 m | CABLE-D- 9SUB/F/OE/0,25/S/3,0M | 2926056 | 1 | CABLE-D- 9SUB/M/OE/0,25/S/3,0M | 2926409 | 1 |
| | 9 | 4 m | CABLE-D- 9SUB/F/OE/0,25/S/4,0M | 2926069 | 1 | CABLE-D- 9SUB/M/OE/0,25/S/4,0M | 2926412 | 1 |
| | 9 | 6 m | CABLE-D- 9SUB/F/OE/0,25/S/6,0M | 2926072 | 1 | CABLE-D- 9SUB/M/OE/0,25/S/6,0M | 2926425 | 1 |
| Round cable, same as before, however in variable lengths | 9 | | CABLE-D- 9SUB-F-OE-0,25-S/... | 2900903 | 1 | CABLE-D- 9SUB-M-OE-0,25-S/... | 2900909 | 1 |
| Round cable with an open end | 15 | 0.5 m | CABLE-D-15SUB/F/OE/0,25/S/0,5M | 2926085 | 1 | CABLE-D-15SUB/M/OE/0,25/S/0,5M | 2926438 | 1 |
| | 15 | 1 m | CABLE-D-15SUB/F/OE/0,25/S/1,0M | 2926098 | 1 | CABLE-D-15SUB/M/OE/0,25/S/1,0M | 2926441 | 1 |
| | 15 | 1.5 m | CABLE-D-15SUB/F/OE/0,25/S/1,5M | 2926108 | 1 | CABLE-D-15SUB/M/OE/0,25/S/1,5M | 2926454 | 1 |
| | 15 | 2 m | CABLE-D-15SUB/F/OE/0,25/S/2,0M | 2926111 | 1 | CABLE-D-15SUB/M/OE/0,25/S/2,0M | 2926467 | 1 |
| | 15 | 3 m | CABLE-D-15SUB/F/OE/0,25/S/3,0M | 2926124 | 1 | CABLE-D-15SUB/M/OE/0,25/S/3,0M | 2926470 | 1 |
| | 15 | 4 m | CABLE-D-15SUB/F/OE/0,25/S/4,0M | 2926137 | 1 | CABLE-D-15SUB/M/OE/0,25/S/4,0M | 2926483 | 1 |
| | 15 | 6 m | CABLE-D-15SUB/F/OE/0,25/S/6,0M | 2926140 | 1 | CABLE-D-15SUB/M/OE/0,25/S/6,0M | 2926496 | 1 |
| Round cable, same as before, however in variable lengths | 15 | | CABLE-D-15SUB-F-OE-0,25-S/... | 2900905 | 1 | CABLE-D-15SUB-M-OE-0,25-S/... | 2900910 | 1 |
| Round cable with an open end | 25 | 0.5 m | CABLE-D-25SUB/F/OE/0,25/S/0,5M | 2926153 | 1 | CABLE-D-25SUB/M/OE/0,25/S/0,5M | 2926506 | 1 |
| | 25 | 1 m | CABLE-D-25SUB/F/OE/0,25/S/1,0M | 2926166 | 1 | CABLE-D-25SUB/M/OE/0,25/S/1,0M | 2926519 | 1 |
| | 25 | 1.5 m | CABLE-D-25SUB/F/OE/0,25/S/1,5M | 2926179 | 1 | CABLE-D-25SUB/M/OE/0,25/S/1,5M | 2926522 | 1 |
| | 25 | 2 m | CABLE-D-25SUB/F/OE/0,25/S/2,0M | 2926182 | 1 | CABLE-D-25SUB/M/OE/0,25/S/2,0M | 2926535 | 1 |
| | 25 | 3 m | CABLE-D-25SUB/F/OE/0,25/S/3,0M | 2926195 | 1 | CABLE-D-25SUB/M/OE/0,25/S/3,0M | 2926548 | 1 |
| | 25 | 4 m | CABLE-D-25SUB/F/OE/0,25/S/4,0M | 2926205 | 1 | CABLE-D-25SUB/M/OE/0,25/S/4,0M | 2926551 | 1 |
| | 25 | 6 m | CABLE-D-25SUB/F/OE/0,25/S/6,0M | 2926218 | 1 | CABLE-D-25SUB/M/OE/0,25/S/6,0M | 2926564 | 1 |
| Round cable, same as before, however in variable lengths | 25 | | CABLE-D-25SUB-F-OE-0,25-S/... | 2900906 | 1 | CABLE-D-25SUB-M-OE-0,25-S/... | 2900911 | 1 |

Special lengths of D-SUB cable with open ends can be configured using separate order numbers.

Ordering example:

One system cable assembled with a 37-pos. D-SUB socket strip and one open end, 12.75 m in length:

1 pcs. 2900907/12,75



Socket strip at one end and open end at the other end



Pin strip at one end and open end at the other end

| | | | Technical data | | | Technical data | | |
|--|--------------|--------------|--|-----------|-------------|--|-----------|-------------|
| Max. perm. operating voltage | | | 125 V AC/DC | | | 125 V AC/DC | | |
| Max. perm. current carrying capacity per path | | | 2 A | | | 2 A | | |
| Max. conductor resistance | | | 0.09 Ω/m | | | 0.09 Ω/m | | |
| Ambient temperature (operation) | | | -20°C ... 50°C | | | -20°C ... 50°C | | |
| Shield | | | Tinned copper-braided shield, approx. 85% covering | | | Tinned copper-braided shield, approx. 85% covering | | |
| Insertion/withdrawal cycles | | | > 200 | | | > 200 | | |
| Conductor cross section | | | AWG 24 / 0.25 mm ² | | | AWG 24 / 0.25 mm ² | | |
| Outside diameter | | | | | | | | |
| | 37 -position | | 12 mm | | | 12 mm | | |
| | 50 -position | | 13.5 mm | | | 13.5 mm | | |
| | | | Ordering data | | | Ordering data | | |
| Description | No. of pos. | Cable length | Type | Order No. | Pcs. / Pkt. | Type | Order No. | Pcs. / Pkt. |
| Round cable with an open end | 37 | 0.5 m | CABLE-D-37SUB/F/OE/0,25/S/0,5M | 2926221 | 1 | CABLE-D-37SUB/M/OE/0,25/S/0,5M | 2926577 | 1 |
| | 37 | 1 m | CABLE-D-37SUB/F/OE/0,25/S/1,0M | 2926234 | 1 | CABLE-D-37SUB/M/OE/0,25/S/1,0M | 2926580 | 1 |
| | 37 | 1.5 m | CABLE-D-37SUB/F/OE/0,25/S/1,5M | 2926247 | 1 | CABLE-D-37SUB/M/OE/0,25/S/1,5M | 2926593 | 1 |
| | 37 | 2 m | CABLE-D-37SUB/F/OE/0,25/S/2,0M | 2926250 | 1 | CABLE-D-37SUB/M/OE/0,25/S/2,0M | 2926603 | 1 |
| | 37 | 3 m | CABLE-D-37SUB/F/OE/0,25/S/3,0M | 2926263 | 1 | CABLE-D-37SUB/M/OE/0,25/S/3,0M | 2926616 | 1 |
| | 37 | 4 m | CABLE-D-37SUB/F/OE/0,25/S/4,0M | 2926276 | 1 | CABLE-D-37SUB/M/OE/0,25/S/4,0M | 2926629 | 1 |
| | 37 | 6 m | CABLE-D-37SUB/F/OE/0,25/S/6,0M | 2926289 | 1 | CABLE-D-37SUB/M/OE/0,25/S/6,0M | 2926632 | 1 |
| Round cable, same as before, however in variable lengths | 37 | | CABLE-D-37SUB-F-OE-0,25-S/... | 2900907 | 1 | CABLE-D-37SUB-M-OE-0,25-S/... | 2900912 | 1 |
| Round cable with an open end | 50 | 0.5 m | CABLE-D-50SUB/F/OE/0,25/S/0,5M | 2926292 | 1 | CABLE-D-50SUB/M/OE/0,25/S/0,5M | 2926645 | 1 |
| | 50 | 1 m | CABLE-D-50SUB/F/OE/0,25/S/1,0M | 2926302 | 1 | CABLE-D-50SUB/M/OE/0,25/S/1,0M | 2926658 | 1 |
| | 50 | 1.5 m | CABLE-D-50SUB/F/OE/0,25/S/1,5M | 2926315 | 1 | CABLE-D-50SUB/M/OE/0,25/S/1,5M | 2926661 | 1 |
| | 50 | 2 m | CABLE-D-50SUB/F/OE/0,25/S/2,0M | 2926328 | 1 | CABLE-D-50SUB/M/OE/0,25/S/2,0M | 2926674 | 1 |
| | 50 | 3 m | CABLE-D-50SUB/F/OE/0,25/S/3,0M | 2926331 | 1 | CABLE-D-50SUB/M/OE/0,25/S/3,0M | 2926687 | 1 |
| | 50 | 4 m | CABLE-D-50SUB/F/OE/0,25/S/4,0M | 2926344 | 1 | CABLE-D-50SUB/M/OE/0,25/S/4,0M | 2926690 | 1 |
| | 50 | 6 m | CABLE-D-50SUB/F/OE/0,25/S/6,0M | 2926357 | 1 | CABLE-D-50SUB/M/OE/0,25/S/6,0M | 2926700 | 1 |
| Round cable, same as before, however in variable lengths | 50 | | CABLE-D-50SUB-F-OE-0,25-S/... | 2900908 | 1 | CABLE-D-50SUB-M-OE-0,25-S/... | 2900913 | 1 |

VARIOFACE system cabling

N

System cable with a 56-pos. ELCO/EDAC plug-in connector and an open end

Assembled system cable for connecting 56-pos. EDAC plug-in connectors from the 516 series or ELCO plug-in connectors from the 8016 series.

- Single-sided 516 series EDAC socket plug-in connectors
- Metal housing with lateral cable outlet
- Coding sockets in location 1 by default
- Open end at the other end
- Single wire marking: 1, 2, 3, ... 53, 54, Y, Z (see pin assignment)
- Shield connection on both sides: H05V-K 1 mm² cable, black, length: 0.5 m



56-pos. system cable

| Notes: |
|--|
| The system cables are designed specifically for the UMK-EC56/56-XOR (2975900) and UMK-EC56/56-XOL (2975890) modules. |
| When using the UMK-EC56/FRONT 2,5V/R (2976161) or UMK-EC56/FRONT 2,5V/L (2976158) modules, the coding sockets must be adapted accordingly. |
| Observe the module and system cable layouts. |

Max. perm. operating voltage
 Max. perm. current carrying capacity per path
 Max. conductor resistance
 Ambient temperature (operation)
 Shield

Technical data

25 V AC / 60 V DC
 1.5 A
 0.056 Ω/m
 -20°C ... 60°C
 Tinned copper-braided shield, approx. 85% covering

Conductor cross section
 Conductor structure: stranded wires / material

AWG 22 / 0.34 mm²
 19 / Cu uninsulated

Ordering data

| Description | No. of pos. | Cable length |
|---|-------------|--------------|
| Shielded round cable , single-sided with assembled EDAC socket plug-in connector and an open end | | |
| | 56 | 1 m |
| | 56 | 2 m |
| | 56 | 4 m |
| | 56 | 6 m |
| | 56 | 8 m |
| | 56 | 10 m |
| | 56 | 15 m |
| | 56 | 20 m |

Shielded round cable, as above, but in variable lengths

| Type | Order No. | Pcs. / Pkt. |
|------------------------------|-----------|-------------|
| CABLE-EC56/F/OE/0,34/S/ 1,0M | 2903395 | 1 |
| CABLE-EC56/F/OE/0,34/S/ 2,0M | 2903396 | 1 |
| CABLE-EC56/F/OE/0,34/S/ 4,0M | 2903397 | 1 |
| CABLE-EC56/F/OE/0,34/S/ 6,0M | 2903398 | 1 |
| CABLE-EC56/F/OE/0,34/S/ 8,0M | 2903399 | 1 |
| CABLE-EC56/F/OE/0,34/S/10,0M | 2903400 | 1 |
| CABLE-EC56/F/OE/0,34/S/15,0M | 2903401 | 1 |
| CABLE-EC56/F/OE/0,34/S/20,0M | 2903402 | 1 |
| CABLE-EC56-F-OE-0,34-S/... | 2904025 | 1 |

Pin assignment

| Single wire marking | EDAC socket plug-in connector | Single wire marking | EDAC socket plug-in connector |
|---------------------|-------------------------------|---------------------|-------------------------------|
| Z | Z | 31 | m |
| 1 | A | 32 | n |
| 2 | B | 33 | p |
| 3 | C | 34 | r |
| 4 | D | 35 | s |
| 5 | E | 36 | t |
| 6 | F | 37 | u |
| 7 | H | 38 | v |
| 8 | J | 39 | w |
| 9 | K | 40 | x |
| 10 | L | 41 | y |
| 11 | M | 42 | z |
| 12 | N | 43 | AA |
| 13 | P | 44 | BB |
| 14 | R | 45 | CC |
| 15 | S | 46 | DD |
| 16 | T | 47 | EE |
| 17 | U | 48 | FF |
| 18 | V | 49 | HH |
| 19 | W | 50 | JJ |
| 20 | X | 51 | KK |
| 21 | a | 52 | LL |
| 22 | b | 53 | MM |
| 23 | c | 54 | NN |
| 24 | d | Y | Y |
| 25 | e | | |
| 26 | f | | |
| 27 | h | | |
| 28 | j | | |
| 29 | k | | |
| 30 | l | | |



VIP – VARIOFACE Professional – secure and reliable connections in even the tightest of spaces

Space is extremely valuable in the control cabinet. That is why the I/O of automation devices feature high-position plug-in connectors. To enable the individual wires of the sensor/actuator level to be connected to the automation interface in accordance with industry requirements, Phoenix Contact is now able to offer new interface modules and new system cables inside a professional and compact housing design. Thanks to the encapsulated system cables, the control and process levels can be connected safely and reliably in harsh industrial environments.

To allow all components to be supplied with power, potential distributors are available with the same housing design.

VARIOFACE Professional means:

New modules:

- Space-saving
- Vibration resistant thanks to metal foot
- Optional marking
- New housing design

New FLK system cables:

- Encapsulated FLK plug-in connectors
- Professional strain relief
- Robust design



VIP - VARIOFACE Professional interface modules

Interface modules with various connection technologies and designs are available for the widely-used FLK, D-SUB, and high-density D-SUB plug-in connectors. Modules with a status indicator can be selected for operation monitoring purposes.



Interface module with ELCO or DIN plug-in connector

Modules with ELCO plug-in connectors exist for robust environments or where there are increased safety requirements.

Interface modules are also available for DIN strip types C, D, E, and F.



Relay/solid-state relay modules

The active modules are configured as a 4-channel, 8-channel, and 16-channel interface. Multi-channel modules exist for relay and signal/power optocouplers. These allow functions such as signal conditioning, electrical isolation, and power gain to be achieved.



System cables with encapsulated FLK or D-SUB plug-in connectors

Assembled FLK and D-SUB cables guarantee a reliable connection between the automation device and the module. 1 A (FLK cable) and 2 A (D-SUB cable) currents can be transmitted on each signal path thanks to the large conductor cross sections.

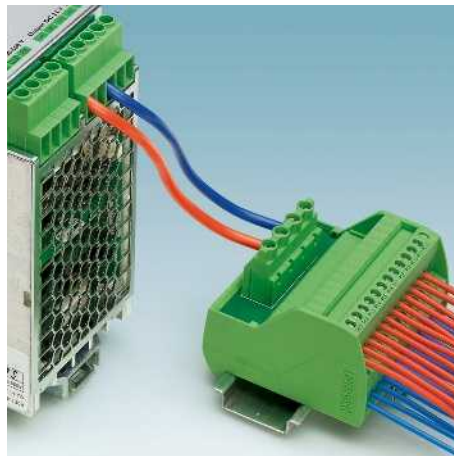

VIP - VARIOFACE Professional potential distributors

Designed for up to 250 V/30 V, the potential distributors can be used universally – for both operating voltage and control voltage distribution. Screw connections or spring-cage connection can be selected as required for the application.

System cabling for controllers

VARIOFACE wiring interface

Product overview for VIP - VARIOFACE Professional

| Device series | Passive modules (connection technology) | | | | |
|----------------------|--|---|---|--|--|
| | Flat-ribbon cable strip | D-SUB strip | DIN strip | ELCO strip | Potential distributor |
| VIP Line |  Page 524 |  Page 532 539 |  Page 540 |  Page 544 |  Page 548 |
| Standard Line | | |  540 |  544 | |
| Slim Line |  528 |  536 | | | |
| Feed-through modules |  530 |  537 | | | |
| Cables |  500 |  512 | | | |

COMBICON



Page

Device series

Active modules (function)

**Relays/
solid-state relays**



Page

Solid-state relays



Page

Standard Line



550

553

Accessories



554

558

547

547

VARIOFACE wiring interface

VIP – VARIOFACE Professional Modules with flat-ribbon cable plug-in connectors

- 1:1 connection
 - 10- to 64-pos.
 - Screw connection
 - Metal foot
 - As per IEC 60603-13
 - Optional with status indicator
- Low and high engagement latches are supplied with all modules.

Notes:

For marking systems (e.g., "ZB 22:UNBEDRUCKT"; Order No. 0811862) and mounting material, see Catalog 5.



10 to 20 positions with screw connection



Technical data

| | |
|--|---|
| Operating voltage | 60 V AC/DC |
| Max. perm. current (per branch) | 1 A |
| Ambient temperature (operation) | -20°C ... 50°C |
| Mounting position | Any |
| Standards/regulations | IEC 60664, DIN EN 50178, IEC 62103 |
| Connection data solid / stranded / AWG | 0.2 - 4 mm ² / 0.2 - 2.5 mm ² / 24 - 12 |
| Dimensions | H / D 65.5 mm / 56 mm |

Ordering data

| Description | No. of pos. | Module width W | Type | Order No. | Pcs. / Pkt. |
|---|-------------|----------------|----------------|-----------|-------------|
| VARIOFACE module, with pin strip | 10 | 34.70 | VIP-2/SC/FLK10 | 2315010 | 1 |
| | 14 | 39.80 | VIP-2/SC/FLK14 | 2315023 | 1 |
| | 16 | 45.00 | VIP-2/SC/FLK16 | 2315036 | 1 |
| | 20 | 55.10 | VIP-2/SC/FLK20 | 2315049 | 1 |
| VARIOFACE module, with pin strip and light indicator | 10 | 34.70 | | | |
| | 14 | 44.90 | | | |
| | 16 | 50.00 | | | |
| | 20 | 60.20 | | | |
| VARIOFACE module, with pin strip | 26 | 57.10 | | | |
| | 34 | 67.30 | | | |
| | 40 | 77.40 | | | |
| | 50 | 92.70 | | | |
| | 60 | 108.00 | | | |
| | 64 | 118.00 | | | |
| VARIOFACE module, with pin strip and light indicator | 26 | 57.40 | | | |
| | 34 | 67.60 | | | |
| | 40 | 77.80 | | | |
| | 50 | 93.10 | | | |
| | 60 | 113.50 | | | |
| | 64 | 118.60 | | | |

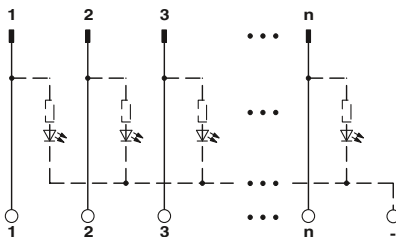



**10 to 20 positions
with screw connection and light indicator**



**26 to 64 positions
with screw connection**



**26 to 64 positions
with screw connection and light indicator**



Technical data

24 V DC
1 A
-20°C ... 50°C
Any
IEC 60664, DIN EN 50178, IEC 62103
0.2 - 4 mm² / 0.2 - 2.5 mm² / 24 - 12
65.5 mm / 56 mm

Technical data

60 V AC/DC
1 A
-20°C ... 50°C
Any
IEC 60664, DIN EN 50178, IEC 62103
0.2 - 4 mm² / 0.2 - 2.5 mm² / 24 - 12
69 mm / 62 mm

Technical data

24 V DC
1 A
-20°C ... 50°C
Any
IEC 60664, DIN EN 50178, IEC 62103
0.2 - 4 mm² / 0.2 - 2.5 mm² / 24 - 12
69 mm / 62 mm

Ordering data

Ordering data

Ordering data

| Type | Order No. | Pcs. / Pkt. |
|--------------------|-----------|-------------|
| VIP-2/SC/FLK10/LED | 2322045 | 1 |
| VIP-2/SC/FLK14/LED | 2322058 | 1 |
| VIP-2/SC/FLK16/LED | 2322061 | 1 |
| VIP-2/SC/FLK20/LED | 2322074 | 1 |

| Type | Order No. | Pcs. / Pkt. |
|----------------|-----------|-------------|
| VIP-3/SC/FLK26 | 2315052 | 1 |
| VIP-3/SC/FLK34 | 2315065 | 1 |
| VIP-3/SC/FLK40 | 2315078 | 1 |
| VIP-3/SC/FLK50 | 2315081 | 1 |
| VIP-3/SC/FLK60 | 2315094 | 1 |
| VIP-3/SC/FLK64 | 2315104 | 1 |

| Type | Order No. | Pcs. / Pkt. |
|--------------------|-----------|-------------|
| VIP-3/SC/FLK26/LED | 2322087 | 1 |
| VIP-3/SC/FLK34/LED | 2322090 | 1 |
| VIP-3/SC/FLK40/LED | 2322100 | 1 |
| VIP-3/SC/FLK50/LED | 2322113 | 1 |
| VIP-3/SC/FLK60/LED | 2322126 | 1 |
| VIP-3/SC/FLK64/LED | 2322139 | 1 |

VARIOFACE wiring interface

VIP – VARIOFACE Professional Modules with flat-ribbon cable plug-in connectors

- 1:1 connection
 - 10- to 64-pos.
 - Push-in connection
 - Metal foot
 - As per IEC 60603-13
 - Optional with status indicator
- Low and high engagement latches are supplied with all modules.

Notes:
For marking systems (e.g., "ZB 22:UNBEDRUCKT"; Order No. 0811862) and mounting material, see Catalog 5.



10 to 20 positions
with push-in connection

Operating voltage
Max. perm. current (per branch)
Ambient temperature (operation)
Mounting position
Standards/regulations
Connection data solid / stranded / AWG
Dimensions

Technical data
60 V AC/DC
1 A
-20°C ... 50°C
Any
IEC 60664, DIN EN 50178, IEC 62103
0.14 - 2.5 mm² / 0.14 - 2.5 mm² / 26 - 14
72.1 mm / 56 mm

H / D

| Description | No. of pos. | Module width W |
|---|-------------|----------------|
| VARIOFACE module, with pin strip | 10 | 36.80 |
| | 14 | 41.90 |
| | 16 | 46.90 |
| | 20 | 57.10 |
| VARIOFACE module, with pin strip and light indicator | 10 | 36.80 |
| | 14 | 41.90 |
| | 16 | 46.90 |
| | 20 | 57.10 |
| VARIOFACE module, with pin strip | 26 | 57.10 |
| | 34 | 67.30 |
| | 40 | 77.40 |
| | 50 | 92.70 |
| | 60 | 107.90 |
| | 64 | 118.10 |
| VARIOFACE module, with pin strip and light indicator | 26 | 57.10 |
| | 34 | 67.30 |
| | 40 | 77.40 |
| | 50 | 92.70 |
| | 60 | 107.90 |
| | 64 | 118.10 |

Ordering data

| Type | Order No. | Pcs. / Pkt. |
|----------------|-----------|-------------|
| VIP-2/PT/FLK10 | 2903787 | 1 |
| VIP-2/PT/FLK14 | 2903788 | 1 |
| VIP-2/PT/FLK16 | 2903789 | 1 |
| VIP-2/PT/FLK20 | 2903790 | 1 |

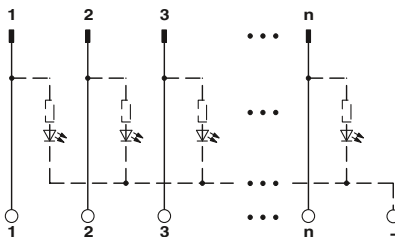



**10 to 20 positions
with push-in connection and light indicator**

N

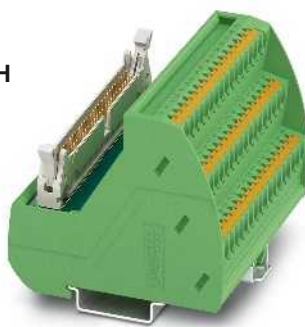

**26 to 64 positions
with push-in connection**

N

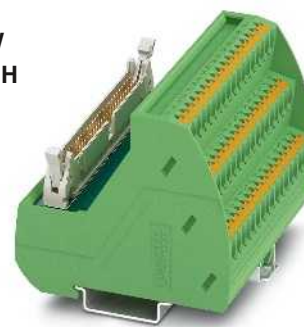

**26 to 64 positions
with push-in connection and light indicator**

N

Technical data

24 V DC
1 A
-20°C ... 50°C
Any
IEC 60664, DIN EN 50178, IEC 62103
0.14 - 2.5 mm² / 0.14 - 2.5 mm² / 26 - 14
72.1 mm / 56 mm

Technical data

60 V AC/DC
1 A
-20°C ... 50°C
Any
IEC 60664, DIN EN 50178, IEC 62103
0.14 - 2.5 mm² / 0.14 - 2.5 mm² / 26 - 14
75.8 mm / 63 mm

Technical data

24 V DC
1 A
-20°C ... 50°C
Any
IEC 60664, DIN EN 50178, IEC 62103
0.14 - 2.5 mm² / 0.14 - 2.5 mm² / 26 - 14
75.8 mm / 63 mm

Ordering data

| Type | Order No. | Pcs. / Pkt. |
|--------------------|-----------|-------------|
| VIP-2/PT/FLK10/LED | 2904248 | 1 |
| VIP-2/PT/FLK14/LED | 2904249 | 1 |
| VIP-2/PT/FLK16/LED | 2904250 | 1 |
| VIP-2/PT/FLK20/LED | 2904251 | 1 |

Ordering data

| Type | Order No. | Pcs. / Pkt. |
|----------------|-----------|-------------|
| VIP-3/PT/FLK26 | 2903791 | 1 |
| VIP-3/PT/FLK34 | 2903792 | 1 |
| VIP-3/PT/FLK40 | 2903793 | 1 |
| VIP-3/PT/FLK50 | 2903794 | 1 |
| VIP-3/PT/FLK60 | 2903795 | 1 |
| VIP-3/PT/FLK64 | 2903796 | 1 |

Ordering data

| Type | Order No. | Pcs. / Pkt. |
|--------------------|-----------|-------------|
| VIP-3/PT/FLK26/LED | 2904252 | 1 |
| VIP-3/PT/FLK34/LED | 2904253 | 1 |
| VIP-3/PT/FLK40/LED | 2904254 | 1 |
| VIP-3/PT/FLK50/LED | 2904255 | 1 |
| VIP-3/PT/FLK60/LED | 2904256 | 1 |
| VIP-3/PT/FLK64/LED | 2904257 | 1 |

System cabling for controllers

VARIOFACE wiring interface

SLIM-LINE modules for flat-ribbon cable plug-in connectors

VARIOFACE SLIM-LINE modules connect flat-ribbon cable plug-in connectors in accordance with IEC 60603-13/DIN 41651 to front connection terminal blocks.

The modules are provided with low and high engagement latches to protect the flat-ribbon cable plug-in connector against being accidentally released.



20 and 26-pos.
with screw connection



34 to 50 positions
with screw connection

| | |
|---|-------|
| Operating voltage | |
| Max. perm. current (per branch) | |
| Ambient temperature (operation) | |
| Mounting position | |
| Standards/regulations | |
| Screw connection solid / stranded / AWG | |
| Dimensions | D / W |



| Technical data | |
|---|--|
| < 50 V AC / 60 V DC | |
| 0.8 A (data valid for 100% coincidence factor) | |
| -10°C ... 50°C | |
| Any | |
| IEC 60664, DIN EN 50178, IEC 62103 | |
| 0.2 ... 4 mm ² / 0.2 ... 2.5 mm ² / 24 - 12 | |
| 45 mm / 25 mm | |

| Ordering data | | |
|---------------------|-----------|-------------|
| Type | Order No. | Pcs. / Pkt. |
| UM 25-FLK20/Front/Q | 2959515 | 1 |
| UM-25 FLK26/Front/Q | 2959528 | 1 |



| Technical data | |
|---|--|
| < 50 V AC / 60 V DC | |
| 1 A (data valid for 100% coincidence factor) | |
| -10°C ... 50°C | |
| Any | |
| IEC 60664, DIN EN 50178, IEC 62103 | |
| 0.2 ... 4 mm ² / 0.2 ... 2.5 mm ² / 24 - 12 | |
| 45 mm / 45 mm | |

| Ordering data | | |
|---------------------|-----------|-------------|
| Type | Order No. | Pcs. / Pkt. |
| UM 45-FLK34/Front/Q | 2959531 | 1 |
| UM 45-FLK40/Front/Q | 2959544 | 1 |
| UM 45-FLK50/Front/Q | 2959557 | 1 |

| Description | No. of pos. | Module height H |
|--|-------------|-----------------|
| VARIOFACE-SLIM-LINE module, with pin strip | 20 | 177.00 |
| | 26 | 217.00 |
| VARIOFACE-SLIM-LINE module, with pin strip | 34 | 147.00 |
| | 40 | 167.00 |
| | 50 | 197.00 |

System cabling for controllers

VARIOFACE wiring interface

Panel feed-through modules for flat-ribbon cable plug-in connectors

VARIOFACE DFLK... panel feed-through modules connect the flat-ribbon cable plug-in connectors in accordance with IEC 60603-13/DIN 41651 to the screw connection terminal blocks.

These modules are suitable for mounting on a side panel with an appropriate housing cutout (see dimensioning table).

The modules are provided with low and high engagement latches to protect the flat-ribbon cable plug-in connector against being accidentally released.



16 to 50 positions
with screw connection

Technical data

| | |
|--|---|
| Operating voltage | < 50 V AC / 60 V DC |
| Max. perm. current (per branch) | 1 A |
| Ambient temperature (operation) | -20°C ... 50°C |
| Mounting position | Any |
| Standards/regulations | DIN EN 50178 |
| Connection data solid / stranded / AWG | 0.2 - 4 mm ² / 0.2 - 2.5 mm ² / 24 - 12 |

Ordering data

| Description | No. of pos. | Module width W | Type | Order No. | Pcs. / Pkt. |
|--|-------------|----------------|----------------|----------------|-------------|
| VARIOFACE feed-through module, with pin strip | | | | | |
| | 16 | 39.00 | DFLK 16 | 2280239 | 5 |
| | 20 | 39.00 | DFLK 20 | 2280242 | 5 |
| | 26 | 39.00 | DFLK 26 | 2280255 | 5 |
| | 34 | 39.00 | DFLK 34 | 2280268 | 5 |
| | 40 | 39.00 | DFLK 40 | 2280271 | 5 |
| | 50 | 39.00 | DFLK 50 | 2280284 | 5 |

Dimensioning of the housing cutout



| Type | a | b | c | d |
|---------|-------|-------|------------|---------|
| DFLK 16 | 58.4 | 52.5 | 40.1 + 0.2 | 9 + 0.2 |
| DFLK 20 | 68.4 | 62.5 | 45.2 + 0.2 | 9 + 0.2 |
| DFLK 26 | 83.4 | 77.5 | 52.8 + 0.2 | 9 + 0.2 |
| DFLK 34 | 103.4 | 97.5 | 63.0 + 0.2 | 9 + 0.2 |
| DFLK 40 | 128.4 | 122.5 | 70.6 + 0.2 | 9 + 0.2 |
| DFLK 50 | 143.4 | 137.5 | 83.3 + 0.2 | 9 + 0.2 |

Dimensional drawing DFLK:

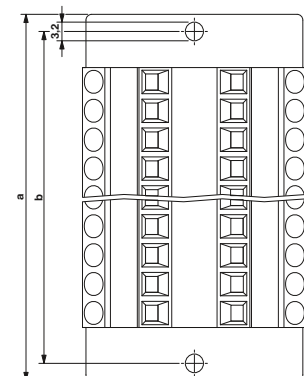
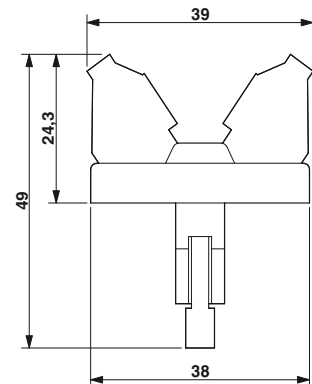

Feed-through modules for IDC/FLK plug-in connectors (pitch 2.54 mm) with spring-cage connection

- 1:1 connection
- 10- to 50-pos.
- Plug-in push-in spring-cage connection
- Plug-in connectors as per IEC 60603-13
- Short and long latches are supplied with the module
- Select housing cutout for side panel mounting according to dimensions table



With pin strip and push-in spring-cage connection

Technical data

| | |
|--|---|
| Operating voltage | < 50 V AC / 60 V DC |
| Max. perm. current (per branch) | 1 A |
| Ambient temperature (operation) | -20°C ... 50°C |
| Mounting position | Any |
| Standards/regulations | DIN EN 50178 |
| Connection data solid / stranded / AWG | 0.2 - 2.5 mm ² / 0.2 - 2.5 mm ² / 24 - 12 |

Ordering data

| Description | No. of pos. | Module width W | Type | Order No. | Pcs. / Pkt. |
|--|-------------|----------------|--------------|-----------|-------------|
| VARIOFACE feed-through module, with pin strip | | | | | |
| | 10 | 36.50 | DFLK 10/FKCT | 2903034 | 1 |
| | 14 | 36.50 | DFLK 14/FKCT | 2903035 | 1 |
| | 16 | 36.50 | DFLK 16/FKCT | 2903036 | 1 |
| | 20 | 36.50 | DFLK 20/FKCT | 2903038 | 1 |
| | 26 | 36.50 | DFLK 26/FKCT | 2903039 | 1 |
| | 34 | 36.50 | DFLK 34/FKCT | 2903041 | 1 |
| | 40 | 36.50 | DFLK 40/FKCT | 2903042 | 1 |
| | 50 | 36.50 | DFLK 50/FKCT | 2903043 | 1 |

Dimensioning of the housing cutout

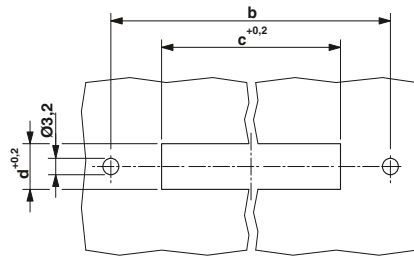

Dimensional drawing DFLK...FKCT

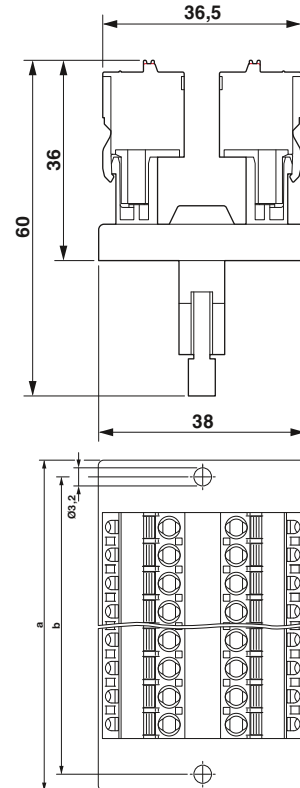

| Type | a | b | c | d |
|--------------|-------|-------|------------|---------|
| DFLK 10/FKCT | 58.4 | 52.5 | 40.1 + 0.2 | 9 + 0.2 |
| DFLK 14/FKCT | 58.4 | 52.5 | 40.1 + 0.2 | 9 + 0.2 |
| DFLK 16/FKCT | 58.4 | 52.5 | 40.1 + 0.2 | 9 + 0.2 |
| DFLK 20/FKCT | 68.4 | 62.5 | 45.2 + 0.2 | 9 + 0.2 |
| DFLK 26/FKCT | 83.4 | 77.5 | 52.8 + 0.2 | 9 + 0.2 |
| DFLK 34/FKCT | 103.4 | 97.5 | 63.0 + 0.2 | 9 + 0.2 |
| DFLK 40/FKCT | 128.4 | 122.5 | 70.6 + 0.2 | 9 + 0.2 |
| DFLK 50/FKCT | 143.4 | 137.5 | 83.3 + 0.2 | 9 + 0.2 |

VARIOFACE wiring interface

VIP – VARIOFACE Professional Modules with D-SUB plug-in connectors

- 1:1 connection
 - 9- to 50-pos.
 - Screw connection
 - Metal foot
 - As per IEC 60807-2
 - Optional with status indicator
- The D-SUB-4-40 UNC threads are guided directly onto a connection terminal block.

Notes:
For marking systems (e.g., "ZB 22:UNBEDRUCKT"; Order No. 0811862) and mounting material, see Catalog 5.



9 to 15 positions
with screw connection



Operating voltage
Max. perm. current (per branch)
Ambient temperature (operation)
Mounting position
Standards/regulations
Connection data solid / stranded / AWG
Dimensions

125 V AC/DC
2 A
-20°C ... 50°C
Any
IEC 60664, DIN EN 50178, IEC 62103
0.2 - 4 mm² / 0.2 - 2.5 mm² / 24 - 12
65.5 mm / 45.1 mm

Ordering data

| Description | No. of pos. | Module width W |
|---|----------------|-------------------------|
| VARIOFACE module , with D-SUB miniature pin strip | 9 15 | 34.70 45.00 |
| VARIOFACE module , with D-SUB miniature pin strip and light indicator | 9 15 | 34.70 50.00 |
| VARIOFACE module , with D-SUB miniature socket strip | 9 15 | 34.70 45.00 |
| VARIOFACE module , with D-SUB miniature socket strip and light indicator | 9 15 | 34.70 50.00 |
| VARIOFACE module , with D-SUB miniature pin strip | 25 37 50 | 57.40 72.70 98.20 |
| VARIOFACE module , with D-SUB miniature pin strip and light indicator | 25 37 50 | 57.40 72.70 98.20 |
| VARIOFACE module , with D-SUB miniature socket strip | 25 37 50 | 57.40 72.70 98.20 |
| VARIOFACE module , with D-SUB miniature socket strip and light indicator | 25 37 50 | 57.40 72.70 98.20 |

| Type | Order No. | Pcs. / Pkt. |
|--------------------------|-----------|-------------|
| VIP-2/SC/D 9SUB/M | 2315117 | 1 |
| VIP-2/SC/D15SUB/M | 2315120 | 1 |
| VIP-2/SC/D 9SUB/F | 2315162 | 1 |
| VIP-2/SC/D15SUB/F | 2315175 | 1 |

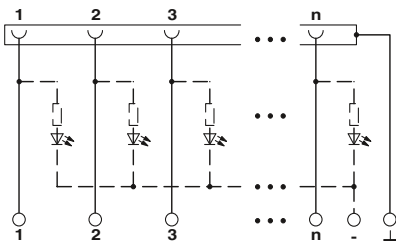



9 to 15 positions
with screw connection and light indicator



25 to 50 positions
with screw connection



25 to 50 positions
with screw connection and light indicator



Technical data

24 V DC
2.5 A
-20°C ... 50°C
Any
IEC 60664, DIN EN 50178, IEC 62103
0.2 - 4 mm² / 0.2 - 2.5 mm² / 24 - 12
65.5 mm / 45.1 mm

Technical data

125 V AC/DC
2 A
-20°C ... 50°C
Any
IEC 60664, DIN EN 50178, IEC 62103
0.2 - 4 mm² / 0.2 - 2.5 mm² / 24 - 12
69 mm / 62 mm

Technical data

24 V DC
2.5 A
-20°C ... 50°C
Any
IEC 60664, DIN EN 50178, IEC 62103
0.2 - 4 mm² / 0.2 - 2.5 mm² / 24 - 12
69 mm / 62 mm

Ordering data

Ordering data

Ordering data

| Type | Order No. | Pcs. / Pkt. |
|-----------------------|-----------|-------------|
| VIP-2/SC/D 9SUB/M/LED | 2322142 | 1 |
| VIP-2/SC/D15SUB/M/LED | 2322155 | 1 |
| VIP-2/SC/D 9SUB/F/LED | 2322197 | 1 |
| VIP-2/SC/D15SUB/F/LED | 2322207 | 1 |

| Type | Order No. | Pcs. / Pkt. |
|-------------------|-----------|-------------|
| VIP-3/SC/D25SUB/M | 2315133 | 1 |
| VIP-3/SC/D37SUB/M | 2315146 | 1 |
| VIP-3/SC/D50SUB/M | 2315159 | 1 |
| VIP-3/SC/D25SUB/F | 2315188 | 1 |
| VIP-3/SC/D37SUB/F | 2315191 | 1 |
| VIP-3/SC/D50SUB/F | 2315201 | 1 |

| Type | Order No. | Pcs. / Pkt. |
|-----------------------|-----------|-------------|
| VIP-3/SC/D25SUB/M/LED | 2322168 | 1 |
| VIP-3/SC/D37SUB/M/LED | 2322171 | 1 |
| VIP-3/SC/D50SUB/M/LED | 2322184 | 1 |
| VIP-3/SC/D25SUB/F/LED | 2322210 | 1 |
| VIP-3/SC/D37SUB/F/LED | 2322223 | 1 |
| VIP-3/SC/D50SUB/F/LED | 2322236 | 1 |

VARIOFACE wiring interface

VIP – VARIOFACE Professional Modules with D-SUB plug-in connectors

- 1:1 connection
 - 9- to 50-pos.
 - Push-in connection
 - Metal foot
 - As per IEC 60807-2
 - Optional with status indicator
- The D-SUB-4-40 UNC threads are guided directly onto a connection terminal block.

Notes:
For marking systems (e.g., "ZB 22:UNBEDRUCKT"; Order No. 0811862) and mounting material, see Catalog 5.



N



9 to 15 positions with push-in connection

Operating voltage
Max. perm. current (per branch)
Ambient temperature (operation)
Mounting position
Standards/regulations
Connection data solid / stranded / AWG
Dimensions

| Technical data | |
|--|---|
| Operating voltage | 125 V AC/DC |
| Max. perm. current (per branch) | 2 A |
| Ambient temperature (operation) | -20°C ... 50°C |
| Mounting position | Any |
| Standards/regulations | IEC 60664, DIN EN 50178, IEC 62103 |
| Connection data solid / stranded / AWG | 0.14 - 2.5 mm ² / 0.14 - 2.5 mm ² / 26 - 14 |
| Dimensions | 72.1 mm / 46.6 mm |

| Description | No. of pos. | Module width W |
|---|-------------|----------------|
| VARIOFACE module , with D-SUB miniature pin strip | 9 | 36.80 |
| | 15 | 46.90 |
| VARIOFACE module , with D-SUB miniature pin strip and light indicator | 9 | 36.80 |
| | 15 | 52.00 |
| VARIOFACE module , with D-SUB miniature socket strip | 9 | 36.80 |
| | 15 | 46.90 |
| VARIOFACE module , with D-SUB miniature socket strip and light indicator | 9 | 36.80 |
| | 15 | 52.00 |
| VARIOFACE module , with D-SUB miniature pin strip | 25 | 57.10 |
| | 37 | 72.30 |
| | 50 | 97.70 |
| VARIOFACE module , with D-SUB miniature pin strip and light indicator | 25 | 57.10 |
| | 37 | 72.30 |
| | 50 | 97.70 |
| VARIOFACE module , with D-SUB miniature socket strip | 25 | 57.10 |
| | 37 | 72.30 |
| | 50 | 97.70 |
| VARIOFACE module , with D-SUB miniature socket strip and light indicator | 25 | 57.10 |
| | 37 | 72.30 |
| | 50 | 97.70 |

| Ordering data | | |
|-------------------|-----------|-------------|
| Type | Order No. | Pcs. / Pkt. |
| VIP-2/PT/D 9SUB/M | 2903777 | 1 |
| VIP-2/PT/D15SUB/M | 2903779 | 1 |
| VIP-2/PT/D 9SUB/F | 2903778 | 1 |
| VIP-2/PT/D15SUB/F | 2903780 | 1 |

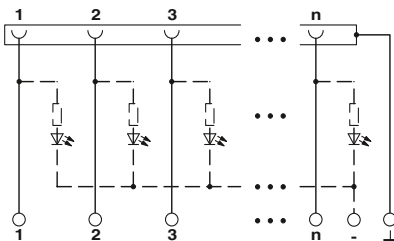



9 to 15 positions
with push-in connection and light indicator

N

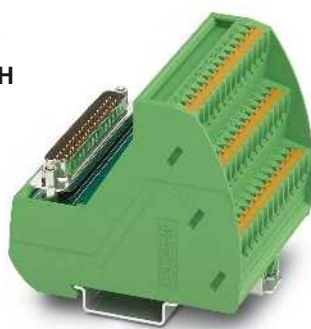

25 to 50 positions
with push-in connection

N

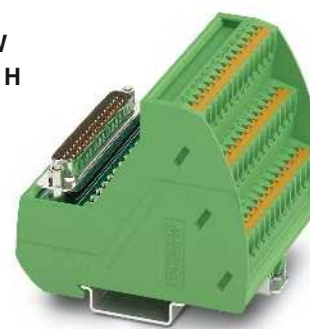

25 to 50 positions
with push-in connection and light indicator

N

Technical data

24 V DC
2 A
-20°C ... 50°C
Any
IEC 60664, DIN EN 50178, IEC 62103
0.14 - 2.5 mm² / 0.14 - 2.5 mm² / 26 - 14
72.1 mm / 46.6 mm

Technical data

125 V AC/DC
2 A
-20°C ... 50°C
Any
IEC 60664, DIN EN 50178, IEC 62103
0.14 - 2.5 mm² / 0.14 - 2.5 mm² / 26 - 14
75.8 mm / 63 mm

Technical data

24 V DC
2 A
-20°C ... 50°C
Any
IEC 60664, DIN EN 50178, IEC 62103
0.14 - 2.5 mm² / 0.14 - 2.5 mm² / 26 - 14
75.8 mm / 63 mm

Ordering data

| Type | Order No. | Pcs. / Pkt. |
|-----------------------|-----------|-------------|
| VIP-2/PT/D 9SUB/M/LED | 2904258 | 1 |
| VIP-2/PT/D15SUB/M/LED | 2904259 | 1 |
| VIP-2/PT/D 9SUB/F/LED | 2904263 | 1 |
| VIP-2/PT/D15SUB/F/LED | 2904264 | 1 |

Ordering data

| Type | Order No. | Pcs. / Pkt. |
|-------------------|-----------|-------------|
| VIP-3/PT/D25SUB/M | 2903781 | 1 |
| VIP-3/PT/D37SUB/M | 2903783 | 1 |
| VIP-3/PT/D50SUB/M | 2903785 | 1 |
| VIP-3/PT/D25SUB/F | 2903782 | 1 |
| VIP-3/PT/D37SUB/F | 2903784 | 1 |
| VIP-3/PT/D50SUB/F | 2903786 | 1 |

Ordering data

| Type | Order No. | Pcs. / Pkt. |
|-----------------------|-----------|-------------|
| VIP-3/PT/D25SUB/M/LED | 2904260 | 1 |
| VIP-3/PT/D37SUB/M/LED | 2904261 | 1 |
| VIP-3/PT/D50SUB/M/LED | 2904262 | 1 |
| VIP-3/PT/D25SUB/F/LED | 2904265 | 1 |
| VIP-3/PT/D37SUB/F/LED | 2904266 | 1 |
| VIP-3/PT/D50SUB/F/LED | 2904267 | 1 |

System cabling for controllers

VARIOFACE wiring interface

SLIM-LINE modules for D-subminiature plug-in connectors

These VARIOFACE modules connect D-SUB strips with front connection terminal blocks in accordance with IEC 60807-2/DIN 41652.

To make the ground connection, the metallic plug shell (4-40 UNC thread) makes contact with a connection terminal block.



9 to 25 positions
With screw connection



37 to 50 positions
With screw connection

| | |
|---------------------------------|-------|
| Operating voltage | |
| Max. perm. current (per branch) | |
| Ambient temperature (operation) | |
| Mounting position | |
| Standards/regulations | |
| Dimensions | D / W |



| Technical data | |
|---------------------------------|---|
| Operating voltage | 125 V AC/DC |
| Max. perm. current (per branch) | 2.5 A |
| Ambient temperature (operation) | -10°C ... 50°C |
| Mounting position | Any |
| Standards/regulations | IEC 60664, IEC 60664 A, DIN VDE 0110, DIN VDE 0160 (in parts) |
| Dimensions | 45 mm / 25 mm |

Ordering data

| Type | Order No. | Pcs. / Pkt. |
|------------------------|-----------|-------------|
| UM 25-D 9SUB/S/Front/Q | 2959573 | 1 |
| UM 25-D15SUB/S/Front/Q | 2959599 | 1 |
| UM 25-D25SUB/S/Front/Q | 2959612 | 1 |
| UM 25-D 9SUB/B/Front/Q | 2959560 | 1 |
| UM 25-D15SUB/B/Front/Q | 2959586 | 1 |
| UM 25-D25SUB/B/Front/Q | 2959609 | 1 |



| Technical data | |
|---------------------------------|------------------------------------|
| Operating voltage | 125 V AC/DC |
| Max. perm. current (per branch) | 2.5 A |
| Ambient temperature (operation) | -10°C ... 50°C |
| Mounting position | Any |
| Standards/regulations | IEC 60664, DIN EN 50178, IEC 62103 |
| Dimensions | 45 mm / 45 mm |

Ordering data

| Type | Order No. | Pcs. / Pkt. |
|------------------------|-----------|-------------|
| UM 45-D37SUB/S/Front/Q | 2959638 | 1 |
| UM 45-D50SUB/S/Front/Q | 2959654 | 1 |
| UM 45-D37SUB/B/Front/Q | 2959625 | 1 |
| UM 45-D50SUB/B/Front/Q | 2959641 | 1 |

| Description | No. of pos. | Module height H |
|---|-------------|-----------------|
| VARIOFACE-SLIM-LINE module, with D-SUB miniature pin strip | 9 | 117.00 |
| | 15 | 147.00 |
| | 25 | 217.00 |
| VARIOFACE-SLIM-LINE module, with D-SUB miniature socket strip | 9 | 117.00 |
| | 15 | 147.00 |
| | 25 | 217.00 |
| VARIOFACE-SLIM-LINE module, with D-SUB miniature pin strip | 37 | 157.00 |
| | 50 | 187.00 |
| VARIOFACE-SLIM-LINE module, with D-SUB miniature socket strip | 37 | 157.00 |
| | 50 | 187.00 |

Feed-through modules for D-SUB miniature plug-in connectors with screw connection

- 1:1 connection
- 9- to 50-pos.
- Screw connection
- As per IEC 60807-2
- D-SUB 4-40 UNC thread
- 9- to 37-pos.: Separate ground tap
- 50-pos.: No ground tap

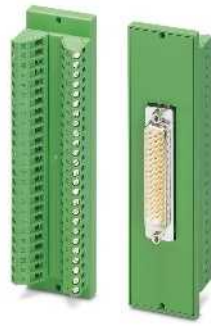

With D-subminiature pin strip



With D-subminiature socket strip

| | |
|--|---|
| Operating voltage | 125 V AC/DC |
| Max. perm. current (per branch) | 2.5 A |
| Ambient temperature (operation) | -20°C ... 50°C |
| Mounting position | Any |
| Standards/regulations | DIN EN 50178 |
| Connection data solid / stranded / AWG | 0.2 - 4 mm ² / 0.2 - 2.5 mm ² / 24 - 12 |

Technical data

| | |
|--|---|
| Operating voltage | 125 V AC/DC |
| Max. perm. current (per branch) | 2.5 A |
| Ambient temperature (operation) | -20°C ... 50°C |
| Mounting position | Any |
| Standards/regulations | DIN EN 50178 |
| Connection data solid / stranded / AWG | 0.2 - 4 mm ² / 0.2 - 2.5 mm ² / 24 - 12 |

Technical data

| | |
|--|---|
| Operating voltage | 125 V AC/DC |
| Max. perm. current (per branch) | 2.5 A |
| Ambient temperature (operation) | -20°C ... 50°C |
| Mounting position | Any |
| Standards/regulations | DIN EN 50178 |
| Connection data solid / stranded / AWG | 0.2 - 4 mm ² / 0.2 - 2.5 mm ² / 24 - 12 |

| Description | No. of pos. | Module width W |
|---|-------------|----------------|
| VARIOFACE feed-through module, with D-subminiature plug-in connector | | |
| | 9 | 39.00 |
| | 15 | 39.00 |
| | 25 | 39.00 |
| | 37 | 39.00 |
| | 50 | 39.00 |

Ordering data

| Type | Order No. | Pcs. / Pkt. |
|-----------------------|----------------|-------------|
| DFLK-D 9 SUB/S | 2283870 | 5 |
| DFLK-D15 SUB/S | 2280297 | 5 |
| DFLK-D25 SUB/S | 2280310 | 5 |
| DFLK-D37 SUB/S | 2280336 | 5 |
| DFLK-D50 SUB/S | 2291286 | 5 |

Ordering data

| Type | Order No. | Pcs. / Pkt. |
|-----------------------|----------------|-------------|
| DFLK-D 9 SUB/B | 2287135 | 5 |
| DFLK-D15 SUB/B | 2280307 | 5 |
| DFLK-D25 SUB/B | 2280323 | 5 |
| DFLK-D37 SUB/B | 2280349 | 5 |
| DFLK-D50 SUB/B | 2287669 | 5 |

Dimensioning of the housing cutout



| Type | a | b | c | d |
|-----------------|-------|-------|------------|------------|
| DFLK-D 9 SUB/S | 58.4 | 52.5 | 40.2 + 0.2 | 13 + 0.2 |
| DFLK-D 15 SUB/S | 58.4 | 52.5 | 40.2 + 0.2 | 13 + 0.2 |
| DFLK-D 25 SUB/S | 83.4 | 77.5 | 54.2 + 0.2 | 13 + 0.2 |
| DFLK-D 37 SUB/S | 128.4 | 122.5 | 70.6 + 0.2 | 13 + 0.2 |
| DFLK-D 50 SUB/S | 143.4 | 137.5 | 67.8 + 0.2 | 15.8 + 0.2 |
| DFLK-D 9 SUB/B | 58.4 | 52.5 | 40.2 + 0.2 | 13 + 0.2 |
| DFLK-D 15 SUB/B | 58.4 | 52.5 | 40.2 + 0.2 | 13 + 0.2 |
| DFLK-D 25 SUB/B | 83.4 | 77.5 | 54.2 + 0.2 | 13 + 0.2 |
| DFLK-D 37 SUB/B | 128.4 | 122.5 | 70.6 + 0.2 | 13 + 0.2 |
| DFLK-D 50 SUB/B | 143.4 | 137.5 | 67.8 + 0.2 | 15.8 + 0.2 |

Dimensional drawing: DFLK-D...SUB:

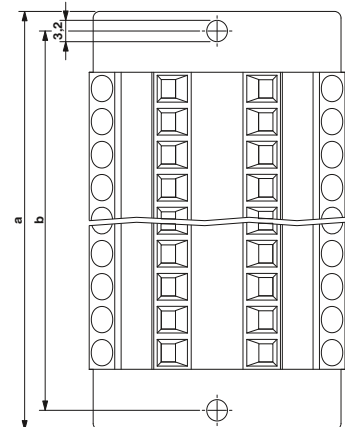

System cabling for controllers

VARIOFACE wiring interface

Feed-through modules for D-SUB miniature plug-in connectors with push-in connection

- 1:1 connection
- 9- to 50-pos.
- Plug-in push-in spring-cage connection
- Plug-in connector according to IEC 60807-2
- D-SUB 4-40 UNC thread
- 9- to 37-pos. with separate ground tap
- 50-pos.: No ground tap
- Select housing cutout for side panel mounting according to dimensions table



With D-SUB pin strip and push-in connection

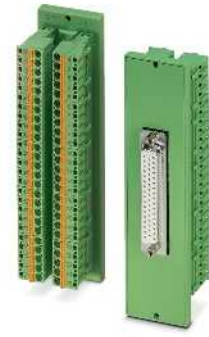

With D-SUB socket strip and push-in connection

Operating voltage
Max. perm. current (per branch)
Ambient temperature (operation)
Mounting position
Standards/regulations
Connection data solid / stranded / AWG

125 V AC/DC
2.5 A
-20°C ... 50°C
Any
DIN EN 50178
0.2 - 2.5 mm² / 0.2 - 2.5 mm² / 24 - 12

125 V AC/DC
2.5 A
-20°C ... 50°C
Any
DIN EN 50178
0.2 - 2.5 mm² / 0.2 - 2.5 mm² / 24 - 12

| Description | No. of pos. | Module width W |
|--|-------------|----------------|
| VARIOFACE feed-through module, with D-subminiature plug-in connector | | |
| | 9 | 36.50 |
| | 15 | 36.50 |
| | 25 | 36.50 |
| | 37 | 36.50 |
| | 50 | 36.50 |

| Ordering data | | |
|---------------------|-----------|-------------|
| Type | Order No. | Pcs. / Pkt. |
| DFLK-D 9 SUB/M/FKCT | 2903052 | 1 |
| DFLK-D15 SUB/M/FKCT | 2903054 | 1 |
| DFLK-D25 SUB/M/FKCT | 2903055 | 1 |
| DFLK-D37 SUB/M/FKCT | 2903056 | 1 |
| DFLK-D50 SUB/M/FKCT | 2903058 | 1 |

| Ordering data | | |
|---------------------|-----------|-------------|
| Type | Order No. | Pcs. / Pkt. |
| DFLK-D 9 SUB/F/FKCT | 2903063 | 1 |
| DFLK-D15 SUB/F/FKCT | 2903065 | 1 |
| DFLK-D25 SUB/F/FKCT | 2903067 | 1 |
| DFLK-D37 SUB/F/FKCT | 2903069 | 1 |
| DFLK-D50 SUB/F/FKCT | 2903070 | 1 |

Dimensioning of the housing cutout

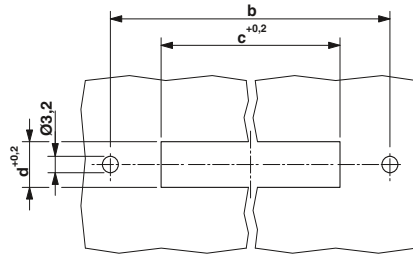

| Type | a | b | c | d |
|---------------------|-------|-------|------------|------------|
| DFLK-D 9 SUB/M/FKCT | 58.4 | 52.5 | 40.2 + 0.2 | 13 + 0.2 |
| DFLK-D15 SUB/M/FKCT | 58.4 | 52.5 | 40.2 + 0.2 | 13 + 0.2 |
| DFLK-D25 SUB/M/FKCT | 83.4 | 77.5 | 54.2 + 0.2 | 13 + 0.2 |
| DFLK-D37 SUB/M/FKCT | 128.4 | 122.5 | 70.6 + 0.2 | 13 + 0.2 |
| DFLK-D50 SUB/M/FKCT | 143.4 | 137.5 | 67.8 + 0.2 | 15.8 + 0.2 |
| DFLK-D 9 SUB/F/FKCT | 58.4 | 52.5 | 40.2 + 0.2 | 13 + 0.2 |
| DFLK-D15 SUB/F/FKCT | 58.4 | 52.5 | 40.2 + 0.2 | 13 + 0.2 |
| DFLK-D25 SUB/F/FKCT | 83.4 | 77.5 | 54.2 + 0.2 | 13 + 0.2 |
| DFLK-D37 SUB/F/FKCT | 128.4 | 122.5 | 70.6 + 0.2 | 13 + 0.2 |
| DFLK-D50 SUB/F/FKCT | 143.4 | 137.5 | 67.8 + 0.2 | 15.8 + 0.2 |

Dimensional drawing DFLK-D...SUB...FKCT

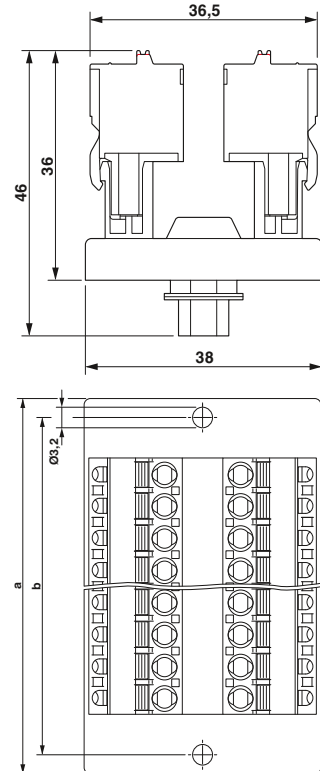

VIP – VARIOFACE Professional modules for high density D-SUB miniature plug-in connectors

- 1:1 connection
- 15- to 62-pos.
- Screw and push-in connection
- Metal foot

The D-SUB-4-40 UNC threads are guided directly onto a connection terminal block.

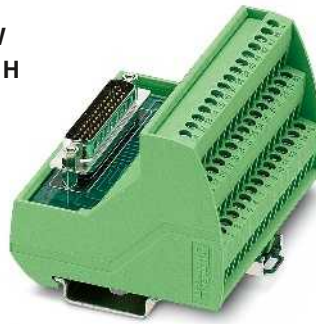

15 to 62 positions
with screw connection

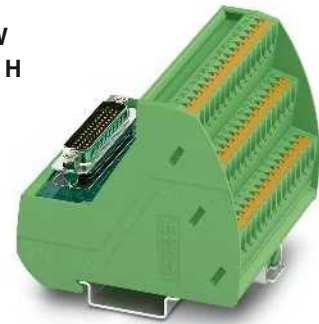

15 to 62 positions
with push-in connection

Notes:

For marking systems (e.g., "ZB 22:UNBEDRUCKT"; Order No. 0811862) and mounting material, see Catalog 5.

1) Module with double-level terminal blocks



| | |
|--|---|
| Operating voltage | 125 V AC/DC |
| Max. perm. current (per branch) | 1 A |
| Ambient temperature (operation) | -20°C ... 50°C |
| Mounting position | Any |
| Connection data solid / stranded / AWG | 0.2 - 4 mm ² / 0.2 - 2.5 mm ² / 24 - 12 |
| Dimensions | 69 mm / 62 mm |

| Technical data | |
|--|---|
| Operating voltage | 125 V AC/DC |
| Max. perm. current (per branch) | 1 A |
| Ambient temperature (operation) | -20°C ... 50°C |
| Mounting position | Any |
| Connection data solid / stranded / AWG | 0.2 - 4 mm ² / 0.2 - 2.5 mm ² / 24 - 12 |
| Dimensions | 69 mm / 62 mm |

| Technical data | |
|--|---|
| Operating voltage | 125 V AC/DC |
| Max. perm. current (per branch) | 1 A |
| Ambient temperature (operation) | -20°C ... 50°C |
| Mounting position | Any |
| Connection data solid / stranded / AWG | 0.14 - 2.5 mm ² / 0.14 - 2.5 mm ² / 26 - 14 |
| Dimensions | 75.8 mm / 63 mm |

| Description | No. of pos. | Module width W |
|--|-------------|----------------|
| VARIOFACE module, with D-SUB miniature pin strip | | |
| With screw connection 1) | 15 | 44.90 |
| With screw connection | 26 | 52.30 |
| With screw connection | 44 | 82.90 |
| With screw connection | 62 | 113.50 |
| With push-in connection 1) | 15 | 46.90 |
| With push-in connection | 26 | 52.00 |
| With push-in connection | 44 | 82.50 |
| With push-in connection | 62 | 113.00 |
| VARIOFACE module, with D-SUB miniature socket strip | | |
| With screw connection 1) | 15 | 44.90 |
| With screw connection | 26 | 52.30 |
| With screw connection | 44 | 82.90 |
| With screw connection | 62 | 113.50 |
| With push-in connection 1) | 15 | 46.90 |
| With push-in connection | 26 | 52.00 |
| With push-in connection | 44 | 82.50 |
| With push-in connection | 62 | 113.00 |

| Ordering data | | | |
|--------------------|-----------|-------------|--|
| Type | Order No. | Pcs. / Pkt. | |
| VIP-2/SC/HD15SUB/M | 2322326 | 1 | |
| VIP-3/SC/HD26SUB/M | 2322375 | 1 | |
| VIP-3/SC/HD44SUB/M | 2322388 | 1 | |
| VIP-3/SC/HD62SUB/M | 2322391 | 1 | |
| VIP-2/SC/HD15SUB/F | 2322401 | 1 | |
| VIP-3/SC/HD26SUB/F | 2322414 | 1 | |
| VIP-3/SC/HD44SUB/F | 2322427 | 1 | |
| VIP-3/SC/HD62SUB/F | 2322430 | 1 | |

| Ordering data | | | |
|--------------------|-----------|-------------|--|
| Type | Order No. | Pcs. / Pkt. | |
| VIP-2/PT/HD15SUB/M | 2904268 | 1 | |
| VIP-3/PT/HD26SUB/M | 2904269 | 1 | |
| VIP-3/PT/HD44SUB/M | 2904270 | 1 | |
| VIP-3/PT/HD62SUB/M | 2904271 | 1 | |
| VIP-2/PT/HD15SUB/F | 2904272 | 1 | |
| VIP-3/PT/HD26SUB/F | 2904273 | 1 | |
| VIP-3/PT/HD44SUB/F | 2904274 | 1 | |
| VIP-3/PT/HD62SUB/F | 2904275 | 1 | |

VARIOFACE wiring interface

Modules for plug-in connectors IEC 60603/DIN 41612

These VARIOFACE interface modules connect high-position plug-in connectors according to IEC 60603/DIN 41612 to screw connection terminal blocks.

The following VARIOFACE modules are available:

- **UMK** modules with double-level connection terminal blocks
- **UMKS** modules with three-level connection terminal blocks.

Notes:

For suitable cable housings, see the table on page 562

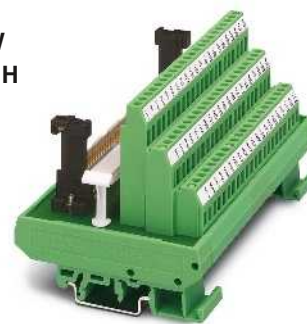

**Design C,
64-position, a, c assembled**



Technical data

| | |
|--|---|
| Operating voltage | 125 V AC/DC |
| Max. perm. current (per branch) | 1 A |
| Ambient temperature (operation) | -20°C ... 50°C |
| Mounting position | Any |
| Standards/regulations | IEC 60664, DIN EN 50178, IEC 62103 |
| Connection data solid / stranded / AWG | 0.2 - 4 mm ² / 0.2 - 2.5 mm ² / 24 - 12 |
| Dimensions | H / D 77 mm / 72 mm |

Ordering data

| Description | No. of pos. | Module width W | Type | Order No. | Pcs. / Pkt. |
|---|-------------|----------------|----------------------|----------------|-------------|
| VARIOFACE module, C 64-pos., screw-on cable housing, with: | | | | | |
| - Pin strip | 64 | 135.00 | UMKS- C64M-VS | 2970565 | 1 |
| VARIOFACE module, E 48-pos., screw-on cable housing, with: | | | | | |
| - Pin strip | 48 | 123.80 | | | |
| VARIOFACE module, F 48-pos., screw-on cable housing, with: | | | | | |
| - Pin strip | 48 | 112.50 | | | |
| VARIOFACE module, F 48-pos., snap-on cable housing, with: | | | | | |
| - Pin strip | 48 | 112.50 | | | |
| VARIOFACE module, D 32-pos., screw-on cable housing, with: | | | | | |
| - Pin strip | 32 | 135.00 | | | |

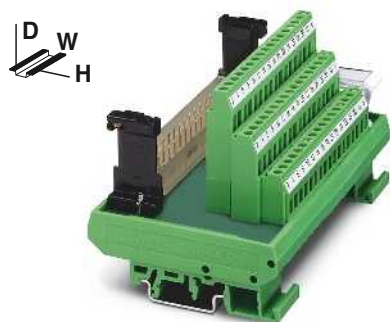

Design E,
48-position, a, c, e assembled

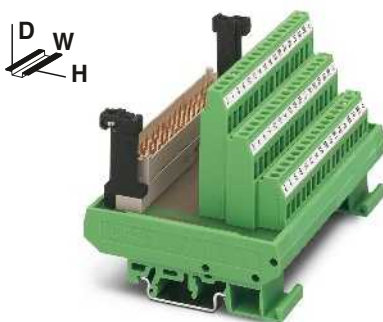

Design F,
48-position, z, b, d assembled

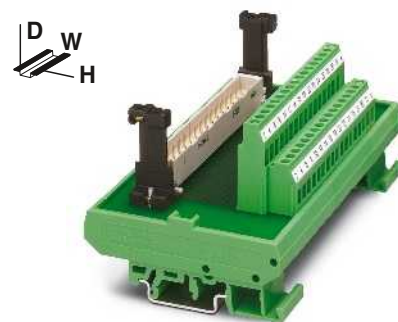

Design D,
32-position, a, c assembled



| Technical data |
|---|
| 125 V AC/DC |
| 4 A |
| -20°C ... 50°C |
| Any |
| IEC 60664, DIN EN 50178, IEC 62103 |
| 0.2 - 4 mm ² / 0.2 - 2.5 mm ² / 24 - 12 |
| 77 mm / 72 mm |

| Technical data |
|---|
| 250 V AC |
| 4 A |
| -20°C ... 45°C |
| Any |
| IEC 60664, DIN EN 50178, IEC 62103 |
| 0.2 - 4 mm ² / 0.2 - 2.5 mm ² / 24 - 12 |
| 77 mm / 72 mm |

| Technical data |
|---|
| 250 V AC/DC |
| 2 A |
| -20°C ... 50°C |
| Any |
| IEC 60664, DIN EN 50178, IEC 62103 |
| 0.2 - 4 mm ² / 0.2 - 2.5 mm ² / 24 - 12 |
| 77 mm / 62.5 mm |

| Ordering data | | |
|---------------|-----------|-------------|
| Type | Order No. | Pcs. / Pkt. |
| UMKS- E48M-VS | 2970154 | 1 |

| Ordering data | | |
|---------------|-----------|-------------|
| Type | Order No. | Pcs. / Pkt. |
| UMKS- F48M-VS | 2970714 | 1 |
| UMKS- F48M-VR | 2970167 | 1 |

| Ordering data | | |
|---------------|-----------|-------------|
| Type | Order No. | Pcs. / Pkt. |
| UMK- D32M-VS | 2970060 | 1 |

System cabling for controllers

VARIOFACE wiring interface

Modules for ELCO plug-in connectors

Notes:
Dimensional drawings and pin assignments, see page 562

These modules can be used to connect ELCO plug-in connectors of the 8016 series to screw connection terminal blocks.

The diagonal position of the ELCO plug-in connector means that the wires leading out of the cable housing at the side can be led away without restricting neighboring modules.

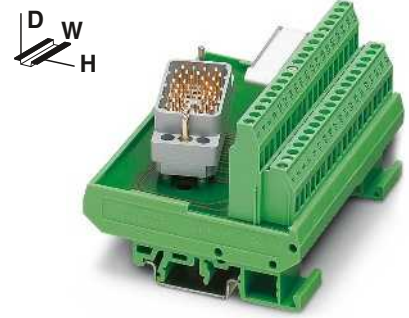

38-pos.



| | |
|--|-------|
| Operating voltage | |
| Max. perm. current (per branch) | |
| Total current | |
| Ambient temperature (operation) | |
| Mounting position | |
| Standards/regulations | |
| Connection data solid / stranded / AWG | |
| Dimensions | H / D |

| Technical data | |
|---|--|
| 25 V AC / 60 V DC | |
| 1.5 A | |
| 19 A (38 branches with 0.5 A each) | |
| -20°C ... 40°C | |
| Any | |
| IEC 60664, DIN EN 50178, IEC 62103 | |
| 0.2 - 4 mm ² / 0.2 - 2.5 mm ² / 24 - 12 | |
| 77 mm / 58.5 mm | |

| Description | No. of pos. | Module width W |
|--------------------------------|-------------|----------------|
| VARIOFACE module, with: | | |
| - Pin strip 8016 right | 38 | 101.50 |
| - Pin strip 8016 left | 38 | 101.50 |
| VARIOFACE module, with: | | |
| - Pin strip 8016 right | 56 | 157.50 |
| - Pin strip 8016 left | 56 | 157.50 |
| VARIOFACE module, with: | | |
| - Pin strip 8016 right | 56 | 77.00 |
| - Pin strip 8016 left | 56 | 77.00 |
| VARIOFACE module, with: | | |
| - Pin strip 8016 right above | 32 | 101.30 |
| - Pin strip 8016 right below | 32 | 101.30 |
| - Pin strip 8016 left above | 32 | 101.30 |
| - Pin strip 8016 left below | 32 | 101.30 |

| Ordering data | | |
|------------------|-----------|-------------|
| Type | Order No. | Pcs. / Pkt. |
| UMK- EC38/38-XOR | 2976297 | 1 |
| UMK- EC38/38-XOL | 2976284 | 1 |

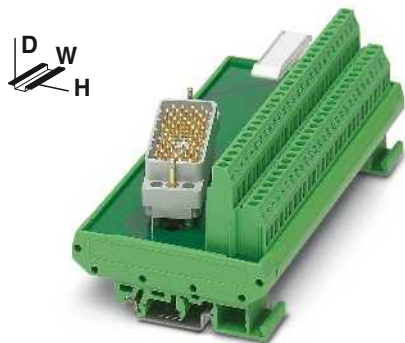

56-pos.



56-pos.,
with front connection terminal blocks



32-pos.



Technical data

125 V AC/DC
1.5 A
28 A (56 branches with 0.5 A each)
-20°C ... 50°C
Any
IEC 60664, DIN EN 50178, IEC 62103
0.2 - 4 mm² / 0.2 - 2.5 mm² / 24 - 12
77 mm / 58.5 mm

Technical data

< 25 V AC / 30 V DC
1.5 A
28 A (56 branches with 0.5 A each)
-20°C ... 50°C
Any
IEC 60664, DIN EN 50178, IEC 62103
0.2 - 2.5 mm² / 0.2 - 1.5 mm² / 26 - 16
146.3 mm / 47.5 mm

Technical data

25 V AC / 60 V DC
2 A
32 A (32 branches with 1 A each)
-20°C ... 40°C
Any
IEC 60664, DIN EN 50178, IEC 62103
0.2 - 4 mm² / 0.2 - 2.5 mm² / 24 - 12
77 mm / 58.5 mm

Ordering data

| Type | Order No. | Pcs. / Pkt. |
|------------------|-----------|-------------|
| UMK- EC56/56-XOR | 2975900 | 1 |
| UMK- EC56/56-XOL | 2975890 | 1 |

Ordering data

| Type | Order No. | Pcs. / Pkt. |
|------------------------|-----------|-------------|
| UMK- EC56/FRONT 2,5V/R | 2976161 | 1 |
| UMK- EC56/FRONT 2,5V/L | 2976158 | 1 |

Ordering data

| Type | Order No. | Pcs. / Pkt. |
|------------------|-----------|-------------|
| UMK- EC56/32-XOR | 2975858 | 1 |
| UMK- EC56/32-XUR | 2975777 | 1 |
| UMK- EC56/32-XOL | 2975764 | 1 |
| UMK- EC56/32-XUL | 2975780 | 1 |

VARIOFACE wiring interface

Modules for ELCO plug-in connectors for use in Ex i circuits

The VARIOFACE modules connect ELCO plug-in connectors of the 8016 series to screw connection terminal blocks. The modules for ELCO connectors can be used as simple electrical equipment for applications in intrinsically safe circuits as per EN 60079-14. They fulfill the requirements of intrinsic safety as per EN 60079-11 (EN 50020) and can be used for various intrinsically safe circuits taking into account the pin configuration.

The voltage of an intrinsically safe circuit may not exceed 30 V. The voltage difference between two intrinsically safe circuits can be up to 60 V.

The modules are equipped with blue screw connection methods are clear labeling for intrinsically safe circuits.

The arrangement of angled ELCO plug-in connectors makes it possible to lead the lines led out from the cable housing away from the adjacent modules without any negative effects.

For the disconnection of intrinsically safe and non-intrinsically safe circuits, a distance of at least 50 mm should be kept between the connection points using partition plates or spaces.

| Notes: |
|--|
| Dimensional drawings and pin assignments, see page 563 |
| Facts about explosion protection, see page 154 |

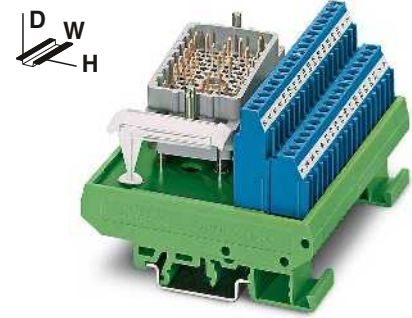

32-pos.

| | |
|--|-------|
| Operating voltage | |
| Max. perm. current (per branch) | |
| Ambient temperature (operation) | |
| Mounting position | |
| Standards/regulations | |
| Connection data solid / stranded / AWG | |
| Dimensions | H / D |

| Technical data |
|---|
| max. 30 V DC (Max. voltage between two intrinsically safe circuits: 60 V DC) |
| 500 mA |
| -20°C ... 50°C |
| Any |
| DIN EN 60079-11 |
| 0.2 - 4 mm ² / 0.2 - 2.5 mm ² / 24 - 12 |
| 77 mm / 58.5 mm |

| Description | No. of pos. | Module width W |
|--------------------------------|-------------|----------------|
| VARIOFACE module, with: | | |
| - Pin strip 8016 right above | 32 | 101.30 |
| - Pin strip 8016 right below | 32 | 101.30 |
| - Pin strip 8016 left above | 32 | 101.30 |
| - Pin strip 8016 left below | 32 | 101.30 |
| VARIOFACE module, with: | | |
| - Pin strip 8016 right | 25 | 78.80 |
| - Pin strip 8016 left | 25 | 78.80 |
| VARIOFACE module, with: | | |
| - Pin strip 8016 right | 25 | 77.00 |
| - Pin strip 8016 left | 25 | 77.00 |

| Ordering data | | |
|----------------------------|----------------|-------------|
| Type | Order No. | Pcs. / Pkt. |
| UMK- EC90/32/EX-XOR | 2900109 | 1 |
| UMK- EC90/32/EX-XUR | 2969068 | 1 |
| UMK- EC90/32/EX-XOL | 2900110 | 1 |
| UMK- EC90/32/EX-XUL | 2969071 | 1 |

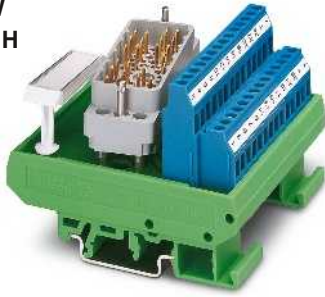

25-pos.

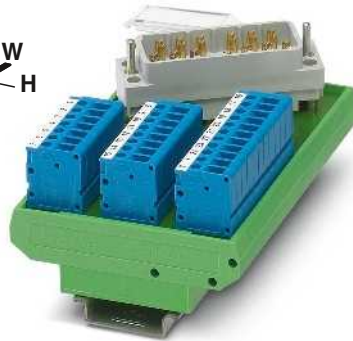

25-pos.,
with front connection terminal blocks

Technical data

max. 30 V DC
(Max. voltage between two intrinsically safe circuits: 60 V DC)
500 mA
-20°C ... 50°C
Any
DIN EN 60079-11
0.2 - 4 mm² / 0.2 - 2.5 mm² / 24 - 12
77 mm / 58.5 mm

Ordering data

| Type | Order No. | Pcs. / Pkt. |
|--------------------|-----------|-------------|
| UMK- EC56/25/EX -R | 2900112 | 1 |
| UMK- EC56/25/EX -L | 2900113 | 1 |

Technical data

max. 30 V DC
(Max. voltage between two intrinsically safe circuits: 60 V DC)
500 mA
-20°C ... 50°C
Any
DIN EN 60079-11
0.2 - 2.5 mm² / 0.2 - 2.5 mm² / 24 - 14
112.5 mm / 52.5 mm

Ordering data

| Type | Order No. | Pcs. / Pkt. |
|-------------------------------|-----------|-------------|
| UMK- EC56/25/EX -FRONT 2,5V/R | 2900114 | 1 |
| UMK- EC56/25/EX -FRONT 2,5V/L | 2900115 | 1 |

System cabling for controllers

VARIOFACE wiring interface

Modules with RJ45 plug-in connector

- 1:1 connection
- 8-positions, RJ45 connector
- Screw or push-in connection (direct plug-in technology)
- Connector housing led to separate connection terminal blocks

Notes:
For marking systems (e.g., "ZB 22:UNBEDRUCKT"; Order No. 0811862) and mounting material, see Catalog 5.



8-pos.
with screw connection



8-pos.
with push-in connection

N



Technical data

Operating voltage
Max. perm. current (per branch)
Ambient temperature (operation)
Mounting position
Standards/regulations
Connection data solid / stranded / AWG
Dimensions

48 V AC/DC
1 A
-20°C ... 50°C
Any
DIN EN 50178
0.2 - 4 mm² / 0.2 - 2.5 mm² / 24 - 12
69 mm / 62 mm

H / D

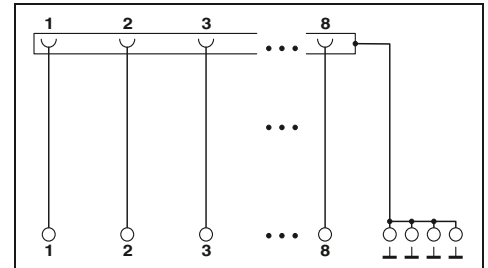

Technical data

48 V AC/DC
1 A
-20°C ... 50°C
Any
EN 50178
0.14 - 2.5 mm² / 0.14 - 2.5 mm² / 26 - 14
75.8 mm / 63 mm

Ordering data

| Description | No. of pos. | Module width W |
|---|-------------|----------------|
| VARIOFACE module , with RJ45 plug-in connector | | |
| With screw connection | 8 | 26.90 |
| With push-in connection | 8 | 26.60 |

| Type | Order No. | Pcs. / Pkt. |
|---------------|-----------|-------------|
| VIP-3/SC/RJ45 | 2900701 | 1 |

Ordering data

| Type | Order No. | Pcs. / Pkt. |
|---------------|-----------|-------------|
| VIP-3/PT/RJ45 | 2904290 | 1 |

Modules with COMBICON connection

- The slim 10- and 18-pos. VARIOFACE SLIM-LINE modules connect the front connection terminal blocks to a COMBICON header. The corresponding COMBICON plugs (5.0 mm pitch) can be found in the COMBICON catalog PCB Connection Technique.
- The 32-pos. UMK-32 MDSTB/MKKDS 3/R module connects screw connection terminal blocks with coded COMBICON plug-in screw connectors.



10- and 18-pos.
With screw connection



32-pos.
With screw connection



Technical data

250 V AC/DC
2.5 A
-10°C ... 50°C
Any
IEC 60664, DIN EN 50178, IEC 62103
45 mm / 25 mm

Ordering data

| Type | Order No. | Pcs. / Pkt. |
|-----------------------|-----------|-------------|
| UM 25-10 MSTB/FRONT/Q | 2959803 | 1 |
| UM 25-18 MSTB/FRONT/Q | 2959502 | 1 |

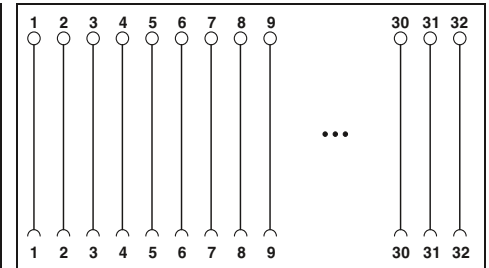

Technical data

250 V AC/DC
3 A
-20°C ... 50°C
Any
IEC 60664, DIN EN 50178, IEC 62103
58.5 mm / 112.5 mm

Ordering data

| Type | Order No. | Pcs. / Pkt. |
|-----------------------|-----------|-------------|
| UMK-32 MDSTB/MKKDS3/R | 2970196 | 1 |

Operating voltage
Max. perm. current (per branch)
Ambient temperature (operation)
Mounting position
Standards/regulations
Dimensions

D / W

| Description | No. of pos. | Module height H |
|---|-------------|------------------|
| VARIOFACE-SLIM-LINE module, with a COMBICON header (without a COMBICON plug-in connector) | 10 18 | 137.00 217.00 |
| VARIOFACE module, with COMBICON plug-in connector, coded | 32 | 77.00 |

VARIOFACE wiring interface

Modules as compact potential distributors

The VIP-2/.../PDM... modules offer the following features:

- Two potential levels
- Separate supply
- Screw or push-in connection
- Consecutive labeling

The UMK-PVB and UMK-PVB 6 modules have three or six potential levels.

Notes:
Marking systems and mounting material
See Catalog 5



With screw connection and 2 potential levels

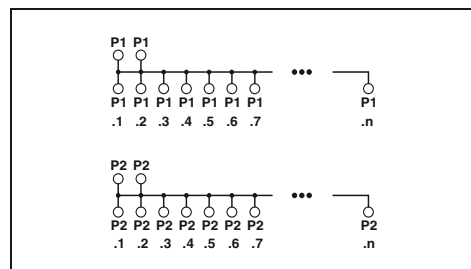

Technical data

| | |
|---|---|
| Operating voltage | 250 V AC/DC |
| Max. perm. current (per branch) | 15 A |
| Total current | 30 A (Per potential) |
| Ambient temperature (operation) | -20°C ... 50°C |
| Mounting position | Any |
| Standards/regulations | IEC 60664, DIN EN 50178, IEC 62103 |
| Supply connection data solid / stranded / AWG | 0.2 - 6 mm ² / 0.2 - 4 mm ² / 24 - 10 |
| Distribution connection data solid / stranded / AWG | 0.2 - 4 mm ² / 0.2 - 2.5 mm ² / 24 - 12 |
| Dimensions | H / D 65.5 mm / 50 mm |

Ordering data

| Description | No. of pos. | Module width W | Type | Order No. | Pcs. / Pkt. |
|---|-------------|----------------|--------------------------|----------------|-------------|
| VARIOFACE module , with two busbars (P1, P2) for potential distribution, per potential: | | | | | |
| 2 power terminal blocks/ 8 distributor terminal blocks | | 50.00 | VIP-2/SC/PDM-2/16 | 2315256 | 1 |
| 2 power terminal blocks/ 12 distributor terminal blocks | | 70.40 | VIP-2/SC/PDM-2/24 | 2315269 | 1 |
| 2 power terminal blocks/ 16 distributor terminal blocks | | 90.80 | VIP-2/SC/PDM-2/32 | 2315272 | 1 |
| 2 power terminal blocks/ 24 distributor terminal blocks | | 131.50 | VIP-2/SC/PDM-2/48 | 2903717 | 1 |
| VARIOFACE module , with three busbars (+, -, PE) for potential distribution, per potential: | | | | | |
| (+) two power terminal blocks/48 distributor terminal blocks (-) two power terminal blocks/24 distributor terminal blocks (PE) 2 power/72 distributor terminal blocks | | 168.80 | | | |
| VARIOFACE module , with six busbars (P1 to P6) for potential distribution, per potential: | | | | | |
| 2 power terminal blocks/ 12 distributor terminal blocks | | 123.80 | | | |
| VARIOFACE module , with two busbars (P1, P2) for potential distribution, per potential: | | | | | |
| 2 power terminal blocks/ 8 distributor terminal blocks | | 41.90 | | | |
| 2 power terminal blocks/ 12 distributor terminal blocks | | 57.10 | | | |
| 2 power terminal blocks/ 16 distributor terminal blocks | | 67.30 | | | |
| 2 power terminal blocks/ 24 distributor terminal blocks | | 97.70 | | | |



With screw connection and 3 potential levels



With screw connection and 6 potential levels

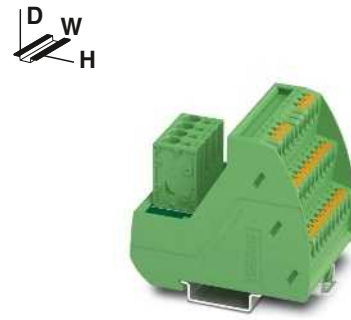

With push-in three-level connection and 2 potential levels



Technical data

250 V AC/DC
 16 A
 16 A (Per potential)
 -20°C ... 50°C
 Any
 IEC 60664, DIN EN 50178, IEC 62103
 0.5 - 6 mm² / 0.5 - 4 mm² / 20 - 10

 0.2 - 4 mm² / 0.2 - 2.5 mm² / 24 - 12

 77 mm / 72 mm

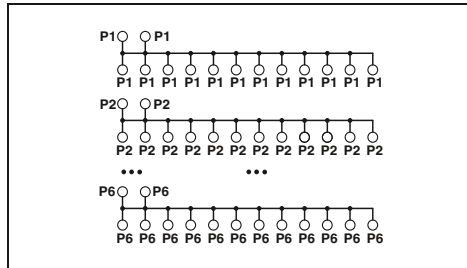

Technical data

250 V AC/DC
 16 A
 16 A (Per potential)
 -20°C ... 50°C
 Any
 IEC 60664, DIN EN 50178, IEC 62103
 0.2 - 6 mm² / 0.2 - 4 mm² / 24 - 10

 0.2 - 4 mm² / 0.2 - 2.5 mm² / 24 - 12

 77 mm / 72 mm

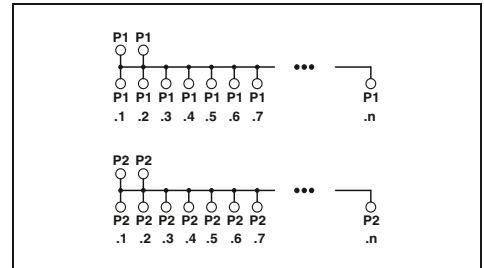

Technical data

250 V AC/DC
 15 A
 30 A (Per potential)
 -20°C ... 50°C
 Any
 IEC 60664, DIN EN 50178, IEC 62103
 0.25 - 6 mm² / 0.25 - 4 mm² / 24 - 10

 0.14 - 2.5 mm² / 0.14 - 2.5 mm² / 26 - 14

 75.8 mm / 63 mm

Ordering data

| Type | Order No. | Pcs. / Pkt. |
|----------|-----------|-------------|
| UMK- PVB | 2971302 | 1 |

Ordering data

| Type | Order No. | Pcs. / Pkt. |
|------------|-----------|-------------|
| UMK- PVB 6 | 2972136 | 1 |

Ordering data

| Type | Order No. | Pcs. / Pkt. |
|-------------------|-----------|-------------|
| VIP-3/PT/PDM-2/16 | 2903797 | 1 |
| VIP-3/PT/PDM-2/24 | 2903798 | 1 |
| VIP-3/PT/PDM-2/32 | 2903799 | 1 |
| VIP-3/PT/PDM-2/48 | 2903800 | 1 |

System cabling for controllers

VARIOFACE wiring interface

VARIOFACE modules for plug-in miniature relays and/or miniature solid-state relays

The UMK-... RM 4-, 8-, and 16-way relay or solid-state relay interfaces provide 4, 8 or 16 slots for standard electromechanical relays (REL-MR..., not REL-MR...MS) or optoelectronic relays (SIM-El...). The connections between the I/O module and the electronics, as well as the process cabling, are implemented via screw connection terminal blocks.



4-channel with bridge rectifier



4-channel for relays with a PDT contact

| |
|--|
| Notes: |
| For the protection of relay coils and contacts, inductive loads must be dampened with an efficient protection circuit. |
| Other input voltages on request. |
| 1) not with 230 V AC. |
| 2) with 230 V AC glow lamp. |
| 3) with 100 V DC and 230 V AC glow lamp. |

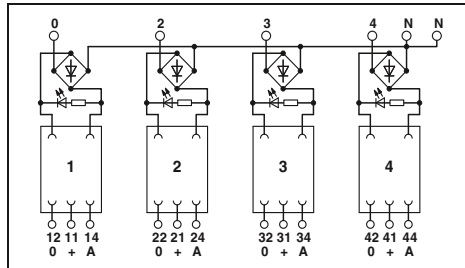

Technical data

| | |
|--|---|
| Coil side | |
| Tolerance of the input voltage | ±10% |
| Input circuit | Bridge rectifier |
| Operating voltage display | - |
| Status display/channel | Yellow LED |
| Connection method | Screw connection |
| Connection data solid / stranded / AWG | 0.2 ... 4 mm ² / 0.2 ... 2.5 mm ² / 24 - 12 |
| Contact side | |
| Contact type | 1 PDT |
| Max. switching voltage | 250 V AC/DC |
| Limiting continuous current | 6 A |
| Connection method | Screw connection |
| Connection data solid / stranded / AWG | 0.2 ... 4 mm ² / 0.2 ... 2.5 mm ² / 24 - 12 |
| General data | |
| Test voltage | 2.5 kV (50 Hz, 1 min.) |
| Ambient temperature (operation) | -20°C ... 50°C |
| Standards/regulations | DIN VDE 0110 |
| Mounting position | Any |
| Dimensions | W / H / D 67.5 mm / 77 mm / 59 mm |

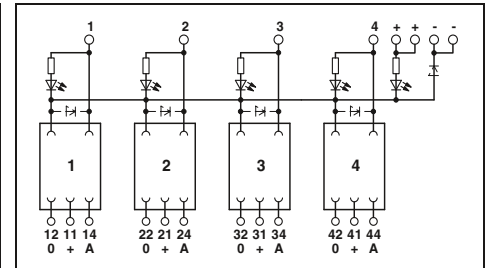

Technical data

| | |
|--|---|
| Description | Input voltage |
| VARIOFACE module , for four plug-in miniature relays or miniature solid-state relays, with light indicator (without relays) | 24 V AC/DC |
| VARIOFACE module , for plug-in miniature relays or miniature solid-state relays, with light indicator (without relay) | 5 V DC 12 V DC 24 V DC 48 V DC 110 V DC 230 V AC |

| Ordering data | | |
|---------------|-----------|-------------|
| Type | Order No. | Pcs. / Pkt. |
| UMK- 4 RM 24 | 2971344 | 1 |

| Ordering data | | |
|----------------|-----------|-------------|
| Type | Order No. | Pcs. / Pkt. |
| UMK- 4 RM 5DC | 2972819 | 1 |
| UMK- 4 RM 12DC | 2972822 | 1 |
| UMK- 4 RM 24DC | 2972835 | 1 |
| UMK- 4 RM 60DC | 2972851 | 1 |
| UMK- 4 RM110DC | 2972864 | 1 |
| UMK- 4 RM230AC | 2972880 | 1 |

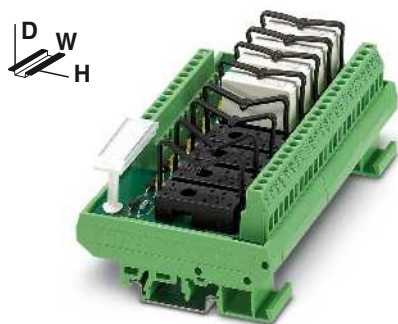

8-channel for relays with a PDT contact

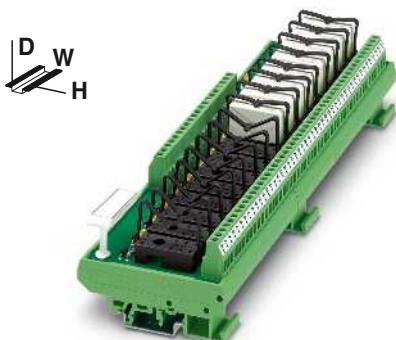

16-channel for relays with a PDT contact

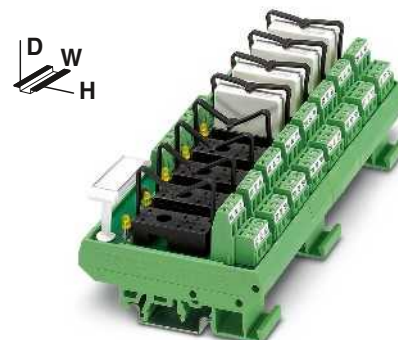

8-channel for relays with two PDT contacts

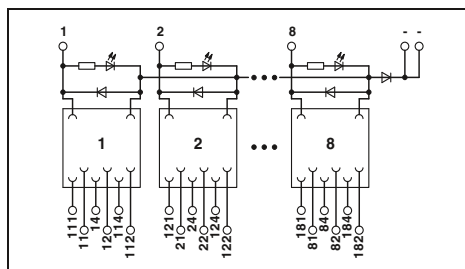
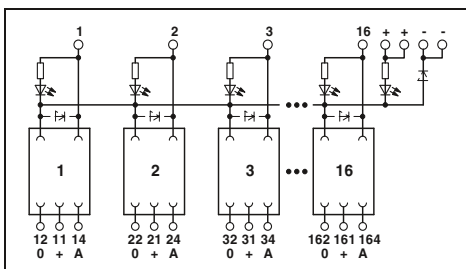
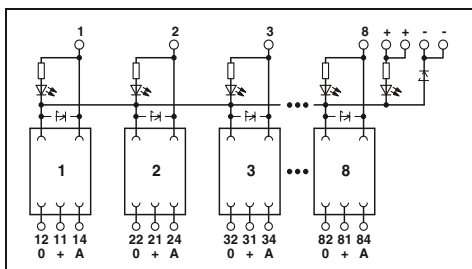

Technical data

±10%
Freewheeling diode, Protection against polarity reversal
Yellow LED²⁾

Yellow LED³⁾

Screw connection
0.2 ... 4 mm² / 0.2 ... 2.5 mm² / 24 - 24

1 PDT
250 V AC
5 A
Screw connection
0.2 ... 4 mm² / 0.2 ... 2.5 mm² / 24 - 12

2.5 kV (50 Hz, 1 min.)
-20°C ... 50°C
DIN VDE 0110
Any
135 mm / 77 mm / 59 mm

Technical data

±10%
Freewheeling diode, Protection against polarity reversal
Yellow LED²⁾

Yellow LED³⁾

Screw connection
0.2 ... 4 mm² / 0.2 ... 2.5 mm² / 24 - 24

1 PDT
250 V AC
5 A
Screw connection
0.2 ... 4 mm² / 0.2 ... 2.5 mm² / 24 - 12

2.5 kV (50 Hz, 1 min.)
-20°C ... 50°C
DIN VDE 0110
Any
259 mm / 77 mm / 59 mm

Technical data

±10%
Freewheeling diode, Protection against polarity reversal
-

Yellow LED

Screw connection
0.14 ... 1.5 mm² / 0.14 ... 1.5 mm² / 26 - 26

2 PDT
250 V AC
5 A
Screw connection
0.14 ... 1.5 mm² / 0.14 ... 1.5 mm² / 26 - 14

2.5 kV (50 Hz, 1 min.)
-20°C ... 50°C
DIN VDE 0110
Any
168.8 mm / 77 mm / 59 mm

Ordering data

| Type | Order No. | Pcs. / Pkt. |
|---------------------|-----------|-------------|
| UMK- 8 RM 5DC/MKDS | 2972893 | 1 |
| UMK- 8 RM 12DC/MKDS | 2972903 | 1 |
| UMK- 8 RM24DC/MKDS | 2972916 | 1 |
| UMK- 8 RM 60DC/MKDS | 2972932 | 1 |
| UMK- 8 RM110DC/MKDS | 2972945 | 1 |
| UMK- 8 RM230AC/MKDS | 2972961 | 1 |

Ordering data

| Type | Order No. | Pcs. / Pkt. |
|---------------------|-----------|-------------|
| UMK-16 RM 5DC/MKDS | 2972974 | 1 |
| UMK-16 RM 12DC/MKDS | 2972987 | 1 |
| UMK-16 RM 24DC/MKDS | 2972990 | 1 |
| UMK-16 RM 60DC/MKDS | 2973038 | 1 |
| UMK-16 RM110DC/MKDS | 2973041 | 1 |
| UMK-16 RM230AC/MKDS | 2973067 | 1 |

Ordering data

| Type | Order No. | Pcs. / Pkt. |
|--------------------------|-----------|-------------|
| UMK- 8 RELS/KSR-24/21/21 | 2975722 | 1 |

System cabling for controllers

VARIOFACE wiring interface

VARIOFACE modules as interface for plug-in solid-state relays or digital I/O modules

The 1-, 4-, 8- or 16-time INTERFACE modules are the wiring interface and the coupling level in one unit. The connection to the interface module is established using screw connection technology.

Properties of the single interface:

- Status display
- Protection against polarity reversal in input
- Surge protection in input
- Assembly option with solid-state relay for loads up to 350 V DC/1 A or 480 V AC/5 A

Properties of the 4-, 8-, and 16-time interfaces:

- Status display
- Integrated fuse for line protection
- Assembly option with solid-state relay or I/O modules

| Notes: |
|--|
| Type of housing: Polyamide PA non-reinforced, color: green. |
| Marking systems and mounting material See Catalog 5 |
| For the protection of relay coils and contacts, inductive loads must be dampened with an efficient protection circuit. |
| Solid-state relays, see page 558 |

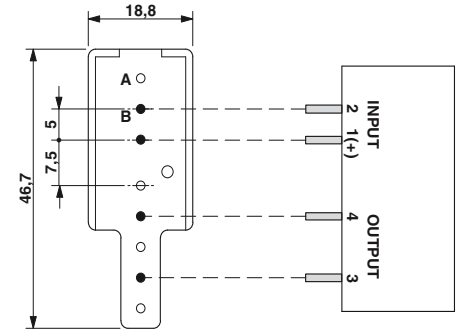

A = without metal
B = with metal

| |
|--|
| Input data |
| Input voltage range |
| Input circuit |
| Status display/channel |
| Connection method |
| Connection data solid / stranded / AWG |
| Output data |
| Connection method |
| Connection data solid / stranded / AWG |
| General data |
| Ambient temperature (operation) |
| Standards/regulations |
| Mounting position |
| Mounting |
| Dimensions |

H / D

| Description | Module width W |
|--|-------------------|
| Interface module , with plug-in base for one solid-state relay, with locking clip | 22.5 |
| Interface module , with plug-in base for four solid-state relays, with locking clip Microfuse: 250 V, 4 A | 90 |
| Interface module , with plug-in base for eight digital I/O modules. Microfuse: 250 V, 4 A | 180 |
| Interface module , with plug-in base for eight solid-state relays, with locking clip Microfuse: 250 V, 4 A | 180 |
| Interface module , with plug-in base for 16 digital I/O modules. Microfuse: 250 V, 4 A | 326.5 |
| Interface module , with plug-in base for 16 solid-state relays, with locking clip Microfuse: 250 V, 4 A | 326.5 |

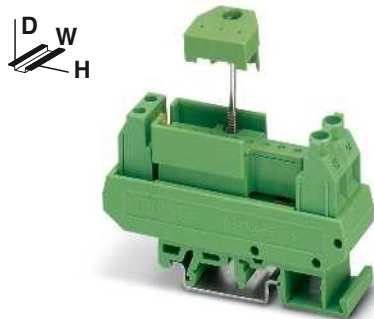

With light indicator

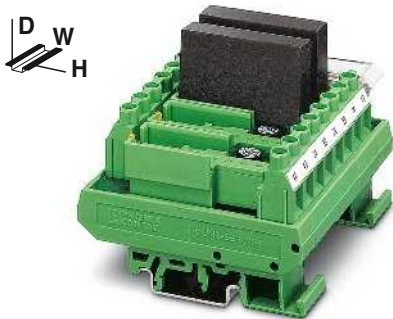

With light indicator and fuse,
control logic negative switching

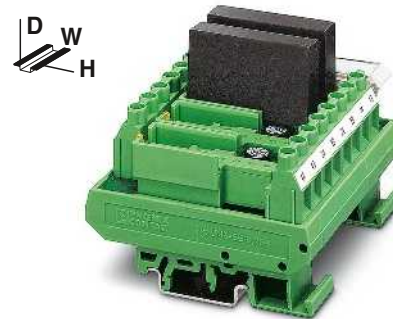

With light indicator and fuse,
control logic positive switching

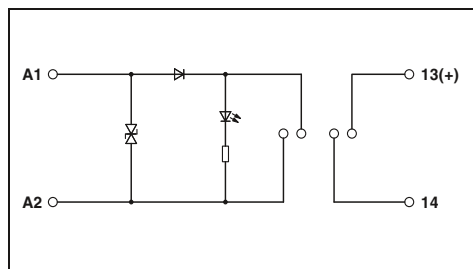
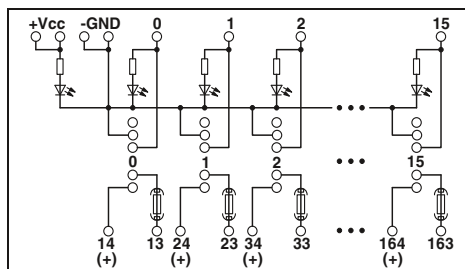

Technical data

4 V ... 32 V
 Protection against polarity reversal, Surge protection
 Yellow LED
 Screw connection
 0.2 ... 4 mm² / 0.2 ... 2.5 mm² / 24 - 12
 Screw connection
 0.2 ... 6 mm² / 0.2 ... 4 mm² / 24 - 10
 -20°C ... 60°C
 DIN EN 50178
 Any
 In rows with zero spacing
 77 mm / 72 mm

Technical data

4 V ... 32 V
 Yellow LED
 Screw connection
 0.2 ... 4 mm² / 0.2 ... 2.5 mm² / 24 - 24
 Screw connection
 0.2 ... 6 mm² / 0.2 ... 4 mm² / 24 - 10
 -20°C ... 55°C
 DIN VDE 0110b, Gr. C for 250 V DC, DIN VDE 0160
 (in relevant parts)
 Any
 In rows with zero spacing
 77 mm / 72 mm

Technical data

4 V ... 32 V
 Yellow LED
 Screw connection
 0.2 ... 4 mm² / 0.2 ... 2.5 mm² / 24 - 24
 Screw connection
 0.2 ... 6 mm² / 0.2 ... 4 mm² / 24 - 10
 -20°C ... 55°C
 DIN VDE 0110b, Gr. C for 250 V DC, DIN VDE 0160
 (in relevant parts)
 Any
 In rows with zero spacing
 77 mm / 72 mm

Ordering data

| Type | Order No. | Pcs. / Pkt. |
|-----------------|-----------|-------------|
| UMK- 1 OM-R/AMS | 2983002 | 1 |

Ordering data

| Type | Order No. | Pcs. / Pkt. |
|---------------------|-----------|-------------|
| UMK- 4 OM-R/MF | 2970882 | 1 |
| UMK- 8 OM/MF/MKDS | 2972712 | 1 |
| UMK- 8 OM-R/MF/MKDS | 2972738 | 1 |
| UMK-16 OM/MF/MKDS | 2972754 | 1 |
| UMK-16 OM-R/MF/MKDS | 2972770 | 1 |

Ordering data

| Type | Order No. | Pcs. / Pkt. |
|-----------------------|-----------|-------------|
| UMK- 4 OM-R/MF/P | 2972673 | 1 |
| UMK- 8 OM-R/MF/MKDS/P | 2972699 | 1 |
| UMK-16 OM-R/MF/MKDS/P | 2972796 | 1 |

REL-MR miniature relay

The robust relays are used as interface relays throughout process and production engineering.

The main features of these relays are their compact design, reliable electrical isolation, and compliance with the most important standards, as well as the number of variants.

| Notes: |
|---|
| If the specified maximum values for multi-layer contact relays are exceeded, the gold plating is destroyed. The maximum values of the power contact relay are then valid. This can result in a shorter service life than with a pure power contact. |
| For diagrams of operating voltage ranges, see page 344 |



1 N/O contact

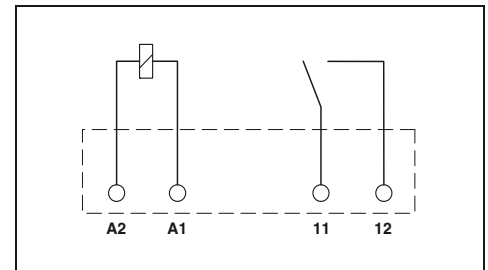

| Input data | |
|---|--|
| Permissible range (with reference to U_N) | - |
| Permissible range (with reference to U_N) | 0.8 - 1.1 |
| Typ. input current at U_N | [mA] 5 |
| Typ. response time at U_N | [ms] 5 |
| Typ. response time at U_N (depending on phase relation) | [ms] |
| Typ. release time at U_N | [ms] 2 |
| Typ. release time at U_N (depending on phase relation) | [ms] |
| Output data | |
| Contact type | Double contact, 1 N/O contact |
| Contact material | AgNi, hard gold-plated |
| Max. switching voltage | 250 V AC / 125 V DC |
| Min. switching voltage | 5 V DC |
| Limiting continuous current | 3 A |
| Max. inrush current | 5 A |
| Max. interrupting rating, ohmic load | 250 V AC |
| General data | |
| Test voltage (winding / contact) | 2 kV AC (50 Hz, 1 min.) |
| Test voltage (contact/contact) | - |
| Ambient temperature (operation) | -40°C ... 85°C |
| Nominal operating mode | 100% operating factor |
| Mechanical service life | Approx. 2×10^7 cycles |
| Standards/regulations | DIN VDE 0110, IEC 255/DIN VDE 0435 (in relevant parts) |
| Mounting position/mounting | Any |
| Dimensions | W / H / D 5 mm / 23 mm / 17 mm |

Technical data

| Ordering data | | |
|---------------|-----------|-------------|
| Type | Order No. | Pcs. / Pkt. |
| REL-MR-G 24/1 | 2961037 | 8 |

| Description | Input voltage U_N |
|---------------------------------------|---------------------|
| Plug-in miniature power relays | |
| with power contact | ① 12 V DC |
| with power contact | ② 24 V DC |
| with power contact | ③ 48 V DC |
| with power contact | ④ 60 V DC |
| with power contact | ⑤ 110 V DC |
| with power contact | ⑥ 230 V AC |
| Plug-in miniature power relays | |
| with gold contact | ① 12 V DC |
| with gold contact | ② 24 V DC |
| with gold contact | ③ 48 V DC |
| with gold contact | ④ 60 V DC |
| with gold contact | ⑤ 110 V DC |
| with gold contact | ⑥ 230 V AC |



1 PDT for high continuous currents



2 PDT

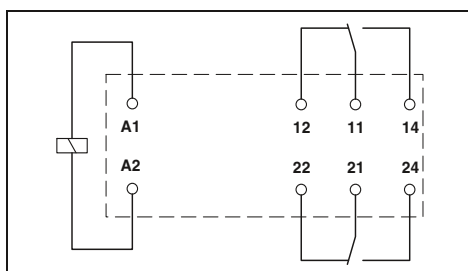
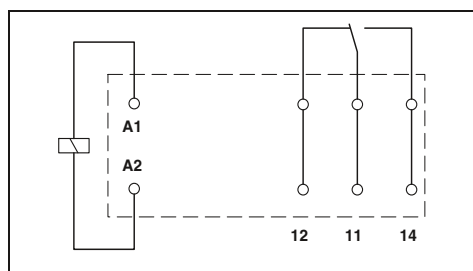

Technical data

Technical data

① ② ③ ④ ⑤ ⑥
refer to the diagram

① ② ③ ④ ⑤ ⑥
refer to the diagram

| | | | | | |
|----|----|-----|-----|-----|--------|
| 33 | 17 | 8.7 | 8.2 | 4.1 | 3 |
| 7 | 7 | 7 | 7 | 7 | |
| | | | | | 3 - 12 |
| 3 | 3 | 3 | 3 | 3 | |
| | | | | | 2 - 9 |

| | | | | | |
|----|----|-----|-----|-----|--------|
| 33 | 17 | 8.7 | 8.2 | 4.1 | 3 |
| 7 | 7 | 7 | 7 | 7 | |
| | | | | | 3 - 12 |
| 3 | 3 | 3 | 3 | 3 | |
| | | | | | 2 - 9 |

Single contact, 1-PDT

Single contact, 1-PDT

Single contact, 2-PDT

Single contact, 2-PDT

AgNi
250 V AC/DC
12 V (at 10 mA)
16 A
30 A (300 ms)

AgNi, hard gold-plated
30 V AC / 36 V DC
100 mV (at 10 mA)
50 mA
50 mA

AgNi
250 V AC/DC
5 V (at 10 mA)
8 A
25 A (20 ms)

AgNi, hard gold-plated
30 V AC / 36 V DC
100 mV (at 10 mA)
50 mA
50 mA

4000 VA

-

2000 VA

-

5 kV AC (50 Hz, 1 min.)

-

5 kV AC (50 Hz, 1 min.)

2.5 kV AC (50 Hz, 1 min.)

-40°C ... 85°C

-40°C ... 85°C

100% operating factor

100% operating factor

3 x 10⁷ cycles

3 x 10⁷ cycles

IEC 60664, EN 50178, IEC 62103

IEC 60664, EN 50178, IEC 62103

Any / Can be aligned without spacing (> 70°C ≥ 2.5 mm)

Any / Can be aligned without spacing (> 70°C ≥ 2.5 mm)

12.7 mm / 29 mm / 15.7 mm

12.7 mm / 29 mm / 15.7 mm

Ordering data

Ordering data

| Type | Order No. | Pcs. / Pkt. |
|----------------------|-----------|-------------|
| REL-MR- 12DC/21HC | 2961309 | 10 |
| REL-MR- 24DC/21HC | 2961312 | 10 |
| REL-MR- 48DC/21HC | 2834821 | 10 |
| REL-MR- 60DC/21HC | 2961325 | 10 |
| REL-MR-110DC/21HC | 2961338 | 10 |
| REL-MR-230AC/21HC | 2961422 | 10 |
| REL-MR- 12DC/21HC AU | 2961532 | 10 |
| REL-MR- 24DC/21HC AU | 2961545 | 10 |
| REL-MR-110DC/21HC AU | 2961561 | 10 |
| REL-MR-230AC/21HC AU | 2961529 | 10 |

| Type | Order No. | Pcs. / Pkt. |
|----------------------|-----------|-------------|
| REL-MR- 12DC/21-21 | 2961257 | 10 |
| REL-MR- 24DC/21-21 | 2961192 | 10 |
| REL-MR- 48DC/21-21 | 2834834 | 10 |
| REL-MR- 60DC/21-21 | 2961273 | 10 |
| REL-MR-110DC/21-21 | 2961202 | 10 |
| REL-MR-230AC/21-21 | 2961451 | 10 |
| REL-MR- 12DC/21-21AU | 2961299 | 10 |
| REL-MR- 24DC/21-21AU | 2961215 | 10 |
| REL-MR- 48DC/21-21AU | 2834847 | 10 |
| REL-MR- 60DC/21-21AU | 2961286 | 10 |
| REL-MR-110DC/21-21AU | 2961228 | 10 |
| REL-MR-230AC/21-21AU | 2961480 | 10 |

SIM-EI miniature solid-state relay

The SIM-EI miniature solid-state relays have connections compatible with commercially available miniature switching relays and are of the same shape.

The modules are used for floating conditioning of process signals as an alternative to electromechanical relays. Substituting mechanical relays for solid-state ones opens new possibilities for solving interface problems in a user-friendly way. The compatibility of the pins with the mechanical relay permits use of solid-state relays without any changes in the layout. The output of the solid-state relay is "high active" and designed as a 2- or 3-conductor output.



with DC voltage output
max. = 100 mA

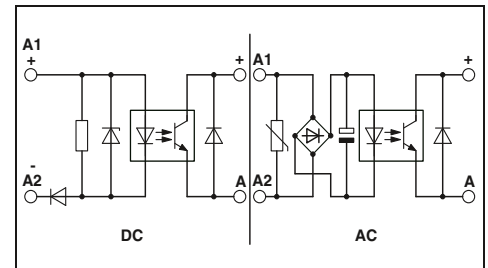

Technical data

| Input data | | ① | ② | ③ | ④ | ⑤ | ⑥ | ⑦ | ⑧ | |
|--|----------------|--|------------|------------|-------------|------------|------------|------------|------------|--|
| Permissible range (with reference to U_N) | | 0.9 - 1.1 | 0.9 - 1.1 | 0.9 - 1.1 | 0.9 - 1.1 | 0.9 - 1.1 | 0.9 - 1.1 | 0.9 - 1.1 | 0.9 - 1.1 | |
| Switching level with reference to U_N | 1 signal ("H") | ≥ 0.8 | ≥ 0.8 | ≥ 0.8 | ≥ 0.8 | ≥ 0.8 | ≥ 0.8 | ≥ 0.8 | ≥ 0.8 | |
| | 0 signal ("L") | ≤ 0.35 | ≤ 0.4 | ≤ 0.4 | ≤ 0.25 | ≤ 0.4 | ≤ 0.4 | ≤ 0.4 | ≤ 0.4 | |
| Typ. input current at U_N | [mA] | 5.4 | 5.7 | 5.1 | 6.8 | 2.4 | 2.6 | 2.1 | 2.1 | |
| Transmission frequency f_{limit} | [Hz] | 600 | 600 | 600 | 600 | 300 | 300 | 3 | 3 | |
| Input circuit AC | | Protection against polarity reversal, Surge protection | | | | | | | | |
| Input circuit DC | | Protection against polarity reversal | | | | | | | | |
| Output data | | 8 V DC ... 48 V DC | | | | | | | | |
| Operating voltage range | | 100 mA | | | | | | | | |
| Limiting continuous current | | 1 V | | | | | | | | |
| Residual voltage drop at "H" | | - | | | | | | | | |
| Max. inrush current | | 2-conductor, floating | | | | | | | | |
| Output circuit | | Protection against polarity reversal | | | | | | | | |
| Output protection | | 2.5 kV (50 Hz, 1 min.) | | | | | | | | |
| General data | | -20°C ... 50°C | | | | | | | | |
| Test voltage input/output | | DIN VDE 0110 | | | | | | | | |
| Ambient temperature (operation) | | Any / Can be aligned with 2 mm spacing | | | | | | | | |
| Standards/regulations | | 13 mm / 29 mm / 25 mm | | | | | | | | |
| Mounting position/mounting | | | | | | | | | | |
| Dimensions | W / H / D | | | | | | | | | |

Ordering data

| Description | Input voltage U_N | Type | Order No. | Pcs. / Pkt. |
|--|---------------------|-----------------------|-----------|-------------|
| Solid-state relay , with protective circuit in the input and output circuit | ① 5 V DC | SIM-EI- 5DC/48DC/100 | 2271057 | 10 |
| | ② 12 V DC | SIM-EI- 12DC/48DC/100 | 2271060 | 10 |
| | ③ 24 V DC | SIM-EI- 24DC/48DC/100 | 2271073 | 10 |
| | ④ 60 V DC | SIM-EI- 60DC/48DC/100 | 2271086 | 10 |
| | ⑤ 110 V DC | SIM-EI-110DC/48DC/100 | 2271099 | 10 |
| | ⑥ 220 V DC | SIM-EI-220DC/48DC/100 | 2271109 | 10 |
| | ⑦ 120 V AC | SIM-EI-120AC/48DC/100 | 2271112 | 10 |
| | ⑧ 230 V AC | SIM-EI-230AC/48DC/100 | 2271125 | 10 |

Accessories

| Accessories | Order No. | Pcs. / Pkt. |
|---|-----------|-------------|
| Plug-in base , for plug-in miniature relays or miniature solid-state relays, for soldering onto the printed circuit board. | | |
| Retaining bracket , for miniature solid-state relay | | |
| - Plastic | 2271484 | 100 |
| - Metal | | |
| Retaining bracket , for miniature relay | | |
| - Plastic | 2271468 | 10 |
| - Metal | 2271497 | 10 |
| | 2271471 | 10 |
| | 2271510 | 10 |

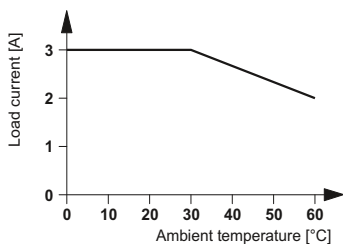

Derating curve for SIM-EI-OV-24 DC/24 DC/3



with TTL logic level output,
max. = 100 mA



with DC voltage output
Maximum = 100 mA, RC element in input



with DC voltage output
max. = 3 A

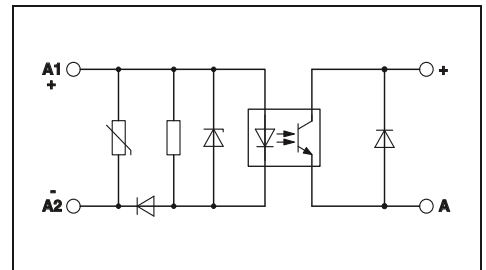
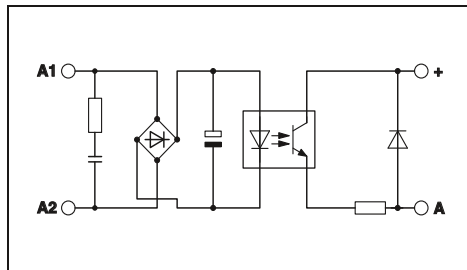
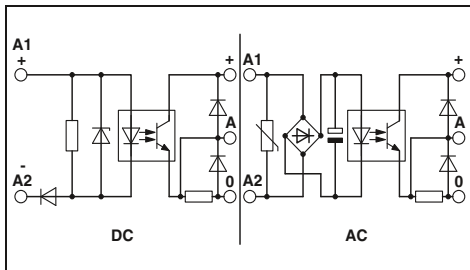

Technical data

| ① | ② | ③ | ④ | ⑤ | ⑥ | ⑦ | ⑧ |
|-----------|-----------|-----------|-----------|-----------|-----------|-----------|-----------|
| 0.9 - 1.1 | 0.9 - 1.1 | 0.9 - 1.1 | 0.9 - 1.1 | 0.9 - 1.1 | 0.9 - 1.1 | 0.9 - 1.1 | 0.9 - 1.1 |
| ≥ 0.8 | ≥ 0.8 | ≥ 0.8 | ≥ 0.8 | ≥ 0.8 | ≥ 0.8 | ≥ 0.8 | ≥ 0.8 |
| ≤ 0.35 | ≤ 0.4 | ≤ 0.4 | ≤ 0.25 | ≤ 0.4 | ≤ 0.4 | ≤ 0.4 | ≤ 0.4 |
| 5.4 | 5.7 | 5.1 | 4.7 | 2.4 | 2.6 | 2.1 | 2.1 |
| 4000 | 4000 | 4000 | 4000 | 1000 | 1000 | 3 | 3 |

Protection against polarity reversal, Surge protection
Protection against polarity reversal

3 V DC ... 5.25 V DC
100 mA
0.3 V

-
3-conductor, ground-referenced
Protection against polarity reversal, Free running

2.5 kV (50 Hz, 1 min.)
-20°C ... 50°C
DIN VDE 0110
Any / Can be aligned with 2 mm spacing
13 mm / 29 mm / 25 mm

Technical data

| ⑦ | ⑧ |
|-----------|-----------|
| 0.9 - 1.1 | 0.9 - 1.1 |
| ≥ 0.8 | ≥ 0.8 |
| ≤ 0.4 | ≤ 0.4 |
| 2.2 | 2.5 |
| 3 | 3 |

RC element

8 V DC ... 48 V DC
100 mA
1 V

-
2-conductor, floating
Protection against polarity reversal

2.5 kV (50 Hz, 1 min.)
-20°C ... 50°C
DIN VDE 0110
Any / Can be aligned with 2 mm spacing
13 mm / 29 mm / 25 mm

Technical data

| ③ |
|-----------|
| 0.8 - 1.2 |
| ≥ 0.8 |
| ≤ 0.4 |
| 7 |
| 300 |

Protection against polarity reversal, Surge protection

3 V DC ... 33 V DC
3 A (see derating curve)
≤ 200 mV

15 A (10 ms)
2-conductor, floating
Protection against polarity reversal, Surge protection

2.5 kV (50 Hz, 1 min.)
-20°C ... 60°C
DIN VDE 0110
Any / Can be aligned with 2 mm spacing
13 mm / 29 mm / 25 mm

Ordering data

| Type | Order No. | Pcs. / Pkt. |
|----------------------|-----------|-------------|
| SIM-EI- 5DC/TTL/100 | 2271138 | 10 |
| SIM-EI- 12DC/TTL/100 | 2271141 | 10 |
| SIM-EI- 24DC/TTL/100 | 2271154 | 10 |
| SIM-EI- 60DC/TTL/100 | 2271167 | 10 |
| SIM-EI-110DC/TTL/100 | 2271170 | 10 |
| SIM-EI-220DC/TTL/100 | 2271183 | 10 |
| SIM-EI-120AC/TTL/100 | 2271196 | 10 |
| SIM-EI-230AC/TTL/100 | 2271206 | 10 |

Ordering data

| Type | Order No. | Pcs. / Pkt. |
|--------------------------|-----------|-------------|
| SIM-EI-120AC/48DC/100/RC | 2271439 | 10 |
| SIM-EI-230AC/48DC/100/RC | 2271426 | 10 |

Ordering data

| Type | Order No. | Pcs. / Pkt. |
|-------------------------|-----------|-------------|
| SIM-EI-OV- 24DC/ 24DC/3 | 2300096 | 10 |

Accessories

| Type | Order No. | Pcs. / Pkt. |
|---------------------|-----------|-------------|
| SIM-ERSN | 2271484 | 100 |
| SIM-ERSN-HB-KSR | 2271468 | 10 |
| SIM-ERSN-HB-KSR/MET | 2271497 | 10 |
| SIM-ERSN-HB-MR | 2271471 | 10 |
| SIM-ERSN-HB-MR/MET | 2271510 | 10 |

Accessories

| Type | Order No. | Pcs. / Pkt. |
|---------------------|-----------|-------------|
| SIM-ERSN | 2271484 | 100 |
| SIM-ERSN-HB-KSR | 2271468 | 10 |
| SIM-ERSN-HB-KSR/MET | 2271497 | 10 |
| SIM-ERSN-HB-MR | 2271471 | 10 |
| SIM-ERSN-HB-MR/MET | 2271510 | 10 |

Accessories

| Type | Order No. | Pcs. / Pkt. |
|---------------------|-----------|-------------|
| SIM-ERSN | 2271484 | 100 |
| SIM-ERSN-HB-KSR | 2271468 | 10 |
| SIM-ERSN-HB-KSR/MET | 2271497 | 10 |
| SIM-ERSN-HB-MR | 2271471 | 10 |
| SIM-ERSN-HB-MR/MET | 2271510 | 10 |

OV solid-state relay

Solid-state relays for electrical isolation can be mounted directly on the printed circuit board as interfaces or plugged in using the SIM-AMS solder-in socket.

The solid-state relays are suitable for switching ohmic, capacitive or inductive loads. Relays for switching AC circuits have a zero voltage switch to switch the load on in the zero voltage crossing. It is switched off in the zero current crossing. The integrated RC element permits operation up to $\cos \phi = 0.5$.

Inductive DC loads must be equipped with a fast-acting freewheeling diode for semiconductor relay protection.

- Switching capacity up to 350 V DC/1 A, 60 V DC/4 A or 480 V AC/5 A
- No wear and tear even with high switching frequencies
- No contact bounce – no movable parts
- No electromagnetic interference
- Electrically insulated housings
- Small dimensions
- High test voltage of 4 kV between control and load circuits

| Notes: |
|---|
| For derating curves see page 564 |
| For suitable bases, see page 560 |
| ¹⁾ Turn-on/off time at U_N : Max. ½ period |



with DC voltage output
max. = 1 A

RLIS

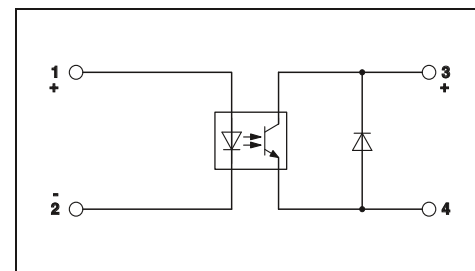

Technical data

| | |
|------------------------------------|--|
| Input data | ① |
| Input voltage range | 4.25 V DC ... 32 V DC |
| Switching level | 3.3 |
| | 1 signal ("H") [V DC] ≥ 3.3 |
| | 0 signal ("L") [V DC] ≤ 1 |
| Typ. input current at U_N | [mA] 15 |
| Typ. switch-on time at U_N | [µs] 100 |
| Typ. switch-off time at U_N | [µs] 250 |
| Transmission frequency f_{limit} | [Hz] 100 |
| Output data | |
| Operating voltage range | 1 V DC ... 350 V DC |
| Periodic peak reverse voltage | - |
| Limiting continuous current | 1 A (see derating curve) |
| Min. load current | 1 mA |
| Surge current | 20 A (tp = 1 s) |
| Residual voltage drop at "H" | 0.5 V |
| Leakage current in off state | 100 µA |
| Phase angle (cos φ) | - |
| Max. load value | - |
| Output protection | Protection against polarity reversal |
| General data | |
| Test voltage input/output | 4 kV (50 Hz, 1 min.) |
| Ambient temperature (operation) | -20°C ... 80°C |
| Standards/regulations | EN 61000-4-2, EN 61000-4-3, EN 61000-4-4, EN 55011 |
| Mounting position/mounting | Any / Can be aligned with > 9 mm spacing |
| Dimensions | 10.5 mm / 43 mm / 25.4 mm |

Ordering data

| Description | Input voltage U_N | Type | Order No. | Pcs. / Pkt. |
|---|---------------------|-----------------|-----------|-------------|
| Solid-state relay for signal amplification and electrical isolation of the control and load circuits, can be plugged into the solder-in plug-in base SIM-AMS or with PCB connection for direct mounting onto the PCB. Input: DC voltage Output: DC voltage | ① 24 V DC | OV-24DC/350DC/1 | 2982634 | 10 |
| Solid-state relay , same as before, however Input: DC voltage Output: AC voltage | ① 24 V DC | | | |



with DC voltage output
max. = 4 A



with AC voltage output
max. = 5 A

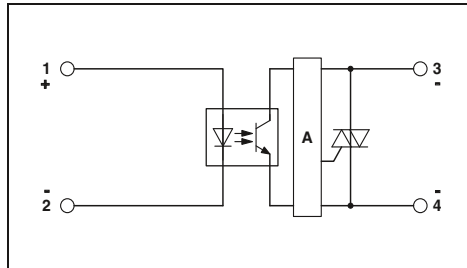

Technical data

①
4.25 V DC ... 32 V DC
3.3
1
15
100
250
100

1 V DC ... 60 V DC
-
4 A (see derating curve)
1 mA
25 A (tp = 1 s)
0.5 V
100 μ A
-
-
Protection against polarity reversal

4 kV (50 Hz, 1 min.)
-20°C ... 80°C
EN 61000-4-2, EN 61000-4-3, EN 61000-4-4, EN 55011

Any / Can be aligned with > 20 mm spacing
10.5 mm / 43 mm / 25.4 mm

Ordering data

| Type | Order No. | Pcs. / Pkt. |
|-----------------|-----------|-------------|
| OV-24DC/ 60DC/4 | 2982647 | 10 |

Technical data

①
4 V DC ... 32 V DC
3.5
1.2
10
25

12 V AC ... 530 V AC (45/65 Hz)
1000 V
5 A (see derating curve)
20 mA
80 A (tp = 20 ms)
1.2 V
< 1 mA
0.5
50 A²s
-

4 kV (50 Hz, 1 min.)
-20°C ... 70°C
EN 61000-4-2, EN 61000-4-3, EN 61000-4-4, EN 61000-4-5,
EN 61000-4-6

Any / Can be aligned with > 20 mm spacing
10.5 mm / 43 mm / 25.4 mm

Ordering data

| Type | Order No. | Pcs. / Pkt. |
|-----------------|-----------|-------------|
| OV-24DC/480AC/5 | 2982650 | 10 |

Solder-in socket for solid-state relays and I/O modules

Modern interface solutions for computer and electronic controls are increasingly being designed as I/O systems which are system-independent and individually mountable. Electrical isolation and signal conditioning are carried out using standard I/O modules. These are produced by various manufacturers in pin-compatible versions for different functions. The I/O modules are either soldered directly into the PCB or plugged into component sockets for quick interchanging.

SIM sockets facilitate the plugging of I/O modules considerably. All standard I/O modules and solid-state relays with up to eight connections can be plugged into the solder-in plug-in socket.

The I/O modules are securely fixed to the socket using fastening screws which are specific to the module. They are thereby protected against being accidentally released. Optocouplers, now also available in plug-in versions, are secured using the latch which is attached to the socket and which can be labeled. For better identification, each module plug position has its own marking panel on the socket.

The SIM socket has been designed so that it can be used on existing printed circuit boards without any layout modifications. Peripheral components such as LEDs or fuse resistors remain accessible to the user.

| Notes: |
|--|
| Type of housing: Polyamide PA non-reinforced, color: green. |
| Marking systems and mounting material See Catalog 5 |
| For dimensional drawings and pin assignments, see page 564 |
| 1) Applies only to the sockets SIM-AMS 1, SIM-AMS 1-R and SIM-AMSC in connection with the standard I/O modules with the corresponding AC voltage output. |

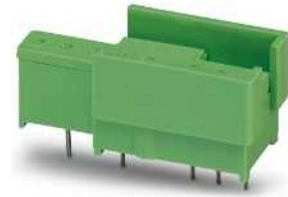

Plug-in base for solid-state relays

Operating voltage

Nominal current
Standards/regulations



Technical data

250 V AC / 380 V AC¹⁾

5 A
DIN VDE 0110b, Gr. C for 250 V DC

Ordering data

| Description | No. of pos. | Module width W |
|--|-------------|----------------|
| Plug-in base , for solid-state relay and I/O modules, with different numbers of contacts, can be labeled with marker pins BN or BNB | | |
| Partial assembly Complete assembly | | |
| Plug-in base , as above, however, with locking clips for fastening | | |
| Partial assembly Complete assembly | | |
| Plug-in base , for standard I/O modules of generation 4 of the company Opto 22, can be labeled using marker pins BN or BNB | | |
| Marker pin , made of white plastic, lettering area 7.5 x 4 mm, unprinted for self-marking with B-STIFT | | |
| Marker pen, not refillable , for manual labeling, line thickness 0.5 mm | | |

| Type | Order No. | Pcs. / Pkt. |
|-----------|-----------|-------------|
| SIM-AMS 1 | 2271015 | 10 |
| SIM-AMS 2 | 2271028 | 10 |

Accessories

| | | |
|---------|---------|-----|
| BN-TRK | 2701404 | 100 |
| B-STIFT | 1051993 | 10 |

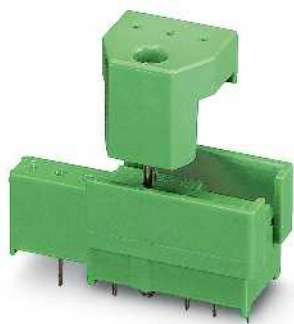

Plug-in base for solid-state relays with locking clip



Plug-in base for I/O modules



Technical data

250 V AC / 380 V AC¹⁾

5 A
DIN VDE 0110b, Gr. C for 250 V DC

Ordering data

| Type | Order No. | Pcs. / Pkt. |
|-------------|-----------|-------------|
| SIM-AMS 1-R | 2271031 | 10 |
| SIM-AMS 2-R | 2271044 | 10 |

Accessories

| | | |
|---------|---------|-----|
| BN-TRK | 2701404 | 100 |
| B-STIFT | 1051993 | 10 |

Technical data

250 V AC / 380 V AC¹⁾

5 A
DIN VDE 0110b, Gr. C for 250 V DC

Ordering data

| Type | Order No. | Pcs. / Pkt. |
|-----------|-----------|-------------|
| SIM-AMSC1 | 2271390 | 50 |

Accessories

| | | |
|---------|---------|-----|
| BN-TRK | 2701404 | 100 |
| B-STIFT | 1051993 | 10 |

System cabling for controllers

VARIOFACE wiring interface

Modules for IEC 60603/DIN 41612 plug-in connectors

Cable housing suitable for snap-lock mechanism:

| | | |
|--------------|---------------------------|--|
| Manufacturer | Type F 32- and 48-pos. | |
| HARTING | Types "B" and "D" | |

Cable housing suitable for screw locking:

| | | |
|--------------|-----------------|-----------------|
| Manufacturer | Type C, 64-pos. | Type D, 32-pos. |
| ERNI | KSG 173... | KSG 173... |
| AMP | 826196-1 | 826196-1 |

Cable housing suitable for screw locking:

| | | |
|--------------|-----------------|-------------------------|
| Manufacturer | Type E, 48-pos. | Type F, 32- and 48-pos. |
| ERNI | KSG 173... | KSG 203... |
| AMP | - | 826198-1 |

Modules for ELCO plug-in connectors

Dimensional drawing for UMK-EC38/38-XOL



Dimensional drawing for UMK-EC38/38-XOR



Dimensional drawing for UMK-EC56/56-XOL



Dimensional drawing for UMK-EC56/56-XOR



Dimensional drawing for UMK-EC56/FRONT 2,5V/R



Dimensional drawing for UMK-EC56/FRONT 2,5V/L

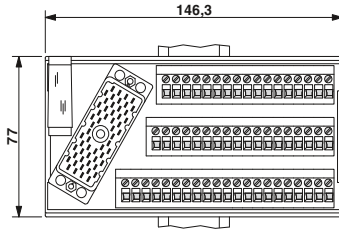

Dimensional drawing for UMK-EC56/32-XOL

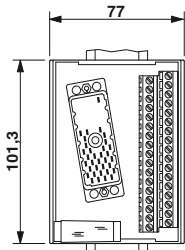

Dimensional drawing for UMK-EC56/32-XOR

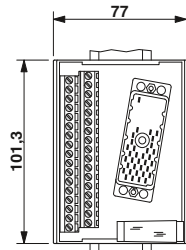

Pin assignment UMK-EC38/38...

| Terminal block | Pin strip |
|----------------|-----------|
| 1 | A |
| 2 | B |
| 3 | C |
| 4 | D |
| 5 | E |
| 6 | F |
| 7 | H |
| 8 | J |
| 9 | K |
| 10 | L |
| 11 | M |
| 12 | N |
| 13 | P |
| 14 | R |
| 15 | S |
| 16 | T |
| 17 | U |
| 18 | V |
| 19 | W |
| 20 | X |
| 21 | Y |
| 22 | Z |
| 23 | AA |
| 24 | BB |
| 25 | DD |
| 26 | EE |
| 27 | FF |
| 28 | HH |
| 29 | JJ |
| 30 | KK |
| 31 | LL |
| 32 | MM |
| 33 | NN |
| 34 | PP |
| 35 | RR |
| 36 | SS |
| 37 | TT |
| CC | CC |

Pin assignment UMK-EC56/56...

| Terminal block | Pin strip |
|----------------|------------|
| Z | Z |
| 1 | A |
| 2 | B |
| 3 | C |
| 4 | D |
| 5 | E |
| 6 | F |
| 7 | H |
| 8 | J |
| 9 | K |
| 10 | L |
| 11 | M |
| 12 | N |
| 13 | P |
| 14 | R |
| 15 | S |
| 16 | T |
| 17 | U |
| 18 | V |
| 19 | W |
| 20 | X |
| 21 | a |
| 22 | b |
| 23 | c |
| 24 | d |
| 25 | e |
| 26 | f |
| 27 | h |
| 28 | j |
| 29 | k |
| 30 | l |
| 31 | m |
| 32 | n |
| 33 | p |
| 34 | r |
| 35 | s |
| 36 | t |
| 37 | u |
| 38 | v |
| 39 | w |
| 40 | x |
| 41 | y |
| 42 | z |
| 43 | AA |
| 44 | BB |
| 45 | CC |
| 46 | DD |
| 47 | EE |
| 48 | FF |
| 49 | HH |
| 50 | JJ |
| 51 | KK |
| 52 | LL |
| 53 | MM |
| 54 | NN |
| Y | Y (shield) |

Modules for ELCO plug-in connectors with protection type Ex i

Pin assignment UMK-EC56/Front 2,5V/...

| Terminal block | ELCO plug |
|----------------|------------|
| X | N.C. |
| 1 | A |
| 2 | B |
| 3 | C |
| 4 | D |
| 5 | E |
| 6 | F |
| 7 | H |
| 8 | J |
| 9 | K |
| 10 | L |
| 11 | M |
| 12 | N |
| 13 | P |
| 14 | R |
| 15 | S |
| 16 | T |
| 17 | U |
| 18 | V |
| 19 | W |
| 20 | X |
| 21 | a |
| 22 | b |
| 23 | c |
| 24 | d |
| 25 | e |
| 26 | f |
| 27 | h |
| 28 | j |
| 29 | k |
| 30 | l |
| 31 | m |
| 32 | n |
| 33 | p |
| 34 | r |
| 35 | s |
| 36 | t |
| 37 | u |
| 38 | v |
| 39 | w |
| 40 | x |
| 41 | y |
| 42 | z |
| 43 | AA |
| 44 | BB |
| 45 | CC |
| 46 | DD |
| 47 | EE |
| 48 | FF |
| 49 | HH |
| 50 | JJ |
| 51 | KK |
| 52 | LL |
| 53 | MM |
| 54 | NN |
| Y | Y (shield) |

Pin assignment UMK-EC56/32-...

| Terminal block | ELCO plug |
|----------------|-----------|
| 1 | A |
| 2 | B |
| 3 | C |
| 4 | D |
| 5 | E |
| 6 | F |
| 7 | H |
| 8 | J |
| 9 | K |
| 10 | L |
| 11 | M |
| 12 | N |
| 13 | P |
| 14 | R |
| 15 | S |
| 16 | T |
| 17 | U |
| 18 | V |
| 19 | W |
| 20 | X |
| 21 | Z |
| 22 | a |
| 23 | b |
| 24 | c |
| 25 | d |
| 26 | e |
| 27 | f |
| 28 | h |
| 29 | j |
| 30 | k |
| 31 | l |
| 32 | m |
| Y | NN + Y |

Dimensional drawing for UMK-EC90/32/EX-XUL



Dimensional drawing for UMK-EC90/32/EX-XUR



Dimensional drawing for UMK-EC56/25/EX-L



Dimensional drawing for UMK-EC56/25/EX-R



Dimensional drawing for UMK-EC90/32/EX-XOL

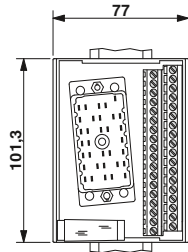

Dimensional drawing for UMK-EC90/32/EX-XOR

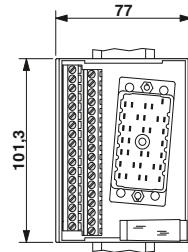

Dimensional drawing for UMK-EC 56/25/EX/Front 2,5 V/L

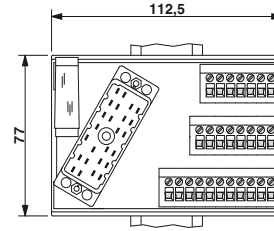

Dimensional drawing for UMK-EC 56/25/EX/Front 2,5 V/R

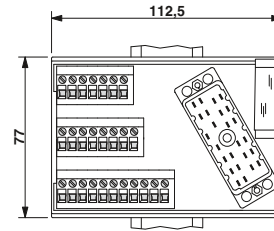

Pin assignment UMK-EC90/32/EX-...

| Terminal block | Pin strip | Channel |
|----------------|-----------|---------|
| 1 | H | |
| 2 | J | 1 |
| 3 | L | |
| 4 | M | 2 |
| 5 | P | |
| 6 | X | 3 |
| 7 | Z | |
| 8 | AA | 4 |
| 9 | AC | |
| 10 | AD | 5 |
| 11 | AM | |
| 12 | AN | 6 |
| 13 | AR | |
| 14 | AS | 7 |
| 15 | AU | |
| 16 | BC | 8 |
| 17 | AZ | |
| 18 | BA | 9 |
| 19 | BJ | |
| 20 | BK | 10 |
| 21 | BM | |
| 22 | BN | 11 |
| 23 | BR | |
| 24 | BY | 12 |
| 25 | CA | |
| 26 | CB | 13 |
| 27 | CD | |
| 28 | CE | 14 |
| 29 | CN | |
| 30 | CP | 15 |
| 31 | CS | |
| 32 | CT | 16 |
| Y | DS | |

Pin assignment UMK-EC 56/25/EX-...

| Terminal block | Pin strip | Channel |
|----------------|-----------|---------|
| 1 | C | |
| 2 | D | 1 |
| 3 | E | |
| 4 | F | 2 |
| 5 | N | |
| 6 | P | 3 |
| 7 | R | |
| 8 | S | 4 |
| 9 | a | |
| 10 | b | 5 |
| 11 | d | |
| 12 | j | 6 |
| 13 | k | |
| 14 | l | 7 |
| 15 | s | |
| 16 | t | 8 |
| 17 | u | |
| 18 | v | 9 |
| 19 | BB | |
| 20 | CC | 10 |
| 21 | DD | |
| 22 | EE | 11 |
| 23 | MM | |
| 24 | NN | 12 |
| Y | Y | |

System cabling for controllers

VARIOFACE wiring interface

OV solid-state relays

Load current depending on ambient temperature
Operating time: 100% OT

OV-24DC/350DC/1

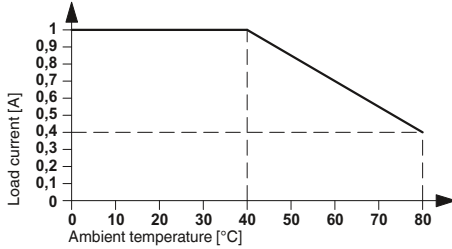

Dimensional drawing for SIM-AMS:

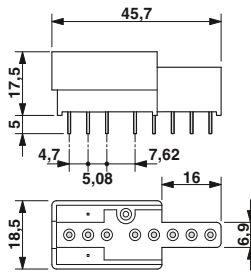

Dimensional drawing for SIM-AMSC:



OV-24DC/60DC/4



Dimensional drawing for SIM-AMS...R:



Contacts in the SIM-AMSC plug-in base:



- With metal
- Without metal

Note:
4th generation optocoupler, available from Opto 22.

OV-24DC/480AC/5

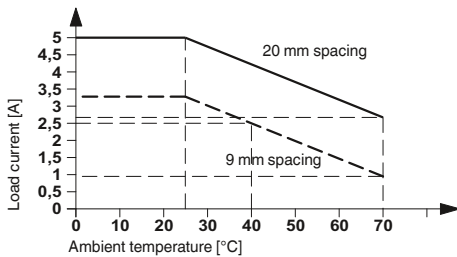

Contacts in the SIM-AMS plug-in base
1. Partial assembly for standard I/O modules

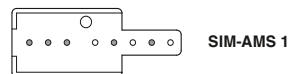

2. Complete assembly, e.g., for analog I/O modules

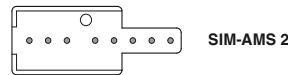

- With metal
- Without metal

Quality in quantity



Integrated management system

The aim of the Phoenix Contact integrated management system is to coordinate all the requirements regarding products, processes, and organization.

Statutory and regulatory requirements, as well as those of international standards and our customers, are met and, in some cases, even exceeded in all phases of the product life cycle.

In the Phoenix Contact management system, the integration of quality, environmental protection, and safety in the workplace is monitored each year for conformance by internationally recognized independent bodies. Certification in accordance with international standards ISO 9001, ISO 14001, and BS OHSAS 18001 is the result of our corporate philosophy of meeting the needs of our customers, staff, and environment as best as possible. They serve as the basis for innovative products with the familiar high Phoenix quality standard, actively practiced environmental protection, and responsibility in the field of occupational health and safety. Of course, we integrate all further requirements of standards, international approvals or special customer requirements into company processes.

This system provides a building block for the success of the Phoenix Contact Group and its products and services.

CE marking

The CE mark was introduced as an important instrument for the free movement of goods and services within the single European market. By attaching the mark to a product, the manufacturer confirms that it complies with all applicable European Union (EU) directives. EC directives describe the product properties with regard to device safety and avoiding danger. These are legally binding regulations of the European Union (EU). In other words, compliance with the requirements is a **statutory condition for marketing the product within the EU.**

Where applicable, the products that our company currently manufactures fall within the scope of the following directives:

- 2006/95/EC
Electrical equipment designed for use within certain voltage limits (Low Voltage Directive)
- 2004/108/EC
Electromagnetic compatibility (EMC Directive)
- 2006/42/EC
Safety of machinery (Machinery Directive)
- 94/9/EC
Equipment and protective systems intended for use in potentially explosive areas (ATEX Directive 100a)
- 1999/5/EC
Radio and telecommunications terminal equipment (R&TTE)

The standards upon which the specified directives are based have been part of our standard of development for a long time. This guarantees conformance with European directives. The numbers of the directives indicate their version at the time of publication. In the event of changes to directives and/or standards, our products will undergo conformity assessment again in good time and a new declaration of conformity will be issued promptly. The current declarations for each product can also be found in our Download Center.

The EMC Directive occupies a special place among the European directives listed. It defines electromagnetic compatibility as a fundamental property of devices based on mandatory guidelines. European Law therefore acknowledges the electromagnetic compatibility of devices and systems as an important condition for error-free operation of machinery and systems. Phoenix Contact is one of the leading international companies in surge protection, and therefore possesses broad expertise in EMC. This expertise and the experience gained over years of developing and applying industrial interface and communication technology have resulted in our products having an extremely high standard of quality with regard to electromagnetic compatibility. It was with a view to providing other companies with this expertise that our associate company, Phoenix Testlab, was founded. Phoenix Testlab GmbH is an independent, accredited service provider offering EMC testing that conforms to European standards. At Phoenix Testlab, devices are also tested with regard to their electrical safety, mechanical influences, and their behavior in relation to environmental influences. Furthermore, Phoenix Testlab is a “Notified Body” in accordance with EMC Directive 2004/108/EC and according to R&TTE Directive 1999/5/EC for radio and telecom-

munications terminal equipment. As a “Telecom Certification Body” (TCB), Phoenix Testlab may also approve these products for markets in the USA, Canada, and Japan.

Standards and regulations

All relevant standards and regulations are used as the basis for the development and maintenance of our products.

International standards are subject to continuous changes as a result of harmonization and new developments. In line with this process, the current version of all standards that are relevant to our products is documented in the product area on our website at www.phoenixcontact.net/products.

Online product information service on the web

Phoenix Contact's product range is growing constantly.

Due to our commitment to product monitoring, all products are subject to improvement.

The Internet is an ideal platform to quickly communicate new product developments and improvements to the market.

You can quickly access the relevant Phoenix Contact website for your region via www.phoenixcontact.com. Here, you will always find the latest overview of products, solutions, and services from Phoenix Contact. This includes technical documents, such as data sheets and user manuals, the latest driver and demo software, plus a means of contacting the appropriate contact person directly.

Shock protection



Back of hand safety

Example: pressure actuation

The accident prevention regulations BGV A 2 issued by the German employer's liability insurance association for precision mechanics and electrical engineering apply to the operators of electrical systems and are aimed at the prevention of electrical accidents by means of special safety requirements.

These regulations contain specifications regarding the safety distances for work, operation, and occasional handling in the proximity of "live parts" in low-voltage systems up to 1000 V ~ or 1500 V –.

– Work with live parts is only permitted once they have been de-energized. Operational activities are only permitted in the vicinity of live parts if these parts are de-energized or are protected against direct contact (§ 6).

The following safety measures apply when working in the vicinity of active components:

- Provision of the de-energized state for the duration of the work
- Ensure shock protection is in place in the form of covers or barriers during the work
- Assurance that proximity limits will not be violated (§ 7)

The term "occasional handling" has been introduced for the operation of elements such as pushbuttons, rocker arms or rotary buttons in the proximity of live parts.

In VDE 0105-1, this is covered by "operation with partial protection against direct contact".

Detailed specifications for "occasional handling" can be found in DIN VDE 0106-100. This specifies to what degree live parts in the proximity of operating elements are to be protected against contact. The basis for this is the definition of a "protection area for occasional handling"; this is the area into which the user must reach in order to handle the machine.

The most important thing is that an area formed by an even envelope curve 30 mm in radius must surround the live parts. This area must be **touch proof**, i.e., the live parts of the electrical device must not be within reach of the VDE test finger in accordance with IEC 60529/DIN VDE 0470-1 (test finger).

Back of hand safety is specified for the "rest of the area" up to 100 mm around the operating element. **Back of hand safety** means that when a force of 50 N is applied to a ball with a diameter of 50 mm, this does not come into contact with the live parts of the



equipment. No special measures for shock protection are provided outside this area.

Note: systems and equipment that are operated with SELV up to 25 V ~ or 60 V – are considered to be protected against direct contact.

According to § 5, Subsection 4 of the BGV A 2 regulations, there is no need to test the condition of the system prior to initial startup if the company has confirmation from the manufacturer or installer that the electrical



systems and equipment conform to BGV A 2. The confirmation required relates to systems and equipment that have been installed and are ready for operation and can only be issued

by the installer or installation company. The manufacturer of the electrical equipment can only issue a confirmation that products have been produced in accordance with the relevant electrotechnical DIN VDE regulations stipulated in BGV A 2. The installer must bear this in mind when selecting the equipment to be used.

In the field of connection technology, Phoenix Contact offers a wide range of products that are touch proof or that can be protected against contact using covers. Depending on the conditions, all of this must be taken into account when selecting the individual types of terminal block and accessories.

Quality features of insulating housing

Thermoplastics

The majority of our insulating housing is made from thermoplastic materials. Roughly speaking, these can be divided into amorphous and semi-crystalline substances. Thermoplastics are processed using the efficient and environmentally-friendly injection molding process. They have good recycling properties and can be re-used. We use many materials that are modified in different ways to meet the demanding requirements that electrical and electronic modules, devices, and systems have to meet with regard to their mechanical, thermal, and electrical properties.

Behavior of plastics under the influence of temperature (operating temperatures, mechanical influences)

All plastics undergo a process referred to as thermal aging when they are subjected to heat over long periods. This process causes changes in the mechanical and electrical properties of the material. External influences, e.g., radiation, additional mechanical, chemical or electrical stresses, amplify this effect. Special tests on samples can yield characteristic data which provides a good means of drawing comparisons between different plastics. However, applying these characteristics to an evaluation of molded plastic parts is only possible to a limited extent, and can only give the designer a rough guide when it comes to selecting a plastic material. This catalog uses the following assessment criteria: the **RTI value** according to UL746B/ANSI 746 B (elec. based on dielectric strength) and the **Ti value** according to IEC 60216-1 (based on a 50% reduction in tensile strength after 20,000 hours).

IEC 60947-7-1/EN 60947-7-1 specifies a permissible temperature increase of 45 K for modular terminal blocks under nominal load. Phoenix Contact terminal blocks meet this requirement.

The properties of plastics are not only affected by the influence of heat as described above; they also undergo changes as a result of cold influences. When subjected to cold as well as low levels of humidity, plastics become increasingly brittle with the result that they are no longer capable of withstanding the same mechanical loads. As the table on the right shows, the plastics concerned can be used down to a temperature of -40°C , but only without a mechanical load. As far as the products presented in the catalog are concerned, it is the ambient temperature specified in each case that is to be regarded as definitive for operation. Regardless of the plastics used, this may be subject to further restrictions (e.g., limited to -20°C) as a result of the components used or other restrictive parameters.

At very low temperatures, this means that any form of mechanical load on the plastic components must be avoided (e.g., mounting of products on/removal of products from the DIN rail, actuation of terminal points, locking/ejection of relays from bases, prizing out of plug-in bridges, bending of cables and lines, etc.), as there is always an associated risk of damage. Unless otherwise indicated, it is recommended that you carry out the specified mounting/operational tasks in a temperature range from -10°C to $+40^{\circ}\text{C}$.

Inflammability characteristics of plastics (UL 94)

Inflammability tests for plastics have been defined by Underwriters Laboratories (USA) in regulation UL 94. This applies to all areas of application, but in particular to electrical engineering. A horizontal or vertical test is carried out at the test laboratory to determine the inflammability of the plastic material with a naked flame. In order of increasing resistance to combustion, the evaluation classes are HB, V2, V1, V0, and 5V. Test results are recorded on "yellow cards" and are published annually in the **Recognized Component Directory**.

Thermoplastics: non-reinforced polyamide, PA

We use the modern, semi-crystalline polyamide insulation material, which has now become an essential component in electrical engineering and electronics. It has long occupied a leading position and is authorized for use by the relevant approval authorities such as the CSA, NEMKO, KEMA, PTB, SEV, UL, VDE, etc.

Polyamide also has excellent electrical, mechanical, chemical, and other properties, even at high operating temperatures. Brief peak temperatures up to approximately 200°C are permitted as a result of heat aging stabilization. Depending on the type (PA 4.6, 6.6, 6.10, etc.), its melting point is in the region of 215°C to 295°C .

Polyamide absorbs moisture from its surroundings, on average 2.8%. However, this moisture is not in the form of crystallization water in the plastic itself, but chemically bonded H_2O groups in the molecule structure. This makes the plastic flexible and resistant to breakage, even at temperatures as low as -40°C . According to UL 94, PA belongs to inflammability class V2 to V0.

Thermoplastics: polyester, PBT

We use the semi-crystalline thermoplastic polyester in non-reinforced and fiberglass-reinforced variants for special applications which require increased dimensional and form stability.

In addition to the high operating temperature, the material is characterized by excellent mechanical strength and hardness, and does not absorb moisture from its surroundings. PBT is therefore particularly suitable for strips, for example, which are soldered onto PCBs and subsequently have to pass a burn-in test while they are subjected to heat. According to UL 94, PBT belongs to inflammability class V2 to V0.

Thermoplastics: polycarbonate, PC

Polycarbonate combines many advantages such as rigidity, impact strength, transparency, dimensional stability, good insulation properties, and resistance to heat.

This amorphous material only absorbs moisture to a very limited degree, and is used for items such as large, rigid electronic component housing.

In its transparent form, polycarbonate is particularly suitable for use as cover profiles or marking materials.

PC has good resistance properties against mineral acids, saturated aliphatic hydrocarbons, gasoline, greases, and oils.

The material is less resistant to solvents, benzene, lyes, acetone, and ammonia. Strain cracks may result from contact with certain chemicals.

According to UL 94, PC belongs to inflammability class V2 to V0.

Thermoplastics: polycarbonate fiber-reinforced, PC-F

Compared to non-reinforced materials, fiber-reinforced polycarbonates feature greater rigidity, impact strength, and operating temperature. In other respects, their properties are largely identical to those of non-reinforced polycarbonate.

Thermoplastics: ABS

We use the thermoplastic molding compound ABS for products which must have good impact and notched impact properties in addition to high mechanical stability and rigidity. The products are resistant to chemicals and stress cracking due to their special surface quality and hardness.

The characteristic thermal properties provide good dimensional stability at both low and high temperatures. Products made from ABS can be coated with metallic surfaces, e.g., nickel.

According to UL 94, the molding compound used belongs to inflammability class HB to V0.

Dimensions: width / height / depth

The dimensions for “width / height / depth” are defined as follows for all DIN-rail-mountable products in the INTERFACE range:

- Width: measurement taken along the DIN rail
- Height: measurement taken across the DIN rail
- Depth: measurement taken starting from the mounting plate and including the NS 35/7,5 DIN rail (EN 60715)

The width, height, and depth never change, even if the products shown in this catalog happen to be photographed from two different perspectives (horizontal or vertical).

To make things easier for you, one of the following two symbols has been included next to each product photo:



| Properties | Unit/level | Polyamide PA | Polyester PBT | Polycarbonate PC | Polycarbonate PC-F | ABS |
|---|------------|------------------|------------------|--------------------|--------------------|------------------|
| Operating temperature | RTI ** | ≤ 105 | ≤ 105 | ≤ 125 | ≤ 120 | ≤ 80 |
| Minimum temperature (without mechanical load) | | -40 | -40 | -40 | -40 | -40 |
| Dielectric strength according to IEC 60243-1/DIN VDE 0303-21 | kV/cm | 600 | 400 | > 300 | | 850 |
| Creep resistance | CTI...M | 550 | 225 | 175 | | 200 |
| IEC 60112/DIN VDE 0303-1 | CTI... | 600 | 225 | 175 | 175 | 600 |
| Tropical and termite resistance | | Good | Good | Good | | |
| Specific contact resistance IEC 60093/VDE 0303 Part 30; IEC 60167/VDE 0303 Part 31 | Ω cm | 10 ¹² | 10 ¹⁶ | > 10 ¹⁶ | > 10 ¹⁴ | 10 ¹⁴ |
| Surface resistance IEC 60093/VDE 0303 Part 30; IEC 60167/VDE 0303 Part 31 | Ω | 10 ¹⁰ | 10 ¹³ | > 10 ¹⁴ | | 10 ¹³ |
| Inflammability class according to UL 94 | | V2 - V0 | V0 | V2 - V0 | V0 | HB - V0 |

* According to UL 746 B/ANSI 746 B (elec.)

** Minimum value

Connection cross section

The rated cross section of modular terminal blocks must be specified by the manufacturer in accordance with IEC 60947-7-1. The rated cross section is the maximum conductor cross section that can be connected in single-, multi- or fine-strand versions subject to specific thermal, mechanical, and electrical requirements.

The manufacturer must also specify the **rated connection capacity**, i.e., the area of the conductor that can be connected, as well as the number of conductors that can be connected simultaneously and the necessary preparation of the conductor ends. The conductors can be **solid (single or multi-**

strand) or stranded (fine-strand).

These values can be found in the product-specific technical data.

The rated connection capacity of Phoenix Contact modular terminal blocks usually exceeds standard requirements, which specify that it must only be possible to connect one conductor with one of the two next smallest cross sections, excluding the rated cross section (standardized for the cross section range from 0.2 to 35 mm²).

In addition, conductors with a rated cross section can usually be wired with ferrules with plastic sleeve.

Phoenix Contact modular terminal blocks

are designed to allow copper conductors to be connected to them untreated. "Special treatment" or the use of ferrules – both permitted according to IEC 60947-7-1 – is not required. If ferrules are nevertheless used to protect stranded conductors against splicing, the connection capacity of the stranded conductor is generally reduced by one level.

| Structure and dimensions of connecting cables | | | | | | | | | | | | | |
|---|-------------------------|-----------------|-------------------------|----------------------------------|-------------------------|-------------------------------|---------------------------|--------------|--------------------|------|----------------|--------------|--------------------|
| Cross section [mm ²] | Single-strand | | Multi-strand | | Fine-strand | | American Wire Gauge [AWG] | | | | | | |
| | Diameter max. dimension | Number of wires | Diameter max. dimension | Number of wires (minimum number) | Diameter max. dimension | Number of wires (guide value) | Gauge No. AWG | Solid wires | | | Stranded wires | | |
| | | | | | | | [Ø mm] | [circ. mils] | [mm ²] | | [Ø mm] | [circ. mils] | [mm ²] |
| 0.2 | 0.5 | 1 | – | – | – | – | 24 | 0.51 | 404 | 0.21 | – | – | – |
| 0.5 | 0.9 | 1 | 1.1 | 7 | 1.1 | 16 | 20 | 0.81 | 1022 | 0.52 | 0.97 | 1111 | 0.56 |
| 0.75 | 1.0 | 1 | 1.2 | 7 | 1.3 | 24 | 18 | 1.02 | 1620 | 0.82 | 1.16 | 1600 | 0.82 |
| 1 | 1.2 | 1 | 1.4 | 7 | 1.5 | 32 | (17) | 1.15 | 2050 | 1.04 | | | |
| – | – | – | – | – | – | – | 16 | 1.29 | 2580 | 1.31 | 1.50 | 2580 | 1.32 |
| 1.5 | 1.5 | 1 | 1.7 | 7 | 1.8 | 30 | (15) | 1.45 | 3260 | 1.65 | | | |
| – | – | – | – | – | – | – | 14 | 1.63 | 4110 | 2.08 | 1.85 | 4100 | 2.09 |
| 2.5 | 1.9 | 1 | 2.2 | 7 | 2.3 | 50 | (13) | 1.83 | 5180 | 2.63 | | | |
| – | – | – | – | – | – | – | 12 | 2.05 | 6530 | 3.31 | 2.41 | 6500 | 3.32 |
| 4 | 2.4 | 1 | 2.7 | 7 | 2.9 | 56 | (11) | 2.30 | 8230 | 4.17 | | | |
| – | – | – | – | – | – | – | 10 | 2.59 | 10380 | 5.26 | 2.95 | 10530 | 5.37 |
| 6 | 2.9 | 1 | 3.3 | 7 | 3.9 | 84 | (9) | 2.91 | 13100 | 6.63 | | | |
| – | – | – | – | – | – | – | 8 | 3.26 | 16510 | 8.37 | 3.73 | 16625 | 8.48 |

Tightening torque of terminal block screws

IEC 60947-1/EN 60947-1, modified, Table 4 specifies tightening torques for screw connections based on the screw size for electrical and mechanical type tests.

Extract from IEC 60 947-1/EN 60 947-1, Table 4

The torque according to IEC and the recommended tightening torque for Phoenix Contact terminal blocks are specified.

| Thread | Head screw with slot | |
|-------------|----------------------|------------------------------------|
| | Torque [Nm] | Recommended tightening torque [Nm] |
| M2.5 (M2.6) | 0.4 | 0.4 - 0.5 |
| M3 | 0.5 | 0.5 - 0.6 |
| M3.5 | 0.8 | 0.8 - 1.0 |
| M4 | 1.2 | 1.2 - 1.5 |

Current carrying capacity

Standard IEC 60947-7-1/EN 60947-7-1/DIN VDE 0611-1 specifies the test currents for the individual conductor cross sections listed in the adjacent table. The corresponding currents are listed with the connection data for the individual terminal blocks. The type tests for modular terminal blocks are based on this data.

Test currents according to IEC 60947-7-1/EN 60947-7-1, Table 5

| Rated cross section | [mm ²] | 0.2 | 0.5 | 0.75 | 1.0 | 1.5 | 2.5 | 4 | 6 | 10 | 16 |
|---------------------|--------------------|-----|-----|------|------|------|-----|----|----|----|----|
| Test current | [A] | 4 | 6 | 9 | 13.5 | 17.5 | 24 | 32 | 41 | 57 | 76 |

Overview of certification bodies and safety marks

| Certification bodies and approvals | | Country code | Explosion protection | | Country code | Ship classification societies | | Country code |
|--|--|---------------|---|--|--------------|---|---------------------------------------|--------------|
|  | IECEE CB Scheme (in combination with certifying body) | International |  | FM Approvals | US |  | Bureau Veritas | FR |
| CCA | CENELEC Certification Agreement (CCA inspection report) (in combination with certifying body) | EU |  | DEKRA Certification B.V. | NL |  | Germanischer Lloyd AG | DE |
|  | Canadian Standards Association (CSA) | CA |  | Physikalisch-Technische Bundesanstalt | DE |  | Lloyd's Register EMEA | GB |
|   | Underwriters Laboratories Inc. (UL) | US |  | QS Schaffhausen | CH | ClassNK | Nippon Kaiji Kyokai | JP |
|   | Underwriters Laboratories Inc. (UL) - UL approval for Canada - | CA |  | VTT Expert Services Oy | FI |  | Det Norske Veritas | NO |
|    | Underwriters Laboratories Inc. (UL) Combined logo - UL approval for the USA and Canada - | US CA | IBExU | IBExU Institut für Sicherheitstechnik GmbH | DE |  | Polski Rejestr Statków | PL |
|  | INSIEME PER LA QUALITA'E LA SICUREZZA | IT |  | TÜV Rheinland do Brasil | BR |  | Russian Maritime Register of Shipping | RU |
|  | Gosudarstvenne Komitet Standartov (GOST) | RU |   | Underwriters Laboratories Inc. (UL) | US |  | Korean Register of Shipping | KR |
|  | DEKRA Certification B.V. | NL |  | TÜV Nord | DE |  | American Bureau of Shipping | US |
|  | Österreichischer Verband für Elektrotechnik | AT |  | DEKRA EXAM GmbH | DE | | | |
|  | South African Bureau of Standards | ZA | | | | | | |
|  | electrosuisse SEV Verband für Elektro-, Energie- und Informationstechnik | CH | | | | | | |
|   | Verband Deutscher Elektrotechniker e.V.(VDE) – Approval of drawings – Reports with production monitoring | DE | | | | | | |
|   | Berufsgenossenschaft (BG) GS - Geprüfte Sicherheit | DE | | | | | | |
|  | TÜV Rheinland Industrie Service GmbH | DE | | | | | | |

EMC: Class A product:

In accordance with statutory regulations, our products are indicated with this footnote if they are intended for use in industrial environments. This means that the permissible limit values for residential applications may be exceeded in the event of conducted and emitted interference. In such cases, the operator may have to take additional safety measures in order to ensure electromagnetic compatibility in residential applications.

Note:

Subject to changes that serve the purpose of technical progress.

Index

Alphabetical

| Type | Order No. | Page | Type | Order No. | Page | Type | Order No. | Page | Type | Order No. | Page |
|-------------------------------|-----------|------|--------------------------------|-----------|------|--------------------------------|-----------|------|-------------------------------|-----------|------|
| | | | CABLE-D-15SUB/M/OE/0,25/S/0,5M | 2926438 | 516 | CABLE-D25SUB/B/S/300/KONFEK/S | 2302162 | 512 | CABLE-FCN40/1X50/3,0M/IM/MEL | 2903471 | 441 |
| | | | CABLE-D-15SUB/M/OE/0,25/S/1,0M | 2926441 | 516 | CABLE-D25SUB/B/S/400/KONFEK/S | 2302175 | 512 | CABLE-FCN40/1X50/3,0M/IP/MEL | 2903479 | 441 |
| | | | CABLE-D-15SUB/M/OE/0,25/S/1,5M | 2926454 | 516 | CABLE-D25SUB/B/S/600/KONFEK/S | 2302188 | 512 | CABLE-FCN40/1X50/3,0M/M340 | 2321664 | 447 |
| | | | CABLE-D-15SUB/M/OE/0,25/S/2,0M | 2926467 | 516 | CABLE-D25SUB/S/S/100/KONFEK/S | 2305635 | 513 | CABLE-FCN40/1X50/3,0M/S7-IN | 2321127 | 453 |
| B | | | | | | | | | | | |
| B-STIFT | 1051993 | 560 | CABLE-D-15SUB/M/OE/0,25/S/3,0M | 2926470 | 516 | CABLE-D25SUB/S/S/200/KONFEK/S | 2305648 | 513 | CABLE-FCN40/1X50/3,0M/S7-OUT | 2321046 | 453 |
| BN-TRK | 2701404 | 560 | CABLE-D-15SUB/M/OE/0,25/S/4,0M | 2926483 | 516 | CABLE-D25SUB/S/S/300/KONFEK/S | 2305651 | 513 | CABLE-FCN40/1X50/4,0M/IM/MEL | 2903472 | 441 |
| BRIDGE-2 | 2900746 | 36 | CABLE-D-15SUB/M/OE/0,25/S/6,0M | 2926496 | 516 | CABLE-D37-M2,5/4X14-X81-I/... | 2302706 | 440 | CABLE-FCN40/1X50/4,0M/IP/MEL | 2903480 | 441 |
| BRIDGE-2-3M | 2901543 | 37 | CABLE-D-25SUB-F-OE-0,25-S/... | 2900906 | 516 | CABLE-D37-M2,5/4X14-Y81P-O/... | 2302696 | 440 | CABLE-FCN40/1X50/4,0M/M340 | 2321677 | 447 |
| BRIDGE-3 | 2900747 | 36 | CABLE-D-25SUB-M-OE-0,25-S/... | 2900911 | 516 | CABLE-D37-M2,5/4X14/50/X81-I | 2302515 | 440 | CABLE-FCN40/1X50/4,0M/S7-IN | 2321130 | 453 |
| BRIDGE-3-3M | 2901656 | 37 | CABLE-D-25SUB/F/OE/0,25/S/0,5M | 2926153 | 516 | CABLE-D37-M2,5/4X14/50/Y81P-O | 2302476 | 440 | CABLE-FCN40/1X50/4,0M/S7-OUT | 2321059 | 453 |
| BRIDGE-4 | 2900748 | 36 | CABLE-D-25SUB/F/OE/0,25/S/1,0M | 2926166 | 516 | CABLE-D37-M2,5/4X14/100/X81-I | 2302528 | 440 | CABLE-FCN40/1X50/6,0M/IM/MEL | 2903473 | 441 |
| BRIDGE-4-3M | 2901659 | 37 | CABLE-D-25SUB/F/OE/0,25/S/1,5M | 2926179 | 516 | CABLE-D37-M2,5/4X14/100/Y81P-O | 2302489 | 440 | CABLE-FCN40/1X50/6,0M/IP/MEL | 2903481 | 441 |
| BRIDGE-5 | 2900749 | 36 | CABLE-D-25SUB/F/OE/0,25/S/2,0M | 2926182 | 516 | CABLE-D37-M2,5/4X14/200/X81-I | 2302531 | 440 | CABLE-FCN40/1X50/6,0M/M340 | 2321680 | 447 |
| BRIDGE-5-3M | 2901545 | 37 | CABLE-D-25SUB/F/OE/0,25/S/3,0M | 2926195 | 516 | CABLE-D37-M2,5/4X14/200/Y81P-O | 2302492 | 440 | CABLE-FCN40/1X50/6,0M/S7-IN | 2321143 | 453 |
| BRIDGE-6 | 2900750 | 36 | CABLE-D-25SUB/F/OE/0,25/S/4,0M | 2926205 | 516 | CABLE-D37-M2,5/4X14/300/X81-I | 2302544 | 440 | CABLE-FCN40/1X50/6,0M/S7-OUT | 2321062 | 453 |
| BRIDGE-6-3M | 2901697 | 37 | CABLE-D-25SUB/F/OE/0,25/S/6,0M | 2926218 | 516 | CABLE-D37-M2,5/4X14/300/Y81P-O | 2302502 | 440 | CABLE-FCN40/1X50/8,0M/IM/MEL | 2903474 | 441 |
| BRIDGE-7 | 2900751 | 36 | CABLE-D-25SUB/M/OE/0,25/S/0,5M | 2926506 | 516 | CABLE-D37SUB/B/B/100/KONFEK/S | 2305509 | 513 | CABLE-FCN40/1X50/8,0M/IP/MEL | 2903482 | 441 |
| BRIDGE-7-3M | 2901698 | 37 | CABLE-D-25SUB/M/OE/0,25/S/1,0M | 2926519 | 516 | CABLE-D37SUB/B/B/200/KONFEK/S | 2305512 | 513 | CABLE-FCN40/1X50/8,0M/M340 | 2321693 | 447 |
| BRIDGE-8 | 2900752 | 36 | CABLE-D-25SUB/M/OE/0,25/S/1,5M | 2926522 | 516 | CABLE-D37SUB/B/B/300/KONFEK/S | 2305525 | 513 | CABLE-FCN40/1X50/8,0M/S7-IN | 2321156 | 453 |
| BRIDGE-8-3M | 2901700 | 37 | CABLE-D-25SUB/M/OE/0,25/S/2,0M | 2926535 | 516 | CABLE-D37SUB/B/B/400/KONFEK/S | 2900759 | 513 | CABLE-FCN40/1X50/8,0M/S7-OUT | 2321075 | 453 |
| BRIDGE-9 | 2900753 | 36 | CABLE-D-25SUB/M/OE/0,25/S/3,0M | 2926548 | 516 | CABLE-D37SUB/B/B/600/KONFEK/S | 2900760 | 513 | CABLE-FCN40/1X50/10,0M/IM/MEL | 2903475 | 441 |
| BRIDGE-9-3M | 2901701 | 37 | CABLE-D-25SUB/M/OE/0,25/S/4,0M | 2926551 | 516 | CABLE-D37SUB/B/B/800/KONFEK/S | 2900761 | 513 | CABLE-FCN40/1X50/10,0M/IP/MEL | 2903483 | 441 |
| BRIDGE-10 | 2900754 | 36 | CABLE-D-25SUB/M/OE/0,25/S/6,0M | 2926564 | 516 | CABLE-D37SUB/B/B/1000/KONFEK/S | 2900762 | 513 | CABLE-FCN40/1X50/10,0M/M340 | 2321703 | 447 |
| BRIDGE-10-3M | 2901702 | 37 | CABLE-D-37SUB-F-OE-0,25-S/... | 2900907 | 517 | CABLE-D37SUB/B/B/1500/KONFEK/S | 2900763 | 513 | CABLE-FCN40/1X50/10,0M/S7-IN | 2321169 | 453 |
| | | | CABLE-D-37SUB-M-OE-0,25-S/... | 2900912 | 517 | CABLE-D37SUB/B/B/2000/KONFEK/S | 2900764 | 513 | CABLE-FCN40/1X50/10,0M/S7-OUT | 2321088 | 453 |
| | | | CABLE-D-37SUB/F/OE/0,25/S/0,5M | 2926221 | 517 | CABLE-D37SUB/B/S/50/KONFEK/S | 2302191 | 512 | CABLE-FCN40/1X50/15,0M/M340 | 2903748 | 447 |
| | | | CABLE-D-37SUB/F/OE/0,25/S/1,0M | 2926234 | 517 | CABLE-D37SUB/B/S/100/KONFEK/S | 2302201 | 512 | CABLE-FCN40/4X14/0,5M/IM/MEL | 2903502 | 441 |
| | | | CABLE-D-37SUB/F/OE/0,25/S/1,5M | 2926247 | 517 | CABLE-D37SUB/B/S/150/KONFEK/S | 2302214 | 512 | CABLE-FCN40/4X14/0,5M/M340 | 2321716 | 447 |
| C | | | | | | | | | | | |
| CABLE D-SUB-B-B-S/.../.../... | 2302421 | 515 | CABLE-D-37SUB/F/OE/0,25/S/2,0M | 2926250 | 517 | CABLE-D37SUB/B/S/200/KONFEK/S | 2302227 | 512 | CABLE-FCN40/4X14/0,5M/S7-IN | 2321253 | 453 |
| CABLE D-SUB-S-S-S/.../.../... | 2302434 | 515 | CABLE-D-37SUB/F/OE/0,25/S/3,0M | 2926263 | 517 | CABLE-D37SUB/B/S/300/KONFEK/S | 2302230 | 512 | CABLE-FCN40/4X14/0,5M/S7-OUT | 2321172 | 453 |
| CABLE D-SUB-S/.../.../... | 2302340 | 515 | CABLE-D-37SUB/F/OE/0,25/S/4,0M | 2926276 | 517 | CABLE-D37SUB/B/S/400/KONFEK/S | 2302243 | 512 | CABLE-FCN40/4X14/1,0M/IM/MEL | 2903503 | 441 |
| CABLE-D-2FLK16/2,0M/YUC | 2321334 | 467 | CABLE-D-37SUB/F/OE/0,25/S/6,0M | 2926289 | 517 | CABLE-D37SUB/B/S/600/KONFEK/S | 2302256 | 512 | CABLE-FCN40/4X14/1,0M/M340 | 2321729 | 447 |
| CABLE-40/2FLK16/4,0M/YUC | 2321347 | 467 | CABLE-D-37SUB/M/OE/0,25/S/0,5M | 2926577 | 517 | CABLE-D37SUB/S/S/100/KONFEK/S | 2305664 | 513 | CABLE-FCN40/4X14/1,0M/S7-IN | 2321266 | 453 |
| CABLE-40/2FLK16/10,0M/YUC | 2321350 | 467 | CABLE-D-37SUB/M/OE/0,25/S/1,0M | 2926580 | 517 | CABLE-D37SUB/S/S/200/KONFEK/S | 2305677 | 513 | CABLE-FCN40/4X14/1,0M/S7-OUT | 2321185 | 453 |
| CABLE-40/2FLK16/15,0M/YUC | 2321376 | 467 | CABLE-D-37SUB/M/OE/0,25/S/1,5M | 2926593 | 517 | CABLE-D37SUB/S/S/300/KONFEK/S | 2305680 | 513 | CABLE-FCN40/4X14/2,0M/IM/MEL | 2903504 | 441 |
| CABLE-40/2FLK16/20,0M/YUC | 2321363 | 467 | CABLE-D-37SUB/M/OE/0,25/S/2,0M | 2926603 | 517 | CABLE-D50SUB/B/B/100/KONFEK/S | 2305541 | 513 | CABLE-FCN40/4X14/2,0M/M340 | 2321732 | 447 |
| CABLE-50/4FLK14/2,0M/YUC | 2314655 | 467 | CABLE-D-37SUB/M/OE/0,25/S/3,0M | 2926616 | 517 | CABLE-D50SUB/B/B/200/KONFEK/S | 2305554 | 513 | CABLE-FCN40/4X14/2,0M/S7-IN | 2321279 | 453 |
| CABLE-50/4FLK14/4,0M/YUC | 2314671 | 467 | CABLE-D-37SUB/M/OE/0,25/S/4,0M | 2926629 | 517 | CABLE-D50SUB/B/B/300/KONFEK/S | 2305567 | 513 | CABLE-FCN40/4X14/2,0M/S7-OUT | 2321198 | 453 |
| CABLE-50/4FLK14/6,0M/YUC | 2318978 | 467 | CABLE-D-37SUB/M/OE/0,25/S/6,0M | 2926632 | 517 | CABLE-D50SUB/B/S/50/KONFEK/S | 2302269 | 512 | CABLE-FCN40/4X14/3,0M/IM/MEL | 2903505 | 441 |
| CABLE-50/4FLK14/10,0M/YUC | 2314684 | 467 | CABLE-D-50SUB-F-OE-0,25-S/... | 2900908 | 517 | CABLE-D50SUB/B/S/100/KONFEK/S | 2302272 | 512 | CABLE-FCN40/4X14/3,0M/M340 | 2321745 | 447 |
| CABLE-50/4FLK14/15,0M/YUC | 2322773 | 467 | CABLE-D-50SUB-M-OE-0,25-S/... | 2900913 | 517 | CABLE-D50SUB/B/S/150/KONFEK/S | 2302285 | 512 | CABLE-FCN40/4X14/3,0M/S7-IN | 2321282 | 453 |
| CABLE-50/4FLK14/20,0M/YUC | 2314778 | 467 | CABLE-D-50SUB/F/OE/0,25/S/3,5M | 2926292 | 517 | CABLE-D50SUB/B/S/200/KONFEK/S | 2302298 | 512 | CABLE-FCN40/4X14/3,0M/S7-OUT | 2321208 | 453 |
| CABLE-D 9SUB/B/S/100/KONFEK/S | 2305415 | 513 | CABLE-D-50SUB/F/OE/0,25/S/4,0M | 2926302 | 517 | CABLE-D50SUB/B/S/300/KONFEK/S | 2302308 | 512 | CABLE-FCN40/4X14/4,0M/IM/MEL | 2903506 | 441 |
| CABLE-D 9SUB/B/B/200/KONFEK/S | 2305428 | 513 | CABLE-D-50SUB/F/OE/0,25/S/1,5M | 2926315 | 517 | CABLE-D50SUB/B/S/400/KONFEK/S | 2302311 | 512 | CABLE-FCN40/4X14/4,0M/M340 | 2321758 | 447 |
| CABLE-D 9SUB/B/B/300/KONFEK/S | 2305431 | 513 | CABLE-D-50SUB/F/OE/0,25/S/2,0M | 2926328 | 517 | CABLE-D50SUB/B/S/600/KONFEK/S | 2302324 | 512 | CABLE-FCN40/4X14/4,0M/S7-IN | 2321295 | 453 |
| CABLE-D 9SUB/B/S/50/KONFEK/S | 2299987 | 512 | CABLE-D-50SUB/F/OE/0,25/S/3,0M | 2926331 | 517 | CABLE-D50SUB/S/S/100/KONFEK/S | 2305693 | 513 | CABLE-FCN40/4X14/4,0M/S7-OUT | 2321211 | 453 |
| CABLE-D 9SUB/B/S/100/KONFEK/S | 2299990 | 512 | CABLE-D-50SUB/F/OE/0,25/S/4,0M | 2926344 | 517 | CABLE-D50SUB/S/S/200/KONFEK/S | 2305703 | 513 | CABLE-FCN40/4X14/6,0M/IM/MEL | 2903507 | 441 |
| CABLE-D 9SUB/B/S/150/KONFEK/S | 2300009 | 512 | CABLE-D-50SUB/F/OE/0,25/S/6,0M | 2926357 | 517 | CABLE-D50SUB/S/S/300/KONFEK/S | 2305716 | 513 | CABLE-FCN40/4X14/6,0M/M340 | 2321761 | 447 |
| CABLE-D 9SUB/B/S/200/KONFEK/S | 2302010 | 512 | CABLE-D-50SUB/M/OE/0,25/S/0,5M | 2926645 | 517 | CABLE-EC56-F-OE-0,34-S/... | 2904025 | 518 | CABLE-FCN40/4X14/6,0M/S7-IN | 2321305 | 453 |
| CABLE-D 9SUB/B/S/300/KONFEK/S | 2302023 | 512 | CABLE-D-50SUB/M/OE/0,25/S/1,0M | 2926658 | 517 | CABLE-EC56/F/OE/0,34/S/1,0M | 2903395 | 518 | CABLE-FCN40/4X14/6,0M/S7-OUT | 2321224 | 453 |
| CABLE-D 9SUB/B/S/400/KONFEK/S | 2302036 | 512 | CABLE-D-50SUB/M/OE/0,25/S/1,5M | 2926661 | 517 | CABLE-EC56/F/OE/0,34/S/2,0M | 2903396 | 518 | CABLE-FCN40/4X14/8,0M/IM/MEL | 2903508 | 441 |
| CABLE-D 9SUB/B/S/600/KONFEK/S | 2302049 | 512 | CABLE-D-50SUB/M/OE/0,25/S/2,0M | 2926674 | 517 | CABLE-EC56/F/OE/0,34/S/4,0M | 2903397 | 518 | CABLE-FCN40/4X14/8,0M/M340 | 2321774 | 447 |
| CABLE-D 9SUB/S/S/100/KONFEK/S | 2305570 | 513 | CABLE-D-50SUB/M/OE/0,25/S/3,0M | 2926687 | 517 | CABLE-EC56/F/OE/0,34/S/6,0M | 2903398 | 518 | CABLE-FCN40/4X14/8,0M/S7-IN | 2321318 | 453 |
| CABLE-D 9SUB/S/S/200/KONFEK/S | 2305583 | 513 | CABLE-D-50SUB/M/OE/0,25/S/4,0M | 2926690 | 517 | CABLE-EC56/F/OE/0,34/S/8,0M | 2903399 | 518 | CABLE-FCN40/4X14/8,0M/S7-OUT | 2321237 | 453 |
| CABLE-D 9SUB/S/S/300/KONFEK/S | 2305596 | 513 | CABLE-D-50SUB/M/OE/0,25/S/6,0M | 2926700 | 517 | CABLE-EC56/F/OE/0,34/S/10,0M | 2903400 | 518 | CABLE-FCN40/4X14/10,0M/IM/MEL | 2903509 | 441 |
| CABLE-D-9SUB-F-OE-0,25-S/... | 2900903 | 516 | CABLE-D15SUB/B/B/100/KONFEK/S | 2305444 | 513 | CABLE-EC56/F/OE/0,34/S/15,0M | 2903401 | 518 | CABLE-FCN40/4X14/10,0M/M340 | 2321787 | 447 |
| CABLE-D-9SUB-M-OE-0,25-S/... | 2900909 | 516 | CABLE-D15SUB/B/B/200/KONFEK/S | 2305457 | 513 | CABLE-EC56/F/OE/0,34/S/20,0M | 2903402 | 518 | CABLE-FCN40/4X14/10,0M/S7-IN | 2321321 | 453 |
| CABLE-D-9SUB/F/OE/0,25/S/0,5M | 2926014 | 516 | CABLE-D15SUB/B/B/300/KONFEK/S | 2305460 | 513 | CABLE-FCN24-2X14-OMR-IN/... | 2302845 | 442 | CABLE-FCN40/4X14/10,0M/S7-OUT | 2321240 | 453 |
| CABLE-D-9SUB/F/OE/0,25/S/1,0M | 2926027 | 516 | CABLE-D15SUB/B/S/50/KONFEK/S | 2302052 | 512 | CABLE-FCN24-2X14-OMR-OUT/... | 2302858 | 442 | CABLE-FCN40/4X14/100/OMR-IN | 2304209 | 442 |
| CABLE-D-9SUB/F/OE/0,25/S/1,5M | 2926030 | 516 | CABLE-D15SUB/B/S/100/KONFEK/S | 2302065 | 512 | CABLE-FCN24/2X14/100/OMR-IN | 2304241 | 442 | CABLE-FCN40/4X14/100/OMR-OUT | 2304186 | 442 |
| CABLE-D-9SUB/F/OE/0,25/S/2,0M | 2926043 | 516 | CABLE-D15SUB/B/S/150/KONFEK/S | 2302078 | 512 | CABLE-FCN24/2X14/100/OMR-OUT | 2304225 | 442 | CABLE-FCN40/4X14/15,0M/M340 | 2903749 | 447 |
| CABLE-D-9SUB/F/OE/0,25/S/3,0M | 2926056 | 516 | CABLE-D15SUB/B/S/200/KONFEK/S | 2302081 | 512 | CABLE-FCN24/2X14/200/OMR-IN | 2304254 | 442 | CABLE-FCN40/4X14/200/OMR-IN | 2304212 | 442 |
| CABLE-D-9SUB/F/OE/0,25/S/4,0M | 2926069 | 516 | CABLE-D15SUB/B/S/300/KONFEK/S | 2302094 | 512 | CABLE-FCN24/2X14/200/OMR-OUT | 2304238 | 442 | CABLE-FCN40/4X14/200/OMR-OUT | 2304199 | 442 |
| CABLE-D-9SUB/F/OE/0,25/S/6,0M | 2926072 | 516 | CABLE-D15SUB/B/S/400/KONFEK/S | 2302104 | 512 | CABLE-FCN40-4X14-OMR-IN/... | 2302816 | 442 | CABLE-FLK10-OE-0,14/... | 2904331 | 502 |
| CABLE-D-9SUB/M/OE/0,25/S/0,5M | 2926360 | 516 | CABLE-D15SUB/B/S/600/KONFEK/S | 2302117 | 512 | CABLE-FCN40-4X14-OMR-OUT/... | 2302832 | 442 | CABLE-FLK10/OE/0,14/0,5M | 2904073 | 502 |
| CABLE-D-9SUB/M/OE/0,25/S/1,0M | 2926373 | | | | | | | | | | |

Index

Alphabetical

| Type | Order No. | Page | Type | Order No. | Page | Type | Order No. | Page | Type | Order No. | Page |
|----------------------------|-----------|------|-----------------------------|-----------|------|--------------------------------|-----------|------|--------------------------------|-----------|------|
| EMG 45-DIO 8P-1N5408 | 2954879 | 262 | FBST 500-PLC GY | 2966838 | 368 | FLK 16/14/DV-IN/200 | 2300562 | 432 | FLK 40/4X14/EZ-DR/ 200/OB32 | 2298522 | 431 |
| EMG 45-DIO14M | 2950129 | 262 | FBST 500-PLC RD | 2966786 | 368 | FLK 16/14/DV-IN/300 | 2304403 | 432 | FLK 40/4X14/EZ-DR/ 300/OB32 | 2296841 | 431 |
| EMG 45-DIO14M/LP | 2950132 | 263 | FLK CRIMPTOOL | 2744869 | 48 | FLK 16/14/DV-IN/400 | 2305185 | 432 | FLK 40/4X14/EZ-DR/ 300/OB32 | 2298535 | 431 |
| EMG 45-DIO14P | 2950116 | 262 | FL PLUG RJ45 GN/2 | 2744571 | 48 | FLK 16/14/DV-OUT/ 30 | 2304348 | 432 | FLK 40/EZ-DR/ 50/KONFEK | 2288985 | 507 |
| EMG 45-LED 14S/24 | 2952334 | 263 | FL PLUG RJ45 GR/2 | 2744856 | 48 | FLK 16/14/DV-OUT/ 50 | 2304351 | 432 | FLK 40/EZ-DR/ 50/SLC | 2294610 | 430 |
| EMG 90-DIO 16E/LP | 2954808 | 263 | FLK 10/EZ-DR/ 50/KONFEK | 2299204 | 506 | FLK 16/14/DV-OUT/100 | 2300575 | 432 | FLK 40/EZ-DR/ 100/KONFEK | 2288998 | 430 |
| EMG 90-DIO 17E | 2954895 | 262 | FLK 10/EZ-DR/ 100/KONFEK | 2299217 | 506 | FLK 16/14/DV-OUT/200 | 2300588 | 432 | FLK 40/EZ-DR/ 100/SLC | 2294623 | 507 |
| EMG 90-DIO 32M | 2954934 | 262 | FLK 10/EZ-DR/ 150/KONFEK | 2299220 | 506 | FLK 16/14/DV-OUT/300 | 2304364 | 432 | FLK 40/EZ-DR/ 150/KONFEK | 2289007 | 507 |
| EMG 90-DIO 32M/LP | 2954785 | 263 | FLK 10/EZ-DR/ 200/KONFEK | 2299233 | 506 | FLK 16/24/DV-AI/EZ-DR/ 30 | 2304319 | 432 | FLK 40/EZ-DR/ 150/SLC | 2294636 | 430 |
| EMG 90-DIO 32P | 2954918 | 262 | FLK 10/EZ-DR/ 300/KONFEK | 2299246 | 506 | FLK 16/24/DV-AI/EZ-DR/ 50 | 2304296 | 432 | FLK 40/EZ-DR/ 200/KONFEK | 2298010 | 507 |
| EMG-GKS 12 | 2947035 | 262 | FLK 10/EZ-DR/ 400/KONFEK | 2299259 | 506 | FLK 16/24/DV-AI/EZ-DR/100 | 2301134 | 432 | FLK 40/EZ-DR/ 200/SLC | 2294649 | 430 |
| EML (15X6) R YE | 0819288 | 372 | FLK 10/EZ-DR/ 600/KONFEK | 2299262 | 506 | FLK 16/24/DV-AI/EZ-DR/200 | 2301545 | 432 | FLK 40/EZ-DR/ 250/KONFEK | 2289023 | 507 |
| EMM 3- 24DC/500AC-16-IFS | 2297523 | 12 | FLK 10/EZ-DR/ 800/KONFEK | 2299275 | 506 | FLK 16/24/DV-AI/EZ-DR/300 | 2304322 | 432 | FLK 40/EZ-DR/ 300/KONFEK | 2289036 | 507 |
| EMM 3- 24DC/500AC-IFS | 2297497 | 12 | FLK 10/EZ-DR/1000/KONFEK | 2299288 | 506 | FLK 16/EZ-DR/ 50/KONFEK | 2299291 | 506 | FLK 40/EZ-DR/ 300/SLC | 2294652 | 430 |
| EMM 3-230AC/500AC-16-IFS | 2297536 | 12 | FLK 14-16-EZ-DR-HF-S7/... | 2295693 | 457 | FLK 16/EZ-DR/ 100/KONFEK | 2299301 | 506 | FLK 40/EZ-DR/ 350/KONFEK | 2289049 | 507 |
| EMM 3-230AC/500AC-IFS | 2297507 | 12 | FLK 14/16/EZ-DR/ 50/S7 | 2293815 | 456 | FLK 16/EZ-DR/ 150/KONFEK | 2299314 | 506 | FLK 40/EZ-DR/ 400/KONFEK | 2289052 | 507 |
| ETD-BL-1T-F- 10S | 2917492 | 259 | FLK 14/16/EZ-DR/ 100/S7 | 2293828 | 456 | FLK 16/EZ-DR/ 200/KONFEK | 2299327 | 506 | FLK 40/EZ-DR/ 600/KONFEK | 2299589 | 507 |
| ETD-BL-1T-F- 10S-PT | 2901489 | 259 | FLK 14/16/EZ-DR/ 100/S7 | 2293831 | 456 | FLK 16/EZ-DR/ 300/KONFEK | 2299330 | 506 | FLK 40/EZ-DR/ 800/KONFEK | 2299592 | 507 |
| ETD-BL-1T-F- 30MIN | 2917515 | 259 | FLK 14/16/EZ-DR/ 200/S7 | 2293844 | 456 | FLK 16/EZ-DR/ 400/KONFEK | 2299343 | 506 | FLK 40/EZ-DR/1000/KONFEK | 2299602 | 507 |
| ETD-BL-1T-F- 30MIN-PT | 2901491 | 259 | FLK 14/16/EZ-DR/ 250/S7 | 2293857 | 456 | FLK 16/EZ-DR/ 600/KONFEK | 2299356 | 506 | FLK 50-2FLK20-EZ-DR-DV/... | 2304966 | 432 |
| ETD-BL-1T-F-300MIN | 2917528 | 259 | FLK 14/16/EZ-DR/ 300/S7 | 2293860 | 456 | FLK 16/EZ-DR/ 800/KONFEK | 2299369 | 506 | FLK 50-4X14-EZ-DR ... | 2302405 | 508 |
| ETD-BL-1T-F-300MIN-PT | 2901492 | 259 | FLK 14/16/EZ-DR/ 400/S7 | 2293863 | 456 | FLK 16/EZ-DR/1000/KONFEK | 2299372 | 506 | FLK 50-EZ-DR/FCN40-OMR-OU/... | 2302447 | 508 |
| ETD-BL-1T-F-300S | 2917502 | 259 | FLK 14/16/EZ-DR/ 500/S7 | 2293899 | 456 | FLK 20/2FLK14/EZ-DR/... | 2304487 | 432 | FLK 50-EZ-DR-D37SUB-X81-I/... | 2302683 | 440 |
| ETD-BL-1T-F-300S-PT | 2901490 | 259 | FLK 14/16/EZ-DR/ 600/S7 | 2293909 | 456 | FLK 20/2FLK14/EZ-DR/100/KONFEK | 2298470 | 432 | FLK 50-EZ-DR-D37SUB-Y81P-O/... | 2302625 | 440 |
| ETD-BL-1T-OFF-CC- 10S | 2917450 | 259 | FLK 14/16/EZ-DR/ 700/S7 | 2293912 | 456 | FLK 20/2FLK14/EZ-DR/200/KONFEK | 2298438 | 432 | FLK 50-EZ-DR-FCN40-OMR-IN/... | 2302803 | 442 |
| ETD-BL-1T-OFF-CC- 10S-PT | 2901485 | 259 | FLK 14/16/EZ-DR/ 800/S7 | 2293925 | 456 | FLK 20/2FLK14/EZ-DR/300/KONFEK | 2300818 | 432 | FLK 50-EZ-DR-FCN40-OMR-OU/... | 2302829 | 442 |
| ETD-BL-1T-OFF-CC- 30MIN | 2917467 | 259 | FLK 14/16/EZ-DR/ 900/S7 | 2293938 | 456 | FLK 20/EZ-DR/ 50/KONFEK | 2296391 | 506 | FLK 50-PA/EZ-DR/KS/ 200/YUC | 2314299 | 466 |
| ETD-BL-1T-OFF-CC- 30MIN-PT | 2901487 | 259 | FLK 14/16/EZ-DR/1000/S7 | 2293941 | 456 | FLK 20/EZ-DR/ 100/KONFEK | 2296401 | 506 | FLK 50-PA/EZ-DR/KS/ 300/YUC | 2314309 | 466 |
| ETD-BL-1T-OFF-CC-300MIN | 2917489 | 259 | FLK 14/16/EZ-DR/HF/ 50/S7 | 2296919 | 457 | FLK 20/EZ-DR/ 150/KONFEK | 2296472 | 506 | FLK 50-PA/EZ-DR/KS/ 400/YUC | 2314312 | 466 |
| ETD-BL-1T-OFF-CC-300MIN-PT | 2901488 | 259 | FLK 14/16/EZ-DR/HF/ 100/S7 | 2296922 | 457 | FLK 20/EZ-DR/ 200/KONFEK | 2296485 | 506 | FLK 50-PA/EZ-DR/KS/ 500/YUC | 2321499 | 466 |
| ETD-BL-1T-OFF-CC-300S | 2917463 | 259 | FLK 14/16/EZ-DR/HF/ 150/S7 | 2296935 | 457 | FLK 20/EZ-DR/ 300/KONFEK | 2296498 | 506 | FLK 50-PA/EZ-DR/KS/ 600/YUC | 2314927 | 466 |
| ETD-BL-1T-OFF-CC-300S-PT | 2901486 | 259 | FLK 14/16/EZ-DR/HF/ 200/S7 | 2296948 | 457 | FLK 20/EZ-DR/ 400/KONFEK | 2296508 | 506 | FLK 50-PA/EZ-DR/KS/ 700/YUC | 2321509 | 466 |
| ETD-BL-1T-ON- 10S | 2917379 | 258 | FLK 14/16/EZ-DR/HF/ 250/S7 | 2296951 | 457 | FLK 20/EZ-DR/ 600/KONFEK | 2296511 | 506 | FLK 50-PA/EZ-DR/KS/ 800/YUC | 2314930 | 466 |
| ETD-BL-1T-ON- 10S-PT | 2901476 | 258 | FLK 14/16/EZ-DR/HF/ 300/S7 | 2296964 | 457 | FLK 20/EZ-DR/ 800/KONFEK | 2296524 | 506 | FLK 50-PA/EZ-DR/KS/ 900/YUC | 2321512 | 466 |
| ETD-BL-1T-ON- 30MIN | 2917395 | 258 | FLK 14/16/EZ-DR/HF/ 400/S7 | 2904525 | 457 | FLK 20/EZ-DR/1000/KONFEK | 2296537 | 506 | FLK 50-PA/EZ-DR/KS/1000/YUC | 2314325 | 466 |
| ETD-BL-1T-ON- 30MIN-PT | 2901478 | 258 | FLK 14/16/EZ-DR/HF/ 500/S7 | 2304704 | 457 | FLK 26/EZ-DR/ 50/KONFEK | 2299385 | 506 | FLK 50-PA/EZ-DR/KS/1100/YUC | 2321389 | 466 |
| ETD-BL-1T-ON-300MIN | 2917405 | 258 | FLK 14/16/EZ-DR/HF/ 600/S7 | 2904526 | 457 | FLK 26/EZ-DR/ 100/KONFEK | 2299398 | 506 | FLK 50-PA/EZ-DR/KS/1200/YUC | 2321525 | 466 |
| ETD-BL-1T-ON-300MIN-PT | 2901479 | 258 | FLK 14/16/EZ-DR/HF/ 800/S7 | 2904527 | 457 | FLK 26/EZ-DR/ 150/KONFEK | 2299408 | 506 | FLK 50-PA/EZ-DR/KS/1300/YUC | 2321392 | 466 |
| ETD-BL-1T-ON-300S | 2917382 | 258 | FLK 14/16/EZ-DR/HF/1000/S7 | 2904528 | 457 | FLK 26/EZ-DR/ 200/KONFEK | 2299411 | 506 | FLK 50-PA/EZ-DR/KS/1400/YUC | 2321402 | 466 |
| ETD-BL-1T-ON-300S-PT | 2901477 | 258 | FLK 14/EZ-DR/ 30/KONFEK | 2295729 | 504 | FLK 26/EZ-DR/ 300/KONFEK | 2299424 | 506 | FLK 50-PA/EZ-DR/KS/1500/YUC | 2314338 | 466 |
| ETD-BL-1T-ON-CC- 10S | 2917418 | 259 | FLK 14/EZ-DR/ 50/KONFEK | 2288901 | 504 | FLK 26/EZ-DR/ 400/KONFEK | 2299437 | 506 | FLK 50-PA/EZ-DR/KS/1600/YUC | 2321538 | 466 |
| ETD-BL-1T-ON-CC- 10S-PT | 2901480 | 259 | FLK 14/EZ-DR/ 50/KONFEK/S | 2296977 | 505 | FLK 26/EZ-DR/ 600/KONFEK | 2299440 | 506 | FLK 50-PA/EZ-DR/KS/1700/YUC | 2321541 | 466 |
| ETD-BL-1T-ON-CC- 30MIN | 2917434 | 259 | FLK 14/EZ-DR/ 100/KONFEK | 2288914 | 504 | FLK 26/EZ-DR/ 800/KONFEK | 2299453 | 506 | FLK 50-PA/EZ-DR/KS/1800/YUC | 2321554 | 466 |
| ETD-BL-1T-ON-CC- 30MIN-PT | 2901483 | 259 | FLK 14/EZ-DR/ 100/KONFEK/S | 2296980 | 505 | FLK 26/EZ-DR/1000/KONFEK | 2299466 | 506 | FLK 50-PA/EZ-DR/KS/1900/YUC | 2321567 | 466 |
| ETD-BL-1T-ON-CC-300MIN | 2917447 | 259 | FLK 14/EZ-DR/ 150/KONFEK | 2288927 | 504 | FLK 34/EZ-DR/ 50/KONFEK | 2299479 | 506 | FLK 50-PA/EZ-DR/KS/2000/YUC | 2314503 | 466 |
| ETD-BL-1T-ON-CC-300MIN-PT | 2901484 | 259 | FLK 14/EZ-DR/ 150/KONFEK/S | 2296993 | 505 | FLK 34/EZ-DR/ 100/KONFEK | 2299482 | 506 | FLK 50-PA/EZ-DR/KS/2500/YUC | 2314516 | 466 |
| ETD-BL-1T-ON-CC-300S | 2917421 | 259 | FLK 14/EZ-DR/ 200/KONFEK | 2288930 | 504 | FLK 40-PA/EZ-DR/KS/ 100/YUC | 2299495 | 506 | FLK 50-PA/EZ-DR/KS/3000/YUC | 2314529 | 466 |
| ETD-BL-1T-ON-CC-300S-PT | 2901481 | 259 | FLK 14/EZ-DR/ 200/KONFEK/S | 2297002 | 505 | FLK 34/EZ-DR/ 200/KONFEK | 2299505 | 506 | FLK 50/2FLK20/EZ-DR/ 50/DV | 2304872 | 432 |
| ETD-FL-2T-DTI | 2866187 | 260 | FLK 14/EZ-DR/ 250/KONFEK | 2288943 | 504 | FLK 34/EZ-DR/ 300/KONFEK | 2299518 | 506 | FLK 50/2FLK20/EZ-DR/ 100/DV | 2304898 | 432 |
| ETD-SL-1T-DTF | 2866161 | 261 | FLK 14/EZ-DR/ 300/KONFEK | 2288956 | 504 | FLK 34/EZ-DR/ 400/KONFEK | 2299521 | 506 | FLK 50/2FLK20/EZ-DR/ 200/DV | 2304908 | 432 |
| ETD-SL-2T-I | 2866174 | 261 | FLK 14/EZ-DR/ 300/KONFEK/S | 2299013 | 505 | FLK 34/EZ-DR/ 600/KONFEK | 2299534 | 506 | FLK 50/2FLK20/EZ-DR/ 300/DV | 2304911 | 432 |
| EU4A-RJ45-USB-CAB1 PXC | 2903465 | 34 | FLK 14/EZ-DR/ 350/KONFEK | 2288969 | 504 | FLK 34/EZ-DR/ 800/KONFEK | 2299547 | 506 | FLK 50/2FLK20/EZ-DR/ 600/DV | 2304937 | 432 |
| EU5C-SWD-CAN PXC | 2903098 | 33 | FLK 14/EZ-DR/ 400/KONFEK | 2288972 | 504 | FLK 34/EZ-DR/1000/KONFEK | 2299550 | 506 | FLK 50/2FLK20/EZ-DR/ 800/DV | 2304940 | 432 |
| EU5C-SWD-DP PXC | 2903100 | 33 | FLK 14/EZ-DR/ 400/KONFEK/S | 2299026 | 505 | FLK 40-PA/EZ-DR/KS/ 100/YUC | 2322786 | 466 | FLK 50/2FLK20/EZ-DR/1000/DV | 2304953 | 432 |
| EU5C-SWD-EIP-MODTCP PXC | 2903244 | 33 | FLK 14/EZ-DR/ 450/KONFEK | 2290847 | 504 | FLK 40-PA/EZ-DR/KS/ 200/YUC | 2314341 | 466 | FLK 50/4X14/EZ-DR/ 50/KONFEK | 2296689 | 508 |
| EU5C-SWD-PF2-1 PXC | 2903113 | 33 | FLK 14/EZ-DR/ 500/KONFEK | 2290834 | 504 | FLK 40-PA/EZ-DR/KS/ 300/YUC | 2314354 | 466 | FLK 50/4X14/EZ-DR/ 100/KONFEK | 2296692 | 508 |
| EU5E-SWD-2A2A PXC | 2903104 | 33 | FLK 14/EZ-DR/ 550/KONFEK | 2290850 | 504 | FLK 40-PA/EZ-DR/KS/ 400/YUC | 2314367 | 466 | FLK 50/4X14/EZ-DR/ 150/KONFEK | 2296702 | 508 |
| EU5E-SWD-4D4D PXC | 2903101 | 33 | FLK 14/EZ-DR/ 600/KONFEK | 2290863 | 504 | FLK 40-PA/EZ-DR/KS/ 500/YUC | 2321570 | 466 | FLK 50/4X14/EZ-DR/ 200/KONFEK | 2296715 | 508 |
| EU5E-SWD-4DX PXC | 2903102 | 33 | FLK 14/EZ-DR/ 600/KONFEK/S | 2299039 | 505 | FLK 40-PA/EZ-DR/KS/ 600/YUC | 2314943 | 466 | FLK 50/4X14/EZ-DR/ 250/KONFEK | 2305402 | 508 |
| EU5E-SWD-X8D PXC | 2903103 | 33 | FLK 14/EZ-DR/ 800/KONFEK | 2299563 | 504 | FLK 40-PA/EZ-DR/KS/ 700/YUC | 2321583 | 466 | FLK 50/4X14/EZ-DR/ 300/KONFEK | 2296728 | 508 |
| | | | FLK 14/EZ-DR/ 800/KONFEK/S | 2299042 | 505 | FLK 40-PA/EZ-DR/KS/ 800/YUC | 2314956 | 466 | FLK 50/4X14/EZ-DR/ 400/KONFEK | 2296731 | 508 |
| | | | FLK 14/EZ-DR/1000/KONFEK | 2299576 | 504 | FLK 40-PA/EZ-DR/KS/ 900/YUC | 2321415 | 466 | FLK 50/4X14/EZ-DR/ 600/KONFEK | 2296744 | 508 |
| | | | FLK 14/EZ-DR/1000/KONFEK/S | 2299055 | 505 | FLK 40-PA/EZ-DR/KS/1000/YUC | 2314370 | 466 | FLK 50/4X14/EZ-DR/ 800/KONFEK | 2296757 | 508 |
| | | | FLK 14/EZ-DR/HF/ 50/KONFEK | 2305952 | 505 | FLK 40-PA/EZ-DR/KS/1100/YUC | 2321428 | 466 | FLK 50/4X14/EZ-DR/1000/KONFEK | 2296773 | 508 |
| FBS 2-6 | 3030336 | 318 | FLK 14/EZ-DR/HF/ 100/KONFEK | 2305965 | 505 | FLK 40-PA/EZ-DR/KS/1200/YUC | 2321431 | 466 | FLK 50/EZ-DR/ 50/KONFEK | 2289065 | |

| Type | Order No. | Page | Type | Order No. | Page | Type | Order No. | Page | Type | Order No. | Page |
|---------------------------------|-----------|------|--------------------------------|-----------|------|--------------------------------|-----------|------|---------------------------|-----------|------|
| FLK 50/EZ-DR/550/KONFEK | 2289599 | 504 | FLKM S135-431-4UA/S400 | 2314846 | 459 | LV- 12- 24UC | 2833712 | 388 | MACX MCR-SL-NAM-R-SP | 2924252 | 120 |
| FLK 50/EZ-DR/600/KONFEK | 2289609 | 504 | FLKM S135-454-4UA/S400 | 2314859 | 461 | LV- 48- 60UC | 2833725 | 388 | MACX MCR-SL-RPSSI-2I | 2924825 | 107 |
| FLK 50/EZ-DR/800/KONFEK/S | 2289152 | 505 | FLKM S135-460-4UA/I/S400 | 2314613 | 461 | LV-120-230AC/110DC | 2833738 | 388 | MACX MCR-SL-RPSSI-2I-SP | 2924838 | 107 |
| FLK 50/EZ-DR/650/KONFEK | 2289612 | 504 | FLKM S135-460-4UA/U/S400 | 2314862 | 461 | LV3- 12- 24UC | 2833835 | 388 | MACX MCR-SL-RPSSI-I | 2865955 | 106 |
| FLK 50/EZ-DR/700/KONFEK | 2289625 | 504 | FLKM S135-465-4UA/T/S400 | 2314875 | 462 | LV3- 48- 60UC | 2833848 | 388 | MACX MCR-SL-RPSSI-I-SP | 2924207 | 106 |
| FLK 50/EZ-DR/750/KONFEK | 2289638 | 504 | FLKM S135-465-4UA/U/S400 | 2314888 | 462 | LV3-120-230AC/110DC | 2833851 | 388 | MACX MCR-SL-RPSSI-I-UP | 2865968 | 108 |
| FLK 50/EZ-DR/800/KONFEK | 2289641 | 504 | FLKM S135-470-4UC/I/S400 | 2314626 | 462 | | | | MACX MCR-SL-RPSSI-I-UP-SP | 2924210 | 108 |
| FLK 50/EZ-DR/800/KONFEK/S | 2289165 | 505 | FLKM S135-470-4UC/U/S400 | 2314891 | 462 | | | | MACX MCR-SL-RTD-I | 2865065 | 110 |
| FLK 50/EZ-DR/850/KONFEK | 2289654 | 504 | FLKM S135/42X0,75/3,0M/OE | 2315007 | 463 | | | | MACX MCR-SL-RTD-I-NC | 2865078 | 110 |
| FLK 50/EZ-DR/900/KONFEK | 2289667 | 504 | FLKM S135/42X0,75/5,0M/OE | 2318017 | 463 | | | | MACX MCR-SL-RTD-I-SP | 2924317 | 110 |
| FLK 50/EZ-DR/950/KONFEK | 2289670 | 504 | FLKM S135/S400/SO120 | 2301723 | 459 | | | | MACX MCR-SL-RTD-I-SP-NC | 2924320 | 110 |
| FLK 50/EZ-DR/1000/KONFEK | 2289683 | 504 | FLKM S135/S400/SO121 | 2301736 | 459 | | | | MACX MCR-SL-TC-I | 2924333 | 112 |
| FLK 50/EZ-DR/1000/KONFEK/S | 2289178 | 505 | FLKM S135/S400/SO122 | 2301749 | 459 | MACX MCR-EX-SL-2NAM-R-UP | 2865984 | 175 | MACX MCR-SL-TC-I-NC | 2924346 | 112 |
| FLK 50/EZ-DR/D37SUB/50/X81-I | 2302641 | 440 | FLKM S135/S400/SO123 | 2301752 | 460 | MACX MCR-EX-SL-2NAM-R-UP-SP | 2924249 | 175 | MACX MCR-T-UI-UI | 2811394 | 114 |
| FLK 50/EZ-DR/D37SUB/50/Y81-P-O | 2302599 | 440 | FLKM S135/S400/SO124 | 2301765 | 461 | MACX MCR-EX-SL-2NAM-RO | 2865476 | 174 | MACX MCR-T-UI-UP-C | 2811873 | 114 |
| FLK 50/EZ-DR/D37SUB/100/X81-I | 2302654 | 440 | FLKM S135/S400/SO125 | 2301778 | 460 | MACX MCR-EX-SL-2NAM-RO-SP | 2924087 | 174 | MACX MCR-T-UI-UP-SP | 2811860 | 114 |
| FLK 50/EZ-DR/D37SUB/100/Y81-P-O | 2302609 | 440 | FLKM S135/S400/SO126 | 2301781 | 460 | MACX MCR-EX-SL-2NAM-T | 2865489 | 177 | MACX MCR-T-UI-UP-SP-C | 2811970 | 114 |
| FLK 50/EZ-DR/D37SUB/200/X81-I | 2302667 | 440 | FLKM S135/S400/SO127 | 2301794 | 460 | MACX MCR-EX-SL-2NAM-T-SP | 2924090 | 177 | MACX MCR-T-UIREL-UP | 2811378 | 116 |
| FLK 50/EZ-DR/D37SUB/200/Y81-P-O | 2302612 | 440 | FLKM S135/S7/FLK50/PLC | 2314736 | 463 | MACX MCR-EX-SL-IDSH-I | 2865405 | 164 | MACX MCR-T-UIREL-UP-C | 2811514 | 116 |
| FLK 50/EZ-DR/D37SUB/300/X81-I | 2302670 | 440 | FLKM-2FLK14/KDS3-MT/PPA/S7 | 2295062 | 482 | MACX MCR-EX-SL-IDSH-SP | 2924032 | 164 | MACX MCR-T-UIREL-UP-SP | 2811828 | 116 |
| FLK 50/EZ-DR/D37SUB/300/Y81-P-O | 2302638 | 440 | FLKM-D25 SUB/B/KDS3-MT/TU810 | 2304513 | 422 | MACX MCR-EX-SL-NAM-2RO | 2865450 | 173 | MACX MCR-T-UIREL-UP-SP-C | 2811831 | 116 |
| FLK 50/EZ-DR/FCN40/100/OMR-IN | 2302642 | 442 | FLKM-D25 SUB/B/KDS3-MT/TU810/P | 2304539 | 422 | MACX MCR-EX-SL-NAM-2RO-SP | 2924061 | 173 | MACX MCR-UI-UI | 2811284 | 102 |
| FLK 50/EZ-DR/FCN40/100/OMR-OUT | 2304144 | 442 | FLKM-D25 SUB/B/KDS3-MT/TU830 | 2304526 | 422 | MACX MCR-EX-SL-NAM-2T | 2865463 | 176 | MACX MCR-UI-UI-NC | 2811446 | 102 |
| FLK 50/EZ-DR/FCN40/200/OMR-IN | 2304173 | 442 | FLKM-KS40/AO16/YCS | 2314260 | 469 | MACX MCR-EX-SL-NAM-2T-SP | 2924074 | 176 | MACX MCR-UI-UI-SP | 2811572 | 102 |
| FLK 50/EZ-DR/FCN40/200/OMR-OUT | 2304157 | 442 | FLKM-KS40/YCS | 2314642 | 468 | MACX MCR-EX-SL-NAM-NAM | 2866006 | 178 | MACX MCR-UI-UI-SP-NC | 2811556 | 102 |
| FLK EZ-DR-S.....I..... | 2295046 | 456 | FLKM-PA-2D15/HW/DI/C300 | 2901879 | 438 | MACX MCR-EX-SL-NAM-NAM-SP | 2924883 | 178 | MACX MCR-UI-UI-UP | 2811459 | 104 |
| FLK EZ-DR-.....I..... | 2295059 | 456 | FLKM-PA-2D15/HW/DO/C300 | 2900924 | 438 | MACX MCR-EX-SL-NAM-R | 2865434 | 172 | MACX MCR-UI-UI-UP-NC | 2811297 | 104 |
| FLKM 14-PA-AB/1756/EXTC | 23002861 | 425 | FLKM-PA-D37/HW/AN/C300 | 2900622 | 438 | MACX MCR-EX-SL-NAM-R-SP | 2924045 | 172 | MACX MCR-UI-UI-UP-SP | 2811585 | 104 |
| FLKM 14-PA-AB/1756/IF6/EXTC | 2901037 | 425 | FLKM-PA-D37/HW/DIO/C300 | 2901423 | 438 | MACX MCR-EX-SL-RPSSI-2I-2I | 2865382 | 162 | MACX MCR-UI-UI-UP-SP-NC | 2811569 | 104 |
| FLKM 14-PA-AB/1756/IN/EXTC | 2302874 | 425 | FLKMS 50/32IM/LA/PLC | 2284510 | 480 | MACX MCR-EX-SL-RPSSI-2I-2I-SP | 2924676 | 162 | MC 1,5/5-ST-3,81 | 1803604 | 12 |
| FLKM 14-PA-INLINE/32 | 2302777 | 444 | FLKMS 50/32IM/PLC | 2284523 | 480 | MACX MCR-EX-SL-RPSSI-2I | 2865366 | 161 | MCR-1CLP-I-I-00 | 2814016 | 135 |
| FLKM 14-PA-INLINE/DIO8 | 2900889 | 444 | FLKMS 50/32IM/ZFKDS/PLC | 2901389 | 480 | MACX MCR-EX-SL-RPSSI-2I-SP | 2924236 | 161 | MCR-2CLP-I-I-00 | 2814029 | 135 |
| FLKM 14-PA-INLINE/IN16 | 2302751 | 444 | FLKMS-KS40/Al/YCS | 2314286 | 469 | MACX MCR-EX-SL-RPSSI-I | 2865340 | 160 | MCR-4CLP-I-I-00 | 2814045 | 135 |
| FLKM 14-PA-INLINE/OUT16 | 2302764 | 444 | FLKMS-KS40/SIIA16/YCS | 2314273 | 469 | MACX MCR-EX-SL-RPSSI-I-SP | 2924016 | 160 | MCR-C-I-I-00-DC | 2814508 | 131 |
| FLKM 14-PA-MODI/M340 | 2903208 | 446 | FLKMS-KS50/32IM/YCS | 2314451 | 468 | MACX MCR-EX-SL-RPSSI-I-UP | 2865793 | 163 | MCR-C-I-U-4-DC | 2814511 | 131 |
| FLKM 14-PA-S300 | 2289770 | 451 | FUSE-10X38-16A-GR | 2903126 | 29 | MACX MCR-EX-SL-RPSSI-I-UP-SP | 2924029 | 163 | MCR-C-U-I-4-DC | 2814537 | 131 |
| FLKM 14-PA-SLC500/IN | 2293462 | 428 | FUSE-10X38-20A-GR | 2903384 | 29 | MACX MCR-EX-SL-RTD-I | 2865939 | 165 | MCR-C-U-U-DC | 2814469 | 131 |
| FLKM 14-PA-SLC500/IN/M | 2293475 | 428 | FUSE-10X38-30A-MR | 2903119 | 29 | MACX MCR-EX-SL-RTD-I-NC | 2865573 | 165 | MCR-ET 38X35 WH | 2814317 | 149 |
| FLKM 14-PA-SLC500/OUT | 2293459 | 428 | | | | MACX MCR-EX-SL-RTD-I-SP | 2924142 | 165 | MCR-F-UI-DC | 2814605 | 144 |
| FLKM 14-PA/GE/DI | 2290038 | 437 | | | | MACX MCR-EX-SL-RTD-I-SP-NC | 2924168 | 165 | MCR-FL-C-UI-2UI-DCI | 2814854 | 132 |
| FLKM 14-PA/GE/DO | 2290009 | 437 | | | | MACX MCR-EX-SL-SD-21-25-LP | 2865492 | 180 | MCR-FL-C-UI-2UI-DCI-NC | 2814867 | 132 |
| FLKM 14/8M/SI/PLC | 2294487 | 478 | | | | MACX MCR-EX-SL-SD-21-25-LP-SP | 2924113 | 180 | MCR-FL-HT-T-I | 2864529 | 142 |
| FLKM 14/KDS3-MT/PPA/PLC | 2290423 | 482 | | | | MACX MCR-EX-SL-SD-21-40-LP | 2865764 | 181 | MCR-FL-HT-T-I-EX | 2864532 | 189 |
| FLKM 16-PA-331-1KF/1/mini-MCR | 2318237 | 455 | | | | MACX MCR-EX-SL-SD-21-40-LP-SP | 2924139 | 181 | MCR-FL-HT-TS-I-EX | 2864545 | 188 |
| FLKM 16-PA-332-5HF/1/mini-MCR | 2318240 | 455 | IB IL 24 DI 16-PAC | 2861250 | 207 | MACX MCR-EX-SL-SD-21-60-LP | 2865515 | 181 | MCR-FL-T-LP-I | 2864561 | 140 |
| FLKM 16-PA-S300/mini-MCR | 2314749 | 454 | IB IL 24 DI 2-PAC | 2861221 | 207 | MACX MCR-EX-SL-SD-21-60-LP-SP | 2924100 | 181 | MCR-FL-T-LP-I-EX | 2864574 | 187 |
| FLKM 16/AI/DV | 2304429 | 433 | IB IL 24 DI 4-PAC | 2861234 | 207 | MACX MCR-EX-SL-SD-23-48-LFD | 2924867 | 179 | MCR-FL-TS-LP-I-EX | 2864587 | 187 |
| FLKM 16/AO/SI/DV | 2304445 | 433 | IB IL 24 DI 8-PAC | 2861247 | 207 | MACX MCR-EX-SL-SD-23-48-LFD-SP | 2924870 | 179 | MCR-PAC-T-USB | 2309000 | 149 |
| FLKM 16/DI/SI/LA/DV | 2304458 | 433 | IB IL 24 FLM-PAC | 2736903 | 50 | MACX MCR-EX-SL-SD-24-48-LP | 2865609 | 181 | MCR-PSP | 2811912 | 146 |
| FLKM 16/DV | 2304432 | 433 | IB IL AI 2/SF-PAC | 2861302 | 207 | MACX MCR-EX-SL-SD-24-48-LP-SP | 2924126 | 181 | MCR-PSP-DC | 2811925 | 146 |
| FLKM 50-PA-AB/1756/EXTC | 2302735 | 424 | IB IL AI 8/SI-PAC | 2861661 | 207 | MACX MCR-EX-SL-SD-TC-I | 2865942 | 166 | MCR-PT100-I | 2810353 | 138 |
| FLKM 50-PA-AB/1756/IN/EXTC | 2302748 | 424 | IB IL AI 8/SF-PAC | 2861412 | 207 | MACX MCR-EX-SL-TC-I-NC | 2865586 | 166 | MCR-PT100-I-DC | 2810337 | 138 |
| FLKM 50-PA-AB/IBN | 2289816 | 426 | IB IL DI 8/SO-PAC | 2897020 | 207 | MACX MCR-EX-T-UI-UP | 2865654 | 168 | MCR-PT100-U | 2810340 | 138 |
| FLKM 50-PA-AB/OBN | 2289829 | 426 | IBS IP 400 MBH -F | 2732668 | 48 | MACX MCR-EX-T-UI-UP-C | 2811763 | 168 | MCR-PT100-U-DC | 2810311 | 138 |
| FLKM 50-PA-GE/TKFC/RXI | 2321473 | 436 | IBS PG SET | 2836599 | 48 | MACX MCR-EX-T-UI-UP-SP | 2924689 | 168 | MCR-S-1-5-UI-DCI | 2814634 | 230 |
| FLKM 50-PA-GE/TKFC/RXI/IN | 2321486 | 436 | IBS RBC/F-T/ | 2740151 | 50 | MACX MCR-EX-T-UI-UP-SP-C | 2924692 | 168 | MCR-S-1-5-UI-DCI-NC | 2814715 | 230 |
| FLKM 50-PA-MODI-TSX/Q | 2294306 | 445 | IFS-CONFSTICK | 2986122 | 12 | MACX MCR-EX-T-UIREL-UP | 2865751 | 170 | MCR-S-1-5-UI-SW-DCI | 2814650 | 230 |
| FLKM 50-PA-S300 | 2294445 | 450 | IFS-CONFSTICK-L | 2901103 | 12 | MACX MCR-EX-T-UIREL-UP-C | 2865722 | 170 | MCR-S-1-5-UI-SW-DCI-NC | 2814731 | 230 |
| FLKM 50-PA-S300/SO167 | 2307662 | 452 | IFS-OP-CRADLE | 2811886 | 118 | MACX MCR-EX-T-UIREL-UP-SP | 2924799 | 170 | MCR-S-10-50-UI-DCI | 2814647 | 230 |
| FLKM 50-PA-S400 | 2294500 | 458 | IFS-OP-UNIT | 2811899 | 118 | MACX MCR-EX-T-UIREL-UP-SP-C | 2924809 | 170 | MCR-S-10-50-UI-SW-DCI | 2814663 | 230 |
| FLKM 50-PA-S400(3-48) | 2294908 | 458 | IFS-USB-PROG-ADAPTER | 2811271 | 119 | MACX MCR-PTB | 2865625 | 126 | MCR-S10-50-UI-DCI-NC | 2814728 | 230 |
| FLKM 50-PA-SLC500/OUT/2A | 2293446 | 428 | IMC 1,5/ 5-ST-3,81 | 1857919 | 12 | MACX MCR-PTB-SP | 2924184 | 126 | MCR-S10-50-UI-SW-DCI-NC | 2814744 | 230 |
| FLKM 50-PA/DO326/S7-300 | 2321952 | 452 | | | | MACX MCR-S-MUX | 2865599 | 186 | MCR-SL-1CLP-I-I-00-4KV | 2814841 | 134 |
| FLKM 50/4-FLK14/PA-MODI-TSX/Q | 2294416 | 445 | | | | MACX MCR-S-MUX-TB | 2308124 | 186 | MCR-SL-CUC-100-I | 2308027 | 229 |
| FLKM 50/4-FLK14/PA-S400 | 2294429 | 458 | | | | MACX MCR-SL-2NAM-R-UP | 2865052 | 123 | MCR-SL-CUC-100-U | 2308108 | 229 |
| FLKM 50/32M/DV | 2304869 | 434 | | | | MACX MCR-SL-2NAM-R-UP-SP | 2924304 | 123 | MCR-SL-CUC-200-I | 2308030 | 229 |
| FLKM 50/32M/IN/LA/DV | 2304856 | 434 | | | | MACX MCR-SL-2NAM-RO | 2865049 | 122 | MCR-SL-CUC-200-U | 2308205 | 229 |
| FLKM 50/32M/PLC | 2289719 | 477 | | | | MACX MCR-SL-2NAM-RO-SP | 2924294 | 122 | MCR-SL-CUC-300-I | 2308043 | 229 |
| FLKM 50/32M/SI/PLC | 2294940 | 478 | LDM- 12- 24DC | 2833686 | 388 | MACX MCR-SL-2NAM-T | 2865036 | 125 | MCR-SL-CUC-300-U | 2308302 | 229 |
| FLKM 50/32P/PLC | 2291121 | 477 | LDM- 48- 60DC | 2833699 | 388 | MACX MCR-SL-2NAM-T-SP | 2924281 | 125 | MCR-SL-CUC-400-I | 2308072 | 229 |
| FLKM 50/4-FLK14/PA-S300 | 2296281 | 450 | LDM-110DC | 2833709 | 388 | MACX MCR-SL-CAC- 5-I | 2810612 | 232 | MCR-SL-CUC-500-I | 2308085 | 229 |
| FLKM 50/KDS3-MT/PPA/AN/PLC | 2291587 | 482 | LDM3- 12- 24DC | 2833806 | 388 | MACX MCR-SL-CAC- 5-I-UP | 2810625 | 232 | MCR-SL-CUC-600-I | 2308098 | 229 |
| FLKM 50/KDS3-MT/PPA/PLC | 2290614 | 482 | LDM3- 48- 60DC | 2833819 | 388 | MACX MCR-SL-CAC-12-I-UP | 2810638 | 232 | MCR-SL-D-RA | 2810081 | 150 |
| FLKM 50/KDS3-MT/PPA/S7-300 | 2304490 | 482 | LDM3-110DC | 2833822 | | | | | | | |

Index

Alphabetical

| Type | Order No. | Page | Type | Order No. | Page | Type | Order No. | Page | Type | Order No. | Page |
|--------------------------------|-----------|------|--------------------------------|-----------|------|-------------------------------|-----------|------|--------------------------------|-----------|------|
| MCR-SL-S-100-U | 2813457 | 233 | MINI MCR-SL-UI-2I | 2864794 | 72 | PACT MCR-V2-3015-60-75-5A-1 | 2276502 | 214 | PACT MCR-V2-8015-105-500-5A-1 | 2276269 | 219 |
| MCR-SL-S-200-I-LP | 2813499 | 233 | MINI MCR-SL-UI-2I-NC | 2864176 | 72 | PACT MCR-V2-3015-60-250-5A-1 | 2276544 | 214 | PACT MCR-V2-8015-105-600-5A-1 | 2276272 | 219 |
| MCR-SL-S-200-U | 2813460 | 233 | MINI MCR-SL-UI-2I-SP | 2864804 | 72 | PACT MCR-V2-4012-70 | 2277284 | 215 | PACT MCR-V2-8015-105-750-5A-1 | 2276285 | 219 |
| MCR-SL-P-1-5-UI-0 | 2814359 | 234 | MINI MCR-SL-UI-2I-SP-NC | 2864189 | 72 | PACT MCR-V2-5012-85 | 2277297 | 216 | PACT MCR-V2-8015-105-800-5A-1 | 2276298 | 219 |
| MCR-SWS-I | 2766478 | 147 | MINI MCR-SL-UI-F | 2864082 | 83 | PACT MCR-V2-6015-85 | 2277336 | 217 | PACT MCR-V2-8015-105-1000-5A-1 | 2276308 | 219 |
| MCR-SWS-U | 2766465 | 147 | MINI MCR-SL-UI-F-SP | 2812043 | 83 | PACT MCR-V2-6040-96 | 2277349 | 218 | PACT MCR-V2-8015-105-1000-5A-1 | 2277721 | 219 |
| MCR-T-UI | 2814090 | 136 | MINI MCR-SL-UI-I-LP-NC | 2902829 | 75 | PACT MCR-V2-6315-95 | 2277307 | 218 | PACT MCR-V2-8015-105-1250-5A-1 | 2276311 | 219 |
| MCR-T-UI-E | 2814113 | 136 | MINI MCR-SL-UI-I-LP-SP-NC | 2902830 | 75 | PACT MCR-V2-8015-105 | 2277352 | 219 | PACT MCR-V2-8015-105-1500-5A-1 | 2277734 | 219 |
| MCR-T-UI-E-NC | 2814126 | 136 | MINI MCR-SL-UI-REL | 2864480 | 85 | PACT MCR-V2-8020-105 | 2277365 | 219 | PACT MCR-V2-8015-105-1600-5A-1 | 2276324 | 219 |
| MCR-T-UI-NC | 2814100 | 136 | MINI MCR-SL-UI-REL-SP | 2864493 | 85 | PACT MCR-V2-10020-129 | 2277378 | 220 | PACT MCR-V2-8015-105-2000-5A-1 | 2276337 | 219 |
| MCR-TTL-RS232 | 2814391 | 149 | MINI MCR-SL-UI-UI | 2864383 | 66 | PACT MCR-V2-10020-129-2500-5A | 2276395 | 220 | PACT MCR-V2-8015-105-2500-5A-1 | 2276340 | 219 |
| MCR-TTL-RS232-E | 2814388 | 149 | MINI MCR-SL-UI-UI-NC | 2864150 | 66 | PACT MCR-V2-10036-129 | 2277381 | 220 | PACT MCR-V2-8020-105-1000-5A-1 | 2277747 | 219 |
| MCR-VAC-UI-0-DC | 2811103 | 236 | MINI MCR-SL-UI-UI-SP | 2864710 | 66 | PACT MCR-V2-10036-129-3000-5A | 2276405 | 220 | PACT MCR-V2-8020-105-1500-5A-1 | 2277750 | 219 |
| MCR-VDC-UI-B-DC | 2811116 | 236 | MINI MCR-SL-UI-UI-SP-NC | 2864163 | 66 | PACT MCR-V2-12020-159 | 2277394 | 221 | PACT MCR-V2-8020-105-2000-5A-1 | 2276382 | 219 |
| MCR/PI-CONF-WIN | 2814799 | 149 | MINI MCR-SL-V8-FLK 16-A | 2811268 | 94 | PACT MCR-V2-12040-159 | 2277404 | 221 | PACT MCR-V3-60 | 2277417 | 222 |
| ME 17,5 TBUS 1,5/ 5-ST-3,81 GN | 2709561 | 91 | MINI MCR-TC-UI-NC | 2902851 | 80 | PACT MCR-V2-12040-159-4000-5A | 2276418 | 221 | PACT-FAST-MNT-W13-L40 | 2276612 | 223 |
| ME 22,5 TBUS 1,5/ 5-ST-3,81 GN | 2707437 | 12 | MINI-PS-100-240AC/24DC/1,5/EX | 2866653 | 91 | PACT MCR-V2-3015-60-60-5A-1 | 2277815 | 214 | PACT-FAST-MNT-W13-L65 | 2276625 | 223 |
| ME 6,2 TBUS-2 1,5/5-ST-3,81 GN | 2869728 | 90 | MINI-SYS-PS-100-240AC/24DC/1,5 | 2866983 | 91 | PACT MCR-V2-3015-60-75-5A-1 | 2277828 | 214 | PACT-FAST-MNT-W16-L40 | 2276638 | 223 |
| MINI MCR-DKL | 2308111 | 88 | MMI-CONF-SET | 2297992 | 15 | PACT MCR-V2-3015-60-80-5A-1 | 2277831 | 214 | PACT-FAST-MNT-W16-L65 | 2276641 | 223 |
| MINI MCR-DKL-LABEL | 2810272 | 88 | MP 1 | 2833631 | 372 | PACT MCR-V2-3015-60-100-5A-1 | 2277064 | 214 | PLC-2RPT-24DC/1 | 2901639 | 348 |
| MINI MCR-RTD-UI-NC | 2902849 | 76 | MP 2 | 2833644 | 378 | PACT MCR-V2-3015-60-125-5A-1 | 2277624 | 214 | PLC-2RSC-24DC/ 1 | 2987309 | 348 |
| MINI MCR-RTD-UI-SP-NC | 2902850 | 76 | MPS-IH BK | 0201731 | 191 | PACT MCR-V2-3015-60-150-5A-1 | 2277077 | 214 | PLC-2RSP-24DC/ 1 | 2987312 | 348 |
| MINI MCR-SL-1CP-I | 2864419 | 74 | MPS-IH BU | 0201689 | 191 | PACT MCR-V2-3015-60-150-5A-1 | 2277844 | 214 | PLC-ATP BK | 2966841 | 368 |
| MINI MCR-SL-1CP-I-I-SP | 2864749 | 74 | MPS-IH GN | 0201702 | 191 | PACT MCR-V2-3015-60-200-5A-1 | 2277637 | 214 | PLC-BP A1-14 | 2980283 | 368 |
| MINI MCR-SL-2CP-I | 2864655 | 74 | MPS-IH GY | 0201728 | 191 | PACT MCR-V2-3015-60-200-5A-1 | 2277857 | 214 | PLC-BPT-24DC/21RW | 2900261 | 360 |
| MINI MCR-SL-2CP-I-I-SP | 2864781 | 74 | MPS-IH RD | 0201676 | 191 | PACT MCR-V2-3015-60-250-5A-1 | 2277080 | 214 | PLC-BPT-24UC/ 1/ACT | 2900450 | 329 |
| MINI MCR-SL-CVS-24-5-10-NC | 2902822 | 87 | MPS-IH WH | 0201663 | 191 | PACT MCR-V2-3015-60-250-5A-1 | 2277860 | 214 | PLC-BPT-120UC/ 1/SEN/SO46 | 2900456 | 335 |
| MINI MCR-SL-CVS-24-5-10-SP-NC | 2902823 | 87 | MPS-IH YE | 0201692 | 191 | PACT MCR-V2-3015-60-300-5A-1 | 2277640 | 214 | PLC-BPT-120UC/21/SO46 | 2900453 | 334 |
| MINI MCR-SL-F-UI-NC | 2902832 | 82 | MPS-MT | 0201744 | 191 | PACT MCR-V2-3015-60-400-5A-1 | 2277093 | 214 | PLC-BPT-230UC/ 1/SEN/SO46 | 2900457 | 335 |
| MINI MCR-SL-F-UI-SP-NC | 2902833 | 82 | | | | PACT MCR-V2-3015-60-500-5A-1 | 2277653 | 214 | PLC-BPT-230UC/21/SO46 | 2900455 | 334 |
| MINI MCR-SL-FM-RC-NC | 2902961 | 89 | | | | PACT MCR-V2-3015-60-600-5A-1 | 2277103 | 214 | PLC-BPT-TTL/1 | 2900458 | 356 |
| MINI MCR-SL-FM-RC-SP-NC | 2902962 | 89 | | | | PACT MCR-V2-3015-60-750-5A-1 | 2277666 | 214 | PLC-BSC-24UC/ 1/ACT | 2982799 | 329 |
| MINI MCR-SL-I | 2864406 | 71 | | | | PACT MCR-V2-4012-70-250-5A-1 | 2277116 | 215 | PLC-BSC-120UC/ 1/SEN/SO46 | 2980322 | 335 |
| MINI MCR-SL-I-I-SP | 2864723 | 71 | | | | PACT MCR-V2-4012-70-300-5A-1 | 2277679 | 215 | PLC-BSC-120UC/21-21/SO46 | 2980416 | 335 |
| MINI MCR-SL-I-U-0 | 2813541 | 71 | | | | PACT MCR-V2-4012-70-400-5A-1 | 2277129 | 215 | PLC-BSC-120UC/21/SO46 | 2980319 | 335 |
| MINI MCR-SL-I-U-0-SP | 2813554 | 71 | | | | PACT MCR-V2-4012-70-500-5A-1 | 2277682 | 215 | PLC-BSC-120UC/21HC/SO46 | 2980432 | 334 |
| MINI MCR-SL-I-U-4 | 2813538 | 71 | OPT-5DC/ 24DC/ 2 | 2967989 | 340 | PACT MCR-V2-4012-70-600-5A-1 | 2277132 | 215 | PLC-BSC-230UC/ 1/SEN/SO46 | 2980348 | 335 |
| MINI MCR-SL-I-U-4-SP | 2813567 | 71 | OPT-5DC/ 24DC/ 5 | 2982113 | 288 | PACT MCR-V2-4012-70-750-5A-1 | 2277695 | 215 | PLC-BSC-230UC/21-21/SO46 | 2980429 | 335 |
| MINI MCR-SL-MUX-V8-FLK 16 | 2811815 | 95 | OPT-5DC/ 48DC/ 100 | 2967992 | 340 | PACT MCR-V2-4012-70-800-5A-1 | 2277145 | 215 | PLC-BSC-230UC/21/SO46 | 2980335 | 334 |
| MINI MCR-SL-NAM-2RNO | 2864105 | 86 | OPT-5DC/230AC/ 2 | 2982168 | 289 | PACT MCR-V2-4012-70-1000-5A-1 | 2277158 | 215 | PLC-BSC-230UC/21HC/SO46 | 2980445 | 335 |
| MINI MCR-SL-NAM-2RNO-SP | 2810269 | 86 | OPT-24DC/ 24DC/ 2 | 2966595 | 280 | PACT MCR-V2-5012-85-150-5A-1 | 2276117 | 216 | PLC-BSC-TTL/1 | 2982689 | 356 |
| MINI MCR-SL-PT100-LP | 2810298 | 79 | OPT-24DC/ 24DC/ 5 | 2982100 | 288 | PACT MCR-V2-5012-85-200-5A-1 | 2276120 | 216 | PLC-BSP-24DC/21RW | 2961396 | 360 |
| MINI MCR-SL-PT100-LP-NC | 2810308 | 79 | OPT-24DC/ 48DC/100 | 2966618 | 340 | PACT MCR-V2-5012-85-250-5A-1 | 2276133 | 216 | PLC-BSP-24UC/ 1/ACT | 2982809 | 329 |
| MINI MCR-SL-PT100-LP-NC-SP | 2810395 | 79 | OPT-24DC/230AC/ 1 | 2967950 | 281 | PACT MCR-V2-5012-85-300-5A-1 | 2276146 | 216 | PLC-BSP-120UC/ 1/SEN/SO46 | 2980364 | 335 |
| MINI MCR-SL-PT100-LP-SP | 2810382 | 79 | OPT-24DC/230AC/ 2 | 2982171 | 289 | PACT MCR-V2-5012-85-400-5A-1 | 2277161 | 216 | PLC-BSP-120UC/21/SO46 | 2980351 | 334 |
| MINI MCR-SL-PT100-UI | 2864435 | 77 | OPT-60DC/ 24DC/ 2 | 2966605 | 340 | PACT MCR-V2-5012-85-500-5A-1 | 2276159 | 216 | PLC-BSP-230UC/ 1/SEN/SO46 | 2980380 | 335 |
| MINI MCR-SL-PT100-UI-200 | 2864309 | 77 | OPT-60DC/ 24DC/ 5 | 2982126 | 288 | PACT MCR-V2-5012-85-600-5A-1 | 2276162 | 216 | PLC-BSP-230UC/21/SO46 | 2980377 | 334 |
| MINI MCR-SL-PT100-UI-200-NC | 2864370 | 77 | OPT-60DC/ 48DC/100 | 2966621 | 340 | PACT MCR-V2-5012-85-600-5A-1 | 2277174 | 216 | PLC-BSP-TTL/1 | 2982692 | 356 |
| MINI MCR-SL-PT100-UI-200-SP | 2864192 | 77 | OPT-60DC/230AC/ 1 | 2967963 | 341 | PACT MCR-V2-5012-85-750-5A-1 | 2276175 | 216 | PLC-ESK GY | 2966508 | 368 |
| MINI MCR-SL-PT100-UI-200-SP-NC | 2864202 | 77 | OPT-60DC/230AC/ 2 | 2982184 | 289 | PACT MCR-V2-5012-85-800-5A-1 | 2277187 | 216 | PLC-OPT- 5DC/ 24DC/100KHZ | 2902969 | 354 |
| MINI MCR-SL-PT100-UI-NC | 2864273 | 78 | OV-24DC/ 60DC/4 | 2982647 | 559 | PACT MCR-V2-5012-85-1000-5A-1 | 2276463 | 216 | PLC-OPT- 5DC/ 24DC/3WR | 2900375 | 327 |
| MINI MCR-SL-PT100-UI-SP | 2864736 | 78 | OV-24DC/350DC/1 | 2982634 | 558 | PACT MCR-V2-5012-85-1000-5A-1 | 2277190 | 216 | PLC-OPT- 5DC/ 5DC/100KHZ-G | 2902971 | 355 |
| MINI MCR-SL-PT100-UI-SP-NC | 2864286 | 78 | OV-24DC/480AC/5 | 2982650 | 559 | PACT MCR-V2-5012-85-1250-5A-1 | 2277200 | 216 | PLC-OPT- 5DC/24DC/100KHZ-G | 2902973 | 355 |
| MINI MCR-SL-PTB | 2864134 | 90 | | | | PACT MCR-V2-5012-85-1500-5A-1 | 2276188 | 216 | PLC-OPT- 5DC/300DC/1 | 2900381 | 352 |
| MINI MCR-SL-PTB-FM | 2902958 | 89 | | | | PACT MCR-V2-5012-85-200-5A-1 | 2277873 | 217 | PLC-OPT- 12DC/300DC/1 | 2900382 | 352 |
| MINI MCR-SL-PTB-FM-SP | 2902959 | 89 | | | | PACT MCR-V2-6015-85-250-5A-1 | 2277886 | 217 | PLC-OPT- 24DC/ 24DC/10R | 2900398 | 353 |
| MINI MCR-SL-PTB-SP | 2864147 | 90 | | | | PACT MCR-V2-6015-85-300-5A-1 | 2277899 | 217 | PLC-OPT- 24DC/ 24DC/2 | 2900364 | 325 |
| MINI MCR-SL-R-UI | 2864095 | 84 | | | | PACT MCR-V2-6015-85-400-5A-1 | 2277909 | 217 | PLC-OPT- 24DC/ 24DC/2/ACT | 2900376 | 327 |
| MINI MCR-SL-R-UI-SP | 2810256 | 84 | | | | PACT MCR-V2-6015-85-500-5A-1 | 2277912 | 217 | PLC-OPT- 24DC/ 24DC/3WR | 2900379 | 359 |
| MINI MCR-SL-RPS-I | 2864422 | 73 | | | | PACT MCR-V2-6015-85-600-5A-1 | 2277925 | 217 | PLC-OPT- 24DC/ 48DC/100 | 2900352 | 324 |
| MINI MCR-SL-RPS-I-I-SP | 2864752 | 73 | PACT MCR-CB-21-8 | 2277569 | 223 | PACT MCR-V2-6015-85-750-5A-1 | 2277938 | 217 | PLC-OPT- 24DC/ 48DC/100/SEN | 2900358 | 351 |
| MINI MCR-SL-RPSS-I | 2864079 | 73 | PACT MCR-CB-21-12 | 2277556 | 223 | PACT MCR-V2-6015-85-800-5A-1 | 2277941 | 217 | PLC-OPT- 24DC/ 48DC/500W | 2900378 | 333 |
| MINI MCR-SL-RPSS-I-I-SP | 2810230 | 73 | PACT MCR-CB-28-12 | 2277543 | 223 | PACT MCR-V2-6015-85-1000-5A-1 | 2277954 | 217 | PLC-OPT- 24DC/ 5DC/100KHZ-G | 2902972 | 355 |
| MINI MCR-SL-SHUNT-UI | 2810858 | 68 | PACT MCR-CB-42-12 | 2277530 | 223 | PACT MCR-V2-6015-85-1250-5A-1 | 2277967 | 217 | PLC-OPT- 24DC/110DC/3WR | 2900391 | 359 |
| MINI MCR-SL-SHUNT-UI-NC | 2810780 | 68 | PACT MCR-ETC-60 | 2277572 | 223 | PACT MCR-V2-6015-85-1500-5A-1 | 2277970 | 217 | PLC-OPT- 24DC/230AC/1 | 2900369 | 325 |
| MINI MCR-SL-SHUNT-UI-SP | 2810874 | 68 | PACT MCR-ETC-75 | 2277585 | 223 | PACT MCR-V2-6015-85-1600-5A-1 | 2277983 | 217 | PLC-OPT- 24DC/24DC/100KHZ | 2902970 | 354 |
| MINI MCR-SL-SHUNT-UI-SP-NC | 2810793 | 68 | PACT MCR-ICAP | 2277608 | 223 | PACT MCR-V2-6040-96-600-5A-1 | 2276191 | 218 | PLC-OPT- 24DC/24DC/100KHZ-G | 2902974 | 355 |
| MINI MCR-SL-TB | 2811420 | 80 | PACT MCR-RA | 2277598 | 223 | PACT MCR-V2-6040-96-750-5A-1 | 2276201 | 218 | PLC-OPT- 24DC/300DC/1 | 2900383 | 352 |
| MINI MCR-SL-TC-UI | 2864448 | 81 | PACT MCR-V1-21-44 | 2277268 | 213 | PACT MCR-V2-6040-96-800-5A-1 | 2276214 | 218 | PLC-OPT- 24DC/TTL | 2900363 | 358 |
| MINI MCR-SL-TC-UI-NC | 2864299 | 81 | PACT MCR-V1-21-44-150-5A-1 | 2277019 | 213 | PACT MCR-V2-6040-96-1000-5A-1 | 2277705 | 218 | PLC-OPT- 36DC/110DC/3WR | 2900392 | 359 |
| MINI MCR-SL-UI-0 | | | | | | | | | | | |

| Type | Order No. | Page | Type | Order No. | Page | Type | Order No. | Page | Type | Order No. | Page |
|----------------------------|-----------|------|----------------------------|-----------|------|-------------------------|-----------|------|---------------------------|-----------|------|
| PLC-OPT-110DC/24DC/3RW | 2900380 | 359 | PLC-OSP-60DC/230AC/ 1 | 2967918 | 325 | PLC-RSC-12DC/21AU | 2966919 | 323 | PLC-RSP-110UC/21-21/RW | 2987147 | 363 |
| PLC-OPT-110DC/110DC/3RW | 2900396 | 359 | PLC-OSP-60DC/300DC/ 1 | 2980843 | 352 | PLC-RSC-12DC/21HC | 2967617 | 333 | PLC-RSP-110UC/21-21AU/RW | 2987150 | 363 |
| PLC-OPT-110DC/300DC/1 | 2900385 | 352 | PLC-OSP-72DC/110DC/ 3RW | 2982540 | 359 | PLC-RSC-24DC/1-1/ACT | 2967109 | 327 | PLC-RSP-110UC/21/RW | 2987053 | 362 |
| PLC-OPT-120AC/300DC/1 | 2900388 | 352 | PLC-OSP-96DC/110DC/ 3RW | 2982553 | 359 | PLC-RSC-24DC/1/ACT | 2966210 | 326 | PLC-RSP-110UC/21AU/RW | 2987066 | 362 |
| PLC-OPT-120UC/24DC/2 | 2900367 | 325 | PLC-OSP-110DC/24DC/ 3RW | 2980526 | 359 | PLC-RSC-24DC/1AU/SEN | 2966317 | 330 | PLC-RSP-110UC/21HC/RW | 2987095 | 363 |
| PLC-OPT-120UC/48DC/100 | 2900355 | 324 | PLC-OSP-110DC/110DC/ 3RW | 2982566 | 359 | PLC-RSC-24DC/1IC/ACT | 2967604 | 332 | PLC-RSP-120UC/1AU/SEN | 2967390 | 363 |
| PLC-OPT-120UC/48DC/100/SEN | 2900359 | 331 | PLC-OSP-110DC/300DC/ 1 | 2980856 | 352 | PLC-RSC-24DC/21 | 2966171 | 322 | PLC-RSP-120UC/21 | 2966324 | 322 |
| PLC-OPT-120UC/230AC/1 | 2900372 | 325 | PLC-OSP-120AC/300DC/ 1 | 2980872 | 352 | PLC-RSC-24DC/21-21 | 2967060 | 323 | PLC-RSP-120UC/21-21 | 2912549 | 323 |
| PLC-OPT-220DC/300DC/1 | 2900387 | 352 | PLC-OSP-120UC/24DC/ 2 | 2967484 | 325 | PLC-RSC-24DC/21-21AU | 2967125 | 323 | PLC-RSP-120UC/2121AU | 2912617 | 323 |
| PLC-OPT-230AC/300DC/1 | 2900389 | 352 | PLC-OSP-120UC/48DC/100 | 2967552 | 324 | PLC-RSC-24DC/21AU | 2966265 | 323 | PLC-RSP-120UC/21AU | 2966582 | 323 |
| PLC-OPT-230UC/24DC/2 | 2900368 | 325 | PLC-OSP-120UC/48DC/100/SEN | 2967581 | 331 | PLC-RSC-24DC/21HC | 2967620 | 333 | PLC-RSP-120UC/21HC | 2912316 | 333 |
| PLC-OPT-230UC/48DC/100 | 2900356 | 324 | PLC-OSP-120UC/230AC/ 1 | 2967921 | 325 | PLC-RSC-24UC/1/S/H | 2982236 | 350 | PLC-RSP-230UC/1AU/SEN | 2967413 | 330 |
| PLC-OPT-230UC/48DC/100/SEN | 2900361 | 331 | PLC-OSP-220DC/300DC/ 1 | 2980869 | 352 | PLC-RSC-24UC/1/S/L | 2834876 | 350 | PLC-RSP-230UC/21 | 2966537 | 322 |
| PLC-OPT-230UC/230AC/1 | 2900374 | 325 | PLC-OSP-230AC/300DC/ 1 | 2980885 | 352 | PLC-RSC-24UC/21 | 2966184 | 322 | PLC-RSP-230UC/21-21 | 2912552 | 323 |
| PLC-OPT-LPE-24DC/48DC/100 | 2903173 | 366 | PLC-OSP-230UC/24DC/ 2 | 2967497 | 325 | PLC-RSC-24UC/21-21 | 2967073 | 323 | PLC-RSP-230UC/21-21AU | 2912620 | 323 |
| PLC-OSC-5DC/5DC/100KHZ-G | 2902965 | 355 | PLC-OSP-230UC/48DC/100 | 2967565 | 324 | PLC-RSC-24UC/21-21AU | 2967112 | 323 | PLC-RSP-230UC/21-21AU/RWF | 2968001 | 361 |
| PLC-OSC-5DC/24DC/ 2/ACT | 2980144 | 327 | PLC-OSP-230UC/48DC/100/SEN | 2967594 | 331 | PLC-RSC-24UC/21AU | 2966278 | 323 | PLC-RSP-230UC/21AU | 2966647 | 323 |
| PLC-OSC-5DC/24DC/100KHZ-G | 2900367 | 355 | PLC-OSP-230UC/230AC/ 1 | 2967934 | 325 | PLC-RSC-24UC/21HC | 2967633 | 333 | PLC-RSP-230UC/21HC | 2912329 | 333 |
| PLC-OSC-5DC/24DC/100KHZ | 2902963 | 354 | PLC-PT-EIK 1-SVN 24P/P | 2900397 | 364 | PLC-RSC-48DC/21 | 2966113 | 322 | PLC-SC-EIK 1-SVN 24P/P | 2982663 | 364 |
| PLC-OSC-5DC/300DC/ 1 | 2980652 | 352 | PLC-RPT-12DC/21 | 2900316 | 322 | PLC-RSC-48DC/21-21 | 2967248 | 323 | PLC-SC-ELR W1/ 2-24DC | 2980539 | 365 |
| PLC-OSC-12DC/300DC/ 1 | 2980665 | 352 | PLC-RPT-12DC/21-21 | 2900329 | 323 | PLC-RSC-48DC/21-21AU | 2967280 | 323 | PLC-SC-S/H | 2980733 | 351 |
| PLC-OSC-24DC/5DC/100KHZ-G | 2902967 | 355 | PLC-RPT-12DC/21-21AU | 2900337 | 323 | PLC-RSC-48DC/21AU | 2966126 | 323 | PLC-SC-S/L | 2980775 | 351 |
| PLC-OSC-24DC/24DC/ 2 | 2966634 | 325 | PLC-RPT-12DC/21AU | 2900317 | 323 | PLC-RSC-48DC/21HC | 2967646 | 333 | PLC-SP-EIK 1-SVN 24P/P | 2982676 | 364 |
| PLC-OSC-24DC/24DC/ 2/ACT | 2966676 | 327 | PLC-RPT-12DC/21HC | 2900290 | 333 | PLC-RSC-60DC/21 | 2966139 | 322 | PLC-SP-ELR W1/ 2-24DC | 2980555 | 365 |
| PLC-OSC-24DC/24DC/ 5/ACT | 2982786 | 328 | PLC-RPT-24DC/1/ACT | 2900312 | 326 | PLC-RSC-60DC/21-21 | 2967293 | 323 | PLC-SP-S/H | 2980746 | 351 |
| PLC-OSC-24DC/24DC/10/R | 2982702 | 353 | PLC-RPT-24DC/1AU/SEN | 2900313 | 330 | PLC-RSC-60DC/21-21AU | 2967303 | 323 | PLC-SP-S/L | 2980788 | 351 |
| PLC-OSC-24DC/24DC/100KHZ-G | 2902968 | 355 | PLC-RPT-24DC/1IC/ACT | 2900298 | 332 | PLC-RSC-60DC/21AU | 2966142 | 323 | PLC-V8/D15B/IN | 2296087 | 369 |
| PLC-OSC-24DC/48DC/100 | 2966728 | 324 | PLC-RPT-24DC/21 | 2900299 | 332 | PLC-RSC-60DC/21HC | 2967659 | 333 | PLC-V8/D15B/OUT | 2296061 | 369 |
| PLC-OSC-24DC/48DC/100/SEN | 2966773 | 331 | PLC-RPT-24DC/21-21 | 2900330 | 323 | PLC-RSC-120UC/1AU/SEN | 2966320 | 330 | PLC-V8/D15S/IN | 2296074 | 369 |
| PLC-OSC-24DC/48DC/500/W | 2980636 | 353 | PLC-RPT-24DC/21-21AU | 2900338 | 323 | PLC-RSC-120UC/21 | 2966197 | 322 | PLC-V8/D15S/OUT | 2296058 | 369 |
| PLC-OSC-24DC/230AC/ 1 | 2967840 | 325 | PLC-RPT-24DC/21AU | 2900306 | 323 | PLC-RSC-120UC/21-21 | 2967086 | 323 | PLC-V8/FLK14/IN | 2296553 | 369 |
| PLC-OSC-24DC/230AC/ 1/ACT | 2967947 | 327 | PLC-RPT-24DC/21HC | 2900291 | 333 | PLC-RSC-120UC/21-21AU | 2967138 | 323 | PLC-V8/FLK14/IN/M | 2304115 | 369 |
| PLC-OSC-24DC/230AC/ 2/ACT | 2982760 | 328 | PLC-RPT-24UC/1/S/H | 2900328 | 350 | PLC-RSC-120UC/21AU | 2966281 | 323 | PLC-V8/FLK14/OUT | 2295554 | 369 |
| PLC-OSC-24DC/24DC/100KHZ | 2902964 | 354 | PLC-RPT-24UC/1/S/L | 2900327 | 350 | PLC-RSC-120UC/21HC | 2967662 | 333 | PLC-V8/FLK14/OUT/M | 2304102 | 369 |
| PLC-OSC-24DC/300DC/ 1 | 2980678 | 352 | PLC-RPT-24UC/21 | 2900300 | 322 | PLC-RSC-230UC/1AU/SEN | 2966333 | 330 | PLC-V8/FLK14/OUT | 2299660 | 369 |
| PLC-OSC-24DC/TTL | 2982728 | 358 | PLC-RPT-24UC/21-21 | 2900332 | 323 | PLC-RSC-230UC/21 | 2966207 | 322 | PLC-V8/FLK14/OUT/M | 2304306 | 369 |
| PLC-OSC-48DC/24DC/ 2 | 2967002 | 325 | PLC-RPT-24UC/21-21/RW | 2900346 | 363 | PLC-RSC-230UC/21-21 | 2967099 | 323 | PLC-VT | 2296870 | 486 |
| PLC-OSC-48DC/48DC/100 | 2966993 | 324 | PLC-RPT-24UC/21-21AU | 2900339 | 323 | PLC-RSC-230UC/21-21AU | 2967141 | 323 | PLC-VT/ACT | 2295567 | 487 |
| PLC-OSC-48DC/230AC/ 1 | 2967853 | 325 | PLC-RPT-24UC/21-21AU/RW | 2900349 | 363 | PLC-RSC-230UC/21AU | 2966294 | 323 | PLC-VT/ACT/LA | 2296867 | 487 |
| PLC-OSC-60DC/24DC/ 2 | 2967468 | 325 | PLC-RPT-24UC/21/RW | 2900318 | 362 | PLC-RSC-230UC/21HC | 2967675 | 333 | PLC-VT/LA | 2296854 | 486 |
| PLC-OSC-60DC/48DC/100 | 2967455 | 324 | PLC-RPT-24UC/21AU | 2900307 | 323 | PLC-RSP-12DC/21 | 2967439 | 322 | PR1-BSC2/2X21 | 2833518 | 372 |
| PLC-OSC-60DC/230AC/ 1 | 2967866 | 325 | PLC-RPT-24UC/21AU/RW | 2900321 | 362 | PLC-RSP-12DC/21-21 | 2912497 | 323 | PR1-BSC3/2X21 | 2833521 | 373 |
| PLC-OSC-60DC/300DC/ 1 | 2980681 | 352 | PLC-RPT-24UC/21HC | 2900293 | 333 | PLC-RSP-12DC/21-21AU | 2912565 | 323 | PR1-BSP3/2X21 | 2833534 | 373 |
| PLC-OSC-110DC/300DC/ 1 | 2980694 | 352 | PLC-RPT-24UC/21HC/RW | 2900324 | 363 | PLC-RSP-12DC/21AU | 2967442 | 323 | PR1-RSC3-LDP-24DC/21 | 2834326 | 390 |
| PLC-OSC-120AC/300DC/ 1 | 2980717 | 352 | PLC-RPT-48DC/21 | 2900301 | 322 | PLC-RSP-12DC/21HC | 2912264 | 333 | PR1-RSC3-LDP-24DC/21AU | 2834368 | 390 |
| PLC-OSC-120UC/24DC/ 2 | 2966650 | 325 | PLC-RPT-48DC/21-21 | 2900333 | 323 | PLC-RSP-24DC/1/ACT | 2967345 | 326 | PR1-RSC3-LDP-24DC/2X21 | 2834481 | 391 |
| PLC-OSC-120UC/48DC/100 | 2966744 | 324 | PLC-RPT-48DC/21-21AU | 2900340 | 323 | PLC-RSP-24DC/1AU/SEN | 2967374 | 330 | PR1-RSC3-LDP-24DC/2X21AU | 2834520 | 391 |
| PLC-OSC-120UC/48DC/100/SEN | 2966799 | 331 | PLC-RPT-48DC/21AU | 2900308 | 323 | PLC-RSP-24DC/1IC/ACT | 2912413 | 332 | PR1-RSC3-LV-24AC/21 | 2834339 | 390 |
| PLC-OSC-120UC/230AC/ 1 | 2967879 | 325 | PLC-RPT-48DC/21HC | 2900294 | 333 | PLC-RSP-24DC/21 | 2966472 | 322 | PR1-RSC3-LV-24AC/21AU | 2834371 | 390 |
| PLC-OSC-125DC/24DC/ 2 | 2980050 | 325 | PLC-RPT-60DC/21 | 2900303 | 322 | PLC-RSP-24DC/21-21 | 2912507 | 323 | PR1-RSC3-LV-24AC/2X21 | 2834494 | 391 |
| PLC-OSC-125DC/48DC/100 | 2980047 | 324 | PLC-RPT-60DC/21-21 | 2900334 | 323 | PLC-RSP-24DC/21-21AU | 2912578 | 323 | PR1-RSC3-LV-24AC/2X21AU | 2834533 | 391 |
| PLC-OSC-125DC/230AC/ 1 | 2980063 | 325 | PLC-RPT-60DC/21-21AU | 2900341 | 323 | PLC-RSP-24DC/21AU | 2966540 | 323 | PR1-RSC3-LV-120AC/21 | 2834342 | 390 |
| PLC-OSC-220DC/300DC/ 1 | 2980704 | 352 | PLC-RPT-60DC/21AU | 2900309 | 323 | PLC-RSP-24DC/21HC | 2912277 | 333 | PR1-RSC3-LV-120AC/21AU | 2834384 | 390 |
| PLC-OSC-230AC/300DC/ 1 | 2980720 | 352 | PLC-RPT-60DC/21HC | 2900295 | 333 | PLC-RSP-24UC/1/S/H | 2982249 | 350 | PR1-RSC3-LV-120AC/2X21 | 2834504 | 391 |
| PLC-OSC-230UC/24DC/ 2 | 2966663 | 325 | PLC-RPT-72UC/21-21/RW | 2900347 | 363 | PLC-RSP-24UC/1/S/L | 2834889 | 350 | PR1-RSC3-LV-120AC/2X21AU | 2834546 | 391 |
| PLC-OSC-230UC/48DC/100 | 2966757 | 324 | PLC-RPT-72UC/21-21AU/RW | 2900350 | 363 | PLC-RSP-24UC/21 | 2966485 | 322 | PR1-RSC3-LV-230AC/21 | 2834355 | 390 |
| PLC-OSC-230UC/48DC/100/SEN | 2966809 | 331 | PLC-RPT-72UC/21/RW | 2900319 | 362 | PLC-RSP-24UC/21-21 | 2912510 | 323 | PR1-RSC3-LV-230AC/21AU | 2834397 | 390 |
| PLC-OSC-230UC/230AC/ 1 | 2967882 | 325 | PLC-RPT-72UC/21AU/RW | 2900322 | 362 | PLC-RSP-24UC/21-21/RW | 2987105 | 363 | PR1-RSC3-LV-230AC/2X21 | 2834517 | 391 |
| PLC-OSC-LPE-24DC/48DC/100 | 2903171 | 366 | PLC-RPT-72UC/21HC/RW | 2900325 | 363 | PLC-RSP-24UC/21-21AU | 2912581 | 323 | PR1-RSC3-LV-230AC/2X21AU | 2834559 | 391 |
| PLC-OSP-5DC/24DC/ 2/ACT | 2980157 | 327 | PLC-RPT-110UC/21-21/RW | 2900348 | 363 | PLC-RSP-24UC/21-21AU/RW | 2987118 | 363 | PR1-RSP3-LDP-24DC/21 | 2834407 | 392 |
| PLC-OSP-5DC/300DC/ 1 | 2980814 | 352 | PLC-RPT-110UC/21-21AU/RW | 2900351 | 363 | PLC-RSP-24UC/21/RW | 2987011 | 362 | PR1-RSP3-LDP-24DC/21AU | 2834449 | 392 |
| PLC-OSP-12DC/300DC/ 1 | 2980827 | 352 | PLC-RPT-110UC/21/RW | 2900320 | 362 | PLC-RSP-24UC/21AU | 2966553 | 323 | PR1-RSP3-LDP-24DC/2X21 | 2834562 | 393 |
| PLC-OSP-24DC/24DC/ 2 | 2967471 | 325 | PLC-RPT-110UC/21AU/RW | 2900323 | 362 | PLC-RSP-24UC/21AU/RW | 2987024 | 362 | PR1-RSP3-LDP-24DC/2X21AU | 2834601 | 393 |
| PLC-OSP-24DC/24DC/ 2/ACT | 2967507 | 327 | PLC-RPT-110UC/21HC/RW | 2900326 | 363 | PLC-RSP-24UC/21HC | 2912280 | 333 | PR1-RSP3-LV-24AC/21 | 2834410 | 392 |
| PLC-OSP-24DC/24DC/ 3RW | 2980513 | 359 | PLC-RPT-120UC/1AU/SEN | 2900314 | 330 | PLC-RSP-24UC/21HC/RW | 2987079 | 363 | PR1-RSP3-LV-24AC/21AU | 2834452 | 392 |
| PLC-OSP-24DC/110DC/ 3RW | 2982524 | 358 | PLC-RPT-120UC/21 | 2900304 | 322 | PLC-RSP-48DC/21 | 2966498 | 322 | PR1-RSP3-LV-120AC/2X21 | 2834575 | 393 |
| PLC-OSP-24DC/48DC/100 | 2967549 | 324 | PLC-RPT-120UC/21-21 | 2900335 | 323 | PLC-RSP-48DC/21-21 | 2912523 | 323 | PR1-RSP3-LV-24AC/2X21AU | 2834614 | 393 |
| PLC-OSP-24DC/48DC/100/SEN | 2967578 | 331 | PLC-RPT-120UC/21-21AU | 2900342 | 323 | PLC-RSP-48DC/21-21AU | 2912594 | 323 | PR1-RSP3-LV-120AC/21 | 2834423 | 392 |
| PLC-OSP-24DC/48DC/500/W | 2980649 | 353 | PLC-RPT-120UC/21AU | 2900310 | 323 | PLC-RSP-48DC/21AU | 2966566 | 323 | PR1-RSP3-LV-120AC/21AU | 2834465 | |

Index

Alphabetical

| Type | Order No. | Page | Type | Order No. | Page | Type | Order No. | Page |
|-------------------------------|-----------|------|----------------------------|-----------|------|------|-----------|------|
| VIP-CAB-FLK14/FR/OE/0,14/1,0M | 2900123 | 502 | VIP-PA-FLK14/ 2,5M/S7 | 2322692 | 449 | | | |
| VIP-CAB-FLK14/FR/OE/0,14/1,5M | 2900125 | 502 | VIP-PA-FLK14/ 3,0M/S7 | 2322702 | 449 | | | |
| VIP-CAB-FLK14/FR/OE/0,14/2,0M | 2900126 | 502 | VIP-PA-FLK14/ 4,0M/S7 | 2322715 | 449 | | | |
| VIP-CAB-FLK14/FR/OE/0,14/3,0M | 2900127 | 502 | VIP-PA-FLK14/ 5,0M/S7 | 2322728 | 449 | | | |
| VIP-CAB-FLK14/FR/OE/0,14/4,0M | 2900128 | 502 | VIP-PA-FLK14/ 6,0M/S7 | 2322731 | 449 | | | |
| VIP-CAB-FLK14/FR/OE/0,14/6,0M | 2900129 | 502 | VIP-PA-FLK14/ 7,0M/S7 | 2322744 | 449 | | | |
| VIP-CAB-FLK16-0,14/... | 2318538 | 500 | VIP-PA-FLK14/ 8,0M/S7 | 2322757 | 449 | | | |
| VIP-CAB-FLK16/0,14/0,5M | 2318460 | 500 | VIP-PA-FLK14/10,0M/S7 | 2322760 | 449 | | | |
| VIP-CAB-FLK16/0,14/1,0M | 2318473 | 500 | VIP-PA-FLK50-4X14-S7/... | 2900886 | 449 | | | |
| VIP-CAB-FLK16/0,14/1,5M | 2318486 | 500 | VIP-PA-FLK50-S7/... | 2900885 | 448 | | | |
| VIP-CAB-FLK16/0,14/2,0M | 2318499 | 500 | VIP-PA-FLK50/ 0,5M/S7 | 2322443 | 448 | | | |
| VIP-CAB-FLK16/0,14/3,0M | 2318509 | 500 | VIP-PA-FLK50/ 1,0M/S7 | 2322456 | 448 | | | |
| VIP-CAB-FLK16/0,14/4,0M | 2318512 | 500 | VIP-PA-FLK50/ 1,5M/S7 | 2322469 | 448 | | | |
| VIP-CAB-FLK16/0,14/6,0M | 2318525 | 500 | VIP-PA-FLK50/ 2,0M/S7 | 2321800 | 448 | | | |
| VIP-CAB-FLK16/FR/OE/0,14/0,5M | 2900130 | 502 | VIP-PA-FLK50/ 2,5M/S7 | 2322472 | 448 | | | |
| VIP-CAB-FLK16/FR/OE/0,14/1,0M | 2900131 | 502 | VIP-PA-FLK50/ 3,0M/S7 | 2322485 | 448 | | | |
| VIP-CAB-FLK16/FR/OE/0,14/1,5M | 2900132 | 502 | VIP-PA-FLK50/ 4,0M/S7 | 2322498 | 448 | | | |
| VIP-CAB-FLK16/FR/OE/0,14/2,0M | 2900133 | 502 | VIP-PA-FLK50/ 5,0M/S7 | 2322508 | 448 | | | |
| VIP-CAB-FLK16/FR/OE/0,14/3,0M | 2900134 | 502 | VIP-PA-FLK50/ 6,0M/S7 | 2322511 | 448 | | | |
| VIP-CAB-FLK16/FR/OE/0,14/4,0M | 2900135 | 502 | VIP-PA-FLK50/ 7,0M/S7 | 2322524 | 448 | | | |
| VIP-CAB-FLK16/FR/OE/0,14/6,0M | 2900136 | 502 | VIP-PA-FLK50/ 8,0M/S7 | 2322537 | 448 | | | |
| VIP-CAB-FLK20-0,14/... | 2318619 | 500 | VIP-PA-FLK50/10,0M/S7 | 2322540 | 448 | | | |
| VIP-CAB-FLK20/0,14/0,5M | 2318541 | 500 | VIP-PA-FLK50/4X14/ 0,5M/S7 | 2322553 | 449 | | | |
| VIP-CAB-FLK20/0,14/1,0M | 2318554 | 500 | VIP-PA-FLK50/4X14/ 1,0M/S7 | 2322566 | 449 | | | |
| VIP-CAB-FLK20/0,14/1,5M | 2318567 | 500 | VIP-PA-FLK50/4X14/ 1,5M/S7 | 2322579 | 449 | | | |
| VIP-CAB-FLK20/0,14/2,0M | 2318570 | 500 | VIP-PA-FLK50/4X14/ 2,0M/S7 | 2321910 | 449 | | | |
| VIP-CAB-FLK20/0,14/3,0M | 2318583 | 500 | VIP-PA-FLK50/4X14/ 2,5M/S7 | 2322582 | 449 | | | |
| VIP-CAB-FLK20/0,14/4,0M | 2318596 | 500 | VIP-PA-FLK50/4X14/ 3,0M/S7 | 2322595 | 449 | | | |
| VIP-CAB-FLK20/0,14/6,0M | 2318606 | 500 | VIP-PA-FLK50/4X14/ 4,0M/S7 | 2322605 | 449 | | | |
| VIP-CAB-FLK20/FR/OE/0,14/0,5M | 2900138 | 503 | VIP-PA-FLK50/4X14/ 5,0M/S7 | 2322618 | 449 | | | |
| VIP-CAB-FLK20/FR/OE/0,14/1,0M | 2900139 | 503 | VIP-PA-FLK50/4X14/ 6,0M/S7 | 2322621 | 449 | | | |
| VIP-CAB-FLK20/FR/OE/0,14/1,5M | 2900141 | 503 | VIP-PA-FLK50/4X14/ 7,0M/S7 | 2322634 | 449 | | | |
| VIP-CAB-FLK20/FR/OE/0,14/2,0M | 2900142 | 503 | VIP-PA-FLK50/4X14/ 8,0M/S7 | 2322647 | 449 | | | |
| VIP-CAB-FLK20/FR/OE/0,14/3,0M | 2900143 | 503 | VIP-PA-FLK50/4X14/10,0M/S7 | 2322650 | 449 | | | |
| VIP-CAB-FLK20/FR/OE/0,14/4,0M | 2900144 | 503 | VS-937/... | 1402611 | 48 | | | |
| VIP-CAB-FLK20/FR/OE/0,14/6,0M | 2900145 | 503 | | | | | | |
| VIP-CAB-FLK26-0,14/... | 2318693 | 501 | | | | | | |
| VIP-CAB-FLK26/0,14/0,5M | 2318622 | 501 | | | | | | |
| VIP-CAB-FLK26/0,14/1,0M | 2318635 | 501 | | | | | | |
| VIP-CAB-FLK26/0,14/1,5M | 2318648 | 501 | | | | | | |
| VIP-CAB-FLK26/0,14/2,0M | 2318651 | 501 | ZB 15:UNBEDRUCKT | 0811972 | 318 | | | |
| VIP-CAB-FLK26/0,14/3,0M | 2318664 | 501 | ZB 5 :UNBEDRUCKT | 1050004 | 318 | | | |
| VIP-CAB-FLK26/0,14/4,0M | 2318677 | 501 | ZB 6.LGS:FORTL.ZAHLEN | 1051016 | 368 | | | |
| VIP-CAB-FLK26/0,14/6,0M | 2318680 | 501 | ZB 6:UNBEDRUCKT | 1051003 | 318 | | | |
| VIP-CAB-FLK34-0,14/... | 2318774 | 501 | | | | | | |
| VIP-CAB-FLK34/0,14/0,5M | 2318703 | 501 | | | | | | |
| VIP-CAB-FLK34/0,14/1,0M | 2318716 | 501 | | | | | | |
| VIP-CAB-FLK34/0,14/1,5M | 2318729 | 501 | | | | | | |
| VIP-CAB-FLK34/0,14/2,0M | 2318732 | 501 | | | | | | |
| VIP-CAB-FLK34/0,14/3,0M | 2318745 | 501 | | | | | | |
| VIP-CAB-FLK34/0,14/4,0M | 2318758 | 501 | | | | | | |
| VIP-CAB-FLK34/0,14/6,0M | 2318761 | 501 | | | | | | |
| VIP-CAB-FLK40-0,14/... | 2318855 | 501 | | | | | | |
| VIP-CAB-FLK40/0,14/0,5M | 2318787 | 501 | | | | | | |
| VIP-CAB-FLK40/0,14/1,0M | 2318790 | 501 | | | | | | |
| VIP-CAB-FLK40/0,14/1,5M | 2318800 | 501 | | | | | | |
| VIP-CAB-FLK40/0,14/2,0M | 2318813 | 501 | | | | | | |
| VIP-CAB-FLK40/0,14/3,0M | 2318826 | 501 | | | | | | |
| VIP-CAB-FLK40/0,14/4,0M | 2318839 | 501 | | | | | | |
| VIP-CAB-FLK40/0,14/6,0M | 2318842 | 501 | | | | | | |
| VIP-CAB-FLK50-0,14/... | 2318936 | 501 | | | | | | |
| VIP-CAB-FLK50/0,14/0,5M | 2318868 | 501 | | | | | | |
| VIP-CAB-FLK50/0,14/1,0M | 2318871 | 501 | | | | | | |
| VIP-CAB-FLK50/0,14/1,5M | 2318884 | 501 | | | | | | |
| VIP-CAB-FLK50/0,14/2,0M | 2318897 | 501 | | | | | | |
| VIP-CAB-FLK50/0,14/3,0M | 2318907 | 501 | | | | | | |
| VIP-CAB-FLK50/0,14/4,0M | 2318910 | 501 | | | | | | |
| VIP-CAB-FLK50/0,14/6,0M | 2318923 | 501 | | | | | | |
| VIP-CAB-FLK50/FR/OE/0,14/0,5M | 2900146 | 503 | | | | | | |
| VIP-CAB-FLK50/FR/OE/0,14/1,0M | 2900147 | 503 | | | | | | |
| VIP-CAB-FLK50/FR/OE/0,14/1,5M | 2900148 | 503 | | | | | | |
| VIP-CAB-FLK50/FR/OE/0,14/2,0M | 2900149 | 503 | | | | | | |
| VIP-CAB-FLK50/FR/OE/0,14/3,0M | 2900150 | 503 | | | | | | |
| VIP-CAB-FLK50/FR/OE/0,14/4,0M | 2900151 | 503 | | | | | | |
| VIP-CAB-FLK50/FR/OE/0,14/6,0M | 2900152 | 503 | | | | | | |
| VIP-PA-FLK14-S7/... | 2900887 | 449 | | | | | | |
| VIP-PA-FLK14/ 0,5M/S7 | 2322663 | 449 | | | | | | |
| VIP-PA-FLK14/ 1,0M/S7 | 2322676 | 449 | | | | | | |
| VIP-PA-FLK14/ 1,5M/S7 | 2322689 | 449 | | | | | | |
| VIP-PA-FLK14/ 2,0M/S7 | 2321790 | 449 | | | | | | |

Z



Компания «Океан Электроники» предлагает заключение долгосрочных отношений при поставках импортных электронных компонентов на взаимовыгодных условиях!

Наши преимущества:

- Поставка оригинальных импортных электронных компонентов напрямую с производств Америки, Европы и Азии, а так же с крупнейших складов мира;
- Широкая линейка поставок активных и пассивных импортных электронных компонентов (более 30 млн. наименований);
- Поставка сложных, дефицитных, либо снятых с производства позиций;
- Оперативные сроки поставки под заказ (от 5 рабочих дней);
- Экспресс доставка в любую точку России;
- Помощь Конструкторского Отдела и консультации квалифицированных инженеров;
- Техническая поддержка проекта, помощь в подборе аналогов, поставка прототипов;
- Поставка электронных компонентов под контролем ВП;
- Система менеджмента качества сертифицирована по Международному стандарту ISO 9001;
- При необходимости вся продукция военного и аэрокосмического назначения проходит испытания и сертификацию в лаборатории (по согласованию с заказчиком);
- Поставка специализированных компонентов военного и аэрокосмического уровня качества (Xilinx, Altera, Analog Devices, Intersil, Interpoint, Microsemi, Actel, Aeroflex, Peregrine, VPT, Syfer, Eurofarad, Texas Instruments, MS Kennedy, Miteq, Cobham, E2V, MA-COM, Hittite, Mini-Circuits, General Dynamics и др.);

Компания «Океан Электроники» является официальным дистрибьютором и эксклюзивным представителем в России одного из крупнейших производителей разъемов военного и аэрокосмического назначения «JONHON», а так же официальным дистрибьютором и эксклюзивным представителем в России производителя высокотехнологичных и надежных решений для передачи СВЧ сигналов «FORSTAR».



JONHON

«JONHON» (основан в 1970 г.)

Разъемы специального, военного и аэрокосмического назначения:

(Применяются в военной, авиационной, аэрокосмической, морской, железнодорожной, горно- и нефтедобывающей отраслях промышленности)

«FORSTAR» (основан в 1998 г.)

ВЧ соединители, коаксиальные кабели, кабельные сборки и микроволновые компоненты:

(Применяются в телекоммуникациях гражданского и специального назначения, в средствах связи, РЛС, а так же военной, авиационной и аэрокосмической отраслях промышленности).



Телефон: 8 (812) 309-75-97 (многоканальный)

Факс: 8 (812) 320-03-32

Электронная почта: ocean@oceanchips.ru

Web: <http://oceanchips.ru/>

Адрес: 198099, г. Санкт-Петербург, ул. Калинина, д. 2, корп. 4, лит. А