

# ADSP-21160N

## SUMMARY

High Performance 32-Bit DSP—Applications in Audio, Medical, Military, Graphics, Imaging, and Communication

Super Harvard Architecture—Four Independent Buses for Dual Data Fetch, Instruction Fetch, and Nonintrusive, Zero-Overhead I/O

Backwards Compatible—Assembly Source Level Compatible with Code for ADSP-2106x DSPs

Single-Instruction-Multiple-Data (SIMD) Computational Architecture—Two 32-Bit IEEE Floating-Point Computation Units, Each with a Multiplier, ALU, Shifter, and Register File

Integrated Peripherals—Integrated I/O Processor, 4 M Bits On-Chip Dual-Ported SRAM, Glueless Multiprocessing Features, and Ports (Serial, Link, External Bus, and JTAG)

## KEY FEATURES

- 100 MHz (10 ns) Core Instruction Rate
- Single-Cycle Instruction Execution, Including SIMD Operations in Both Computational Units
- Dual Data Address Generators (DAGs) with Modulo and Bit-Reverse Addressing
- Zero-Overhead Looping and Single-Cycle Loop Setup, Providing Efficient Program Sequencing

## FUNCTIONAL BLOCK DIAGRAM

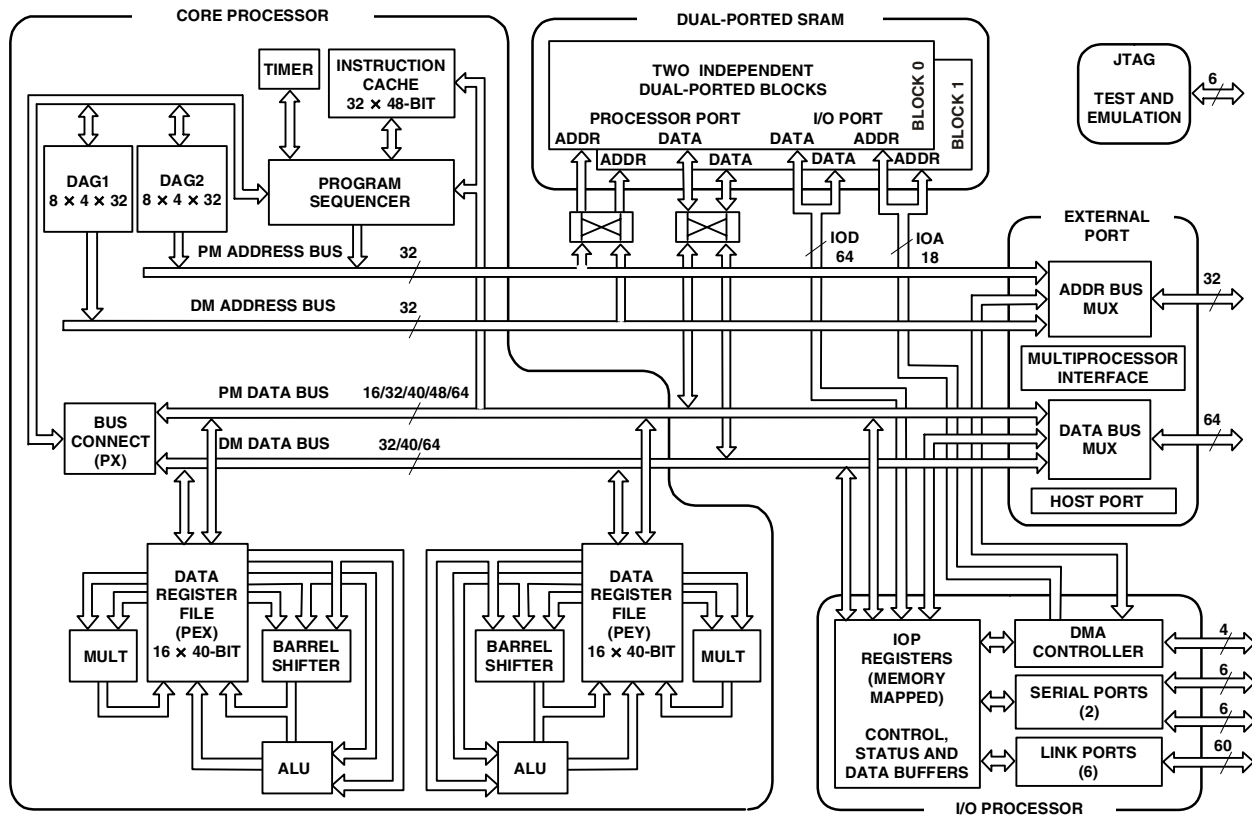

SHARC and the SHARC logo are registered trademarks of Analog Devices, Inc.

REV. 0

Information furnished by Analog Devices is believed to be accurate and reliable. However, no responsibility is assumed by Analog Devices for its use, nor for any infringements of patents or other rights of third parties that may result from its use. No license is granted by implication or otherwise under any patent or patent rights of Analog Devices. Trademarks and registered trademarks are the property of their respective companies.

One Technology Way, P.O.Box 9106, Norwood, MA 02062-9106, U.S.A.  
 Tel: 781/329-4700 [www.analog.com](http://www.analog.com)  
 Fax: 781/326-8703 © 2003 Analog Devices, Inc. All rights reserved.

# ADSP-21160N

## KEY FEATURES (continued)

IEEE 1149.1 JTAG Standard Test Access Port and On-Chip Emulation

400-Ball 27 mm × 27 mm Metric PBGA Package

200 Million Fixed-Point MACs Sustained Performance

Single Instruction Multiple Data (SIMD)

Architecture Provides:

Two Computational Processing Elements

Concurrent Execution—Each Processing Element Executes the Same Instruction, but Operates on Different Data

Code Compatibility—at Assembly Level, Uses the Same Instruction Set as the ADSP-2106x

SHARC DSPs

Parallelism in Buses and Computational Units Allows:

Single-Cycle Execution (with or without SIMD) of: A Multiply Operation, An ALU Operation, A Dual Memory Read or Write, and An Instruction Fetch Transfers Between Memory and Core at up to Four 32-Bit Floating- or Fixed-Point Words per Cycle Accelerated FFT Butterfly Computation Through a Multiply with Add and Subtract

4M Bits On-Chip Dual-Ported SRAM for Independent Access by Core Processor, Host, and DMA

DMA Controller Supports:

14 Zero-Overhead DMA Channels for Transfers Between ADSP-21160N Internal Memory and External Memory, External Peripherals, Host Processor, Serial Ports, or Link Ports

64-Bit Background DMA Transfers at Core Clock Speed, in Parallel with Full-Speed Processor Execution  
Host Processor Interface to 16- and 32-Bit Microprocessors

4G Word Address Range for Off-Chip Memory

Memory Interface Supports Programmable Wait State Generation and Page-Mode for Off-Chip Memory

Multiprocessing Support Provides:

Glueless Connection for Scalable DSP Multiprocessing Architecture

Distributed On-Chip Bus Arbitration for Parallel Bus Connect of up to Six ADSP-21160Ns Plus Host

Six Link Ports for Point-to-Point Connectivity and Array Multiprocessing

Serial Ports Provide:

Two 50M Bits/s Synchronous Serial Ports with Companding Hardware

Independent Transmit and Receive Functions

TDM Support for T1 and E1 Interfaces

64-Bit Wide Synchronous External Port Provides:

Glueless Connection to Asynchronous and SBSRAM External Memories

Up to 50 MHz Operation

## TABLE OF CONTENTS

<p><b>GENERAL DESCRIPTION</b> . . . . . 4</p> <p>ADSP-21160N Family Core Architecture . . . . . 4</p> <p>    SIMD Computational Engine . . . . . 5</p> <p>    Independent, Parallel Computation Units . . . . . 5</p> <p>    Data Register File . . . . . 5</p> <p>    Single-Cycle Fetch of Instruction and         Four Operands . . . . . 5</p> <p>    Instruction Cache . . . . . 5</p> <p>    Data Address Generators with Hardware         Circular Buffers . . . . . 5</p> <p>    Flexible Instruction Set . . . . . 5</p> <p>ADSP-21160N Memory and I/O Interface Features . 5</p> <p>    Dual-Ported On-Chip Memory . . . . . 5</p> <p>    Off-Chip Memory and Peripherals Interface . . . . . 5</p> <p>    DMA Controller . . . . . 6</p> <p>    Multiprocessing . . . . . 6</p> <p>    Link Ports . . . . . 8</p> <p>    Serial Ports . . . . . 8</p> <p>    Host Processor Interface . . . . . 8</p> <p>    Program Booting . . . . . 8</p> <p>    Phase-Locked Loop . . . . . 8</p> <p>    Power Supplies . . . . . 8</p> <p>Development Tools . . . . . 8</p> <p>Designing an Emulator-Compatible     DSP Board (Target) . . . . . 9</p> <p>    Additional Information . . . . . 9</p> <p><b>PIN FUNCTION DESCRIPTIONS</b> . . . . . 9</p> <p><b>SPECIFICATIONS</b> . . . . . 14</p> <p>    <b>ABSOLUTE MAXIMUM RATINGS</b> . . . . . 15</p> <p>    <b>ESD SENSITIVITY</b> . . . . . 15</p> <p>    <b>TIMING SPECIFICATIONS</b> . . . . . 16</p>	<p>    Power-up Sequencing . . . . . 16</p> <p>    Clock Input . . . . . 18</p> <p>    Reset . . . . . 18</p> <p>    Interrupts . . . . . 19</p> <p>    Timer . . . . . 19</p> <p>    Flags . . . . . 20</p> <p>    Memory Read—Bus Master . . . . . 21</p> <p>    Memory Write—Bus Master . . . . . 22</p> <p>    Synchronous Read/Write—Bus Master . . . . . 23</p> <p>    Synchronous Read/Write—Bus Slave . . . . . 25</p> <p>    Multiprocessor Bus Request and         Host Bus Request . . . . . 26</p> <p>    Asynchronous Read/Write—Host         to ADSP-21160N . . . . . 28</p> <p>    Three-State Timing—Bus Master, Bus Slave . . . . . 30</p> <p>    DMA Handshake . . . . . 32</p> <p>    Link Ports —Receive, Transmit . . . . . 34</p> <p>    Serial Ports . . . . . 36</p> <p>    JTAG Test Access Port and Emulation . . . . . 39</p> <p>    Output Drive Currents . . . . . 40</p> <p>    Power Dissipation . . . . . 40</p> <p>    Test Conditions . . . . . 41</p> <p>        Output Disable Time . . . . . 41</p> <p>        Output Enable Time . . . . . 41</p> <p>        Example System Hold Time Calculation . . . . . 41</p> <p>        Capacitive Loading . . . . . 42</p> <p>    Environmental Conditions . . . . . 42</p> <p>        Thermal Characteristics . . . . . 42</p> <p>400-BALL METRIC PBGA PIN     <b>CONFIGURATIONS</b> . . . . . 43</p> <p>    <b>OUTLINE DIMENSIONS</b> . . . . . 46</p> <p>    <b>ORDERING GUIDE</b> . . . . . 46</p>
--	---

# ADSP-21160N

## GENERAL DESCRIPTION

The ADSP-21160N SHARC DSP is the second iteration of the ADSP-21160. Built in a 0.18 micron CMOS process, it offers higher performance and lower power consumption than its predecessor, the ADSP-21160M. Easing portability, the ADSP-21160N is application source code compatible with first generation ADSP-2106x SHARC DSPs in SISD (Single Instruction, Single Data) mode. To take advantage of the processor's SIMD (Single Instruction, Multiple Data) capability, some code changes are needed. Like other SHARCs, the ADSP-21160N is a 32-bit processor that is optimized for high performance DSP applications. The ADSP-21160N includes a 100 MHz core, a dual-ported on-chip SRAM, an integrated I/O processor with multiprocessing support, and multiple internal buses to eliminate I/O bottlenecks.

The ADSP-21160N introduces Single-Instruction, Multiple-Data (SIMD) processing. Using two computational units (ADSP-2106x SHARC DSPs have one), the ADSP-21160N can double performance versus the ADSP-2106x on a range of DSP algorithms.

Fabricated in a state of the art, high speed, low power CMOS process, the ADSP-21160N has a 10 ns instruction cycle time. With its SIMD computational hardware running at 100 MHz, the ADSP-21160N can perform 600 million math operations per second.

Table 1 shows performance benchmarks for the ADSP-21160N.

**Table 1. ADSP-21160N Benchmarks**

Benchmark Algorithm	Speed
1024 Point Complex FFT (Radix 4, with reversal)	171 $\mu$ s
FIR Filter (per tap)	5 ns
IIR Filter (per biquad)	40 ns <sup>1</sup>
Matrix Multiply (pipelined) [3x3] x [3x1]	30 ns
[4x4] x [4x1]	37 ns
Divide (y/x)	60 ns <sup>1</sup>
Inverse Square Root	90 ns <sup>1</sup>
DMA Transfer Rate	800M byte/s

<sup>1</sup> Specified in SISD mode. Using SIMD, the same benchmark applies for two sets of computations. For example, two sets of biquad operations can be performed in the same amount of time as the SISD mode benchmark.

These benchmarks provide single-channel extrapolations of measured dual-channel processing performance. For more information on benchmarking and optimizing DSP code for single- and dual-channel processing, see the Analog Devices website ([www.analog.com](http://www.analog.com)).

The ADSP-21160N continues SHARC's industry-leading standards of integration for DSPs, combining a high performance 32-bit DSP core with integrated, on-chip system features. These features include a 4M-bit dual ported SRAM memory, host processor interface, I/O processor that supports 14 DMA channels, two serial ports, six link ports, external parallel bus, and glueless multiprocessing.

The functional block diagram on Page 1 shows a block diagram of the ADSP-21160N, illustrating the following architectural features:

- Two processing elements, each made up of an ALU, Multiplier, Shifter, and Data Register File
- Data Address Generators (DAG1, DAG2)
- Program sequencer with instruction cache
- PM and DM buses capable of supporting four 32-bit data transfers between memory and the core every core processor cycle
- Interval timer
- On-Chip SRAM (4M bits)
- External port that supports:
  - Interfacing to off-chip memory peripherals
  - Glueless multiprocessing support for six ADSP-21160N SHARCs
  - Host port
- DMA controller
- Serial ports and link ports
- JTAG test access port

Figure 1 shows a typical single-processor system. A multiprocessing system appears in Figure 4.

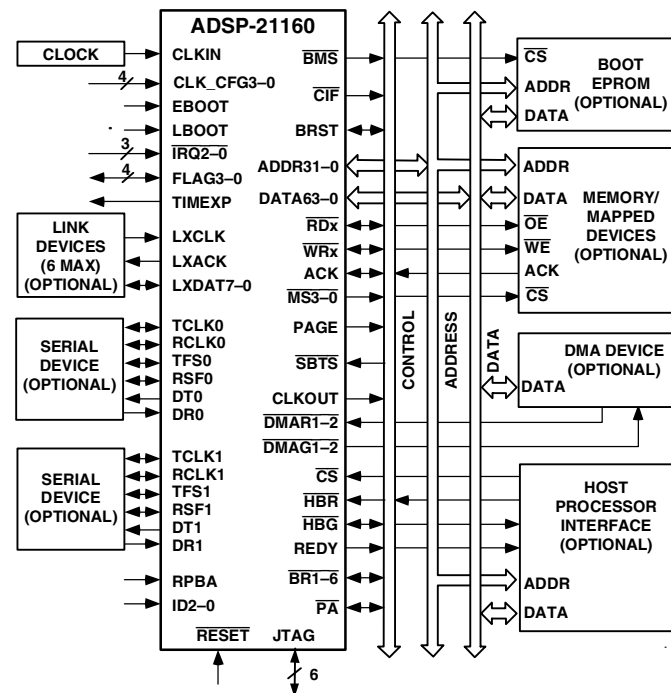

Figure 1. Single-Processor System

## ADSP-21160N Family Core Architecture

The ADSP-21160N includes the following architectural features of the ADSP-2116x family core. The ADSP-21160N is code compatible at the assembly level with the ADSP-2106x and ADSP-21161.

***SIMD Computational Engine***

The ADSP-21160N contains two computational processing elements that operate as a Single Instruction Multiple Data (SIMD) engine. The processing elements are referred to as PEX and PEY, and each contains an ALU, multiplier, shifter, and register file. PEX is always active, and PEY may be enabled by setting the PEYEN mode bit in the MODE1 register. When this mode is enabled, the same instruction is executed in both processing elements, but each processing element operates on different data. This architecture is efficient at executing math-intensive DSP algorithms.

Entering SIMD mode also has an effect on the way data is transferred between memory and the processing elements. When in SIMD mode, twice the data bandwidth is required to sustain computational operation in the processing elements. Because of this requirement, entering SIMD mode also doubles the bandwidth between memory and the processing elements. When using the DAGs to transfer data in SIMD mode, two data values are transferred with each access of memory or the register file.

***Independent, Parallel Computation Units***

Within each processing element is a set of computational units. The computational units consist of an arithmetic/logic unit (ALU), multiplier, and shifter. These units perform single-cycle instructions. The three units within each processing element are arranged in parallel, maximizing computational throughput. Single multifunction instructions execute parallel ALU and multiplier operations. In SIMD mode, the parallel ALU and multiplier operations occur in both processing elements. These computation units support IEEE 32-bit single-precision floating-point, 40-bit extended precision floating-point, and 32-bit fixed-point data formats.

***Data Register File***

A general-purpose data register file is contained in each processing element. The register files transfer data between the computation units and the data buses, and store intermediate results. These 10-port, 32-register (16 primary, 16 secondary) register files, combined with the ADSP-2116x enhanced Harvard architecture, allow unconstrained data flow between computation units and internal memory. The registers in PEX are referred to as R0–R15 and in PEY as S0–S15.

***Single-Cycle Fetch of Instruction and Four Operands***

The ADSP-21160N features an enhanced Harvard architecture in which the data memory (DM) bus transfers data, and the program memory (PM) bus transfers both instructions and data (see the functional block diagram on Page 1). With the ADSP-21160N's separate program and data memory buses and on-chip instruction cache, the processor can simultaneously fetch four operands and an instruction (from the cache), all in a single cycle.

***Instruction Cache***

The ADSP-21160N includes an on-chip instruction cache that enables three-bus operation for fetching an instruction and four data values. The cache is selective—only the instructions whose fetches conflict with PM bus data accesses are cached. This cache

allows full-speed execution of core, providing looped operations, such as digital filter multiply-accumulates and FFT butterfly processing.

***Data Address Generators with Hardware Circular Buffers***

The ADSP-21160N's two data address generators (DAGs) are used for indirect addressing and provide for implementing circular data buffers in hardware. Circular buffers allow efficient programming of delay lines and other data structures required in digital signal processing, and are commonly used in digital filters and Fourier transforms. The two DAGs of the ADSP-21160N contain sufficient registers to allow the creation of up to 32 circular buffers (16 primary register sets, 16 secondary). The DAGs automatically handle address pointer wraparound, reducing overhead, increasing performance, and simplifying implementation. Circular buffers can start and end at any memory location.

***Flexible Instruction Set***

The 48-bit instruction word accommodates a variety of parallel operations, for concise programming. For example, the ADSP-21160N can conditionally execute a multiply, an add, and subtract, in both processing elements, while branching, all in a single instruction.

***ADSP-21160N Memory and I/O Interface Features***

Augmenting the ADSP-2116x family core, the ADSP-21160N adds the following architectural features:

***Dual-Ported On-Chip Memory***

The ADSP-21160N contains four megabits of on-chip SRAM, organized as two blocks of 2M bits each, which can be configured for different combinations of code and data storage. Each memory block is dual-ported for single-cycle, independent accesses by the core processor and I/O processor. The dual-ported memory in combination with three separate on-chip buses allows two data transfers from the core and one from I/O processor, in a single cycle. On the ADSP-21160N, the memory can be configured as a maximum of 128K words of 32-bit data, 256K words of 16-bit data, 85K words of 48-bit instructions (or 40-bit data), or combinations of different word sizes up to four megabits. All of the memory can be accessed as 16-bit, 32-bit, 48-bit, or 64-bit words. A 16-bit floating-point storage format is supported that effectively doubles the amount of data that may be stored on-chip. Conversion between the 32-bit floating-point and 16-bit floating-point formats is done in a single instruction. While each memory block can store combinations of code and data, accesses are most efficient when one block stores data, using the DM bus for transfers, and the other block stores instructions and data, using the PM bus for transfers. Using the DM bus and PM bus in this way, with one dedicated to each memory block, assures single-cycle execution with two data transfers. In this case, the instruction must be available in the cache.

***Off-Chip Memory and Peripherals Interface***

The ADSP-21160N's external port provides the processor's interface to off-chip memory and peripherals. The 4G word off-chip address space is included in the ADSP-21160N's unified address space. The separate on-chip buses—for PM addresses,

# ADSP-21160N

PM data, DM addresses, DM data, I/O addresses, and I/O data—are multiplexed at the external port to create an external system bus with a single 32-bit address bus and a single 64-bit data bus. The lower 32 bits of the external data bus connect to even addresses and the upper 32 bits of the 64 connect to odd addresses. Every access to external memory is based on an address that fetches a 32-bit word, and with the 64-bit bus, two address locations can be accessed at once. When fetching an instruction from external memory, two 32-bit data locations are being accessed (16 bits are unused). Figure 3 shows the alignment of various accesses to external memory.

The external port supports asynchronous, synchronous, and synchronous burst accesses. ZBT synchronous burst SRAM can be interfaced gluelessly. Addressing of external memory devices is facilitated by on-chip decoding of high order address lines to generate memory bank select signals. Separate control lines are also generated for simplified addressing of page-mode DRAM. The ADSP-21160N provides programmable memory wait states and external memory acknowledge controls to allow interfacing to DRAM and peripherals with variable access, hold, and disable time requirements.

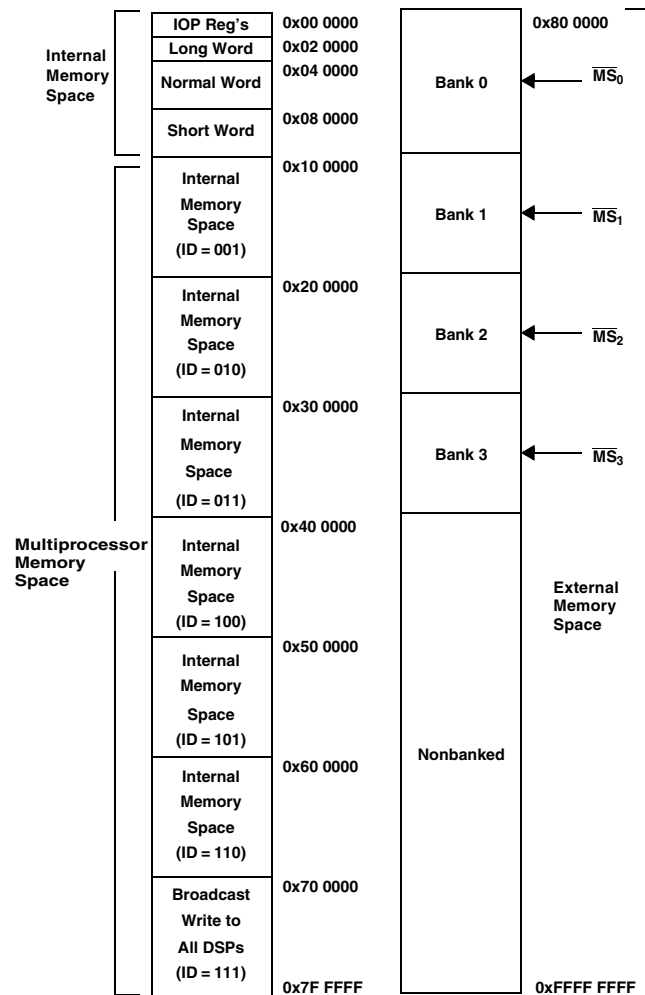

Figure 2. Memory Map

## DMA Controller

The ADSP-21160N's on-chip DMA controller allows zero-overhead data transfers without processor intervention. The DMA controller operates independently and invisibly to the processor core, allowing DMA operations to occur while the core is simultaneously executing its program instructions. DMA transfers can occur between the ADSP-21160N's internal memory and external memory, external peripherals, or a host processor. DMA transfers can also occur between the ADSP-21160N's internal memory and its serial ports or link ports. External bus packing to 16-, 32-, 48-, or 64-bit words is performed during DMA transfers. Fourteen channels of DMA are available on the ADSP-21160N—six via the link ports, four via the serial ports, and four via the processor's external port (for either host processor, other ADSP-21160Ns, memory or I/O transfers). Programs can be downloaded to the ADSP-21160N using DMA transfers. Asynchronous off-chip peripherals can control two DMA channels using DMA Request/Grant lines ( $\overline{DMAR1-2}$ ,  $\overline{DMAG1-2}$ ). Other DMA features include interrupt generation upon completion of DMA transfers, two-dimensional DMA, and DMA chaining for automatic linked DMA transfers.

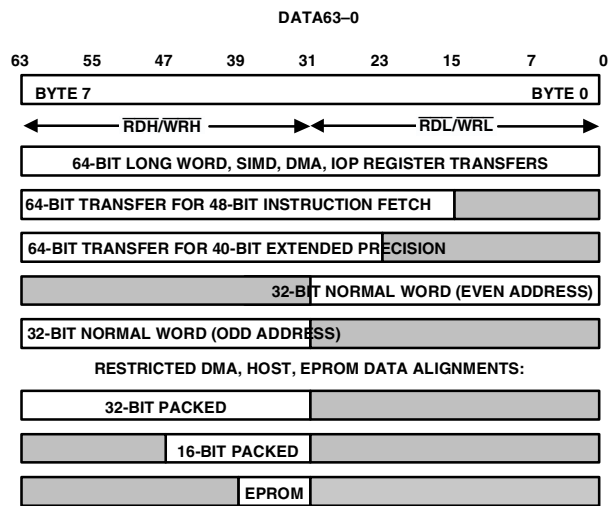

Figure 3. External Data Alignment Options

## Multiprocessing

The ADSP-21160N offers powerful features tailored to multiprocessing DSP systems as shown in Figure 4. The external port and link ports provide integrated glueless multiprocessing support.

The external port supports a unified address space (see Figure 2) that allows direct interprocessor accesses of each ADSP-21160N's internal memory. Distributed bus arbitration logic is included on-chip for simple, glueless connection of systems containing up to six ADSP-21160Ns and a host processor. Master processor changeover incurs only one cycle of overhead. Bus arbitration is selectable as either fixed or rotating priority. Bus lock allows indivisible read-modify-write sequences for semaphores. A vector interrupt is provided for interprocessor

commands. Maximum throughput for interprocessor data transfer is 400M bytes/s over the external port. Broadcast writes allow simultaneous transmission of data to all ADSP-21160Ns and can be used to implement reflective semaphores.

Six link ports provide a second method of multiprocessing communications. Each link port can support communications to another ADSP-21160N. Using the links, a large multiprocessor system can be constructed in a 2D or 3D fashion. Systems can use the link ports and cluster multiprocessing concurrently or independently.

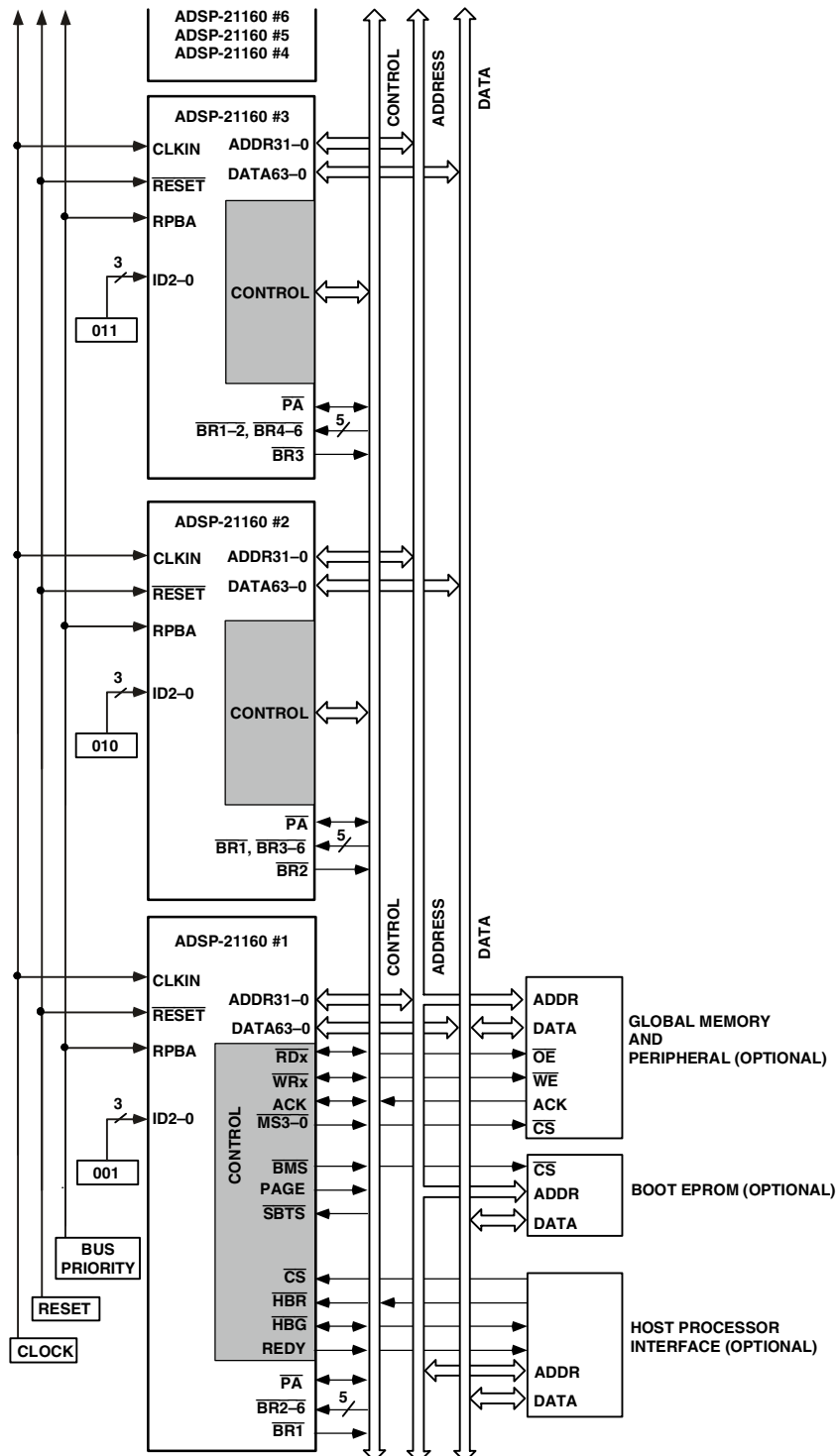

Figure 4. Shared Memory Multiprocessing System



# ADSP-21160N

## Link Ports

The ADSP-21160N features six 8-bit link ports that provide additional I/O capabilities. With the capability of running at 100 MHz rates, each link port can support 80M bytes/s. Link port I/O is especially useful for point-to-point interprocessor communication in multiprocessing systems. The link ports can operate independently and simultaneously. Link port data is packed into 48- or 32-bit words, and can be directly read by the core processor or DMA-transferred to on-chip memory. Each link port has its own double-buffered input and output registers. Clock/acknowledge handshaking controls link port transfers. Transfers are programmable as either transmit or receive.

## Serial Ports

The ADSP-21160N features two synchronous serial ports that provide an inexpensive interface to a wide variety of digital and mixed-signal peripheral devices. The serial ports can operate up to half the clock rate of the core, providing each with a maximum data rate of 50M bit/s. Independent transmit and receive functions provide greater flexibility for serial communications. Serial port data can be automatically transferred to and from on-chip memory via a dedicated DMA. Each of the serial ports offers a TDM multichannel mode. The serial ports can operate with little-endian or big-endian transmission formats, with word lengths selectable from 3 bits to 32 bits. They offer selectable synchronization and transmit modes as well as optional  $\mu$ -law or A-law companding. Serial port clocks and frame syncs can be internally or externally generated.

## Host Processor Interface

The ADSP-21160N host interface allows easy connection to standard microprocessor buses, both 16-bit and 32-bit, with little additional hardware required. The host interface is accessed through the ADSP-21160N's external port and is memory-mapped into the unified address space. Four channels of DMA are available for the host interface; code and data transfers are accomplished with low software overhead. The host processor communicates with the ADSP-21160N's external bus with host bus request ( $\overline{\text{HBR}}$ ), host bus grant ( $\overline{\text{HBG}}$ ), ready (REDY), acknowledge (ACK), and chip select (CS) signals. The host can directly read and write the internal memory of the ADSP-21160N, and can access the DMA channel setup and mailbox registers. Vector interrupt support provides efficient execution of host commands.

## Program Booting

The internal memory of the ADSP-21160N can be booted at system power-up from an 8-bit EPROM, a host processor, or through one of the link ports. Selection of the boot source is controlled by the BMS (Boot Memory Select), EBOOT (EPROM Boot), and LBOOT (Link/Host Boot) pins. 32-bit and 16-bit host processors can be used for booting.

## Phase-Locked Loop

The ADSP-21160N uses an on-chip PLL to generate the internal clock for the core. Ratios of 2:1, 3:1, and 4:1 between the core and CLKIN are supported. The CLK\_CFG pins are used to select the ratio. The CLKIN rate is the rate at which the synchronous external port operates.

CROSSCORE is a trademark of Analog Devices, Inc.

VisualDSP++ is a registered trademark of Analog Devices, Inc.

## Power Supplies

The ADSP-21160N has separate power supply connections for the internal ( $V_{\text{DDINT}}$ ), external ( $V_{\text{DDEXT}}$ ), and analog ( $AV_{\text{DD}}$  and AGND) power supplies. The internal and analog supplies must meet the 1.9 V requirement. The external supply must meet the 3.3 V requirement. All external supply pins must be connected to the same supply.

The PLL Filter, Figure 5, must be added for each ADSP-21160N in the system.  $V_{\text{DDINT}}$  is the digital core supply. It is recommended that the capacitors be connected directly to AGND using short thick trace. It is recommended that the capacitors be placed as close to  $AV_{\text{DD}}$  and AGND as possible. The connection from AGND to the (digital) ground plane should be made after the capacitors. The use of a thick trace for AGND is reasonable only because the PLL is a relatively low power circuit—it does not apply to any other ADSP-21160N GND connection.

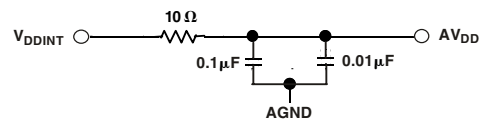

Figure 5. Analog Power ( $AV_{\text{DD}}$ ) Filter Circuit

## Development Tools

The ADSP-21160N is supported with a complete set of CROSSCORE™ software and hardware development tools, including Analog Devices emulators and VisualDSP++® development environment. The same emulator hardware that supports other ADSP-2116x processors also fully emulates the ADSP-21160N.

The VisualDSP++ project management environment lets programmers develop and debug an application. This environment includes an easy to use assembler (which is based on an algebraic syntax), an archiver (librarian/library builder), a linker, a loader, a cycle-accurate instruction-level simulator, a C/C++ compiler, and a C/C++ runtime library that includes DSP and mathematical functions. A key point for these tools is C/C++ code efficiency. The compiler has been developed for efficient translation of C/C++ code to DSP assembly. The DSP has architectural features that improve the efficiency of compiled C/C++ code.

The VisualDSP++ debugger has a number of important features. Data visualization is enhanced by a plotting package that offers a significant level of flexibility. This graphical representation of user data enables the programmer to quickly determine the performance of an algorithm. As algorithms grow in complexity, this capability can have increasing significance on the designer's development schedule, increasing productivity. Statistical profiling enables the programmer to nonintrusively poll the processor as it is running the program. This feature, unique to VisualDSP++, enables the software developer to passively gather important code execution metrics without interrupting the real-time characteristics of the program. Essentially, the developer can identify bottlenecks in software quickly and efficiently. By using the profiler, the programmer can focus on those areas in the program that impact performance and take corrective action.



Debugging both C/C++ and assembly programs with the VisualDSP++ debugger, programmers can:

- View mixed C/C++ and assembly code (interleaved source and object information)
- Insert breakpoints
- Set conditional breakpoints on registers, memory, and stacks
- Trace instruction execution
- Perform linear or statistical profiling of program execution
- Fill, dump, and graphically plot the contents of memory
- Perform source level debugging
- Create custom debugger windows

The VisualDSP++ IDDE lets programmers define and manage DSP software development. Its dialog boxes and property pages let programmers configure and manage all of the ADSP-2116x development tools, including the color syntax highlighting in the VisualDSP++ editor. This capability permits programmers to:

- Control how the development tools process inputs and generate outputs
- Maintain a one-to-one correspondence with the tool's command line switches

The VisualDSP++ Kernel (VDK) incorporates scheduling and resource management tailored specifically to address the memory and timing constraints of DSP programming. These capabilities enable engineers to develop code more effectively, eliminating the need to start from the very beginning, when developing new application code. The VDK features include Threads, Critical and Unscheduled regions, Semaphores, Events, and Device flags. The VDK also supports Priority-based, Pre-emptive, Cooperative, and Time-Sliced scheduling approaches. In addition, the VDK was designed to be scalable. If the application does not use a specific feature, the support code for that feature is excluded from the target system.

Because the VDK is a library, a developer can decide whether to use it or not. The VDK is integrated into the VisualDSP++ development environment, but can also be used via standard command line tools. When the VDK is used, the development environment assists the developer with many error-prone tasks and assists in managing system resources, automating the generation of various VDK based objects, and visualizing the system state, when debugging an application that uses the VDK.

VCSE is Analog Devices technology for creating, using, and reusing software components (independent modules of substantial functionality) to quickly and reliably assemble software applications. Download components from the Web and drop them into the application. Publish component archives from within VisualDSP++. VCSE supports component implementation in C/C++ or assembly language.

Use the Expert Linker to visually manipulate the placement of code and data on the embedded system. View memory utilization in a color-coded graphical form, easily move code and data to different areas of the DSP or external memory with the drag of

the mouse, examine run time stack and heap usage. The Expert Linker is fully compatible with existing Linker Definition File (LDF), allowing the developer to move between the graphical and textual environments.

Analog Devices DSP emulators use the IEEE 1149.1 JTAG Test Access Port of the ADSP-21160N processor to monitor and control the target board processor during emulation. The emulator provides full speed emulation, allowing inspection and modification of memory, registers, and processor stacks. Noninvasive in-circuit emulation is assured by the use of the processor's JTAG interface—the emulator does not affect target system loading or timing.

In addition to the software and hardware development tools available from Analog Devices, third parties provide a wide range of tools supporting the ADSP-2116x processor family. Hardware tools include ADSP-2116x processor PC plug-in cards. Third party software tools include DSP libraries, real-time operating systems, and block diagram design tools.

### Designing an Emulator-Compatible DSP Board (Target)

The Analog Devices family of emulators are tools that every DSP developer needs to test and debug hardware and software systems. Analog Devices has supplied an IEEE 1149.1 JTAG Test Access Port (TAP) on each JTAG DSP. The emulator uses the TAP to access the internal features of the DSP, allowing the developer to load code, set breakpoints, observe variables, observe memory, and examine registers. The DSP must be halted to send data and commands, but once an operation has been completed by the emulator, the DSP system is set running at full speed with no impact on system timing.

To use these emulators, the target board must include a header that connects the DSP's JTAG port to the emulator.

For details on target board design issues including mechanical layout, single processor connections, multiprocessor scan chains, signal buffering, signal termination, and emulator pod logic, see the *EE-68: Analog Devices JTAG Emulation Technical Reference* on the Analog Devices website ([www.analog.com](http://www.analog.com))—use site search on “EE-68.” This document is updated regularly to keep pace with improvements to emulator support.

### Additional Information

This data sheet provides a general overview of the ADSP-21160N architecture and functionality. For detailed information on the ADSP-2116x family core architecture and instruction set, refer to the *ADSP-21160 SHARC DSP Hardware Reference* and the *ADSP-21160 SHARC DSP Instruction Set Reference*. For detailed information on the development tools for this processor, see the *VisualDSP++ User's Guide for SHARC Processors*.

### PIN FUNCTION DESCRIPTIONS

ADSP-21160N pin definitions are listed below. Inputs identified as synchronous (S) must meet timing requirements with respect to CLKIN (or with respect to TCK for TMS, TDI). Inputs identified as asynchronous (A) can be asserted asynchronously to CLKIN (or to TCK for  $\overline{\text{TRST}}$ ).

# ADSP-21160N

Tie or pull unused inputs to  $V_{DD}$  or GND, except for the following:

- ADDR31–0, DATA63–0, PAGE, BRST, CLKOUT (ID2–0 = 00x) (Note: These pins have a logic-level hold circuit enabled on the ADSP-21160N DSP with ID2–0 = 00x.)
- $\overline{PA}$ , ACK, MS3–0,  $\overline{RDx}$ ,  $\overline{WRx}$ ,  $\overline{CIF}$ ,  $\overline{DMARx}$ ,  $\overline{DMAGx}$  (ID2–0 = 00x) (Note: These pins have a pull-up enabled on the ADSP-21160N DSP with ID2–0 = 00x.)

- LxCLK, LxACK, LxDAT7–0 (LxPDRDE = 0) (Note: See Link Port Buffer Control Register Bit definitions in the *ADSP-21160 DSP Hardware Reference*.)
- DTx, DRx, TCLKx, RCLKx,  $\overline{EMU}$ , TMS,  $\overline{TRST}$ , TDI (Note: These pins have a pull-up.)

The following symbols appear in the Type column of [Table 2](#): A = Asynchronous, G = Ground, I = Input, O = Output, P = Power Supply, S = Synchronous, (A/D) = Active Drive, (O/D) = Open Drain, and T = Three-State (when  $\overline{SBTS}$  is asserted, or when the ADSP-21160N is a bus slave).

**Table 2. Pin Function Descriptions**

Pin	Type	Function
ADDR31–0	I/O/T	External Bus Address. The ADSP-21160N outputs addresses for external memory and peripherals on these pins. In a multiprocessor system, the bus master outputs addresses for read/writes of the internal memory or IOP registers of other ADSP-21160Ns. The ADSP-21160N inputs addresses when a host processor or multiprocessing bus master is reading or writing its internal memory or IOP registers. A keeper latch on the DSP's ADDR31–0 pins maintains the input at the level it was last driven (only enabled on the ADSP-21160N with ID2–0 = 00x).
DATA63–0	I/O/T	External Bus Data. The ADSP-21160N inputs and outputs data and instructions on these pins. Pull-up resistors on unused DATA pins are not necessary. A keeper latch on the DSP's DATA63–0 pins maintains the input at the level it was last driven (only enabled on the ADSP-21160N with ID2–0 = 00x).
$\overline{MS3-0}$	O/T	Memory Select Lines. These outputs are asserted (low) as chip selects for the corresponding banks of external memory. Memory bank size must be defined in the SYSCON control register. The $\overline{MS3-0}$ outputs are decoded memory address lines. In asynchronous access mode, the $\overline{MS3-0}$ outputs transition with the other address outputs. In synchronous access modes, the $\overline{MS3-0}$ outputs assert with the other address lines; however, they deassert after the first CLKIN cycle in which ACK is sampled asserted. $\overline{MS3-0}$ has a 20 k $\Omega$ internal pull-up resistor that is enabled on the ADSP-21160N with ID2–0 = 00x.
$\overline{RDL}$	I/O/T	Memory Read Low Strobe. $\overline{RDL}$ is asserted whenever ADSP-21160N reads from the low word of external memory or from the internal memory of other ADSP-21160Ns. External devices, including other ADSP-21160Ns, must assert $\overline{RDL}$ for reading from the low word of ADSP-21160N internal memory. In a multiprocessing system, $\overline{RDL}$ is driven by the bus master. $\overline{RDL}$ has a 20 k $\Omega$ internal pull-up resistor that is enabled on the ADSP-21160N with ID2–0 = 00x.
$\overline{RDH}$	I/O/T	Memory Read High Strobe. $\overline{RDH}$ is asserted whenever ADSP-21160N reads from the high word of external memory or from the internal memory of other ADSP-21160Ns. External devices, including other ADSP-21160Ns, must assert $\overline{RDH}$ for reading from the high word of ADSP-21160N internal memory. In a multiprocessing system, $\overline{RDH}$ is driven by the bus master. $\overline{RDH}$ has a 20 k $\Omega$ internal pull-up resistor that is enabled on the ADSP-21160N with ID2–0 = 00x.
$\overline{WRL}$	I/O/T	Memory Write Low Strobe. $\overline{WRL}$ is asserted when ADSP-21160N writes to the low word of external memory or internal memory of other ADSP-21160Ns. External devices must assert $\overline{WRL}$ for writing to ADSP-21160N's low word of internal memory. In a multiprocessing system, $\overline{WRL}$ is driven by the bus master. $\overline{WRL}$ has a 20 k $\Omega$ internal pull-up resistor that is enabled on the ADSP-21160N with ID2–0 = 00x.
$\overline{WRH}$	I/O/T	Memory Write High Strobe. $\overline{WRH}$ is asserted when ADSP-21160N writes to the high word of external memory or internal memory of other ADSP-21160Ns. External devices must assert $\overline{WRH}$ for writing to ADSP-21160N's high word of internal memory. In a multiprocessing system, $\overline{WRH}$ is driven by the bus master. $\overline{WRH}$ has a 20 k $\Omega$ internal pull-up resistor that is enabled on the ADSP-21160N with ID2–0 = 00x.

**Table 2. Pin Function Descriptions (continued)**

Pin	Type	Function
PAGE	O/T	DRAM Page Boundary. The ADSP-21160N asserts this pin to an external DRAM controller, to signal that an external DRAM page boundary has been crossed. DRAM page size must be defined in the ADSP-21160N's memory control register (WAIT). DRAM can only be implemented in external memory Bank 0; the PAGE signal can only be activated for Bank 0 accesses. In a multiprocessing system PAGE is output by the bus master. A keeper latch on the DSP's PAGE pin maintains the output at the level it was last driven (only enabled on the ADSP-21160N with ID2-0 = 00x).
BRST	I/O/T	Sequential Burst Access. BRST is asserted by ADSP-21160N or a host to indicate that data associated with consecutive addresses is being read or written. A slave device samples the initial address and increments an internal address counter after each transfer. The incremented address is not pipelined on the bus. If the burst access is a read from host to ADSP-21160N, ADSP-21160N automatically increments the address as long as BRST is asserted. BRST is asserted after the initial access of a burst transfer. It is asserted for every cycle after that, except for the last data request cycle (denoted by $\overline{RDx}$ or $\overline{WRx}$ asserted and BRST negated). A keeper latch on the DSP's BRST pin maintains the input at the level it was last driven (only enabled on the ADSP-21160N with ID2-0 = 00x).
ACK	I/O/S	Memory Acknowledge. External devices can deassert ACK (low) to add wait states to an external memory access. ACK is used by I/O devices, memory controllers, or other peripherals to hold off completion of an external memory access. The ADSP-21160N deasserts ACK as an output to add wait states to a synchronous access of its internal memory, by a synchronous host or another DSP in a multiprocessor configuration. ACK has a 2 k $\Omega$ internal pull-up resistor that is enabled on the ADSP-21160N with ID2-0 = 00x.
$\overline{SBTS}$	I/S	Suspend Bus and Three-State. External devices can assert $\overline{SBTS}$ (low) to place the external bus address, data, selects, and strobes in a high impedance state for the following cycle. If the ADSP-21160N attempts to access external memory while $\overline{SBTS}$ is asserted, the processor will halt and the memory access will not be completed until $\overline{SBTS}$ is deasserted. $\overline{SBTS}$ should only be used to recover from host processor and/or ADSP-21160N deadlock or used with a DRAM controller.
$\overline{IRQ2-0}$	I/A	Interrupt Request Lines. These are sampled on the rising edge of CLKIN and may be either edge-triggered or level-sensitive.
FLAG3-0	I/O/A	Flag Pins. Each is configured via control bits as either an input or output. As an input, it can be tested as a condition. As an output, it can be used to signal external peripherals.
TIMEXP	O	Timer Expired. Asserted for four Core Clock cycles when the timer is enabled and TCOUNT decrements to zero.
$\overline{HBR}$	I/A	Host Bus Request. Must be asserted by a host processor to request control of the ADSP-21160N's external bus. When $\overline{HBR}$ is asserted in a multiprocessing system, the ADSP-21160N that is bus master will relinquish the bus and assert $\overline{HBG}$ . To relinquish the bus, the ADSP-21160N places the address, data, select, and strobe lines in a high impedance state. $\overline{HBR}$ has priority over all ADSP-21160N bus requests (BR6-1) in a multiprocessing system.
$\overline{HBG}$	I/O	Host Bus Grant. Acknowledges an $\overline{HBR}$ bus request, indicating that the host processor may take control of the external bus. $\overline{HBG}$ is asserted (held low) by the ADSP-21160N until $\overline{HBR}$ is released. In a multiprocessing system, $\overline{HBG}$ is output by the ADSP-21160N bus master and is monitored by all others. After $\overline{HBR}$ is asserted, and before $\overline{HBG}$ is given, $\overline{HBG}$ will float for 1 t <sub>CLK</sub> (1 CLKIN cycle). To avoid erroneous grants, $\overline{HBG}$ should be pulled up with a 20 k $\Omega$ to 50 k $\Omega$ external resistor.
$\overline{CS}$	I/A	Chip Select. Asserted by host processor to select the ADSP-21160N, for asynchronous transfer protocol.
REDY	O (O/D)	Host Bus Acknowledge. The ADSP-21160N deasserts REDY (low) to add wait states to an asynchronous host access when $\overline{CS}$ and $\overline{HBR}$ inputs are asserted.
$\overline{DMAR1}$	I/A	DMA Request 1 (DMA Channel 11). Asserted by external port devices to request DMA services. $\overline{DMAR1}$ has a 20 k $\Omega$ internal pull-up resistor that is enabled on the ADSP-21160N with ID2-0 = 00x.

# ADSP-21160N

Table 2. Pin Function Descriptions (continued)

Pin	Type	Function
$\overline{\text{DMAR2}}$	I/A	DMA Request 2 (DMA Channel 12). Asserted by external port devices to request DMA services. $\overline{\text{DMAR2}}$ has a 20 k $\Omega$ internal pull-up resistor that is enabled on the ADSP-21160N with ID2-0 = 00x.
ID2-0	I	Multiprocessing ID. Determines which multiprocessing bus request ( $\overline{\text{BR1}}$ – $\overline{\text{BR6}}$ ) is used by ADSP-21160N. ID = 001 corresponds to $\overline{\text{BR1}}$ , ID = 010 corresponds to BR2, and so on. Use ID = 000 or ID = 001 in single-processor systems. These lines are a system configuration selection which should be hardwired or only changed at reset.
$\overline{\text{DMAG1}}$	O/T	DMA Grant 1 (DMA Channel 11). Asserted by ADSP-21160N to indicate that the requested DMA starts on the next cycle. Driven by bus master only. $\overline{\text{DMAG1}}$ has a 20 k $\Omega$ internal pull-up resistor that is enabled on the ADSP-21160N with ID2-0 = 00x.
$\overline{\text{DMAG2}}$	O/T	DMA Grant 2 (DMA Channel 12). Asserted by ADSP-21160N to indicate that the requested DMA starts on the next cycle. Driven by bus master only. $\overline{\text{DMAG2}}$ has a 20 k $\Omega$ internal pull-up resistor that is enabled on the ADSP-21160N with ID2-0 = 00x.
$\overline{\text{BR6-1}}$	I/O/S	Multiprocessing Bus Requests. Used by multiprocessing ADSP-21160Ns to arbitrate for bus mastership. An ADSP-21160N only drives its own $\overline{\text{BRx}}$ line (corresponding to the value of its ID2-0 inputs) and monitors all others. In a multiprocessor system with less than six ADSP-21160Ns, the unused $\overline{\text{BRx}}$ pins should be pulled high; the processor's own $\overline{\text{BRx}}$ line must not be pulled high or low because it is an output.
RPBA	I/S	Rotating Priority Bus Arbitration Select. When RPBA is high, rotating priority for multiprocessor bus arbitration is selected. When RPBA is low, fixed priority is selected. This signal is a system configuration selection which must be set to the same value on every ADSP-21160N. If the value of RPBA is changed during system operation, it must be changed in the same CLKIN cycle on every ADSP-21160N.
$\overline{\text{PA}}$	I/O/T	Priority Access. Asserting its $\overline{\text{PA}}$ pin allows an ADSP-21160N bus slave to interrupt background DMA transfers and gain access to the external bus. $\overline{\text{PA}}$ is connected to all ADSP-21160Ns in the system. If access priority is not required in a system, the $\overline{\text{PA}}$ pin should be left unconnected. $\overline{\text{PA}}$ has a 20 k $\Omega$ internal pull-up resistor that is enabled on the ADSP-21160N with ID2-0 = 00x.
DTx	O	Data Transmit (Serial Ports 0, 1). Each DT pin has a 50 k $\Omega$ internal pull-up resistor.
DRx	I	Data Receive (Serial Ports 0, 1). Each DR pin has a 50 k $\Omega$ internal pull-up resistor.
TCLKx	I/O	Transmit Clock (Serial Ports 0, 1). Each TCLK pin has a 50 k $\Omega$ internal pull-up resistor.
RCLKx	I/O	Receive Clock (Serial Ports 0, 1). Each RCLK pin has a 50 k $\Omega$ internal pull-up resistor.
TFSx	I/O	Transmit Frame Sync (Serial Ports 0, 1).
RFSx	I/O	Receive Frame Sync (Serial Ports 0, 1).
LxDAT7-0	I/O	Link Port Data (Link Ports 0-5). Each LxDAT pin has a 50 k $\Omega$ internal pull-down resistor that is enabled or disabled by the LPDRD bit of the LCTL0-1 register.
LxCLK	I/O	Link Port Clock (Link Ports 0-5). Each LxCLK pin has a 50 k $\Omega$ internal pull-down resistor that is enabled or disabled by the LPDRD bit of the LCTL0-1 register.
LxACK	I/O	Link Port Acknowledge (Link Ports 0-5). Each LxACK pin has a 50 k $\Omega$ internal pull-down resistor that is enabled or disabled by the LPDRD bit of the LCOM register.
EBOOT	I	EPROM Boot Select. For a description of how this pin operates, see Table 3. This signal is a system configuration selection that should be hardwired.
LBOOT	I	Link Boot. For a description of how this pin operates, see Table 3. This signal is a system configuration selection that should be hardwired.
$\overline{\text{BMS}}$	I/O/T	Boot Memory Select. Serves as an output or input as selected with the EBOOT and LBOOT pins; see Table 3. This input is a system configuration selection that should be hardwired.
CLKIN	I	Local Clock In. CLKIN is the ADSP-21160N clock input. The ADSP-21160N external port cycles at the frequency of CLKIN. The instruction cycle rate is a multiple of the CLKIN frequency; it is programmable at power-up. CLKIN may not be halted, changed, or operated below the specified frequency.

Table 2. Pin Function Descriptions (continued)

Pin	Type	Function
CLK_CFG3-0	I	Core/CLKIN Ratio Control. ADSP-21160N core clock (instruction cycle) rate is equal to $n \times \text{CLKIN}$ where $n$ is user-selectable to 2, 3, or 4, using the CLK_CFG3-0 inputs. For clock configuration definitions, see the <i>RESET &amp; CLKIN</i> section of the <i>System Design</i> chapter of the <i>ADSP-21160 SHARC DSP Hardware Reference</i> manual.
CLKOUT	O/T	CLKOUT is driven at the CLKIN frequency by the ADSP-21160N. This output can be three-stated by setting the COD bit in the SYSCON register. A keeper latch on the DSP's CLKOUT pin maintains the output at the level it was last driven (only enabled on the ADSP-21160N with ID2-0 = 00x). Do not use CLKOUT in multiprocessing systems; use CLKIN instead.
$\overline{\text{RESET}}$	I/A	Processor Reset. Resets the ADSP-21160N to a known state and begins execution at the program memory location specified by the hardware reset vector address. The $\overline{\text{RESET}}$ input must be asserted (low) at power-up.
TCK	I	Test Clock (JTAG). Provides a clock for JTAG boundary scan.
TMS	I/S	Test Mode Select (JTAG). Used to control the test state machine. TMS has a 20 k $\Omega$ internal pull-up resistor.
TDI	I/S	Test Data Input (JTAG). Provides serial data for the boundary scan logic. TDI has a 20 k $\Omega$ internal pull-up resistor.
TDO	O	Test Data Output (JTAG). Serial scan output of the boundary scan path.
$\overline{\text{TRST}}$	I/A	Test Reset (JTAG). Resets the test state machine. $\overline{\text{TRST}}$ must be asserted (pulsed low) after power-up or held low for proper operation of the ADSP-21160N. $\overline{\text{TRST}}$ has a 20 k $\Omega$ internal pull-up resistor.
$\overline{\text{EMU}}$	O (O/D)	Emulation Status. Must be connected to the ADSP-21160N emulator target board connector only. $\overline{\text{EMU}}$ has a 50 k $\Omega$ internal pull-up resistor.
$\overline{\text{CIF}}$	O/T	Core Instruction Fetch. Signal is active low when an external instruction fetch is performed. Driven by bus master only. Three-state when host is bus master. $\overline{\text{CIF}}$ has a 20 k $\Omega$ internal pull-up resistor that is enabled on the ADSP-21160N with ID2-0 = 00x.
V <sub>DDINT</sub>	P	Core Power Supply. Nominally 1.9 V dc and supplies the DSP's core processor (40 pins).
V <sub>DDEXT</sub>	P	I/O Power Supply. Nominally 3.3 V dc (43 pins).
AV <sub>DD</sub>	P	Analog Power Supply. Nominally 1.9 V dc and supplies the DSP's internal PLL (clock generator). This pin has the same specifications as V <sub>DDINT</sub> , except that added filtering circuitry is required. For more information, see Power Supplies on Page 8.
AGND	G	Analog Power Supply Return.
GND	G	Power Supply Return (82 pins).
NC		Do Not Connect. Reserved pins that must be left open and unconnected (9 pins).

Table 3. Boot Mode Selection

EBOOT	LBOOT	$\overline{\text{BMS}}$	Booting Mode
1	0	Output	EPROM (Connect $\overline{\text{BMS}}$ to EPROM chip select.)
0	0	1 (Input)	Host Processor
0	1	1 (Input)	Link Port
0	0	0 (Input)	No Booting. Processor executes from external memory.
0	1	0 (Input)	Reserved
1	1	x (Input)	Reserved



# ADSP-21160N

## SPECIFICATIONS

### RECOMMENDED OPERATING CONDITIONS

Parameter		C Grade		K Grade		Unit
		Min	Max	Min	Max	
V <sub>DDINT</sub>	Internal (Core) Supply Voltage	1.8	2.0	1.8	2.0	V
AV <sub>DD</sub>	Analog (PLL) Supply Voltage	1.8	2.0	1.8	2.0	V
V <sub>DDEXT</sub>	External (I/O) Supply Voltage	3.13	3.47	3.13	3.47	V
T <sub>CASE</sub>	Case Operating Temperature <sup>1</sup>	-40	+100	0	85	°C
V <sub>IH1</sub>	High Level Input Voltage, <sup>2</sup> @ V <sub>DDEXT</sub> = Max	2.0	V <sub>DDEXT</sub> + 0.5	2.0	V <sub>DDEXT</sub> + 0.5	V
V <sub>IH2</sub>	High Level Input Voltage, <sup>3</sup> @ V <sub>DDEXT</sub> = Max	2.0	V <sub>DDEXT</sub> + 0.5	2.0	V <sub>DDEXT</sub> + 0.5	V
V <sub>IL</sub>	Low Level Input Voltage, <sup>2,3</sup> @ V <sub>DDEXT</sub> = Min	-0.5	+0.8	-0.5	+0.8	V

Specifications subject to change without notice.

<sup>1</sup> See Environmental Conditions on Page 42 for information on thermal specifications.

<sup>2</sup> Applies to input and bidirectional pins: DATA63-0, ADDR31-0,  $\overline{RDx}$ ,  $\overline{WRx}$ , ACK,  $\overline{SBTS}$ ,  $\overline{IRQ2-0}$ , FLAG3-0,  $\overline{HBG}$ ,  $\overline{CS}$ ,  $\overline{DMAR1}$ ,  $\overline{DMAR2}$ ,  $\overline{BR6-1}$ , ID2-0, RPBA,  $\overline{PA}$ , BRST, TFS0, TFS1, RFS0, RFS1, LxDAT3-0, LxCLK, LxACK, EBOOT, LBOOT,  $\overline{BMS}$ , TMS, TDI, TCK,  $\overline{HBR}$ , DR0, DR1, TCLK0, TCLK1, RCLK0, RCLK1.

<sup>3</sup> Applies to input pins: CLKIN,  $\overline{RESET}$ ,  $\overline{TRST}$ .

### ELECTRICAL CHARACTERISTICS

Parameter		Test Conditions	Min	Max	Unit
V <sub>OH</sub>	High Level Output Voltage <sup>1</sup>	@ V <sub>DDEXT</sub> = Min, I <sub>OH</sub> = -2.0 mA <sup>2</sup>	2.4		V
V <sub>OL</sub>	Low Level Output Voltage <sup>1</sup>	@ V <sub>DDEXT</sub> = Min, I <sub>OL</sub> = 4.0 mA <sup>2</sup>		0.4	V
I <sub>IH</sub>	High Level Input Current <sup>3, 4, 5</sup>	@ V <sub>DDEXT</sub> = Max, V <sub>IN</sub> = V <sub>DD</sub> Max		10	μA
I <sub>IL</sub>	Low Level Input Current <sup>3</sup>	@ V <sub>DDEXT</sub> = Max, V <sub>IN</sub> = 0 V		10	μA
I <sub>IHC</sub>	CLKIN High Level Input Current <sup>6</sup>	@ V <sub>DDEXT</sub> = Max, V <sub>IN</sub> = V <sub>DDEXT</sub> Max		25	μA
I <sub>ILC</sub>	CLKIN Low Level Input Current <sup>6</sup>	@ V <sub>DDEXT</sub> = Max, V <sub>IN</sub> = 0 V		25	μA
I <sub>IKH</sub>	Keeper High Load Current <sup>7</sup>	@ V <sub>DDEXT</sub> = Max, V <sub>IN</sub> = 2.0 V	-250	-50	μA
I <sub>IKL</sub>	Keeper Low Load Current <sup>7</sup>	@ V <sub>DDEXT</sub> = Max, V <sub>IN</sub> = 0.8 V	50	200	μA
I <sub>IKH-OD</sub>	Keeper High Overdrive Current <sup>7, 8, 9</sup>	@ V <sub>DDEXT</sub> = Max	-300		μA
I <sub>IKL-OD</sub>	Keeper Low Overdrive Current <sup>7, 8, 9</sup>	@ V <sub>DDEXT</sub> = Max	300		μA
I <sub>ILPU1</sub>	Low Level Input Current Pull-Up <sup>14</sup>	@ V <sub>DDEXT</sub> = Max, V <sub>IN</sub> = 0 V		250	μA
I <sub>ILPU2</sub>	Low Level Input Current Pull-Up <sup>25</sup>	@ V <sub>DDEXT</sub> = Max, V <sub>IN</sub> = 0 V		500	μA
I <sub>OZH</sub>	Three-State Leakage Current <sup>10, 11, 12, 13</sup>	@ V <sub>DDEXT</sub> = Max, V <sub>IN</sub> = V <sub>DD</sub> Max		10	μA
I <sub>OZL</sub>	Three-State Leakage Current <sup>10</sup>	@ V <sub>DDEXT</sub> = Max, V <sub>IN</sub> = 0 V		10	μA
I <sub>OZHPD</sub>	Three-State Leakage Current Pull-Down <sup>13</sup>	@ V <sub>DDEXT</sub> = Max, V <sub>IN</sub> = V <sub>DD</sub> Max		250	μA
I <sub>OZLPU1</sub>	Three-State Leakage Current Pull-Up <sup>11</sup>	@ V <sub>DDEXT</sub> = Max, V <sub>IN</sub> = 0 V		250	μA
I <sub>OZLPU2</sub>	Three-State Leakage Current Pull-Up <sup>12</sup>	@ V <sub>DDEXT</sub> = Max, V <sub>IN</sub> = 0 V		500	μA
I <sub>OZHA</sub>	Three-State Leakage Current <sup>14</sup>	@ V <sub>DDEXT</sub> = Max, V <sub>IN</sub> = V <sub>DD</sub> Max		25	μA
I <sub>OZLA</sub>	Three-State Leakage Current <sup>14</sup>	@ V <sub>DDEXT</sub> = Max, V <sub>IN</sub> = 0 V		4	mA
I <sub>DD-INPEAK</sub>	Supply Current (Internal) <sup>15</sup>	t <sub>CCLK</sub> = 10.0 ns, V <sub>DDINT</sub> = Max		960	mA
I <sub>DD-INHIGH</sub>	Supply Current (Internal) <sup>16</sup>	t <sub>CCLK</sub> = 10.0 ns, V <sub>DDINT</sub> = Max		715	mA
I <sub>DD-INLOW</sub>	Supply Current (Internal) <sup>17</sup>	t <sub>CCLK</sub> = 10.0 ns, V <sub>DDINT</sub> = Max		550	mA
I <sub>DD-IDLE</sub>	Supply Current (Idle) <sup>18</sup>	t <sub>CCLK</sub> = 10.0 ns, V <sub>DDINT</sub> = Max		450	mA
AI <sub>DD</sub>	Supply Current (Analog) <sup>6</sup>	@ AV <sub>DD</sub> = Max		10	mA
C <sub>IN</sub>	Input Capacitance <sup>19, 20</sup>	f <sub>IN</sub> = 1 MHz, T <sub>CASE</sub> = 25°C, V <sub>IN</sub> = 2.5 V		4.7	pF

Specifications subject to change without notice.

<sup>1</sup> Applies to output and bidirectional pins: DATA63-0, ADDR31-0,  $\overline{MS3-0}$ ,  $\overline{RDx}$ ,  $\overline{WRx}$ , PAGE, CLKOUT, ACK, FLAG3-0, TIMEXP,  $\overline{HBG}$ , REDY,  $\overline{DMAG1}$ ,  $\overline{DMAG2}$ ,  $\overline{BR6-1}$ ,  $\overline{PA}$ , BRST,  $\overline{CIF}$ , DT0, DT1, TCLK0, TCLK1, RCLK0, RCLK1, TFS0, TFS1, RFS0, RFS1, LxDAT3-0, LxCLK, LxACK,  $\overline{BMS}$ , TDO, EMU.

<sup>2</sup> See Output Drive Currents on Page 40 for typical drive current capabilities.

<sup>3</sup> Applies to input pins:  $\overline{SBTS}$ ,  $\overline{IRQ2-0}$ ,  $\overline{HBR}$ ,  $\overline{CS}$ , ID2-0, RPBA, EBOOT, LBOOT, CLKIN,  $\overline{RESET}$ , TCK, CLK\_CFG3-0.

<sup>4</sup> Applies to input pins with internal pull-ups: DR0, DR1.

<sup>5</sup> Applies to input pins with internal pull-ups:  $\overline{DMARx}$ , TMS, TDI,  $\overline{TRST}$ .



- <sup>6</sup>Applies to CLKIN only.
- <sup>7</sup>Applies to all pins with keeper latches: ADDR31–0, DATA63–0, PAGE, BRST, CLKOUT.
- <sup>8</sup>Current required to switch from kept high to low or from kept low to high.
- <sup>9</sup>Characterized, but not tested.
- <sup>10</sup>Applies to three-statable pins: DATA63–0, ADDR31–0, PAGE, CLKOUT, ACK, FLAG3–0, REDY,  $\overline{\text{HBG}}$ ,  $\overline{\text{BMS}}$ ,  $\overline{\text{BR6-1}}$ , TFSx, RFSx, TDO.
- <sup>11</sup>Applies to three-statable pins with internal pull-ups:  $\overline{\text{DTx}}$ ,  $\overline{\text{TCLKx}}$ ,  $\overline{\text{RCLKx}}$ ,  $\overline{\text{EMU}}$ .
- <sup>12</sup>Applies to three-statable pins with internal pull-ups:  $\overline{\text{MS3-0}}$ ,  $\overline{\text{RDx}}$ ,  $\overline{\text{WRx}}$ ,  $\overline{\text{DMAGx}}$ ,  $\overline{\text{PA}}$ ,  $\overline{\text{CIF}}$ .
- <sup>13</sup>Applies to three-statable pins with internal pull-downs: LxDAT7–0, LxCLK, LxACK.
- <sup>14</sup>Applies to ACK pulled up internally with 2 k $\Omega$  during reset or ID2–0 = 00x.
- <sup>15</sup>The test program used to measure I<sub>DD-INPEAK</sub> represents worst-case processor operation and is not sustainable under normal application conditions. Actual internal power measurements made using typical applications are less than specified. For more information, see Power Dissipation on Page 40.
- <sup>16</sup>I<sub>DD-INHIGH</sub> is a composite average based on a range of high activity code. For more information, see Power Dissipation on Page 40.
- <sup>17</sup>I<sub>DD-INLOW</sub> is a composite average based on a range of low activity code. For more information, see Power Dissipation on Page 40.
- <sup>18</sup>Idle denotes ADSP-21160N state during execution of IDLE instruction. For more information, see Power Dissipation on Page 40.
- <sup>19</sup>Applies to all signal pins.
- <sup>20</sup>Guaranteed, but not tested.

## ABSOLUTE MAXIMUM RATINGS

Internal (Core) Supply Voltage (V <sub>DDINT</sub> ) <sup>1</sup> . . .	–0.3 V to +2.3 V
Analog (PLL) Supply Voltage (AV <sub>DD</sub> ) <sup>1</sup> . . . . .	–0.3 V to +2.3 V
External (I/O) Supply Voltage (V <sub>DDEXT</sub> ) <sup>1</sup> . . .	–0.3 V to +4.6 V
Input Voltage <sup>1</sup> . . . . .	–0.5 V to V <sub>DDEXT</sub> + 0.5 V
Output Voltage Swing <sup>1</sup> . . . . .	–0.5 V to V <sub>DDEXT</sub> + 0.5 V
Load Capacitance <sup>1</sup> . . . . .	.200 pF
Storage Temperature Range <sup>1</sup> . . . . .	–65°C to +150°C

<sup>1</sup>Stresses greater than those listed above may cause permanent damage to the device. These are stress ratings only; functional operation of the device at these or any other conditions greater than those indicated in the operational sections of this specification is not implied. Exposure to absolute maximum rating conditions for extended periods may affect device reliability.

## ESD SENSITIVITY

### CAUTION

ESD (electrostatic discharge) sensitive device. Electrostatic charges as high as 4000 V readily accumulate on the human body and test equipment and can discharge without detection. Although the ADSP-21160N features proprietary ESD protection circuitry, permanent damage may occur on devices subjected to high energy electrostatic discharges. Therefore, proper ESD precautions are recommended to avoid performance degradation or loss of functionality.



# ADSP-21160N

## TIMING SPECIFICATIONS

The ADSP-21160N's internal clock switches at higher frequencies than the system input clock (CLKIN). To generate the internal clock, the DSP uses an internal phase-locked loop (PLL). This PLL-based clocking minimizes the skew between the system clock (CLKIN) signal and the DSP's internal clock (the clock source for the external port logic and I/O pads).

The ADSP-21160N's internal clock (a multiple of CLKIN) provides the clock signal for timing internal memory, processor core, link ports, serial ports, and external port (as required for read/write strobes in asynchronous access mode). During reset, program the ratio between the DSP's internal clock frequency and external (CLKIN) clock frequency with the CLK\_CFG3-0 pins. Even though the internal clock is the clock source for the external port, the external port clock always switches at the CLKIN frequency. To determine switching frequencies for the serial and link ports, divide down the internal clock, using the programmable divider control of each port (TDIVx/RDIVx for the serial ports and LxCLKD1-0 for the link ports).

Note the following definitions of various clock periods that are a function of CLKIN and the appropriate ratio control:

- $t_{\text{CLK}} = (t_{\text{CK}}) / \text{CR}$
- $t_{\text{LCLK}} = (t_{\text{CLK}}) \times \text{LR}$
- $t_{\text{SCLK}} = (t_{\text{CLK}}) \times \text{SR}$

where:

- LCLK = Link Port Clock
- SCLK = Serial Port Clock
- $t_{\text{CK}}$  = CLKIN Clock Period
- $t_{\text{CLK}}$  = (Processor) Core Clock Period
- $t_{\text{LCLK}}$  = Link Port Clock Period
- $t_{\text{SCLK}}$  = Serial Port Clock Period
- CR = Core/CLKIN Ratio (2, 3, or 4:1, determined by CLK\_CFG3-0 at reset)
- LR = Link Port/Core Clock Ratio (1, 2, 3, or 4:1, determined by LxCLKD)
- SR = Serial Port/Core Clock Ratio (wide range, determined by  $\times$ CLKDIV)

Use the exact timing information given. Do not attempt to derive parameters from the addition or subtraction of others. While addition or subtraction would yield meaningful results for an

individual device, the values given in this data sheet reflect statistical variations and worst cases. Consequently, it is not meaningful to add parameters to derive longer times.

See [Figure 30 on Page 41](#) under Test Conditions for voltage reference levels.

Switching Characteristics specify how the processor changes its signals. Circuitry external to the processor must be designed for compatibility with these signal characteristics. Switching characteristics describe what the processor will do in a given circumstance. Use switching characteristics to ensure that any timing requirement of a device connected to the processor (such as memory) is satisfied.

Timing Requirements apply to signals that are controlled by circuitry external to the processor, such as the data input for a read operation. Timing requirements guarantee that the processor operates correctly with other devices.

During processor reset ( $\overline{\text{RESET}}$  pin low) or software reset (SRST bit in SYSCON register = 1), deassertion ( $\overline{\text{MS3-0}}$ ,  $\overline{\text{HBG}}$ ,  $\overline{\text{DMAGx}}$ ,  $\overline{\text{RDx}}$ ,  $\overline{\text{WRx}}$ ,  $\overline{\text{CIF}}$ , PAGE, BRST) and three-state ( $\overline{\text{FLAG3-0}}$ , LxCLK, LxACK, LxDAT7-0, ACK, REDY,  $\overline{\text{PA}}$ , TFSx, RFSx, TCLKx, RCLKx, DTx,  $\overline{\text{BMS}}$ , TDO,  $\overline{\text{EMU}}$ , DATA) timings differ. These occur asynchronously to CLKIN, and may not meet the specifications published in the Timing Requirements and Switching Characteristics tables. The maximum delay for deassertion and three-state is one  $t_{\text{CK}}$  from  $\overline{\text{RESET}}$  pin assertion low or setting the SRST bit in SYSCON. During reset the DSP will not respond to  $\overline{\text{SBTS}}$ ,  $\overline{\text{HBR}}$  and MMS accesses.  $\overline{\text{HBR}}$  asserted before reset will be recognized, but a  $\overline{\text{HBG}}$  will not be returned by the DSP until after reset is deasserted and the DSP has completed bus synchronization.

### Power-up Sequencing

For power-up sequencing, see [Table 4](#) and [Figure 6](#). During the power-up sequence of the DSP, differences in the ramp-up rates and activation time between the two power supplies can cause current to flow in the I/O ESD protection circuitry. To prevent this damage to the ESD diode protection circuitry, Analog Devices, Inc. recommends including a bootstrap Schottky diode (see [Figure 7](#)). The bootstrap Schottky diode connected between the 1.9 V and 3.3 V power supplies protects the ADSP-21160N from partially powering the 3.3 V supply. Including a Schottky diode will shorten the delay between the supply ramps and thus prevent damage to the ESD diode protection circuitry. With this technique, if the 1.9 V rail rises ahead of the 3.3 V rail, the Schottky diode pulls the 3.3 V rail along with the 1.9 V rail.

**Table 4. Power-up Sequencing**

Parameter	Min	Max	Unit
<i>Timing Requirements</i>			
$t_{RSTVDD}$	RESET Low Before $V_{DDINT}/V_{DDEXT}$ on		ns
$t_{VDDEVD}$	$V_{DDINT}$ on Before $V_{DDEXT}$		ms
$t_{CLKVDD}$	CLKIN Running After valid $V_{DDINT}/V_{DDEXT}$ <sup>1</sup>		ms
$t_{CLKRST}$	CLKIN Valid Before RESET Deasserted		$\mu$ s
$t_{PLLST}$	PLL Control Setup Before RESET Deasserted		$\mu$ s
<i>Switching Characteristics</i>			
$t_{CORERST}$	DSP Core Reset Deasserted After RESET Deasserted		$4096t_{CK}^{3,4}$

<sup>1</sup> Valid  $V_{DDINT}/V_{DDEXT}$  assumes that the supplies are fully ramped to their 1.9 V and 3.3 V rails. Voltage ramp rates can vary from microseconds to hundreds of milliseconds, depending on the design of the power supply subsystem.

<sup>2</sup> Assumes a stable CLKIN signal after meeting worst-case start-up timing of oscillators. Refer to your oscillator manufacturer's data sheet for start-up time.

<sup>3</sup> Based on CLKIN cycles.

<sup>4</sup> CORERST is an internal signal only. The 4096 cycle count is dependent on  $t_{SRST}$  specification. If setup time is not met, one additional CLKIN cycle may be added to the core reset time, resulting in 4097 cycles maximum.

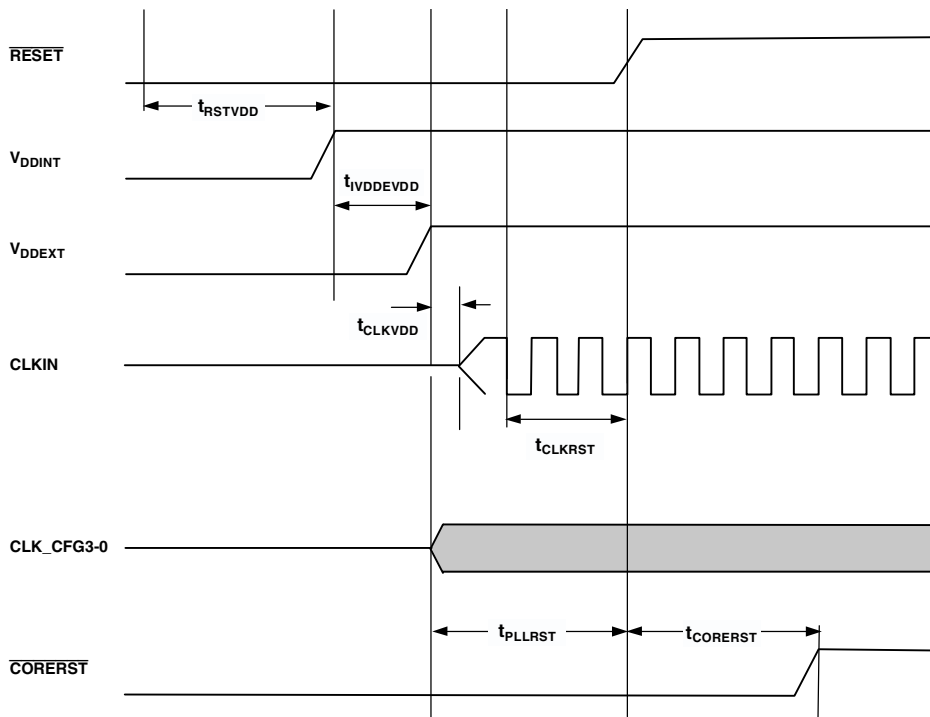

Figure 6. Power-up Sequencing

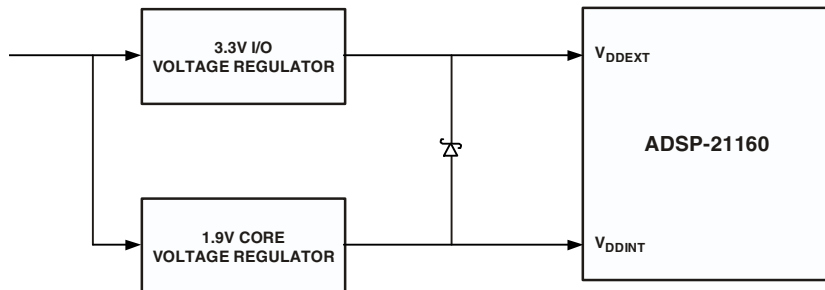

Figure 7. Dual Voltage Schottky Diode

# ADSP-21160N

## Clock Input

For Clock Input, see [Table 5](#) and [Figure 8](#).

**Table 5. Clock Input**

Parameter	100 MHz		Unit	
	Min	Max		
<i>Timing Requirements</i>				
$t_{CK}$	CLKIN Period	20	80	ns
$t_{CKL}$	CLKIN Width Low	7.5	40	ns
$t_{CKH}$	CLKIN Width High	7.5	40	ns
$t_{CKRF}$	CLKIN Rise/Fall (0.4 V–2.0 V)		3	ns
$t_{CCLK}$	Core Clock Period	10	30	ns

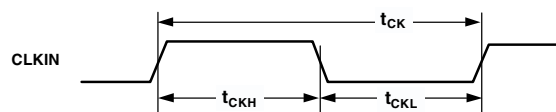

*Figure 8. Clock Input*

## Reset

For Reset, see [Table 6](#) and [Figure 9](#).

**Table 6. Reset**

Parameter	Min	Max	Unit
<i>Timing Requirements</i>			
$t_{WRST}$	$\overline{\text{RESET}}$ Pulsewidth Low <sup>1</sup>	$4t_{CK}$	ns
$t_{SRST}$	$\overline{\text{RESET}}$ Setup Before CLKIN High <sup>2</sup>	8	ns

<sup>1</sup>Applies after the power-up sequence is complete. At power-up, the processor's internal phase-locked loop requires no more than 100  $\mu$ s while  $\overline{\text{RESET}}$  is low, assuming stable  $V_{DD}$  and CLKIN (not including start-up time of external clock oscillator).

<sup>2</sup>Only required if multiple ADSP-21160Ns must come out of reset synchronous to CLKIN with program counters (PC) equal. Not required for multiple ADSP-21160Ns communicating over the shared bus (through the external port), because the bus arbitration logic automatically synchronizes itself after reset.

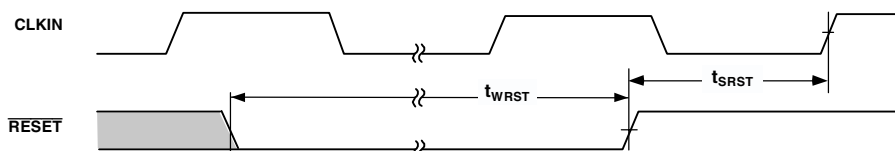

*Figure 9. Reset*

**Interrupts**

For Interrupts, see [Table 7](#) and [Figure 10](#).

**Table 7. Interrupts**

Parameter	Min	Max	Unit
<i>Timing Requirements</i>			
$t_{SIR}$ $\overline{IRQ2-0}$ Setup Before CLKIN High <sup>1</sup>	6		ns
$t_{HIR}$ $\overline{IRQ2-0}$ Hold After CLKIN High <sup>1</sup>	0		ns
$t_{IPW}$ $\overline{IRQ2-0}$ Pulsewidth <sup>2</sup>	$2 + t_{CK}$		ns

<sup>1</sup> Only required for  $\overline{IRQx}$  recognition in the following cycle.

<sup>2</sup> Applies only if  $t_{SIR}$  and  $t_{HIR}$  requirements are not met.

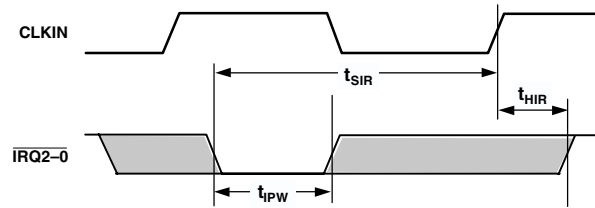

Figure 10. Interrupts

**Timer**

For Timer, see [Table 8](#) and [Figure 11](#).

**Table 8. Timer**

Parameter	Min	Max	Unit
<i>Switching Characteristic</i>			
$t_{DTEX}$ CLKIN High to TIMEXP	1	9	ns

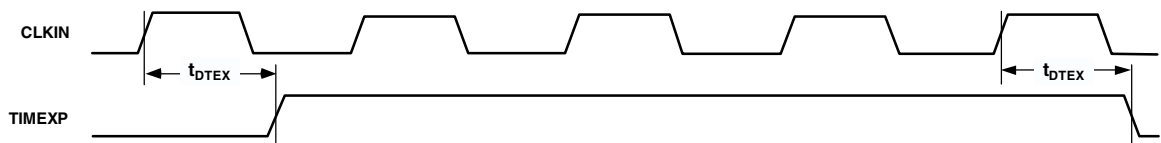

Figure 11. Timer

# ADSP-21160N

## Flags

For Flags, see [Table 9](#) and [Figure 12](#).

**Table 9. Flags**

Parameter	Min	Max	Unit
<i>Timing Requirements</i>			
$t_{SFI}$ FLAG3-0 IN Setup Before CLKIN High <sup>1</sup>	4		ns
$t_{HFI}$ FLAG3-0 IN Hold After CLKIN High <sup>1</sup>	1		ns
$t_{DWRFI}$ FLAG3-0 IN Delay After $\overline{RDx}/\overline{WRx}$ Low <sup>1</sup>		10	ns
$t_{HFIWR}$ FLAG3-0 IN Hold After $\overline{RDx}/\overline{WRx}$ Deasserted <sup>1</sup>	0		ns
<i>Switching Characteristics</i>			
$t_{DFO}$ FLAG3-0 OUT Delay After CLKIN High		9	ns
$t_{HFO}$ FLAG3-0 OUT Hold After CLKIN High	1		ns
$t_{DFOE}$ CLKIN High to FLAG3-0 OUT Enable	1		ns
$t_{DFOD}$ CLKIN High to FLAG3-0 OUT Disable		$t_{CK} - t_{CCLK} + 5$	ns

<sup>1</sup>Flag inputs meeting these setup and hold times for instruction cycle N will affect conditional instructions in instruction cycle N+2.

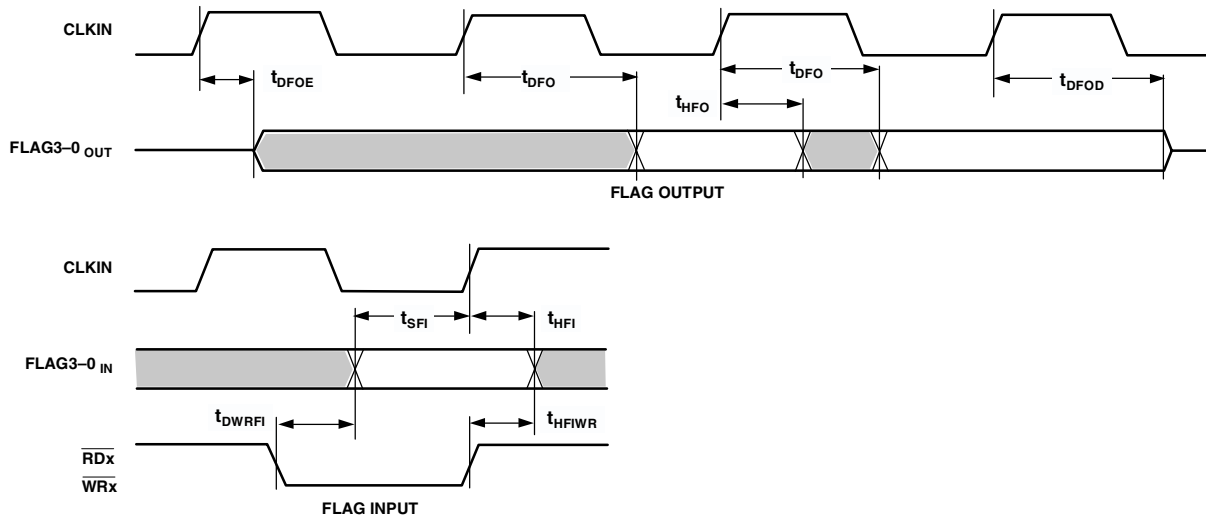

Figure 12. Flags



## Memory Read—Bus Master

See [Table 10](#) and [Figure 13](#). Use these specifications for asynchronous interfacing to memories (and memory-mapped peripherals) without reference to CLKIN. These specifications

apply when the ADSP-21160N is the bus master accessing external memory space in asynchronous access mode. Note that timing for ACK, DATA,  $\overline{RDx}$ ,  $\overline{WRx}$ , and  $\overline{DMAGx}$  strobe timing parameters only applies to asynchronous access mode.

**Table 10. Memory Read—Bus Master**

Parameter	Min	Max	Unit
<i>Timing Requirements</i>			
$t_{DAD}$	Address, $\overline{CIF}$ , Selects Delay to Data Valid <sup>1,2</sup>		ns
$t_{DRLD}$	$\overline{RDx}$ Low to Data Valid <sup>1</sup>		ns
$t_{HDA}$	Data Hold from Address, Selects <sup>3</sup>		ns
$t_{SDS}$	Data Setup to $\overline{RDx}$ High <sup>1</sup>		ns
$t_{HDRH}$	Data Hold from $\overline{RDx}$ High <sup>3</sup>		ns
$t_{DAAK}$	ACK Delay from Address, Selects <sup>2,4</sup>		ns
$t_{DSAK}$	ACK Delay from $\overline{RDx}$ Low <sup>4</sup>		ns
$t_{SAKC}$	ACK Setup to CLKIN <sup>4</sup>		ns
$t_{HAKC}$	ACK Hold After CLKIN		ns
<i>Switching Characteristics</i>			
$t_{DRHA}$	Address, $\overline{CIF}$ , Selects Hold After $\overline{RDx}$ High		ns
$t_{DARL}$	Address, $\overline{CIF}$ , Selects to $\overline{RDx}$ Low <sup>2</sup>		ns
$t_{RW}$	$\overline{RDx}$ Pulsewidth		ns
$t_{RWR}$	$\overline{RDx}$ High to $\overline{WRx}$ , $\overline{RDx}$ , $\overline{DMAGx}$ Low		ns

$W = (\text{number of wait states specified in WAIT register}) \times t_{CK}$ .

HI =  $t_{CK}$  (if an address hold cycle or bus idle cycle occurs, as specified in WAIT register; otherwise HI = 0).

H =  $t_{CK}$  (if an address hold cycle occurs as specified in WAIT register; otherwise H = 0).

<sup>1</sup>Data Delay/Setup: User must meet  $t_{DAD}$ ,  $t_{DRLD}$ , or  $t_{SDS}$ .

<sup>2</sup>The falling edge of  $\overline{MSx}$ ,  $\overline{BMS}$  is referenced.

<sup>3</sup>Data Hold: User must meet  $t_{HDA}$  or  $t_{HDRH}$  in asynchronous access mode. See Example System Hold Time Calculation on [Page 41](#) for the calculation of hold times given capacitive and dc loads.

<sup>4</sup>ACK Delay/Setup: User must meet  $t_{DAAK}$ ,  $t_{DSAK}$ , or  $t_{SAKC}$  for deassertion of ACK (Low), all three specifications must be met for assertion of ACK (High).

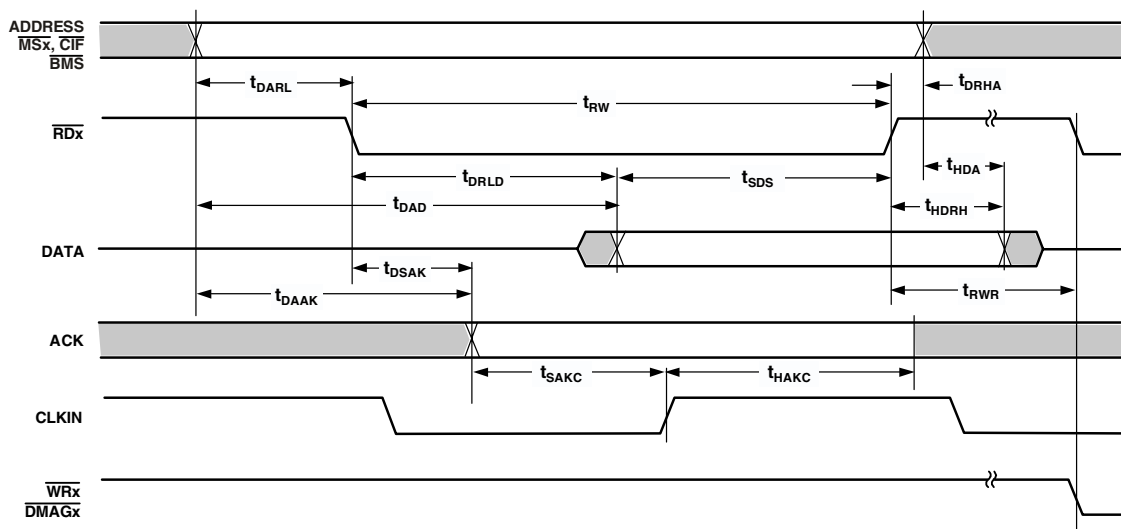

Figure 13. Memory Read—Bus Master

# ADSP-21160N

## Memory Write—Bus Master

See Table 11 and Figure 14. Use these specifications for asynchronous interfacing to memories (and memory-mapped peripherals) without reference to CLKIN. These specifications

apply when the ADSP-21160N is the bus master accessing external memory space in asynchronous access mode. Note that timing for ACK, DATA,  $\overline{RDx}$ ,  $\overline{WRx}$ , and  $\overline{DMAGx}$  strobe timing parameters only applies to asynchronous access mode.

**Table 11. Memory Write—Bus Master**

Parameter	Min	Max	Unit
<i>Timing Requirements</i>			
$t_{DAAK}$ ACK Delay from Address, Selects <sup>1, 2</sup>		$t_{CK} - 0.5t_{CCLK} - 12 + W$	ns
$t_{DSAK}$ ACK Delay from $\overline{WRx}$ Low <sup>1</sup>		$t_{CK} - 0.75t_{CCLK} - 11 + W$	ns
$t_{SAKC}$ ACK Setup to CLKIN <sup>1</sup>	$0.5t_{CCLK} + 3$		ns
$t_{HAKC}$ ACK Hold After CLKIN <sup>1</sup>	1		ns
<i>Switching Characteristics</i>			
$t_{DAWH}$ Address, $\overline{CIF}$ , Selects to $\overline{WRx}$ Deasserted <sup>2</sup>	$t_{CK} - 0.25t_{CCLK} - 3 + W$		ns
$t_{DAWL}$ Address, $\overline{CIF}$ , Selects to $\overline{WRx}$ Low <sup>2</sup>	$0.25t_{CCLK} - 3$		ns
$t_{WW}$ $\overline{WRx}$ Pulsewidth	$t_{CK} - 0.5t_{CCLK} - 1 + W$		ns
$t_{DDWH}$ Data Setup before $\overline{WRx}$ High	$t_{CK} - 0.5t_{CCLK} - 1 + W$		ns
$t_{DWHa}$ Address Hold after $\overline{WRx}$ Deasserted	$0.25t_{CCLK} - 1 + H$		ns
$t_{DWHd}$ Data Hold after $\overline{WRx}$ Deasserted	$0.25t_{CCLK} - 1 + H$		ns
$t_{DATRWH}$ Data Disable after $\overline{WRx}$ Deasserted <sup>3</sup>	$0.25t_{CCLK} - 2 + H$	$0.25t_{CCLK} + 2 + H$	ns
$t_{WWR}$ $\overline{WRx}$ High to $\overline{WRx}$ , $\overline{RDx}$ , $\overline{DMAGx}$ Low	$0.5t_{CCLK} - 1 + HI$		ns
$t_{DDWR}$ Data Disable before $\overline{WRx}$ or $\overline{RDx}$ Low	$0.25t_{CCLK} - 1 + I$		ns
$t_{WDE}$ $\overline{WRx}$ Low to Data Enabled	$-0.25t_{CCLK} - 1$		ns

W = (number of wait states specified in WAIT register) ×  $t_{CK}$ .

H =  $t_{CK}$  (if an address hold cycle occurs, as specified in WAIT register; otherwise H = 0).

HI =  $t_{CK}$  (if an address hold cycle or bus idle cycle occurs, as specified in WAIT register; otherwise HI = 0).

I =  $t_{CK}$  (if a bus idle cycle occurs, as specified in WAIT register; otherwise I = 0).

<sup>1</sup> ACK Delay/Setup: User must meet  $t_{DAAK}$  or  $t_{DSAK}$  or  $t_{SAKC}$  for deassertion of ACK (Low), all three specifications must be met for assertion of ACK (High).

<sup>2</sup> The falling edge of  $\overline{MSx}$ ,  $\overline{BMS}$  is referenced.

<sup>3</sup> See Example System Hold Time Calculation on Page 41 for calculation of hold times given capacitive and dc loads.

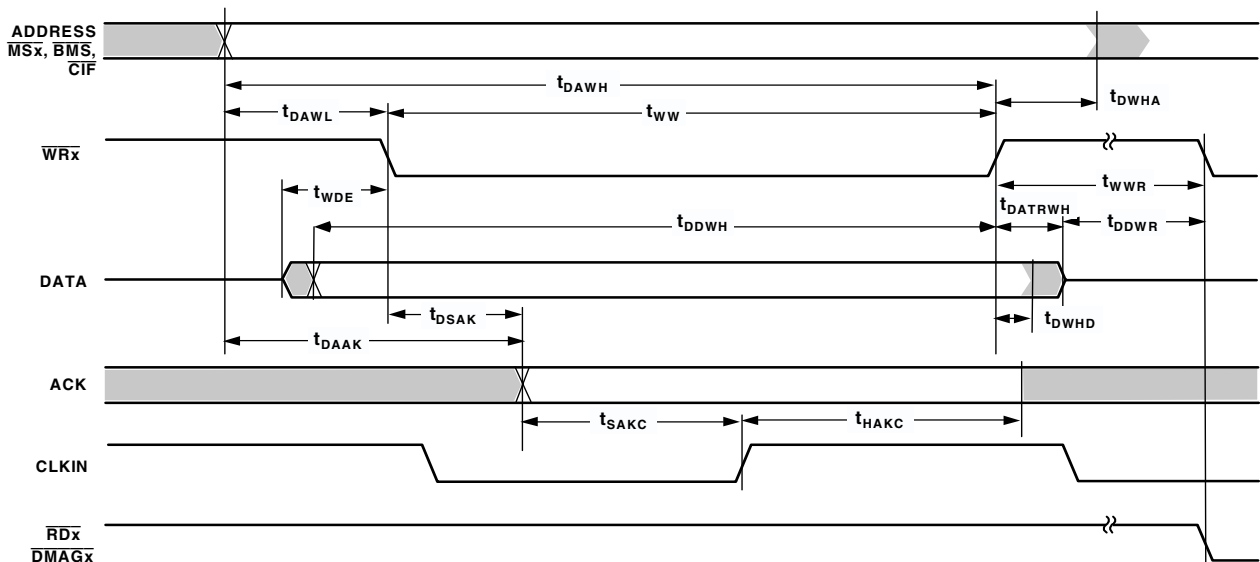

Figure 14. Memory Write—Bus Master

### Synchronous Read/Write—Bus Master

See Table 12 and Figure 15. Use these specifications for interfacing to external memory systems that require CLKIN—relative timing or for accessing a slave ADSP-21160N (in multiprocessor memory space). These synchronous switching characteristics are also valid during asynchronous memory reads and writes except where noted (see Memory Read—Bus Master on Page 21 and

Memory Write—Bus Master on Page 22). When accessing a slave ADSP-21160N, these switching characteristics must meet the slave’s timing requirements for synchronous read/writes (see Synchronous Read/Write—Bus Slave on Page 25). The slave ADSP-21160N must also meet these (bus master) timing requirements for data and acknowledge setup and hold times.

**Table 12. Synchronous Read/Write—Bus Master**

Parameter	Min	Max	Unit
<i>Timing Requirements</i>			
t <sub>SSDATI</sub> Data Setup Before CLKIN	5.5		ns
t <sub>HSDATI</sub> Data Hold After CLKIN	1		ns
t <sub>SACKC</sub> ACK Setup Before CLKIN	0.5t <sub>CCLK</sub> + 3		ns
t <sub>HACKC</sub> ACK Hold After CLKIN	1		ns
<i>Switching Characteristics</i>			
t <sub>DADDO</sub> Address, $\overline{MSx}$ , $\overline{BMS}$ , $\overline{BRST}$ , $\overline{CIF}$ Delay After CLKIN		10	ns
t <sub>HADDO</sub> Address, $\overline{MSx}$ , $\overline{BMS}$ , $\overline{BRST}$ , $\overline{CIF}$ Hold After CLKIN	1.5		ns
t <sub>DPGO</sub> PAGE Delay After CLKIN	1.5	11	ns
t <sub>DRDO</sub> $\overline{RDx}$ High Delay After CLKIN	0.25t <sub>CCLK</sub> - 1	0.25t <sub>CCLK</sub> + 9	ns
t <sub>DWRO</sub> $\overline{WRx}$ High Delay After CLKIN	0.25t <sub>CCLK</sub> - 1	0.25t <sub>CCLK</sub> + 9	ns
t <sub>DRWL</sub> $\overline{RDx}/\overline{WRx}$ Low Delay After CLKIN	0.25t <sub>CCLK</sub> - 1	0.25t <sub>CCLK</sub> + 9	ns
t <sub>DDATO</sub> Data Delay After CLKIN		0.25t <sub>CCLK</sub> + 9	ns
t <sub>HDATO</sub> Data Hold After CLKIN	1.5		ns
t <sub>DACKMO</sub> ACK Delay After CLKIN <sup>1</sup>	3	9	ns
t <sub>ACKMTR</sub> ACK Disable Before CLKIN <sup>1</sup>	-3		ns
t <sub>DCKOO</sub> CLKOUT Delay After CLKIN	0.5	5	ns
t <sub>CKOP</sub> CLKOUT Period	t <sub>CK</sub> - 1	t <sub>CK</sub> <sup>2</sup> + 1	ns
t <sub>CKWH</sub> CLKOUT Width High	t <sub>CK</sub> /2 - 2	t <sub>CK</sub> /2 + 2 <sup>2</sup>	ns
t <sub>CKWL</sub> CLKOUT Width Low	t <sub>CK</sub> /2 - 2	t <sub>CK</sub> /2 + 2 <sup>2</sup>	ns

<sup>1</sup>Applies to broadcast write, master precharge of ACK.

<sup>2</sup>Applies only when the DSP drives a bus operation; CLKOUT held inactive or three-state otherwise. For more information, see the System Design chapter in the ADSP-2116x SHARC DSP Hardware Reference.

# ADSP-21160N

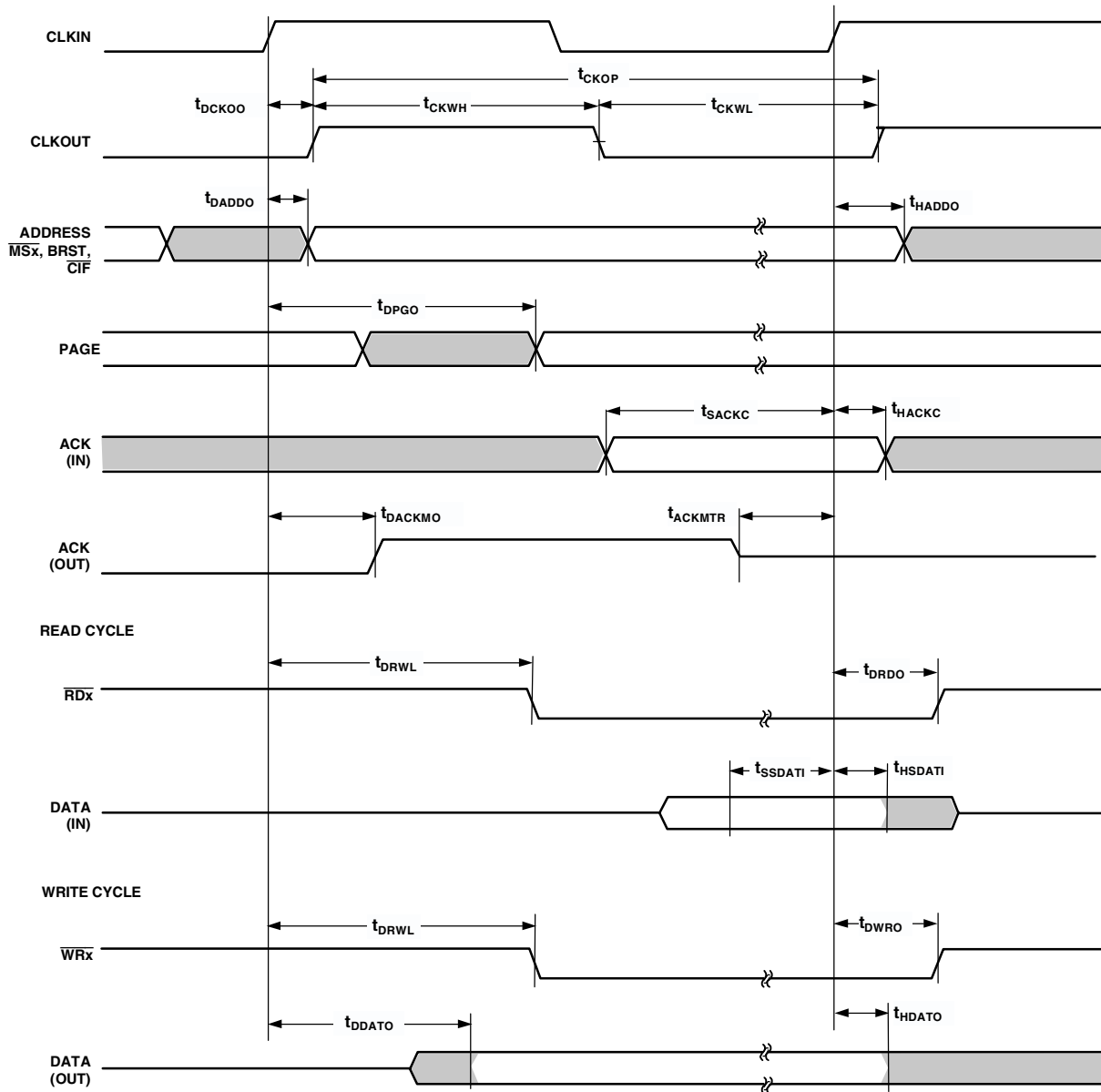

Figure 15. Synchronous Read/Write—Bus Master

### Synchronous Read/Write—Bus Slave

See Table 13 and Figure 16. Use these specifications for ADSP-21160N bus master accesses of a slave's IOP registers or internal memory (in multiprocessor memory space). The bus master must meet these (bus slave) timing requirements.

**Table 13. Synchronous Read/Write—Bus Slave**

Parameter		Min	Max	Unit
<i>Timing Requirements</i>				
$t_{SADDI}$	Address, BRST Setup Before CLKIN	5		ns
$t_{HADDI}$	Address, BRST Hold After CLKIN	1		ns
$t_{SRWI}$	$\overline{RDx}/\overline{WRx}$ Setup Before CLKIN	5		ns
$t_{HRWI}$	$\overline{RDx}/\overline{WRx}$ Hold After CLKIN	1		ns
$t_{SSDATI}$	Data Setup Before CLKIN	5.5		ns
$t_{HSDATI}$	Data Hold After CLKIN	1		ns
<i>Switching Characteristics</i>				
$t_{DDATO}$	Data Delay After CLKIN		$0.25 t_{CCLK} + 9$	ns
$t_{HDATA}$	Data Hold After CLKIN	1.5		ns
$t_{DACKC}$	ACK Delay After CLKIN		10	ns
$t_{HACKO}$	ACK Hold After CLKIN	1.5		ns

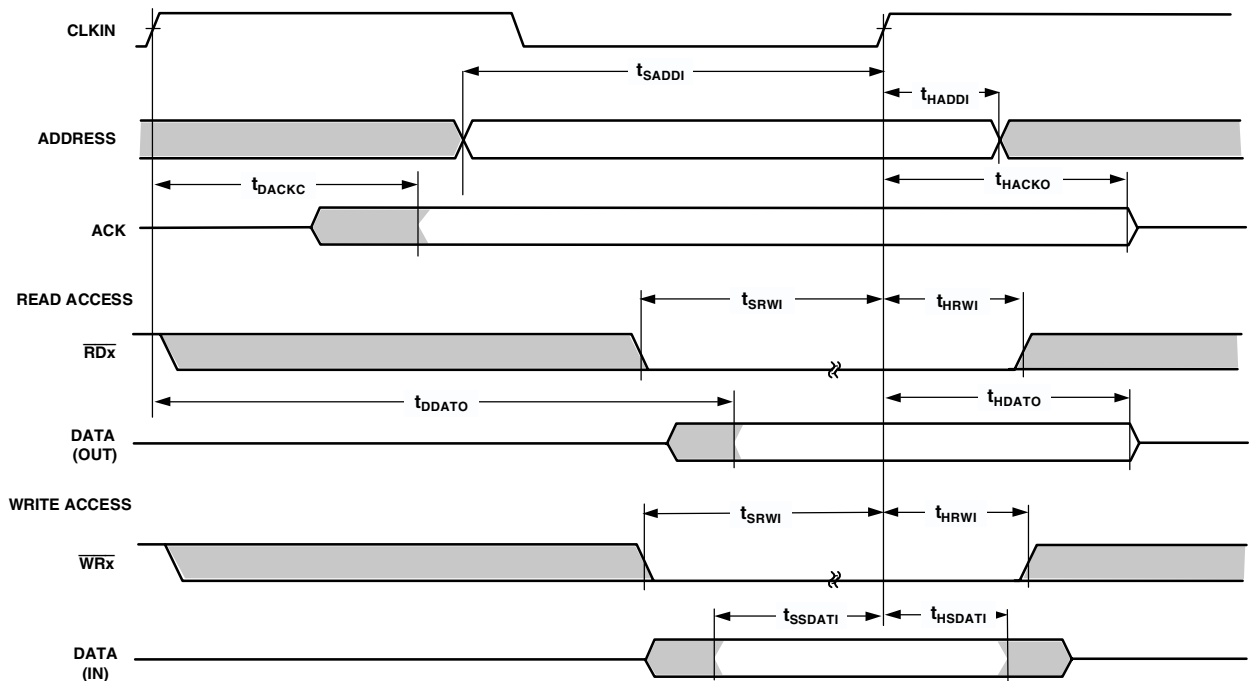

Figure 16. Synchronous Read/Write—Bus Slave

# ADSP-21160N

## Multiprocessor Bus Request and Host Bus Request

See Table 14 and Figure 17. Use these specifications for passing of bus mastership between multiprocessing ADSP-21160Ns ( $\overline{\text{BRx}}$ ) or a host processor, both synchronous and asynchronous ( $\overline{\text{HBR}}$ ,  $\overline{\text{HBG}}$ ).

**Table 14. Multiprocessor Bus Request and Host Bus Request**

Parameter		Min	Max	Unit
<i>Timing Requirements</i>				
$t_{\text{HBGRCSV}}$	$\overline{\text{HBG}}$ Low to $\overline{\text{RDx}}/\overline{\text{WRx}}/\overline{\text{CS}}$ Valid		$6.5 + t_{\text{CK}} + t_{\text{CCLK}} - 12.5\text{CR}$	ns
$t_{\text{SHBRI}}$	$\overline{\text{HBR}}$ Setup Before CLKIN <sup>1</sup>	6		ns
$t_{\text{HHBRI}}$	$\overline{\text{HBR}}$ Hold After CLKIN <sup>1</sup>	1		ns
$t_{\text{SHBGI}}$	$\overline{\text{HBG}}$ Setup Before CLKIN	6		ns
$t_{\text{HHBGI}}$	$\overline{\text{HBG}}$ Hold After CLKIN High	1		ns
$t_{\text{SBRI}}$	$\overline{\text{BRx}}$ , $\overline{\text{PA}}$ Setup Before CLKIN	9		ns
$t_{\text{HBRI}}$	$\overline{\text{BRx}}$ , $\overline{\text{PA}}$ Hold After CLKIN High	1		ns
$t_{\text{SRPBAI}}$	RPBA Setup Before CLKIN	6		ns
$t_{\text{HRPBAI}}$	RPBA Hold After CLKIN	2		ns
<i>Switching Characteristics</i>				
$t_{\text{DHBGO}}$	$\overline{\text{HBG}}$ Delay After CLKIN		7	ns
$t_{\text{HHBGO}}$	$\overline{\text{HBG}}$ Hold After CLKIN	1.5		ns
$t_{\text{DBRO}}$	$\overline{\text{BRx}}$ Delay After CLKIN		8	ns
$t_{\text{HBRO}}$	$\overline{\text{BRx}}$ Hold After CLKIN	1.5		ns
$t_{\text{DPASO}}$	$\overline{\text{PA}}$ Delay After CLKIN, Slave		8	ns
$t_{\text{TRPAS}}$	$\overline{\text{PA}}$ Disable After CLKIN, Slave	1.5		ns
$t_{\text{DPAMO}}$	$\overline{\text{PA}}$ Delay After CLKIN, Master		$0.25t_{\text{CCLK}} + 9$	ns
$t_{\text{PATR}}$	$\overline{\text{PA}}$ Disable Before CLKIN, Master	$0.25t_{\text{CCLK}} - 5.5$		ns
$t_{\text{DRDYCS}}$	REDY (O/D) or (A/D) Low from $\overline{\text{CS}}$ and $\overline{\text{HBR}}$ Low <sup>2</sup>		$0.5t_{\text{CK}} + 1.0$	ns
$t_{\text{TRDYHG}}$	REDY (O/D) Disable or REDY (A/D) High from $\overline{\text{HBG}}$ <sup>2</sup>	$t_{\text{CK}} + 15$		ns
$t_{\text{ARDYTR}}$	REDY (A/D) Disable from $\overline{\text{CS}}$ or $\overline{\text{HBR}}$ High <sup>2</sup>		11	ns

<sup>1</sup> Only required for recognition in the current cycle.

<sup>2</sup> (O/D) = open drain, (A/D) = active drive.



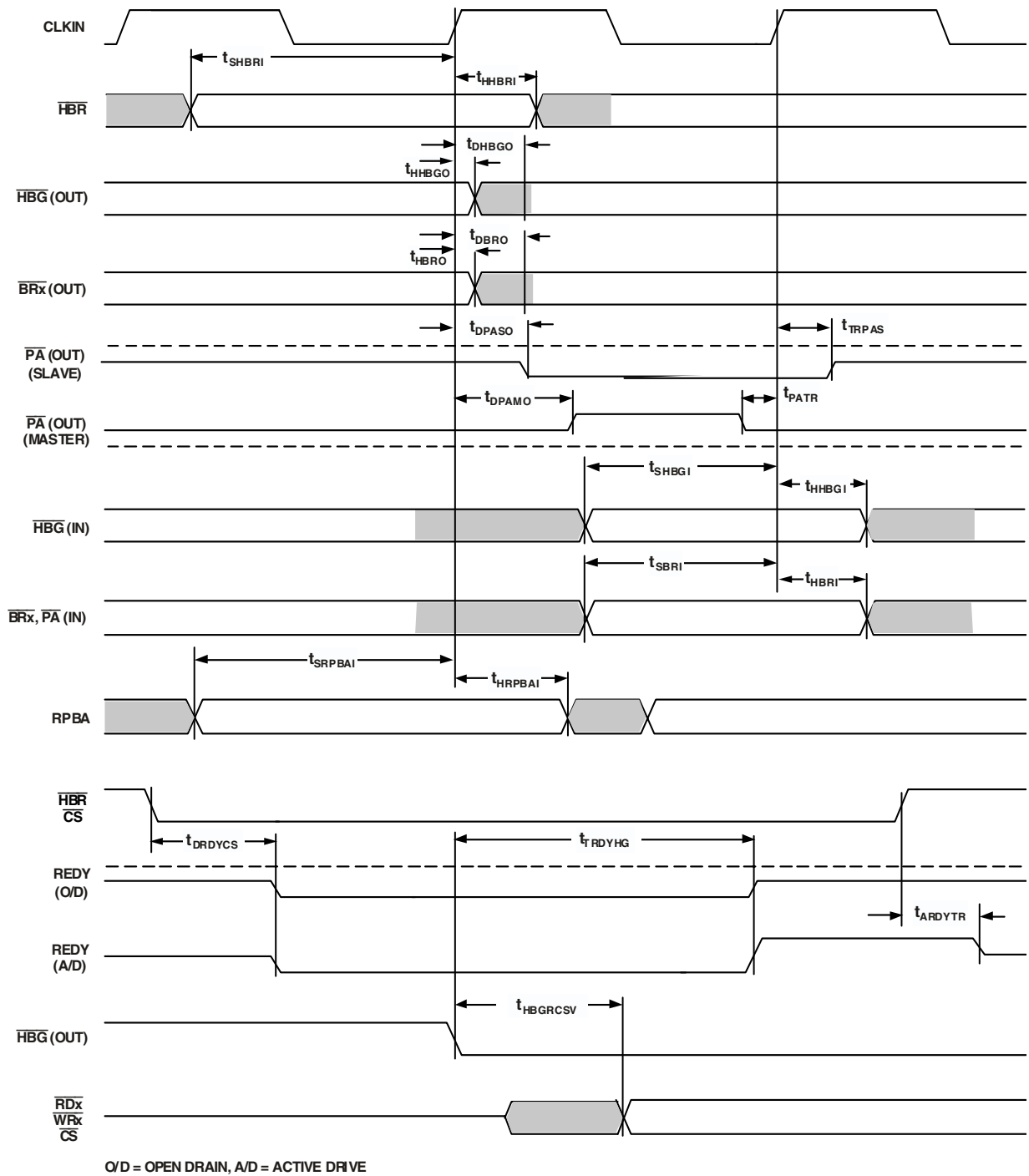

Figure 17. Multiprocessor Bus Request and Host Bus Request

# ADSP-21160N

## Asynchronous Read/Write—Host to ADSP-21160N

Use these specifications (Table 15, Table 16, Figure 18, and Figure 19) for asynchronous host processor accesses of an ADSP-21160N, after the host has asserted  $\overline{CS}$  and  $\overline{HBR}$  (low).

After  $\overline{HBG}$  is returned by the ADSP-21160N, the host can drive the  $\overline{RDx}$  and  $\overline{WRx}$  pins to access the ADSP-21160N's internal memory or IOP registers.  $\overline{HBR}$  and  $\overline{HBG}$  are assumed low for this timing.

**Table 15. Read Cycle**

Parameter	Min	Max	Unit
<i>Timing Requirements</i>			
$t_{SADRDL}$	Address Setup/ $\overline{CS}$ Low Before $\overline{RDx}$ Low		ns
$t_{HADRDH}$	Address Hold/ $\overline{CS}$ Hold Low After $\overline{RDx}$		ns
$t_{WRWH}$	$\overline{RDx}/\overline{WRx}$ High Width		ns
$t_{DRDHRDY}$	$\overline{RDx}$ High Delay After REDY (O/D) Disable		ns
$t_{DRDHRDY}$	$\overline{RDx}$ High Delay After REDY (A/D) Disable		ns
<i>Switching Characteristics</i>			
$t_{SDATRDY}$	Data Valid Before REDY Disable from Low		ns
$t_{DRDYRDL}$	REDY (O/D) or (A/D) Low Delay After $\overline{RDx}$ Low		ns
$t_{RDYPRD}$	REDY (O/D) or (A/D) Low Pulsewidth for Read		ns
$t_{HDARWH}$	Data Disable After $\overline{RDx}$ High		ns

**Table 16. Write Cycle**

Parameter	Min	Max	Unit
<i>Timing Requirements</i>			
$t_{SCSWRL}$	$\overline{CS}$ Low Setup Before $\overline{WRx}$ Low		ns
$t_{HCSWRH}$	$\overline{CS}$ Low Hold After $\overline{WRx}$ High		ns
$t_{SADWRH}$	Address Setup Before $\overline{WRx}$ High		ns
$t_{HADWRH}$	Address Hold After $\overline{WRx}$ High		ns
$t_{WWRL}$	$\overline{WRx}$ Low Width		ns
$t_{WRWH}$	$\overline{RDx}/\overline{WRx}$ High Width		ns
$t_{DWRHRDY}$	$\overline{WRx}$ High Delay After REDY (O/D) or (A/D) Disable		ns
$t_{SDATWH}$	Data Setup Before $\overline{WRx}$ High		ns
$t_{HDATWH}$	Data Hold After $\overline{WRx}$ High		ns
<i>Switching Characteristics</i>			
$t_{DRDYWRL}$	REDY (O/D) or (A/D) Low Delay After $\overline{WRx}/\overline{CS}$ Low		ns
$t_{RDYPPWR}$	REDY (O/D) or (A/D) Low Pulsewidth for Write		ns

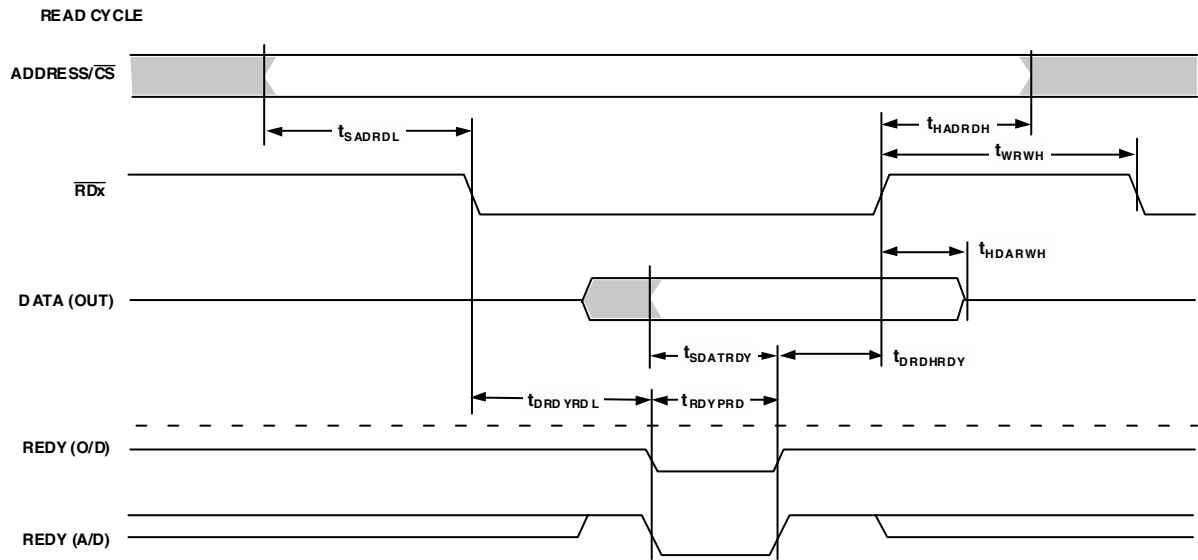

Figure 18. Asynchronous Read—Host to ADSP-21160N

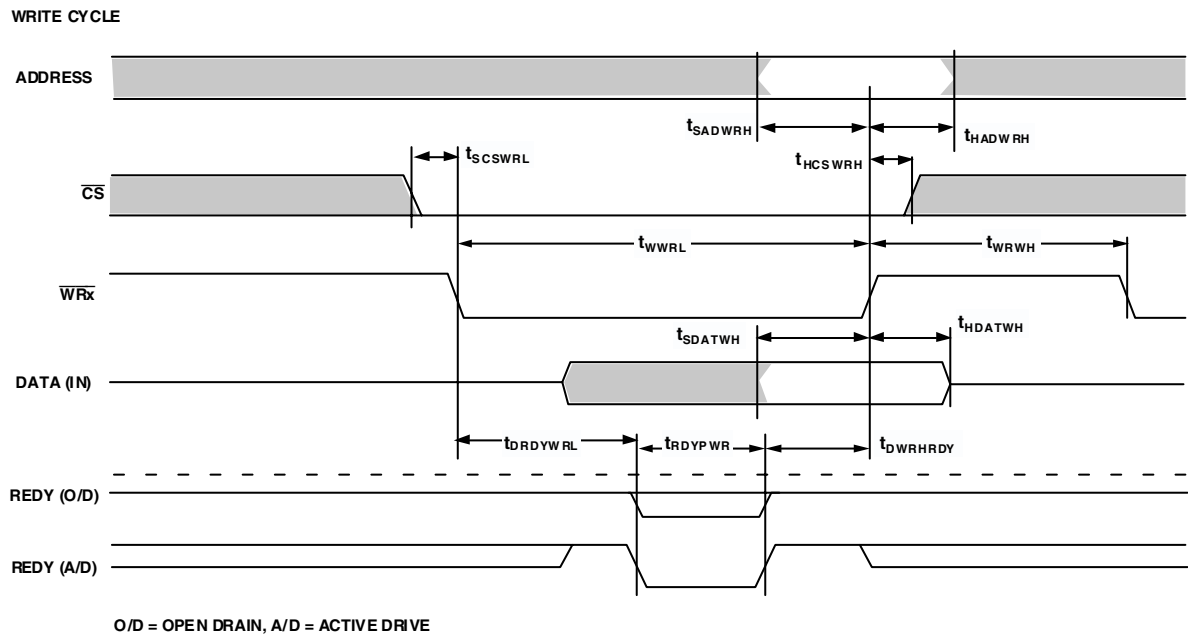

Figure 19. Asynchronous Write—Host to ADSP-21160N

# ADSP-21160N

## Three-State Timing—Bus Master, Bus Slave

See Table 17 and Figure 20. These specifications show how the memory interface is disabled (stops driving) or enabled (resumes driving) relative to CLKIN and the  $\overline{\text{SBTS}}$  pin. This timing is applicable to bus master transition cycles (BTC) and host transition cycles (HTC) as well as the  $\overline{\text{SBTS}}$  pin.

**Table 17. Three-State Timing—Bus Master, Bus Slave**

Parameter	Min	Max	Unit
<i>Timing Requirements</i>			
$t_{\text{STSCK}}$ $\overline{\text{SBTS}}$ Setup Before CLKIN	6		ns
$t_{\text{HTSCK}}$ $\overline{\text{SBTS}}$ Hold After CLKIN	2		ns
<i>Switching Characteristics</i>			
$t_{\text{MIENA}}$ Address/Select Enable After CLKIN	1.5	9	ns
$t_{\text{MIENS}}$ Strobes Enable After CLKIN <sup>1</sup>	1.5	9	ns
$t_{\text{MIENHG}}$ $\overline{\text{HBG}}$ Enable After CLKIN	1.5	9	ns
$t_{\text{MITRA}}$ Address/Select Disable After CLKIN	0.5	9	ns
$t_{\text{MITRS}}$ Strobes Disable After CLKIN <sup>1,2</sup>	$0.25t_{\text{CCLK}} - 4$	$0.25t_{\text{CCLK}} + 1.5$	ns
$t_{\text{MITRHG}}$ $\overline{\text{HBG}}$ Disable After CLKIN	0.5	8	ns
$t_{\text{DATEN}}$ Data Enable After CLKIN <sup>3</sup>	$0.25t_{\text{CCLK}} + 1$	$0.25t_{\text{CCLK}} + 7$	ns
$t_{\text{DATTR}}$ Data Disable After CLKIN <sup>3</sup>	0.5	5	ns
$t_{\text{ACKEN}}$ ACK Enable After CLKIN <sup>3</sup>	1.5	9	ns
$t_{\text{ACKTR}}$ ACK Disable After CLKIN <sup>3</sup>	1.5	5	ns
$t_{\text{CDCEEN}}$ CLKOUT Enable After CLKIN	0.5	9	ns
$t_{\text{CDCTR}}$ CLKOUT Disable After CLKIN	$t_{\text{CCLK}} - 3$	$t_{\text{CCLK}} + 1$	ns
$t_{\text{ATRHBG}}$ Address, $\overline{\text{MSx}}$ Disable Before $\overline{\text{HBG}}$ Low	$1.5t_{\text{CK}} - 6$	$1.5t_{\text{CK}} + 5$	ns
$t_{\text{STRHBG}}$ $\overline{\text{RDx}}$ , $\overline{\text{WRx}}$ , $\overline{\text{DMAGx}}$ Disable Before $\overline{\text{HBG}}$ Low	$t_{\text{CK}} + 0.25t_{\text{CCLK}} - 6$	$t_{\text{CK}} + 0.25t_{\text{CCLK}} + 5$	ns
$t_{\text{PTRHBG}}$ Page Disable Before $\overline{\text{HBG}}$ Low	$t_{\text{CK}} - 6$	$t_{\text{CK}} + 5$	ns
$t_{\text{BTRHBG}}$ $\overline{\text{BMS}}$ Disable Before $\overline{\text{HBG}}$ Low	$0.5t_{\text{CK}} - 6.5$	$0.5t_{\text{CK}} + 1.5$	ns
$t_{\text{MENHBG}}$ Memory Interface Enable After $\overline{\text{HBG}}$ High <sup>4</sup>	$t_{\text{CK}} - 5$	$t_{\text{CK}} + 6$	ns

<sup>1</sup> Strobes =  $\overline{\text{RDx}}$ ,  $\overline{\text{WRx}}$ ,  $\overline{\text{DMAGx}}$ .

<sup>2</sup> If access aborted by  $\overline{\text{SBTS}}$ , then strobes disable *before* CLKIN [ $0.25t_{\text{CCLK}} + 1.5$  (min.),  $0.25t_{\text{CCLK}} + 5$  (max.)]

<sup>3</sup> In addition to bus master transition cycles, these specs also apply to bus master and bus slave synchronous read/write.

<sup>4</sup> Memory Interface = Address,  $\overline{\text{RDx}}$ ,  $\overline{\text{WRx}}$ ,  $\overline{\text{MSx}}$ ,  $\overline{\text{PAGE}}$ ,  $\overline{\text{DMAGx}}$ , and  $\overline{\text{BMS}}$  (in EPROM boot mode).

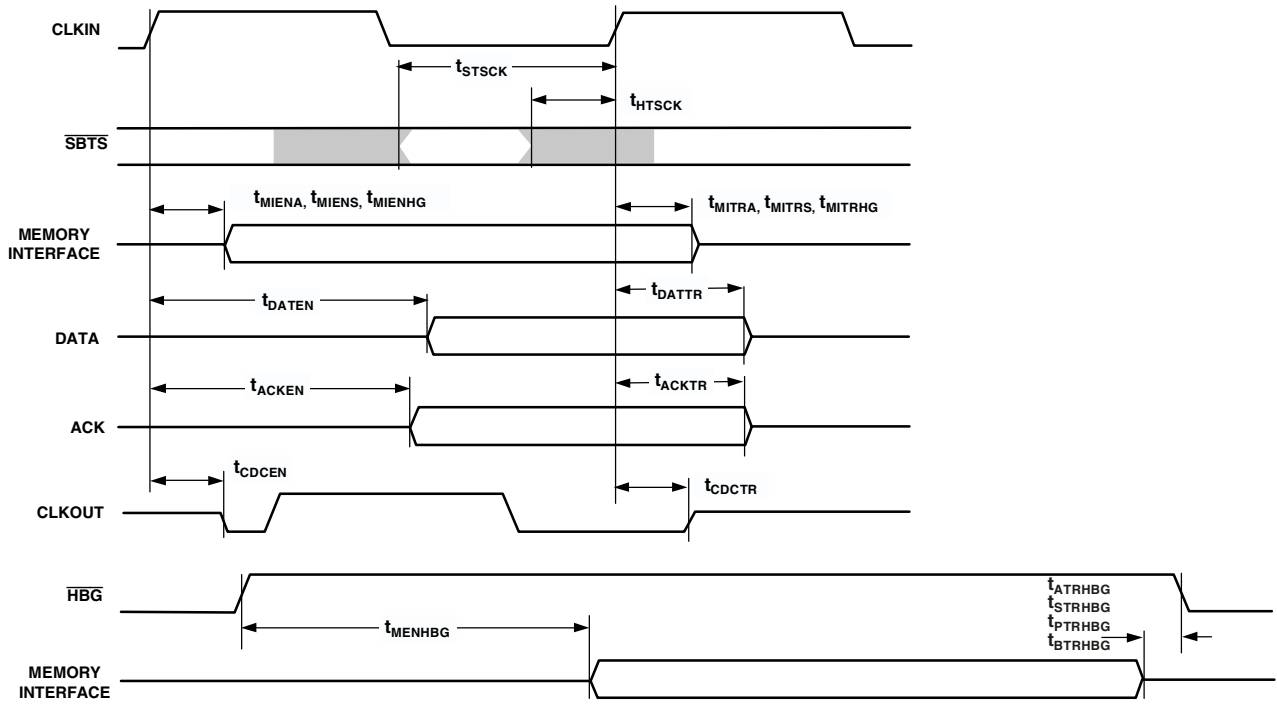

MEMORY INTERFACE = ADDRESS, RDx, WRx, MSx, PAGE, DMAGx. BMS (IN EPROM BOOT MODE)

Figure 20. Three-State Timing—Bus Master, Bus Slave

# ADSP-21160N

## DMA Handshake

See Table 18 and Figure 21. These specifications describe the three DMA handshake modes. In all three modes,  $\overline{\text{DMARx}}$  is used to initiate transfers. For handshake mode,  $\overline{\text{DMAGx}}$  controls the latching or enabling of data externally. For external handshake mode, the data transfer is controlled by the  $\text{ADDR31-0}$ ,  $\overline{\text{RDx}}$ ,  $\overline{\text{WRx}}$ ,  $\text{PAGE}$ ,  $\overline{\text{MS3-0}}$ ,  $\text{ACK}$ , and  $\overline{\text{DMAGx}}$  signals. For

Paced Master mode, the data transfer is controlled by  $\text{ADDR31-0}$ ,  $\overline{\text{RDx}}$ ,  $\overline{\text{WRx}}$ ,  $\overline{\text{MS3-0}}$ , and  $\text{ACK}$  (not  $\overline{\text{DMAGx}}$ ). For Paced Master mode, the Memory Read-Bus Master, Memory Write-Bus Master, and Synchronous Read/Write-Bus Master timing specifications for  $\text{ADDR31-0}$ ,  $\overline{\text{RDx}}$ ,  $\overline{\text{WRx}}$ ,  $\overline{\text{MS3-0}}$ ,  $\text{PAGE}$ ,  $\text{DATA63-0}$ , and  $\text{ACK}$  also apply.

**Table 18. DMA Handshake**

Parameter	Min	Max	Unit	
<i>Timing Requirements</i>				
$t_{\text{SDRC}}$	$\overline{\text{DMARx}}$ Setup Before $\text{CLKIN}$ <sup>1</sup>	3	ns	
$t_{\text{WDR}}$	$\overline{\text{DMARx}}$ Width Low (Nonsynchronous) <sup>2</sup>	$0.5t_{\text{CCLK}} + 2.5$	ns	
$t_{\text{SDATDGL}}$	Data Setup After $\overline{\text{DMAGx}}$ Low <sup>3</sup>	$t_{\text{CK}} - 0.5t_{\text{CCLK}} - 7$	ns	
$t_{\text{HDATIDG}}$	Data Hold After $\overline{\text{DMAGx}}$ High	2	ns	
$t_{\text{DATDRH}}$	Data Valid After $\overline{\text{DMARx}}$ High <sup>3</sup>	$t_{\text{CK}} + 3$	ns	
$t_{\text{DMARLL}}$	$\overline{\text{DMARx}}$ Low Edge to Low Edge <sup>4</sup>	$t_{\text{CK}}$	ns	
$t_{\text{DMARH}}$	$\overline{\text{DMARx}}$ Width High <sup>2</sup>	$0.5t_{\text{CCLK}} + 1$	ns	
<i>Switching Characteristics</i>				
$t_{\text{DDGL}}$	$\overline{\text{DMAGx}}$ Low Delay After $\text{CLKIN}$	$0.25t_{\text{CCLK}} + 1$	$0.25t_{\text{CCLK}} + 9$	ns
$t_{\text{WDGH}}$	$\overline{\text{DMAGx}}$ High Width	$0.5t_{\text{CCLK}} - 1 + \text{HI}$		ns
$t_{\text{WDGL}}$	$\overline{\text{DMAGx}}$ Low Width	$t_{\text{CK}} - 0.5t_{\text{CCLK}} - 1$		ns
$t_{\text{HDGC}}$	$\overline{\text{DMAGx}}$ High Delay After $\text{CLKIN}$	$t_{\text{CK}} - 0.25t_{\text{CCLK}} + 1.5$	$t_{\text{CK}} - 0.25t_{\text{CCLK}} + 9$	ns
$t_{\text{VDATDGH}}$	Data Valid Before $\overline{\text{DMAGx}}$ High <sup>5</sup>	$t_{\text{CK}} - 0.25t_{\text{CCLK}} - 8$	$t_{\text{CK}} - 0.25t_{\text{CCLK}} + 5$	ns
$t_{\text{DATRDGH}}$	Data Disable After $\overline{\text{DMAGx}}$ High <sup>6</sup>	$0.25t_{\text{CCLK}} - 3$	$0.25t_{\text{CCLK}} + 1.5$	ns
$t_{\text{DGWRL}}$	$\overline{\text{WRx}}$ Low Before $\overline{\text{DMAGx}}$ Low	-1.5	2	ns
$t_{\text{DGWRH}}$	$\overline{\text{DMAGx}}$ Low Before $\overline{\text{WRx}}$ High	$t_{\text{CK}} - 0.5t_{\text{CCLK}} - 2 + \text{W}$		ns
$t_{\text{DGWRR}}$	$\overline{\text{WRx}}$ High Before $\overline{\text{DMAGx}}$ High <sup>7</sup>	-1.5	2	ns
$t_{\text{DGRDL}}$	$\overline{\text{RDx}}$ Low Before $\overline{\text{DMAGx}}$ Low	-1.5	2	ns
$t_{\text{DRDGH}}$	$\overline{\text{RDx}}$ Low Before $\overline{\text{DMAGx}}$ High	$t_{\text{CK}} - 0.5t_{\text{CCLK}} - 2 + \text{W}$		ns
$t_{\text{DGRDR}}$	$\overline{\text{RDx}}$ High Before $\overline{\text{DMAGx}}$ High <sup>7</sup>	-1.5	2	ns
$t_{\text{DGWR}}$	$\overline{\text{DMAGx}}$ High to $\overline{\text{WRx}}$ , $\overline{\text{RDx}}$ , $\overline{\text{DMAGx}}$ Low	$0.5t_{\text{CCLK}} - 2 + \text{HI}$		ns
$t_{\text{DADGH}}$	Address/Select Valid to $\overline{\text{DMAGx}}$ High	15.5		ns
$t_{\text{DDGHA}}$	Address/Select Hold after $\overline{\text{DMAGx}}$ High	1		ns

$\text{W} = (\text{number of wait states specified in WAIT register}) \times t_{\text{CK}}$ .

$\text{HI} = t_{\text{CK}}$  (if data bus idle cycle occurs, as specified in WAIT register; otherwise  $\text{HI} = 0$ ).

<sup>1</sup> Only required for recognition in the current cycle.

<sup>2</sup> Maximum throughput using  $\overline{\text{DMARx}}/\overline{\text{DMAGx}}$  handshaking equals  $t_{\text{WDR}} + t_{\text{DMARH}} = (0.5t_{\text{CCLK}} + 1) + (0.5t_{\text{CCLK}} + 1) = 10.0 \text{ ns}$  (100 MHz). This throughput limit applies to non-synchronous access mode only.

<sup>3</sup>  $t_{\text{SDATDGL}}$  is the data setup requirement if  $\overline{\text{DMARx}}$  is not being used to hold off completion of a write. Otherwise, if  $\overline{\text{DMARx}}$  low holds off completion of the write, the data can be driven  $t_{\text{DATDRH}}$  after  $\overline{\text{DMARx}}$  is brought high.

<sup>4</sup> Use  $t_{\text{DMARLL}}$  if  $\overline{\text{DMARx}}$  transitions synchronous with  $\text{CLKIN}$ . Otherwise, use  $t_{\text{WDR}}$  and  $t_{\text{DMARH}}$ .

<sup>5</sup>  $t_{\text{VDATDGH}}$  is valid if  $\overline{\text{DMARx}}$  is not being used to hold off completion of a read. If  $\overline{\text{DMARx}}$  is used to prolong the read, then  $t_{\text{VDATDGH}} = t_{\text{CK}} - .25t_{\text{CCLK}} - 8 + (n \times t_{\text{CK}})$  where  $n$  equals the number of extra cycles that the access is prolonged.

<sup>6</sup> See Example System Hold Time Calculation on Page 41 for calculation of hold times given capacitive and dc loads.

<sup>7</sup> This parameter applies for synchronous access mode only.

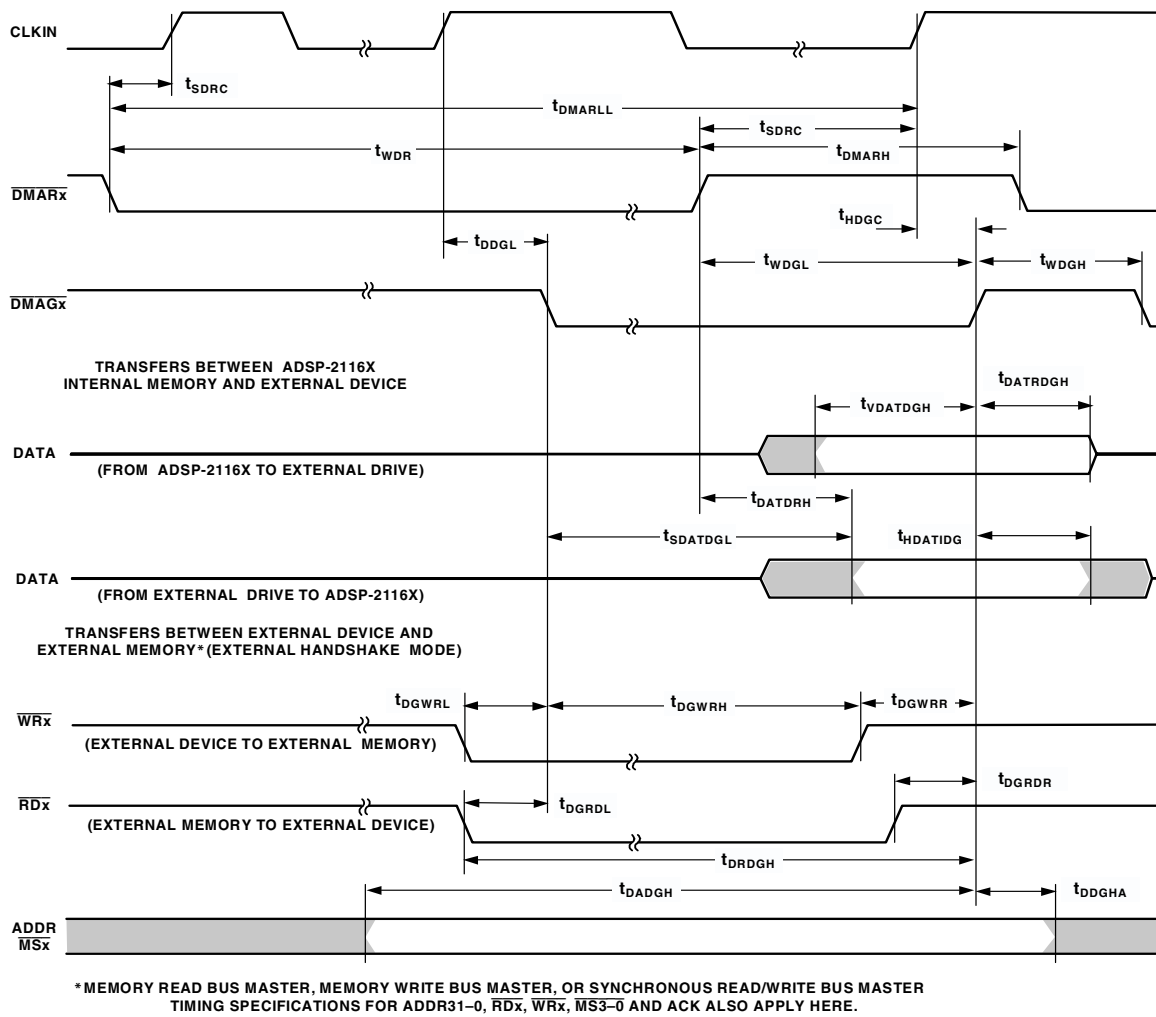

Figure 21. DMA Handshake



# ADSP-21160N

## Link Ports—Receive, Transmit

For Link Ports, see Table 19, Table 20, Figure 22, and Figure 23. Calculation of link receiver data setup and hold, relative to link clock, is required to determine the maximum allowable skew that can be introduced in the transmission path, between LDATA and LCLK. Setup skew is the maximum delay that can be introduced in LDATA, relative to LCLK (setup skew =  $t_{LCLKTWH}$  minimum -  $t_{DLDC}$  -  $t_{SLDCL}$ ). Hold skew is the

maximum delay that can be introduced in LCLK, relative to LDATA (hold skew =  $t_{LCLKTWL}$  minimum +  $t_{HLDCH}$  -  $t_{HLDCL}$ ). Calculations made directly from speed specifications result in unrealistically small skew times, because they include multiple tester guardbands.

Note that there is a two-cycle effect latency between the link port enable instruction and the DSP enabling the link port.

**Table 19. Link Ports—Receive**

Parameter	Min	Max	Unit
<i>Timing Requirements</i>			
$t_{SLDCL}$ Data Setup Before LCLK Low	2.5		ns
$t_{HLDCL}$ Data Hold After LCLK Low	3		ns
$t_{LCLKIW}$ LCLK Period	$t_{LCLK}$		ns
$t_{LCLKRWL}$ LCLK Width Low	4		ns
$t_{LCLKRWH}$ LCLK Width High	4		ns
<i>Switching Characteristics</i>			
$t_{DLALC}$ LACK Low Delay After LCLK High <sup>1</sup>	9	17	ns

<sup>1</sup>LACK goes low with  $t_{DLALC}$  relative to rise of LCLK after first nibble, but does not go low if the receiver's link buffer is not about to fill.

**Table 20. Link Ports—Transmit**

Parameter	Min	Max	Unit
<i>Timing Requirements</i>			
$t_{SLACH}$ LACK Setup Before LCLK High	14		ns
$t_{HLACH}$ LACK Hold After LCLK High	-2		ns
<i>Switching Characteristics</i>			
$t_{DLDC}$ Data Delay After LCLK High		4	ns
$t_{HLDCH}$ Data Hold After LCLK High	-2		ns
$t_{LCLKTWL}$ LCLK Width Low	$0.5t_{LCLK} - .5$	$0.5t_{LCLK} + .5$	ns
$t_{LCLKTWH}$ LCLK Width High	$0.5t_{LCLK} - .5$	$0.5t_{LCLK} + .5$	ns
$t_{DLACLK}$ LCLK Low Delay After LACK High	$0.5t_{LCLK} + 4$	$3/2t_{LCLK} + 11$	ns

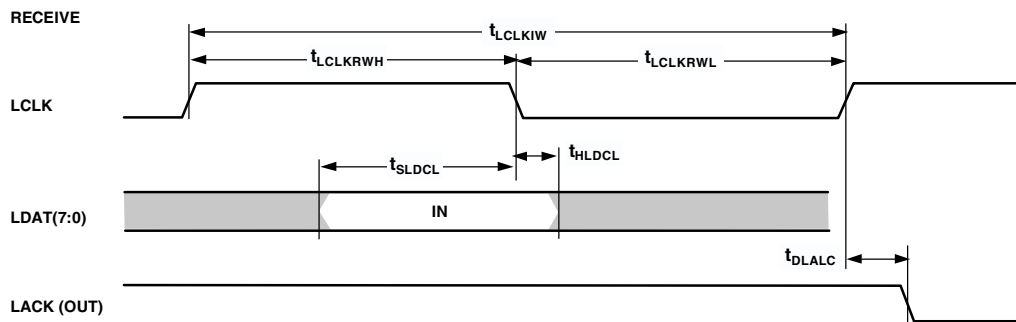

Figure 22. Link Ports—Receive

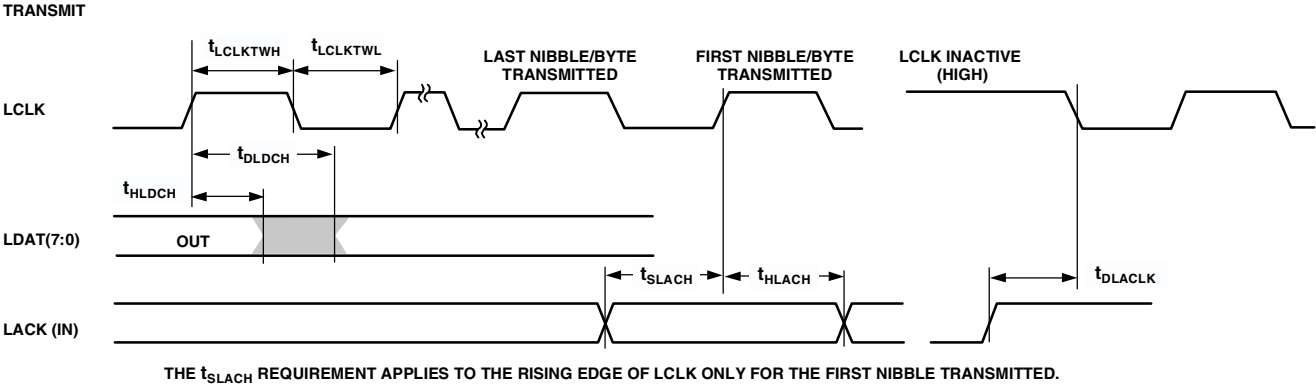

Figure 23. Link Ports—Transmit

# ADSP-21160N

## Serial Ports

For Serial Ports, see [Table 21](#), [Table 22](#), [Table 23](#), [Table 24](#), [Table 25](#), [Table 26](#), [Table 27](#), [Figure 24](#), and [Figure 25](#). To determine whether communication is possible between two

devices at clock speed  $n$ , the following specifications must be confirmed: 1) frame sync delay and frame sync setup and hold, 2) data delay and data setup and hold, and 3) SCLK width.

**Table 21. Serial Ports—External Clock**

Parameter	Min	Max	Unit
<i>Timing Requirements</i>			
$t_{SFSE}$ TFS/RFS Setup Before TCLK/RCLK <sup>1</sup>	3.5		ns
$t_{HFSE}$ TFS/RFS Hold After TCLK/RCLK <sup>1</sup>	4		ns
$t_{SDRE}$ Receive Data Setup Before RCLK <sup>1</sup>	1.5		ns
$t_{HDRE}$ Receive Data Hold After RCLK <sup>1</sup>	6.5		ns
$t_{SCLKW}$ TCLK/RCLK Width	8		ns
$t_{SCLK}$ TCLK/RCLK Period	$2t_{CCLK}$		ns

<sup>1</sup>Referenced to sample edge.

**Table 22. Serial Ports—Internal Clock**

Parameter	Min	Max	Unit
<i>Timing Requirements</i>			
$t_{SFSI}$ TFS Setup Before TCLK <sup>1</sup> ; RFS Setup Before RCLK <sup>1</sup>	8		ns
$t_{HFSI}$ TFS/RFS Hold After TCLK/RCLK <sup>1</sup>	$t_{CCLK}/2 + 1$		ns
$t_{SDRI}$ Receive Data Setup Before RCLK <sup>1</sup>	6.5		ns
$t_{HDRI}$ Receive Data Hold After RCLK <sup>1</sup>	3		ns

<sup>1</sup>Referenced to sample edge.

**Table 23. Serial Ports—External or Internal Clock**

Parameter	Min	Max	Unit
<i>Switching Characteristics</i>			
$t_{DFSE}$ RFS Delay After RCLK (Internally Generated RFS) <sup>1</sup>		13	ns
$t_{HOFSE}$ RFS Hold After RCLK (Internally Generated RFS) <sup>1</sup>	3		ns

<sup>1</sup>Referenced to drive edge.

**Table 24. Serial Ports—External Clock**

Parameter	Min	Max	Unit
<i>Switching Characteristics</i>			
$t_{DFSE}$ TFS Delay After TCLK (Internally Generated TFS) <sup>1</sup>		13	ns
$t_{HOFSE}$ TFS Hold After TCLK (Internally Generated TFS) <sup>1</sup>	3		ns
$t_{DDTE}$ Transmit Data Delay After TCLK <sup>1</sup>		16	ns
$t_{HDTE}$ Transmit Data Hold After TCLK <sup>1</sup>	0		ns

<sup>1</sup>Referenced to drive edge.

**Table 25. Serial Ports—Enable and Three-State**

Parameter	Min	Max	Unit
<i>Switching Characteristics</i>			
$t_{DDTEN}$ Data Enable from External TCLK <sup>1</sup>	4		ns
$t_{DDTTE}$ Data Disable from External TCLK <sup>1</sup>		10	ns
$t_{DDTIN}$ Data Enable from Internal TCLK <sup>1</sup>	0		ns
$t_{DDTTI}$ Data Disable from Internal TCLK <sup>1</sup>		3	ns

<sup>1</sup>Referenced to drive edge.

**Table 26. Serial Ports—Internal Clock**

Parameter	Min	Max	Unit
<i>Switching Characteristics</i>			
$t_{DFSI}$		4.5	ns
$t_{HOFSI}$	-1.5		ns
$t_{DDTI}$		7.5	ns
$t_{HDTI}$	0		ns
$t_{SCLKIW}$	$0.5t_{SCLK} - 1.5$	$0.5t_{SCLK} + 1.5$	ns

<sup>1</sup>Referenced to drive edge.

**Table 27. Serial Ports—External Late Frame Sync**

Parameter	Min	Max	Unit
<i>Switching Characteristics</i>			
$t_{DDTLFSE}$		13	ns
$t_{DDTENFS}$	1.0		ns

<sup>1</sup>MCE = 1, TFS enable and TFS valid follow  $t_{DDTLFSE}$  and  $t_{DDTENFS}$ .

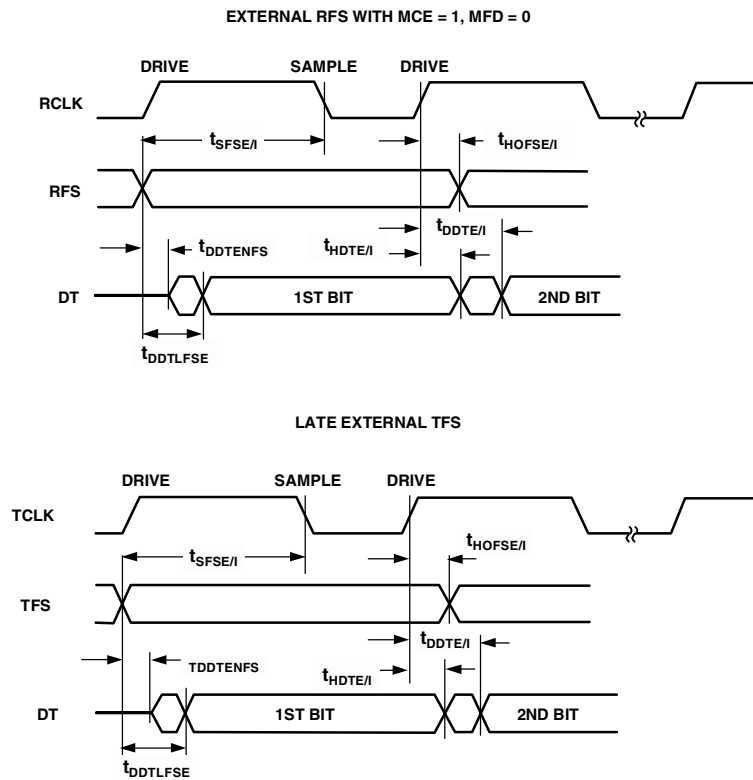
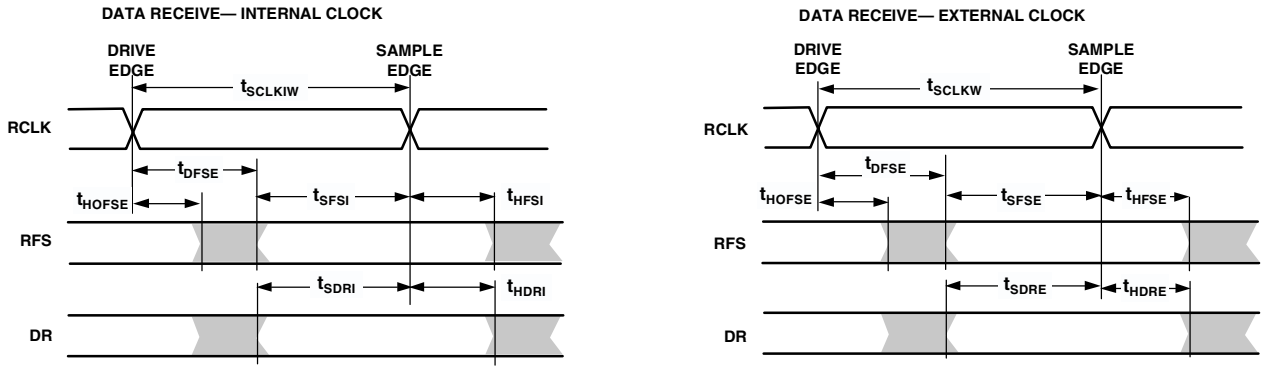
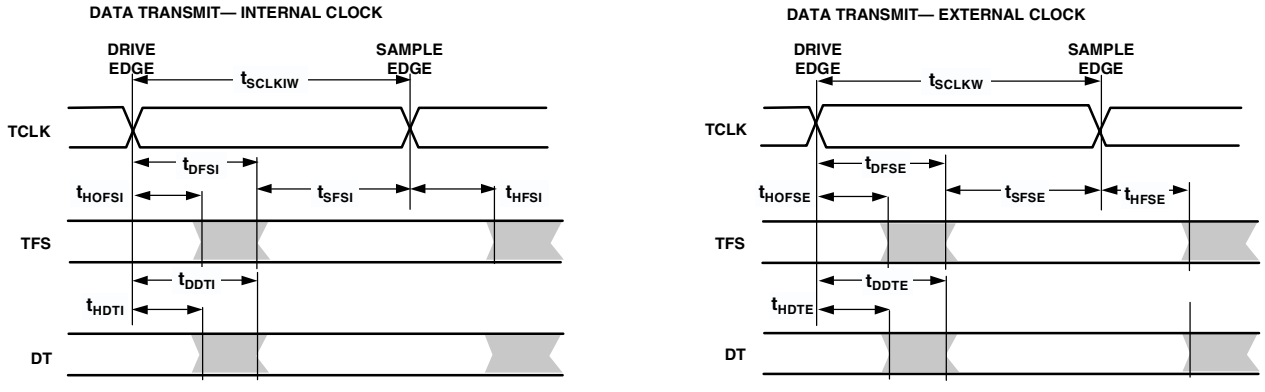

Figure 24. Serial Ports—External Late Frame Sync

# ADSP-21160N



NOTE: EITHER THE RISING EDGE OR FALLING EDGE OF RCLK, TCLK CAN BE USED AS THE ACTIVE SAMPLING EDGE.



NOTE: EITHER THE RISING EDGE OR FALLING EDGE OF RCLK, TCLK CAN BE USED AS THE ACTIVE SAMPLING EDGE.

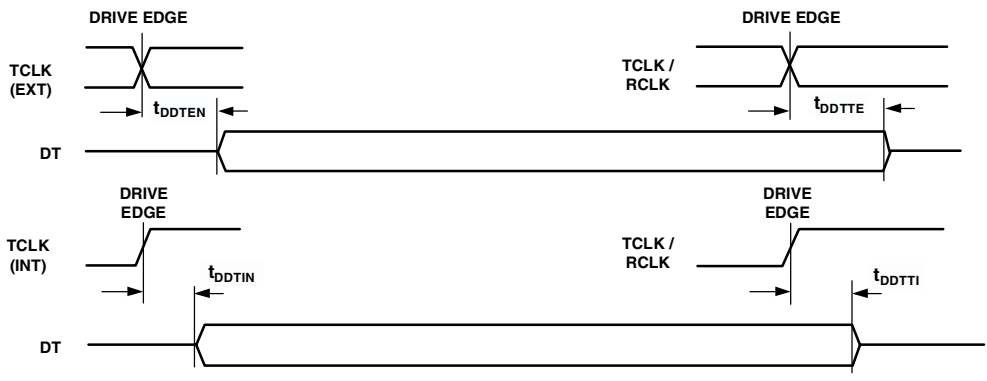

Figure 25. Serial Ports

## JTAG Test Access Port and Emulation

For JTAG Test Access Port and Emulation, see [Table 28](#) and [Figure 26](#).

**Table 28. JTAG Test Access Port and Emulation**

Parameter	Min	Max	Unit
<i>Timing Requirements</i>			
$t_{TCK}$ TCK Period	$t_{CK}$		ns
$t_{STAP}$ TDI, TMS Setup Before TCK High	5		ns
$t_{HTAP}$ TDI, TMS Hold After TCK High	6		ns
$t_{SSYS}$ System Inputs Setup Before TCK Low <sup>1</sup>	7		ns
$t_{HSYS}$ System Inputs Hold After TCK Low <sup>1</sup>	18		ns
$t_{TRSTW}$ $\overline{TRST}$ Pulsewidth	$4t_{CK}$		ns
<i>Switching Characteristics</i>			
$t_{DTDO}$ TDO Delay from TCK Low		13	ns
$t_{DSYS}$ System Outputs Delay After TCK Low <sup>2</sup>		30	ns

<sup>1</sup>System Inputs = DATA63-0, ADDR31-0,  $\overline{RDx}$ ,  $\overline{WRx}$ , ACK,  $\overline{SBTS}$ ,  $\overline{HBR}$ ,  $\overline{HBG}$ , CS, DMAR1, DMAR2,  $\overline{BR6-1}$ , ID2-0, RPBA,  $\overline{IRQ2-0}$ , FLAG3-0,  $\overline{PA}$ , BRST, DR0, DR1, TCLK0, TCLK1, RCLK0, RCLK1, TFS0, TFS1, RFS0, RFS1, LxDAT7-0, LxCLK, LxACK, EBOOT, LBOOT,  $\overline{BMS}$ , CLKIN,  $\overline{RESET}$ .

<sup>2</sup>System Outputs = DATA63-0, ADDR31-0,  $\overline{MS3-0}$ ,  $\overline{RDx}$ ,  $\overline{WRx}$ , ACK, PAGE, CLKOUT,  $\overline{HBG}$ , REDY,  $\overline{DMAG1}$ ,  $\overline{DMAG2}$ ,  $\overline{BR6-1}$ ,  $\overline{PA}$ , BRST,  $\overline{CIF}$ , FLAG3-0, TIMEXP, DT0, DT1, TCLK0, TCLK1, RCLK0, RCLK1, TFS0, TFS1, RFS0, RFS1, LxDAT7-0, LxCLK, LxACK,  $\overline{BMS}$ .

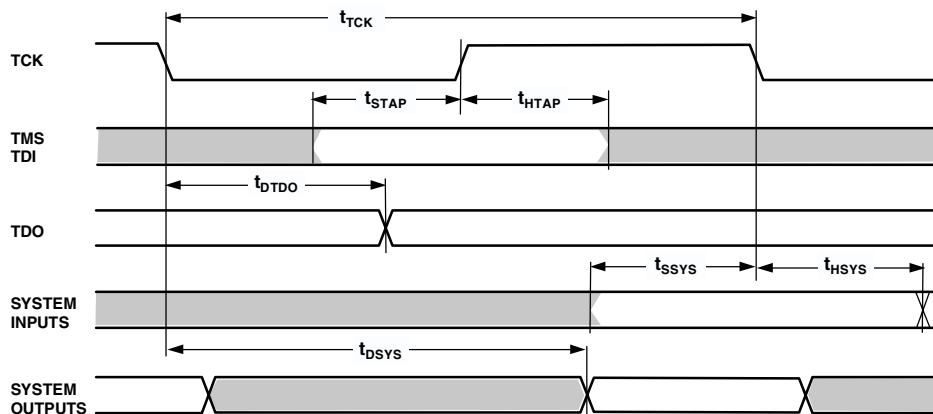

Figure 26. JTAG Test Access Port and Emulation

# ADSP-21160N

## Output Drive Currents

Figure 27 shows typical I–V characteristics for the output drivers of the ADSP-21160N. The curves represent the current drive capability of the output drivers as a function of output voltage.

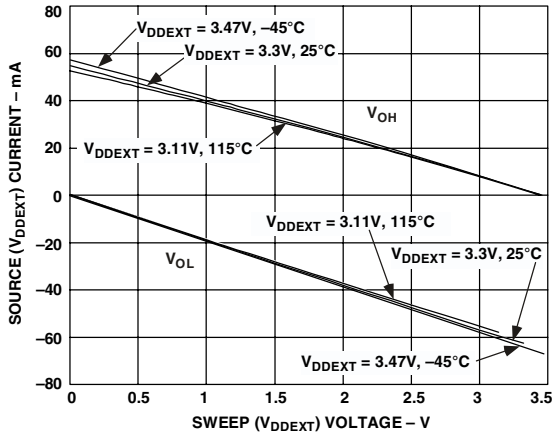

Figure 27. Typical Drive Currents

## Power Dissipation

Total power dissipation has two components, one due to internal circuitry and one due to the switching of external output drivers.

Internal power dissipation is dependent on the instruction execution sequence and the data operands involved. Using the current specifications ( $I_{DD-INPEAK}$ ,  $I_{DD-INHIGH}$ ,  $I_{DD-INLOW}$ ,  $I_{DD-IDLE}$ ) from Electrical Characteristics on Page 14 and the current-versus-operation information in Table 29, engineers can estimate the ADSP-21160N’s internal power supply ( $V_{DDINT}$ ) input current for a specific application, according to the formula.

$$\begin{aligned} & \% \text{ Peak} \times I_{DD-INPEAK} \\ & \% \text{ High} \times I_{DD-INHIGH} \\ & \% \text{ Low} \times I_{DD-INLOW} \\ & + \% \text{ Idle} \times I_{DD-IDLE} \\ & \hline & I_{DDINT} \end{aligned}$$

The external component of total power dissipation is caused by the switching of output pins. Its magnitude depends on:

- the number of output pins that switch during each cycle ( $O$ )
- the maximum frequency at which they can switch ( $f$ )
- their load capacitance ( $C$ )
- their voltage swing ( $V_{DD}$ )

and is calculated by:

$$P_{EXT} = O \times C \times V_{DD}^2 \times f$$

The load capacitance should include the processor’s package capacitance ( $C_{IN}$ ). The switching frequency includes driving the load high and then back low. Address and data pins can drive high and low at a maximum rate of  $1/(2t_{CK})$ . The write strobe can switch every cycle at a frequency of  $1/t_{CK}$ . Select pins switch at  $1/(2t_{CK})$ , but selects can switch on each cycle.

**Example:** Estimate  $P_{EXT}$  with the following assumptions:

- A system with one bank of external data memory—asynchronous RAM (64-bit)
- Four 64K × 16 RAM chips are used, each with a load of 10 pF
- External data memory writes occur every other cycle, a rate of  $1/(2 t_{CK})$ , with 50% of the pins switching
- The bus cycle time is 50 MHz ( $t_{CK} = 20$  ns).

The  $P_{EXT}$  equation is calculated for each class of pins that can drive, as shown in Table 30.

A typical power consumption can now be calculated for these conditions by adding a typical internal power dissipation:

$$P_{TOTAL} = P_{EXT} + P_{INT} + P_{PLL}$$

Table 29. ADSP-21160N Operation Types vs. Input Current

Operation	Peak Activity <sup>1</sup>	High Activity <sup>1</sup>	Low Activity <sup>1</sup>
Instruction Type	Multifunction	Multifunction	Single Function
Instruction Fetch	Cache	Internal Memory	Internal Memory
Core Memory Access <sup>2</sup>	2 per $t_{CK}$ Cycle (DM × 64 and PM × 64)	1 per $t_{CK}$ Cycle (DM × 64)	None
Internal Memory DMA	1 per 2 $t_{CCLK}$ Cycles	1 per 2 $t_{CCLK}$ Cycles	None
External Memory DMA	1 per External Port Cycle (× 64)	1 per External Port Cycle (× 64)	None
Data Bit Pattern for Core Memory Access and DMA	Worst Case	Random	N/A

<sup>1</sup> Peak Activity =  $I_{DD-INPEAK}$ , High Activity =  $I_{DD-INHIGH}$ , and Low Activity =  $I_{DD-INLOW}$ . The state of the PEYEN bit (SIMD versus SISD mode) does not influence these calculations.

<sup>2</sup> These assume a 2:1 core clock ratio. For more information on ratios and clocks ( $t_{CK}$  and  $t_{CCLK}$ ), see the timing ratio definitions on Page 16.



where:

- $P_{EXT}$  is from [Table 30](#)
- $P_{INT}$  is  $I_{DDINT} \times 1.9$  V, using the calculation  $I_{DDINT}$  listed in Power Dissipation [on Page 40](#)
- $P_{PLL}$  is  $AI_{DD} \times 1.9$  V, using the value for  $AI_{DD}$  listed in ABSOLUTE MAXIMUM RATINGS [on Page 15](#)

Note that the conditions causing a worst-case  $P_{EXT}$  are different from those causing a worst-case  $P_{INT}$ . Maximum  $P_{INT}$  cannot occur while 100% of the output pins are switching from all ones to all zeros. Note also that it is not common for an application to have 100% or even 50% of the outputs switching simultaneously.

**Table 30. External Power Calculations (3.3 V Device)**

Pin Type	No. of Pins	% Switching	$\times C$	$\times f$	$\times V_{DD}^2$	= $P_{EXT}$
Address	15	50	$\times 44.7$ pF	$\times 24$ MHz	$\times 10.9$ V	= 0.088 W
MS0	1	0	$\times 44.7$ pF	$\times 24$ MHz	$\times 10.9$ V	= 0.000 W
WRx	2		$\times 44.7$ pF	$\times 24$ MHz	$\times 10.9$ V	= 0.023 W
Data	64	50	$\times 14.7$ pF	$\times 24$ MHz	$\times 10.9$ V	= 0.123 W
CLKOUT	1		$\times 4.7$ pF	$\times 48$ MHz	$\times 10.9$ V	= 0.003 W
$P_{EXT} = 0.237$ W						

### Test Conditions

The test conditions for timing parameters appearing in ADSP-21160N specifications [on Page 14](#) include output disable time, output enable time, and capacitive loading.

#### Output Disable Time

Output pins are considered to be disabled when they stop driving, go into a high impedance state, and start to decay from their output high or low voltage. The time for the voltage on the bus to decay by  $\Delta V$  is dependent on the capacitive load,  $C_L$  and the load current,  $I_L$ . This decay time can be approximated by the following equation:

$$t_{DECAY} = (C_L \Delta V) / I_L$$

The output disable time  $t_{DIS}$  is the difference between  $t_{MEASURED}$  and  $t_{DECAY}$  as shown in [Figure 28](#). The time  $t_{MEASURED}$  is the interval from when the reference signal switches to when the output voltage decays  $\Delta V$  from the measured output high or output low voltage.  $t_{DECAY}$  is calculated with test loads  $C_L$  and  $I_L$ , and with  $\Delta V$  equal to 0.5 V.

#### Output Enable Time

Output pins are considered to be enabled when they have made a transition from a high impedance state to when they start driving. The output enable time  $t_{ENA}$  is the interval from when a reference signal reaches a high or low voltage level to when the output has reached a specified high or low trip point, as shown in the Output Enable/Disable diagram ([Figure 28](#)). If multiple pins (such as the data bus) are enabled, the measurement value is that of the first pin to start driving.

#### Example System Hold Time Calculation

To determine the data output hold time in a particular system, first calculate  $t_{DECAY}$  using the equation given above. Choose  $\Delta V$  to be the difference between the ADSP-21160N's output voltage and the input threshold for the device requiring the hold time. A typical  $\Delta V$  will be 0.4 V.  $C_L$  is the total bus capacitance (per data line), and  $I_L$  is the total leakage or three-state current (per data line). The hold time will be  $t_{DECAY}$  plus the minimum disable time (i.e.,  $t_{DATRWH}$  for the write cycle).

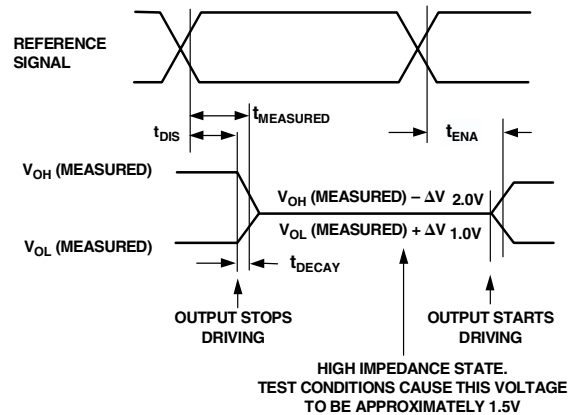

*Figure 28. Output Enable/Disable*

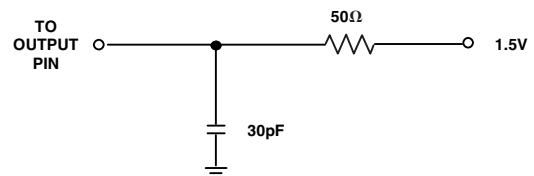

*Figure 29. Equivalent Device Loading for AC Measurements (Includes All Fixtures)*



*Figure 30. Voltage Reference Levels for AC Measurements (Except Output Enable/Disable)*

# ADSP-21160N

## Capacitive Loading

Output delays and holds are based on standard capacitive loads: 30 pF on all pins (see Figure 29). Figure 31 and Figure 32 show how output rise time varies with capacitance. Figure 33 graphically shows how output delays and holds vary with load capacitance. (Note that this graph or derating does not apply to output disable delays; see Output Disable Time on Page 41.) The graphs of Figure 31, Figure 32, and Figure 33 may not be linear outside the ranges shown.

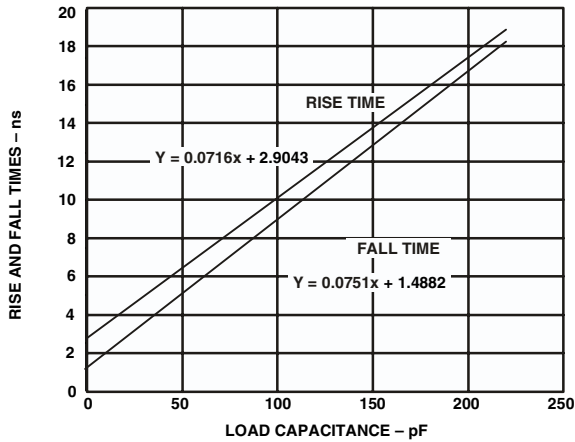

Figure 31. Typical Output Rise Time (20%–80%,  $V_{DDEXT} = \text{Max}$ ) vs. Load Capacitance

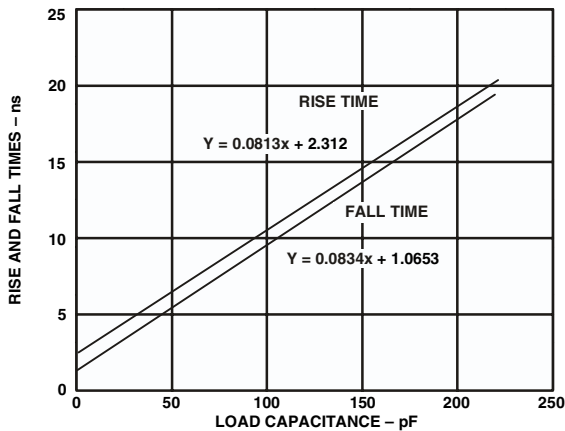

Figure 32. Typical Output Rise Time (20%–80%,  $V_{DDEXT} = \text{Min}$ ) vs. Load Capacitance

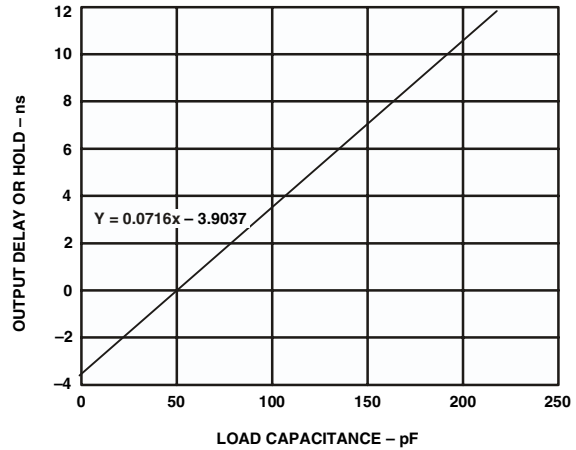

Figure 33. Typical Output Delay or Hold vs. Load Capacitance (at Max Case Temperature)

## Environmental Conditions

The ADSP-21160NKB-100 and ADSP-21160NCB-100 are provided in a 400-Ball Metric PBGA (Plastic Ball Grid Array) package.

## Thermal Characteristics

The ADSP-21160N is specified for a case temperature ( $T_{CASE}$ ). To ensure that the  $T_{CASE}$  data sheet specification is not exceeded, a heatsink and/or an air flow source may be used. Use the centerblock of ground pins (PBGA balls: F7-14, G7-14, H7-14, J7-14, K7-14, L7-14, M-14, N7-14, P7-14, R7-15) to provide thermal pathways to the printed circuit board's ground plane. A heatsink should be attached to the ground plane (as close as possible to the thermal pathways) with a thermal adhesive.

$$T_{CASE} = T_{AMB} + (PD \times \theta_{CA})$$

- $T_{CASE}$  = Case temperature (measured on top surface of package)
- $PD$  = Power dissipation in W (this value depends upon the specific application; a method for calculating  $PD$  is shown under Power Dissipation).
- $\theta_{CA}$  = Value from Table 31.
- $\theta_{JB} = 6.46^\circ\text{C/W}$

Table 31. Airflow Over Package Versus  $\theta_{CA}$

Airflow (Linear Ft./Min.)	0	200	400
$\theta_{CA}$ ( $^\circ\text{C/W}$ ) <sup>1</sup>	12.13	9.86	8.7

<sup>1</sup> $\theta_{JC} = 3.6^\circ\text{C/W}$ .

## 400-BALL METRIC PBGA PIN CONFIGURATIONS

Table 32 lists the pin assignments for the PBGA package, and the pin configurations diagram in Figure 34 shows the pin assignment summary.

**Table 32. 400-Ball Metric PBGA Pin Assignments**

Pin Name	Pin No.	Pin Name	Pin No.	Pin Name	Pin No.	Pin Name	Pin No.
DATA[14]	A01	DATA[22]	B01	DATA[24]	C01	DATA[28]	D01
DATA[13]	A02	DATA[16]	B02	DATA[18]	C02	DATA[25]	D02
DATA[10]	A03	DATA[15]	B03	DATA[17]	C03	DATA[20]	D03
DATA[8]	A04	DATA[9]	B04	DATA[11]	C04	DATA[19]	D04
DATA[4]	A05	DATA[6]	B05	DATA[7]	C05	DATA[12]	D05
DATA[2]	A06	DATA[3]	B06	DATA[5]	C06	V <sub>DDEXT</sub>	D06
TDI	A07	DATA[0]	B07	DATA[1]	C07	V <sub>DDINT</sub>	D07
$\overline{\text{TRST}}$	A08	TCK	B08	TMS	C08	V <sub>DDEXT</sub>	D08
$\overline{\text{RESET}}$	A09	$\overline{\text{EMU}}$	B09	TD0	C09	V <sub>DDEXT</sub>	D09
RPBA	A10	$\overline{\text{IRQ2}}$	B10	$\overline{\text{IRQ1}}$	C10	V <sub>DDEXT</sub>	D10
$\overline{\text{IRQ0}}$	A11	FLAG3	B11	FLAG2	C11	V <sub>DDEXT</sub>	D11
FLAG1	A12	FLAG0	B12	NC	C12	V <sub>DDEXT</sub>	D12
TIMEXP	A13	NC	B13	NC	C13	V <sub>DDINT</sub>	D13
NC	A14	NC	B14	TCLK1	C14	V <sub>DDEXT</sub>	D14
NC	A15	DT1	B15	DR1	C15	TFS0	D15
TFS1	A16	RCLK1	B16	DR0	C16	L1DAT[7]	D16
RFS1	A17	RFS0	B17	L0DAT[7]	C17	L0CLK	D17
RCLK0	A18	TCLK0	B18	L0DAT[6]	C18	L0DAT[3]	D18
DT0	A19	L0DAT[5]	B19	L0ACK	C19	L0DAT[1]	D19
L0DAT[4]	A20	L0DAT[2]	B20	L0DAT[0]	C20	L1CLK	D20
DATA[30]	E01	DATA[34]	F01	DATA[38]	G01	DATA[40]	H01
DATA[29]	E02	DATA[33]	F02	DATA[35]	G02	DATA[39]	H02
DATA[23]	E03	DATA[27]	F03	DATA[32]	G03	DATA[37]	H03
DATA[21]	E04	DATA[26]	F04	DATA[31]	G04	DATA[36]	H04
V <sub>DDEXT</sub>	E05	V <sub>DDEXT</sub>	F05	V <sub>DDEXT</sub>	G05	V <sub>DDEXT</sub>	H05
V <sub>DDINT</sub>	E06	V <sub>DDINT</sub>	F06	V <sub>DDINT</sub>	G06	V <sub>DDINT</sub>	H06
V <sub>DDINT</sub>	E07	GND	F07	GND	G07	GND	H07
V <sub>DDINT</sub>	E08	GND	F08	GND	G08	GND	H08
V <sub>DDINT</sub>	E09	GND	F09	GND	G09	GND	H09
V <sub>DDINT</sub>	E10	GND	F10	GND	G10	GND	H10
GND	E11	GND	F11	GND	G11	GND	H11
V <sub>DDINT</sub>	E12	GND	F12	GND	G12	GND	H12
V <sub>DDINT</sub>	E13	GND	F13	GND	G13	GND	H13
V <sub>DDINT</sub>	E14	GND	F14	GND	G14	GND	H14
V <sub>DDINT</sub>	E15	V <sub>DDINT</sub>	F15	V <sub>DDINT</sub>	G15	V <sub>DDINT</sub>	H15
V <sub>DDEXT</sub>	E16	V <sub>DDEXT</sub>	F16	V <sub>DDEXT</sub>	G16	V <sub>DDEXT</sub>	H16
L1DAT[6]	E17	L1DAT[4]	F17	L1DAT[2]	G17	L2DAT[5]	H17
L1DAT[5]	E18	L1DAT[3]	F18	L2DAT[6]	G18	L2ACK	H18
L1ACK	E19	L1DAT[0]	F19	L2DAT[4]	G19	L2DAT[3]	H19
L1DAT[1]	E20	L2DAT[7]	F20	L2CLK	G20	L2DAT[1]	H20
DATA[44]	J01	CLK_CFG_0	K01	CLKIN	L01	AV <sub>DD</sub>	M01
DATA[43]	J02	DATA[46]	K02	CLK_CFG_1	L02	CLK_CFG_3	M02
DATA[42]	J03	DATA[45]	K03	AGND	L03	CLKOUT	M03
DATA[41]	J04	DATA[47]	K04	CLK_CFG_2	L04	NC	M04
V <sub>DDEXT</sub>	J05	V <sub>DDEXT</sub>	K05	V <sub>DDEXT</sub>	L05	V <sub>DDEXT</sub>	M05
V <sub>DDINT</sub>	J06	V <sub>DDINT</sub>	K06	V <sub>DDINT</sub>	L06	V <sub>DDINT</sub>	M06

# ADSP-21160N

Table 32. 400-Ball Metric PBGA Pin Assignments (continued)

Pin Name	Pin No.	Pin Name	Pin No.	Pin Name	Pin No.	Pin Name	Pin No.
GND	J07	GND	K07	GND	L07	GND	M07
GND	J08	GND	K08	GND	L08	GND	M08
GND	J09	GND	K09	GND	L09	GND	M09
GND	J10	GND	K10	GND	L10	GND	M10
GND	J11	GND	K11	GND	L11	GND	M11
GND	J12	GND	K12	GND	L12	GND	M12
GND	J13	GND	K13	GND	L13	GND	M13
GND	J14	GND	K14	GND	L14	GND	M14
V <sub>DDINT</sub>	J15	V <sub>DDINT</sub>	K15	V <sub>DDINT</sub>	L15	V <sub>DDINT</sub>	M15
V <sub>DDEXT</sub>	J16	V <sub>DDEXT</sub>	K16	V <sub>DDEXT</sub>	L16	V <sub>DDEXT</sub>	M16
L2DAT[2]	J17	$\overline{\text{BR}}_6$	K17	$\overline{\text{BR}}_2$	L17	PAGE	M17
L2DAT[0]	J18	$\overline{\text{BR}}_5$	K18	$\overline{\text{BR}}_1$	L18	$\overline{\text{SBT}}_S$	M18
$\overline{\text{HBG}}$	J19	$\overline{\text{BR}}_4$	K19	ACK	L19	$\overline{\text{PA}}$	M19
$\overline{\text{HBR}}$	J20	$\overline{\text{BR}}_3$	K20	REDY	L20	L3DAT[7]	M20
NC	N01	DATA[49]	P01	DATA[53]	R01	DATA[56]	T01
NC	N02	DATA[50]	P02	DATA[54]	R02	DATA[58]	T02
DATA[48]	N03	DATA[52]	P03	DATA[57]	R03	DATA[59]	T03
DATA[51]	N04	DATA[55]	P04	DATA[60]	R04	DATA[63]	T04
V <sub>DDEXT</sub>	N05	V <sub>DDEXT</sub>	P05	V <sub>DDEXT</sub>	R05	V <sub>DDEXT</sub>	T05
V <sub>DDINT</sub>	N06	V <sub>DDINT</sub>	P06	V <sub>DDINT</sub>	R06	V <sub>DDINT</sub>	T06
GND	N07	GND	P07	GND	R07	V <sub>DDINT</sub>	T07
GND	N08	GND	P08	GND	R08	V <sub>DDINT</sub>	T08
GND	N09	GND	P09	GND	R09	V <sub>DDINT</sub>	T09
GND	N10	GND	P10	GND	R10	V <sub>DDINT</sub>	T10
GND	N11	GND	P11	GND	R11	V <sub>DDINT</sub>	T11
GND	N12	GND	P12	GND	R12	V <sub>DDINT</sub>	T12
GND	N13	GND	P13	GND	R13	V <sub>DDINT</sub>	T13
GND	N14	GND	P14	GND	R14	V <sub>DDINT</sub>	T14
V <sub>DDINT</sub>	N15	V <sub>DDINT</sub>	P15	GND	R15	V <sub>DDINT</sub>	T15
V <sub>DDEXT</sub>	N16	V <sub>DDEXT</sub>	P16	V <sub>DDEXT</sub>	R16	V <sub>DDEXT</sub>	T16
L3DAT[5]	N17	L3DAT[2]	P17	L4DAT[5]	R17	L4DAT[3]	T17
L3DAT[6]	N18	L3DAT[1]	P18	L4DAT[6]	R18	L4ACK	T18
L3DAT[4]	N19	L3DAT[3]	P19	L4DAT[7]	R19	L4CLK	T19
L3CLK	N20	L3ACK	P20	L3DAT[0]	R20	L4DAT[4]	T20
DATA[61]	U01	ADDR[4]	V01	ADDR[5]	W01	ADDR[8]	Y01
DATA[62]	U02	ADDR[6]	V02	ADDR[9]	W02	ADDR[11]	Y02
ADDR[3]	U03	ADDR[7]	V03	ADDR[12]	W03	ADDR[13]	Y03
ADDR[2]	U04	ADDR[10]	V04	ADDR[15]	W04	ADDR[16]	Y04
V <sub>DDEXT</sub>	U05	ADDR[14]	V05	ADDR[17]	W05	ADDR[19]	Y05
V <sub>DDEXT</sub>	U06	ADDR[18]	V06	ADDR[20]	W06	ADDR[21]	Y06
V <sub>DDEXT</sub>	U07	ADDR[22]	V07	ADDR[23]	W07	ADDR[24]	Y07
V <sub>DDEXT</sub>	U08	ADDR[25]	V08	ADDR[26]	W08	ADDR[27]	Y08
V <sub>DDEXT</sub>	U09	ADDR[28]	V09	ADDR[29]	W09	ADDR[30]	Y09
V <sub>DDEXT</sub>	U10	ID0	V10	ID1	W10	ADDR[31]	Y10
V <sub>DDEXT</sub>	U11	ADDR[1]	V11	ADDR[0]	W11	ID2	Y11
V <sub>DDEXT</sub>	U12	$\overline{\text{MS}}_1$	V12	$\overline{\text{BMS}}$	W12	$\overline{\text{BR}}_{\text{ST}}$	Y12
V <sub>DDEXT</sub>	U13	$\overline{\text{CS}}$	V13	$\overline{\text{MS}}_2$	W13	$\overline{\text{MS}}_0$	Y13
V <sub>DDEXT</sub>	U14	$\overline{\text{RDL}}$	V14	$\overline{\text{CIF}}$	W14	$\overline{\text{MS}}_3$	Y14
V <sub>DDEXT</sub>	U15	$\overline{\text{DMAR}}_2$	V15	$\overline{\text{RDH}}$	W15	$\overline{\text{WRH}}$	Y15
V <sub>DDEXT</sub>	U16	L5DAT[0]	V16	$\overline{\text{DMAG}}_2$	W16	$\overline{\text{WRL}}$	Y16
L5DAT[7]	U17	L5DAT[2]	V17	LBOOT	W17	$\overline{\text{DMAG}}_1$	Y17

**Table 32. 400-Ball Metric PBGA Pin Assignments (continued)**

Pin Name	Pin No.	Pin Name	Pin No.	Pin Name	Pin No.	Pin Name	Pin No.
L4DAT[0]	U18	L5ACK	V18	L5DAT[1]	W18	$\overline{\text{DMARI}}$	Y18
L4DAT[1]	U19	L5DAT[4]	V19	L5DAT[3]	W19	EBOOT	Y19
L4DAT[2]	U20	L5DAT[6]	V20	L5DAT[5]	W20	L5CLK	Y20

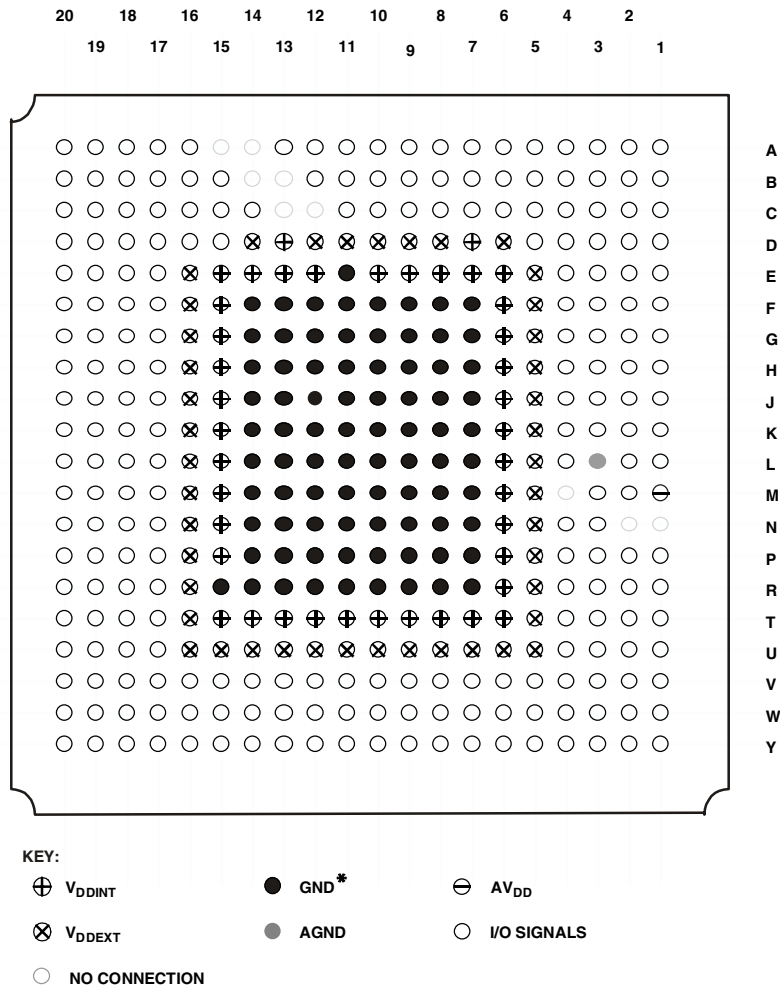

**\* USE THE CENTER BLOCK OF GROUND PINS (PBGA BALLS: F7-14, G7-14, H7-14, J7-14, K7-14, L7-14, M7-14, N7-14, P7-14, R7-15) TO PROVIDE THERMAL PATHWAYS TO YOUR PRINTED CIRCUIT BOARD'S GROUND PLANE.**

*Figure 34. 400-Ball Metric PBGA Pin Configurations (Bottom View, Summary)*

# ADSP-21160N

## OUTLINE DIMENSIONS

The ADSP-21160N comes in a 27 mm × 27 mm, 400-ball Metric PBGA package with 20 rows of balls.

### 400-Ball Metric PBGA (B-400)

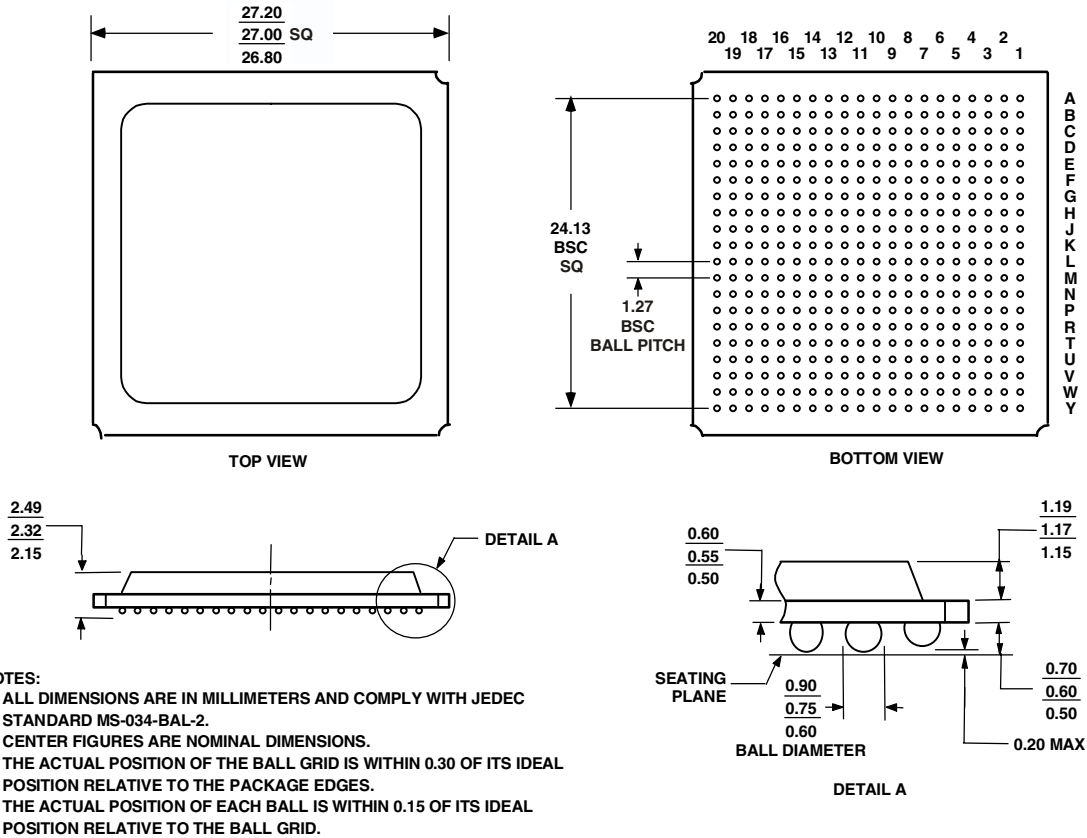

## ORDERING GUIDE

Part Number <sup>1</sup>	Case Temperature Range	Instruction Rate	On-Chip SRAM	Operating Voltage
ADSP-21160NCB-100	-40°C to 100°C	100 MHz	4M bits	1.9 INT/3.3 EXT V
ADSP-21160NKB-100	0°C to 85°C	100 MHz	4M bits	1.9 INT/3.3 EXT V

<sup>1</sup>B = Plastic Ball Grid Array (PBGA) package.







Компания «Океан Электроники» предлагает заключение долгосрочных отношений при поставках импортных электронных компонентов на взаимовыгодных условиях!

Наши преимущества:

- Поставка оригинальных импортных электронных компонентов напрямую с производств Америки, Европы и Азии, а так же с крупнейших складов мира;
- Широкая линейка поставок активных и пассивных импортных электронных компонентов (более 30 млн. наименований);
- Поставка сложных, дефицитных, либо снятых с производства позиций;
- Оперативные сроки поставки под заказ (от 5 рабочих дней);
- Экспресс доставка в любую точку России;
- Помощь Конструкторского Отдела и консультации квалифицированных инженеров;
- Техническая поддержка проекта, помощь в подборе аналогов, поставка прототипов;
- Поставка электронных компонентов под контролем ВП;
- Система менеджмента качества сертифицирована по Международному стандарту ISO 9001;
- При необходимости вся продукция военного и аэрокосмического назначения проходит испытания и сертификацию в лаборатории (по согласованию с заказчиком);
- Поставка специализированных компонентов военного и аэрокосмического уровня качества (Xilinx, Altera, Analog Devices, Intersil, Interpoint, Microsemi, Actel, Aeroflex, Peregrine, VPT, Syfer, Eurofarad, Texas Instruments, MS Kennedy, Miteq, Cobham, E2V, MA-COM, Hittite, Mini-Circuits, General Dynamics и др.);

Компания «Океан Электроники» является официальным дистрибьютором и эксклюзивным представителем в России одного из крупнейших производителей разъемов военного и аэрокосмического назначения «JONHON», а так же официальным дистрибьютором и эксклюзивным представителем в России производителя высокотехнологичных и надежных решений для передачи СВЧ сигналов «FORSTAR».



## JONHON

«JONHON» (основан в 1970 г.)

Разъемы специального, военного и аэрокосмического назначения:

(Применяются в военной, авиационной, аэрокосмической, морской, железнодорожной, горно- и нефтедобывающей отраслях промышленности)

«FORSTAR» (основан в 1998 г.)

ВЧ соединители, коаксиальные кабели, кабельные сборки и микроволновые компоненты:

(Применяются в телекоммуникациях гражданского и специального назначения, в средствах связи, РЛС, а так же военной, авиационной и аэрокосмической отраслях промышленности).



Телефон: 8 (812) 309-75-97 (многоканальный)

Факс: 8 (812) 320-03-32

Электронная почта: [ocean@oceanchips.ru](mailto:ocean@oceanchips.ru)

Web: <http://oceanchips.ru/>

Адрес: 198099, г. Санкт-Петербург, ул. Калинина, д. 2, корп. 4, лит. А