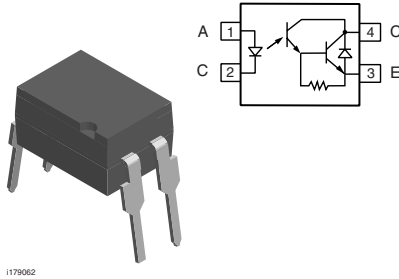

## Optocoupler, Photodarlington Output, High Gain, 300 $V_{CEO}$

**FEATURES**

- High collector emitter voltage,  $V_{CEO} = 300\text{ V}$
- High isolation test voltage:  $5300\text{ V}_{RMS}$
- Standard plastic DIP-4 package
- Compatible with Toshiba TLP627
- Lead (Pb)-free component
- Component in accordance to RoHS 2002/95/EC and WEEE 2002/96/EC

**RoHS  
COMPLIANT**
**DESCRIPTION**

The SFH619A is optically coupled isolators with a gallium arsenide infrared LED and a silicon photodarlington sensor. Switching can be achieved while maintaining a high degree of isolation between driving and load circuits. These optocouplers can be used to replace reed and mercury relays with advantages of long life, high speed switching and elimination of magnetic fields.

**AGENCY APPROVALS**

- UL - file no. E52744 system code H or J
- DIN EN 60747-5-2 (VDE 0884)/DIN EN 60747-5-5 pending available with option 1
- BSI IEC 60950; IEC 60065
- FIMKO

**ORDER INFORMATION**

| PART         | REMARKS                        |
|--------------|--------------------------------|
| SFH619A      | CTR > 1000 %, DIP-4            |
| SFH619A-X007 | CTR > 1000 %, SMD-4 (option 7) |
| SFH619A-X009 | CTR > 1000 %, SMD-4 (option 9) |

**Note**

For additional information on the available options refer to option information.

**ABSOLUTE MAXIMUM RATINGS (1)**

| PARAMETER   | TEST CONDITION     | SYMBOL     | VALUE | UNIT      |
|---|--------------------|------------|-------|-----------|
| <b>INPUT</b>  |                    |            |       |           |
| Peak reverse voltage  |                    | $V_{RM}$   | 6.0   | V         |
| Forward continuous current  |                    | $I_F$      | 60    | mA        |
| Derate linearly from 25 °C  |                    |            | 1.33  | mW/°C     |
| Power dissipation   |                    | $P_{diss}$ | 100   | mW        |
| <b>OUTPUT</b>   |                    |            |       |           |
| Collector emitter breakdown voltage   |                    | $V_{CEO}$  | 300   | V         |
| Emitter collector breakdown voltage   |                    | $V_{ECO}$  | 0.3   | V         |
| Collector (load) current  |                    | $I_C$      | 125   | mA        |
| Derate linearly from 25 °C  |                    |            | 2.0   | mW/°C     |
| Power dissipation   |                    | $P_{diss}$ | 150   | mW        |
| <b>COUPLER</b>  |                    |            |       |           |
| Derate linearly from 25 °C  |                    |            | 3.33  | mW/°C     |
| Total power dissipation   |                    | $P_{tot}$  | 250   | mW        |
| Isolation test voltage between emitter and detector, standard climate: 23 °C/50 % RH, DIN 50014 | $t = 1.0\text{ s}$ | $V_{ISO}$  | 5300  | $V_{RMS}$ |

| ABSOLUTE MAXIMUM RATINGS (1) |  |                   |                    |      |
|------------------------------|--|-------------------|--------------------|------|
| PARAMETER                    | TEST CONDITION   | SYMBOL            | VALUE              | UNIT |
| <b>COUPLER</b>               |  |                   |                    |      |
| Isolation resistance         | V <sub>IO</sub> = 500 V, T <sub>amb</sub> = 25 °C            | R <sub>IO</sub>   | ≥ 10 <sup>12</sup> | Ω    |
|                              | V <sub>IO</sub> = 500 V, T <sub>amb</sub> = 100 °C           | R <sub>IO</sub>   | ≥ 10 <sup>11</sup> | Ω    |
| Storage temperature          |  | T <sub>stg</sub>  | - 55 to + 150      | °C   |
| Operating temperature        |  | T <sub>amb</sub>  | - 55 to + 100      | °C   |
| Soldering temperature (2)    | max. 10 s, dip soldering: distance to seating plane ≥ 1.5 mm | T <sub>slid</sub> | 260                | °C   |

**Notes**(1) T<sub>amb</sub> = 25 °C, unless otherwise specified.

Stresses in excess of the absolute maximum ratings can cause permanent damage to the device. Functional operation of the device is not implied at these or any other conditions in excess of those given in the operational sections of this document. Exposure to absolute maximum ratings for extended periods of the time can adversely affect reliability.

(2) Refer to reflow profile for soldering conditions for surface mounted devices (SMD). Refer to wave profile for soldering conditions for through hole devices (DIP).

| ELECTRICAL CHARACTERISTICS           |  |                    |      |      |      |      |
|--------------------------------------|--|--------------------|------|------|------|------|
| PARAMETER                            | TEST CONDITION                                   | SYMBOL             | MIN. | TYP. | MAX. | UNIT |
| <b>INPUT</b>                         |  |                    |      |      |      |      |
| Forward voltage                      | I <sub>F</sub> = 10 mA                           | V <sub>F</sub>     |      | 1.2  | 1.5  | V    |
| Reverse current                      | V <sub>R</sub> = 6.0 V                           | I <sub>R</sub>     |      | 0.02 | 10   | μA   |
| Capacitance                          | V <sub>R</sub> = 0 V                             | C <sub>O</sub>     |      | 14   |      | pF   |
| <b>OUTPUT</b>                        |  |                    |      |      |      |      |
| Collector emitter breakdown voltage  | I <sub>CE</sub> = 100 μA                         | BV <sub>CEO</sub>  | 300  |      |      | V    |
| Emitter collector breakdown voltage  | I <sub>EC</sub> = 100 μA                         | BV <sub>ECO</sub>  | 0.3  |      |      | V    |
| Collector emitter dark current       | V <sub>CE</sub> = 200 V, T <sub>A</sub> = 25 °C  | I <sub>CEO</sub>   |      | 10   | 200  | nA   |
|                                      | V <sub>CE</sub> = 200 V, T <sub>A</sub> = 100 °C | I <sub>CEO</sub>   |      |      | 20   | nA   |
| Collector emitter capacitance        | V <sub>CE</sub> = 0 V, f = 1.0 MHz               | C <sub>CE</sub>    |      | 39   |      | pF   |
| <b>COUPLER</b>                       |  |                    |      |      |      |      |
| Collector emitter saturation voltage | I <sub>F</sub> = 1.0 mA, I <sub>C</sub> = 10 mA  | V <sub>CEsat</sub> |      |      | 1.0  | V    |
|                                      | I <sub>F</sub> = 10 mA, I <sub>C</sub> = 100 mA  | V <sub>CEsat</sub> | 0.3  |      | 1.2  | V    |
| Coupling capacitance                 | V <sub>I-O</sub> = 0 V, f = 1.0 MHz              | C <sub>C</sub>     |      | 0.6  |      | pF   |

**Note**T<sub>amb</sub> = 25 °C, unless otherwise specified.

Minimum and maximum values are testing requirements. Typical values are characteristics of the device and are the result of engineering evaluation. Typical values are for information only and are not part of the testing requirements.

| CURRENT TRANSFER RATIO  |  |        |      |      |      |      |
|-------------------------|--|--------|------|------|------|------|
| PARAMETER               | TEST CONDITION                                   | SYMBOL | MIN. | TYP. | MAX. | UNIT |
| Coupling transfer ratio | I <sub>F</sub> = 1.0 mA, V <sub>CE</sub> = 1.0 V | CTR    | 1000 |      |      | %    |

| SWITCHING CHARACTERISTICS |  |                  |      |      |      |      |
|---------------------------|--|------------------|------|------|------|------|
| PARAMETER                 | TEST CONDITION   | SYMBOL           | MIN. | TYP. | MAX. | UNIT |
| Rise time                 | V <sub>CC</sub> = 10 V, I <sub>C</sub> = 10 mA, R <sub>L</sub> = 100 Ω | t <sub>r</sub>   |      | 3.5  |      | μs   |
|                           | V <sub>CC</sub> = 10 V, I <sub>F</sub> = 16 mA, R <sub>L</sub> = 180 Ω | t <sub>r</sub>   |      | 1.0  |      | μs   |
| Fall time                 | V <sub>CC</sub> = 10 V, I <sub>C</sub> = 10 mA, R <sub>L</sub> = 100 Ω | t <sub>f</sub>   |      | 14.5 |      | μs   |
|                           | V <sub>CC</sub> = 10 V, I <sub>F</sub> = 16 mA, R <sub>L</sub> = 180 Ω | t <sub>f</sub>   |      | 20.5 |      | μs   |
| Turn-on time              | V <sub>CC</sub> = 10 V, I <sub>C</sub> = 10 mA, R <sub>L</sub> = 100 Ω | t <sub>on</sub>  |      | 4.5  |      | μs   |
|                           | V <sub>CC</sub> = 10 V, I <sub>F</sub> = 16 mA, R <sub>L</sub> = 180 Ω | t <sub>on</sub>  |      | 1.5  |      | μs   |
| Turn-off time             | V <sub>CC</sub> = 10 V, I <sub>C</sub> = 10 mA, R <sub>L</sub> = 100 Ω | t <sub>off</sub> |      | 29.0 |      | μs   |
|                           | V <sub>CC</sub> = 10 V, I <sub>F</sub> = 16 mA, R <sub>L</sub> = 180 Ω | t <sub>off</sub> |      | 53.5 |      | μs   |

| SAFETY AND INSULATION RATINGS                           |                        |        |       |           |      |      |
|---|------------------------|--------|-------|-----------|------|------|
| PARAMETER   | TEST CONDITION         | SYMBOL | MIN.  | TYP.      | MAX. | UNIT |
| Climatic classification<br>(according to IEC 68 part 1) |                        |        |       | 55/100/21 |      |      |
| Comparative tracking index                              |                        | CTI    | 175   |           | 399  |      |
| $V_{IOTM}$  |                        |        | 10000 |           |      | V    |
| $V_{IORM}$  |                        |        | 890   |           |      | V    |
| $P_{SO}$  |                        |        |       |           | 400  | mW   |
| $I_{SI}$  |                        |        |       |           | 275  | mA   |
| $T_{SI}$  |                        |        |       |           | 175  | °C   |
| Creepage distance                                       | standard DIP-4         |        | 7     |           |      | mm   |
| Clearance distance                                      | standard DIP-4         |        | 7     |           |      | mm   |
| Creepage distance                                       | 400 mil DIP-4          |        | 8     |           |      | mm   |
| Clearance distance                                      | 400 mil DIP-4          |        | 8     |           |      | mm   |
| Insulation thickness,<br>reinforced rated               | per IEC 60950 2.10.5.1 |        | 0.4   |           |      | mm   |

**Note**

As per IEC 60747-5-2, § 7.4.3.8.1, this optocoupler is suitable for "safe electrical insulation" only within the safety ratings. Compliance with the safety ratings shall be ensured by means of protective circuits.

**TYPICAL CHARACTERISTICS**

$T_{amb} = 25\text{ }^{\circ}\text{C}$ , unless otherwise specified

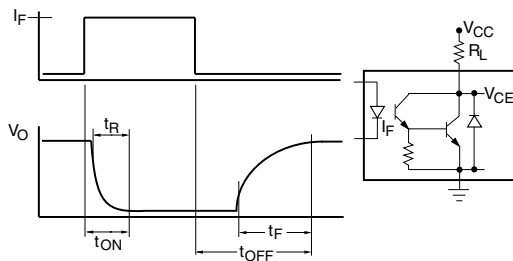

isfh619a\_01

Fig. 1 - Switching Waveform and Switching Schematic

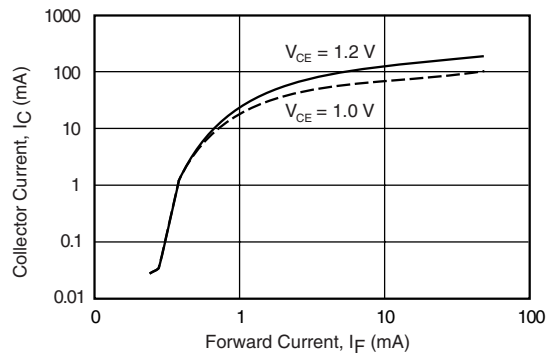

isfh619a\_03

Fig. 2 - Collector Current (mA) vs. Forward Current (mA)

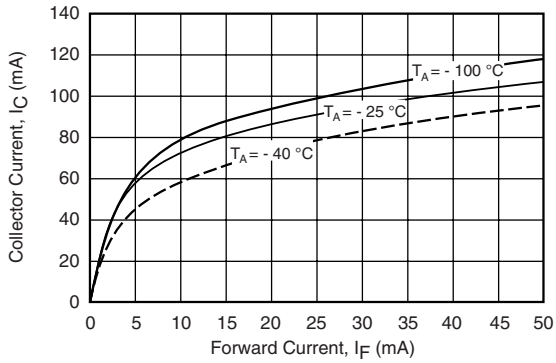

Fig. 3 - Collector Current vs. Forward Current

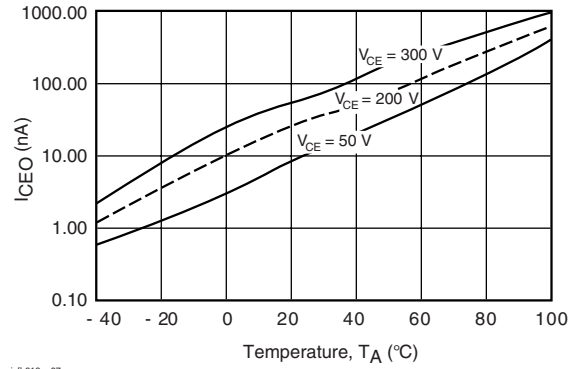

Fig. 6 - Collector Emitter Dark Current vs. Collector Emitter Voltage over Temperature

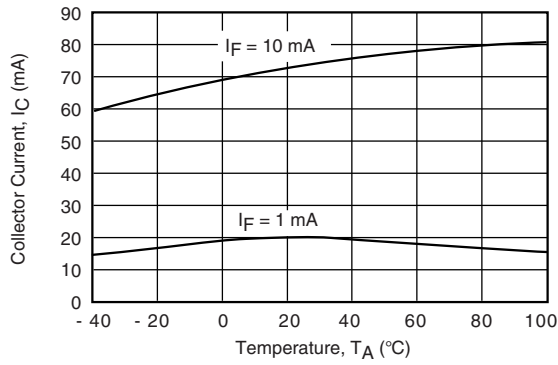

Fig. 4 - Collector Current vs. Ambient Temperature

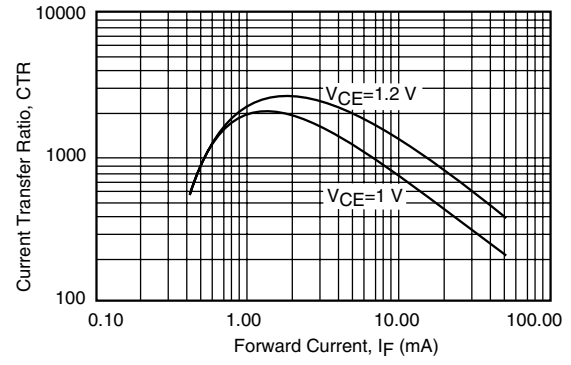

Fig. 7 - Current Transfer Ratio vs. Forward Current

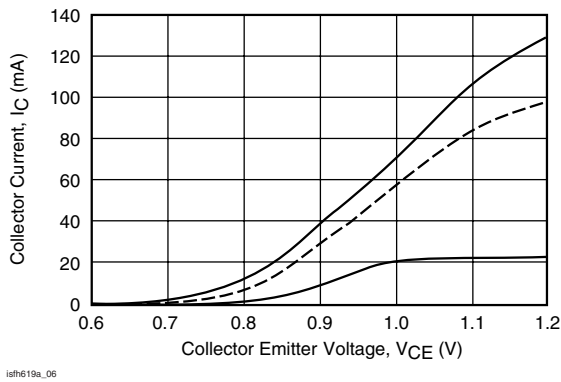

Fig. 5 - Collector Current vs. Collector Emitter Voltage

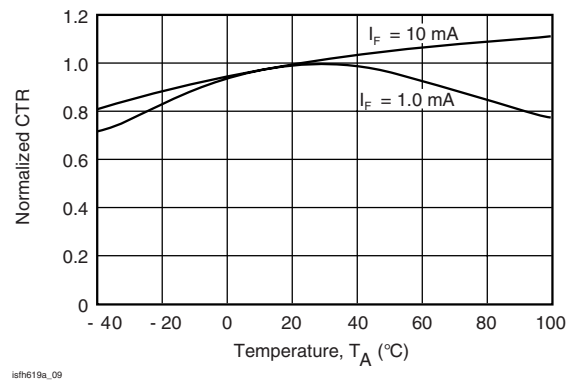
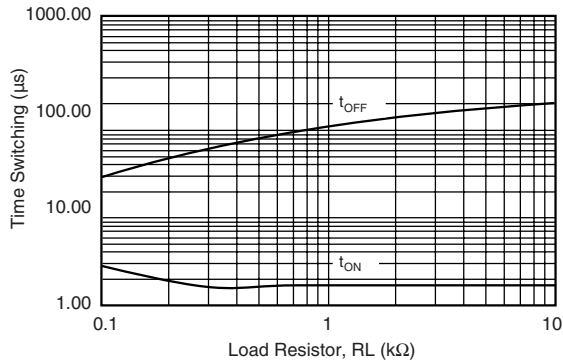

Fig. 8 - Normalized CTR vs. Temperature



sfh619a\_10

Fig. 9 - Switching Time vs. Load Resistor

### PACKAGE DIMENSIONS in inches (millimeters)

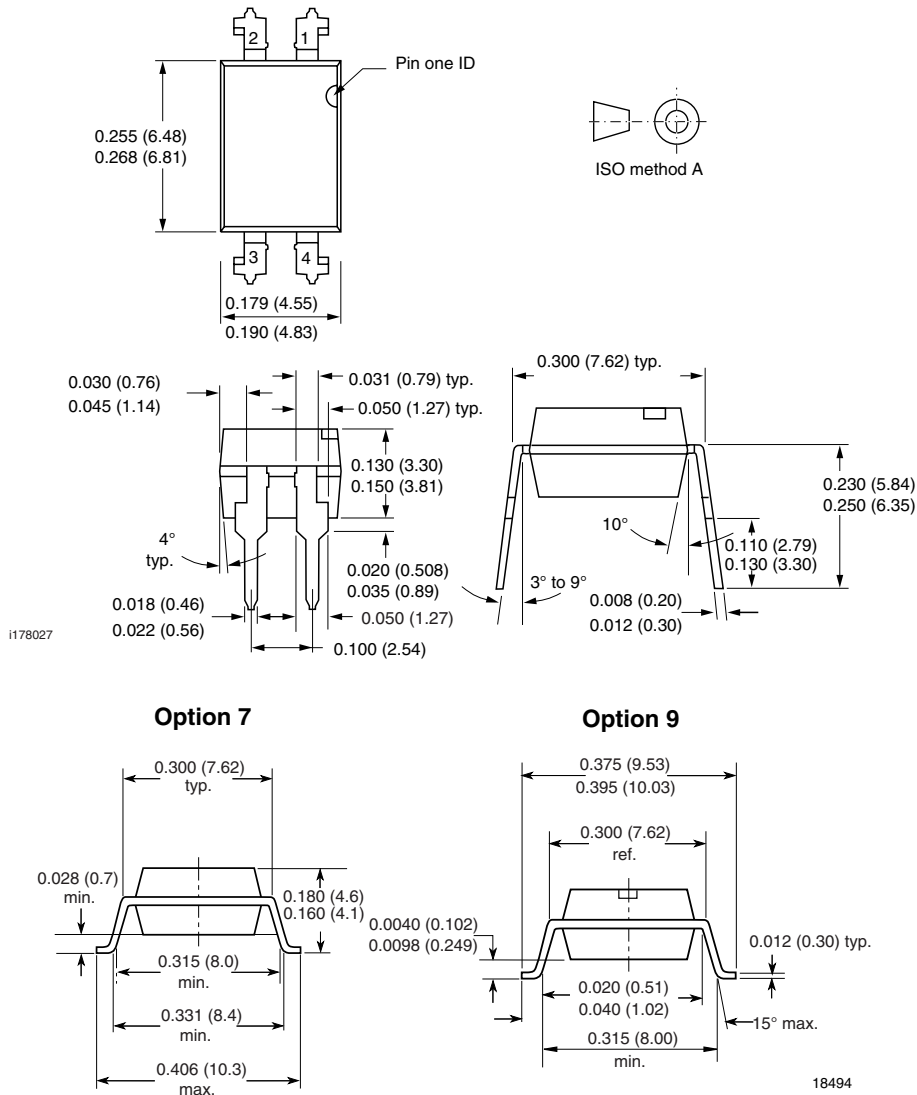

**OZONE DEPLETING SUBSTANCES POLICY STATEMENT**

It is the policy of Vishay Semiconductor GmbH to

1. Meet all present and future national and international statutory requirements.
2. Regularly and continuously improve the performance of our products, processes, distribution and operating systems with respect to their impact on the health and safety of our employees and the public, as well as their impact on the environment.

It is particular concern to control or eliminate releases of those substances into the atmosphere which are known as ozone depleting substances (ODSs).

The Montreal Protocol (1987) and its London Amendments (1990) intend to severely restrict the use of ODSs and forbid their use within the next ten years. Various national and international initiatives are pressing for an earlier ban on these substances.

Vishay Semiconductor GmbH has been able to use its policy of continuous improvements to eliminate the use of ODSs listed in the following documents.

1. Annex A, B and list of transitional substances of the Montreal Protocol and the London Amendments respectively.
2. Class I and II ozone depleting substances in the Clean Air Act Amendments of 1990 by the Environmental Protection Agency (EPA) in the USA.
3. Council Decision 88/540/EEC and 91/690/EEC Annex A, B and C (transitional substances) respectively.

Vishay Semiconductor GmbH can certify that our semiconductors are not manufactured with ozone depleting substances and do not contain such substances.

We reserve the right to make changes to improve technical design  
and may do so without further notice.

Parameters can vary in different applications. All operating parameters must be validated for each customer application by the customer. Should the buyer use Vishay Semiconductors products for any unintended or unauthorized application, the buyer shall indemnify Vishay Semiconductors against all claims, costs, damages, and expenses, arising out of, directly or indirectly, any claim of personal damage, injury or death associated with such unintended or unauthorized use.

Vishay Semiconductor GmbH, P.O.B. 3535, D-74025 Heilbronn, Germany



## Notice

Specifications of the products displayed herein are subject to change without notice. Vishay Intertechnology, Inc., or anyone on its behalf, assumes no responsibility or liability for any errors or inaccuracies.

Information contained herein is intended to provide a product description only. No license, express or implied, by estoppel or otherwise, to any intellectual property rights is granted by this document. Except as provided in Vishay's terms and conditions of sale for such products, Vishay assumes no liability whatsoever, and disclaims any express or implied warranty, relating to sale and/or use of Vishay products including liability or warranties relating to fitness for a particular purpose, merchantability, or infringement of any patent, copyright, or other intellectual property right.

The products shown herein are not designed for use in medical, life-saving, or life-sustaining applications. Customers using or selling these products for use in such applications do so at their own risk and agree to fully indemnify Vishay for any damages resulting from such improper use or sale.

Компания «Океан Электроники» предлагает заключение долгосрочных отношений при поставках импортных электронных компонентов на взаимовыгодных условиях!

Наши преимущества:

- Поставка оригинальных импортных электронных компонентов напрямую с производств Америки, Европы и Азии, а так же с крупнейших складов мира;
- Широкая линейка поставок активных и пассивных импортных электронных компонентов (более 30 млн. наименований);
- Поставка сложных, дефицитных, либо снятых с производства позиций;
- Оперативные сроки поставки под заказ (от 5 рабочих дней);
- Экспресс доставка в любую точку России;
- Помощь Конструкторского Отдела и консультации квалифицированных инженеров;
- Техническая поддержка проекта, помощь в подборе аналогов, поставка прототипов;
- Поставка электронных компонентов под контролем ВП;
- Система менеджмента качества сертифицирована по Международному стандарту ISO 9001;
- При необходимости вся продукция военного и аэрокосмического назначения проходит испытания и сертификацию в лаборатории (по согласованию с заказчиком);
- Поставка специализированных компонентов военного и аэрокосмического уровня качества (Xilinx, Altera, Analog Devices, Intersil, Interpoint, Microsemi, Actel, Aeroflex, Peregrine, VPT, Syfer, Eurofarad, Texas Instruments, MS Kennedy, Miteq, Cobham, E2V, MA-COM, Hittite, Mini-Circuits, General Dynamics и др.);

Компания «Океан Электроники» является официальным дистрибьютором и эксклюзивным представителем в России одного из крупнейших производителей разъемов военного и аэрокосмического назначения «JONHON», а так же официальным дистрибьютором и эксклюзивным представителем в России производителя высокотехнологичных и надежных решений для передачи СВЧ сигналов «FORSTAR».



## JONHON

«JONHON» (основан в 1970 г.)

Разъемы специального, военного и аэрокосмического назначения:

(Применяются в военной, авиационной, аэрокосмической, морской, железнодорожной, горно- и нефтедобывающей отраслях промышленности)

«FORSTAR» (основан в 1998 г.)

ВЧ соединители, коаксиальные кабели,  
кабельные сборки и микроволновые компоненты:

(Применяются в телекоммуникациях гражданского и специального назначения, в средствах связи, РЛС, а так же военной, авиационной и аэрокосмической отраслях промышленности).



Телефон: 8 (812) 309-75-97 (многоканальный)

Факс: 8 (812) 320-03-32

Электронная почта: [ocean@oceanchips.ru](mailto:ocean@oceanchips.ru)

Web: <http://oceanchips.ru/>

Адрес: 198099, г. Санкт-Петербург, ул. Калинина, д. 2, корп. 4, лит. А