

STEP-UP DC/DC CONVERTER

NO.EA-272-141208

OUTLINE

The R1205x Series are CMOS-based PWM control type step-up DC/DC converter ICs with low supply current. Each of these ICs consists of an NMOS FET, a diode, an oscillator, a PWM comparator, a voltage reference unit, an error amplifier, a current limit circuit, an under voltage lockout circuit (UVLO), an over-voltage protection circuit (OVP), a soft-start circuit, a Maxduty limit circuit, and a thermal shutdown protection circuit. This step-up DC/DC converter can be easily built with a few external components such as a coil, a resistor, and a capacitor. As the protection functions, the R1205x Series have a Lx peak current limit function, an over voltage protection (OVP) function, an under voltage lock out (UVLO) function and a thermal shutdown function.

The R1205x Series present the R1205x8xxA version that is optimized for the constant voltage power source, and the R1205x8xxB/C version that is optimized for driving the white LED with the constant current. The R1205x8xxB/C is an adjustable version that can change the LED brightness dynamically by using a 200Hz to 300kHz PWM signal toward the CE pin.

The R1205x Series are available in DFN1616-6B and TSOT-23-6 packages.

FEATURES

- Input Voltage Range 2.3V to 5.5V (R1205x8xxA)
1.8V to 5.5V (R1205x8xxB/C)
- Supply Current Typ. 800 μ A
- Standby Current Max. 5 μ A
- Feedback Voltage 1.0V \pm 1.5% (R1205x8xxA)
0.2V \pm 10mV (R1205x8xxB)
0.4V \pm 10mV (R1205x8xxC)
- Oscillator Frequency Typ. 1.2MHz
- Maximum Duty Cycle Typ. 91%
- UVLO Function Typ.2.0V (Hys.Typ.0.2V) (R1205x8xxA)
Typ.1.6V (Hys.Typ.0.1V) (R1205x8xxB/C)
- Lx Current Limit Function Select from 350mA, 700mA
- Over Voltage Protection Typ. 25V
- LED dimming control (R1205x8xxB/C) by external PWM signal (Frequency 200Hz to 300kHz)
- Thermal Protection Function Typ.150 $^{\circ}$ C(Hys.Typ.50 $^{\circ}$ C)
- Switch ON Resistance Typ. 1.35 Ω
- Packages DFN1616-6B, TSOT-23-6
- Ceramic capacitors are recommended

APPLICATION

- Constant Voltage Power Source for portable equipment
- OLED power supply for portable equipment
- White LED Backlight for portable equipment

BLOCK DIAGRAMS

● R1205x8xxA

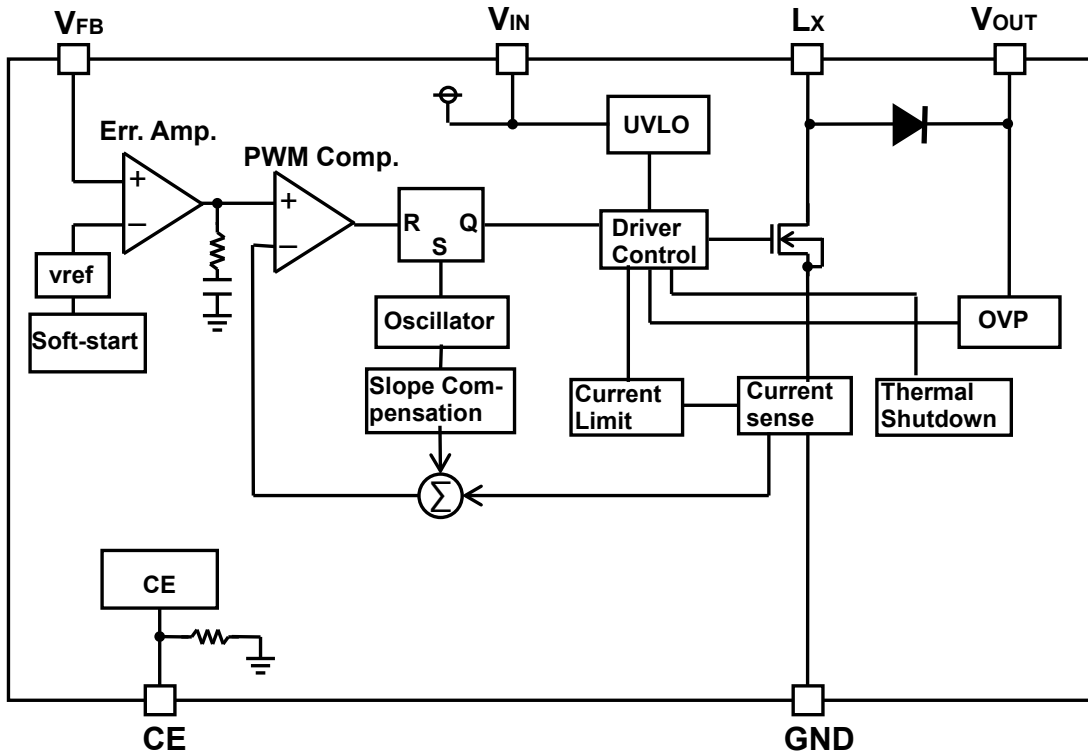

● R1205x8xxB/C

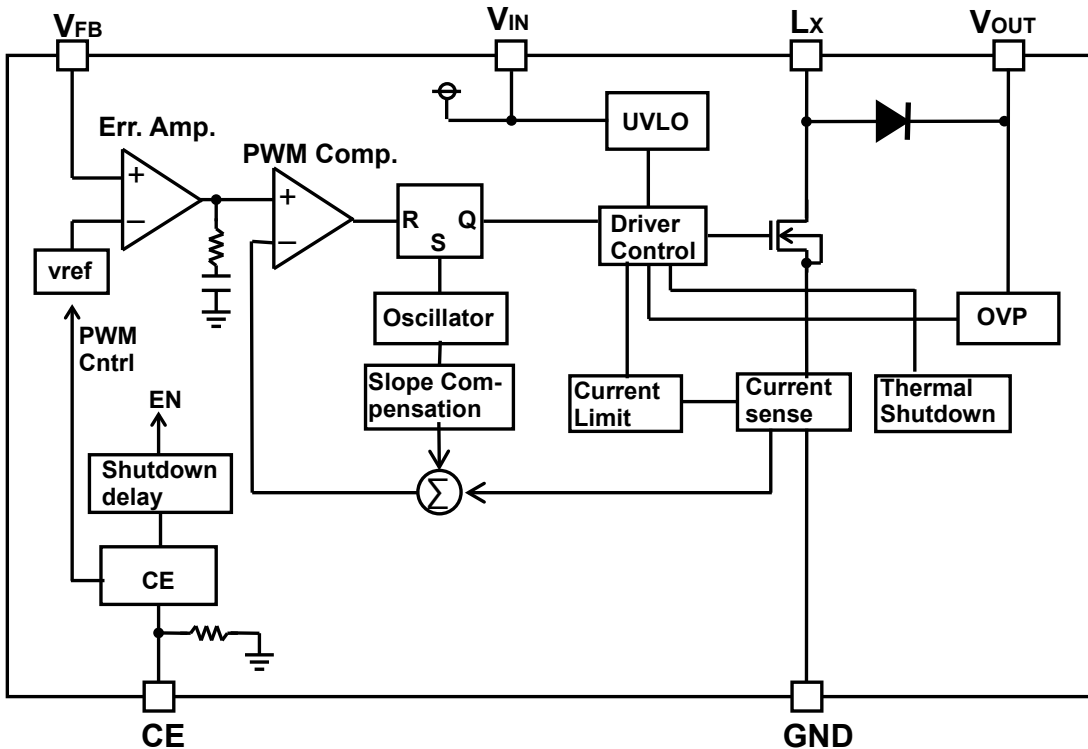

SELECTION GUIDE

The OVP threshold voltage, current limit, package and V_{FB} /Auto discharge are user-selectable options.

Product Name	Package	Quantity per Reel	Pb Free	Halogen Free
R1205L8x1*-TR	DFN1616-6B	5,000 pcs	Yes	Yes
R1205N8x3*-TR-FE	TSOT-23-6	3,000 pcs	Yes	Yes
x : Designation of current limit. (1) 350mA (2) 700mA				
* : Designation of VFB. (A) 1.0V (B) 0.2V (C) 0.4V				

PIN CONFIGURATIONS

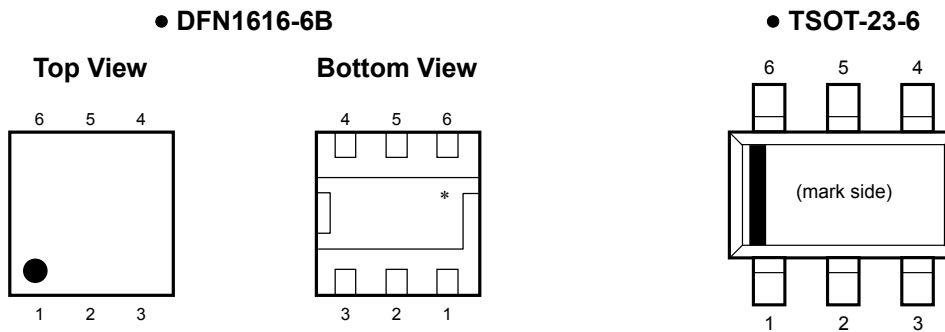

PIN DESCRIPTIONS

• DFN1616-6B

Pin No	Symbol	Pin Description
1	CE	Chip Enable Pin ("H" Active)
2	V_{FB}	Feedback Pin
3	L_X	Switching Pin (Open Drain Output)
4	GND	Ground Pin
5	V_{IN}	Input Pin
6	V_{OUT}	Output Pin

*) The tab is substrate level (GND). The tab is better to be connected to the GND, but leaving it open is also acceptable.

• TSOT-23-6

Pin No	Symbol	Pin Description
1	CE	Chip Enable Pin ("H" Active)
2	V_{OUT}	Output Pin
3	V_{IN}	Input Pin
4	L_X	Switching Pin (Open Drain Output)
5	GND	Ground Pin
6	V_{FB}	Feedback Pin

ABSOLUTE MAXIMUM RATINGS

GND=0V

Symbol	Item	Rating	Unit
V_{IN}	V_{IN} Pin Voltage	-0.3 to 6.5	V
V_{CE}	CE Pin Voltage	-0.3 to 6.5	V
V_{FB}	V_{FB} Pin Voltage	-0.3 to 6.5	V
V_{OUT}	V_{OUT} Pin Voltage	-0.3 to 28	V
V_{LX}	L_X Pin Voltage	-0.3 to 28	V
I_{LX}	L_X Pin Current	1000	mA
P_D	Power Dissipation (DFN1616-6B)*	640	mW
	Power Dissipation (TSOT-23-6)*	460	
T_a	Operating Temperature Range	-40 to 85	°C
T_{stg}	Storage Temperature Range	-55 to 125	°C

*) For details regarding Power Dissipation and Standard Test Land Pattern, please refer to PACKAGE INFORMATION.

ABSOLUTE MAXIMUM RATINGS

Electronic and mechanical stress momentarily exceeded absolute maximum ratings may cause the permanent damages and may degrade the life time and safety for both device and system using the device in the field. The functional operation at or over these absolute maximum ratings is not assured.

RECOMMENDED OPERATING CONDITIONS (ELECTRICAL CHARACTERISTICS)

All of electronic equipment should be designed that the mounted semiconductor devices operate within the recommended operating conditions. The semiconductor devices cannot operate normally over the recommended operating conditions, even if when they are used over such conditions by momentary electronic noise or surge. And the semiconductor devices may receive serious damage when they continue to operate over the recommended operating conditions.

R1205x

ELECTRICAL CHARACTERISTICS

•R1205x

(Ta=25°C)

Symbol	Item	Conditions	Min.	Typ.	Max.	Unit	
V _{IN}	Operating Input Voltage	R1205x8xxA	2.3		5.5	V	
		R1205x8xxB/C	1.8		5.5		
I _{DD}	Supply Current	V _{IN} =5.5V, V _{FB} =0V, L _X at no load		0.8	1.2	mA	
I _{standby}	Standby Current	V _{IN} =5.5V, V _{CE} =0V		1.0	5.0	μA	
V _{UVLO1}	UVLO Detector Threshold	V _{IN} falling	R1205x8xxA	1.9	2.0	2.1	V
			R1205x8xxB/C	1.5	1.6	1.7	
V _{UVLO2}	UVLO Released Voltage	V _{IN} rising	R1205x8xxA		V _{UVLO1} +0.2	2.3	V
			R1205x8xxB/C		V _{UVLO1} +0.1	1.8	
V _{CEH}	CE Input Voltage "H"	V _{IN} =5.5V	1.5			V	
V _{CEL}	CE Input Voltage "L"	V _{IN} =1.8V			0.5	V	
R _{CE}	CE Pull Down Resistance			1200		kΩ	
V _{FB}	V _{FB} Voltage Accuracy	V _{IN} =3.6V	R1205x8xxA	0.985	1.000	1.015	V
			R1205x8xxB	0.19	0.2	0.21	
			R1205x8xxC	0.39	0.4	0.41	
$\frac{\Delta V_{FB}}{\Delta T_a}$	V _{FB} Voltage Temperature Coefficient	V _{IN} =3.6V, -40°C ≤ T _a ≤ 85°C		±150		ppm/°C	
I _{FB}	V _{FB} Input Current	V _{IN} =5.5V, V _{FB} =0V or 5.5V	-0.1		0.1	μA	
t _{start}	Soft-start Time	R1205x8xxA		2.0	3.0	ms	
R _{ON}	FET ON Resistance	I _{LX} =100mA		1.35		Ω	
I _{OFF}	FET Leakage Current	V _{LX} =24V			3.0	μA	
I _{LIM}	FET Current Limit	R1205x81xx	250	350	450	mA	
		R1205x82xx	500	700	900		
V _F	Diode Forward Voltage	I _{SW} =100mA		0.8		V	
I _{DIODEleak}	Diode Leakage Current	V _{OUT} =24V, V _{LX} =0V			10	μA	
f _{osc}	Oscillator Frequency	V _{IN} =3.6V, V _{FB} =0V	1000	1200	1400	kHz	
Maxduty	Maximum Duty Cycle	V _{IN} =3.6V, V _{FB} =0V	86	91		%	
V _{OVP1}	OVP Detect Voltage	V _{IN} =3.6V, V _{OUT} rising	24.2	25	25.8	V	
V _{OVP2}	OVP Release Voltage	V _{IN} =3.6V, V _{OUT} falling		V _{OVP1} -1.8		V	
T _{TSD}	Thermal Shutdown Detect Temperature	V _{IN} =3.6V		150		°C	
T _{TSR}	Thermal Shutdown Release Temperature	V _{IN} =3.6V		100		°C	

TYPICAL APPLICATIONS

●R1205x8xxA

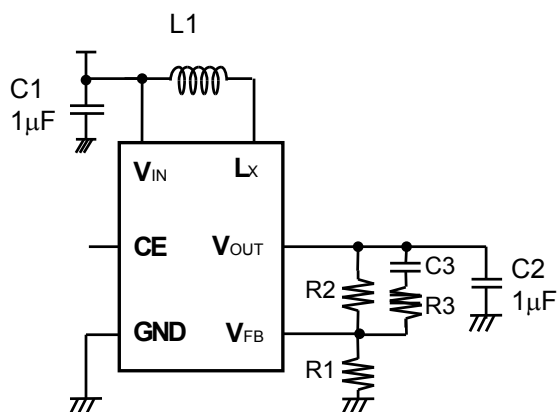

●R1205x8xxB/C

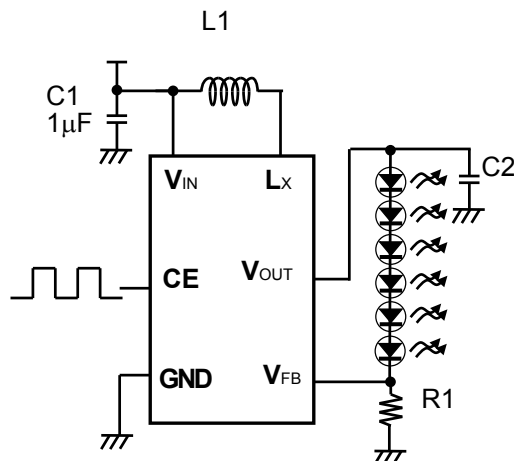

Table 1.Recommended external Inductor

L1 (µH)	Parts No	Rated Current(mA)	Size(mm)
10	LQH32CN100K53	450	3.2×2.5×1.55
10	LQH2MC100K02	225	2.0×1.6×0.9
10	VLF3010A-100	490	2.8×2.6×0.9
22	LQH32CN220K53	250	3.2×2.5×1.55
22	LQH2MC220K02	185	2.0×1.6×0.9
22	VLF3010A-220	330	2.8×2.6×0.9

Table 2.R1205x8xxA Recommended external components

	Rated voltage(V)	Part No.
C1	6.3	CM105B105K06
C2	25	GRM21BR11E105K
C3	25	220pF
R1		For V _{OUT} Setting
R2		For V _{OUT} Setting
R3		2kΩ

Table 3.R1205x8xxB/C Recommended external components

	R1205x	Rated voltage(V)	Part No.
C1	R1205x8xxB/C	6.3	CM105B105K06
C2	R1205x8xxB	25	GRM21BR11E224
	R1205x8xxC	25	C2012X7R1E474K
R1	R1205x8xxB	-	(10/ LED Arrays* ¹ (Ω))
	R1205x8xxC	-	(20/ LED Arrays* ¹ (Ω))

*¹ LED Arrays indicate the number of parallel LEDs in series.

- **The Method of Output Voltage Setting (R1205x8xxA)**

The output voltage (V_{OUT}) can be calculated with divider resistors (R1 and R2) values as the following formula:

$$\text{Output Voltage } (V_{OUT}) = V_{FB} \times (R1 + R2) / R1$$

The total value of R1 and R2 should be equal or less than 300k Ω . Make the V_{IN} and GND line sufficient. The large current flows through the V_{IN} and GND line due to the switching. If this impedance (V_{IN} and GND line) is high, the internal voltage of the IC may shift by the switching current, and the operating may become unstable. Moreover, when the built-in L_X switch is turn OFF, the spike noise caused by the inductor may be generated. As a result of this, recommendation voltage rating of capacitor (C2) value is equal 1.5 times larger or more than the setting output voltage.

- **LED Current setting (R1205x8xxB/C)**

When CE pin input is "H" (Duty=100%), LED current can be set with feedback resistor (R1)

$$I_{LED} = V_{FB} / R1$$

- **LED Dimming Control (R1205x8xxB/C)**

The LED brightness can be controlled by inputting the PWM signal to the CE pin. If the CE pin input is "L" in the fixed time (Typ.0.5ms), the IC becomes the standby mode and turns OFF LEDs.

The current of LEDs can be controlled by Duty of the PWM signal of the input CE pin. The current of LEDs when High-Duty of the CE input is "Hduty" reaches the value as calculatable following formula.

$$I_{LED} = Hduty \times V_{FB} / R1$$

The frequency of the PWM signal is using the range between 200Hz to 300kHz.

When controlling the LED brightness by the PWM signal of 5kHz or less, R1205x8xxB/C are recommended to avoid discharge function during dimming control.

When controlling the LED brightness by the PWM signal of 20kHz or less, the increasing or decreasing of the inductor current might be make a sounds in the hearable sound wave area. In that case, please use the PWM signal in the high frequency area.

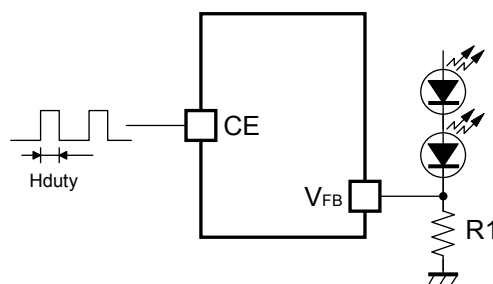

Dimming Control by CE Pin Input

- **Low luminance Dimming Accuracy (R1205x8xxC)**

Low luminance Dimming filtered V_{FB} voltage tolerance depends on the offset voltage of the internal DC/DC converter. By this offset voltage, some voltage difference may be generated between V_{REF} voltage and V_{FB} voltage. Low luminance Dimming Accuracy is shown in Table.4

Table 4. Low luminance Dimming Accuracy for R1205x8xxC (R1=20ohm)

The duty of a PWM signal for the CE pin	I _{LED} Min.	I _{LED} Max.
3.5% (Frequency = 20kHz ~ 300kHz)	0.01mA ²	2.1mA ²

² guaranteed by design engineering (Ta=25 °C)

- **Soft-Start (R1205x8xxA)**

The output and reference of the error amplifier start from 0V and the reference gradually rises up to 1.0V. After the softstart time (T_{SS}), output voltage rise up to the setting voltage.

The output of the error amplifier starts from 0V and the inrush current is suppressed when starting by the CE pin "H" input. Moreover, the inrush current can be suppressed by gradually enlarging Duty of the PWM signal to the CE pin.

- **Current Limit Function**

Current limit function monitors the over current and if it reaches the peak current, it will turn off the driver. When the over current decreases, it will restart oscillation and will restart the monitoring.

- **Inductor Selection**

The peak current of the inductor under the stationary operation can be calculated by the following formula.

$$I_{Lmax} = 1.25 \times I_{LED} \times V_{OUT} / V_{IN} + 0.5 \times V_{IN} \times (V_{OUT} - V_{IN}) / (L \times V_{OUT} \times f_{osc})$$

In the case of adjusting the brightness at the start-up or by the CE pin, the peak current can be transiently more than the above. Select the inductor that can limit the peak current within the current limit of the ICs.

Also, select the inductor of which peak current will not exceed the rated inductor value. The recommended inductance value is between 10μH to 22μH.

- **Capacitor Selection**

The recommended capacitor value for C1 is in the range from 1.0μF to 4.7μF. Connect C1 between V_{IN} and GND pin as close as possible to the pins.

Connect a output capacitor in the range from 1.0μF to 4.7μF between V_{OUT} and GND pins. (R1205x8xxA)

Connect a output capacitor in the range from 0.22μF to 1.0μF between V_{OUT} and GND pins. (R1205x8xxB)

Connect a output capacitor in the range from 0.47μF to 2.2μF between V_{OUT} and GND pins. (R1205x8xxC)

- **External Components Setting**

If the V_{OUT} spike noise is high, it may influence on the V_{FB} pin to cause the operation of R1205x8xxA unstable. To reduce the noise coming into V_{FB} pin, please place a 1kΩ to 5kΩ resistor in R3 in Fig 1.

- **Application of Using 5.5V or more Power Supply**

Other than the IC power supply, if there is a power supply greater than 5.5V, the high power output can be achieved by using the power supply as an inductor power supply. In this case, please place a capacitor between an inductor power supply and GND (shown in Fig 2.) aside from a bypass capacitor between the V_{IN} pin and GND of the IC.

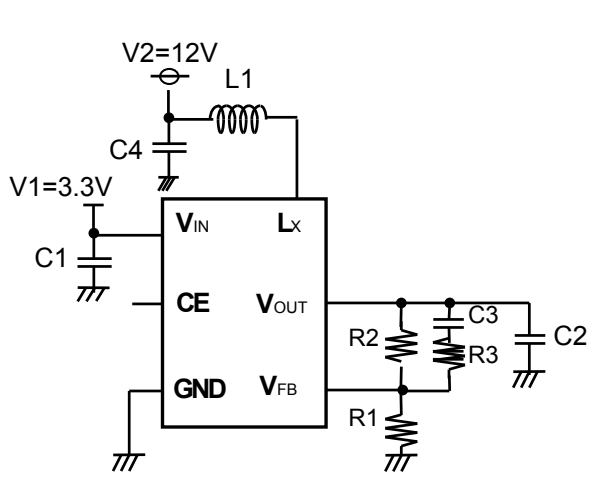

Fig 1. R1205x8xxA

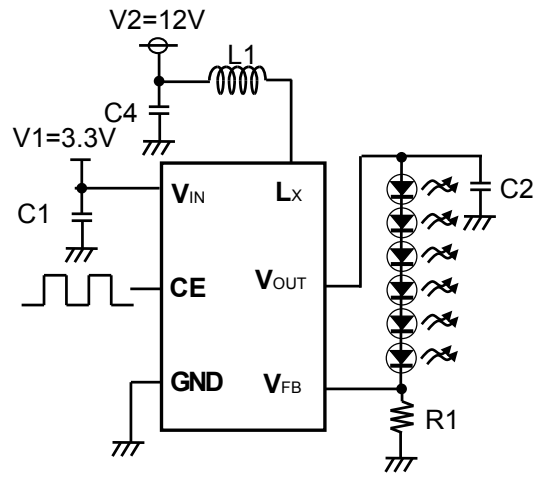
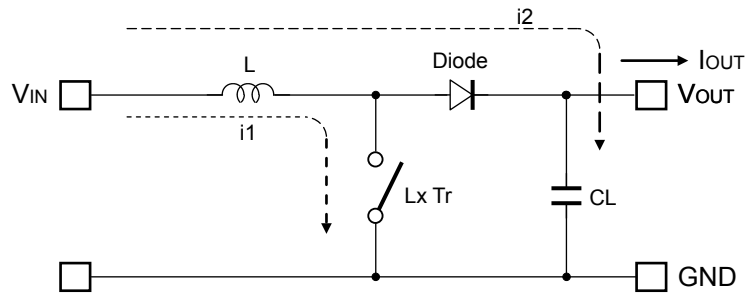

Fig 2. R1205x8xxB/C

OPERATION OF STEP-UP DC/DC CONVERTER AND OUTPUT CURRENT

<Basic Circuit>



<Current through L>

Discontinuous mode

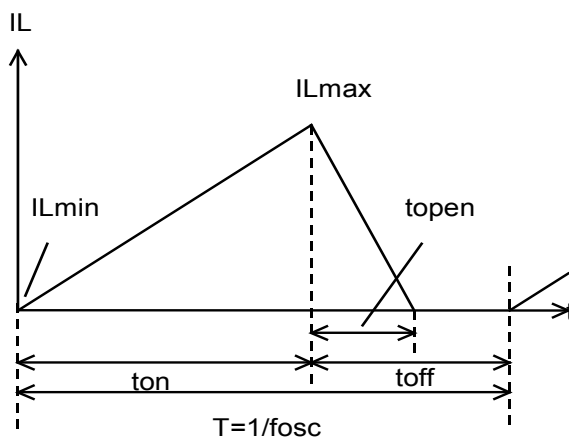

Continuous mode

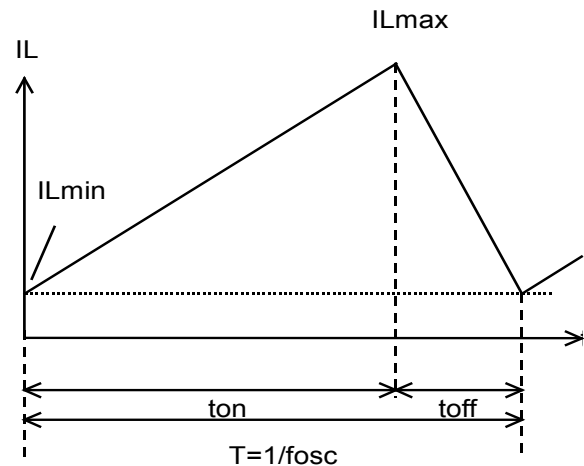

There are two operation modes of the step-up PWM control-DC/DC converter. That is the continuous mode and discontinuous mode by the continuousness inductor.

When the transistor turns ON, the voltage of inductor L becomes equal to V_{IN} voltage. The increase value of inductor current ($i1$) will be

$$\Delta i1 = V_{IN} \times t_{on} / L \dots\dots\dots \text{Formula 1}$$

As the step-up circuit, during the OFF time (when the transistor turns OFF) the voltage is continually supply from the power supply. The decrease value of inductor current ($i2$) will be

$$\Delta i2 = (V_{OUT} - V_{IN}) \times t_{open} / L \dots\dots\dots \text{Formula 2}$$

At the PWM control-method, the inductor current become continuously when $t_{open}=t_{off}$, the DC/DC converter operate as the continuous mode.

In the continuous mode, the variation of current of i_1 and i_2 is same at regular condition.

$$V_{IN} \times t_{on} / L = (V_{OUT} - V_{IN}) \times t_{off} / L \dots\dots\dots \text{Formula 3}$$

The duty at continuous mode will be

$$\text{duty (\%)} = t_{on} / (t_{on} + t_{off}) = (V_{OUT} - V_{IN}) / V_{OUT} \dots\dots\dots \text{Formula 4}$$

The average of inductor current at $t_f = t_{off}$ will be

$$I_L(\text{Ave.}) = V_{IN} \times t_{on} / (2 \times L) \dots\dots\dots \text{Formula 5}$$

If the input voltage = output voltage, the I_{OUT} will be

$$I_{OUT} = V_{IN}^2 \times t_{on} / (2 \times L \times V_{OUT}) \dots\dots\dots \text{Formula 6}$$

If the I_{OUT} value is large than above the calculated value (Formula 6), it will become the continuous mode, at this status, the peak current (I_{Lmax}) of inductor will be

$$I_{Lmax} = I_{OUT} \times V_{OUT} / V_{IN} + V_{IN} \times t_{on} / (2 \times L) \dots\dots\dots \text{Formula 7}$$

$$I_{Lmax} = I_{OUT} \times V_{OUT} / V_{IN} + V_{IN} \times T \times (V_{OUT} - V_{IN}) / (2 \times L \times V_{OUT}) \dots\dots\dots \text{Formula 8}$$

The peak current value is larger than the I_{OUT} value. In case of this, selecting the condition of the input and the output and the external components by considering of I_{Lmax} value.

The explanation above is based on the ideal calculation, and the loss caused by $L \times$ switch and the external components are not included.

The actual maximum output current will be between 50% and 80% by the above calculations. Especially, when the I_L is large or V_{IN} is low, the loss of V_{IN} is generated with on resistance of the switch. Moreover, it is necessary to consider V_f of the diode (approximately 0.8V) about V_{OUT} .

TYPICAL CHARACTERISTICS

1) Efficiency vs. Output Current Characteristics (R1205N823A)

$V_{OUT}=10V, L=10\mu H$ (LQH32CN100K53)

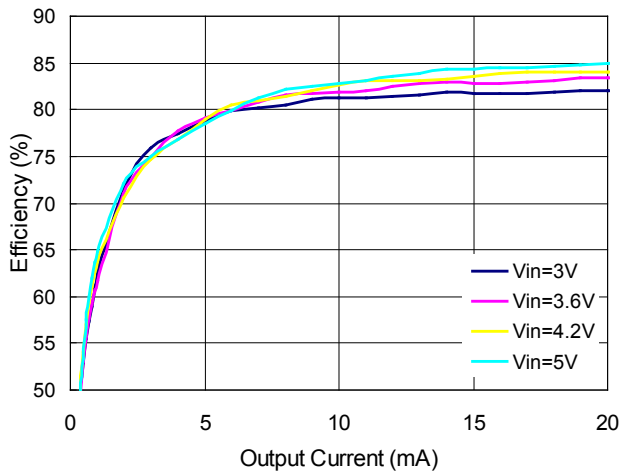

$V_{OUT}=10V, L=22\mu H$ (LQH32CN220K53)

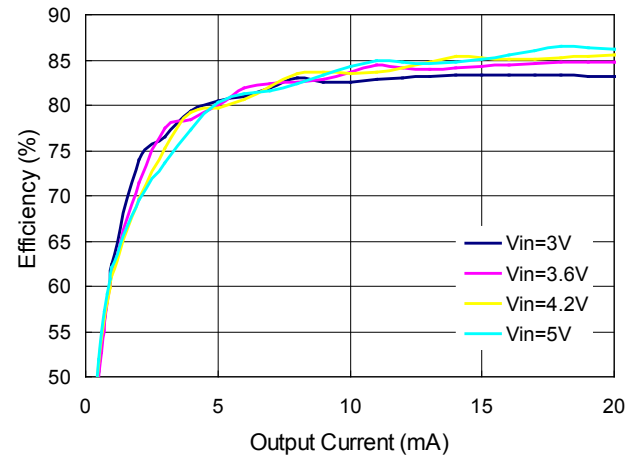

$V_{OUT}=15V, L=10\mu H$ (LQH32CN100K53)

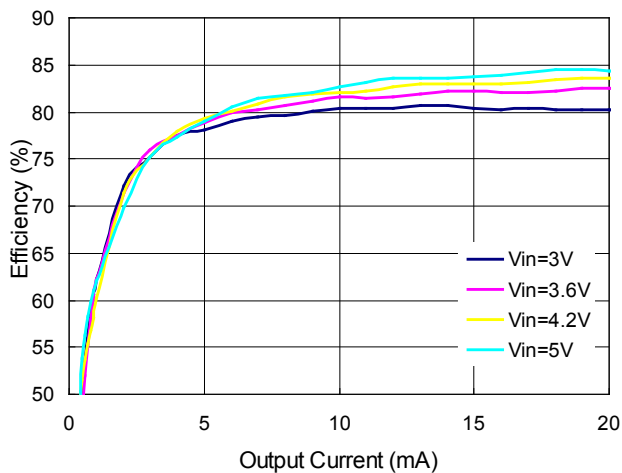

$V_{OUT}=15V, L=22\mu H$ (LQH32CN220K53)

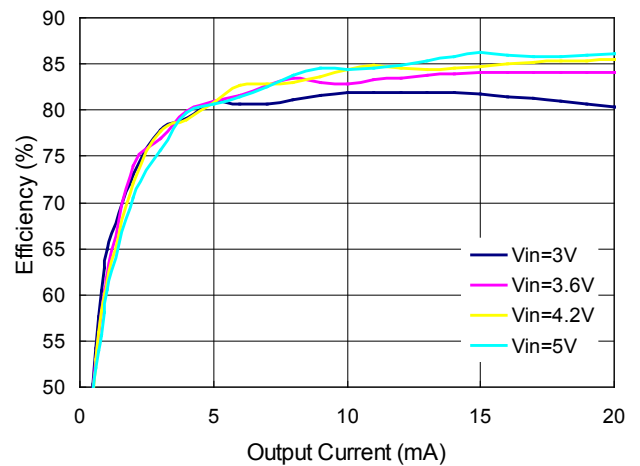

$V_{OUT}=20V, L=10\mu H$ (LQH32CN100K53)

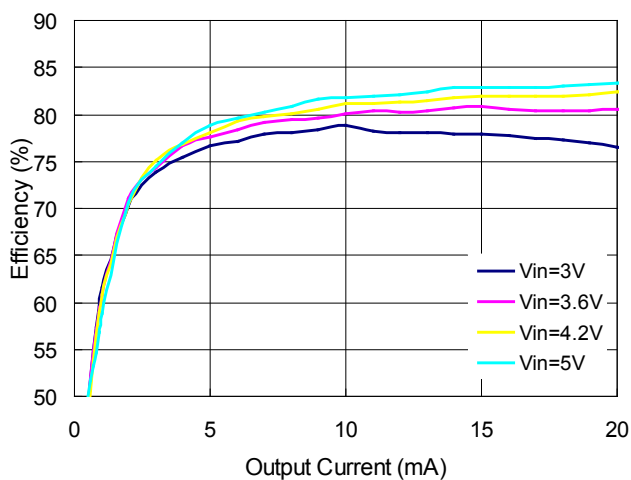

$V_{OUT}=20V, L=22\mu H$ (LQH32CN220K53)

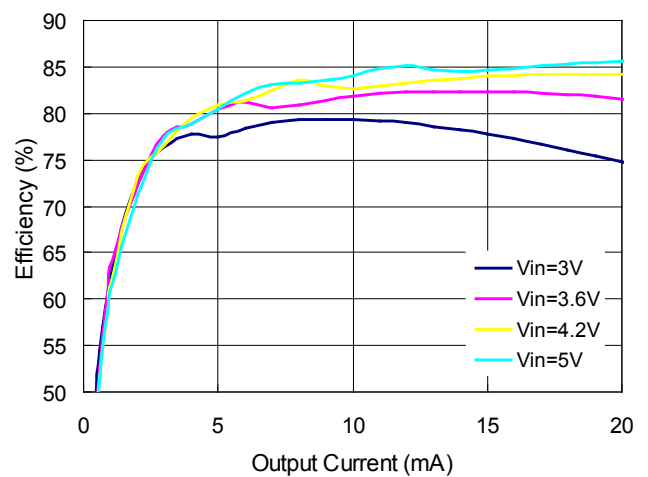

$V_{OUT}=20V, V_{IN}=3.6V$

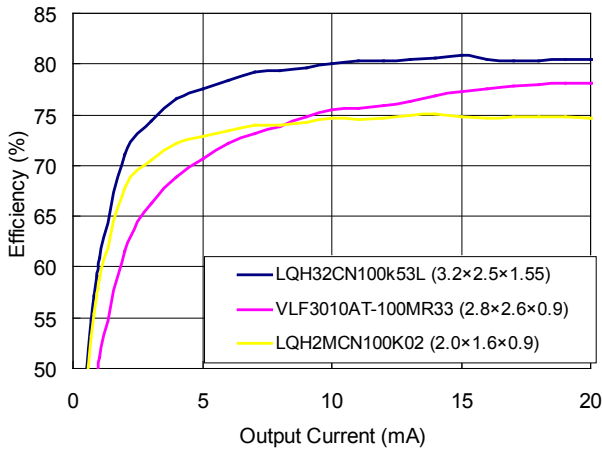

■ Typical Applications with Using 5.5V or Greater

$V_{OUT}=15V, L=10\mu H$ (LQH32CN100K53)

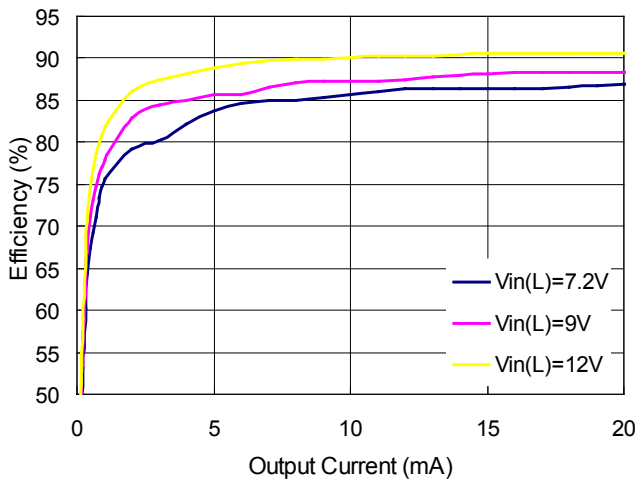

$V_{OUT}=20V, L=10\mu H$ (LQH32CN100K53)

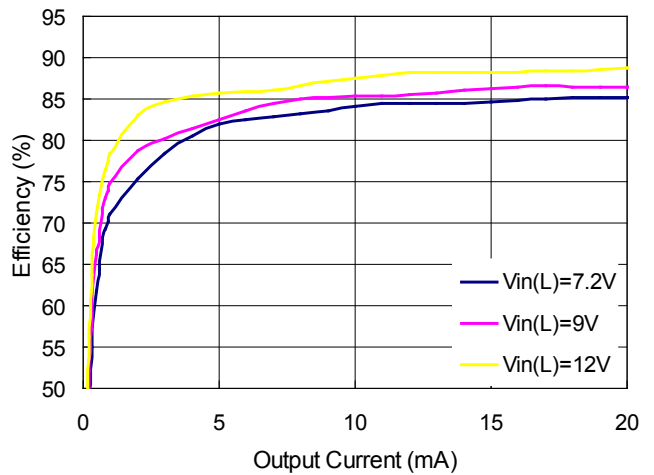

2) Efficiency vs. Output Current Characteristics (R1205N823B/C)

4LED, $L=10\mu H$ (LQH32CN100K53)

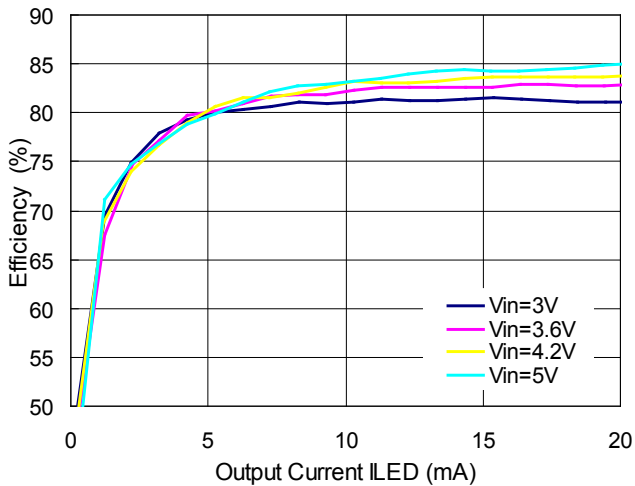

4LED, $L=22\mu H$ (LQH32CN220K53)

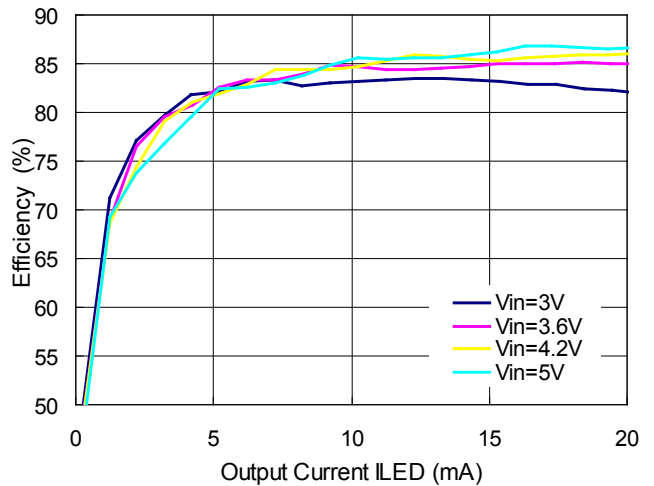

5LED, L=10 μ H (LQH32CN100K53)

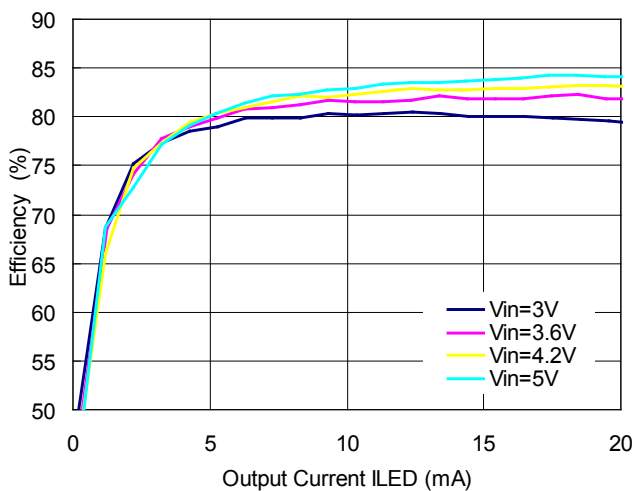

5LED, L=22 μ H (LQH32CN220K53)

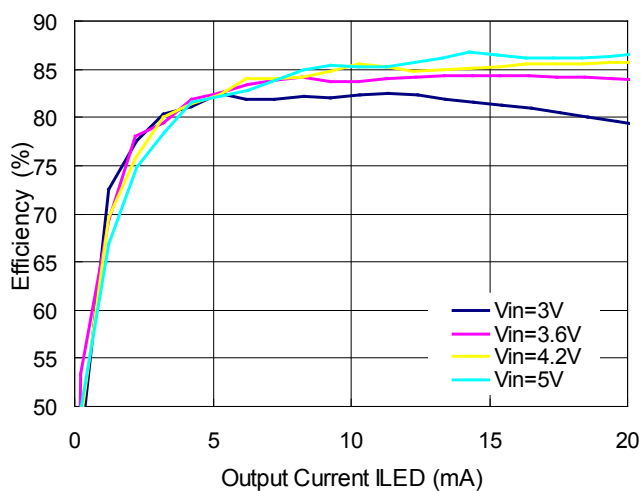

6LED, L=10 μ H (LQH32CN100K53)

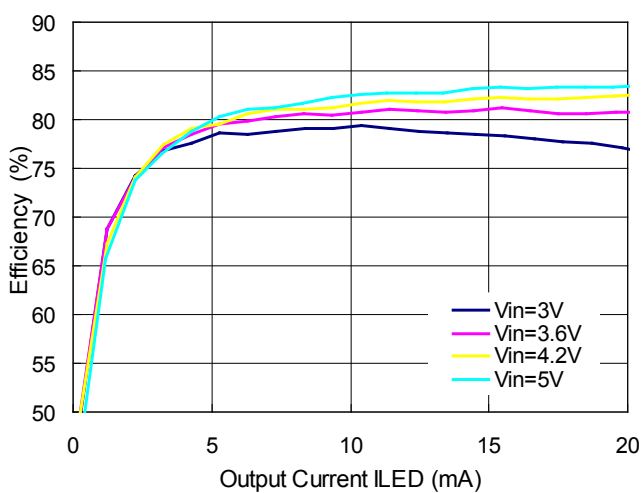

6LED, L=22 μ H (LQH32CN220K53)

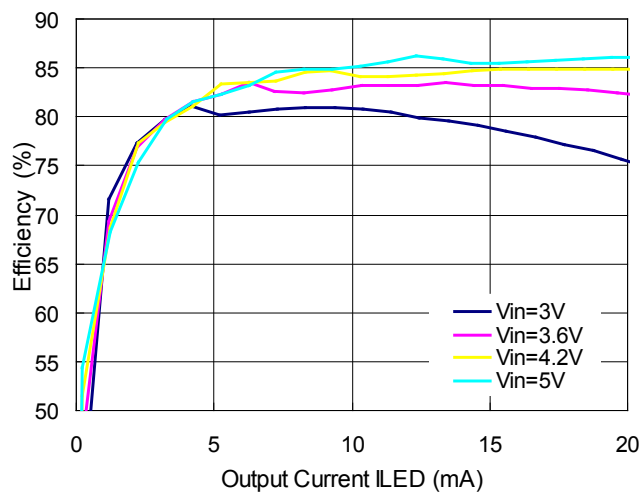

6LED, VIN=3.6V

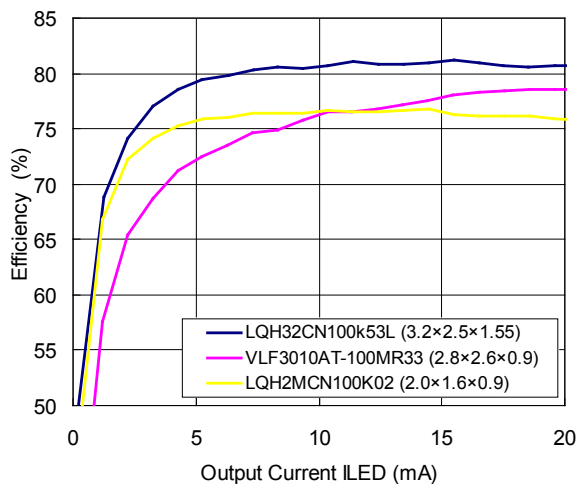

■ Typical Applications with Using 5.5V or Greater

5LED, $V_{IN(IC)}=3.6V$

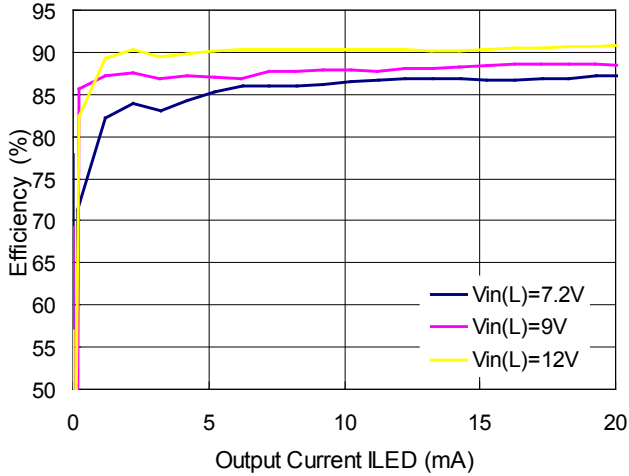

6LED, $V_{IN(IC)}=3.6V$

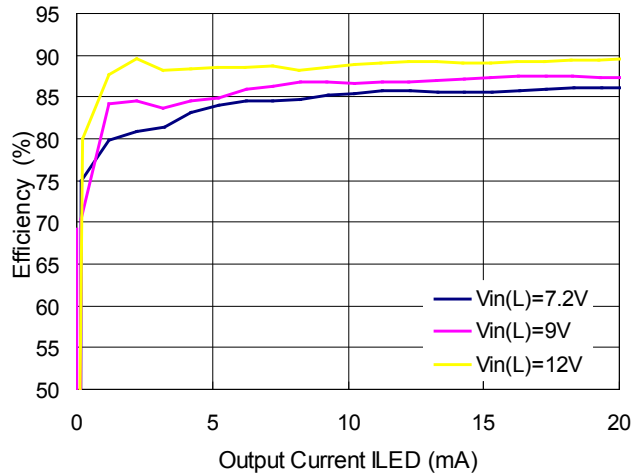

3) Output Voltage vs. Output Current (R1205N823A)

$V_{OUT}=10V, L=10\mu H$ (LQH32CN100K53)

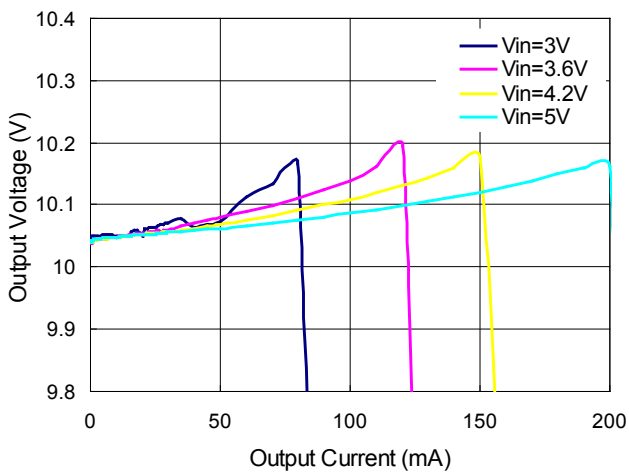

$V_{OUT}=10V, L=22\mu H$ (LQH32CN220K53)

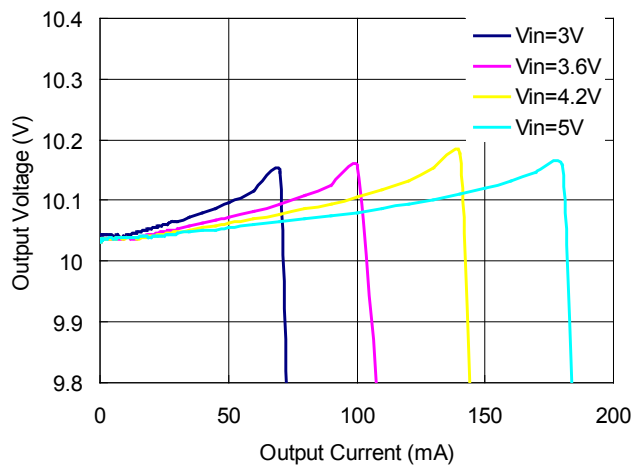

$V_{OUT}=15V, L=10\mu H$ (LQH32CN100K53)

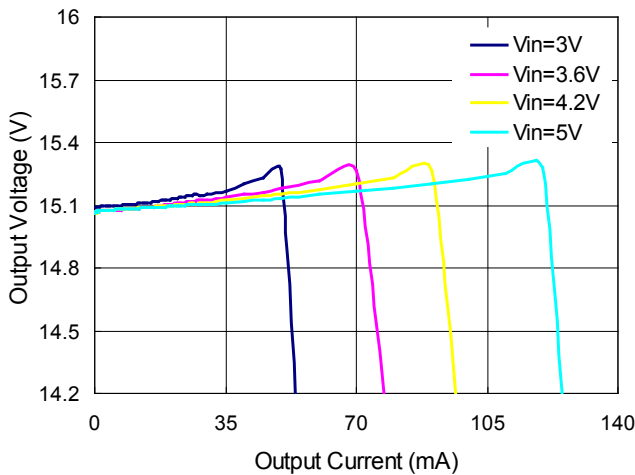

$V_{OUT}=15V, L=22\mu H$ (LQH32CN220K53)

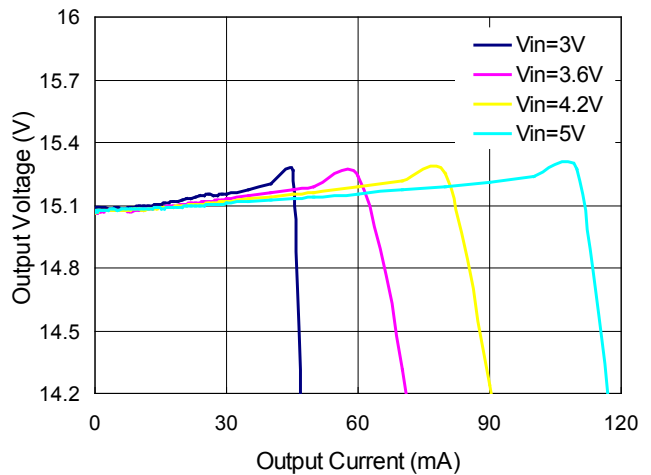

V_{OUT}=20V, L=10μH (LQH32CN100K53)

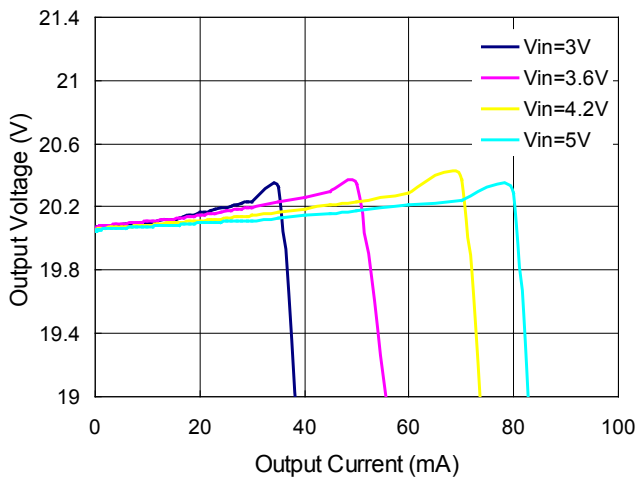

V_{OUT}=20V, L=22μH (LQH32CN220K53)

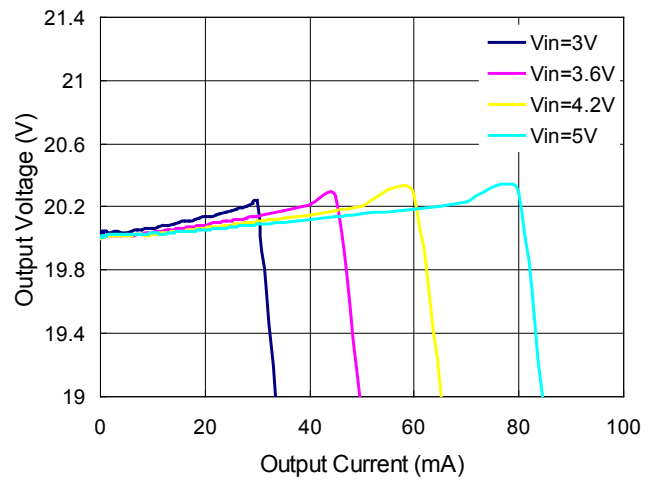

V_{OUT}=20V, V_{IN}=3.6V

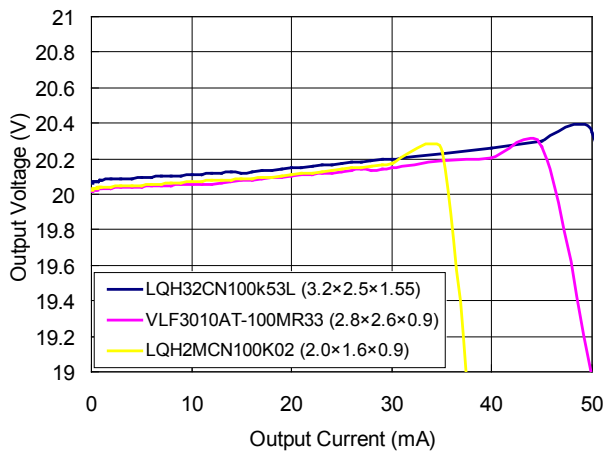

Typical Applications with Using 5.5V or Greater

V_{OUT}=15V, L=10μH (LQH32CN100K53)

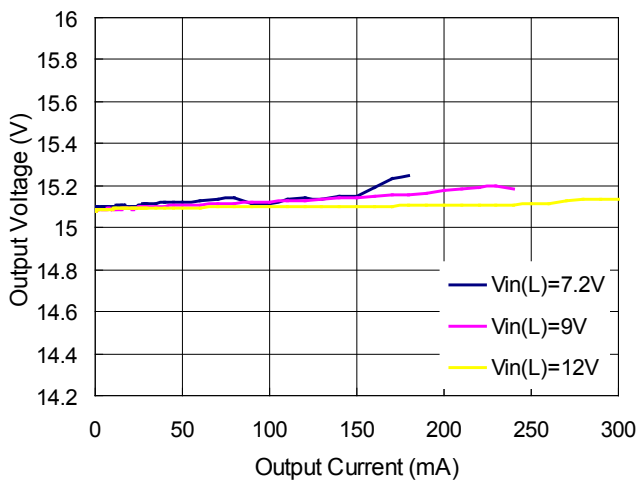

V_{OUT}=20V, L=10μH (LQH32CN100K53)

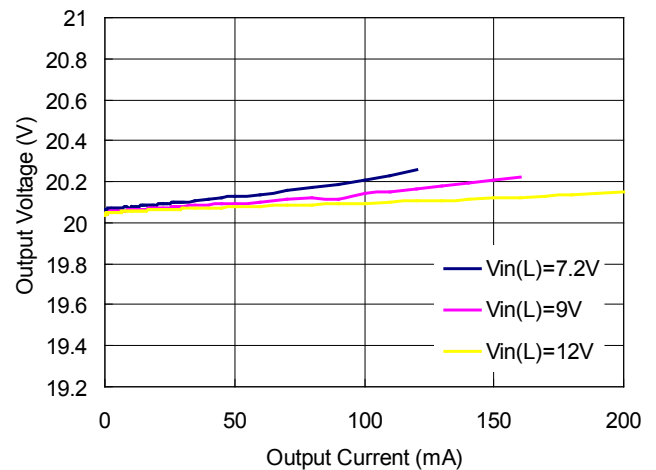

4) Maxduty vs. ILED

R1205N823B/C

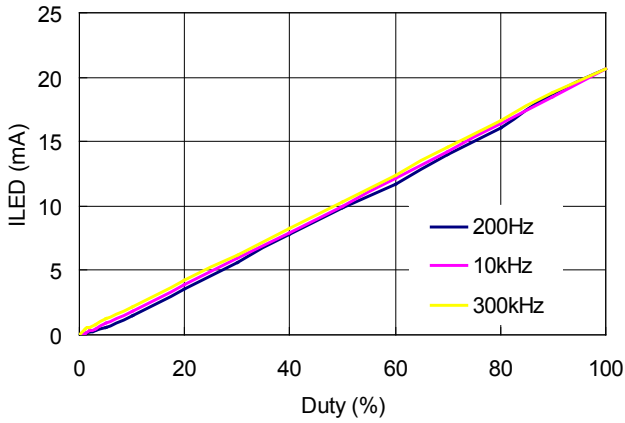

5) OVP Output Waveform

R1205N823B/C

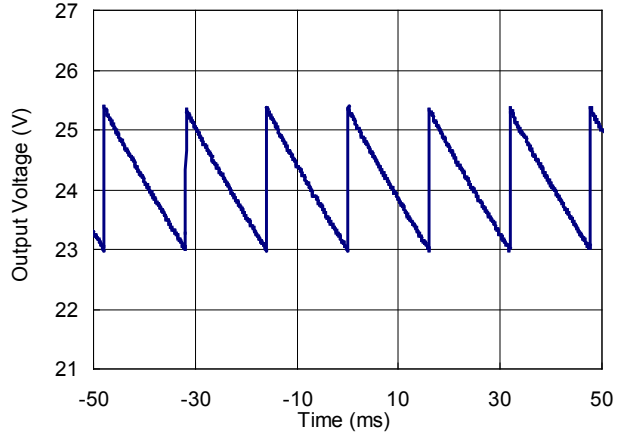

6) Waveform (6LED)

R1205N823B/C (CE Freq=200Hz)

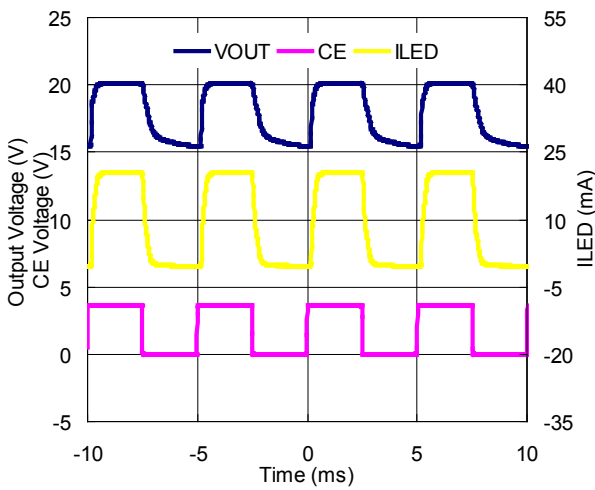

R1205N823B/C (CE Freq=10KHz)

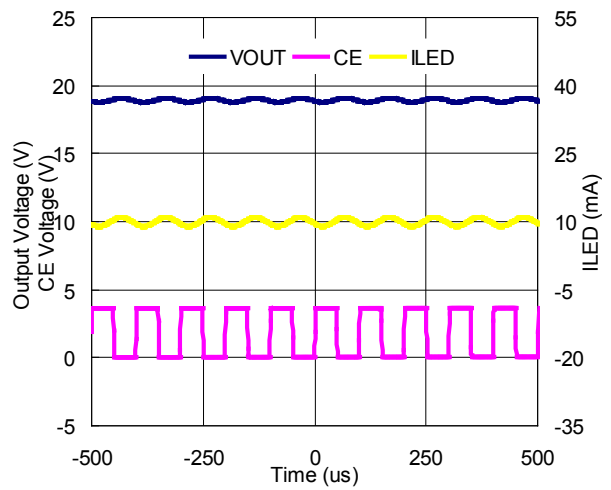

R1205N823B/C(CE Freq=300KHz)

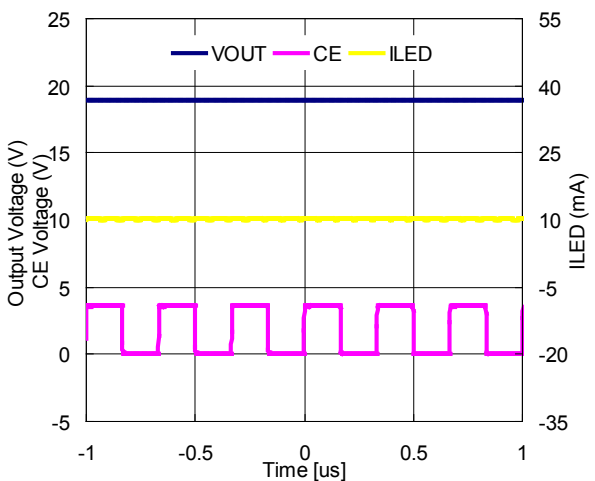

7) Diode Forward Voltage vs. Temperature

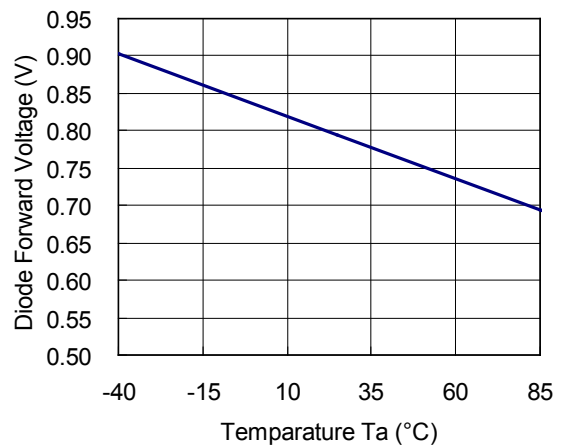

8) Standby Current vs. Temperature

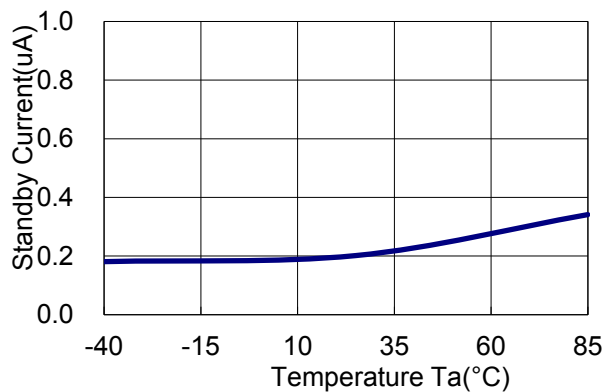

9) Supply Current vs. Temperature

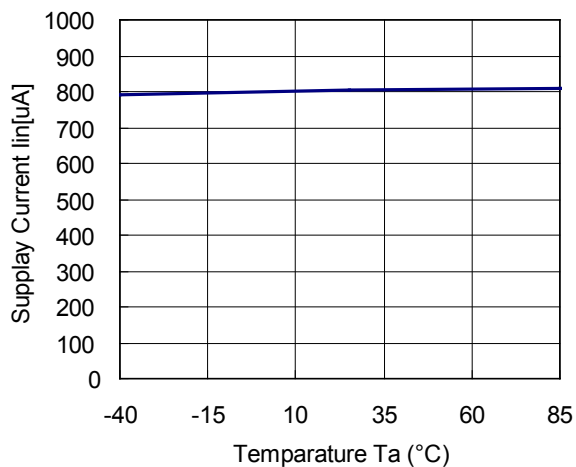

10) UVLO Output Voltage vs. Temperature

R1205x8xxA

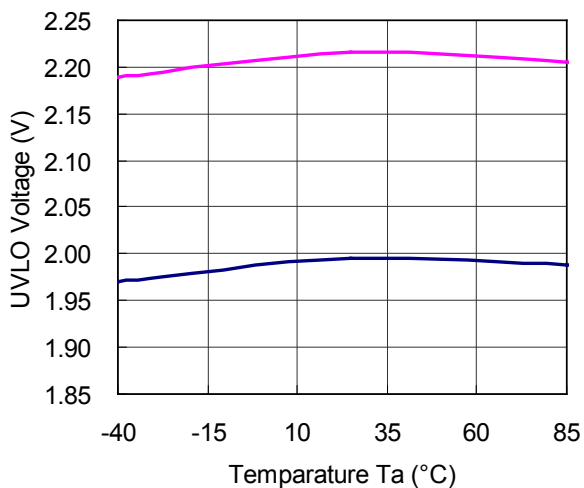

R1205x8xxB/C

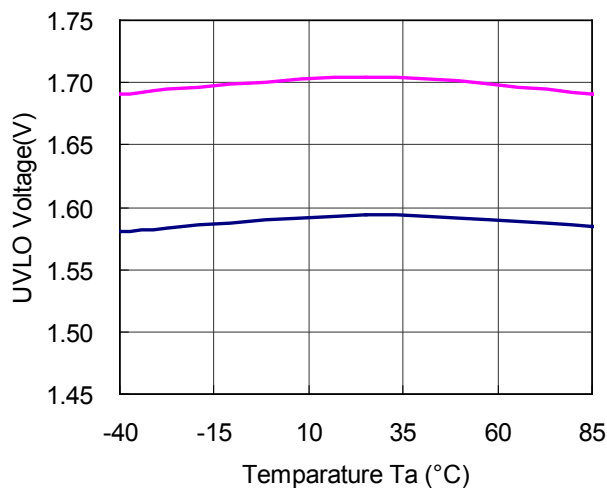

11) VFB Voltage vs. Temperature

R1205x8xxA

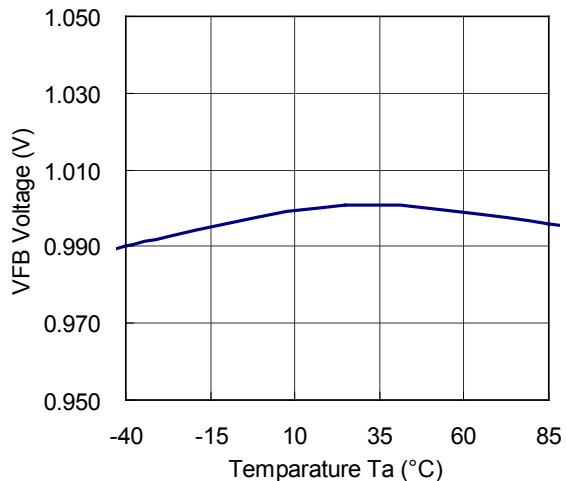

R1205x8xxB

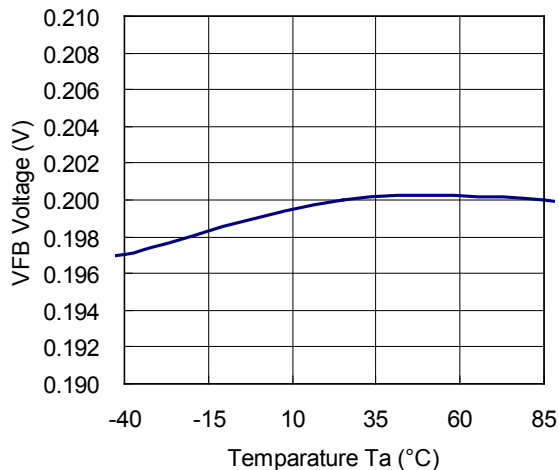

R1205x8xxC

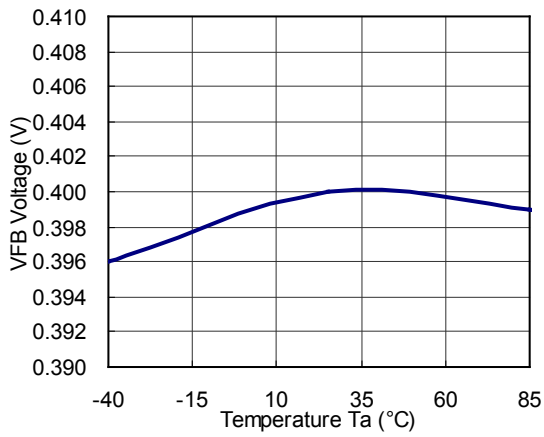

12) Switch ON Resistance RON vs. Temperature

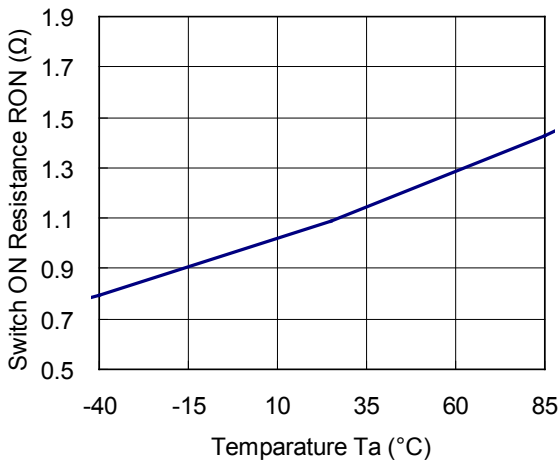

13) OVP Voltage vs. Temperature

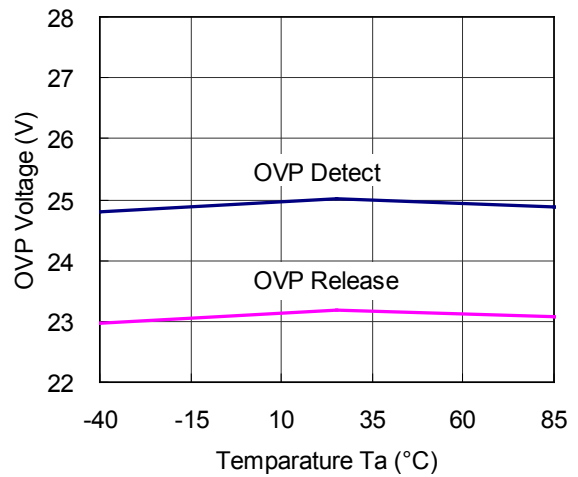

14) Lx Current Limit vs. Temperature

R1205x81xx

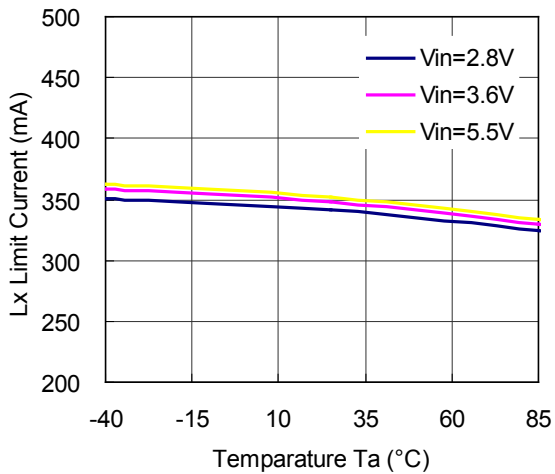

R1205x82xx

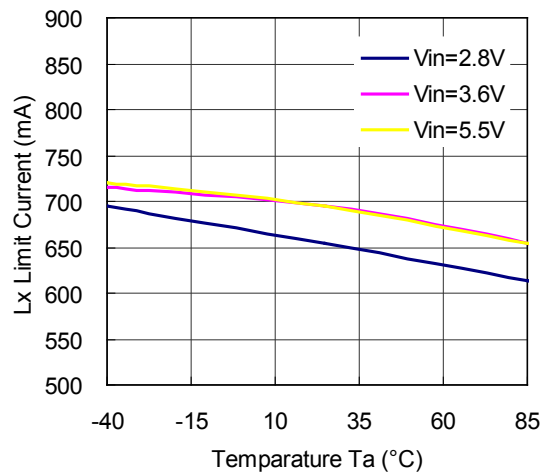

15) Oscillator Frequency vs. Temperature

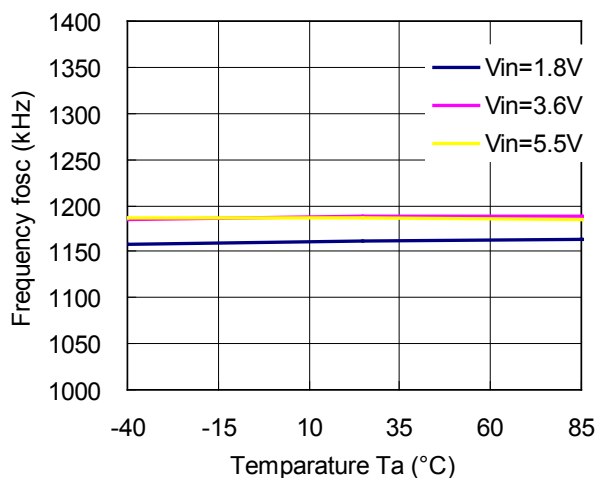

16) Maxduty vs. Temperature

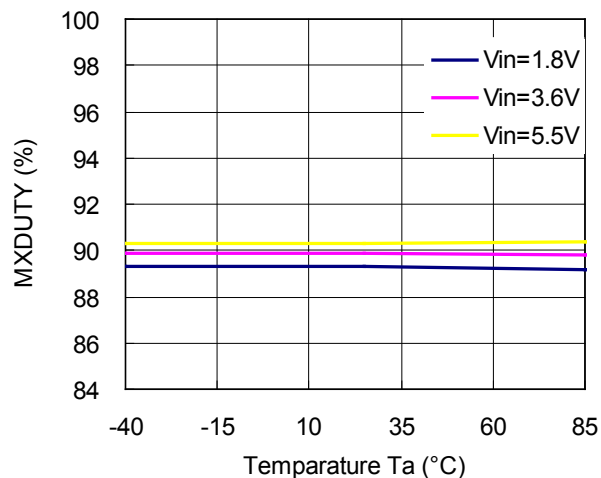

17) Thermal Shutdown Detect / Release Temperature vs. Input Voltage

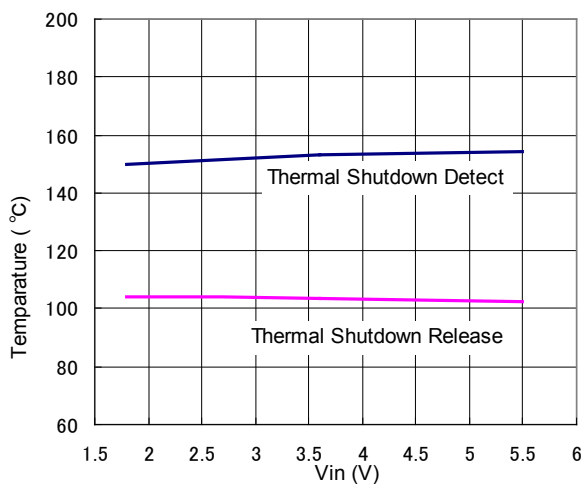



1. The products and the product specifications described in this document are subject to change or discontinuation of production without notice for reasons such as improvement. Therefore, before deciding to use the products, please refer to Ricoh sales representatives for the latest information thereon.
2. The materials in this document may not be copied or otherwise reproduced in whole or in part without prior written consent of Ricoh.
3. Please be sure to take any necessary formalities under relevant laws or regulations before exporting or otherwise taking out of your country the products or the technical information described herein.
4. The technical information described in this document shows typical characteristics of and example application circuits for the products. The release of such information is not to be construed as a warranty of or a grant of license under Ricoh's or any third party's intellectual property rights or any other rights.
5. The products listed in this document are intended and designed for use as general electronic components in standard applications (office equipment, telecommunication equipment, measuring instruments, consumer electronic products, amusement equipment etc.). Those customers intending to use a product in an application requiring extreme quality and reliability, for example, in a highly specific application where the failure or misoperation of the product could result in human injury or death (aircraft, spacevehicle, nuclear reactor control system, traffic control system, automotive and transportation equipment, combustion equipment, safety devices, life support system etc.) should first contact us.
6. We are making our continuous effort to improve the quality and reliability of our products, but semiconductor products are likely to fail with certain probability. In order to prevent any injury to persons or damages to property resulting from such failure, customers should be careful enough to incorporate safety measures in their design, such as redundancy feature, fire containment feature and fail-safe feature. We do not assume any liability or responsibility for any loss or damage arising from misuse or inappropriate use of the products.
7. Anti-radiation design is not implemented in the products described in this document.
8. Please contact Ricoh sales representatives should you have any questions or comments concerning the products or the technical information.



Ricoh is committed to reducing the environmental loading materials in electrical devices with a view to contributing to the protection of human health and the environment.

Ricoh has been providing RoHS compliant products since April 1, 2006 and Halogen-free products since April 1, 2012.

RICOH RICOH ELECTRONIC DEVICES CO., LTD.

<http://www.e-devices.ricoh.co.jp/en/>

Sales & Support Offices

RICOH ELECTRONIC DEVICES CO., LTD.

Higashi-Shinagawa Office (International Sales)
3-32-3, Higashi-Shinagawa, Shinagawa-ku, Tokyo 140-8655, Japan
Phone: +81-3-5479-2857 Fax: +81-3-5479-0502

RICOH EUROPE (NETHERLANDS) B.V.

Semiconductor Support Centre
Prof. W.H. Keesomlaan 1, 1183 DJ Amstelveen, The Netherlands
Phone: +31-20-5474-309

RICOH ELECTRONIC DEVICES KOREA CO., LTD.

3F, Haesung Bldg. 504, Teheran-ro, Gangnam-gu, Seoul, 135-725, Korea
Phone: +82-2-2135-5700 Fax: +82-2-2051-5713

RICOH ELECTRONIC DEVICES SHANGHAI CO., LTD.

Room 403, No.2 Building, No.690 Bibo Road, Pu Dong New District, Shanghai 201203,
People's Republic of China
Phone: +86-21-5027-3200 Fax: +86-21-5027-3299

RICOH ELECTRONIC DEVICES CO., LTD.

Taipei office
Room 109, 10F-1, No.51, Hengyang Rd., Taipei City, Taiwan (R.O.C.)
Phone: +886-2-2313-1621/1622 Fax: +886-2-2313-1623

Mouser Electronics

Authorized Distributor

Click to View Pricing, Inventory, Delivery & Lifecycle Information:

[Ricoh Electronics:](#)

[R1205L821A-TR](#)

Компания «Океан Электроники» предлагает заключение долгосрочных отношений при поставках импортных электронных компонентов на взаимовыгодных условиях!

Наши преимущества:

- Поставка оригинальных импортных электронных компонентов напрямую с производств Америки, Европы и Азии, а так же с крупнейших складов мира;
- Широкая линейка поставок активных и пассивных импортных электронных компонентов (более 30 млн. наименований);
- Поставка сложных, дефицитных, либо снятых с производства позиций;
- Оперативные сроки поставки под заказ (от 5 рабочих дней);
- Экспресс доставка в любую точку России;
- Помощь Конструкторского Отдела и консультации квалифицированных инженеров;
- Техническая поддержка проекта, помощь в подборе аналогов, поставка прототипов;
- Поставка электронных компонентов под контролем ВП;
- Система менеджмента качества сертифицирована по Международному стандарту ISO 9001;
- При необходимости вся продукция военного и аэрокосмического назначения проходит испытания и сертификацию в лаборатории (по согласованию с заказчиком);
- Поставка специализированных компонентов военного и аэрокосмического уровня качества (Xilinx, Altera, Analog Devices, Intersil, Interpoint, Microsemi, Actel, Aeroflex, Peregrine, VPT, Syfer, Eurofarad, Texas Instruments, MS Kennedy, Miteq, Cobham, E2V, MA-COM, Hittite, Mini-Circuits, General Dynamics и др.);

Компания «Океан Электроники» является официальным дистрибьютором и эксклюзивным представителем в России одного из крупнейших производителей разъемов военного и аэрокосмического назначения «JONHON», а так же официальным дистрибьютором и эксклюзивным представителем в России производителя высокотехнологичных и надежных решений для передачи СВЧ сигналов «FORSTAR».



JONHON

«JONHON» (основан в 1970 г.)

Разъемы специального, военного и аэрокосмического назначения:

(Применяются в военной, авиационной, аэрокосмической, морской, железнодорожной, горно- и нефтедобывающей отраслях промышленности)

«FORSTAR» (основан в 1998 г.)

ВЧ соединители, коаксиальные кабели,
кабельные сборки и микроволновые компоненты:

(Применяются в телекоммуникациях гражданского и специального назначения, в средствах связи, РЛС, а так же военной, авиационной и аэрокосмической отраслях промышленности).



Телефон: 8 (812) 309-75-97 (многоканальный)

Факс: 8 (812) 320-03-32

Электронная почта: ocean@oceanchips.ru

Web: <http://oceanchips.ru/>

Адрес: 198099, г. Санкт-Петербург, ул. Калинина, д. 2, корп. 4, лит. А