

**Description**

AH375 is an integrated Hall-Effect latched sensor designed for electronic commutation of brush-less DC motor applications. The device includes an on-chip Hall voltage generator for magnetic sensing, a comparator that amplifies the Hall voltage, and a Schmitt trigger to provide switching hysteresis for noise rejection, and open drain output. An internal band-gap regulator provides a temperature compensated supply voltage for internal circuits and allows a wide operating supply range.

When the magnetic flux density (**B**) is larger than operate point (**Bop**), output is switched on (OUT pin is pulled low). The output state is held on until a magnetic flux density reversal falls below Brp. When **B** is less than Brp, the output is switched off.

The AH375 is available in SIP-3L and SC59 packages.

**Features**

- Bipolar Hall-Effect latch sensor
- 2.2V to 20V DC Operating voltage
- Temperature compensation
- Open drain pre-driver
- 25mA maximum output sink current
- Operating temperature: -40°C to +125°C
- SIP-3L and SC59 packages  
(SC59 is commonly known as SOT23 in Asia)
- Green Molding Compound (No Br, Sb) (Note 1)

Notes: 1. EU Directive 2002/95/EC (RoHS). All applicable RoHS exemptions applied. Please visit our website at [http://www.diodes.com/products/lead\\_free.html](http://www.diodes.com/products/lead_free.html).

**Pin Assignments**

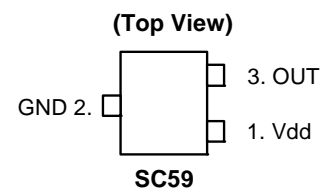
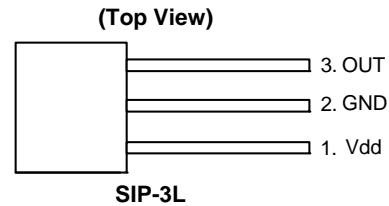

**Applications**

- Brush-Less DC Motor
- Brush-Less DC Fan
- Revolution Counting
- Speed Measurement

**Typical Application Circuit**

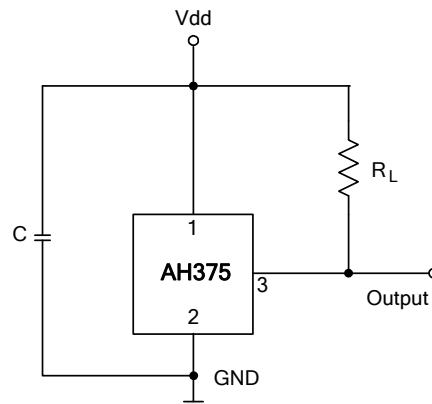

### Pin Descriptions

Pin Name	P/I/O	Pin #	Description
Vdd	P	1	Positive Power Supply
GND	P	2	Ground
OUT	O	3	Output Pin

### Functional Block Diagram

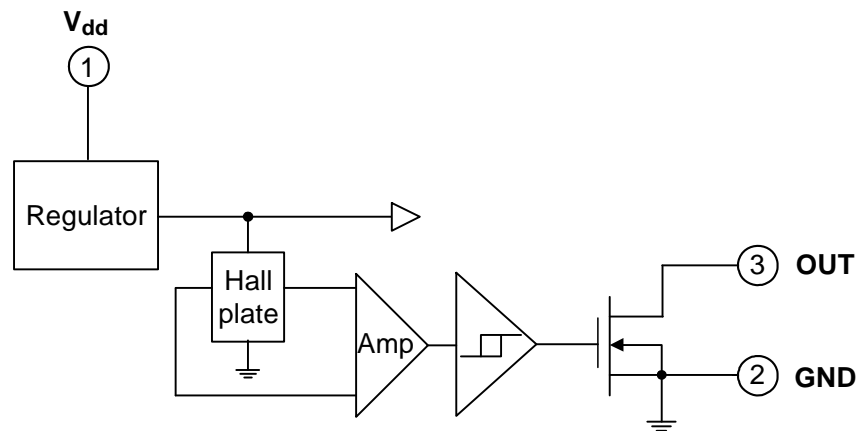

### Absolute Maximum Ratings (T<sub>A</sub> = 25°C)

Symbol	Characteristics	Values	Unit	
V <sub>DD</sub>	Supply Voltage	20	V	
B	Magnetic Flux Density	Unlimited		
V <sub>DS</sub>	Output OFF Voltage	30	V	
I <sub>D</sub>	Output "On" Current	Continuous	25 mA	
T <sub>S</sub>	Storage Temperature Range	-65~+150	°C	
T <sub>J(MAX)</sub>	Maximum Junction Temperature	150	°C	
P <sub>D</sub>	Package Power Dissipation	SIP-3L	550	mW
		SC59	230	
θ <sub>JC</sub>	Thermal Resistance	SIP-3L	227	°C/W
		SC59	543	

### Recommended Operating Conditions

Symbol	Parameter	Conditions	Min	Max	Unit
V <sub>DD</sub>	Supply Voltage (Note 2)	Operating	2.2	20	V
T <sub>A</sub>	Operating Ambient Temperature	Operating	-40	125	°C

Notes: 2. The output of IC will be switched after the supply voltage is over 2.2V, but the magnetic characteristics won't be normal until the supply is over 2.5V.

**Electrical Characteristics ( $T_A = 25\text{ }^\circ\text{C}$ ,  $V_{DD} = 12\text{V}$ )**

Symbol	Characteristic	Test Conditions	Min	Typ.	Max	Unit
$V_{DS(SAT)}$	Output Saturation Voltage	$I_{out} = 20\text{mA}$	-	300	700	mV
$I_{off}$	Output Leakage Current	$V_{DD} = 14\text{V}$	-	<0.1	10	$\mu\text{A}$
$I_{DD}$	Supply Current	Output Open	-	2	4	mA

**Magnetic Characteristics ( $T_A = 25\text{ }^\circ\text{C}$ ,  $V_{DD} = 2.5\text{V to } 20\text{V}$ , Note 3)**

(1mT = 10 Gauss)

Symbol	Parameter	Min	Typ.	Max	Unit
Bops(south pole to brand side)	Operation Point	5	30	60	Gauss
Brps(south pole to brand side)	Release Point	-60	-30	-5	Gauss
$B_{hy}( B_{opx}  -  B_{rpx} )$	Hysteresis	-	60	-	Gauss

Notes: 3. Magnetic characteristics may vary with supply voltage, operating temperature and after soldering.

**Operating Characteristics**

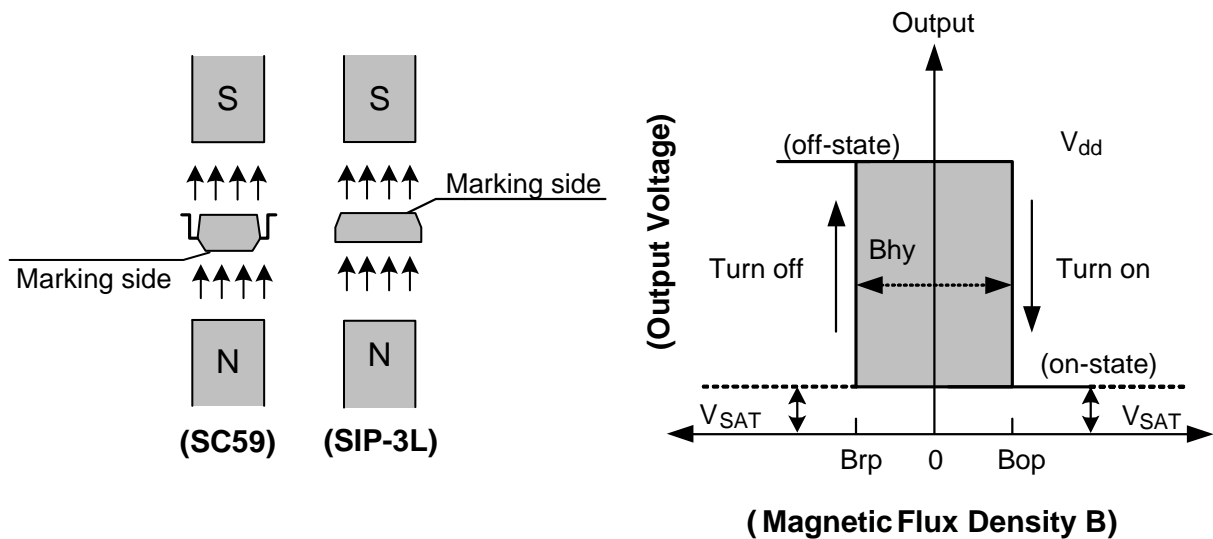

**Performance Characteristics**

**(1) SIP-3L**

<b>T<sub>A</sub> (°C)</b>	<b>25</b>	<b>50</b>	<b>60</b>	<b>70</b>	<b>80</b>	<b>85</b>	<b>90</b>	<b>95</b>	<b>100</b>
P <sub>D</sub> (mW)	550	440	396	352	308	286	264	242	220
<b>T<sub>A</sub> (°C)</b>	<b>105</b>	<b>110</b>	<b>115</b>	<b>120</b>	<b>125</b>	<b>130</b>	<b>135</b>	<b>140</b>	<b>150</b>
P <sub>D</sub> (mW)	198	176	154	132	110	88	66	44	0

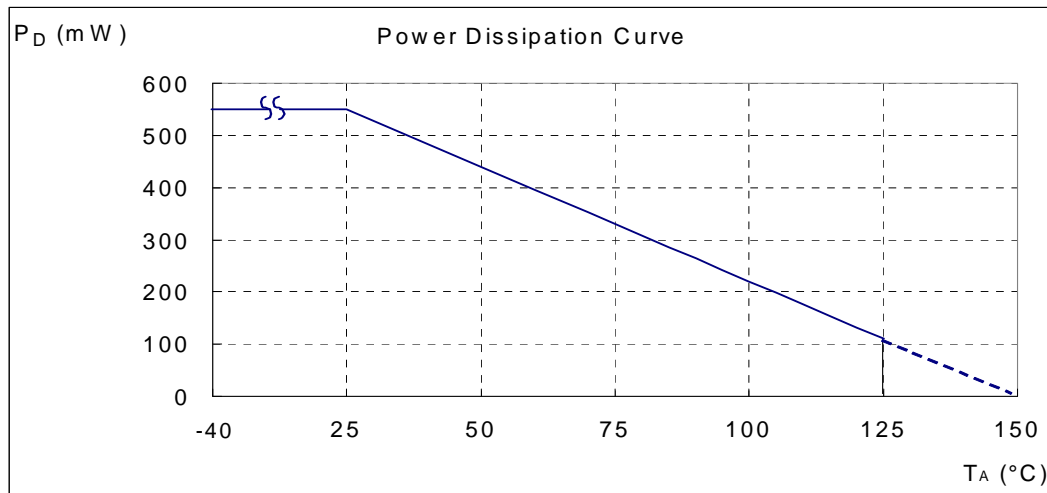





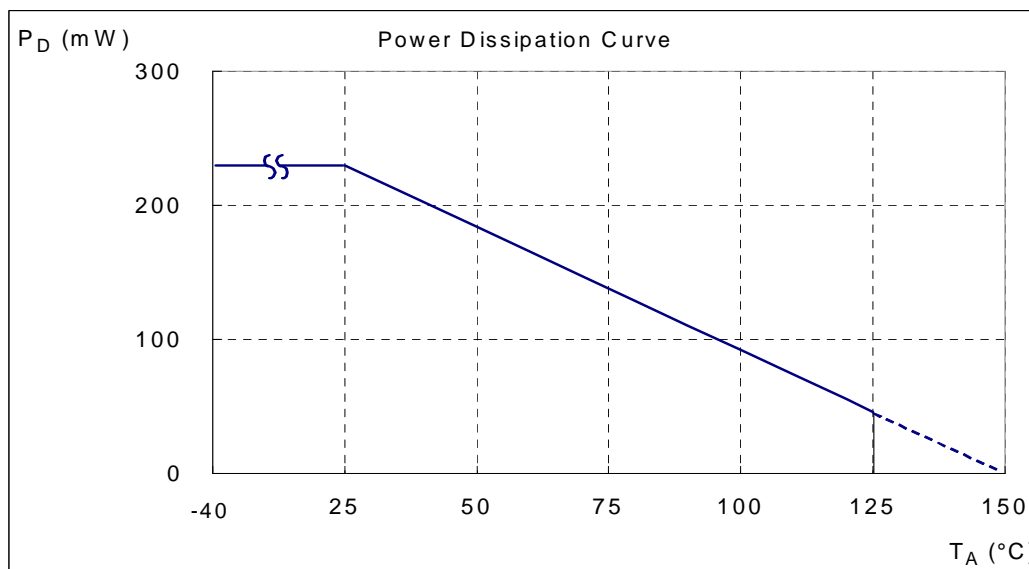

**(2) SC59 (commonly known as SOT23 in Asia)**

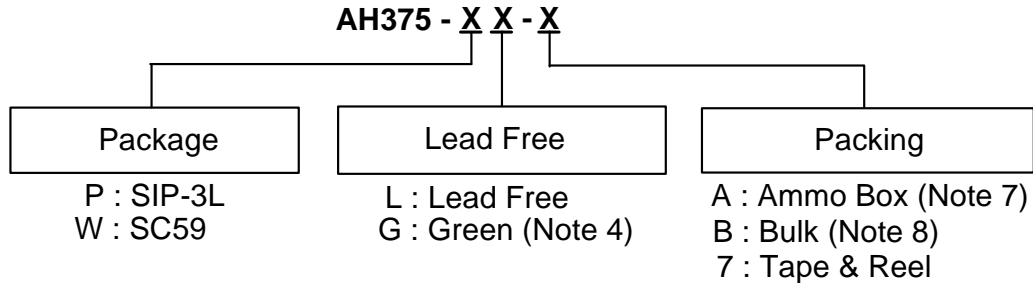
<b>T<sub>A</sub> (°C)</b>	<b>25</b>	<b>50</b>	<b>60</b>	<b>70</b>	<b>80</b>	<b>85</b>	<b>90</b>	<b>100</b>	<b>110</b>	<b>120</b>	<b>130</b>	<b>140</b>	<b>150</b>
P <sub>D</sub> (mW)	230	184	166	147	129	120	110	92	74	55	37	18	0



### Ordering Information



Device	Package Code	Packaging (Note 5, 6)	Bulk		7" Tape and Reel		Ammo Box	
			Quantity	Part Number Suffix	Quantity	Part Number Suffix	Quantity	Part Number Suffix
 AH375-PL-A	P	SIP-3L	NA	NA	NA	NA	4000/Box	-A
 AH375-PL-B	P	SIP-3L	1000	-B	NA	NA	NA	NA
 AH375-PG-A	P	SIP-3L	NA	NA	NA	NA	4000/Box	-A
 AH375-PG-B	P	SIP-3L	1000	-B	NA	NA	NA	NA
 AH375-WL-7	W	SC59	NA	NA	3000/Tape & Reel	-7	NA	NA
 AH375-WG-7	W	SC59	NA	NA	3000/Tape & Reel	-7	NA	NA

- Notes:
4. EU Directive 2002/95/EC (RoHS). All applicable RoHS exemptions applied. Please visit our website at [http://www.diodes.com/products/lead\\_free.html](http://www.diodes.com/products/lead_free.html).
  5. Pad layout as shown on Diodes Inc. suggested pad layout document AP02001, which can be found on our website at <http://www.diodes.com/datasheets/ap02001.pdf>.
  6. Reverse taping as shown on Diodes Inc. Surface Mount (SMD) Packaging document AP02007, which can be found on our website <http://www.diodes.com/datasheets/ap02007.pdf>.
  7. Ammo Box is for SIP-3L Spread Lead.
  8. Bulk is for SIP-3L Straight Lead.

**Marking Information**

**(1) SIP-3L**

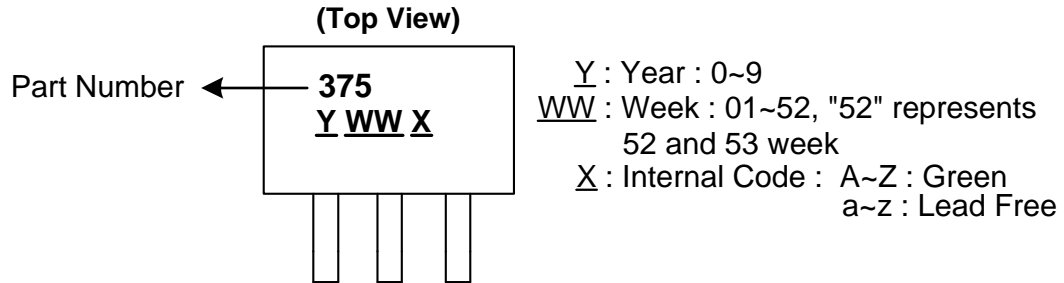

**(2) SC59 (Commonly known as SOT23 in Asia)**

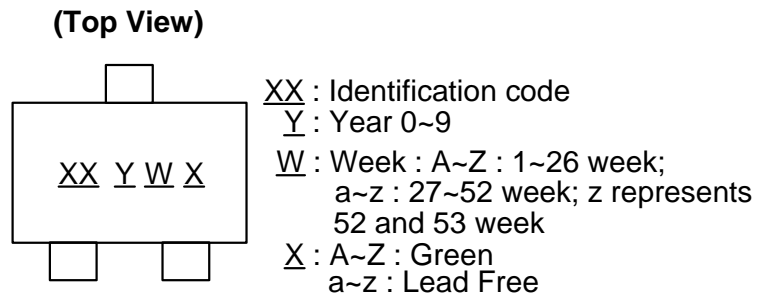

Part Number	Package	Identification Code
AH375	SC59	P3

**Package Outline Dimensions (All Dimensions in mm)**

**(1) Package Type: SIP-3L for Bulk pack**

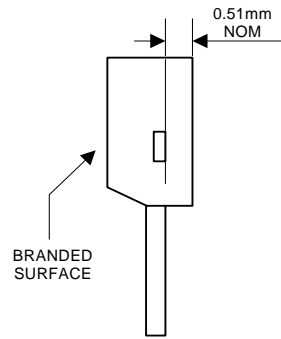

Active Area Depth

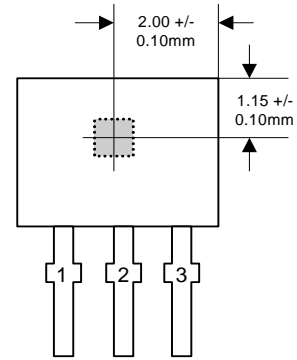

Sensor Location

**Package Dimension**

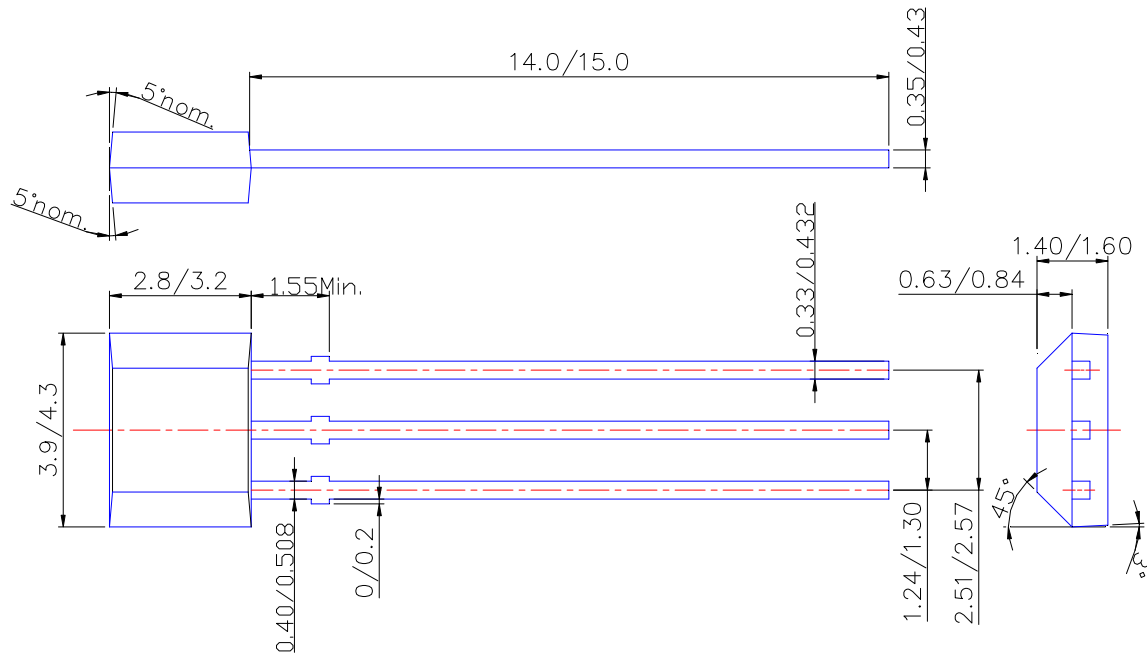





**IMPORTANT NOTICE**

DIODES INCORPORATED MAKES NO WARRANTY OF ANY KIND, EXPRESS OR IMPLIED, WITH REGARDS TO THIS DOCUMENT, INCLUDING, BUT NOT LIMITED TO, THE IMPLIED WARRANTIES OF MERCHANTABILITY AND FITNESS FOR A PARTICULAR PURPOSE (AND THEIR EQUIVALENTS UNDER THE LAWS OF ANY JURISDICTION).

Diodes Incorporated and its subsidiaries reserve the right to make modifications, enhancements, improvements, corrections or other changes without further notice to this document and any product described herein. Diodes Incorporated does not assume any liability arising out of the application or use of this document or any product described herein; neither does Diodes Incorporated convey any license under its patent or trademark rights, nor the rights of others. Any Customer or user of this document or products described herein in such applications shall assume all risks of such use and will agree to hold Diodes Incorporated and all the companies whose products are represented on Diodes Incorporated website, harmless against all damages.

Diodes Incorporated does not warrant or accept any liability whatsoever in respect of any products purchased through unauthorized sales channel.

Should Customers purchase or use Diodes Incorporated products for any unintended or unauthorized application, Customers shall indemnify and hold Diodes Incorporated and its representatives harmless against all claims, damages, expenses, and attorney fees arising out of, directly or indirectly, any claim of personal injury or death associated with such unintended or unauthorized application.

Products described herein may be covered by one or more United States, international or foreign patents pending. Product names and markings noted herein may also be covered by one or more United States, international or foreign trademarks.

**LIFE SUPPORT**

Diodes Incorporated products are specifically not authorized for use as critical components in life support devices or systems without the express written approval of the Chief Executive Officer of Diodes Incorporated. As used herein:

A. Life support devices or systems are devices or systems which:

1. are intended to implant into the body, or
2. support or sustain life and whose failure to perform when properly used in accordance with instructions for use provided in the labeling can be reasonably expected to result in significant injury to the user.

B. A critical component is any component in a life support device or system whose failure to perform can be reasonably expected to cause the failure of the life support device or to affect its safety or effectiveness.

Customers represent that they have all necessary expertise in the safety and regulatory ramifications of their life support devices or systems, and acknowledge and agree that they are solely responsible for all legal, regulatory and safety-related requirements concerning their products and any use of Diodes Incorporated products in such safety-critical, life support devices or systems, notwithstanding any devices- or systems-related information or support that may be provided by Diodes Incorporated. Further, Customers must fully indemnify Diodes Incorporated and its representatives against any damages arising out of the use of Diodes Incorporated products in such safety-critical, life support devices or systems.

Copyright © 2010, Diodes Incorporated

[www.diodes.com](http://www.diodes.com)

Компания «Океан Электроники» предлагает заключение долгосрочных отношений при поставках импортных электронных компонентов на взаимовыгодных условиях!

Наши преимущества:

- Поставка оригинальных импортных электронных компонентов напрямую с производств Америки, Европы и Азии, а так же с крупнейших складов мира;
- Широкая линейка поставок активных и пассивных импортных электронных компонентов (более 30 млн. наименований);
- Поставка сложных, дефицитных, либо снятых с производства позиций;
- Оперативные сроки поставки под заказ (от 5 рабочих дней);
- Экспресс доставка в любую точку России;
- Помощь Конструкторского Отдела и консультации квалифицированных инженеров;
- Техническая поддержка проекта, помощь в подборе аналогов, поставка прототипов;
- Поставка электронных компонентов под контролем ВП;
- Система менеджмента качества сертифицирована по Международному стандарту ISO 9001;
- При необходимости вся продукция военного и аэрокосмического назначения проходит испытания и сертификацию в лаборатории (по согласованию с заказчиком);
- Поставка специализированных компонентов военного и аэрокосмического уровня качества (Xilinx, Altera, Analog Devices, Intersil, Interpoint, Microsemi, Actel, Aeroflex, Peregrine, VPT, Syfer, Eurofarad, Texas Instruments, MS Kennedy, Miteq, Cobham, E2V, MA-COM, Hittite, Mini-Circuits, General Dynamics и др.);

Компания «Океан Электроники» является официальным дистрибьютором и эксклюзивным представителем в России одного из крупнейших производителей разъемов военного и аэрокосмического назначения «JONHON», а так же официальным дистрибьютором и эксклюзивным представителем в России производителя высокотехнологичных и надежных решений для передачи СВЧ сигналов «FORSTAR».



## JONHON

«JONHON» (основан в 1970 г.)

Разъемы специального, военного и аэрокосмического назначения:

(Применяются в военной, авиационной, аэрокосмической, морской, железнодорожной, горно- и нефтедобывающей отраслях промышленности)

«FORSTAR» (основан в 1998 г.)

ВЧ соединители, коаксиальные кабели, кабельные сборки и микроволновые компоненты:

(Применяются в телекоммуникациях гражданского и специального назначения, в средствах связи, РЛС, а так же военной, авиационной и аэрокосмической отраслях промышленности).



Телефон: 8 (812) 309-75-97 (многоканальный)

Факс: 8 (812) 320-03-32

Электронная почта: [ocean@oceanchips.ru](mailto:ocean@oceanchips.ru)

Web: <http://oceanchips.ru/>

Адрес: 198099, г. Санкт-Петербург, ул. Калинина, д. 2, корп. 4, лит. А