

AC and Pulse Metallized Polypropylene Film Capacitors MKP Axial Type

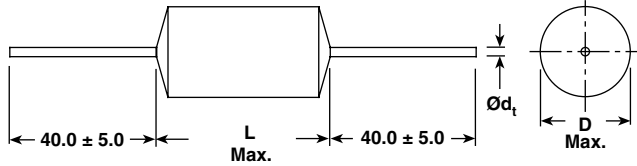

LEAD DIAMETER d_t (mm)	D (mm)	L (mm)
0.6 ± 0.06	≤ 9.0	≤ 19.0
0.8 ± 0.08	< 16.5	> 26.5
1.0 ± 0.1	> 16.5	> 26.5

APPLICATIONS

Pulse operations, SMPS and thyristor circuits, storage, filter, timing and sample and hold circuits.

REFERENCE STANDARDS

IEC 60384-16

MARKING

C-value; tolerance; rated voltage; manufacturer's type; code for dielectric material; manufacturer location; manufacturer's logo; year and week

DIELECTRIC

Polypropylene film

ELECTRODES

Metallized

CONSTRUCTION

Mono construction

RATED (DC) VOLTAGE

160 V, 250 V, 400 V, 630 V

RATED (AC) VOLTAGE

100 V, 160 V, 220 V, 250 V

FEATURES

Supplied loose in box, taped on ammpack or reel
RoHS compliant



ENCAPSULATION

Plastic-wrapped, epoxy resin sealed. Flame retardant.



RoHS
COMPLIANT

CLIMATIC TESTING CLASS ACC. TO IEC 60068-1

55/100/56

CAPACITANCE RANGE (E12 SERIES)

47 pF to 22 μ F

CAPACITANCE TOLERANCE

$\pm 10 \%$, $\pm 5 \%$, $\pm 2.5 \%$, $\pm 2 \%$, $\pm 1 \%$

LEADS

Tinned wire

MAXIMUM APPLICATION TEMPERATURE

100 °C

PULL TEST ON LEADS

≥ 20 N in direction of leads according to IEC 60068-2-21

BENT TEST ON LEADS

2 bends trough 90° with half of the force used in pull test

DETAIL SPECIFICATION

For more detailed data and test requirements contact:
dc-film@vishay.com



COMPOSITION OF CATALOG NUMBER

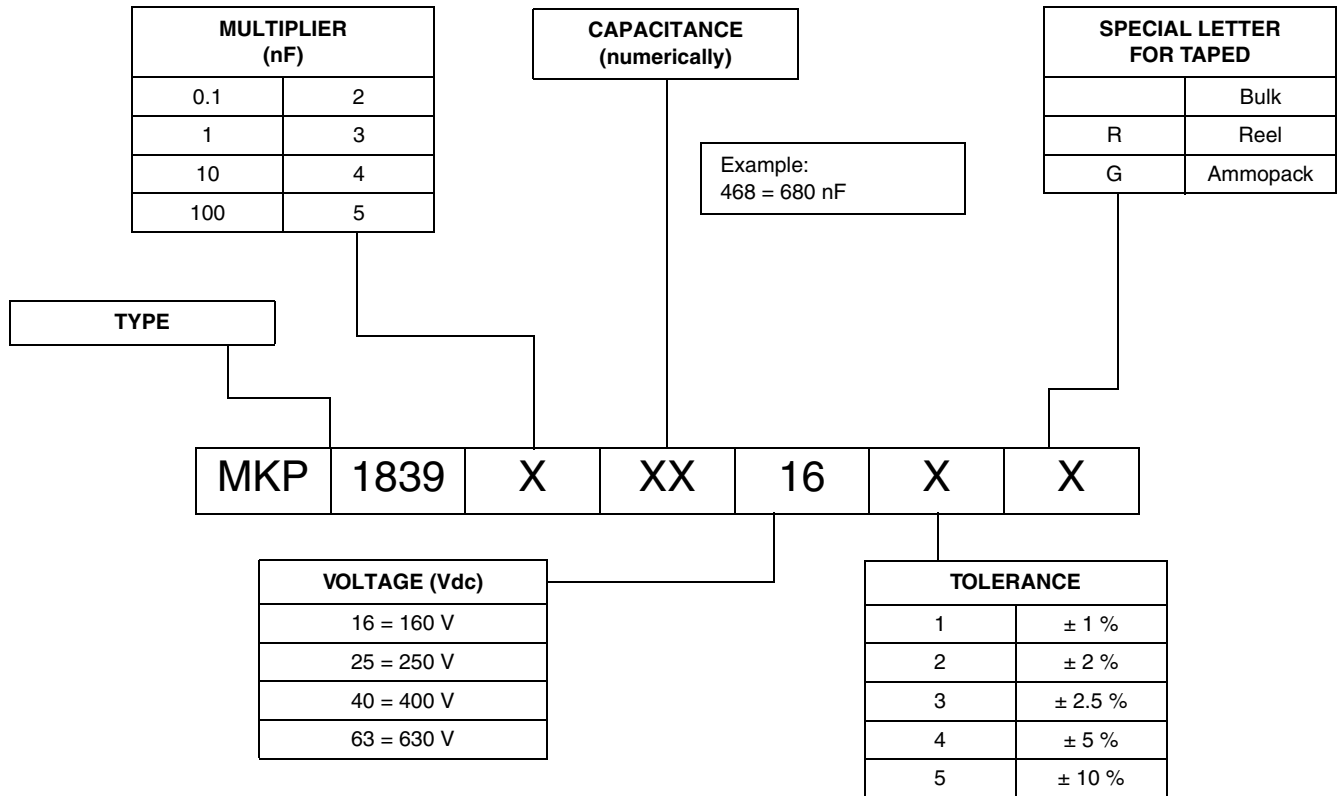

Note

(1) For detailed tape specifications refer to "Packaging Information": www.vishay.com/doc?28139 or end of catalog

SPECIFIC REFERENCE DATA

DESCRIPTION	VALUE			
	at 1 kHz	at 10 kHz	at 100 kHz	
Tangent of loss angle:				
$C \leq 0.1 \mu\text{F}$	4×10^{-4}	6×10^{-4}	40×10^{-4}	
$0.1 \mu\text{F} < C \leq 1.0 \mu\text{F}$	4×10^{-4}	6×10^{-4}	-	
$C > 1.0 \mu\text{F}$	10×10^{-4}	-	-	
Capacitor length (mm)	Maximum pulse rise time (dU/dt) _R [V/μs]			
	160 Vdc	250 Vdc	400 Vdc	630 Vdc
11	240	300	515	700
14	175	220	380	510
19	100	125	200	280
26.5	60	75	120	160
31.5	45	60	95	120
41.5	30	40	65	85
If the maximum pulse voltage is less than the rated voltage higher dU/dt values can be permitted.				
R between leads, for $C \leq 0.33 \mu\text{F}$ at 100 V, 1 min	> 100 000 MΩ			
RC between leads, for $C > 0.33 \mu\text{F}$ at 100 V, 1 min	> 30 000 s			
R between leads and case, 100 V, 1 min	> 30 000 MΩ			
Withstanding (DC) voltage between leads and wrapped film ($1.4 \times U_{\text{Rac}} + 2000$)	2840 V, 1 min			
Withstanding (DC) voltage (cut off current 10 mA), rise time 100 V/s	$1.6 \times U_{\text{Rdc}}$, 1 min			
Maximum application temperature	100 °C			

CAPACITANCE	CAPACITANCE CODE	VOLTAGE CODE 16 160 Vdc/100Vac		VOLTAGE CODE 25 250 Vdc/160Vac		VOLTAGE CODE 40 400 Vdc/220Vac ⁽¹⁾		VOLTAGE CODE 63 630 Vdc/250Vac ⁽¹⁾	
		D (mm)	L (mm)	D (mm)	L (mm)	D (mm)	L (mm)	D (mm)	L (mm)
47 pF	047	-	-	-	-	-	-	5.0	11.0
51 pF	051	-	-	-	-	-	-	5.0	11.0
56 pF	056	-	-	-	-	-	-	5.0	11.0
62 pF	056	-	-	-	-	-	-	5.0	11.0
68 pF	068	-	-	-	-	-	-	5.5	11.0
75 pF	075	-	-	-	-	-	-	5.5	11.0
82 pF	082	-	-	-	-	-	-	5.5	11.0
91 pF	091	-	-	-	-	-	-	6.0	11.0
100 pF	110	-	-	-	-	-	-	6.0	11.0
110 pF	111	-	-	-	-	-	-	6.0	11.0
120 pF	112	-	-	-	-	-	-	6.0	11.0
130 pF	113	-	-	-	-	-	-	6.0	11.0
150 pF	115	-	-	-	-	-	-	6.0	11.0
160 pF	116	-	-	-	-	-	-	6.0	11.0
180 pF	118	-	-	-	-	-	-	6.0	11.0
200 pF	120	-	-	-	-	-	-	6.0	11.0
220 pF	122	-	-	-	-	-	-	5.0	11.0
240 pF	124	-	-	-	-	-	-	5.0	11.0
270 pF	127	-	-	-	-	-	-	5.0	11.0
300 pF	130	-	-	-	-	-	-	5.0	11.0
330 pF	133	-	-	-	-	-	-	5.0	11.0
360 pF	136	-	-	-	-	-	-	5.0	11.0
390 pF	139	-	-	-	-	-	-	5.0	11.0
430 pF	143	-	-	-	-	-	-	5.0	11.0
470 pF	147	-	-	-	-	-	-	5.0	11.0
510 pF	151	-	-	-	-	-	-	5.0	11.0
560 pF	156	-	-	-	-	-	-	5.5	11.0
620 pF	162	-	-	-	-	-	-	5.5	11.0
680 pF	168	-	-	-	-	-	-	5.5	11.0
750 pF	175	-	-	-	-	-	-	5.5	11.0
820 pF	182	-	-	-	-	-	-	5.0	11.0
910 pF	191	-	-	-	-	-	-	5.0	11.0
1000 pF	210	-	-	-	-	-	-	5.0	11.0
1100 pF	211	-	-	-	-	-	-	5.0	11.0
1200 pF	212	-	-	-	-	-	-	5.0	11.0
1300 pF	213	-	-	-	-	-	-	5.0	11.0
1500 pF	215	-	-	-	-	-	-	5.0	11.0
1600 pF	216	-	-	-	-	-	-	5.0	11.0
1800 pF	218	-	-	-	-	-	-	5.0	11.0
2000 pF	220	-	-	-	-	-	-	5.0	11.0
2200 pF	222	-	-	-	-	-	-	5.0	11.0
2400 pF	224	-	-	-	-	-	-	5.0	11.0
2700 pF	227	-	-	-	-	-	-	5.0	11.0
3000 pF	230	-	-	-	-	-	-	5.0	11.0
3300 pF	233	-	-	-	-	-	-	5.0	11.0
3600 pF	236	-	-	-	-	-	-	5.0	11.0
3900 pF	239	-	-	-	-	-	-	5.0	11.0
4300 pF	243	-	-	-	-	-	-	5.0	11.0
4700 pF	247	-	-	-	-	-	-	5.0	11.0
6200 pF	262	-	-	-	-	-	-	5.5	11.0
6800 pF	268	-	-	-	-	5.0	11.0	5.5	11.0



**AC and Pulse Metallized Polypropylene Film Capacitors Vishay Roederstein
MKP Axial Type**

CAPACITANCE	CAPACITANCE CODE	VOLTAGE CODE 16 160 Vdc/100Vac		VOLTAGE CODE 25 250 Vdc/160Vac		VOLTAGE CODE 40 400 Vdc/220Vac ⁽¹⁾		VOLTAGE CODE 63 630 Vdc/250Vac ⁽¹⁾	
		D (mm)	L (mm)	D (mm)	L (mm)	D (mm)	L (mm)	D (mm)	L (mm)
8200 pF	282	-	-	-	-	5.0	11.0	6.0	11
0.01 μF	310	-	-	5.0	11.0	5.5	11.0	5.5	14.0
0.015 μF	315	-	-	5.0	11.0	6.0	11.0	6.5	14.0
0.022 μF	322	-	-	5.0	11.0	6.5	14.0	7.5	14.0
0.033 μF	333	5.0	11.0	5.5	11.0	7.0	14.0	7.0	19.0
0.047 μF	347	5.5	11.0	6.0	14.0	8.0	14.0	8.0	19.0
0.068 μF	368	6.0	11.0	6.5	14.0	8.5	19.0	9.0	19.0
0.1 μF	410	6.5	14.0	7.5	14.0	9.0	19.0	8.5	26.5
0.15 μF	415	7.5	14.0	7.0	19.0	8.0	26.5	10.5	26.5
0.22 μF	422	7.0	19.0	8.5	19.0	9.5	26.5	12.0	26.5
0.33 μF	433	8.0	19.0	8.0	26.5	11.5	26.5	14.5	26.5
0.47 μF	447	9.0	19.0	9.0	26.5	13.5	26.5	15.0	31.5
0.68 μF	468	8.5	26.5	11.0	26.5	14.0	31.5	18.0	31.5
1.0 μF	510	10.5	26.5	12.5	26.5	17.0	31.5	18.0	41.5
1.5 μF	515	12.0	26.5	13.0	31.5	20.5	31.5	22.0	41.5
2.2 μF	522	13.0	31.5	16.0	31.5	21.0	41.5	-	-
3.3 μF	533	15.5	31.5	19.0	31.5	-	-	-	-
4.7 μF	547	15.5	41.5	19.5	41.5	-	-	-	-
6.8 μF	568	18.5	41.5	23.0	41.5	-	-	-	-
10 μF	610	22.0	41.5	22.0	41.5	-	-	-	-
15 μF	615	24.5	41.5	24.5	41.5	-	-	-	-
22 μF	622	28.5	41.5	28.5	41.5	-	-	-	-

Notes⁽¹⁾ Not suitable for mains applications

- Pitch = L + 3.5 mm

RECOMMENDED PACKAGING

PACKAGING CODE	TYPE OF PACKAGING	REEL DIAMETER (mm)	ORDERING CODE EXAMPLES	
G	Ammo	-	MKP 1839-422-403-G	x
R	Reel	350	MKP 1839-422-403-R	x
-	Bulk for L > 31.5 mm	-	MKP 1839-522-403	x

Note

- For detailed tape specifications refer to "Packaging Information": www.vishay.com/doc?28139

MOUNTING**Normal Use**

The capacitors are designed for mounting on printed-circuit boards. The capacitors packed in bandoliers are designed for mounting in printed-circuit boards by means of automatic insertion machines.

For detailed tape specifications refer to "Packaging Information": www.vishay.com/doc?28139

Specific Method of Mounting to Withstand Vibration and Shock

In order to withstand vibration and shock tests, it must be ensured that the capacitors body is in good contact with the printed-circuit board.

- For L < 19 mm capacitors shall be mechanically fixed by the leads
- For larger pitches the capacitors shall be mounted in the same way and the body clamped
- The maximum diameter and length of the capacitors are specified in the dimensions table
- Eccentricity as shown in the drawing on next page

Space Requirements on Printed-Circuit Board

The maximum length and width of film capacitors is shown in drawing:

- Eccentricity as in drawing. The maximum eccentricity is smaller than or equal to the lead diameter of the product concerned.
- Product height with seating plane as given by IEC 60717 as reference: $h_{max.} \leq h + 0.4 \text{ mm}$ or $h_{max.} \leq h' + 0.4 \text{ mm}$



Storage Temperature

- Storage temperature: $T_{stg} = -25 \text{ }^\circ\text{C}$ to $+40 \text{ }^\circ\text{C}$ with RH maximum 80 % without condensation

Ratings and Characteristics Reference Conditions

Unless otherwise specified, all electrical values apply to an ambient temperature of $23 \text{ }^\circ\text{C} \pm 1 \text{ }^\circ\text{C}$, an atmospheric pressure of 86 kPa to 106 kPa and a relative humidity of $50 \text{ } \pm 2 \text{ } \%$.

For reference testing, a conditioning period shall be applied over $96 \text{ h} \pm 4 \text{ h}$ by heating the products in a circulating air oven at the rated temperature and a relative humidity not exceeding 20 %.

CHARACTERISTICS

Max. RMS voltage as a function of frequency (typical curve)

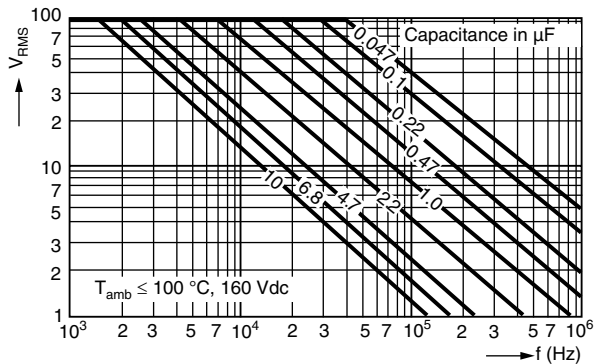

Max. RMS voltage as a function of frequency

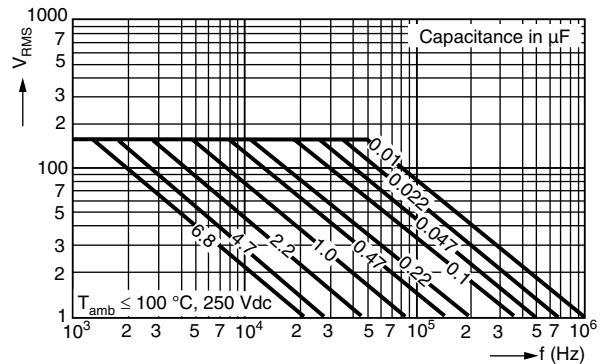

Max. RMS voltage as a function of frequency

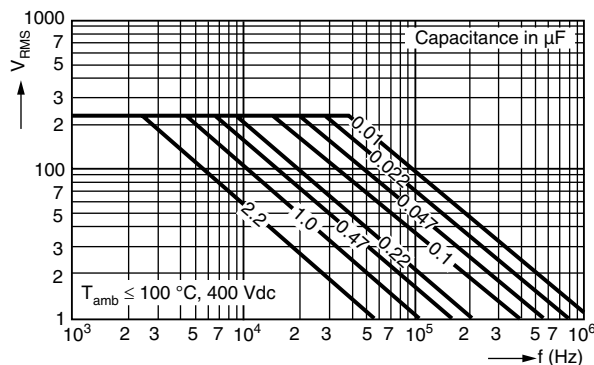

Max. RMS voltage as a function of frequency

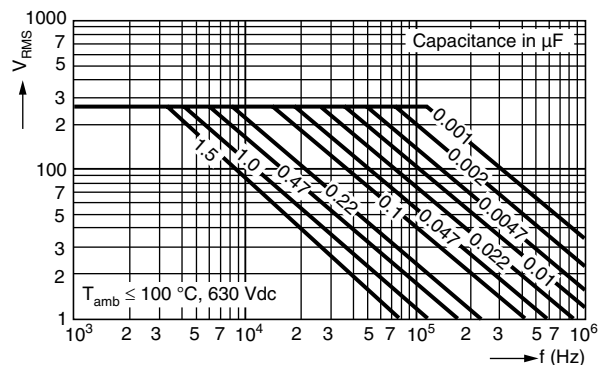

**AC and Pulse Metallized Polypropylene Film Capacitors Vishay Roederstein
MKP Axial Type****HEAT CONDUCTIVITY (G) AS A FUNCTION OF ORIGINAL PITCH AND CAPACITOR BODY THICKNESS IN mW/°C**

DIAMETER (mm)	HEAT CONDUCTIVITY (mW/°C)					
	L 11 mm	L 14 mm	L 19 mm	L 26.5 mm	L 31.5 mm	L 41.5 mm
5.0	2	3	4	5	6	8
5.5	3	3	4	6	7	9
6.0	3	4	5	7	8	10
6.5	3	4	5	7	9	11
7.0	4	5	6	8	9	12
7.5	4	5	7	9	10	13
8.0	4	5	7	10	11	15
8.5	5	6	8	10	12	16
9.0	5	6	8	11	13	17
9.5	6	7	9	12	14	18
10.0	6	7	10	13	15	19
10.5	7	8	10	14	16	20
11.0	7	8	11	14	17	21
11.5	8	9	12	15	18	23
12.0	8	10	12	16	19	24
12.5	9	10	13	17	20	25
13.0	9	11	14	18	21	26
13.5	10	11	14	19	22	28
14.0	10	12	15	20	23	29
14.5	11	13	16	21	24	30
15.0	11	13	16	21	25	31
15.5	12	14	17	22	26	33
16.0	12	14	18	23	27	34
16.5	13	15	19	24	28	35
17.0	14	16	20	25	29	37
17.5	14	17	20	26	30	38
18.0	15	17	21	27	31	39
18.5	15	18	22	28	32	41
19.0	16	19	23	29	34	42
19.5	17	19	24	30	35	43
20.0	17	20	25	31	36	45
20.5	18	21	25	32	37	46
21.0	19	22	26	33	38	48
21.5	20	22	27	35	39	49
22.0	20	23	28	36	41	50
22.5	21	24	29	37	42	52
23.0	22	25	30	38	43	53
23.5	23	26	31	39	44	55
24.0	23	27	32	40	46	56
24.5	24	27	33	41	47	58
25.0	25	28	34	42	48	59
25.5	26	29	35	44	49	61
26.0	27	30	36	45	51	62
26.5	27	31	37	46	52	64
27.0	28	32	38	47	53	66
27.5	29	33	39	48	55	67
28.0	30	34	40	50	56	69
28.5	31	35	41	51	57	70

POWER DISSIPATION AND MAXIMUM COMPONENT TEMPERATURE RISE

The power dissipation must be limited in order not to exceed the maximum allowed component temperature rise as a function of the free air ambient temperature.

The power dissipation can be calculated according type detail specification “HQN-384-01/101: Technical Information Film Capacitors with the typical tgδ of the curves”.

The component temperature rise (ΔT) can be measured (see section “Measuring the component temperature” for more details) or calculated by $\Delta T = P/G$:

- ΔT = Component temperature rise ($^{\circ}\text{C}$)
- P = Power dissipation of the component (mW)
- G = Heat conductivity of the component ($\text{mW}/^{\circ}\text{C}$)

MEASURING THE COMPONENT TEMPERATURE

A thermocouple must be attached to the capacitor body as in:

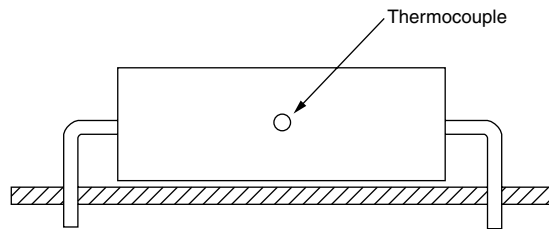

The temperature is measured in unloaded (T_{amb}) and maximum loaded condition (T_{C}).

The temperature rise is given by $\Delta T = T_{\text{C}} - T_{\text{amb}}$.

To avoid radiation or convection, the capacitor should be tested in a wind-free box.

APPLICATION NOTE AND LIMITING CONDITIONS

These capacitors are not suitable for mains applications as across-the-line capacitors without additional protection, as described hereunder. These mains applications are strictly regulated in safety standards and therefore electromagnetic interference suppression capacitors conforming the standards must be used.

To select the capacitor for a certain application, the following conditions must be checked:

1. The peak voltage (U_{P}) shall not be greater than the rated DC voltage (U_{Rdc})
2. The peak-to-peak voltage ($U_{\text{P-P}}$) shall not be greater than the maximum ($U_{\text{P-P}}$) to avoid the ionisation inception level
3. The voltage peak slope (dU/dt) shall not exceed the rated voltage pulse slope in an RC-circuit at rated voltage and without ringing. If the pulse voltage is lower than the rated DC voltage, the rated voltage pulse slope may be multiplied by U_{Rdc} and divided by the applied voltage.

For all other pulses following equation must be fulfilled:

$$2 \times \int_0^T \left(\frac{dU}{dt} \right)^2 \times dt < U_{\text{Rdc}} \times \left(\frac{dU}{dt} \right)_{\text{rated}}$$

T is the pulse duration.

4. The maximum component surface temperature rise must be lower than the limits (see graph max. allowed component temperature rise).
5. Since in circuits used at voltages over 280 V peak-to-peak the risk for an intrinsically active flammability after a capacitor breakdown (short circuit) increases, it is recommended that the power to the component is limited to 100 times the values mentioned in the table: “Heat conductivity”
6. When using these capacitors as across-the-line capacitor in the input filter for mains applications or as series connected with an impedance to the mains the applicant must guarantee that the following conditions are fulfilled in any case (spikes and surge voltages from the mains included).



Voltage Conditions for 6 Above

ALLOWED VOLTAGES	$T_{amb} \leq 85\text{ °C}$	$85\text{ °C} < T_{amb} \leq 100\text{ °C}$
Maximum continuous RMS voltage	U_{Rac}	U_{Rac}
Maximum temperature RMS-overvoltage (< 24 h)	$1.25 \times U_{Rac}$	$1.25 \times U_{Rac}$
Maximum peak voltage (V_{O-P}) (< 2 s)	$1.6 \times U_{Rdc}$	$1.1 \times U_{Rdc}$

INSPECTION REQUIREMENTS

General Notes:

Sub-clause numbers of tests and performance requirements refer to the “Sectional Specification, Publication IEC 60384-16 and Specific Reference Data”.

Group C Inspection Requirements

SUB-CLAUSE NUMBER AND TEST	CONDITIONS	PERFORMANCE REQUIREMENTS
SUB-GROUP C1A PART OF SAMPLE OF SUB-GROUP C1		
4.1 Dimensions (detail)		As specified in chapter “General Data” of this specification
4.3.1 Initial measurements	Capacitance Tangent of loss angle at 100 kHz	No visible damage
4.3 Robustness of terminations	Tensile and bending	
4.4 Resistance to soldering heat	Method: 1A Solder bath: $280\text{ °C} \pm 5\text{ °C}$ Duration: 5 s	
4.14 Component solvent resistance	Isopropylalcohol at room temperature Method: 2 Immersion time: $5 \pm 0.5\text{ min}$ Recovery time: Min. 1 h, max. 2 h	
4.4.2 Final measurements	Visual examination Capacitance Tangent of loss angle	
SUB-GROUP C1B OTHER PART OF SAMPLE OF SUB-GROUP C1		
4.6.1 Initial measurements	Capacitance Tangent of loss angle: For $C \leq 1\text{ }\mu\text{F}$ at 10 kHz For $C > 1\text{ }\mu\text{F}$ at 1 kHz	No visible damage Legible marking
4.15 Solvent resistance of the marking	Isopropylalcohol at room temperature Method: 1 Rubbing material: Cotton wool Immersion time: $5 \pm 0.5\text{ min}$	
4.6 Rapid change of temperature	θA = Lower category temperature θB = Upper category temperature 5 cycles Duration $t = 30\text{ min}$	



SUB-CLAUSE NUMBER AND TEST	CONDITIONS	PERFORMANCE REQUIREMENTS
4.7 Vibration 4.7.2 Final inspection 4.9 Shock 4.9.3 Final measurements	Visual examination Mounting: See section "Mounting" for more information Procedure B4 Frequency range: 10 Hz to 55 Hz Amplitude: 0.75 mm or Acceleration 98 m/s ² (whichever is less severe) Total duration 6 h Visual examination Mounting: See section "Mounting" for more information Pulse shape: Half sine Acceleration: 490 m/s ² Duration of pulse: 11 ms Visual examination Capacitance Tangent of loss angle Insulation resistance	No visible damage No visible damage No visible damage $ \Delta C/C \leq 2\%$ of the value measured in 4.6.1 Increase of $\tan \delta \leq 0.002$ Compared to values measured in 4.6.1 As specified in section "Insulation Resistance" of this specification
SUB-GROUP C1 COMBINED SAMPLE OF SPECIMENS OF SUB-GROUPS C1A AND C1B		
4.10 Climatic sequence 4.10.2 Dry heat 4.10.3 Damp heat cyclic Test Db, first cycle 4.10.4 Cold 4.10.6 Damp heat cyclic Test Db, remaining cycles 4.10.6.2 Final measurements	Temperature: Upper category temperature Duration: 16 h Temperature: Lower category temperature Duration: 2 h Visual examination Capacitance Tangent of loss angle Insulation resistance	No visible damage Legible marking $ \Delta C/C \leq 3\%$ of the value measured in 4.4.2 or 4.9.3 Increase of $\tan \delta \leq 0.003$ Compared to values measured in 4.3.1 or 4.6.1 $\geq 50\%$ of values specified in section "Insulation Resistance" of this specification
SUB-GROUP C2		
4.11 Damp heat steady state 4.11.1 Initial measurements 4.11.3 Final measurements	Capacitance Tangent of loss angle at 1 kHz Visual examination Capacitance Tangent of loss angle Insulation resistance	No visible damage Legible marking $ \Delta C/C \leq 3\%$ of the value measured in 4.11.1. Increase of $\tan \delta \leq 0.001$ Compared to values measured in 4.11.1 $\geq 50\%$ of values specified in section "Insulation Resistance" of this specification
SUB-GROUP C3		
4.12 Endurance DC 4.12.1 Initial measurements	Duration: 2000 h 1.25 x U _{Rdc} at 85 °C 0.875 x U _{Rdc} at 100 °C Capacitance Tangent of loss angle: For C ≤ 1 μF at 10 kHz For C > 1 μF at 1 kHz	



AC and Pulse Metallized Polypropylene Film Capacitors Vishay Roederstein
MKP Axial Type

SUB-CLAUSE NUMBER AND TEST	CONDITIONS	PERFORMANCE REQUIREMENTS
4.12.5 Final measurements	Visual examination Capacitance Tangent of loss angle Insulation resistance	No visible damage Legible marking $ \Delta C/C \leq 3\%$ compared to values measured in 4.12.1 Increase of $\tan \delta \leq 0.002$ Compared to values measured in 4.12.1 $\geq 50\%$ of values specified in section "Insulation Resistance" of this specification
SUB-GROUP C4		
4.2.6 Temperature characteristics Initial measurement Intermediate Intermediate measurements Final measurements	Capacitance Capacitance at lower category temperature Capacitance at 20 °C Capacitance at upper category temperature Capacitance Tangent of loss angle: For $C \leq 1 \mu\text{F}$ at 10 kHz For $C > 1 \mu\text{F}$ at 1 kHz Insulation resistance	For - 55 °C to + 20 °C: $0\% \leq \Delta C/C \leq 2\%$ or for 20 °C to 85 °C: $- 3\% \leq \Delta C/C \leq 0\%$ As specified in section "Capacitance" of this specification As specified in section "Insulation Resistance" of this specification
4.13 Charge and discharge	10 000 cycles Charged to U_{Rdc} Discharge resistance: $R = \frac{U_{Rdc}}{2.5 \times C(dU/dt)}$	
4.13.1 Initial measurements	Capacitance Tangent of loss angle at 100 kHz	
4.13.3 Final measurements	Capacitance Tangent of loss angle Insulation resistance	$ \Delta C/C \leq 3\%$ of the value measured in 4.13.1 Increase of $\tan \delta \leq 0.003$ Compared to values measured in 4.13.1 $\geq 50\%$ of values specified in section "Insulation Resistance" of this specification



Disclaimer

All product specifications and data are subject to change without notice.

Vishay Intertechnology, Inc., its affiliates, agents, and employees, and all persons acting on its or their behalf (collectively, "Vishay"), disclaim any and all liability for any errors, inaccuracies or incompleteness contained herein or in any other disclosure relating to any product.

Vishay disclaims any and all liability arising out of the use or application of any product described herein or of any information provided herein to the maximum extent permitted by law. The product specifications do not expand or otherwise modify Vishay's terms and conditions of purchase, including but not limited to the warranty expressed therein, which apply to these products.

No license, express or implied, by estoppel or otherwise, to any intellectual property rights is granted by this document or by any conduct of Vishay.

The products shown herein are not designed for use in medical, life-saving, or life-sustaining applications unless otherwise expressly indicated. Customers using or selling Vishay products not expressly indicated for use in such applications do so entirely at their own risk and agree to fully indemnify Vishay for any damages arising or resulting from such use or sale. Please contact authorized Vishay personnel to obtain written terms and conditions regarding products designed for such applications.

Product names and markings noted herein may be trademarks of their respective owners.

Компания «Океан Электроники» предлагает заключение долгосрочных отношений при поставках импортных электронных компонентов на взаимовыгодных условиях!

Наши преимущества:

- Поставка оригинальных импортных электронных компонентов напрямую с производств Америки, Европы и Азии, а так же с крупнейших складов мира;
- Широкая линейка поставок активных и пассивных импортных электронных компонентов (более 30 млн. наименований);
- Поставка сложных, дефицитных, либо снятых с производства позиций;
- Оперативные сроки поставки под заказ (от 5 рабочих дней);
- Экспресс доставка в любую точку России;
- Помощь Конструкторского Отдела и консультации квалифицированных инженеров;
- Техническая поддержка проекта, помощь в подборе аналогов, поставка прототипов;
- Поставка электронных компонентов под контролем ВП;
- Система менеджмента качества сертифицирована по Международному стандарту ISO 9001;
- При необходимости вся продукция военного и аэрокосмического назначения проходит испытания и сертификацию в лаборатории (по согласованию с заказчиком);
- Поставка специализированных компонентов военного и аэрокосмического уровня качества (Xilinx, Altera, Analog Devices, Intersil, Interpoint, Microsemi, Actel, Aeroflex, Peregrine, VPT, Syfer, Eurofarad, Texas Instruments, MS Kennedy, Miteq, Cobham, E2V, MA-COM, Hittite, Mini-Circuits, General Dynamics и др.);

Компания «Океан Электроники» является официальным дистрибьютором и эксклюзивным представителем в России одного из крупнейших производителей разъемов военного и аэрокосмического назначения «JONHON», а так же официальным дистрибьютором и эксклюзивным представителем в России производителя высокотехнологичных и надежных решений для передачи СВЧ сигналов «FORSTAR».



JONHON

«JONHON» (основан в 1970 г.)

Разъемы специального, военного и аэрокосмического назначения:

(Применяются в военной, авиационной, аэрокосмической, морской, железнодорожной, горно- и нефтедобывающей отраслях промышленности)

«FORSTAR» (основан в 1998 г.)

ВЧ соединители, коаксиальные кабели, кабельные сборки и микроволновые компоненты:

(Применяются в телекоммуникациях гражданского и специального назначения, в средствах связи, РЛС, а так же военной, авиационной и аэрокосмической отраслях промышленности).



Телефон: 8 (812) 309-75-97 (многоканальный)

Факс: 8 (812) 320-03-32

Электронная почта: ocean@oceanchips.ru

Web: <http://oceanchips.ru/>

Адрес: 198099, г. Санкт-Петербург, ул. Калинина, д. 2, корп. 4, лит. А