

Round terminal type with excellent PC board mounting performance

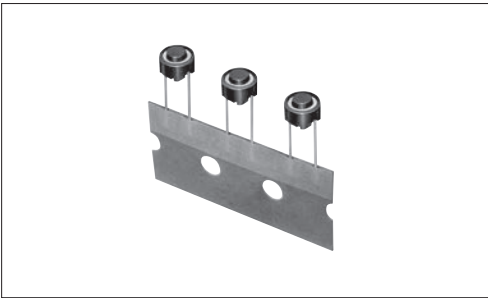

■ Typical Specifications

Items	Specifications
Rating (max.)	50mA 12V DC
Rating (min.)	10 $\mu$ A 1V DC
Initial contact resistance	500m $\Omega$ max.
Travel (mm)	0.25

■ Product Line

Product No.	Operating force	Operating direction	Operating life (5mA 5V DC)	Stem color	Stem height	Minimum order unit (pcs.)	
						Japan	Export
<b>SKRGAAD010</b>	1.27N	Top push	500,000 cycles	Black	h=4.3mm	2,000	2,000
<b>SKRGABD010</b>	1.57N			White			
<b>SKRGACD010</b>	2.55N		200,000 cycles	Gray			
<b>SKRGADD010</b>	1.27N		500,000 cycles	Black	h=5mm		
<b>SKRGAED010</b>	1.57N			White			
<b>SKRGAFD010</b>	2.55N		200,000 cycles	Gray			
<b>SKRGALD010</b>	1.27N		500,000 cycles	Black	h=7mm		
<b>SKRGAMD010</b>	1.57N			White			
<b>SKRGAND010</b>	2.55N		200,000 cycles	Gray			
<b>SKRGAQD010</b>	1.27N		500,000 cycles	Black	h=9.5mm		
<b>SKRGARD010</b>	1.57N			White			
<b>SKRGASD010</b>	2.55N		200,000 cycles	Gray			

■ Packing Specifications

Radial Taping

Number of packages (pcs.)			Export package measurements (mm)
1 box	1 case / Japan	1 case / export packing	
2,000	20,000	20,000	SKRGAA to AF 353×506×244
			SKRGAL to AS 353×506×269

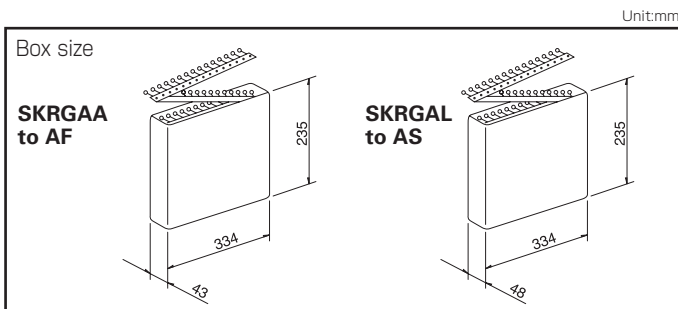

Refer to P.265 for soldering conditions.

TACT Switch™  
Sharp Feeling  
Soft Feeling  
Snap-in Type  
Surface Mount Type  
Radial Type

# SKRG 6.2mm Diameter Round Terminal (Radial Type)

TACT Switch™

Sharp Feeling

Soft Feeling

Snap-In Type

Surface Mount Type

Radial Type

## ■ Dimensions

Unit:mm









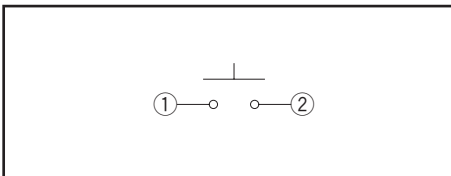





Style		PC board mounting hole dimensions (Viewed from switch mounting face)	
	h	A	
	4.3	3.4	
	5	3.4	
	7	3.2	
9.5	2.9		

## Note

Please use 1.6mm thick PC boards.

## ■ Circuit Diagram



Type		Sharp Feeling Type						
		Snap-in				Radial		
Series		SKHL	SKHH	SKQJ	SKQB	SKRG	SKQK	SKRC
Photo								
Features		—	—	—	—	Round terminal type	—	Round terminal type
Water-proof		—	—	—	●	—	—	●
Dust-proof		—	—	●	●	—	—	●
IP standard		—	—	—	—	—	—	—
Operating direction	Top push	—	—	—	—	●	●	●
	Side push	●	●	●	●	—	—	—
Dimensions (mm)	W	7.3	7.5	7.5	11.5	φ6.2	□6.6	φ9
	D	7.22	7.85	7.85	11.9			
	H	4.3	7.4	7.3	11.3	See the relevant pages for respective product descriptions		5
Operation force coverage	1N max.	↕	↕	↕	↕	↕	↕	↕
	1N to 2N							
	2N to 3N							
	3N to 4N							
	4N to 5N							
Travel (mm)		0.25			0.3	0.25		
Ground terminal		●	●	—	—	—	—	—
Operating temperature range		-40°C to +90°C		-20°C to +70°C	-40°C to +95°C	-40°C to +90°C	-20°C to +70°C	-30°C to +85°C
Automotive use		●	●	—	●	●	—	—
Life Cycle								
Electrical performance	Rating (max.) (Resistive load)	50mA 12V DC						
	Rating (min.) (Resistive load)	10μA 1V DC						
	Insulation resistance	100MΩ min. 100V DC 1min.						
	Voltage proof	250V AC 1min.						
Durability	Vibration	10 to 55 to 10Hz/min., the amplitude is 1.5mm for all the frequencies, in the 3 direction of X, Y and Z for 2 hours respectively						
	Lifetime	Shall be in accordance with individual specifications.						
Environmental performance	Cold	-40°C 96h		-30°C 96h	-40°C 96h		-30°C 96h	-40°C 96h
	Dry heat	90°C 96h		80°C 96h	90°C 96h		80°C 96h	90°C 96h
	Damp heat	60°C, 90 to 95%RH 96h			60°C, 90 to 95%RH 1,000h	60°C, 90 to 95%RH 96h		60°C, 90 to 95%RH 1,000h
Page		195	197	202	204	251	253	254

W : Width. The most outer dimension excluding terminal portion.  
D : Depth. The most outer dimension excluding terminal portion.  
H : Height. The minimum dimension if there are variances.

TACT Switch™ Soldering Conditions	265
TACT Switch™ Cautions	266

#### Notes

- The automotive operating temperature range to be individually discussed upon request.
- Indicates applicability to all products in the series.

## Condition for Reflow

Available for Surface Mount Type.

1. Temperature measurement: Thermocouple  $\phi$  0.1 to 0.2 CA (K) or CC (T) at solder joints (copper foil surface).  
A heat resistive tape should be used to fix thermocouple.
2. Temperature profile



### Notes

1. The above temperature shall be measured of the top of switch. There are cases where the PC board's temperature greatly differs from that of the switch, depending on the material, size, thickness of PC boards and others.  
The above-stated conditions shall also apply to switch surface temperatures.
2. Soldering conditions differ depending on reflow soldering machines.  
Prior verification of soldering condition is highly recommended.

## Conditions for Auto-dip

Available for Snap-in Type and Radial Type.

Items	Condition
Flux built-up	Mounting surface should not be exposed to flux
Preheating temperature	Ambient temperature of the soldered surface of PC board. 100°C max.
Preheating time	60s max.
Soldering temperature	260°C max.
Duration of immersion	5s max.
Number of soldering	2times max.

### SKHH, SKPD Series

Items	Condition
Flux built-up	Mounting surface should not be exposed to flux
Preheating temperature	Ambient temperature of the soldered surface of PC board. 110°C max.
Preheating time	60s max.
Soldering temperature	260°C max.
Duration of immersion	5s max.
Number of soldering	2times max.

### SKQJ, SKQK, SKEG Series

Items	Condition
Flux built-up	Mounting surface should not be exposed to flux
Preheating temperature	Ambient temperature of the soldered surface of PC board. 100°C max.
Preheating time	45s max.
Soldering temperature	255°C max.
Duration of immersion	5s max.
Number of soldering	2times max.

## Manual Soldering

Items	Condition
Soldering temperature	350°C max.
Duration of soldering	3s max.
Capacity of soldering iron	60W max.

### SKHH, SKHW, SKRG, SKPD Series

Items	Condition
Soldering temperature	360°C max.
Duration of soldering	3s max.
Capacity of soldering iron	60W max.

### SKTD, SKTG, SKQJ, SKQK, SKEG Series

Items	Condition
Soldering temperature	350°C max.
Duration of soldering	3s max.
Capacity of soldering iron	20W max.

### Notes

1. Prevent flux penetration from the top side of the TACT Switch™.
2. Switch terminals and a PC board should not be coated with flux prior to soldering.
3. The second soldering should be done after the switch is stable with normal temperature.
4. Use the flux with a specific gravity of min 0.81.  
(EC-19S-8 by TAMURA Corporation, or equivalents.)

Компания «Океан Электроники» предлагает заключение долгосрочных отношений при поставках импортных электронных компонентов на взаимовыгодных условиях!

Наши преимущества:

- Поставка оригинальных импортных электронных компонентов напрямую с производств Америки, Европы и Азии, а так же с крупнейших складов мира;
- Широкая линейка поставок активных и пассивных импортных электронных компонентов (более 30 млн. наименований);
- Поставка сложных, дефицитных, либо снятых с производства позиций;
- Оперативные сроки поставки под заказ (от 5 рабочих дней);
- Экспресс доставка в любую точку России;
- Помощь Конструкторского Отдела и консультации квалифицированных инженеров;
- Техническая поддержка проекта, помощь в подборе аналогов, поставка прототипов;
- Поставка электронных компонентов под контролем ВП;
- Система менеджмента качества сертифицирована по Международному стандарту ISO 9001;
- При необходимости вся продукция военного и аэрокосмического назначения проходит испытания и сертификацию в лаборатории (по согласованию с заказчиком);
- Поставка специализированных компонентов военного и аэрокосмического уровня качества (Xilinx, Altera, Analog Devices, Intersil, Interpoint, Microsemi, Actel, Aeroflex, Peregrine, VPT, Syfer, Eurofarad, Texas Instruments, MS Kennedy, Miteq, Cobham, E2V, MA-COM, Hittite, Mini-Circuits, General Dynamics и др.);

Компания «Океан Электроники» является официальным дистрибьютором и эксклюзивным представителем в России одного из крупнейших производителей разъемов военного и аэрокосмического назначения «JONHON», а так же официальным дистрибьютором и эксклюзивным представителем в России производителя высокотехнологичных и надежных решений для передачи СВЧ сигналов «FORSTAR».



## JONHON

«JONHON» (основан в 1970 г.)

Разъемы специального, военного и аэрокосмического назначения:

(Применяются в военной, авиационной, аэрокосмической, морской, железнодорожной, горно- и нефтедобывающей отраслях промышленности)

«FORSTAR» (основан в 1998 г.)

ВЧ соединители, коаксиальные кабели,  
кабельные сборки и микроволновые компоненты:

(Применяются в телекоммуникациях гражданского и специального назначения, в средствах связи, РЛС, а так же военной, авиационной и аэрокосмической отраслях промышленности).



Телефон: 8 (812) 309-75-97 (многоканальный)

Факс: 8 (812) 320-03-32

Электронная почта: [ocean@oceanchips.ru](mailto:ocean@oceanchips.ru)

Web: <http://oceanchips.ru/>

Адрес: 198099, г. Санкт-Петербург, ул. Калинина, д. 2, корп. 4, лит. А