

# 3M™ HIGH ROUTABILITY INTERNAL SATA CABLE ASSEMBLY

REVISION RECORD		
REV.	ECR/ECN/ECO NUMBER	DATE
A	ECO-0037492	05/09/11
B	ECO-0042030	13/07/12
C	ECO-0043801, CABLE P/N CHG	31/12/12



- NOTES :
- Regulatory Information.  
RoHs compliant, See the regulatory information appendix(RIA) in the "RoHs compliance" section of WWW.3Mconnectors.com compliance information (RIA E1 & C1 apply)
  - For custom cable length, contact 3M sales rep.
  - Cable part number : SL8803/04-10DN5-00
  - Product Specification: PS-0117.
  - This cable construction has a thin aluminum layer at each edge. User should evaluate its use in their application and, if necessary, insulating tape may be applied to cover the aluminum layer, as User deems appropriate
  - PVC overmoulding and PE Inner moulding at both ends.
  - Product meets SATA 3.0 signal integrity specifications.

### PART NUMBER SELECTION

5602-11-0142A-XXX  
Length in mm,000 refers to 1000mm.

3M PART NO.	L(MM)
5602-11-0142A-100	100
5602-11-0142A-200	200
5602-11-0142A-300	300
5602-11-0142A-400	400
5602-11-0142A-500	500
5602-11-0142A-600	600
5602-11-0142A-700	700
5602-11-0142A-800	800
5602-11-0142A-900	900
5602-11-0142A-000	1000

PIN OUT			
P1	TYPE	TYPE	P2
1	G	G	1
2	A+	A+	2
3	A-	A-	3
4	G	G	4
5	B-	B-	5
6	B+	B+	6
7	G	G	7

ITEM	SPECIFICATION	Q'TY	UNIT
3	CABLE : RIBBON TWIN AX , SL8803/04, UL AWM 21008,150V,80C SIGNAL -SILVER PLATED COPPER WITH 30 AWG.	1	PC
2	SATA CONN : 7P FEMALE 90° BLACK PBT30% 15*AU	1	PC
1	SATA CONN : 7P FEMALE 90° BLACK PBT30% 15*AU	1	PC

UNIT: MM	DFTG RAD VITTAPALLI	DATE 13/07/12	<b>3M</b> APAC INNOVATION CENTRE	DIVISION	ESD	STATUS
GEN. TOLERANCES	CHKD RAD VITTAPALLI	DATE 13/07/12		MODEL		RELEASE
LINEAR .0 = ± 0.25 .00 = ± 0.15 .000 = ± 0.05	APPVL ALAN ANG	DATE 13/07/12	TITLE SATA 7 PIN RIBBON TWINAX CABLE ASSEMBLY RIGHT ANGLE TO RIGHT ANGLE W/O LATCH			
ANGLE ±1°	THIS DOCUMENT CONTAINS INFORMATION WHICH IS PROPRIETARY TO 3M COMPANY. NO REPRODUCTION OR PUBLICATION OF THIS DOCUMENT, IN WHOLE OR IN PART, SHALL BE MADE WITHOUT AUTHORIZATION FROM 3M. © 3M 2013. ALL RIGHTS RESERVED.		SIZE A3	DRAWING NO. 78-5100-4897-8	REV C	
PROJECTION	INTERPRET PER ASME Y14.5M-1994		SCALE : NTS	DET LIST	<input type="checkbox"/> YES <input type="checkbox"/> NO	SHT 1 of 7
	CRITICAL DIMENSION: ▲					

# 3M™ HIGH ROUTABILITY INTERNAL SATA CABLE ASSEMBLY

REVISION RECORD		
REV.	ECR/ECN/ECO NUMBER	DATE
REFER TO SHT 1 OF 7		

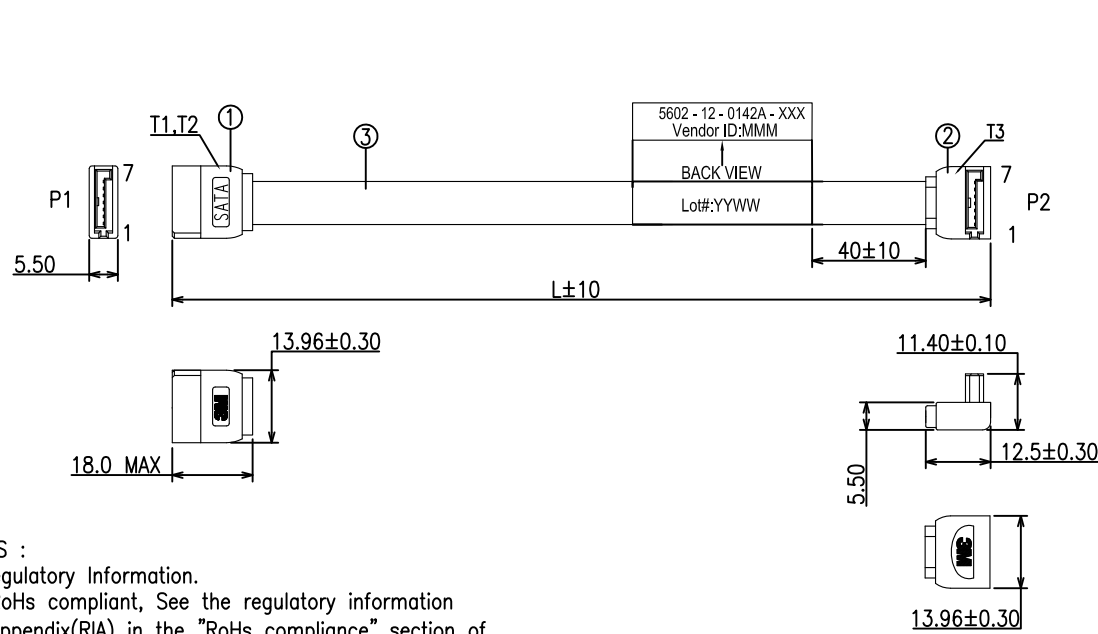

**NOTES :**

- Regulatory Information.  
RoHs compliant, See the regulatory information appendix(RIA) in the "RoHs compliance" section of [WWW.3Mconnectors.com](http://WWW.3Mconnectors.com) compliance information (RIA E1 & C1 apply)
- For custom cable length, contact 3M sales rep.
- Cable Part number: SL8803/04-10DN5-00
- Product Specification: PS-0117.
- This cable construction has a thin aluminum layer at each edge.  
User should evaluate its use in their application and, if necessary, insulating tape may be applied to cover the aluminum layer, as User deems appropriate
- PVC overmoulding and PE Inner moulding at both ends.
- Product meets SATA 3.0 signal integrity specifications.

**PART NUMBER SELECTION**

5602-12-0142A-XXX  
Length in mm,000 refers to 1000mm.

3M PART NO.	L(MM)
5602-12-0142A-100	100
5602-12-0142A-200	200
5602-12-0142A-300	300
5602-12-0142A-400	400
5602-12-0142A-500	500
5602-12-0142A-600	600
5602-12-0142A-700	700
5602-12-0142A-800	800
5602-12-0142A-900	900
5602-12-0142A-000	1000

PIN OUT			
P1	TYPE	TYPE	P2
1	G	G	1
2	A+	A+	2
3	A-	A-	3
4	G	G	4
5	B-	B-	5
6	B+	B+	6
7	G	G	7

ITEM	SPECIFICATION	Q'TY	UNIT
3	CABLE : RIBBON TWIN AX , SL8803/04, UL AWM 21008,150V,80C SIGNAL -SILVER PLATED COPPER CONDUCTOR 30 AWG.	1	PC
2	SATA CONN : 7P FEMALE 90° BLACK PBT 30%GF 15*AU	1	PC
1	SATA CONN : 7P FEMALE 180° BLACK PBT 30%GF 15*AU	1	PC

UNIT: MM	DFTG RAD VITTAPALLI	DATE 13/07/12	<b>3M</b> APAC INNOVATION CENTRE	DIVISION	ESD	STATUS
GEN. TOLERANCES	CHKD RAD VITTAPALLI	DATE 13/07/12		MODEL		RELEASE
LINEAR .0 = ± 0.25 .00 = ± 0.15 .000 = ± 0.05	APPVL ALAN ANG	DATE 13/07/12	TITLE SATA 7 PIN RIBBON TWINAX CABLE ASSEMBLY STRAIGHT TO RIGHT ANGLE W/O LATCH			
ANGLE ±1°	THIS DOCUMENT CONTAINS INFORMATION WHICH IS PROPRIETARY TO 3M COMPANY. NO REPRODUCTION OR PUBLICATION OF THIS DOCUMENT, IN WHOLE OR IN PART, SHALL BE MADE WITHOUT AUTHORIZATION FROM 3M. © 3M 2013. ALL RIGHTS RESERVED.		SIZE A3	DRAWING NO. 78-5100-4897-8	REV C	
PROJECTION	INTERPRET PER ASME Y14.5M-1994	SCALE : NTS		DET LIST	<input type="checkbox"/> YES <input type="checkbox"/> NO	SHT 2 of 7
CRITICAL DIMENSION: ▲						

# 3M™ HIGH ROUTABILITY INTERNAL SATA CABLE ASSEMBLY

REVISION RECORD		
REV.	ECR/ECN/ECO NUMBER	DATE
REFER TO SHT 1 OF 7		

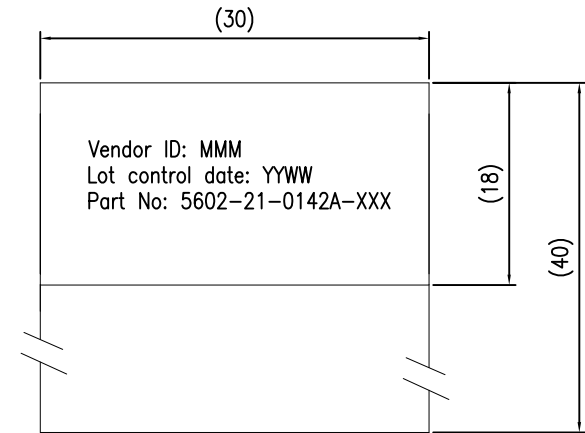
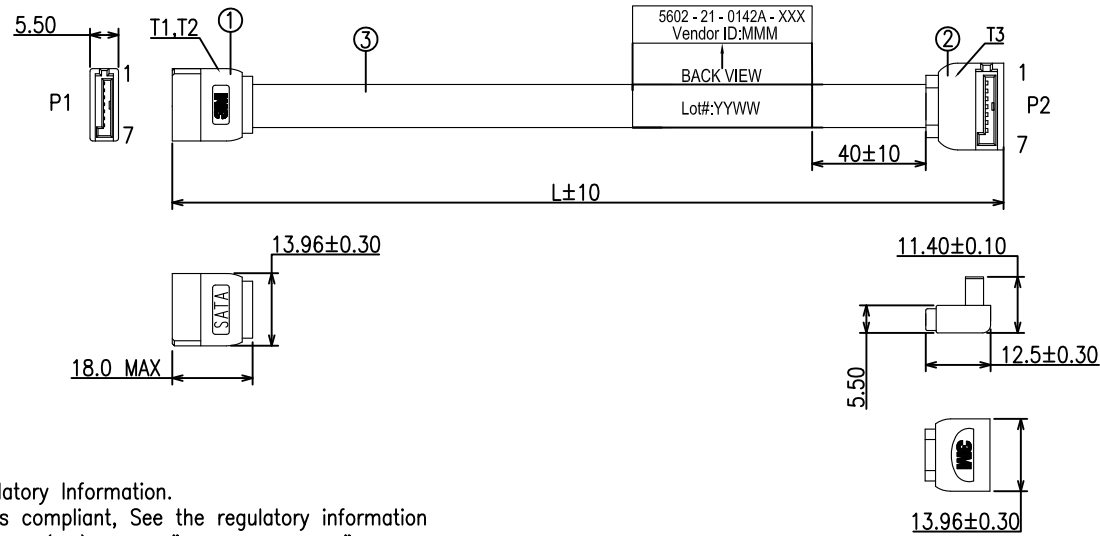

## NOTES :

- Regulatory Information.  
RoHs compliant, See the regulatory information appendix(RIA) in the "RoHs compliance" section of [WWW.3Mconnectors.com](http://WWW.3Mconnectors.com) compliance information (RIA E1 & C1 apply)
- For custom cable length, contact 3M sales rep.
- Cable Part number : SL8803/04-10DN5-00
- Product Specification: PS-0117.
- This cable construction has a thin aluminum layer at each edge.  
User should evaluate its use in their application and, if necessary, insulating tape may be applied to cover the aluminum layer, as User deems appropriate
- PVC overmoulding and PE Inner moulding at both ends.
- Product meets SATA 3.0 signal integrity specifications.

## PART NUMBER SELECTION

5602-21-0142A-XXX  
Length in mm,000 refers to 1000mm.

3M PART NO.	L(MM)
5602-21-0142A-100	100
5602-21-0142A-200	200
5602-21-0142A-300	300
5602-21-0142A-400	400
5602-21-0142A-500	500
5602-21-0142A-600	600
5602-21-0142A-700	700
5602-21-0142A-800	800
5602-21-0142A-900	900
5602-21-0142A-000	1000

## PIN OUT

P1	TYPE	TYPE	P2
1	G	G	1
2	A+	A+	2
3	A-	A-	3
4	G	G	4
5	B-	B-	5
6	B+	B+	6
7	G	G	7

ITEM	SPECIFICATION	Q'TY	UNIT
3	CABLE : RIBBON TWIN AX , SL8803/04, UL AWM 21008,150V,80C SIGNAL -SILVER PLATED COPPER CONDUCTOR 30 AWG.	1	PC
2	SATA CONN : 7P FEMALE 90° BLACK PBT 30%GF 15*AU	1	PC
1	SATA CONN : 7P FEMALE 180° BLACK PBT 30%GF 15*AU	1	PC

UNIT: MM	DFTG RAD VITTAPALLI	DATE 13/07/12	<b>3M</b> APAC INNOVATION CENTRE	DIVISION	ESD	STATUS
GEN. TOLERANCES	CHKD RAD VITTAPALLI	DATE 13/07/12		MODEL		RELEASE
LINEAR .0 = ± 0.25 .00 = ± 0.15 .000 = ± 0.05	APPVL ALAN ANG	DATE 13/07/12	TITLE SATA 7 PIN RIBBON TWINAX CABLE ASSEMBLY STRAIGHT TO RIGHT ANGLE W/O LATCH			
ANGLE ±1°	THIS DOCUMENT CONTAINS INFORMATION WHICH IS PROPRIETARY TO 3M COMPANY. NO REPRODUCTION OR PUBLICATION OF THIS DOCUMENT, IN WHOLE OR IN PART, SHALL BE MADE WITHOUT AUTHORIZATION FROM 3M. © 3M 2013. ALL RIGHTS RESERVED.		SIZE A3	DRAWING NO. 78-5100-4897-8	REV C	
PROJECTION	INTERPRET PER ASME Y14.5M-1994		SCALE : NTS	DET LIST	<input type="checkbox"/> YES <input type="checkbox"/> NO	SHT 3 of 7
	CRITICAL DIMENSION: ▲					

# 3M™ HIGH ROUTABILITY INTERNAL SATA CABLE ASSEMBLY

REVISION RECORD		
REV.	ECR/ECN/ECO NUMBER	DATE
REFER TO SHT 1 OF 7		



### NOTES :

- Regulatory Information.  
RoHs compliant, See the regulatory information appendix(RIA) in the "RoHs compliance" section of WWW.3Mconnectors.com compliance information (RIA E1 & C1 apply)
- For custom cable length, contact 3M sales rep.
- Cable Part number: SL8803/04-10DN5-00
- Product Specification: PS-0117.
- This cable construction has a thin aluminum layer at each edge.  
User should evaluate its use in their application and, if necessary, insulating tape may be applied to cover the aluminum layer, as User deems appropriate
- PVC overmoulding and PE Inner moulding at both ends.
- Product meets SATA 3.0 signal integrity specifications.

### PART NUMBER SELECTION

5602-22-0142A-XXX  
Length in mm,000 refers to 1000mm.

3M PART NO.	L(MM)
5602-22-0142A-100	100
5602-22-0142A-200	200
5602-22-0142A-300	300
5602-22-0142A-400	400
5602-22-0142A-500	500
5602-22-0142A-600	600
5602-22-0142A-700	700
5602-22-0142A-800	800
5602-22-0142A-900	900
5602-22-0142A-000	1000

PIN OUT			
P1	TYPE	TYPE	P2
1	G	G	1
2	A+	A+	2
3	A-	A-	3
4	G	G	4
5	B-	B-	5
6	B+	B+	6
7	G	G	7

ITEM	SPECIFICATION	Q'TY	UNIT
2	CABLE : RIBBON TWIN AX , SL8803/04, UL AWM 21008,150V,80C	1	PC
	SIGNAL -SILVER PLATED COPPER CONDUCTOR WITH 30 AWG.		
1	SATA CONN : 7P FEMALE 180° BLACK PBT 30GF , 15"AU	2	PCS

UNIT: MM	DFTG RAD VITTAPALLI	DATE 13/07/12		DIVISION	ESD	STATUS
GEN. TOLERANCES	CHKD RAD VITTAPALLI	DATE 13/07/12		MODEL		RELEASE
LINEAR .0 = ± 0.25 .00 = ± 0.15 .000 = ± 0.05	APPVL ALAN ANG	DATE 13/07/12	TITLE	SATA 7 PIN RIBBON TWINAX CABLE ASSEMBLY STRAIGHT TO STRAIGHT W/O LATCH		
ANGLE ±1°	THIS DOCUMENT CONTAINS INFORMATION WHICH IS PROPRIETARY TO 3M COMPANY. NO REPRODUCTION OR PUBLICATION OF THIS DOCUMENT, IN WHOLE OR IN PART, SHALL BE MADE WITHOUT AUTHORIZATION FROM 3M. © 3M 2013. ALL RIGHTS RESERVED.		SIZE A3	DRAWING NO.	78-5100-4897-8	REV C
PROJECTION	INTERPRET PER ASME Y14.5M-1994		SCALE : NTS	DET LIST	<input type="checkbox"/> YES <input type="checkbox"/> NO	SHT 4 of 7
	CRITICAL DIMENSION: ▲					

# 3M™ HIGH ROUTABILITY INTERNAL SATA CABLE ASSEMBLY

REVISION RECORD		
REV.	ECR/ECN/ECO NUMBER	DATE
REFER TO SHIT 1 OF 7		

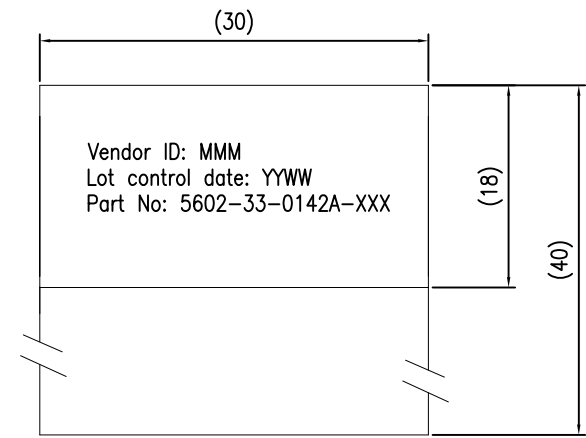
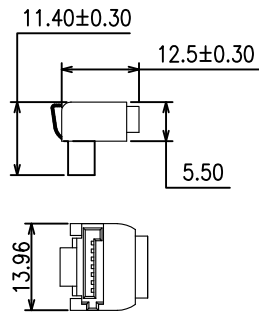

### NOTES :

- Regulatory Information.  
RoHs compliant, See the regulatory information appendix(RIA) in the "RoHs compliance" section of WWW.3Mconnectors.com compliance information (RIA E1 & C1 apply)
- For custom cable length, contact 3M sales rep.
- Cable part number: SL8803/04-10DN5-00
- Product Specification: PS-0117.
- This cable construction has a thin aluminum layer at each edge. User should evaluate its use in their application and, if necessary, insulating tape may be applied to cover the aluminum layer, as User deems appropriate
- PVC overmoulding and PE Inner moulding at both ends.
- Product meets SATA 3.0 signal integrity specifications.

### PART NUMBER SELECTION

5602-33-0142A-XXX  
Length in mm,000 refers to 1000mm.

3M PART NO.	L(MM)
5602-33-0142A-100	100
5602-33-0142A-200	200
5602-33-0142A-300	300
5602-33-0142A-400	400
5602-33-0142A-500	500
5602-33-0142A-600	600
5602-33-0142A-700	700
5602-33-0142A-800	800
5602-33-0142A-900	900
5602-33-0142A-000	1000

### PIN OUT

P1	TYPE	TYPE	P2
1	G	G	1
2	A+	A+	2
3	A-	A-	3
4	G	G	4
5	B-	B-	5
6	B+	B+	6
7	G	G	7

ITEM	SPECIFICATION	Q'TY	UNIT
3	CABLE : RIBBON TWIN AX , SL8803/04, UL AWM 21008,150V,80C SIGNAL -SILVER PLATED COPPER WITH 30 AWG.	1	PC
2	SATA CONN : 7P FEMALE 90° BLACK PBT30% 15*AU WITH LATCH	1	PC
1	SATA CONN : 7P FEMALE 90° BLACK PBT30% 15*AU WITH LATCH	1	PC

UNIT: MM	DFTG RAD VITTAPALLI	DATE 13/07/12	<b>3M</b> APAC INNOVATION CENTRE	DIVISION ESD	STATUS RELEASE
GEN. TOLERANCES	CHKD RAD VITTAPALLI	DATE 13/07/12		MODEL	
LINEAR .0 = ± 0.25 .00 = ± 0.15 .000 = ± 0.05	APPVL ALAN ANG	DATE 13/07/12	TITLE SATA 7 PIN RIBBON TWINAX CABLE ASSEMBLY RIGHT ANGLE TO RIGHT ANGLE WITH LATCH		
ANGLE ±1°	THIS DOCUMENT CONTAINS INFORMATION WHICH IS PROPRIETARY TO 3M COMPANY. NO REPRODUCTION OR PUBLICATION OF THIS DOCUMENT, IN WHOLE OR IN PART, SHALL BE MADE WITHOUT AUTHORIZATION FROM 3M. © 3M 2013. ALL RIGHTS RESERVED.		SIZE A3	DRAWING NO. 78-5100-4897-8	REV C
PROJECTION	INTERPRET PER ASME Y14.5M-1994	SCALE : NTS		DET LIST <input type="checkbox"/> YES <input type="checkbox"/> NO	SHT 5 of 7
CRITICAL DIMENSION: ▲					

WWW.3Mconnectors.com

# 3M™ HIGH ROUTABILITY INTERNAL SATA CABLE ASSEMBLY

REVISION RECORD		
REV.	ECR/ECN/ECO NUMBER	DATE
REFER TO SHT 1 OF 7		

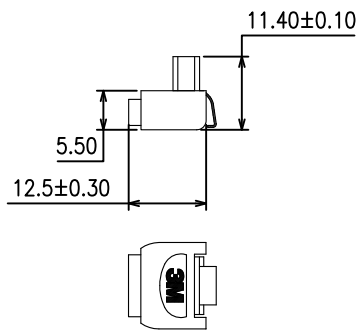
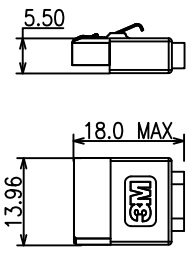
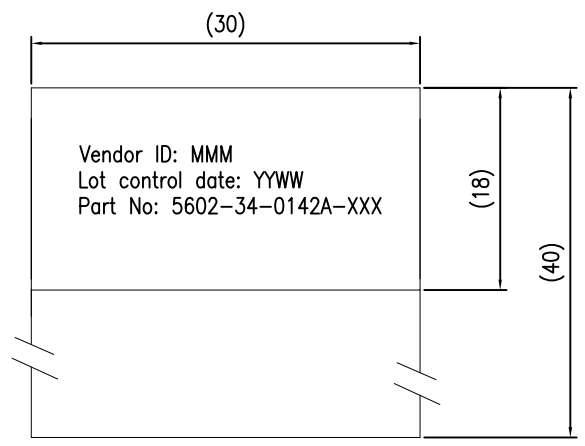
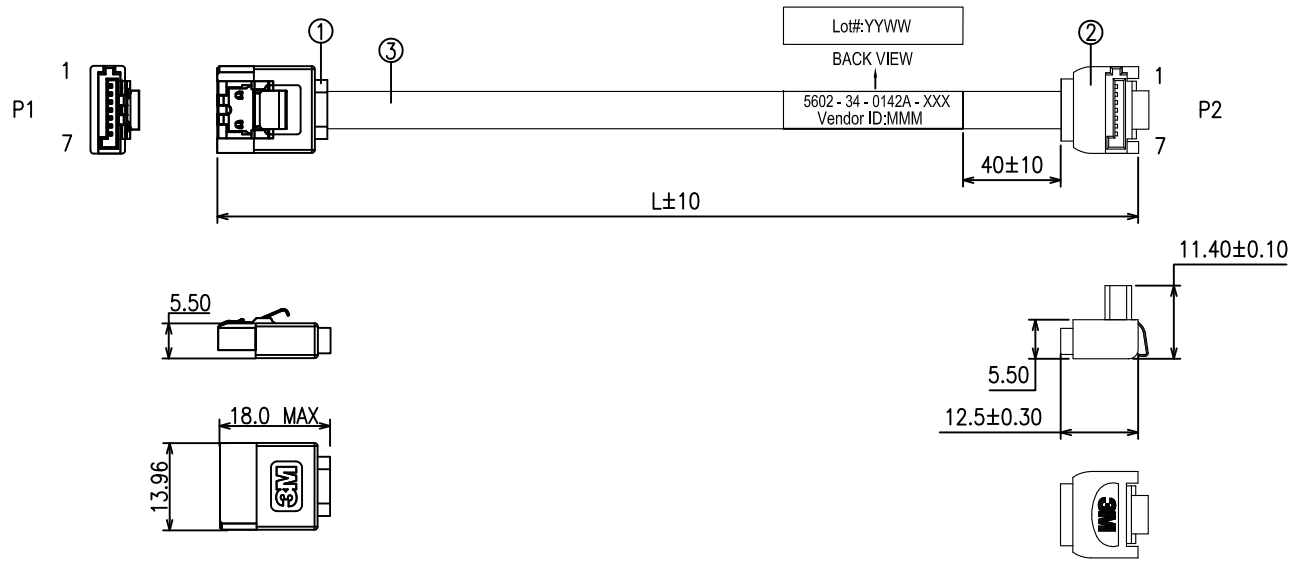

### NOTES :

- Regulatory Information.  
RoHs compliant, See the regulatory information appendix(RIA) in the "RoHs compliance" section of WWW.3Mconnectors.com compliance information (RIA E1 & C1 apply)
- For custom cable length, contact 3M sales rep.
- Cable Part number: SL8803/04-10DN5-00
- Product Specification: PS-0117.
- This cable construction has a thin aluminum layer at each edge. User should evaluate its use in their application and, if necessary, insulating tape may be applied to cover the aluminum layer, as User deems appropriate
- PVC overmoulding and PE Inner moulding at both ends.
- Product meets SATA 3.0 signal integrity specifications.

### PART NUMBER SELECTION

5602-34-0142A-XXX  
Length in mm,000 refers to 1000mm.

3M PART NO.	L(MM)
5602-34-0142A-100	100
5602-34-0142A-200	200
5602-34-0142A-300	300
5602-34-0142A-400	400
5602-34-0142A-500	500
5602-34-0142A-600	600
5602-34-0142A-700	700
5602-34-0142A-800	800
5602-34-0142A-900	900
5602-34-0142A-000	1000

PIN OUT			
P1	TYPE	TYPE	P2
1	G	G	1
2	A+	A+	2
3	A-	A-	3
4	G	G	4
5	B-	B-	5
6	B+	B+	6
7	G	G	7

ITEM	SPECIFICATION	Q'TY	UNIT
3	CABLE : RIBBON TWIN AX , SL8803/04, UL AWM 21008,150V,80C SIGNAL -SILVER PLATED COPPER CONDUCTOR 30 AWG.	1	PC
2	SATA CONN : 7P FEMALE 90° BLACK PBT 30%GF 15*AU WITH LATCH	1	PC
1	SATA CONN : 7P FEMALE 180° BLACK PBT 30%GF 15*AU WITH LATCH	1	PC

UNIT: MM	DFTG RAD VITTAPALLI	DATE 13/07/12	<b>3M</b> APAC INNOVATION CENTRE	DIVISION	ESD	STATUS
GEN. TOLERANCES	CHKD RAD VITTAPALLI	DATE 13/07/12		MODEL		RELEASE
LINEAR .0 = ± 0.25 .00 = ± 0.15 .000 = ± 0.05	APPVL ALAN ANG	DATE 13/07/12	TITLE SATA 7 PIN RIBBON TWINAX CABLE ASSEMBLY STRAIGHT TO RIGHT ANGLE WITH LATCH			
ANGLE ±1°	THIS DOCUMENT CONTAINS INFORMATION WHICH IS PROPRIETARY TO 3M COMPANY. NO REPRODUCTION OR PUBLICATION OF THIS DOCUMENT, IN WHOLE OR IN PART, SHALL BE MADE WITHOUT AUTHORIZATION FROM 3M. © 3M 2013. ALL RIGHTS RESERVED.		SIZE A3	DRAWING NO. 78-5100-4897-8	REV C	
PROJECTION	INTERPRET PER ASME Y14.5M-1994	SCALE : NTS		DET LIST	<input type="checkbox"/> YES <input type="checkbox"/> NO	SHT 6 of 7
CRITICAL DIMENSION: ▲						

WWW.3Mconnectors.com

# 3M™ HIGH ROUTABILITY INTERNAL SATA CABLE ASSEMBLY

REVISION RECORD		
REV.	ECR/ECN/ECO NUMBER	DATE
REFER TO SHT 1 OF 7		



**NOTES :**

- Regulatory Information.  
RoHs compliant, See the regulatory information appendix(RIA) in the "RoHs compliance" section of [WWW.3Mconnectors.com](http://WWW.3Mconnectors.com) compliance information (RIA E1 & C1 apply)
- For custom cable length, contact 3M sales rep.
- Cable Part number: SL8803/04-10DN5-00
- Product Specification: PS-0117.
- This cable construction has a thin aluminum layer at each edge. User should evaluate its use in their application and, if necessary, insulating tape may be applied to cover the aluminum layer, as User deems appropriate
- PVC overmoulding and PE Inner moulding at both ends.
- Product meets SATA 3.0 signal integrity specifications.

**PART NUMBER SELECTION**

5602-44-0142A-XXX  
Length in mm,000 refers to 1000mm.

3M PART NO.	L(MM)
5602-44-0142A-100	100
5602-44-0142A-200	200
5602-44-0142A-300	300
5602-44-0142A-400	400
5602-44-0142A-500	500
5602-44-0142A-600	600
5602-44-0142A-700	700
5602-44-0142A-800	800
5602-44-0142A-900	900
5602-44-0142A-000	1000

PIN OUT			
P1	TYPE	TYPE	P2
1	G	G	1
2	A+	A+	2
3	A-	A-	3
4	G	G	4
5	B-	B-	5
6	B+	B+	6
7	G	G	7

ITEM	SPECIFICATION	Q'TY	UNIT
2	CABLE : RIBBON TWIN AX , SL8803/04, UL AWM 21008,150V,80C	1	PC
	SIGNAL -SILVER PLATED COPPER CONDUCTOR WITH 30 AWG.		
1	SATA CONN : 7P FEMALE 180° BLACK PBT 30GF , 15°AU WITH LATCH	2	PCS

UNIT: MM	DFTG RAD VITTAPALLI	DATE 13/07/12		DIVISION ESD	STATUS RELEASE
GEN. TOLERANCES	CHKD RAD VITTAPALLI	DATE 13/07/12		MODEL	
LINEAR .0 = ± 0.25 .00 = ± 0.15 .000 = ± 0.05	APPVL ALAN ANG	DATE 13/07/12		TITLE SATA 7 PIN RIBBON TWINAX CABLE ASSEMBLY STRAIGHT TO STRAIGHT WITH LATCH	
ANGLE ±1°	THIS DOCUMENT CONTAINS INFORMATION WHICH IS PROPRIETARY TO 3M COMPANY. NO REPRODUCTION OR PUBLICATION OF THIS DOCUMENT, IN WHOLE OR IN PART, SHALL BE MADE WITHOUT AUTHORIZATION FROM 3M. © 3M 2013. ALL RIGHTS RESERVED.		SIZE A3	DRAWING NO. 78-5100-4897-8	REV C
PROJECTION	INTERPRET PER ASME Y14.5M-1994		SCALE : NTS	DET LIST <input type="checkbox"/> YES <input type="checkbox"/> NO	SHT 7 of 7

[WWW.3Mconnectors.com](http://WWW.3Mconnectors.com)

Компания «Океан Электроники» предлагает заключение долгосрочных отношений при поставках импортных электронных компонентов на взаимовыгодных условиях!

Наши преимущества:

- Поставка оригинальных импортных электронных компонентов напрямую с производств Америки, Европы и Азии, а так же с крупнейших складов мира;
- Широкая линейка поставок активных и пассивных импортных электронных компонентов (более 30 млн. наименований);
- Поставка сложных, дефицитных, либо снятых с производства позиций;
- Оперативные сроки поставки под заказ (от 5 рабочих дней);
- Экспресс доставка в любую точку России;
- Помощь Конструкторского Отдела и консультации квалифицированных инженеров;
- Техническая поддержка проекта, помощь в подборе аналогов, поставка прототипов;
- Поставка электронных компонентов под контролем ВП;
- Система менеджмента качества сертифицирована по Международному стандарту ISO 9001;
- При необходимости вся продукция военного и аэрокосмического назначения проходит испытания и сертификацию в лаборатории (по согласованию с заказчиком);
- Поставка специализированных компонентов военного и аэрокосмического уровня качества (Xilinx, Altera, Analog Devices, Intersil, Interpoint, Microsemi, Actel, Aeroflex, Peregrine, VPT, Syfer, Eurofarad, Texas Instruments, MS Kennedy, Miteq, Cobham, E2V, MA-COM, Hittite, Mini-Circuits, General Dynamics и др.);

Компания «Океан Электроники» является официальным дистрибьютором и эксклюзивным представителем в России одного из крупнейших производителей разъемов военного и аэрокосмического назначения «JONHON», а так же официальным дистрибьютором и эксклюзивным представителем в России производителя высокотехнологичных и надежных решений для передачи СВЧ сигналов «FORSTAR».



## JONHON

«JONHON» (основан в 1970 г.)

Разъемы специального, военного и аэрокосмического назначения:

(Применяются в военной, авиационной, аэрокосмической, морской, железнодорожной, горно- и нефтедобывающей отраслях промышленности)

«FORSTAR» (основан в 1998 г.)

ВЧ соединители, коаксиальные кабели, кабельные сборки и микроволновые компоненты:

(Применяются в телекоммуникациях гражданского и специального назначения, в средствах связи, РЛС, а так же военной, авиационной и аэрокосмической отраслях промышленности).



Телефон: 8 (812) 309-75-97 (многоканальный)

Факс: 8 (812) 320-03-32

Электронная почта: [ocean@oceanchips.ru](mailto:ocean@oceanchips.ru)

Web: <http://oceanchips.ru/>

Адрес: 198099, г. Санкт-Петербург, ул. Калинина, д. 2, корп. 4, лит. А