

RF5365

2.4GHz to 2.5GHz, 802.11b/g/n WiFi Front End Module

The RF5365 provides an integrated front end solution for WiFi 802.11b/g/n and Bluetooth® systems. The ultra-small form factor package and integrated matching greatly reduces the number of external components and layout area in the customer application. This simplifies the total front end solution by reducing the bill of materials, system footprint, and assembly cost.

The RF5365 integrates a 2.4 GHz Power Amplifier (PA), 2170 MHz notch filter for coexistence with cellular radios, second harmonic attenuation, power detector coupler for improved accuracy, and an SP3T switch capable of simultaneous reception for WiFi and Bluetooth®. The device is provided in a 2.5 mm x 2.5 mm x 0.5 mm, 12-pin package. This module meets or exceeds the RF front end needs of IEEE 802.11b/g/n WiFi RF systems.



Package: QFN, 12-pin,
2.5mm x 2.5mm x 0.5mm

Features

- Integrated 2.4GHz to 2.5GHz b/g/n Amplifier, SP3T Switch, and Power Detector Coupler
- Single Supply Voltage 3.0V to 4.8V
- Output Power: 11b = 21dBm Meeting Spectral Mask 11n = 18dBm at <3% EVM
- Low Height Package, Suited for SiP and CoB Designs

Applications

- Cellular handsets
- Mobile devices
- Tablets
- Consumer electronics
- Gaming
- Netbooks/Notebooks
- TV/monitors/video
- SmartEnergy

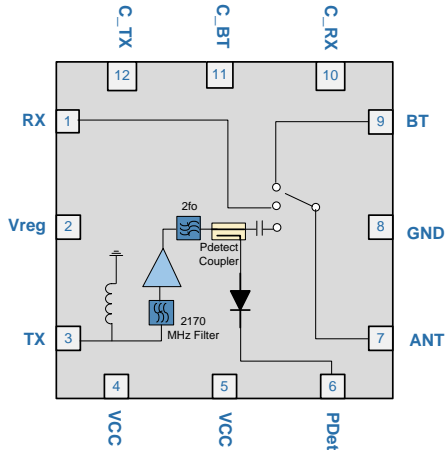

Functional Block Diagram

Ordering Information

RF5365SQ	Standard 25 piece bag
RF5365SR	Standard 100 piece reel
RF5365TR7	Standard 2500 piece reel
RF5365PCK-410	Fully assembled evaluation board w/5 piece bag

Absolute Maximum Ratings

Parameter	Rating	Unit
Supply Voltage	-0.5 to +5.4	VDC
Power Control Voltage (VREG)	-0.5 to 3.5	VDC
DC Supply Current	500	mA
Input RF Power	+5	dBm
Operating Case Temperature	-40 to +85	°C
Storage Temperature	-40 to +150	°C
Moisture Sensitivity	MSL2	



Caution! ESD sensitive device.



RFMD Green: RoHS status based on EU Directive 2011/65/EU (at time of this document revision), halogen free per IEC 61249-2-21, < 1000ppm each of antimony trioxide in polymeric materials and red phosphorus as a flame retardant, and <2% antimony in solder.

Exceeding any one or a combination of the Absolute Maximum Rating conditions may cause permanent damage to the device. Extended application of Absolute Maximum Rating conditions to the device may reduce device reliability. Specified typical performance or functional operation of the device under Absolute Maximum Rating conditions is not implied.

Nominal Operating Parameters

Parameter	Specification			Unit	Condition	
	Min	Typ	Max			
Compliance					IEEE802.11b/g/n Standards; FCC CFG 15.247, .205, .209; EN and JDEC	
Operating Conditions					$V_{CC} = 3.0V$ to $4.8V$; $V_{REG} = 2.8V$ to $2.9V$; Switch Control voltage = $2.7V$ to $3.6V$; Temp = $-10^{\circ}C$ to $+70^{\circ}C$ (SPEC COMPLIANT); Temp = $-40^{\circ}C$ to $-10^{\circ}C$ and $+70^{\circ}C$ to $+85^{\circ}C$ (REDUCED PERFORMANCE)	
Frequency Range	2.4		2.5	GHz		
Power Supply	3.0	3.3	4.8	V		
	2.7			V	Derated performance	
VREG Voltage						
	ON	2.80	2.85	2.90	V	PA in "ON" state
	OFF	0		0.2	V	PA in "OFF" state
Output Power						
	11n	16.5	17.0		dBm	$V_{CC} > 3.0V$ OFDM 54Mbps
	11n	17.5	18.0		dBm	$V_{CC} > 3.3V$ OFDM 54Mbps
	11g	18.0	18.5		dBm	$V_{CC} > 3.3V$ OFDM 54Mbps
	11b	19.5	21.0		dBm	11 Mbps, CCK, $V_{CC} > 3.3V$
EVM						
	11g		4.0	%	18dBm, OFDM 54 Mbps, $V_{CC} = 3.3V$ to $4.8V$ all Temp	
	11n		2.5	3.0	%	17.5dBm, OFDM 54 Mbps, $V_{CC} = 3.3V$ to $4.8V$ all Temp
			3.0	%	16.5dBm, OFDM 54 Mbps, $V_{CC} = 3.0V$ VDC all Temp	
Adjacent Channel Power					$P_{OUT} = 21Bm$, $V_{CC} = 3.3v$, 11Mbps CCK signal. See note 2	
	ACP1		-36	-33	dBc	+/- 11MHz Offset from carrier
	ACP2		-56	-52	dBc	+/- 22MHz Offset from carrier
Gain	23	25	29	dB	At rated P_{OUT}	
Gain Variance Slope						
	Channel 40 MHz BW	-1.0		+1.0	dB	
	Channel 20 MHz BW	-0.5		+0.5	dB	
	Frequency 100 MHz BW	-2		+2	dB	In-Band variance 2.4GHz to 2.5GHz
Out of Band Rejection						
	2170 MHz	6	8		dBc	CW signal

Parameter	Specification			Unit	Condition
	Min	Typ	Max		
Compliance (continued)					IEEE802.11b/g/n Standards; FCC CFG 15.247, .205, .209; EN and JDEC
Output Power Range	0		23	dBm	
Voltage Range	0.1		1.5	VDC	
Voltage at P _{OUT} = 18dBm	0.6	0.65	0.7	dB	11g; 50Ω; V _{CC} = 3.0V to 4.8 V
Filter Bandwidth		0.1		MHz	
Sensitivity					
P _{DETECT} < 0.5 V	10			mV/dB	
P _{DETECT} > 0.5 V	20			mV/dB	
Voltage Target at 23 dBm P _{OUT}		1.2		V	
Load Variation			±200	mV	up to 3:1 VSWR
Current Consumption					
Quiescent		135	180	mA	V _{CC} =3.0V to 4.8 V All Temp
Operating		170	220	mA	V _{CC} < 4.2 V _{DC} , P _{OUT} = 18dBm, 11 n, 50 W,, Temp=25 °C
Operating			230	mA	V _{CC} < 4.8 V _{DC} , P _{OUT} = 17.5dBm, 11 n, 50 W,, All Temp
Operating		210	270	mA	V _{CC} < 4.2 V _{DC} , P _{OUT} = 21dBm, 11b, 50 W, All Temp
V _{REG}		3	5	mA	T = 25°C
FEM Leakage			500	nA	V _{CC} = "ON", V _{REG} = 0.2 V _{DC} , RF OFF
V _{REG} Leakage			50	nA	
Noise Figure		8	9	dB	
Input Return Loss	8	10		dB	
Thermal Resistance		52		°C/W	V _{CC} =4.8V, V _{REG} =2.95V, C _{TX} =3.3V, C _{TX} =3.3, C _{RX} =C _{BT} =GND, P _{OUT} = 18dBm, Modulation=OFDM 11g, Freq=2.45GHz, DC=100%, T=85°C
Harmonics					P _{OUT} = 21dBm, 1 Mbps, CCK BW = 1 MHz, up to 3:1 load
Second			-15	dBm	4.80 GHz to 5.00 GHz, V _{CC} = 3.3 V, Temp=25°C
Third			-20	dBm	7.20 GHz to 7.50 GHz, V _{CC} = 3.3 V, Temp=25°C
Stability					PA must be stable from 0dBm to 21dBm. CW Signal, No spurs above -41.25dBm for non-harmonic related signals.
Output VSWR	4:1				All phase angles, no spurious or oscillations.
Ruggedness					No Damage Conditions over Voltage and Temperature
Output VSWR	10:1				
Input Power			0	dBm	CW Input Power, V _{CC} = 3.0 V to 4.8 V
Input Port Impedance		50		Ω	
Turn-On/Off Time			1	usec	Output stable to within 90% of final gain
2.4GHz Receive					
Frequency	2.4		2.5	GHz	Frequency
Insertion Loss		0.8	1.2	dB	Insertion Loss
Input P1dB	22			dBm	Input P1dB
Passband Ripple					Passband Ripple
WiFi RX Mode	-0.2		+0.2	dB	WiFi RX Mode
WiFi RX/BT Mode	-0.2		+0.2	dB	WiFi RX/BT Mode
WiFi RX Port Return Loss	10	12		dB	WiFi RX Port Return Loss
WiFi RX Port Impedance		50		Ω	WiFi RX Port Impedance

Parameter	Specification			Unit	Condition
	Min	Typ	Max		
Bluetooth®					
Frequency	2.4		2.5	GHz	
Insertion Loss		0.8	1.2	dB	
Bluetooth Port Return Loss	10	12		dB	
Bluetooth Port Impedance		50		Ω	
Bluetooth Input P1dB	22			dBm	
Other Requirements					
Antenna Port Impedance		50		Ω	
Return Loss	10	12		dB	In WiFi RX or BT Mode
Isolation					
ANT to RX	20			dB	At rated P _{OUT} in TX Mode
Switch Control Voltage					
Low	0		0.2	V	
High	2.7		3.6	V	
Switch Control Current					
Low			0.5	μ A	
High			100	μ A	
ESD					
Human Body Model	1000			V	Pin - Ground
Charge Device Model	500			V	JESD22-C101C. Class III

Note 1: The PA must operate with gates bias voltage input at 1% to 99% duty cycle.

Note 2: The output power for channels 1 and 11 may be reduced to meet FCC restricted band requirements.

Switch Control Logic Truth Table

Mode	C_TX	C_RX	C_BT	VREG
TX Mode	High	Low	Low	High
RX Mode	Low	High	Low	Low
BT Mode	Low	Low	High	Low
Simultaneous	Low	High	High	Low

Performance Plots

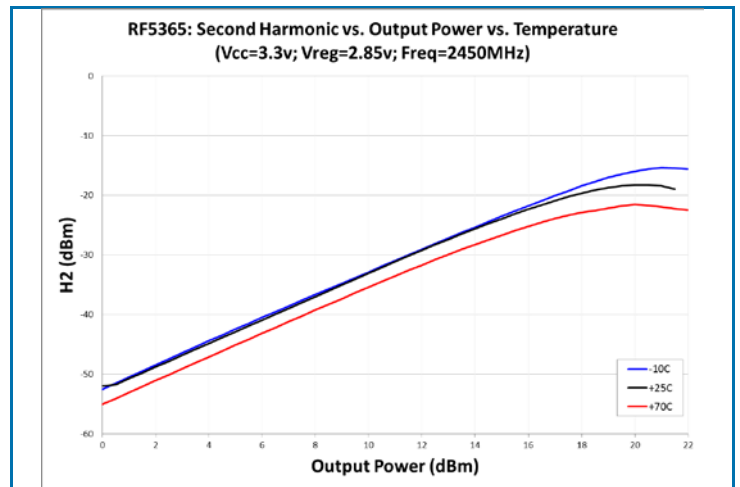
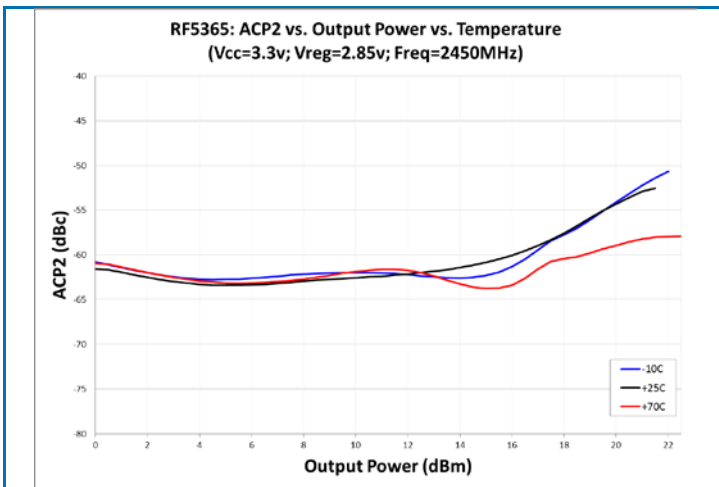
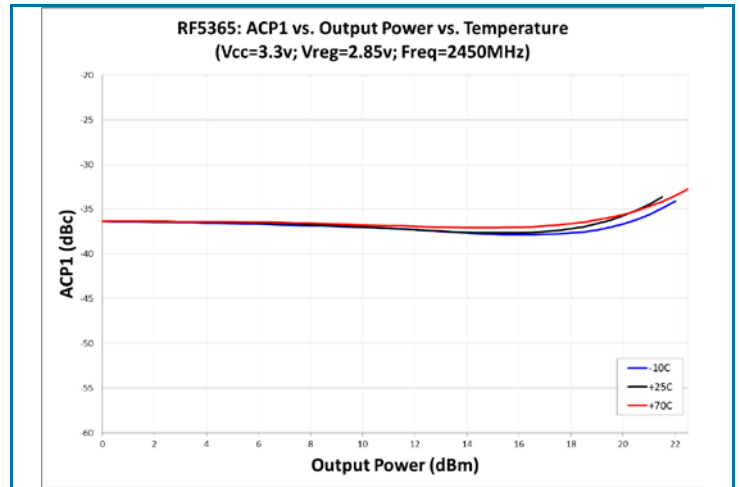
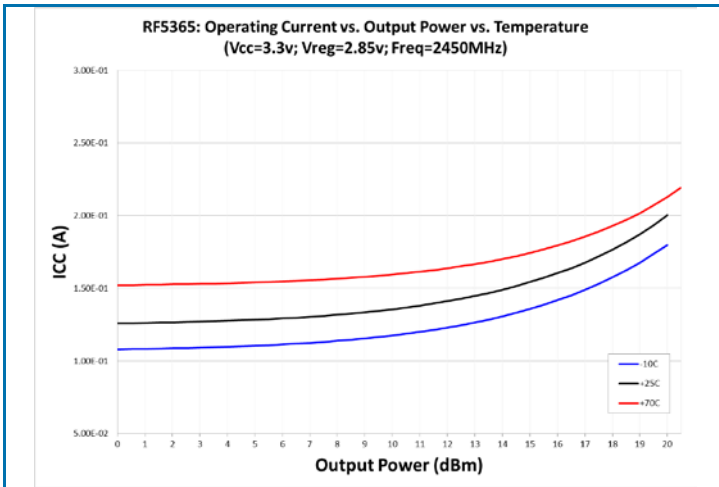
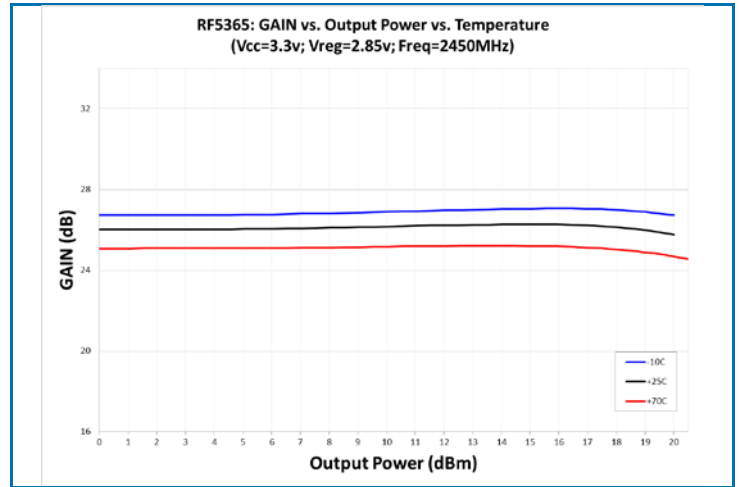
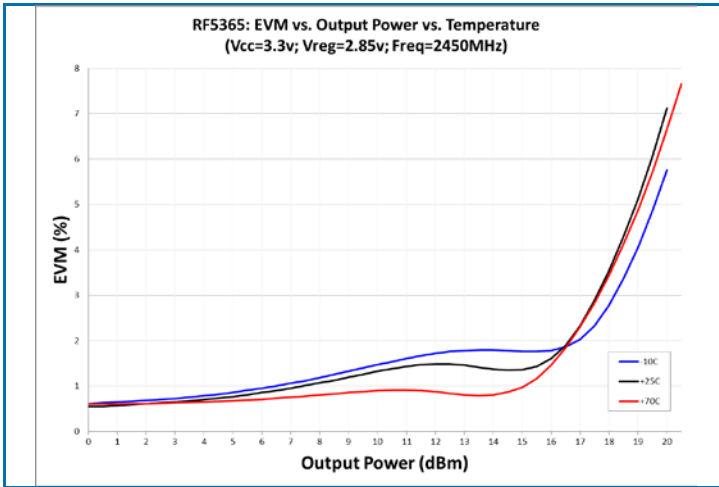

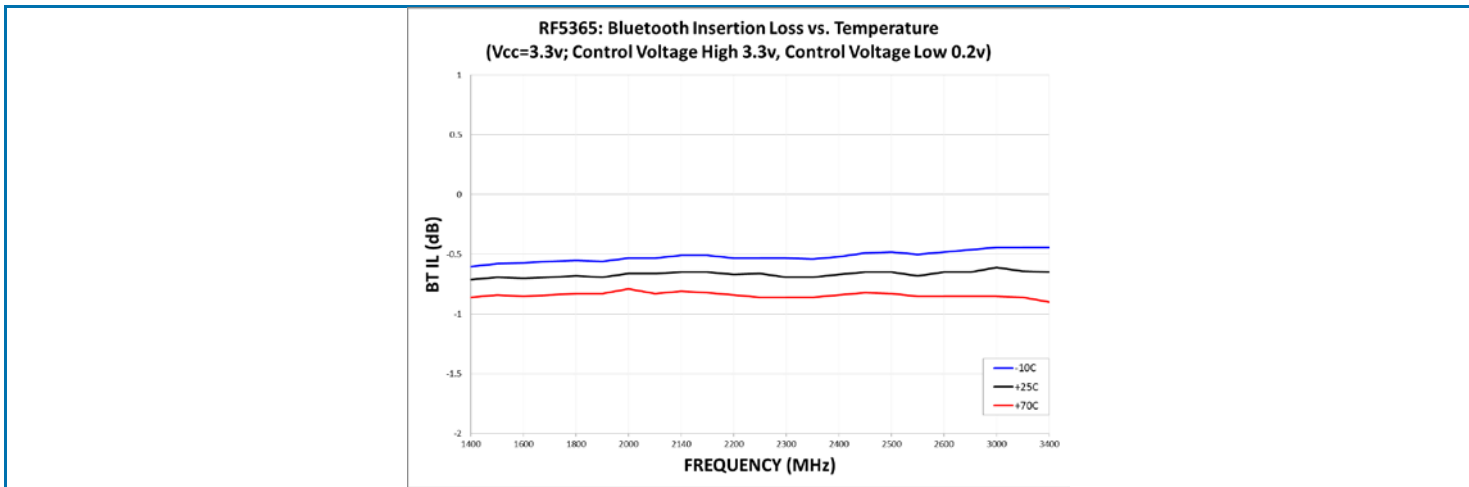
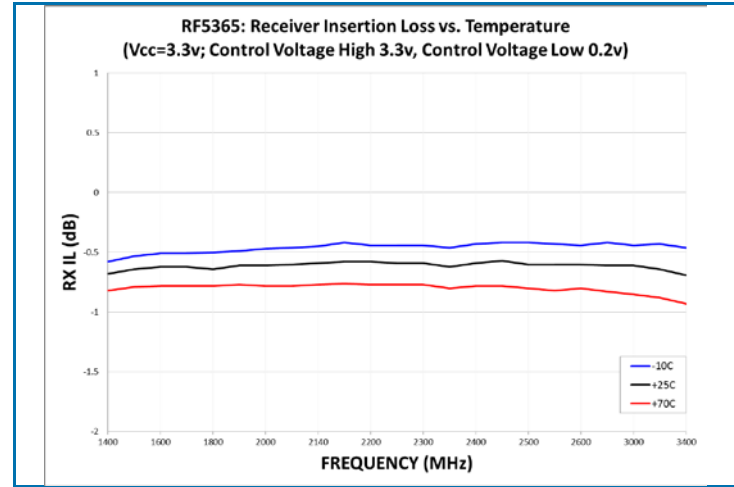
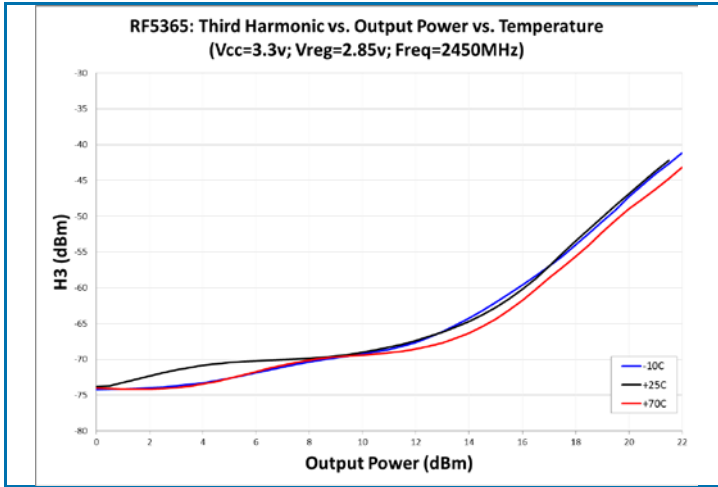

Evaluation Board Schematic

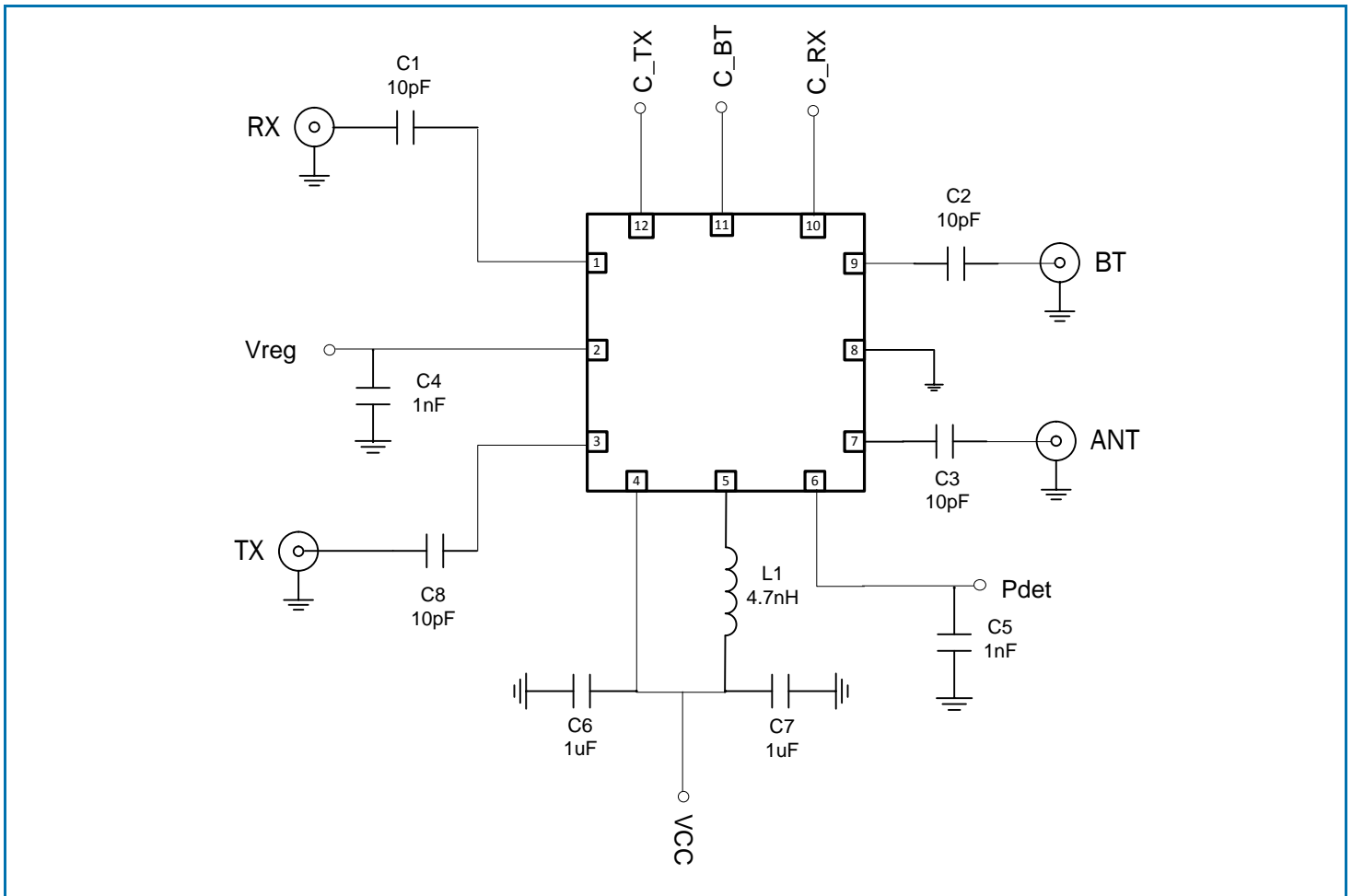

Note: Components C5, and C6 may not be needed in the final schematic. This will be dependent on board layout and noise coupling to these pins. TX input connects directly to the transceiver. If no DC is present on this pin, C8 may also be eliminated.

Evaluation Board Layout

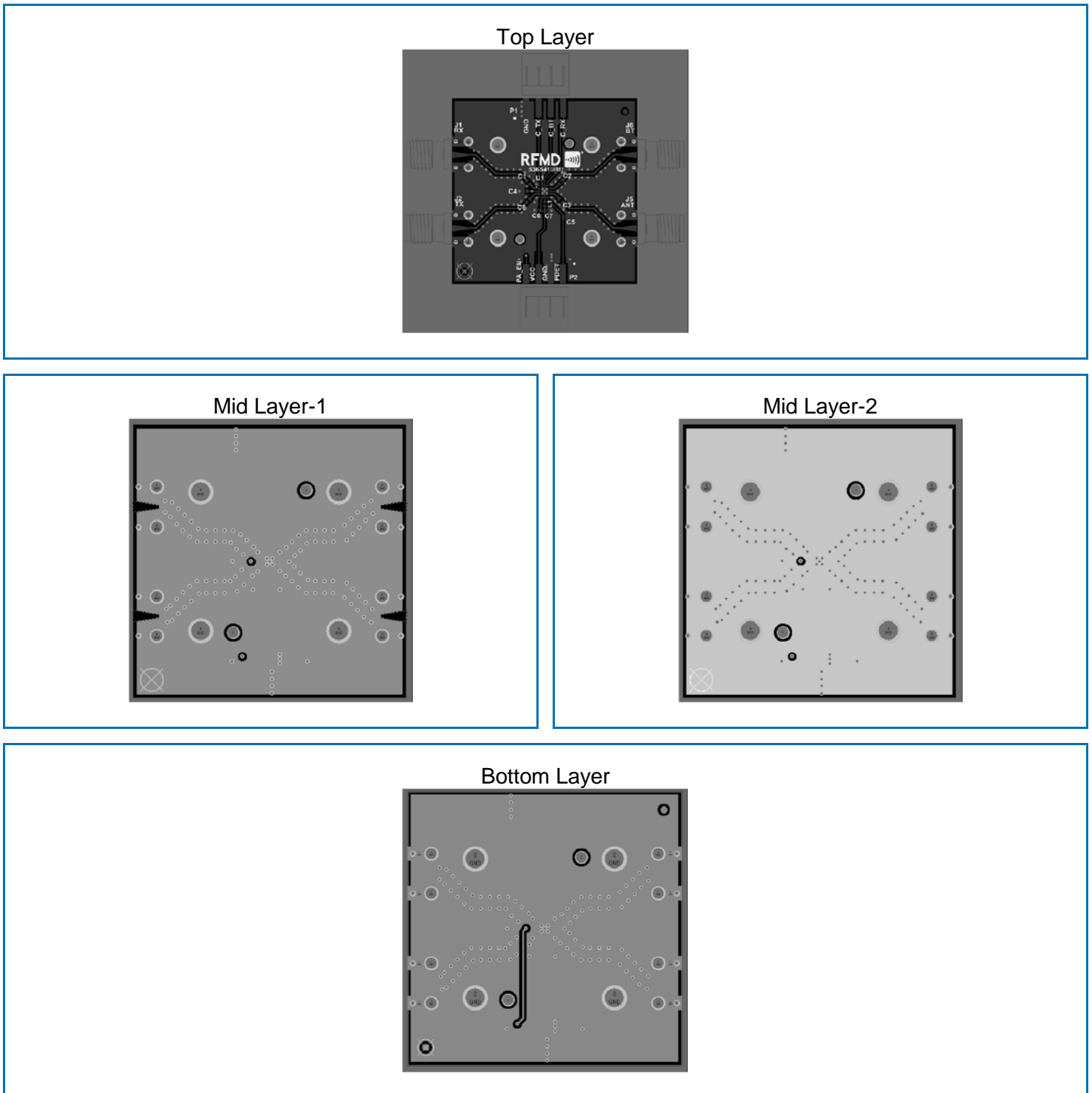

Note: For best performance, it is recommended to follow the routing and grounding of the RFMD evaluation board as close as possible. At a minimum, use five ground thermal vias on the package center slug (via size: 12mil hole by 21mil capture pad)

Pin Out

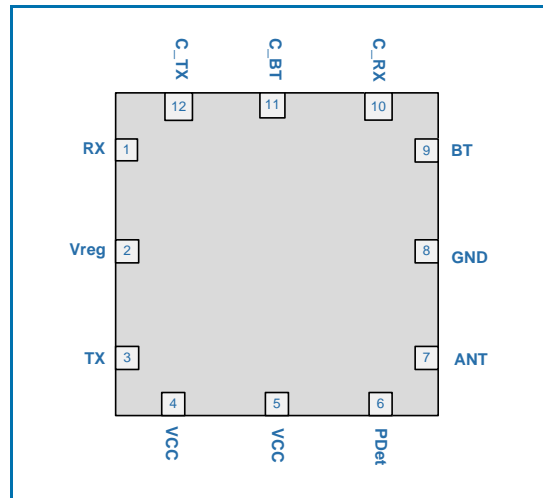

Package Outline Drawing

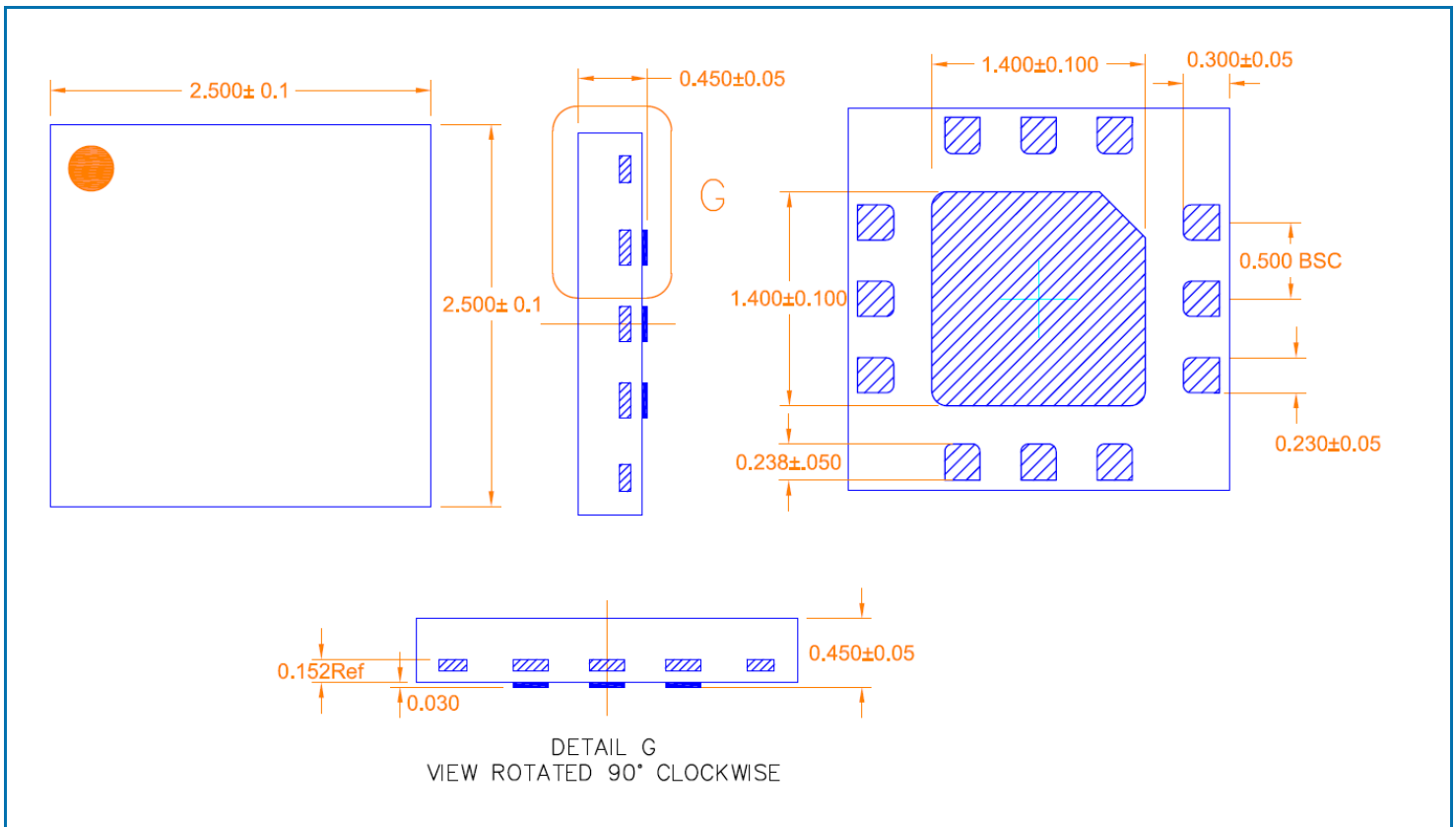

Note:

1. Pin 1 indicator shaded area
2. Chamfered area is Pin 1 indicator

PCB Recommendations

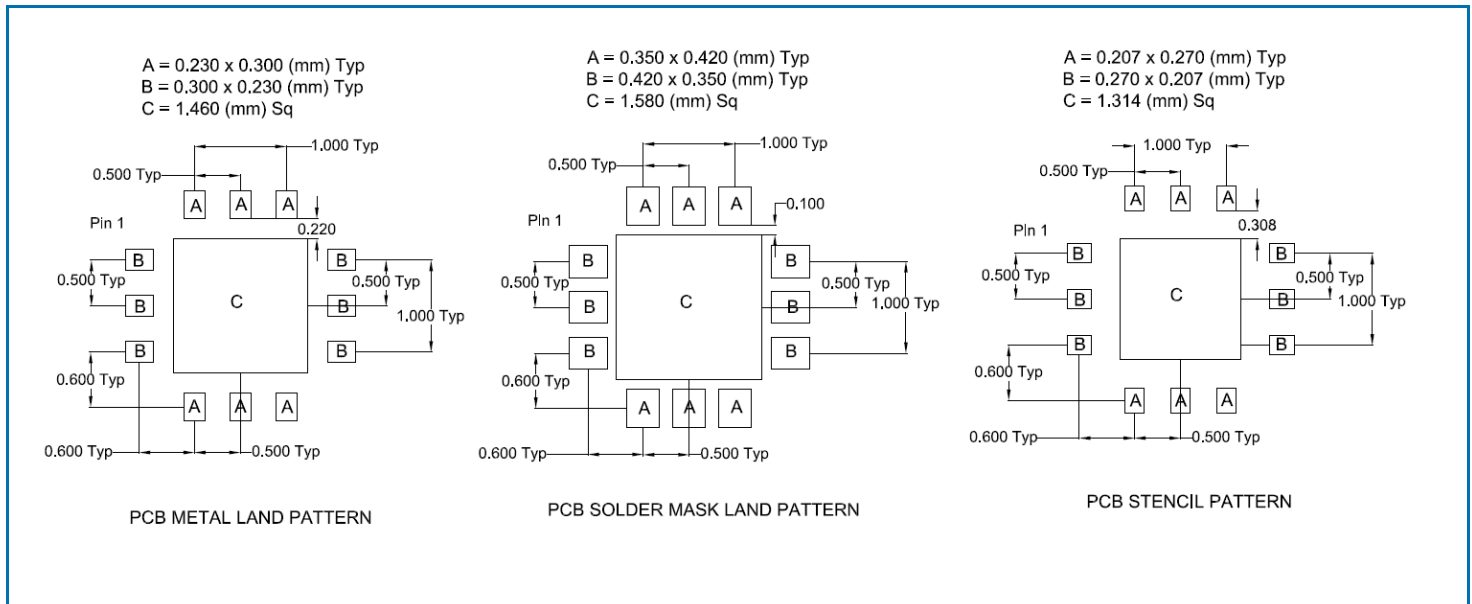

PCB land patterns for RFMD components are based on IPC-7351 standards and RFMD empirical data. The pad pattern shown has been developed and tested for optimized assembly at RFMD. The PCB land pattern has been developed to accommodate lead and package tolerances. Since surface mount processes vary from company to company, careful process development is recommended.

Thermal vias for center slug "B" should be incorporated into the PCB design. The number and size of thermal vias will depend on the application. Example of the number and size of vias can be found on the RFMD evaluation board layout.

Pin Names and Descriptions

Pin	Name	Description
1	RX OUT	Receive port for 802.11b/g/n band. Internally matched to 50Ω. DC block required.
2	VREG	Regulated voltage for the PA bias control circuit. An external bypass capacitor may be needed on the VREG line for decoupling purposes.
3	TX IN	RF input for the 802.11b/g/n PA. Input is matched to 50Ω. DC block required.
4	VCC	Supply voltage for the FEM. Power down pin. Apply $<0.6 V_{DC}$ to power down the power amplifier stages. Apply $2.5 V_{DC}$ to $3.6 V_{DC}$ to power up. If function is not desired, pin may be connected to V_{CC} or V_{REG} .
5	VCC	Supply voltage for the FEM.
6	POWER DETECT	Power detector voltage for TX section. P_{DET} voltage varies with output power. May need external decoupling.
7	ANT	Port matched to 50Ω. DC block required.
8	GND	Ground connection.
9	BT PORT	Bluetooth® RF Port. DC block required.
10	C_RX	Control pin for WiFi Receive Port. Please see truth table for proper settings.
11	C_BT	Control pin for Bluetooth® Port. Please see truth table for proper settings.
12	C_TX	Control pin for WiFi Transmit Port. Please see truth table for proper settings.
Pkg Base	GND	Ground connection. The backside of the package should be connected to the ground plane through a short path, i.e., PCB vias under the device are recommended.

Компания «Океан Электроники» предлагает заключение долгосрочных отношений при поставках импортных электронных компонентов на взаимовыгодных условиях!

Наши преимущества:

- Поставка оригинальных импортных электронных компонентов напрямую с производств Америки, Европы и Азии, а так же с крупнейших складов мира;
- Широкая линейка поставок активных и пассивных импортных электронных компонентов (более 30 млн. наименований);
- Поставка сложных, дефицитных, либо снятых с производства позиций;
- Оперативные сроки поставки под заказ (от 5 рабочих дней);
- Экспресс доставка в любую точку России;
- Помощь Конструкторского Отдела и консультации квалифицированных инженеров;
- Техническая поддержка проекта, помощь в подборе аналогов, поставка прототипов;
- Поставка электронных компонентов под контролем ВП;
- Система менеджмента качества сертифицирована по Международному стандарту ISO 9001;
- При необходимости вся продукция военного и аэрокосмического назначения проходит испытания и сертификацию в лаборатории (по согласованию с заказчиком);
- Поставка специализированных компонентов военного и аэрокосмического уровня качества (Xilinx, Altera, Analog Devices, Intersil, Interpoint, Microsemi, Actel, Aeroflex, Peregrine, VPT, Syfer, Eurofarad, Texas Instruments, MS Kennedy, Miteq, Cobham, E2V, MA-COM, Hittite, Mini-Circuits, General Dynamics и др.);

Компания «Океан Электроники» является официальным дистрибьютором и эксклюзивным представителем в России одного из крупнейших производителей разъемов военного и аэрокосмического назначения «JONHON», а так же официальным дистрибьютором и эксклюзивным представителем в России производителя высокотехнологичных и надежных решений для передачи СВЧ сигналов «FORSTAR».



JONHON

«JONHON» (основан в 1970 г.)

Разъемы специального, военного и аэрокосмического назначения:

(Применяются в военной, авиационной, аэрокосмической, морской, железнодорожной, горно- и нефтедобывающей отраслях промышленности)

«FORSTAR» (основан в 1998 г.)

ВЧ соединители, коаксиальные кабели,
кабельные сборки и микроволновые компоненты:

(Применяются в телекоммуникациях гражданского и специального назначения, в средствах связи, РЛС, а так же военной, авиационной и аэрокосмической отраслях промышленности).



Телефон: 8 (812) 309-75-97 (многоканальный)

Факс: 8 (812) 320-03-32

Электронная почта: ocean@oceanchips.ru

Web: <http://oceanchips.ru/>

Адрес: 198099, г. Санкт-Петербург, ул. Калинина, д. 2, корп. 4, лит. А