

Typical Applications

The HMC476MP86 / HMC476MP86E is an ideal RF/IF gain block & LO or PA driver for:

- Cellular / PCS / 3G
- Fixed Wireless & WLAN
- CATV, Cable Modem & DBS
- Microwave Radio & Test Equipment

Functional Diagram

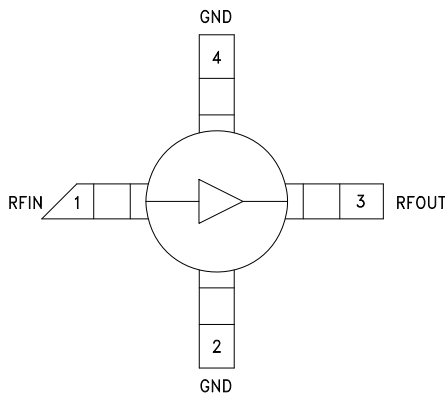

Features

- P1dB Output Power: +12 dBm
- Gain: 20 dB
- Output IP3: +25 dBm
- Cascadable 50 Ohm I/Os
- Single Supply: +5V to +12V
- Included in the HMC-DK001 Designer's Kit

General Description

The HMC476MP86 & HMC476MP86E are SiGe Heterojunction Bipolar Transistor (HBT) Gain Block MMIC SMT amplifiers covering DC to 6 GHz. This Micro-P packaged amplifier can be used as a cascadable 50 Ohm RF/IF gain stage as well as a LO or PA driver with up to +13 dBm output power. The HMC476MP86 & HMC476MP86E offers 20 dB of gain with a +25 dBm output IP3 at 850 MHz while requiring only 35 mA from a single positive supply. The Darlington feedback pair used results in reduced sensitivity to normal process variations and excellent gain stability over temperature while requiring a minimal number of external bias components.

Electrical Specifications, $V_s = 5V$, $R_{bias} = 56 \text{ Ohm}$, $T_A = +25^\circ \text{ C}$

Parameter		Min.	Typ.	Max.	Units
Gain	DC - 1.0 GHz	18.5	20.0		dB
	1.0 - 2.0 GHz	15.5	17.0		dB
	2.0 - 3.0 GHz	13.5	15.0		dB
	3.0 - 4.0 GHz	11.5	13.0		dB
	4.0 - 6.0 GHz	9.0	10.5		dB
Gain Variation Over Temperature	DC - 6 GHz		0.008	0.012	dB/ °C
Input Return Loss	DC - 1.0 GHz		20		dB
	1.0 - 6.0 GHz		15		dB
Output Return Loss	DC - 4.5 GHz		20		dB
	4.5 - 6.0 GHz		13		dB
Reverse Isolation	DC - 6 GHz		18		dB
Output Power for 1 dB Compression (P1dB)	0.5 - 5.0 GHz	9.0	12.0		dBm
	5.0 - 6.0 GHz	8.0	11.0		dBm
Output Third Order Intercept (IP3) (Pout= 0 dBm per tone, 1 MHz spacing)	DC - 5 GHz		25		dBm
	5.0 - 6.0 GHz		23		dBm
Noise Figure	DC - 3.0 GHz		2.5		dB
	3.0 - 6.0 GHz		3.5		dB
Supply Current (Icq)			35		mA

Note: Data taken with broadband bias tee on device output.

For price, delivery and to place orders: Hittite Microwave Corporation, 20 Alpha Road, Chelmsford, MA 01824

Phone: 978-250-3343 Fax: 978-250-3373 Order On-line at www.hittite.com

Application Support: Phone: 978-250-3343 or apps@hittite.com

Broadband Gain & Return Loss

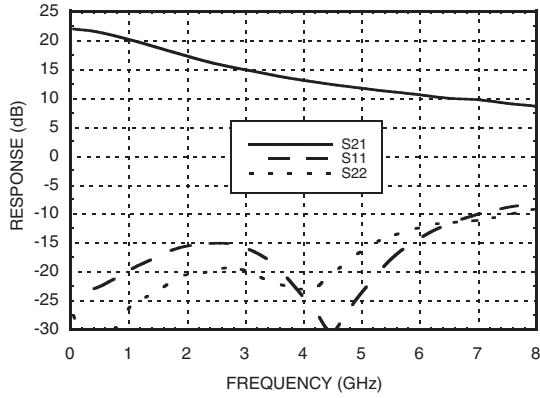

Gain vs. Temperature

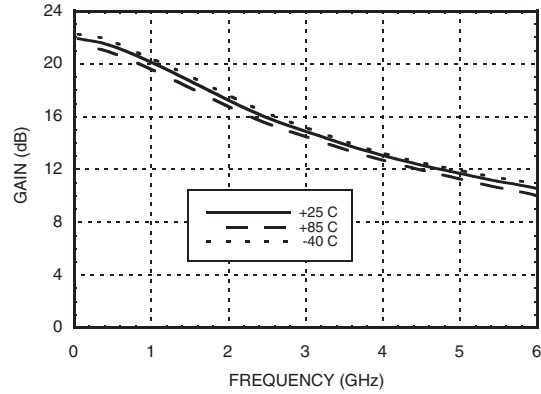

Input Return Loss vs. Temperature

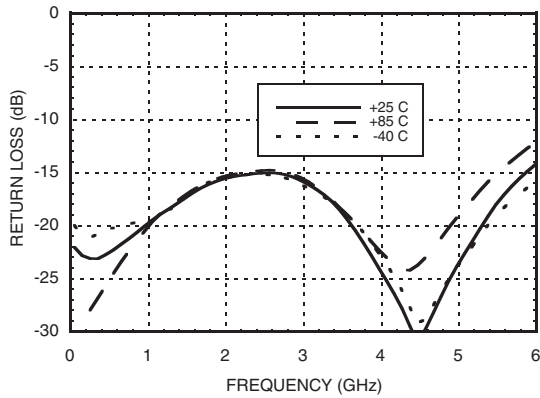

Output Return Loss vs. Temperature

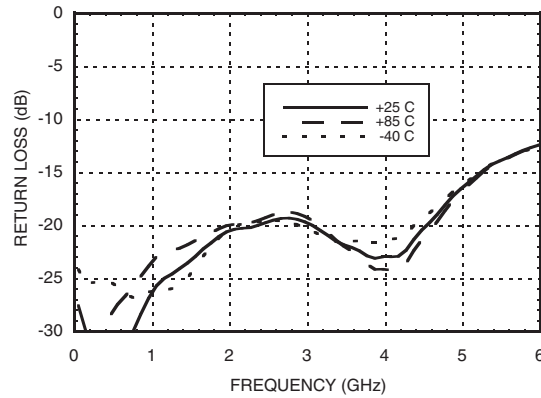

Reverse Isolation vs. Temperature

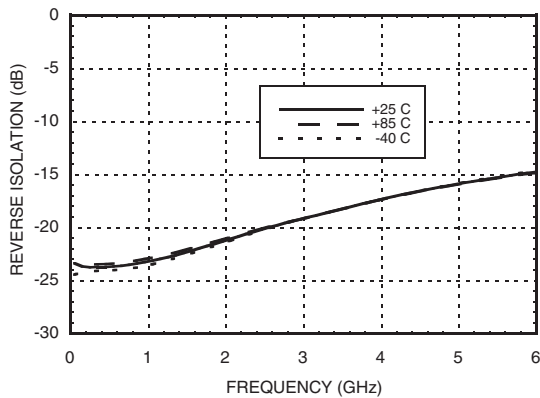

Noise Figure vs. Temperature

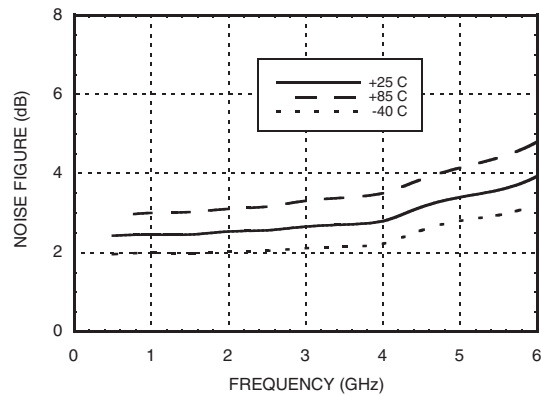

P1dB vs. Temperature

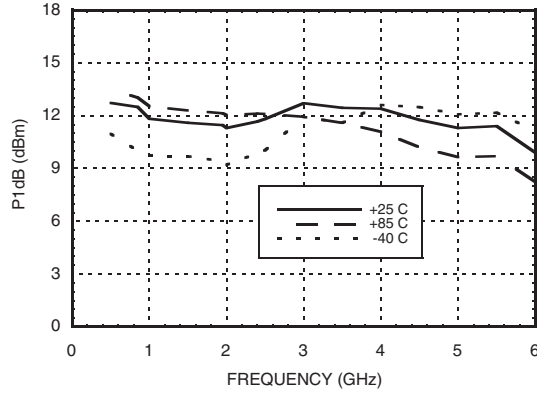

Psat vs. Temperature

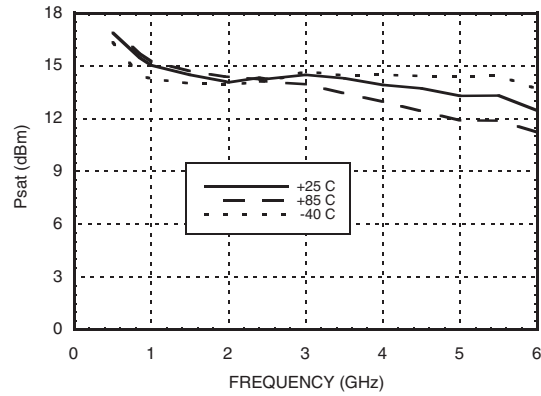

Output IP3 vs. Temperature

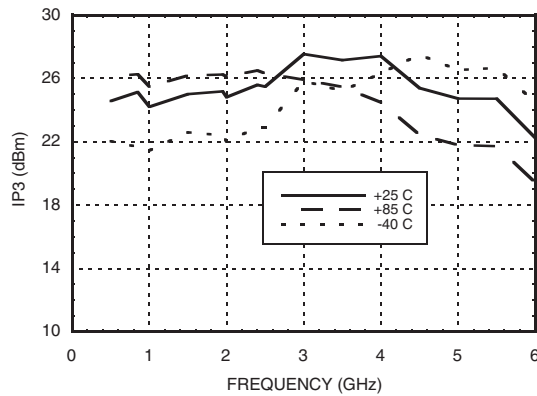

Gain, Power & OIP3 vs. Supply Voltage for Constant Id= 35 mA @ 850 MHz

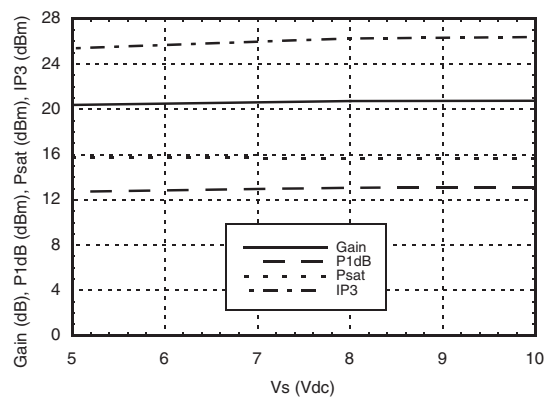

**Vcc vs. Icc Over Temperature for
Fixed Vs= 5V, RBIAS= 56 Ohms**

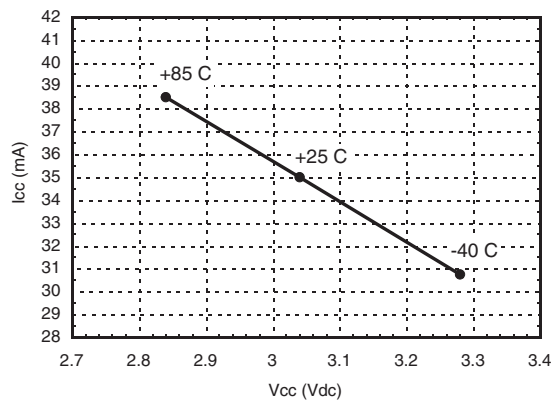

Absolute Maximum Ratings

Collector Bias Voltage (Vcc)	+6.0 Vdc
Collector Bias Current (Icc)	45 mA
RF Input Power (RFIN)(Vcc = +3.0 Vdc)	+5 dBm
Junction Temperature	150 °C
Continuous Pdiss (T = 85 °C) (derate 7.75 mW/°C above 85 °C)	0.504 W
Thermal Resistance (junction to lead)	129 °C/W
Storage Temperature	-65 to +150 °C
Operating Temperature	-40 to +85 °C



ELECTROSTATIC SENSITIVE DEVICE
OBSERVE HANDLING PRECAUTIONS

Outline Drawing

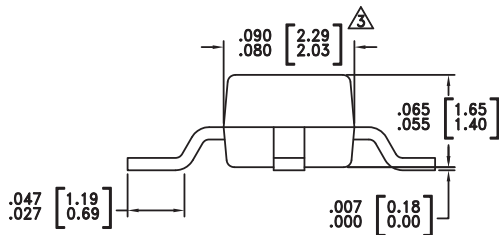
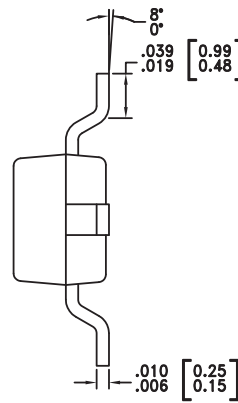
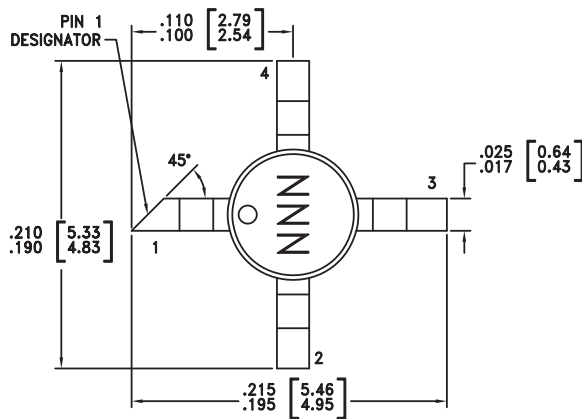

NOTES:

1. LEADFRAME MATERIAL: COPPER ALLOY
2. DIMENSIONS ARE IN INCHES [MILLIMETERS]
- △ DIMENSION DOES NOT INCLUDE MOLDFLASH OF 0.15mm PER SIDE.
4. ALL GROUND LEADS MUST BE SOLDERED TO PCB RF GROUND.
5. THE MICRO-P PACKAGE IS DIMENSIONALLY COMPATIBLE WITH THE "MICRO-X PACKAGE"

Package Information

Part Number	Package Body Material	Lead Finish	MSL Rating	Package Marking
HMC476MP86	Low Stress Injection Molded Plastic	Sn/Pb Solder	MSL1 ^[1]	476
HMC476MP86E	RoHS-compliant Low Stress Injection Molded Plastic	100% matte Sn	MSL1 ^[2]	476

[1] Max peak reflow temperature of 235 °C

[2] Max peak reflow temperature of 260 °C

Pin Descriptions

Pin Number	Function	Description	Interface Schematic
1	RFIN	This pin is DC coupled. An off chip DC blocking capacitor is required.	
3	RFOUT	RF output and DC Bias (Vcc) for the output stage.	
2, 4	GND	These pins must be connected to RF/DC ground.	

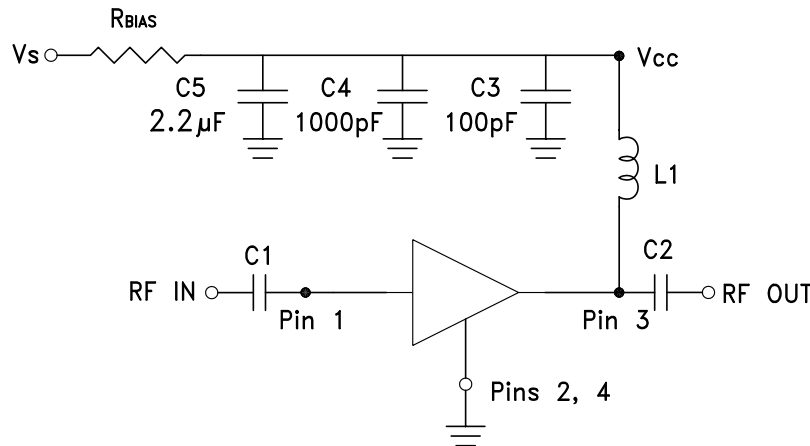
Application Circuit

**Recommended Bias Resistor Values
for $I_{cc} = 35 \text{ mA}$, $R_{bias} = (V_s - V_{cc}) / I_{cc}$**

Supply Voltage (Vs)	5V	8V	10V	12V
RBIAS VALUE	56 Ω	130 Ω	180 Ω	240 Ω
RBIAS POWER RATING	1/8 W	1/4 W	1/4 W	1/2 W

Note:

- External blocking capacitors are required on RFIN and RFOUT.
- RBIAS provides DC bias stability over temperature.

Recommended Component Values for Key Application Frequencies

Component	Frequency (MHz)							
	50	900	1900	2200	2400	3500	5200	5800
L1	270 nH	56 nH	18 nH	18 nH	15 nH	8.2 nH	6.8 nH	3.3 nH
C1, C2	0.01 μF	100 pF	100 pF	100 pF	100 pF	100 pF	100 pF	100 pF

Evaluation PCB

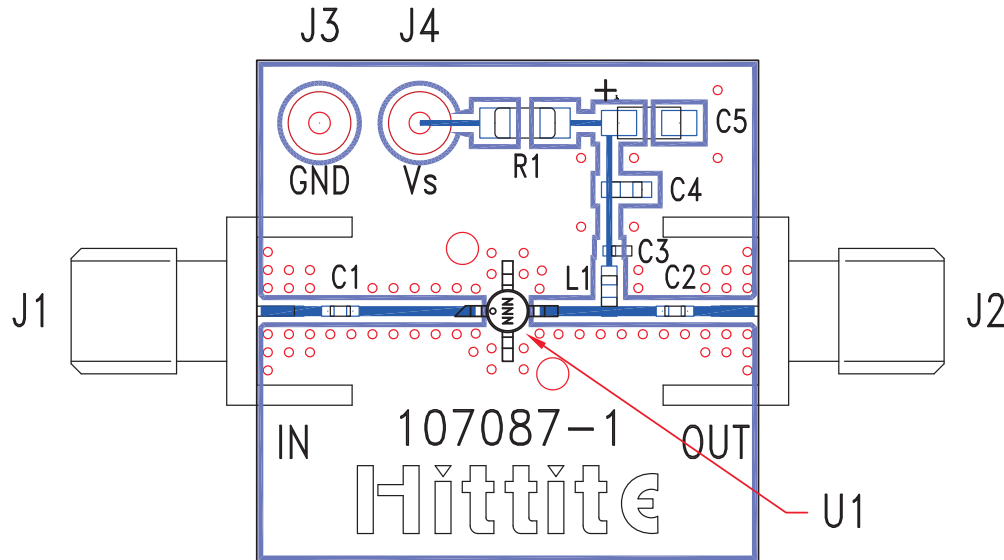

List of Materials for Evaluation PCB 107487 [1]

Item	Description
J1 - J2	PCB Mount SMA Connector
J3 - J4	DC Pin
C1, C2	Capacitor, 0402 Pkg.
C3	100 pF Capacitor, 0402 Pkg.
C4	1000 pF Capacitor, 0603 Pkg.
C5	2.2 μ F Capacitor, Tantalum
R1	Resistor, 1210 Pkg.
L1	Inductor, 0603 Pkg.
U1	HMC476MP86 / HMC476MP86E
PCB [2]	107087 Evaluation PCB

[1] Reference this number when ordering complete evaluation PCB

[2] Circuit Board Material: Rogers 4350

The circuit board used in the application should use RF circuit design techniques. Signal lines should have 50 Ohm impedance while the package ground leads should be connected directly to the ground plane similar to that shown. A sufficient number of via holes should be used to connect the top and bottom ground planes. The evaluation board should be mounted to an appropriate heat sink. The evaluation circuit board shown is available from Hittite upon request.

Компания «Океан Электроники» предлагает заключение долгосрочных отношений при поставках импортных электронных компонентов на взаимовыгодных условиях!

Наши преимущества:

- Поставка оригинальных импортных электронных компонентов напрямую с производств Америки, Европы и Азии, а так же с крупнейших складов мира;
- Широкая линейка поставок активных и пассивных импортных электронных компонентов (более 30 млн. наименований);
- Поставка сложных, дефицитных, либо снятых с производства позиций;
- Оперативные сроки поставки под заказ (от 5 рабочих дней);
- Экспресс доставка в любую точку России;
- Помощь Конструкторского Отдела и консультации квалифицированных инженеров;
- Техническая поддержка проекта, помощь в подборе аналогов, поставка прототипов;
- Поставка электронных компонентов под контролем ВП;
- Система менеджмента качества сертифицирована по Международному стандарту ISO 9001;
- При необходимости вся продукция военного и аэрокосмического назначения проходит испытания и сертификацию в лаборатории (по согласованию с заказчиком);
- Поставка специализированных компонентов военного и аэрокосмического уровня качества (Xilinx, Altera, Analog Devices, Intersil, Interpoint, Microsemi, Actel, Aeroflex, Peregrine, VPT, Syfer, Eurofarad, Texas Instruments, MS Kennedy, Miteq, Cobham, E2V, MA-COM, Hittite, Mini-Circuits, General Dynamics и др.);

Компания «Океан Электроники» является официальным дистрибьютором и эксклюзивным представителем в России одного из крупнейших производителей разъемов военного и аэрокосмического назначения «JONHON», а так же официальным дистрибьютором и эксклюзивным представителем в России производителя высокотехнологичных и надежных решений для передачи СВЧ сигналов «FORSTAR».



JONHON

«JONHON» (основан в 1970 г.)

Разъемы специального, военного и аэрокосмического назначения:

(Применяются в военной, авиационной, аэрокосмической, морской, железнодорожной, горно- и нефтедобывающей отраслях промышленности)

«FORSTAR» (основан в 1998 г.)

ВЧ соединители, коаксиальные кабели, кабельные сборки и микроволновые компоненты:

(Применяются в телекоммуникациях гражданского и специального назначения, в средствах связи, РЛС, а так же военной, авиационной и аэрокосмической отраслях промышленности).



Телефон: 8 (812) 309-75-97 (многоканальный)

Факс: 8 (812) 320-03-32

Электронная почта: ocean@oceanchips.ru

Web: <http://oceanchips.ru/>

Адрес: 198099, г. Санкт-Петербург, ул. Калинина, д. 2, корп. 4, лит. А