

Features

- Replacement for R-78Axx-0.5SMD series
- RoHS 6/6 Conform (100% Lead Free)
- Efficiency up to 97%, Non isolated, no need for heatsinks
- High Reflow Temperature SMD Package
- Adjustable Output Voltage
- Wide input range.(4.75V ~ 32V)
- Short circuit protection, Thermal shutdown
- Remote On/Off Control
- UL94V-0 Package Material
- Very Low Shutdown Current
- See Ininline Application Notes for use as an inverter (alternative to LM79xx Linear)

Description

The R-78Axx-0.5SMD series are manufactured without lead and meet the requirements for RoHS 6/6 as well as the increased reflow soldering temperatures associated with vapour phase soldering, making these high efficiency switching regulators ideally suited to modern pick-and-place mass production. The efficiency of up to 97% means that very little energy is wasted as heat. The additional features of remote on/off control and adjustable output voltages will find many uses in the battery-powered, industrial, medical and automotive markets.

Selection Guide

| Part Number SMD | Input Range (V) | Output Voltage (V) | Adjust Range (V) | Output Current (A) | Efficiency (%) | |
|------------------|-----------------|--------------------|------------------|--------------------|----------------|----------|
| | | | | | Min. Vin | Max. Vin |
| R-78AA1.5-0.5SMD | 4.75 – 30 | 1.5 | fixed | 0.5 | 73 | 63 |
| R-78AA1.8-0.5SMD | 4.75 – 32 | 1.8 | 1.5~3.0 | 0.5 | 82 | 71 |
| R-78AA2.5-0.5SMD | 4.75 – 32 | 2.5 | 1.5~3.0 | 0.5 | 87 | 77 |
| R-78AA3.3-0.5SMD | 4.75 – 32 | 3.3 | 3.0~5.5 | 0.5 | 91 | 81 |
| R-78AA5.0-0.5SMD | 6.5 – 32 | 5.0 | 3.0~8.0 | 0.5 | 94 | 86 |
| R-78AA6.5-0.5SMD | 8.0 – 32 | 6.5 | 3.3~11.0 | 0.5 | 95 | 88 |
| R-78AA9.0-0.5SMD | 11 – 32 | 9.0 | 4.5~12.6 | 0.5 | 96 | 92 |
| R-78AA12-0.5SMD | 15 – 32 | 12 | 4.5~12.6 | 0.5 | 97 | 94 |
| R-78AA15-0.5SMD | 18 – 32 | 15 | fixed | 0.5 | 97 | 95 |

Note 1: 1.5V Output can be unstable with Vin > 30VDC

* add suffix -R for tape&reel packing e.g. R-78AA5.0-0.5-R. For more details see Application Notes.

Standard Application Circuit



To protect the converter from high inrush currents, use soft start Vin and C1=10µF
Output capacitor C2 recommended if load is very dynamic

INNOLINE
DC/DC-Converter
with 3 year Warranty

RECOM

0.5 AMP
SMD
Single Output



EN-60950-1 Certified

R-78AA-0.5

Derating-Graph (Ambient Temperature)

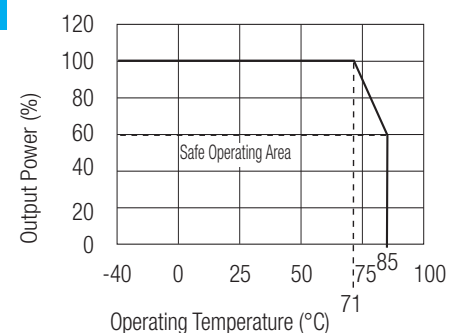

Specifications (typical at 25°C, 10% minimum load, unless otherwise specified)

| Characteristics | Conditions | Min. | Typ. | Max. |
|---|--|---------------------|--------------------------------|-------------------------------------|
| Input Voltage Range | See Table | 4.75V | 32V | 34V abs. max. |
| Output Voltage Range | See Table | 1.5V | | 15V |
| Output Current (see Note) | All Series | 0mA* | | 500mA |
| Output Current Limit | All Series | | | 2000mA |
| Short Circuit Input Current | Vin = 24V | | 60mA | 100mA |
| Internal Power Dissipation | | | | 0.4W |
| Short Circuit Protection | | | Continuous, automatic recovery | |
| Output Voltage Accuracy | 100% Load | | ±2% | ±3% |
| Adjustable Voltage Range | See Table 1 | | | ±50% |
| Line Voltage Regulation (Vin = min. to max. at full load) | 1.5V to 6.5V | | 0.2% | 0.4% |
| | 9V to 15V | | 0.1% | 0.2% |
| Load Regulation (10 to 100% full load) | 1.5V to 6.5V | | 0.7% | 1.0% |
| | 9V to 15V | | 0.25% | 0.4% |
| Dynamic Load Stability with 100µF Output capacitor | 100% <-> 50% load | | ±75V | ±100mV |
| | 100% <-> 10% load | | ±100mV | |
| Ripple & Noise (without Output Capacitor) | 1.5V to 6.5V | | 20mVp-p | 30mVp-p |
| | 9V to 15.5V | | 30mVp-p | 40mVp-p |
| Temperature Coefficient | -40°C ~ +85°C ambient | | | 0.015%/°C |
| Max capacitance Load | with normal start-up time, no external components | | | 220µF |
| | with <1 second start up time + diode protection circuit | | | 6800µF |
| Switching Frequency | | 280kHz | 330kHz | 380kHz |
| Quiescent Current | Vin = min. to max. at 0% load | | 5mA | 7mA |
| ON/OFF Remote Control Pin Drive Current | ON: Open or 1.6V<Vr<5V | | | |
| | OFF: GND or 0<Vr<1.6V | | Ir=1.8µA typ | |
| Converter Input Current (valid for Vr < 1.6V) | | | 20µA | 30µA |
| Remote On/Off Threshold Voltage (Vr rising) | | 2.4V | 2.6V | 2.8V |
| Remote On/Off Voltage Hysteresis | | | 250mV | |
| Operating Temperature Range (with derating) | | -40°C | | +85°C |
| Switch On/Off Time | (using Remote On/Off Control) | | | 50ms |
| Operating Case Temperature | | | | +100°C |
| Storage Temperature Range | | -55°C | | +125°C |
| Case Thermal Impedance | | | | 70°C / W |
| Thermal Shutdown | Internal IC junction | | | +160°C |
| Case Material | | | | Non-Conductive Black Plastic |
| Potting Material | | | | Epoxy (UL94V-0) |
| EMC | Conducted Emissions (with filter) | EN55022 | | Class B |
| | Radiated Emissions (with filter) | EN55022 | | Class B |
| | ESD | EN61000-4-2 | | Class A |
| | Radiated Immunity | EN61000-4-3 | | Class A |
| | Fast Transient | EN61000-4-4 | | Class A |
| | Conducted Immunity | EN61000-4-6 | | Class A |
| | Magnetic Field Immunity | EN61000-4-8 | | Class A |
| | Safety Certification | Report: PS-R7242C1 | | |
| Package Weight | | | 2.7g | |
| Packing Quantity | | | | 33pcs per Tube |
| | | | | 250pcs per Reel |
| MTBF (+25°C) (+71°C) | } Detailed Information see Application Notes chapter "MTBF" | using MIL-HDBK 217F | | 21098~29253 x 10 ³ hours |
| | | | | 4214-7365 x 10 ³ hours |

*Note: Operation under no load will not damage these devices, however they may not meet all specifications. A minimum load of 6mA is recommended

Characteristics

Efficiency

Ripple

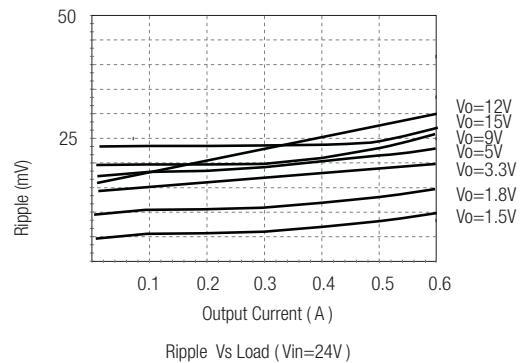
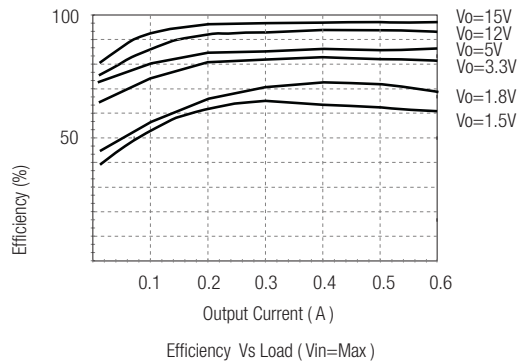
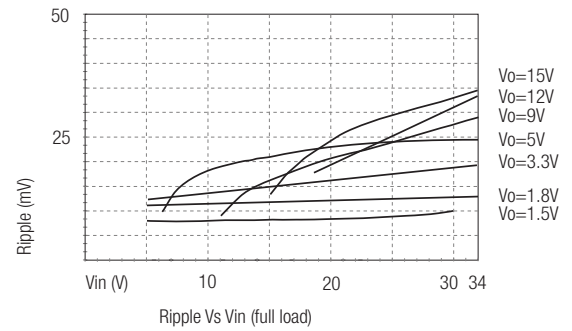

R-78AA-0.5

Application Examples

Flash Memory Program Voltage Switcher



"Program" = 0V, Pgm Pin = +5V
 "Program" = high, Pgm Pin = +12,6V

DC/DC Converter (1:1)



- High isolation voltage
- Improved loading / line regulation
- Wide Input Voltage Range
- Point-of-Load Architecture
- Remote On/Off Control

Optional Protection Circuit

Optional Protection 1:

Add a blocking diode to Vout if current can flow backwards into the output, as this can damage the converter when it is powered down.

The diode can either be fitted across the device if the source is low impedance or fitted in series with the output (recommended).

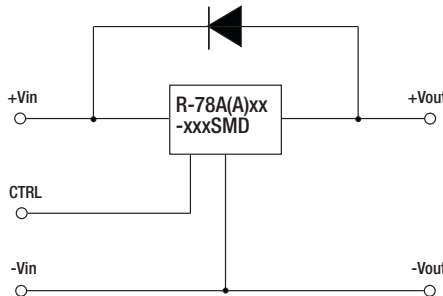

Optional Protection 2:

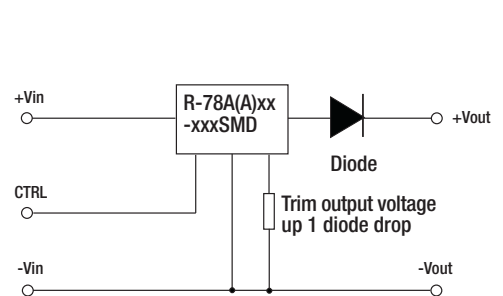

Application example:
Driving a high capacitive load

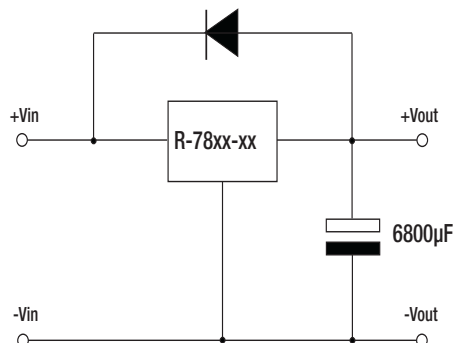

Table 1: Adjustment Resistor Values

| 0.5A _{dc} | R-78AA1.8 | | R-78AA2.5 | | R-78AA3.3 | | R-78AA5.0 | | R-78AA6.5 | | R-78AA9.0 | | R-78AA12 | |
|-------------------------|--------------------|----------------|--------------------|----------------|--------------------|----------------|--------------------|----------------|--------------------|----------------|--------------------|----------------|---------------------|---------------|
| V _{out} (nom.) | -0.5SMD | | -0.5SMD | | -0.5SMD | | -0.5SMD | | -0.5SMD | | -0.5SMD | | -0.5SMD | |
| | 1.8V _{dc} | | 2.5V _{dc} | | 3.3V _{dc} | | 5.0V _{dc} | | 6.5V _{dc} | | 9.0V _{dc} | | 12.0V _{dc} | |
| V _{out} (adj.) | R1 | R2 | R1 | R2 | R1 | R2 | R1 | R2 | R1 | R2 | R1 | R2 | R1 | R2 |
| 1.5 (V) | 3K Ω | | 200 Ω | | | | | | | | | | | |
| 1.8 (V) | | | 12K Ω | | | | | | | | | | | |
| 2.5 (V) | | 11.8K Ω | | | | | | | | | | | | |
| 3.0 (V) | | 4.64K Ω | | 44.2K Ω | 88.4K Ω | | 17K Ω | | | | | | | |
| 3.3 (V) | | | | | | | 27K Ω | | 6.7K Ω | | | | | |
| 3.6 (V) | | | | | | 60.4K Ω | 42K Ω | | 14K Ω | | | | | |
| 3.9 (V) | | | | | | 28K Ω | 58K Ω | | 23K Ω | | | | | |
| 4.5 (V) | | | | | | 11.3K Ω | 180K Ω | | 49K Ω | | 26K Ω | | 17K Ω | |
| 4.9 (V) | | | | | | 7.15K Ω | 850K Ω | | 77K Ω | | 36K Ω | | 24K Ω | |
| 5.0 (V) | | | | | | 6.34K Ω | | | 86K Ω | | 39K Ω | | 26K Ω | |
| 5.1 (V) | | | | | | 5.9K Ω | | 231K Ω | 97K Ω | | 42K Ω | | 28K Ω | |
| 5.5 (V) | | | | | | 3.9K Ω | | 56.2K Ω | 160K Ω | | 56K Ω | | 36K Ω | |
| 6.5 (V) | | | | | | | | 14K Ω | | | 112K Ω | | 63K Ω | |
| 8.0 (V) | | | | | | | | 2.32K Ω | | 24.6K Ω | 400K Ω | | 125K Ω | |
| 9.0 (V) | | | | | | | | | | 10.7K Ω | | | 200K Ω | |
| 10 (V) | | | | | | | | | | 4.75K Ω | | 54.9K Ω | 345K Ω | |
| 11 (V) | | | | | | | | | | 1.65K Ω | | 16.5K Ω | 740K Ω | |
| 12 (V) | | | | | | | | | | | | 3.6K Ω | | |
| 12.6 (V) | | | | | | | | | | | | 0 Ω | | 180K Ω |

R-78AA-0.5

Package Style and Pinning (mm)

SMD 10Pin Package

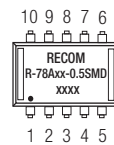

Recommended Footprint Details



Pin Connections

| Pin # | Connection |
|---------|---------------|
| 1,2 | +Vin |
| 3,7,8,9 | GND |
| 4,5 | +Vout |
| 6 | V adj |
| 10 | Remote On/Off |

xx.x $\pm 0.5\text{mm}$
xx.xx $\pm 0.25\text{mm}$

Компания «Океан Электроники» предлагает заключение долгосрочных отношений при поставках импортных электронных компонентов на взаимовыгодных условиях!

Наши преимущества:

- Поставка оригинальных импортных электронных компонентов напрямую с производств Америки, Европы и Азии, а так же с крупнейших складов мира;
- Широкая линейка поставок активных и пассивных импортных электронных компонентов (более 30 млн. наименований);
- Поставка сложных, дефицитных, либо снятых с производства позиций;
- Оперативные сроки поставки под заказ (от 5 рабочих дней);
- Экспресс доставка в любую точку России;
- Помощь Конструкторского Отдела и консультации квалифицированных инженеров;
- Техническая поддержка проекта, помощь в подборе аналогов, поставка прототипов;
- Поставка электронных компонентов под контролем ВП;
- Система менеджмента качества сертифицирована по Международному стандарту ISO 9001;
- При необходимости вся продукция военного и аэрокосмического назначения проходит испытания и сертификацию в лаборатории (по согласованию с заказчиком);
- Поставка специализированных компонентов военного и аэрокосмического уровня качества (Xilinx, Altera, Analog Devices, Intersil, Interpoint, Microsemi, Actel, Aeroflex, Peregrine, VPT, Syfer, Eurofarad, Texas Instruments, MS Kennedy, Miteq, Cobham, E2V, MA-COM, Hittite, Mini-Circuits, General Dynamics и др.);

Компания «Океан Электроники» является официальным дистрибьютором и эксклюзивным представителем в России одного из крупнейших производителей разъемов военного и аэрокосмического назначения «JONHON», а так же официальным дистрибьютором и эксклюзивным представителем в России производителя высокотехнологичных и надежных решений для передачи СВЧ сигналов «FORSTAR».



JONHON

«JONHON» (основан в 1970 г.)

Разъемы специального, военного и аэрокосмического назначения:

(Применяются в военной, авиационной, аэрокосмической, морской, железнодорожной, горно- и нефтедобывающей отраслях промышленности)

«FORSTAR» (основан в 1998 г.)

ВЧ соединители, коаксиальные кабели,
кабельные сборки и микроволновые компоненты:

(Применяются в телекоммуникациях гражданского и специального назначения, в средствах связи, РЛС, а так же военной, авиационной и аэрокосмической отраслях промышленности).



Телефон: 8 (812) 309-75-97 (многоканальный)

Факс: 8 (812) 320-03-32

Электронная почта: ocean@oceanchips.ru

Web: <http://oceanchips.ru/>

Адрес: 198099, г. Санкт-Петербург, ул. Калинина, д. 2, корп. 4, лит. А