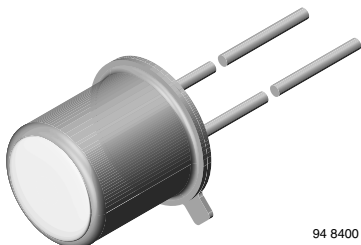


Infrared Emitting Diode, RoHS Compliant, 950 nm, GaAs



94 8400

DESCRIPTION

TSTS7500 is an infrared, 950 nm emitting diode in GaAs technology in a hermetically sealed TO-18 package with flat glass window.

FEATURES

- Package type: leaded
- Package form: TO-18
- Dimensions (in mm): \varnothing 4.7
- Peak wavelength: $\lambda_p = 950$ nm
- High reliability
- High radiant power
- High radiant intensity
- Angle of half intensity: $\varphi = \pm 30^\circ$
- Low forward voltage
- Suitable for high pulse current operation
- Good spectral matching with Si photodetectors
- Lead (Pb)-free component in accordance with RoHS 2002/95/EC and WEEE 2002/96/EC



RoHS
COMPLIANT

APPLICATIONS

- Radiation source in near infrared range

PRODUCT SUMMARY

COMPONENT	I_e (mW/sr)	φ (deg)	λ_p (nm)	t_r (ns)
TSTS7500	1.6	± 30	950	800

Note

Test conditions see table "Basic Characteristics"

ORDERING INFORMATION

ORDERING CODE	PACKAGING	REMARKS	PACKAGE FORM
TSTS7500	Bulk	MOQ: 1000 pcs, 1000 pcs/bulk	TO-18

Note

MOQ: minimum order quantity

ABSOLUTE MAXIMUM RATINGS

PARAMETER	TEST CONDITION	SYMBOL	VALUE	UNIT
Reverse voltage		V_R	5	V
Forward current	$T_{case} \leq 25^\circ\text{C}$	I_F	250	mA
Peak forward current	$t_p/T = 0.5$, $t_p \leq 100 \mu\text{s}$, $T_{case} \leq 25^\circ\text{C}$	I_{FM}	500	mA
Surge forward current	$t_p \leq 100 \mu\text{s}$	I_{FSM}	2.5	A
Power dissipation		P_V	170	mW
	$T_{case} \leq 25^\circ\text{C}$	P_V	500	mW
Junction temperature		T_j	100	$^\circ\text{C}$
Storage temperature range		T_{stg}	- 55 to + 100	$^\circ\text{C}$
Thermal resistance junction/ambient	leads not soldered	R_{thJA}	450	K/W
Thermal resistance junction/case	leads not soldered	R_{thJC}	150	K/W

Note

$T_{amb} = 25^\circ\text{C}$, unless otherwise specified



Fig. 1 - Power Dissipation Limit vs. Ambient Temperature

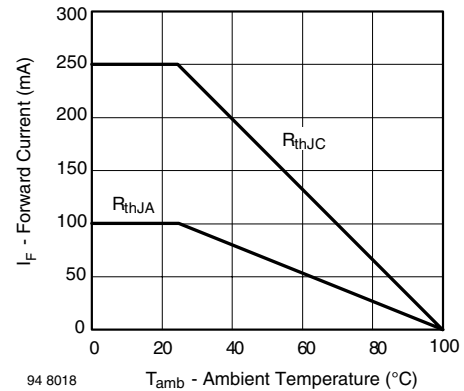


Fig. 2 - Forward Current Limit vs. Ambient Temperature

BASIC CHARACTERISTICS						
PARAMETER	TEST CONDITION	SYMBOL	MIN.	TYP.	MAX.	UNIT
Forward voltage	$I_F = 100 \text{ mA}$, $t_p \leq 20 \text{ ms}$	V_F		1.3	1.7	V
Temperature coefficient of V_F	$I_F = 100 \text{ mA}$	TK_{V_F}		- 1.3		mV/K
Breakdown voltage	$I_R = 100 \text{ }\mu\text{A}$	$V_{(BR)}$	5			V
Junction capacitance	$V_R = 0 \text{ V}$, $f = 1 \text{ MHz}$, $E = 0$	C_j		30		pF
Radiant intensity	$I_F = 100 \text{ mA}$, $t_p = 20 \text{ ms}$	I_e	1.25	1.6	8	mW/sr
Radiant power	$I_F = 100 \text{ mA}$, $t_p \leq 20 \text{ ms}$	ϕ_e		7		mW
Temperature coefficient of ϕ_e	$I_F = 100 \text{ mA}$	TK_{ϕ_e}		- 0.8		%/K
Angle of half intensity		φ		± 30		deg
Peak wavelength	$I_F = 100 \text{ mA}$	λ_p		950		nm
Spectral bandwidth	$I_F = 100 \text{ mA}$	$\Delta\lambda$		50		nm
Rise time	$I_F = 100 \text{ mA}$	t_r		800		ns
	$I_F = 1.5 \text{ A}$, $t_p/T = 0.01$, $t_p \leq 10 \text{ }\mu\text{s}$	t_r		400		ns
Virtual source diameter		d		0.5		mm

Note
 $T_{amb} = 25 \text{ }^\circ\text{C}$, unless otherwise specified

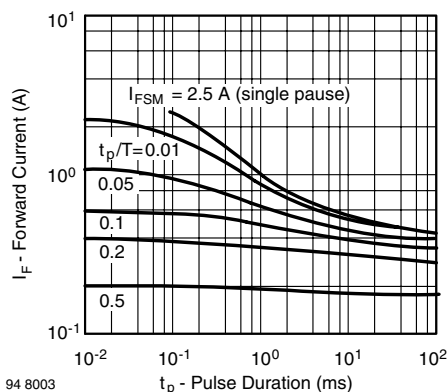
BASIC CHARACTERISTICS
 $T_{amb} = 25 \text{ }^\circ\text{C}$, unless otherwise specified


Fig. 3 - Pulse Forward Current vs. Pulse Duration

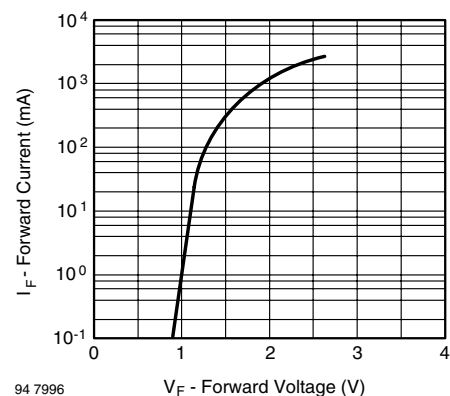


Fig. 4 - Forward Current vs. Forward Voltage



Fig. 5 - Relative Forward Voltage vs. Ambient Temperature

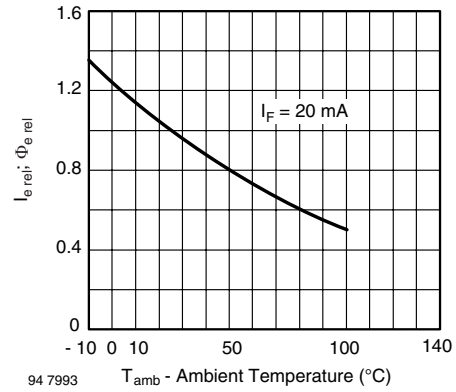


Fig. 8 - Relative Radiant Intensity/Power vs. Ambient Temperature

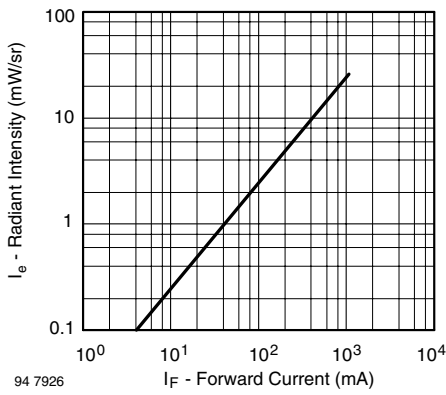


Fig. 6 - Radiant Intensity vs. Forward Current

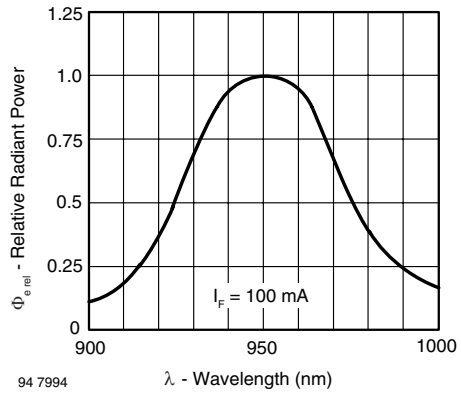


Fig. 9 - Relative Radiant Power vs. Wavelength

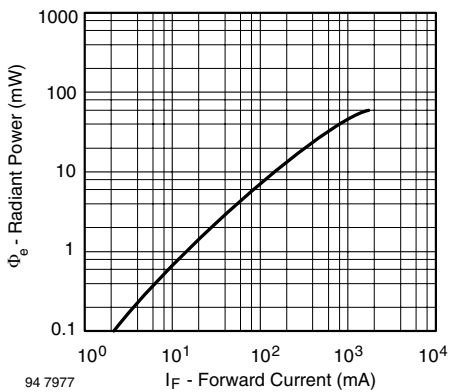


Fig. 7 - Radiant Power vs. Forward Current

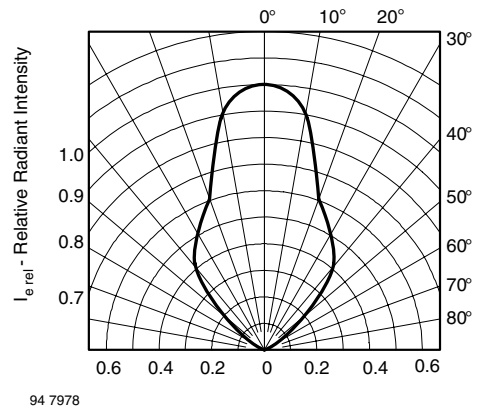
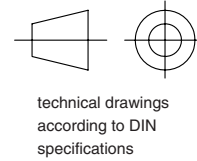
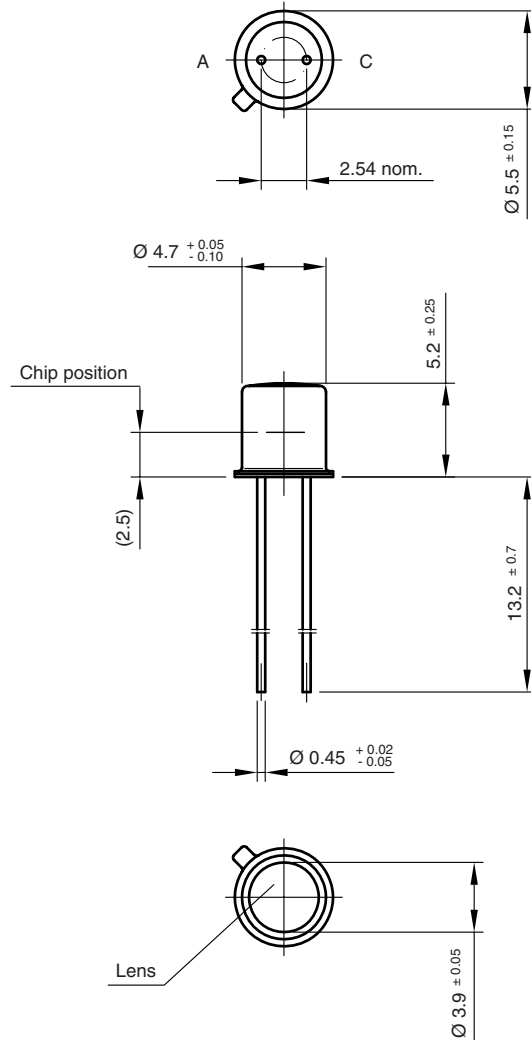


Fig. 10 - Relative Radiant Intensity vs. Angular Displacement



PACKAGE DIMENSIONS in millimeters



Drawing-No.: 6.503-5001.02-4
Issue: 1; 24.08.98
14485



Disclaimer

ALL PRODUCT, PRODUCT SPECIFICATIONS AND DATA ARE SUBJECT TO CHANGE WITHOUT NOTICE TO IMPROVE RELIABILITY, FUNCTION OR DESIGN OR OTHERWISE.

Vishay Intertechnology, Inc., its affiliates, agents, and employees, and all persons acting on its or their behalf (collectively, "Vishay"), disclaim any and all liability for any errors, inaccuracies or incompleteness contained in any datasheet or in any other disclosure relating to any product.

Vishay makes no warranty, representation or guarantee regarding the suitability of the products for any particular purpose or the continuing production of any product. To the maximum extent permitted by applicable law, Vishay disclaims (i) any and all liability arising out of the application or use of any product, (ii) any and all liability, including without limitation special, consequential or incidental damages, and (iii) any and all implied warranties, including warranties of fitness for particular purpose, non-infringement and merchantability.

Statements regarding the suitability of products for certain types of applications are based on Vishay's knowledge of typical requirements that are often placed on Vishay products in generic applications. Such statements are not binding statements about the suitability of products for a particular application. It is the customer's responsibility to validate that a particular product with the properties described in the product specification is suitable for use in a particular application. Parameters provided in datasheets and/or specifications may vary in different applications and performance may vary over time. All operating parameters, including typical parameters, must be validated for each customer application by the customer's technical experts. Product specifications do not expand or otherwise modify Vishay's terms and conditions of purchase, including but not limited to the warranty expressed therein.

Except as expressly indicated in writing, Vishay products are not designed for use in medical, life-saving, or life-sustaining applications or for any other application in which the failure of the Vishay product could result in personal injury or death. Customers using or selling Vishay products not expressly indicated for use in such applications do so at their own risk. Please contact authorized Vishay personnel to obtain written terms and conditions regarding products designed for such applications.

No license, express or implied, by estoppel or otherwise, to any intellectual property rights is granted by this document or by any conduct of Vishay. Product names and markings noted herein may be trademarks of their respective owners.

Material Category Policy

Vishay Intertechnology, Inc. hereby certifies that all its products that are identified as RoHS-Compliant fulfill the definitions and restrictions defined under Directive 2011/65/EU of The European Parliament and of the Council of June 8, 2011 on the restriction of the use of certain hazardous substances in electrical and electronic equipment (EEE) - recast, unless otherwise specified as non-compliant.

Please note that some Vishay documentation may still make reference to RoHS Directive 2002/95/EC. We confirm that all the products identified as being compliant to Directive 2002/95/EC conform to Directive 2011/65/EU.

Vishay Intertechnology, Inc. hereby certifies that all its products that are identified as Halogen-Free follow Halogen-Free requirements as per JEDEC JS709A standards. Please note that some Vishay documentation may still make reference to the IEC 61249-2-21 definition. We confirm that all the products identified as being compliant to IEC 61249-2-21 conform to JEDEC JS709A standards.

Компания «Океан Электроники» предлагает заключение долгосрочных отношений при поставках импортных электронных компонентов на взаимовыгодных условиях!

Наши преимущества:

- Поставка оригинальных импортных электронных компонентов напрямую с производств Америки, Европы и Азии, а так же с крупнейших складов мира;
- Широкая линейка поставок активных и пассивных импортных электронных компонентов (более 30 млн. наименований);
- Поставка сложных, дефицитных, либо снятых с производства позиций;
- Оперативные сроки поставки под заказ (от 5 рабочих дней);
- Экспресс доставка в любую точку России;
- Помощь Конструкторского Отдела и консультации квалифицированных инженеров;
- Техническая поддержка проекта, помощь в подборе аналогов, поставка прототипов;
- Поставка электронных компонентов под контролем ВП;
- Система менеджмента качества сертифицирована по Международному стандарту ISO 9001;
- При необходимости вся продукция военного и аэрокосмического назначения проходит испытания и сертификацию в лаборатории (по согласованию с заказчиком);
- Поставка специализированных компонентов военного и аэрокосмического уровня качества (Xilinx, Altera, Analog Devices, Intersil, Interpoint, Microsemi, Actel, Aeroflex, Peregrine, VPT, Syfer, Eurofarad, Texas Instruments, MS Kennedy, Miteq, Cobham, E2V, MA-COM, Hittite, Mini-Circuits, General Dynamics и др.);

Компания «Океан Электроники» является официальным дистрибьютором и эксклюзивным представителем в России одного из крупнейших производителей разъемов военного и аэрокосмического назначения «JONHON», а так же официальным дистрибьютором и эксклюзивным представителем в России производителя высокотехнологичных и надежных решений для передачи СВЧ сигналов «FORSTAR».



JONHON

«JONHON» (основан в 1970 г.)

Разъемы специального, военного и аэрокосмического назначения:

(Применяются в военной, авиационной, аэрокосмической, морской, железнодорожной, горно- и нефтедобывающей отраслях промышленности)

«FORSTAR» (основан в 1998 г.)

ВЧ соединители, коаксиальные кабели,
кабельные сборки и микроволновые компоненты:

(Применяются в телекоммуникациях гражданского и специального назначения, в средствах связи, РЛС, а так же военной, авиационной и аэрокосмической отраслях промышленности).



Телефон: 8 (812) 309-75-97 (многоканальный)

Факс: 8 (812) 320-03-32

Электронная почта: ocean@oceanchips.ru

Web: <http://oceanchips.ru/>

Адрес: 198099, г. Санкт-Петербург, ул. Калинина, д. 2, корп. 4, лит. А