

Power management (dual transistors)

UMF9N

2SC5585 and 2SK3019 are housed independently in a UMT package.

●Application

Power management circuit

●Features

- 1) Power switching circuit in a single package.
- 2) Mounting cost and area can be cut in half.

●Structure

Silicon epitaxial planar transistor

●Equivalent circuits

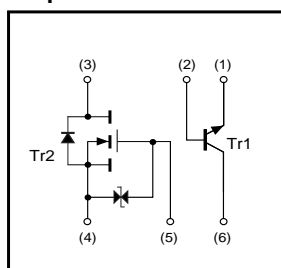

●Dimensions (Units : mm)

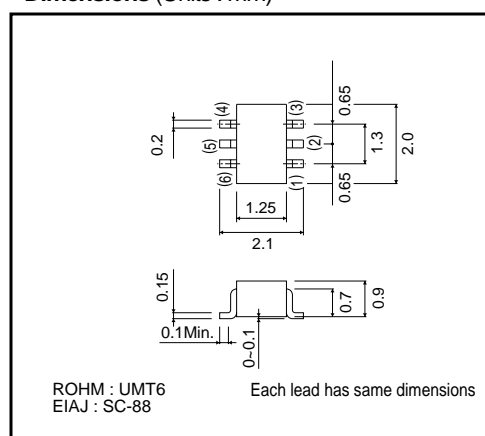

●Packaging specifications

Type	UMF9N
Package	UMT6
Marking	F9
Code	TR
Basic ordering unit (pieces)	3000

Transistors

●Absolute maximum ratings (Ta=25°C)

Tr1

Parameter	Symbol	Limits	Unit
Collector-base voltage	V _{CB0}	15	V
Collector-emitter voltage	V _{CEO}	12	V
Emitter-base voltage	V _{EBO}	6	V
Collector current	I _C	500	mA
	I _{CP}	1.0	A *1
Power dissipation	P _C	150(TOTAL)	mW *2
Junction temperature	T _j	150	°C
Range of storage temperature	T _{stg}	-55 to +150	°C

*1 Single pulse P_w=1ms

*2 120mW per element must not be exceeded. Each terminal mounted on a recommended land.

Tr2

Parameter	Symbol	Limits	Unit
Drain-source voltage	V _{DSS}	30	V
Gate-source voltage	V _{GSS}	±20	V
Drain current	Continuous	I _D	100 mA
	Pulsed	I _{DP}	200 mA *1
Reverse drain current	Continuous	I _{DR}	100 mA
	Pulsed	I _{DRP}	200 mA *1
Total power dissipation	P _D	150(TOTAL)	mW *2
Channel temperature	T _{ch}	150	°C
Range of storage temperature	T _{stg}	-55 to +150	°C

*1 P_w≤10ms Duty cycle≤50%

*2 120mW per element must not be exceeded. Each terminal mounted on a recommended land.

●Electrical characteristics (Ta=25°C)

Tr1

Parameter	Symbol	Min.	Typ.	Max.	Unit	Conditions
Collector-emitter breakdown voltage	BV _{CEO}	12	-	-	V	I _C =1mA
Collector-base breakdown voltage	BV _{CB0}	15	-	-	V	I _C =10μA
Emitter-base breakdown voltage	BV _{EBO}	6	-	-	V	I _E =10μA
Collector cut-off current	I _{CB0}	-	-	100	nA	V _{CB} =15V
Emitter cut-off current	I _{EBO}	-	-	100	nA	V _{EB} =6V
Collector-emitter saturation voltage	V _{CE(sat)}	-	100	250	mV	I _C =200mA, I _B =10mA
DC current gain	h _{FE}	270	-	680	-	V _{CE} =2V, I _C =10mA
Transition frequency	f _T	-	320	-	MHz	V _{CE} =2V, I _E =-10mA, f=100MHz
Collector output capacitance	C _{ob}	-	7.5	-	pF	V _{CB} =10V, I _E =0mA, f=1MHz

Tr2

Parameter	Symbol	Min.	Typ.	Max.	Unit	Conditions
Gate-source leakage	I _{GSS}	-	-	±1	μA	V _{GS} =±20V, V _{DS} =0V
Drain-source breakdown voltage	V _{(BR)DSS}	30	-	-	V	I _D =10μA, V _{GS} =0V
Zero gate voltage drain current	I _{DSS}	-	-	1.0	μA	V _{DS} =30V, V _{GS} =0V
Gate-threshold voltage	V _{GS(th)}	0.8	-	1.5	V	V _{DS} =3V, I _D =100μA
Static drain-source on-state resistance	R _{DS(on)}	-	5	8	Ω	I _D =10mA, V _{GS} =4V
		-	7	13	Ω	I _D =1mA, V _{GS} =2.5V
Forward transfer admittance	Y _{fs}	20	-	-	ms	V _{DS} =3V, I _D =10mA
Input capacitance	C _{iss}	-	13	-	pF	V _{DS} =5V, V _{GS} =0V, f=1MHz
Output capacitance	C _{oss}	-	9	-	pF	
Reverse transfer capacitance	C _{rss}	-	4	-	pF	
Turn-on delay time	t _{d(on)}	-	15	-	ns	
Rise time	t _r	-	35	-	ns	I _D =10mA, V _{DD} =5V, V _{GS} =5V, R _L =500Ω, R _{GS} =10Ω
Turn-off delay time	t _{d(off)}	-	80	-	ns	
Fall time	t _f	-	80	-	ns	

Transistors

●Electrical characteristic curves

Tr1

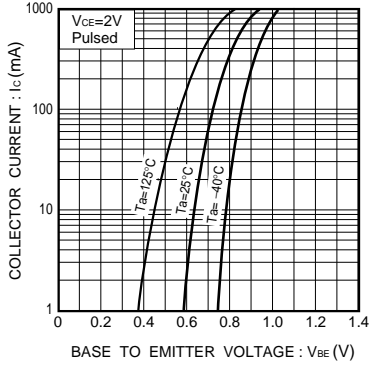

Fig.1 Grounded emitter propagation characteristics

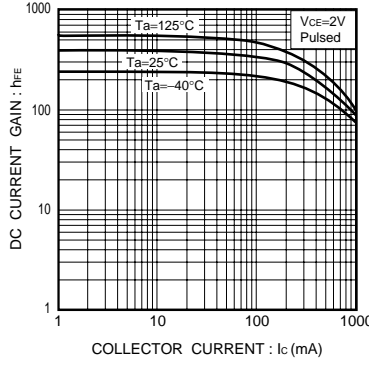

Fig.2 DC current gain vs. collector current

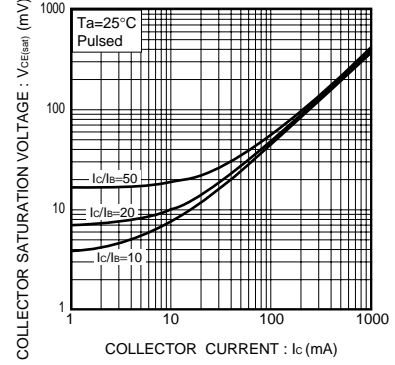

Fig.3 Collector-emitter saturation voltage vs. collector current (I)

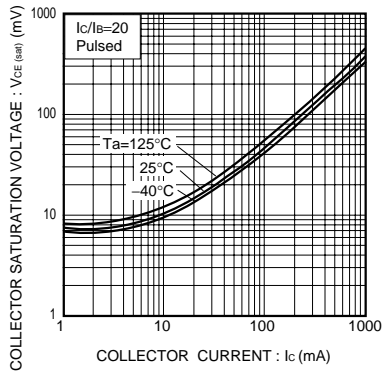

Fig.4 Collector-emitter saturation voltage vs. collector current (II)

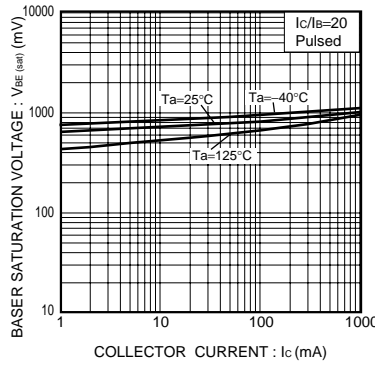

Fig.5 Base-emitter saturation voltage vs. collector current

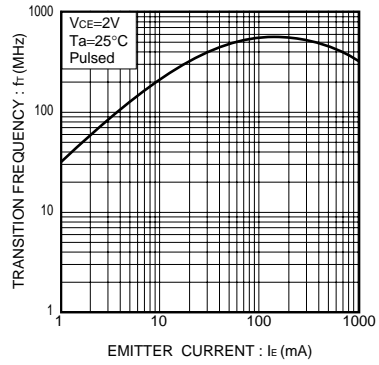

Fig.6 Gain bandwidth product vs. emitter current

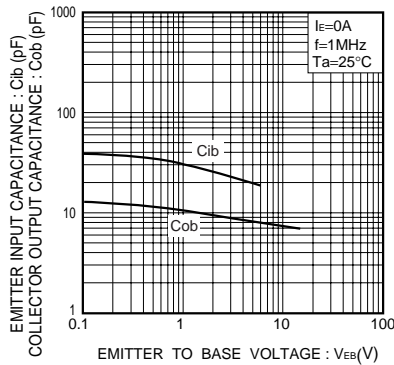

Fig.7 Collector output capacitance vs. collector-base voltage
Emitter input capacitance vs. emitter-base voltage

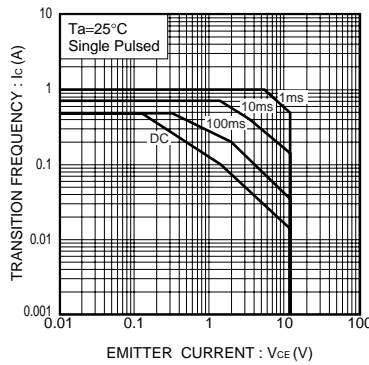

Fig.8 Safe operation area

Transistors

Tr2

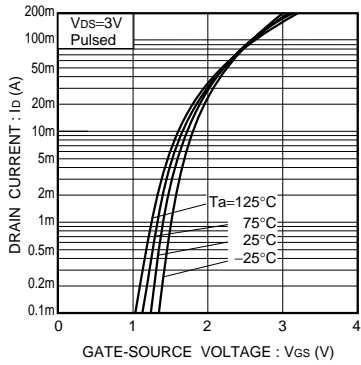

Fig.9 Typical transfer characteristics

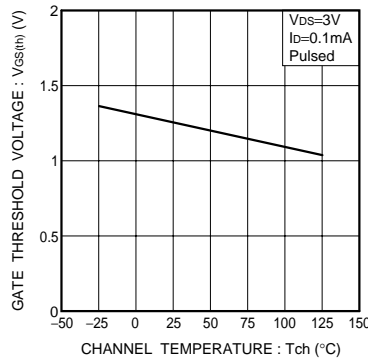

Fig.10 Gate threshold voltage vs. channel temperature

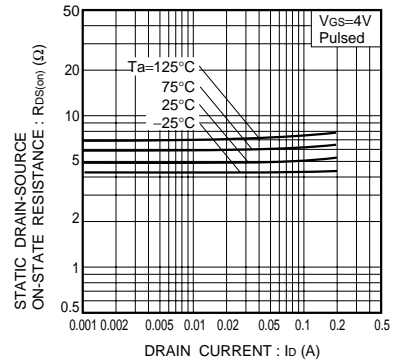

Fig.11 Static drain-source on-state resistance vs. drain current (I)

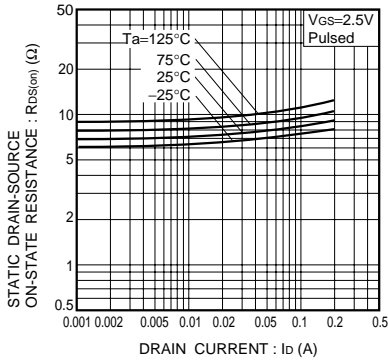

Fig.12 Static drain-source on-state resistance vs. drain current (II)

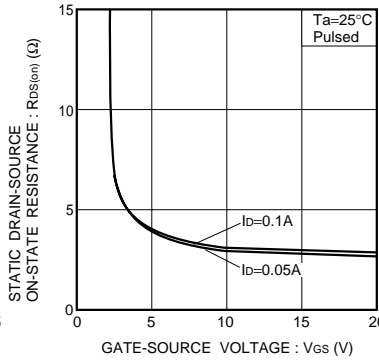

Fig.13 Static drain-source on-state resistance vs. gate-source voltage

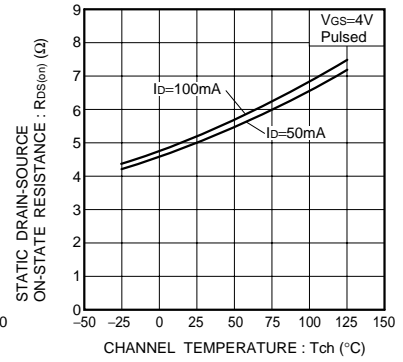

Fig.14 Static drain-source on-state resistance vs. channel temperature

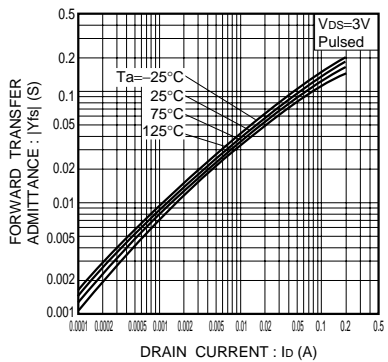

Fig.15 Forward transfer admittance vs. drain current

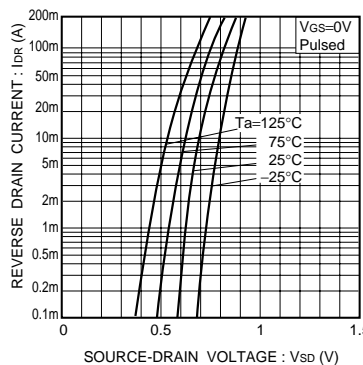

Fig.16 Reverse drain current vs. source-drain voltage (I)

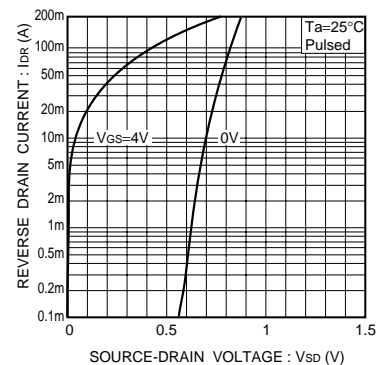

Fig.17 Reverse drain current vs. source-drain voltage (II)

Transistors

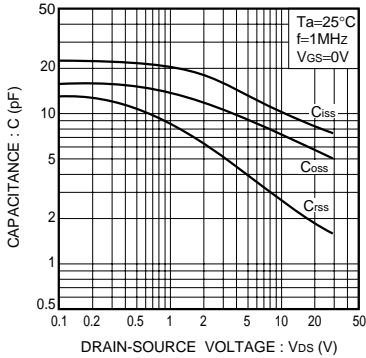

Fig.18 Typical capacitance vs. drain-source voltage

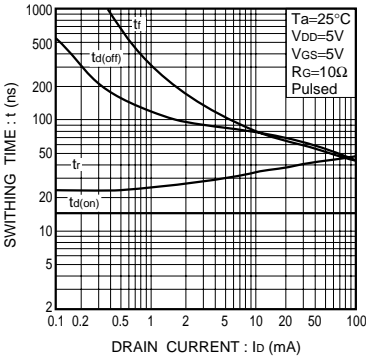

Fig.19 Switching characteristics

Notes

- No technical content pages of this document may be reproduced in any form or transmitted by any means without prior permission of ROHM CO.,LTD.
- The contents described herein are subject to change without notice. The specifications for the product described in this document are for reference only. Upon actual use, therefore, please request that specifications to be separately delivered.
- Application circuit diagrams and circuit constants contained herein are shown as examples of standard use and operation. Please pay careful attention to the peripheral conditions when designing circuits and deciding upon circuit constants in the set.
- Any data, including, but not limited to application circuit diagrams information, described herein are intended only as illustrations of such devices and not as the specifications for such devices. ROHM CO.,LTD. disclaims any warranty that any use of such devices shall be free from infringement of any third party's intellectual property rights or other proprietary rights, and further, assumes no liability of whatsoever nature in the event of any such infringement, or arising from or connected with or related to the use of such devices.
- Upon the sale of any such devices, other than for buyer's right to use such devices itself, resell or otherwise dispose of the same, no express or implied right or license to practice or commercially exploit any intellectual property rights or other proprietary rights owned or controlled by
- ROHM CO., LTD. is granted to any such buyer.
- Products listed in this document are no antiradiation design.

The products listed in this document are designed to be used with ordinary electronic equipment or devices (such as audio visual equipment, office-automation equipment, communications devices, electrical appliances and electronic toys).

Should you intend to use these products with equipment or devices which require an extremely high level of reliability and the malfunction of which would directly endanger human life (such as medical instruments, transportation equipment, aerospace machinery, nuclear-reactor controllers, fuel controllers and other safety devices), please be sure to consult with our sales representative in advance.

It is our top priority to supply products with the utmost quality and reliability. However, there is always a chance of failure due to unexpected factors. Therefore, please take into account the derating characteristics and allow for sufficient safety features, such as extra margin, anti-flammability, and fail-safe measures when designing in order to prevent possible accidents that may result in bodily harm or fire caused by component failure. ROHM cannot be held responsible for any damages arising from the use of the products under conditions out of the range of the specifications or due to non-compliance with the NOTES specified in this catalog.

Thank you for your accessing to ROHM product informations.

More detail product informations and catalogs are available, please contact your nearest sales office.

ROHM Customer Support System

THE AMERICAS / EUROPE / ASIA / JAPAN

www.rohm.com

Contact us : webmaster@rohm.co.jp

Компания «Океан Электроники» предлагает заключение долгосрочных отношений при поставках импортных электронных компонентов на взаимовыгодных условиях!

Наши преимущества:

- Поставка оригинальных импортных электронных компонентов напрямую с производств Америки, Европы и Азии, а так же с крупнейших складов мира;
- Широкая линейка поставок активных и пассивных импортных электронных компонентов (более 30 млн. наименований);
- Поставка сложных, дефицитных, либо снятых с производства позиций;
- Оперативные сроки поставки под заказ (от 5 рабочих дней);
- Экспресс доставка в любую точку России;
- Помощь Конструкторского Отдела и консультации квалифицированных инженеров;
- Техническая поддержка проекта, помощь в подборе аналогов, поставка прототипов;
- Поставка электронных компонентов под контролем ВП;
- Система менеджмента качества сертифицирована по Международному стандарту ISO 9001;
- При необходимости вся продукция военного и аэрокосмического назначения проходит испытания и сертификацию в лаборатории (по согласованию с заказчиком);
- Поставка специализированных компонентов военного и аэрокосмического уровня качества (Xilinx, Altera, Analog Devices, Intersil, Interpoint, Microsemi, Actel, Aeroflex, Peregrine, VPT, Syfer, Eurofarad, Texas Instruments, MS Kennedy, Miteq, Cobham, E2V, MA-COM, Hittite, Mini-Circuits, General Dynamics и др.);

Компания «Океан Электроники» является официальным дистрибьютором и эксклюзивным представителем в России одного из крупнейших производителей разъемов военного и аэрокосмического назначения «JONHON», а так же официальным дистрибьютором и эксклюзивным представителем в России производителя высокотехнологичных и надежных решений для передачи СВЧ сигналов «FORSTAR».



JONHON

«JONHON» (основан в 1970 г.)

Разъемы специального, военного и аэрокосмического назначения:

(Применяются в военной, авиационной, аэрокосмической, морской, железнодорожной, горно- и нефтедобывающей отраслях промышленности)

«FORSTAR» (основан в 1998 г.)

ВЧ соединители, коаксиальные кабели, кабельные сборки и микроволновые компоненты:

(Применяются в телекоммуникациях гражданского и специального назначения, в средствах связи, РЛС, а так же военной, авиационной и аэрокосмической отраслях промышленности).



Телефон: 8 (812) 309-75-97 (многоканальный)

Факс: 8 (812) 320-03-32

Электронная почта: ocean@oceanchips.ru

Web: <http://oceanchips.ru/>

Адрес: 198099, г. Санкт-Петербург, ул. Калинина, д. 2, корп. 4, лит. А