

## LOW NOISE 150mA LDO REGULATOR R1121N SERIES

### OUTLINE

The R1121N Series are voltage regulator ICs with high output voltage accuracy, extremely low supply current, low ON-resistance and high ripple rejection by CMOS process. Each of these voltage regulator ICs consists of a voltage reference unit, an error amplifier, resistors, a current limit circuit, and a chip enable circuit. These ICs perform with low dropout voltage and a chip enable function.

The line transient response and load transient response of the R1121N Series are excellent, thus these ICs are very suitable for the power supply for hand-held communication equipment.

The output voltage of these ICs is fixed with high accuracy.

Since the package for these ICs are SOT-23-5 (Mini-mold) package, high density mounting of the ICs on boards is possible.

### FEATURES

- Ultra-Low Supply Current.....TYP. 35 $\mu$ A
- Standby Mode .....TYP. 0.1 $\mu$ A
- Low Dropout Voltage .....TYP. 0.2V ( $I_{OUT} = 100\text{mA}$ )
- High Ripple Rejection .....TYP. 70db ( $f = 1\text{kHz}$ )
- Low Temperature-Drift Coefficient of Output Voltage ....TYP.  $\pm 100\text{ppm}/^\circ\text{C}$
- Excellent Line Regulation .....TYP. 0.05%/V
- High Accuracy Output Voltage..... $\pm 2.0\%$
- Small Package .....SOT-23-5 (Mini-mold)
- Output Voltage .....Stepwise setting with a step of 0.1V in the range of 1.5V to 5.0V is possible.
- Built-in chip enable circuit (2 Types; A: active "L", B: active "H")
- Pinout .....Similar to the TK112, TK111

### APPLICATIONS

- Power source for cellular phones such as GSM, CDMA and various kind of PCSs.
- Power source for domestic appliances such as cameras, VCRs and camcorders.
- Power source for battery-powered equipment.

### BLOCK DIAGRAM

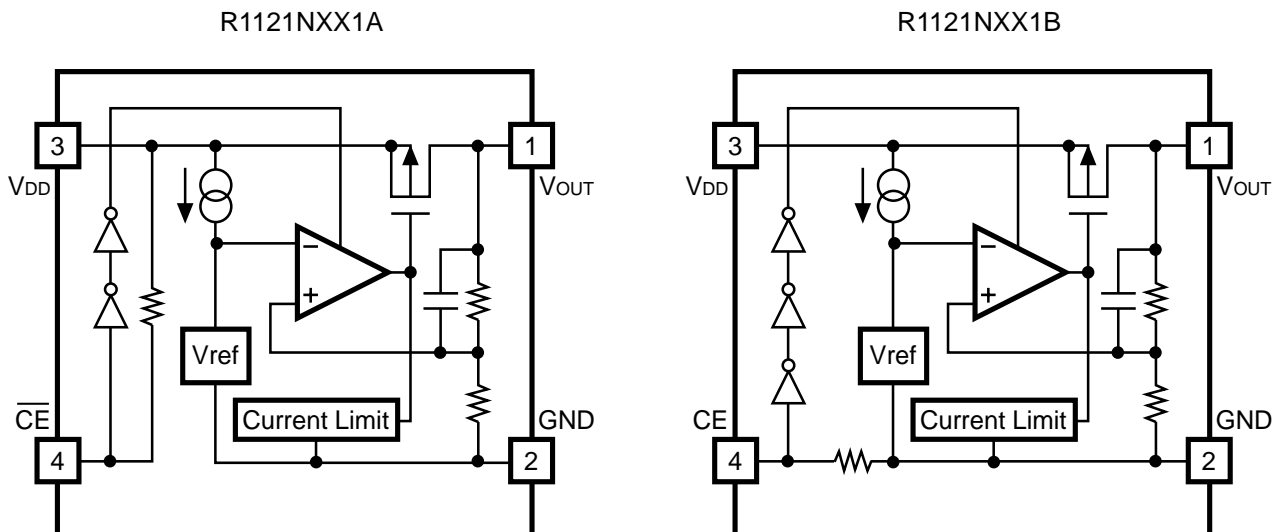

## SELECTION GUIDE

The output voltage, the active type, the packing type, and the taping type for the ICs can be selected at the user's request. The selection can be made by designating the part number as shown below :

R1121XXX1X-XX ←Part Number  
                   ↑ ↑ ↑  
                   a b c

Code	Contents
a	Setting Output Voltage ( $V_{OUT}$ ) : Stepwise setting with a step of 0.1V in the range of 1.5V to 5.0V is possible.
b	Designation of Active Type : A : active "L" type B : active "H" type
c	Designation of Taping Type : Ex. TR, TL (refer to Taping Specifications; TR type is the standard direction.)

## PIN CONFIGURATION



## PIN DESCRIPTION

Pin No.	Symbol	Description
1	$V_{OUT}$	Output pin
2	GND	Ground Pin
3	$V_{DD}$	Input Pin
4	$\overline{CE}$ or CE	Chip Enable Pin
5	NC	No Connection

## ■ ABSOLUTE MAXIMUM RATINGS

Symbol	Item	Rating	Unit
V <sub>IN</sub>	Input Voltage	9	V
V <sub>CE</sub>	Input Voltage (CE or CE Pin)	-0.3 ~ V <sub>IN</sub> +0.3	V
V <sub>OUT</sub>	Output Voltage	-0.3~ V <sub>IN</sub> +0.3	V
P <sub>D</sub>	Power Dissipation	250	mW
T <sub>opt</sub>	Operating Temperature Range	-40 ~ 85	°C
T <sub>stg</sub>	Storage Temperature Range	-55 ~ 125	°C

## ■ ELECTRICAL CHARACTERISTICS

### ● R1121NXX1A

T<sub>opt</sub> = 25°C

Symbol	Item	Conditions	MIN.	TYP.	MAX.	Unit
V <sub>OUT</sub>	Output Voltage	V <sub>IN</sub> = Set V <sub>OUT</sub> +1V 1mA ≤ I <sub>OUT</sub> ≤ 30mA	V <sub>OUT</sub> ×0.98		V <sub>OUT</sub> ×1.02	V
I <sub>OUT</sub>	Output Current	refer to the ELECTRICAL CHARACTERISTICS by OUTPUT VOLTAGE				
ΔV <sub>OUT</sub> /ΔI <sub>OUT</sub>	Load Regulation	V <sub>IN</sub> = Set V <sub>OUT</sub> +1V 1mA ≤ I <sub>OUT</sub> ≤ 80mA		12	40	mV
V <sub>DIF</sub>	Dropout Voltage	refer to the ELECTRICAL CHARACTERISTICS by OUTPUT VOLTAGE				
I <sub>SS</sub>	Supply Current	V <sub>IN</sub> = Set V <sub>OUT</sub> +1V		35	70	μA
I <sub>standby</sub>	Supply Current (Standby)	V <sub>IN</sub> = V <sub>CE</sub> = Set V <sub>OUT</sub> +1V		0.1	1.0	μA
ΔV <sub>OUT</sub> /ΔV <sub>IN</sub>	Line Regulation	Set V <sub>OUT</sub> +0.5V ≤ V <sub>IN</sub> ≤ 8V I <sub>OUT</sub> = 30mA		0.05	0.20	%/V
RR	Ripple Rejection	f = 1KHz, Ripple 0.5Vp-p V <sub>IN</sub> = Set V <sub>OUT</sub> +1V		70		dB
V <sub>IN</sub>	Input Voltage				8	V
ΔV <sub>OUT</sub> /ΔT	Output Voltage Temperature Coefficient	I <sub>OUT</sub> = 30mA -40°C ≤ T <sub>opt</sub> ≤ 85°C		±100		ppm /°C
I <sub>lim</sub>	Short Current Limit	V <sub>OUT</sub> = 0V		50		mA
R <sub>PU</sub>	CE Pull-up Resistance		2.5	5	10	MΩ
V <sub>CEH</sub>	CE Input Voltage "H"		1.5		V <sub>IN</sub>	V
V <sub>CEL</sub>	CE Input Voltage "L"		0		0.25	V
en	Output Noise	BW = 10Hz ~ 100kHz		30		μVrms

● R1121NXX1B

Topt=25°C

Symbol	Item	Conditions	MIN.	TYP.	MAX.	Unit
V <sub>OUT</sub>	Output Voltage	V <sub>IN</sub> = Set V <sub>OUT</sub> +1V 1mA ≤ I <sub>OUT</sub> ≤ 30mA	V <sub>OUT</sub> ×0.98		V <sub>OUT</sub> ×1.02	V
I <sub>OUT</sub>	Output Current	refer to the ELECTRICAL CHARACTERISTICS by OUTPUT VOLTAGE				
ΔV <sub>OUT</sub> /ΔI <sub>OUT</sub>	Load Regulation	V <sub>IN</sub> = Set V <sub>OUT</sub> +1V 1mA ≤ I <sub>OUT</sub> ≤ 80mA		12	40	mV
V <sub>DIF</sub>	Dropout Voltage	refer to the ELECTRICAL CHARACTERISTICS by OUTPUT VOLTAGE				
I <sub>SS</sub>	Supply Current	V <sub>IN</sub> = Set V <sub>OUT</sub> +1V		35	70	μA
I <sub>standby</sub>	Supply Current (Standby)	V <sub>IN</sub> = Set V <sub>OUT</sub> +1V V <sub>CE</sub> = GND		0.1	1.0	μA
ΔV <sub>OUT</sub> /ΔV <sub>IN</sub>	Line Regulation	Set V <sub>OUT</sub> +0.5V ≤ V <sub>IN</sub> ≤ 8V I <sub>OUT</sub> = 30mA		0.05	0.20	%/V
RR	Ripple Rejection	f = 1KHz, Ripple 0.5Vp-p V <sub>IN</sub> = Set V <sub>OUT</sub> +1V		70		dB
V <sub>IN</sub>	Input Voltage				8	V
ΔV <sub>OUT</sub> /ΔT	Output Voltage Temperature Coefficient	I <sub>OUT</sub> = 30mA -40°C ≤ Topt ≤ 85°C		±100		ppm/°C
I <sub>lim</sub>	Short Current Limit	V <sub>OUT</sub> = 0V		50		mA
R <sub>PD</sub>	CE Pull-down Resistance		2.5	5	10	MΩ
V <sub>CEH</sub>	CE Input Voltage "H"		1.5		V <sub>IN</sub>	V
V <sub>CEL</sub>	CE Input Voltage "L"		0		0.25	V
en	Output Noise	BW = 10Hz ~ 100kHz		30		μVrms

● ELECTRICAL CHARACTERISTICS by OUTPUT VOLTAGE

Topt = 25°C

Output Voltage V <sub>OUT</sub> (V)	Output Current	
	I <sub>OUT</sub> (mA)	
	Conditions	MIN.
1.5 ≤ V <sub>OUT</sub> ≤ 1.7	V <sub>IN</sub> - V <sub>OUT</sub> = 1.0V	100
1.8 ≤ V <sub>OUT</sub> ≤ 5.0		150

Topt = 25°C

Output Voltage V <sub>OUT</sub> (V)	Dropout Voltage			
	V <sub>DIF</sub> (V)			
	Conditions	MIN.	TYP.	MAX.
1.5	I <sub>OUT</sub> = 100mA	0.5		
1.6		0.4		
1.7		0.3		
1.8 ≤ V <sub>OUT</sub> ≤ 1.9			0.60	1.40
2.0 ≤ V <sub>OUT</sub> ≤ 2.4			0.35	0.70
2.5 ≤ V <sub>OUT</sub> ≤ 2.7			0.24	0.35
2.8 ≤ V <sub>OUT</sub> ≤ 3.3			0.20	0.30
3.4 ≤ V <sub>OUT</sub> ≤ 5.0			0.17	0.26

Note : When set Output Voltage is equal or less than 2.0V, V<sub>IN</sub> should be equal or more than 2.0V.

## ■ OPERATION



In these ICs, fluctuation of Output Voltage,  $V_{OUT}$  is detected by Feed-back Registers, R1 and R2, and the result is compared with a reference voltage by Error Amplifier, so that a constant voltage is output. A current limit circuit for protection at short mode and a chip enable circuit are included.

**TEST CIRCUITS**



Fig.1 Standard test Circuit



Fig.2 Supply Current Test Circuit

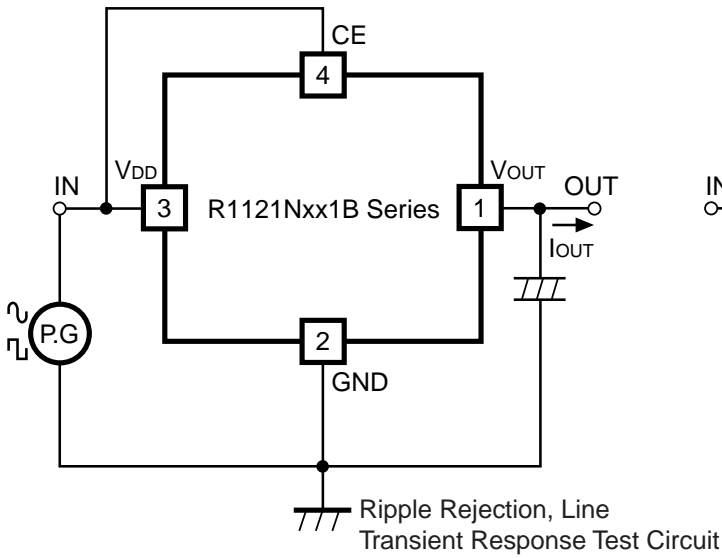

Fig.3 Ripple Rejection, Line Transient Response Test Circuit

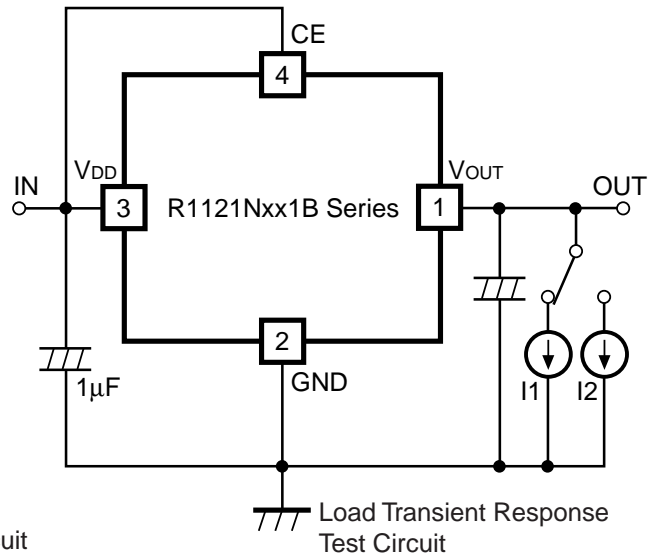
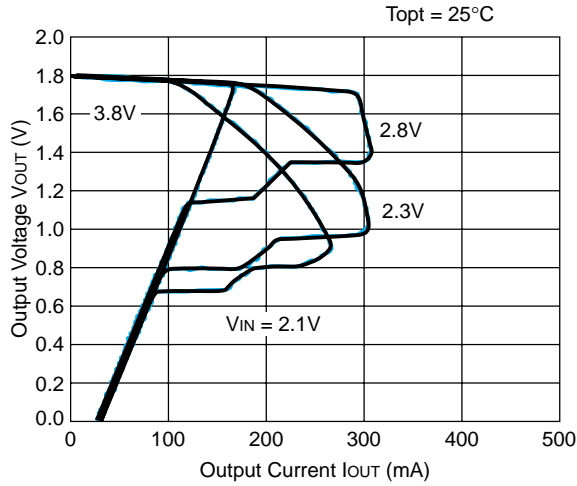

Fig.4 Load Transient Response Test Circuit

## TYPICAL CHARACTERISTICS

### 1) Output Voltage vs. Output Current

R1121N181B



R1121N301B

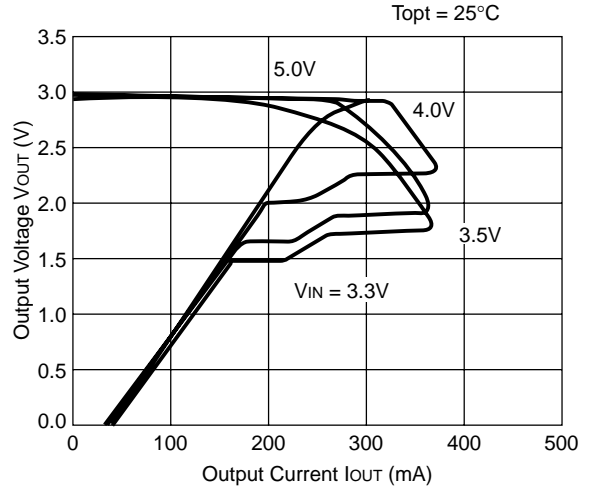

R1121N401B

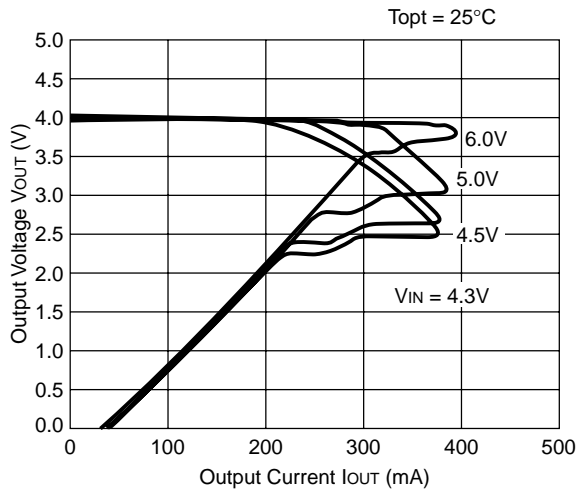

R1121N501B

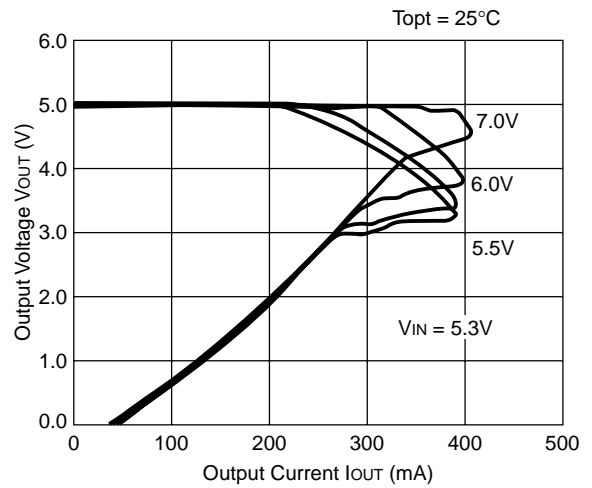

### 2) Output Voltage vs. Input Voltage

R1121N181B

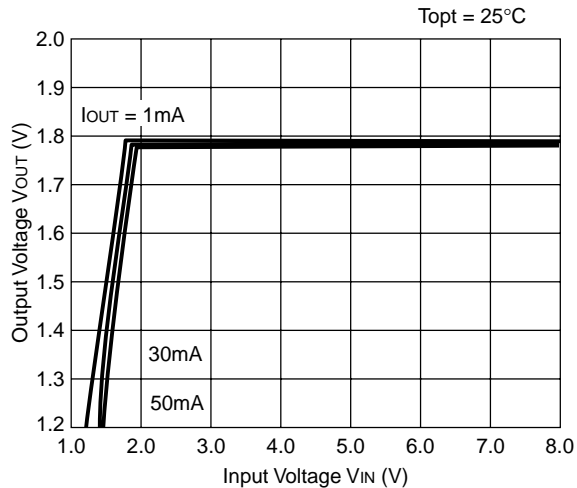

R1121N301B

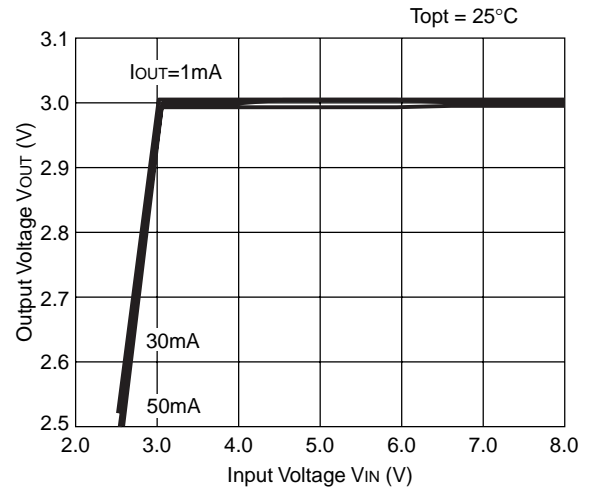



3) Dropout Voltage vs. Output Current  
**R1121N181B**





4) Output Voltage vs. Temperature  
R1121N181B



R1121N301B  
 $V_{IN} = 4.0V$   
 $I_{OUT} = 30mA$

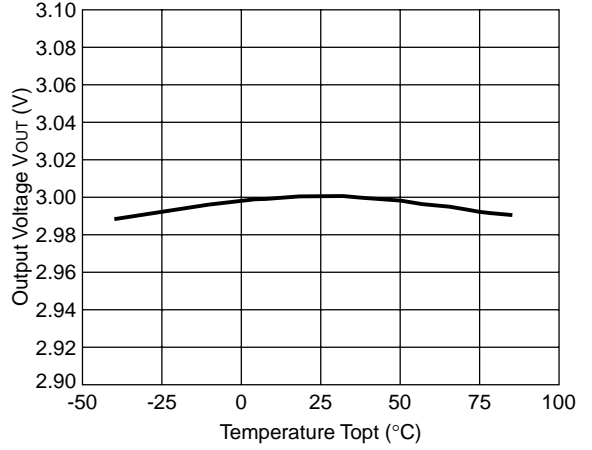

R1121N401B  
 $V_{IN} = 5.0V$   
 $I_{OUT} = 30mA$

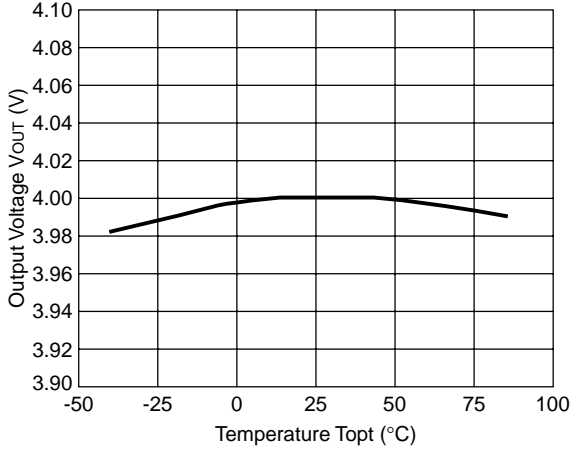

R1121N501B  
 $V_{IN} = 6.0V$   
 $I_{OUT} = 30mA$

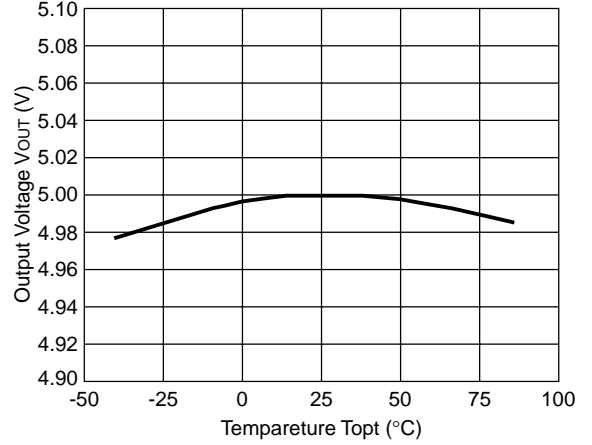

5) Supply Current vs. Input Voltage  
R1121N181B



R1121N301B  
 $T_{opt} = 25^{\circ}C$

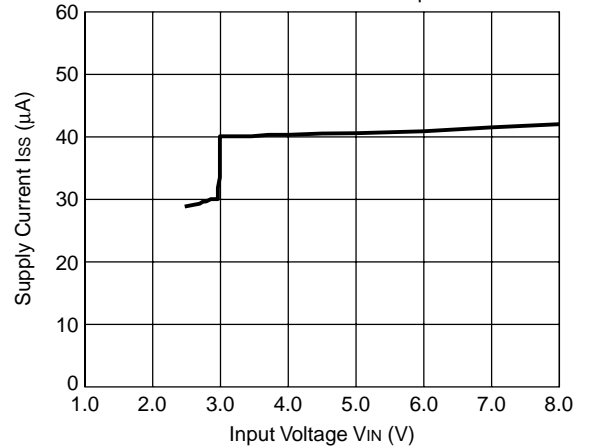

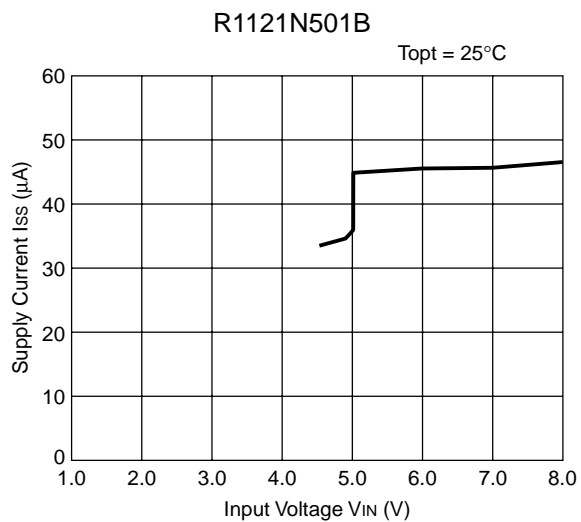
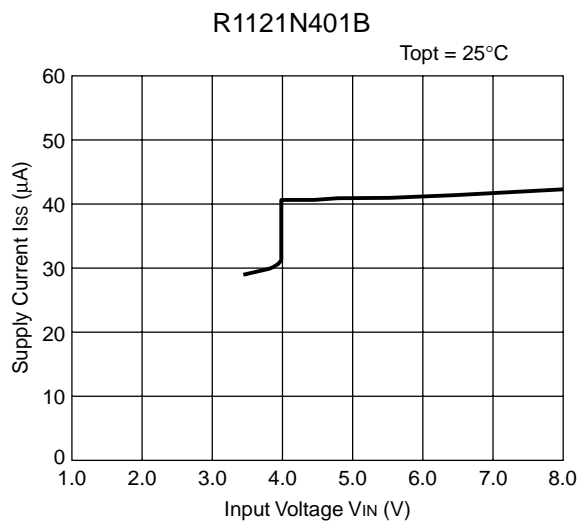

6) Supply Current vs. Temperature

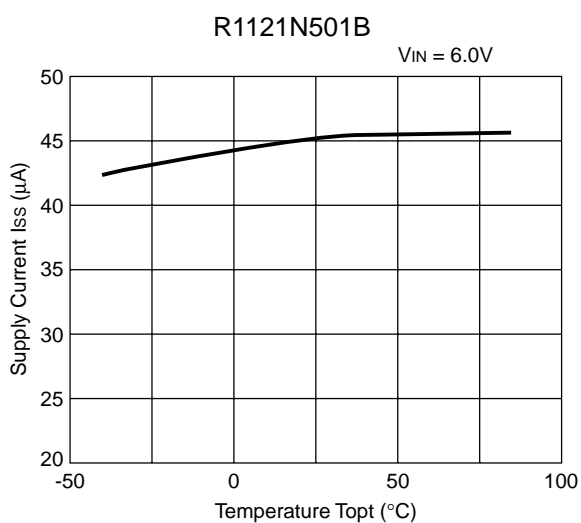
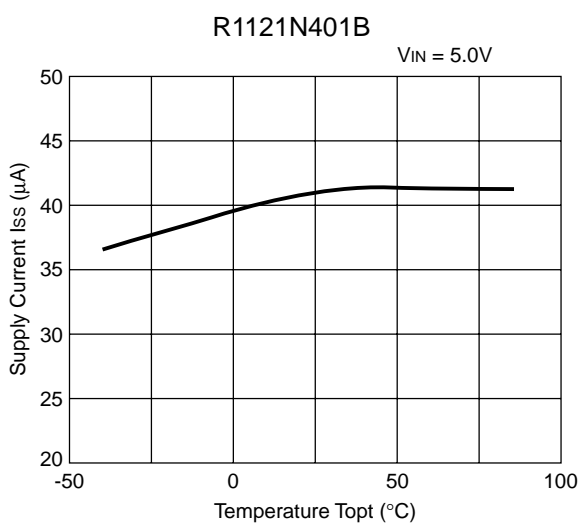
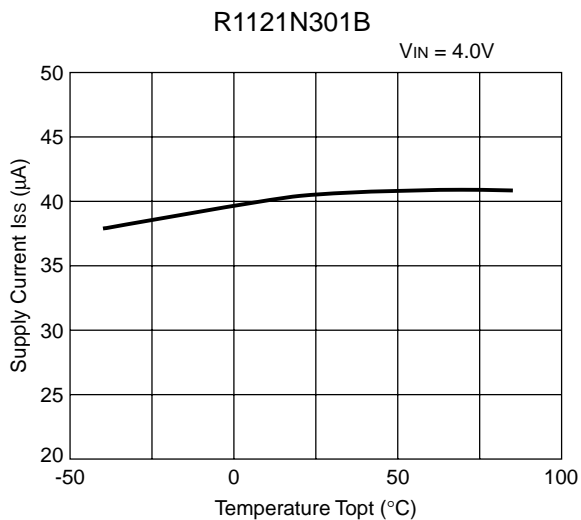
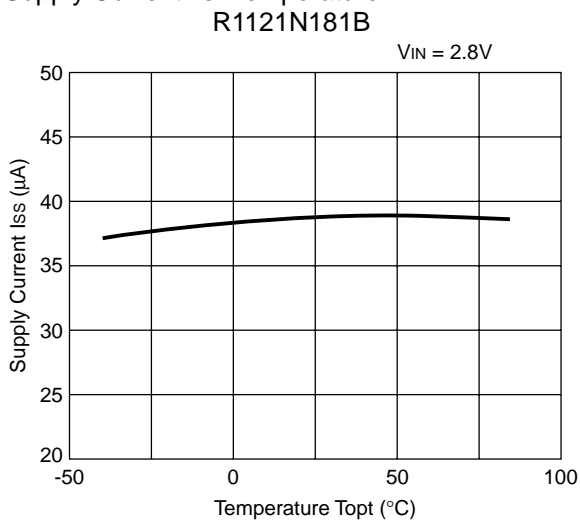

7) Dropout Voltage vs. Set Output Voltage  
R1121Nxx1B

Topt = 25°C



8) Ripple Rejection vs. Frequency  
R1121N181B

VIN = 2.8VDC + 0.5Vp-p  
COUT = tantal 1.0μF



R1121N181B

VIN = 2.8VDC + 0.5Vp-p  
COUT = tantal 2.2μF



R1121N301B

VIN = 4.0VDC + 0.5Vp-p  
COUT = tantal 1.0μF

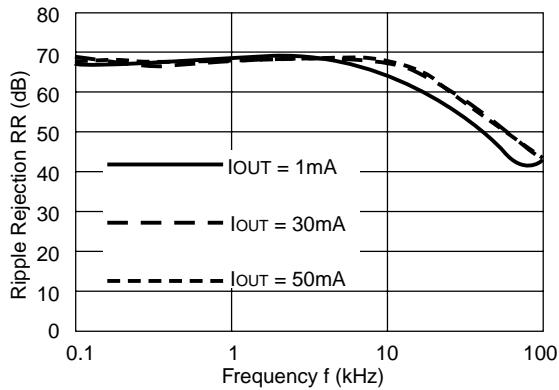

R1121N301B

VIN = 4.0VDC + 0.5Vp-p  
COUT = tantal 2.2μF

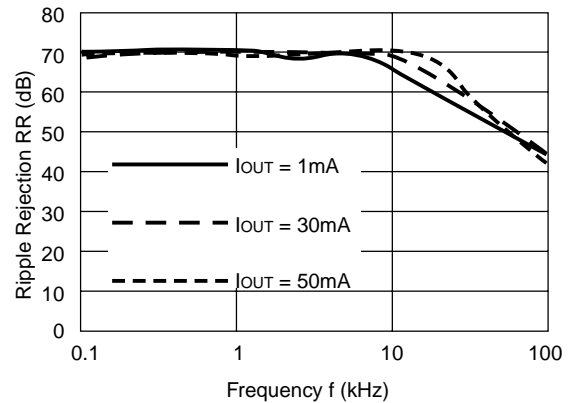

**R1121N401B**

$V_{IN} = 5.0V_{DC} + 0.5V_{p-p}$   
 $C_{OUT} = \text{tantal } 1.0\mu F$



**R1121N401B**

$V_{IN} = 5.0V_{DC} + 0.5V_{p-p}$   
 $C_{OUT} = \text{tantal } 2.2\mu F$



9) Ripple Rejection vs. Input Voltage (DC bias)

**R1121N301B**

$I_{OUT} = 1mA$   
 $C_{OUT} = 2.2\mu F$



**R1121N301B**

$I_{OUT} = 10mA$   
 $C_{OUT} = 2.2\mu F$



**R1121N301B**

$I_{OUT} = 50mA$   
 $C_{OUT} = 2.2\mu F$



10) Line Transient Response

R1121N301B

$I_{OUT}=30\text{mA}$   
 $t_r=t_f=5\ \mu\text{s}$   
 $C_{OUT}=\text{Tantalum } 1.0\ \mu\text{F}$



R1121N301B

$I_{OUT}=30\text{mA}$   
 $t_r=t_f=5\ \mu\text{s}$   
 $C_{OUT}=\text{Tantalum } 2.2\ \mu\text{F}$



R1121N301B

$I_{OUT}=30\text{mA}$   
 $t_r=t_f=5\ \mu\text{s}$   
 $C_{OUT}=\text{Tantalum } 6.8\ \mu\text{F}$



11) Load Transient Response

R1121N301B

$V_{IN}=4V$   
 $C_{IN}=\text{Tantalum } 1\mu F$   
 $C_{OUT}=\text{Tantalum } 1.0\mu F$



R1121N301B

$V_{IN}=4V$   
 $C_{IN}=\text{Tantalum } 1\mu F$   
 $C_{OUT}=\text{Tantalum } 2.2\mu F$



R1121N301B

$V_{IN}=4V$   
 $C_{IN}=\text{Tantalum } 1\mu F$   
 $C_{OUT}=\text{Tantalum } 6.8\mu F$



## TECHNICAL NOTES

When using these ICs, be sure to consider following points:

- In these ICs, phase compensation is made for securing stable operation even if the load current is varied. For this purpose, be sure to use a capacitor  $C_{OUT}$  with good frequency characteristics and ESR (Equivalent Series Resistance) of which is in the range described as follows:



Measuring Circuit for white noise ; R1121N301B

The relations between  $I_{OUT}$  (Output Current) and ESR of Output Capacitor are shown below. The conditions when the white noise level is under  $40\mu\text{V}$  (Avg.) are marked as the hatched area in the graph.  
(note: When the additional ceramic capacitors are connected to the Output Pin with Output capacitor for phase compensation, the operation might be unstable. Because of this, test these ICs with as same external components as ones to be used on the PCB.)

<measuring conditions>

- $V_{IN} = 4\text{V}$
- Frequency band : 10Hz to 1MHz
- Temperature :  $25^\circ\text{C}$



- Make  $V_{DD}$  and GND line sufficient. When the impedance of these is high, there is a case to pick up the noise or not to work correctly.
- Connect the capacitor with a capacitance of  $1\mu\text{F}$  or more between  $V_{DD}$  and GND as close as possible.
- Set external components, especially Output Capacitor, as close as possible to the ICs and make wiring shortest.

---

---

■ TYPICAL APPLICATION





Компания «Океан Электроники» предлагает заключение долгосрочных отношений при поставках импортных электронных компонентов на взаимовыгодных условиях!

Наши преимущества:

- Поставка оригинальных импортных электронных компонентов напрямую с производств Америки, Европы и Азии, а так же с крупнейших складов мира;
- Широкая линейка поставок активных и пассивных импортных электронных компонентов (более 30 млн. наименований);
- Поставка сложных, дефицитных, либо снятых с производства позиций;
- Оперативные сроки поставки под заказ (от 5 рабочих дней);
- Экспресс доставка в любую точку России;
- Помощь Конструкторского Отдела и консультации квалифицированных инженеров;
- Техническая поддержка проекта, помощь в подборе аналогов, поставка прототипов;
- Поставка электронных компонентов под контролем ВП;
- Система менеджмента качества сертифицирована по Международному стандарту ISO 9001;
- При необходимости вся продукция военного и аэрокосмического назначения проходит испытания и сертификацию в лаборатории (по согласованию с заказчиком);
- Поставка специализированных компонентов военного и аэрокосмического уровня качества (Xilinx, Altera, Analog Devices, Intersil, Interpoint, Microsemi, Actel, Aeroflex, Peregrine, VPT, Syfer, Eurofarad, Texas Instruments, MS Kennedy, Miteq, Cobham, E2V, MA-COM, Hittite, Mini-Circuits, General Dynamics и др.);

Компания «Океан Электроники» является официальным дистрибьютором и эксклюзивным представителем в России одного из крупнейших производителей разъемов военного и аэрокосмического назначения «JONHON», а так же официальным дистрибьютором и эксклюзивным представителем в России производителя высокотехнологичных и надежных решений для передачи СВЧ сигналов «FORSTAR».



## JONHON

«JONHON» (основан в 1970 г.)

Разъемы специального, военного и аэрокосмического назначения:

(Применяются в военной, авиационной, аэрокосмической, морской, железнодорожной, горно- и нефтедобывающей отраслях промышленности)

«FORSTAR» (основан в 1998 г.)

ВЧ соединители, коаксиальные кабели,  
кабельные сборки и микроволновые компоненты:

(Применяются в телекоммуникациях гражданского и специального назначения, в средствах связи, РЛС, а так же военной, авиационной и аэрокосмической отраслях промышленности).



Телефон: 8 (812) 309-75-97 (многоканальный)

Факс: 8 (812) 320-03-32

Электронная почта: [ocean@oceanchips.ru](mailto:ocean@oceanchips.ru)

Web: <http://oceanchips.ru/>

Адрес: 198099, г. Санкт-Петербург, ул. Калинина, д. 2, корп. 4, лит. А