

A wide variety of products including dust-proof type



TACT Switch™

Sharp Feeling

Soft Feeling

Snap-in Type

Surface Mount Type

Radial Type

Typical Specifications

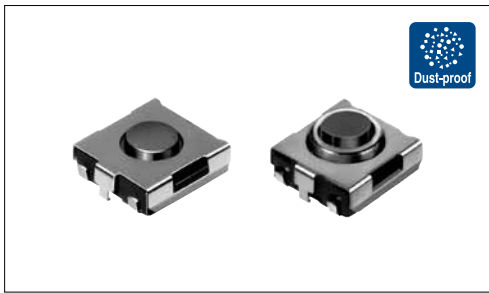

| Items | Specifications |
|----------------------------|--------------------|
| Rating (max.) | 50mA 12V DC |
| Rating (min.) | 10 μ A 1V DC |
| Initial contact resistance | 100m Ω max. |
| Travel (mm) | 0.25 |

Product Line

Top push type

| Product No. | Operating force | Operating direction | Operating life (5mA 5V DC) | Stem color | Height | Minimum order unit (pcs.) | | Drawing No. |
|-------------|-----------------|---------------------|----------------------------|------------|--------|---------------------------|--------|-------------|
| | | | | | | Japan | Export | |
| SKHUAKE010 | 0.98N | Top push | 300,000 cycles | Green | 2.5mm | 3,000 | 3,000 | 1 |
| SKHUALE010 | 1.57N | | | Black | | | | |
| SKHUAME010 | 2.55N | | 100,000 cycles | Red | | | | |

With ground terminal type

| Product No. | Operating force | Operating direction | Operating life (5mA 5V DC) | Stem color | Height | Minimum order unit (pcs.) | | Drawing No. |
|-------------|-----------------|---------------------|----------------------------|------------|--------|---------------------------|--------|-------------|
| | | | | | | Japan | Export | |
| SKHUPKE010 | 0.98N | Top push | 300,000 cycles | Green | 2.5mm | 3,000 | 3,000 | 2 |
| SKHUPLE010 | 1.57N | | | Black | | | | |
| SKHUPME010 | 2.55N | | 100,000 cycles | Red | | | | |

Dust-proof type

| Product No. | Operating force | Operating direction | Operating life (5mA 5V DC) | Stem color | Height | Minimum order unit (pcs.) | | Drawing No. |
|-------------|-----------------|---------------------|----------------------------|------------|--------|---------------------------|--------|-------------|
| | | | | | | Japan | Export | |
| SKHUBHE010 | 1.57N | Top push | 50,000 cycles | Brown | 3.1mm | 3,000 | 3,000 | 3 |

Dust-proof and with ground terminal type

| Product No. | Operating force | Operating direction | Operating life (5mA 5V DC) | Stem color | Height | Minimum order unit (pcs.) | | Drawing No. |
|-------------|-----------------|---------------------|----------------------------|------------|--------|---------------------------|--------|-------------|
| | | | | | | Japan | Export | |
| SKHUQHE010 | 1.57N | Top push | 50,000 cycles | Brown | 3.1mm | 3,000 | 3,000 | 4 |
| SKHUQGE010 | 2.55N | | | Red | | | | |

Packing Specifications

Taping

| Number of packages (pcs.) | | | Tape width (mm) | Export package measurements (mm) |
|---------------------------|----------------|-------------------------|-----------------|----------------------------------|
| 1 reel | 1 case / Japan | 1 case / export packing | | |
| 3,000 | 30,000 | 30,000 | 12 | 395×395×205 |

Note

For reels of 330mm diameter, please inquire.

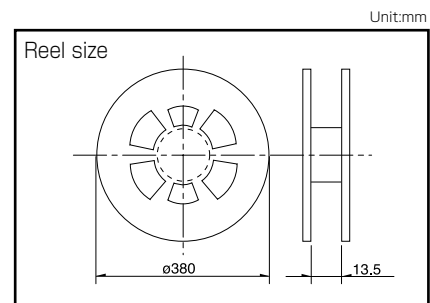

Refer to P.249 for soldering conditions.

SKHU 6.2 × 6.3mm (Surface Mount Type)

TACT Switch™

Sharp Feeling

Soft Feeling

Snap-In Type

Surface Mount Type

Radial Type

■ Dimensions

Unit:mm

| No. | Photo | Style | PC board land dimensions (Viewed from switch mounting face) |
|-----|-------|-------|--|
| 1 | | | |
| 2 | | | |
| 3 | | | |
| 4 | | | |

■ Circuit Diagram

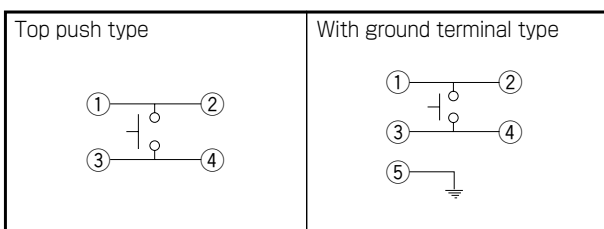

TACT Switch™

List of Varieties

TACT Switch™























Sharp Feeling Type

Soft Feeling Type

Snap-In Type

Surface Mount Type

Radial Type

| Type | | Sharp Feeling Type | | | | | | | |
|-----------------------------|--------------------------------|--|---|---|---|--|---|---|---|
| | | Surface Mount | | | | | | | |
| Series | | SKST | SKRA | SKHM | SKHU | SKTD | SKSN | SKTG | SKSL |
| Photo | |  |  |  |  |  |  |  |  |
| Features | | Middle travel | | — | — | Low-profile | Mid-mount | Half-mount | |
| Water-proof | | — | ○ | — | ○ | ● | — | ● | — |
| Dust-proof | | — | ○ | — | ○ | ● | — | ● | — |
| IP standard | | — | 67 equivalent | — | — | 67 equivalent | — | 67 equivalent | — |
| Operating direction | Top push | ● | ● | ● | ● | — | — | — | — |
| | Side push | — | — | — | — | ● | ● | ● | ● |
| Dimensions (mm) | W | □8.5 | □6.2 | 6.2 | 6.2 | 3.9 | 6.2 | 5.2 | 4.5 |
| | D | | | 6.5 | 6.3 | 2.9 | 3 | 3.5 | 2.6 |
| | H | 3.95 | 3.5/5.2 | 3.1 | 2.5/3.1 | 1.55 | 3.5 | 1.55 | 2.2 |
| Operation force coverage | 1N max. | 4N to 10N |  |  |  |  |  |  |  |
| | 1N to 2N | | | | | | | | |
| | 2N to 3N | | | | | | | | |
| | 3N to 4N | | | | | | | | |
| Travel (mm) | | 0.9 | See the relevant pages for respective product description | 0.25 | | 0.15 | 0.2 | 0.15 | |
| Ground terminal | | — | — | ● | ● | ● | ● | ● | ● |
| Operating temperature range | | -40°C to +90°C | | -40°C to +85°C | | -30°C to +85°C | -40°C to +85°C | -30°C to +85°C | |
| Automotive use | | ● | ○ | — | ○ | — | — | — | — |
| Life Cycle | |  |  |  |  |  |  |  |  |
| Electrical performance | Rating (max.) (Resistive load) | 50mA 16V DC | 50mA 12V DC | | | | | | |
| | Rating (min.) (Resistive load) | 10μA 1V DC | | | | | | | |
| | Insulation resistance | 100MΩ min. 100V DC 1min. | | | | | | | |
| | Voltage proof | 250V AC 1min. | | | | 100V AC 1min. | 250V AC 1min. | | 100V AC 1min. |
| Durability | Vibration | 10 to 55 to 10Hz/min., the amplitude is 1.5mm for all the frequencies, in the 3 direction of X, Y and Z for 2 hours respectively | | | | | | | |
| | Lifetime | Shall be in accordance with individual specifications. | | | | | | | |
| Environmental performance | Cold | -40°C 1,000h | | -40°C 96h | | | | | |
| | Dry heat | 90°C 1,000h | | 90°C 96h | 85°C 96h | 90°C 96h | 85°C 96h | 90°C 96h | |
| | Damp heat | 60°C, 90 to 95%RH 1,000h | | 60°C, 90 to 95%RH 96h | | | | | |
| Page | | 230 | 231 | 232 | 233 | 235 | 236 | 237 | 238 |

W : Width. The most outer dimension excluding terminal portion.
D : Depth. The most outer dimension excluding terminal portion.
H : Height. The minimum dimension if there are variances.

TACT Switch™ Soldering Conditions 249
TACT Switch™ Cautions 250

Notes

- The automotive operating temperature range to be individually discussed upon request.
- Indicates applicability to all products in the series, while ○ indicates applicability to some products in the series.

Condition for Reflow

Available for Surface Mount Type.

Temperature profile



Notes

1. Please confirm the specifications of our product for the detailed condition.
2. Soldering conditions differ depending on reflow soldering machines. Prior verification of soldering condition is highly recommended.

Conditions for Auto-dip

Available for Snap-in Type and Radial Type.

| Items | Condition |
|------------------------|---|
| Flux built-up | Mounting surface should not be exposed to flux |
| Preheating temperature | Ambient temperature of the soldered surface of PC board. 100°C max. |
| Preheating time | 60s max. |
| Soldering temperature | 260°C max. |
| Duration of immersion | 5s max. |
| Number of soldering | 2times max. |

SKHH Series

| Items | Condition |
|------------------------|---|
| Flux built-up | Mounting surface should not be exposed to flux |
| Preheating temperature | Ambient temperature of the soldered surface of PC board. 110°C max. |
| Preheating time | 60s max. |
| Soldering temperature | 260°C max. |
| Duration of immersion | 5s max. |
| Number of soldering | 2times max. |

SKHL Top Push Type, SKQJ Series

| Items | Condition |
|------------------------|---|
| Flux built-up | Mounting surface should not be exposed to flux |
| Preheating temperature | Ambient temperature of the soldered surface of PC board. 100°C max. |
| Preheating time | 45s max. |
| Soldering temperature | 255°C max. |
| Duration of immersion | 5s max. |
| Number of soldering | 2times max. |

Notes

1. Prevent flux penetration from the top side of the TACT Switch™.
2. Switch terminals and a PC board should not be coated with flux prior to soldering.
3. The second soldering should be done after the switch is stable with normal temperature.
4. Use the flux with a specific gravity of min 0.81.
(EC-19S-8 by TAMURA CORPORATION, or equivalents.)

Manual Soldering

| Items | Condition |
|----------------------------|------------|
| Soldering temperature | 350°C max. |
| Duration of soldering | 3s max. |
| Capacity of soldering iron | 60W max. |

SKHH, SKHW Series

| Items | Condition |
|----------------------------|------------|
| Soldering temperature | 360°C max. |
| Duration of soldering | 3s max. |
| Capacity of soldering iron | 60W max. |

SKTD, SKTG, SKQJ Series

| Items | Condition |
|----------------------------|------------|
| Soldering temperature | 350°C max. |
| Duration of soldering | 3s max. |
| Capacity of soldering iron | 20W max. |

Компания «Океан Электроники» предлагает заключение долгосрочных отношений при поставках импортных электронных компонентов на взаимовыгодных условиях!

Наши преимущества:

- Поставка оригинальных импортных электронных компонентов напрямую с производств Америки, Европы и Азии, а так же с крупнейших складов мира;
- Широкая линейка поставок активных и пассивных импортных электронных компонентов (более 30 млн. наименований);
- Поставка сложных, дефицитных, либо снятых с производства позиций;
- Оперативные сроки поставки под заказ (от 5 рабочих дней);
- Экспресс доставка в любую точку России;
- Помощь Конструкторского Отдела и консультации квалифицированных инженеров;
- Техническая поддержка проекта, помощь в подборе аналогов, поставка прототипов;
- Поставка электронных компонентов под контролем ВП;
- Система менеджмента качества сертифицирована по Международному стандарту ISO 9001;
- При необходимости вся продукция военного и аэрокосмического назначения проходит испытания и сертификацию в лаборатории (по согласованию с заказчиком);
- Поставка специализированных компонентов военного и аэрокосмического уровня качества (Xilinx, Altera, Analog Devices, Intersil, Interpoint, Microsemi, Actel, Aeroflex, Peregrine, VPT, Syfer, Eurofarad, Texas Instruments, MS Kennedy, Miteq, Cobham, E2V, MA-COM, Hittite, Mini-Circuits, General Dynamics и др.);

Компания «Океан Электроники» является официальным дистрибьютором и эксклюзивным представителем в России одного из крупнейших производителей разъемов военного и аэрокосмического назначения «JONHON», а так же официальным дистрибьютором и эксклюзивным представителем в России производителя высокотехнологичных и надежных решений для передачи СВЧ сигналов «FORSTAR».



JONHON

«JONHON» (основан в 1970 г.)

Разъемы специального, военного и аэрокосмического назначения:

(Применяются в военной, авиационной, аэрокосмической, морской, железнодорожной, горно- и нефтедобывающей отраслях промышленности)

«FORSTAR» (основан в 1998 г.)

ВЧ соединители, коаксиальные кабели, кабельные сборки и микроволновые компоненты:

(Применяются в телекоммуникациях гражданского и специального назначения, в средствах связи, РЛС, а так же военной, авиационной и аэрокосмической отраслях промышленности).



Телефон: 8 (812) 309-75-97 (многоканальный)

Факс: 8 (812) 320-03-32

Электронная почта: ocean@oceanchips.ru

Web: <http://oceanchips.ru/>

Адрес: 198099, г. Санкт-Петербург, ул. Калинина, д. 2, корп. 4, лит. А