



The Future of Analog IC Technology®

MP3214

500mA LED Camera Flash Charge Pump

DESCRIPTION

The MP3214 is a low noise, high current charge pump designed to drive LEDs at up to 500mA with an input supply of 2.7 to 5.5 volts. The high efficiency and low external parts count (two small bypass caps, two small charge pump caps, and one programming resistor) make the MP3214 ideally suited for portable applications where small size and high efficiency are critical.

The MP3214 controls the inrush current via a soft start algorithm. High frequency switching of the charge pump capacitors allows for very small capacitance values.

The output current is set by an external resistor, R_{SET} . The brightness of the LED can be modulated by a PWM on the enable pin.

The MP3214 automatically adjusts the switching mode of the charge pump for optimal efficiency.

The MP3214 is available in a 16 pin 3x3mm QFN package.

FEATURES

- High Efficiency
- Up to 500mA Output Current
- Wide Supply Range of 2.7V to 5.5 V
- Small Solution Size
- Soft Start
- Low Shutdown Current
- Open/Short Led Protection
- No Inductors
- Programmable Output Current
- PWM Brightness Control

APPLICATIONS

- LED Backlight
- LED Flash
- LED Torch/Flashlight
- Cell Phones, Cameras, PDA, and Handheld Equipment

For MPS green status, please visit MPS website under Quality Assurance. "MPS" and "The Future of Analog IC Technology" are Registered Trademarks of Monolithic Power Systems, Inc.

TYPICAL APPLICATION

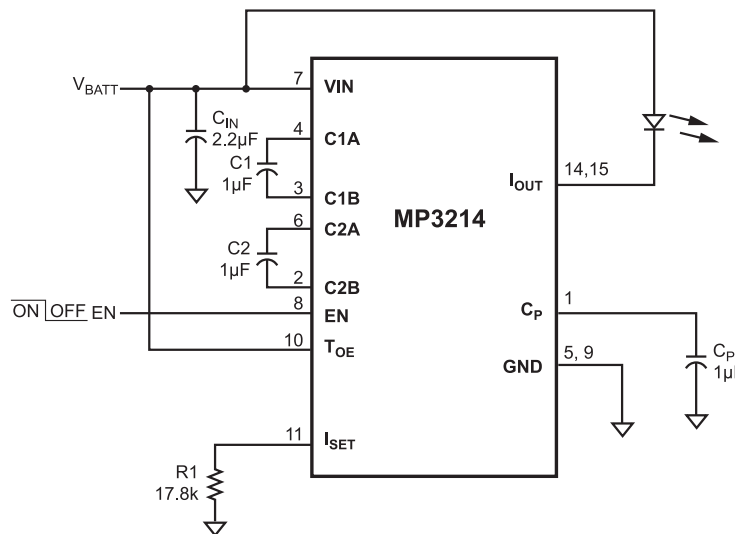

ORDERING INFORMATION

Part Number*	Package	Top Marking	Free Air Temperature (T _A)
MP3214DQ	QFN16 (3 x 3mm)	2F	-40°C to +85°C

* For Tape & Reel, add suffix -Z (g. MP3214DQ-Z).

For RoHS compliant packaging, add suffix -LF (e.g. MP3214DQ-LF-Z)

PACKAGE REFERENCE

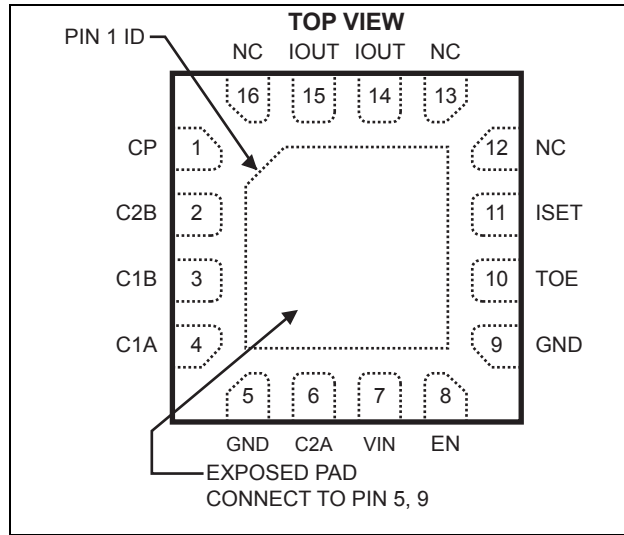

ABSOLUTE MAXIMUM RATINGS ⁽¹⁾

All Other Pins	-0.3V to +6.5V
Continuous Power Dissipation (T _A = +25°C) ⁽²⁾2.1W
Junction Temperature	150°C
Lead Temperature	260°C
Storage Temperature.....	-65°C to +150°C
Supply Voltage V _{IN}	2.5V to 6V

Recommended Operating Conditions ⁽²⁾

Supply Voltage V _{IN}	2.7V to 5.5V
Maximum Junction Temp. (T _J).....	+125°C

Thermal Resistance ⁽³⁾	θ_{JA}	θ_{JC}
QFN16 (3 x 3mm)	60	12 ... °C/W

Notes:

- Exceeding these ratings may damage the device.
- The maximum allowable power dissipation is a function of the maximum junction temperature T_J (MAX), the junction-to-ambient thermal resistance θ_{JA} , and the ambient temperature T_A. The maximum allowable continuous power dissipation at any ambient temperature is calculated by P_D (MAX) = (T_J (MAX)-T_A)/ θ_{JA} . Exceeding the maximum allowable power dissipation will cause excessive die temperature, and the regulator will go into thermal shutdown. Internal thermal shutdown circuitry protects the device from permanent damage.
- The device is not guaranteed to function outside of its operating conditions.
- Measured on JESD51-7, 4-layer PCB.

ELECTRICAL CHARACTERISTICS

$V_{BATT} = 3.6V$, $C1=C2=2.2\mu F$, $C_{OUT}=4.7\mu F$, $C_{BYPASS}=1\mu F$, $T_A = +25^\circ C$, unless otherwise noted.

Parameter	Symbol	Condition	Min	Typ	Max	Units
Input Supply Voltage	V_{IN}		2.7		5.5	V
Supply Current	I_{IN}			3		mA
Shutdown Current	$I_{SHUTDOWN}$			0.1		μA
I_{LED} Drop Out Voltage				0.3		V
LED Current Turn On Delay				4		μs
Clock Frequency				1.35		MHz
En Threshold High				0.81		V
En Threshold Low				0.75		V
I_{OUT} Gain Accuracy		I_{OUT} Measured with $R_{SET}=17.8k$	186	202	218	mA
Gain Coefficient		$I_{OUT} = Gain/R_{SET}$	-8%	3600	+8%	V
Thermal Shutdown				150		$^\circ C$

Note:

- 5) Current matching definition: $(Max - Min)/(Max + Min)$
- 6) Guaranteed by design.

PIN FUNCTIONS

Pin #	Name	Description
1	CP	Charge pump bypass for common anode version. Connect a 2.2 μ F bypass capacitor to GND.
2	C2B	Charge Pump Capacitor #2 Negative Node. Connect the negative side of the #2 charge pump capacitor to C2B.
3	C1B	Charge Pump Capacitor #1 Negative Node. Connect the negative side of the #1 charge pump capacitor to C1B.
4	C1A	Charge Pump Capacitor #1 Positive Node. Connect the positive side of the #1 charge pump capacitor to C1A. Typical applications require C1 to be 1 μ F.
5,9	GND	Battery Power Ground. Connect the exposed pad to this pin.
6	C2A	Charge Pump Capacitor #2 Positive Node. Connect the positive side of the #2 charge pump capacitor to C2A. Typical applications require C2 to be 1 μ F.
7	VIN	Battery Power Input. Connect the 2.5V to 5.5V input source between BATT and GND. Bypass BATT to GND with a 2.2 μ F or greater capacitor.
8	EN	Enable input.
10	TOE	Time Out Enable. With TOE=1 the time out is enabled. The device will keep operating for a period of time after the EN pin goes low.
11	ISET	Current Control Input. Connect a resistor between ISET and GND to set the LED current up to 500mA.
12,13,16	NC	No connection.
14,15	IOUT	Driver for Flashlight. Connect the flashlight LED between this pin and BATT, with the anode at BATT.

BLOCK DIAGRAM

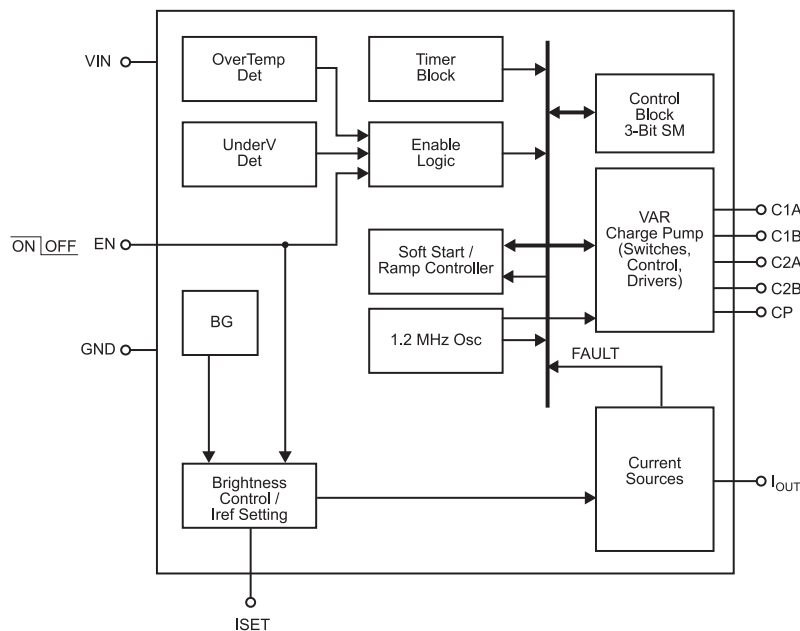
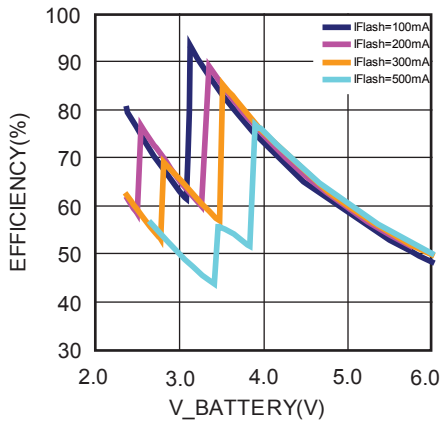

Figure 1—Functional Block Diagram

TYPICAL PERFORMANCE CHARACTERISTICS

Efficiency



Flash Current Regulation vs. Battery Voltage:

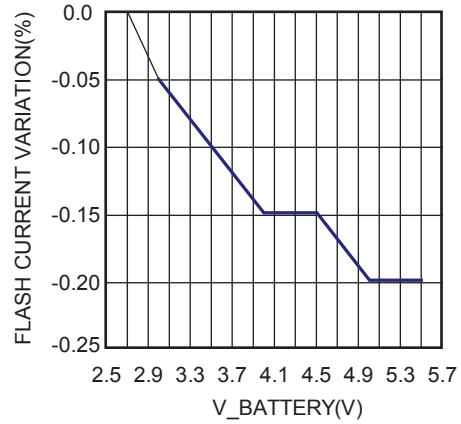

Average Flash Current vs. Dimming Duty Cycle

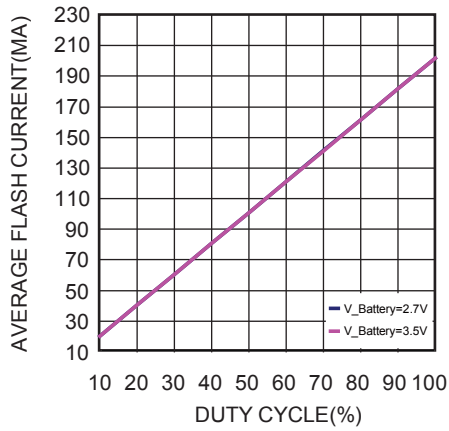

Measurement

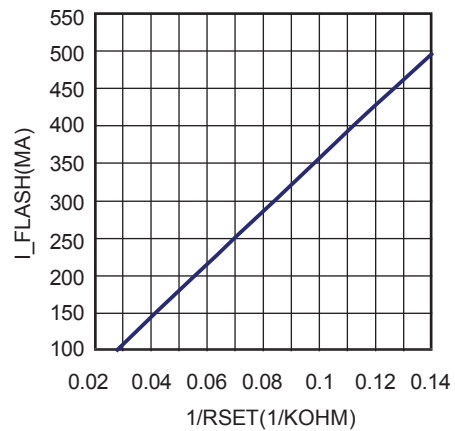

TYPICAL PERFORMANCE CHARACTERISTICS

Charge Pump

Vin=3.5V, I_LED =500mA, 1.5X mode

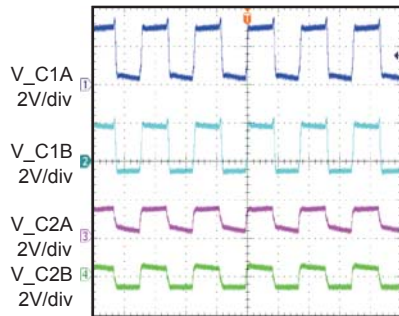

400ns/div

Charge Pump

Vin=2.7V, I_LED =500mA, 2.0X mode

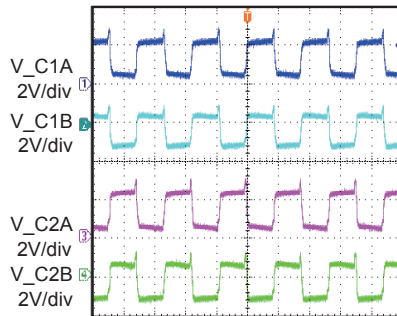

400ns/div

Start up and Shut down

Start up at 1X Mode, V_BAT=4.2V

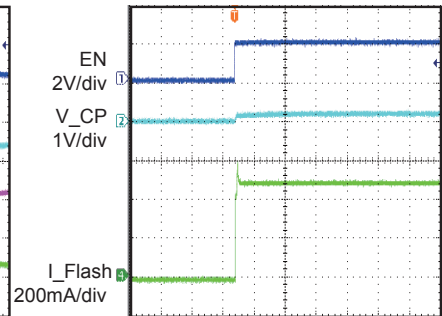

100µs/div

Start up and Shut down

Shut down at 1X Mode, V_BAT=4.2V

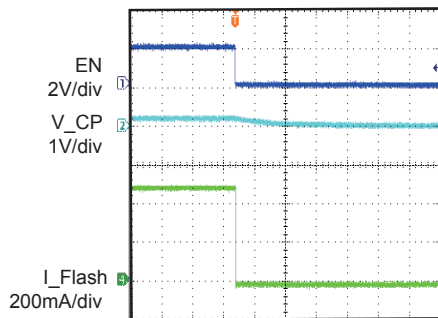

100µs/div

Start up and Shut down

Start up at 1.5X Mode, V_BAT=3.5V

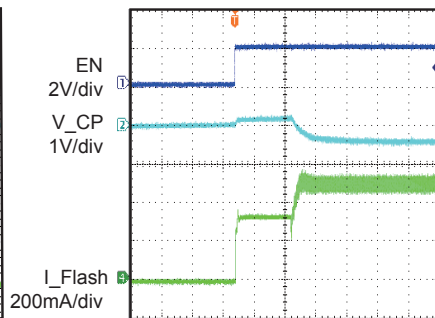

100µs/div

Start up and Shut down

Shut down at 1.5X Mode, V_BAT=3.5V

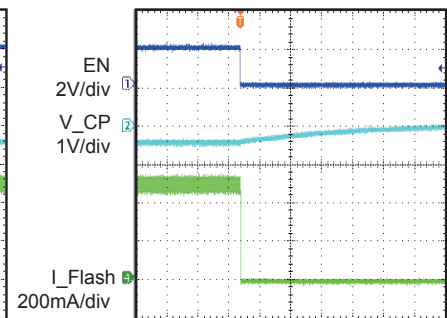

100µs/div

Start up and Shut down

Start up at 2X Mode, V_BAT=2.7V

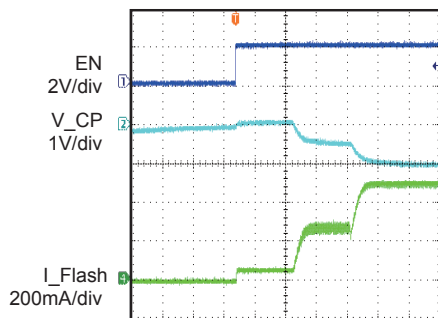

100µs/div

Start up and Shut down

Shut down at 2X Mode, V_BAT=2.7V

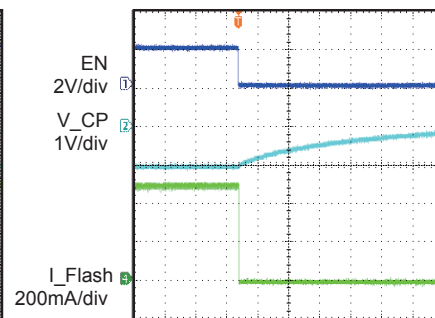

100µs/div

Mode 1.5X to 1X retry

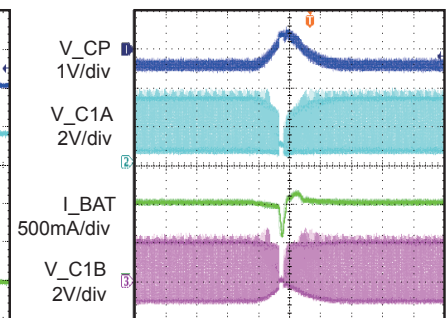

40µs/div

TYPICAL PERFORMANCE CHARACTERISTICS

Mode change from 1X to 1.5

Mode change from 1.5X to 2X

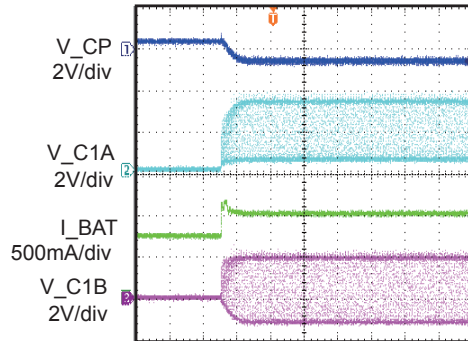

100µs/div

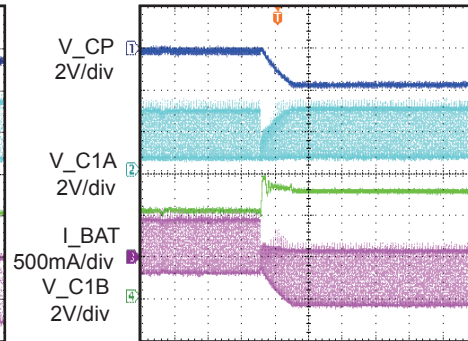

100µs/div

OPERATION

Using the Enable Pin to PWM the LED Current

The Enable (En) pin can enable (logic 1) or disable (logic 0) the part. When disabled, the part enters a low current sleep mode.

There is an internal one shot on the enable pin. The enable pin must go low for more than 30mS in order to completely disable the part and enter the low current shutdown mode. Although the part internally does not immediately shut off, the output drive to the LED does immediately turn off.

A low frequency PWM on the enable pin (50Hz to 2kHz) can be used to change the LED brightness. For example, if a 20% duty cycle PWM signal is applied to the enable pin, the average output current is 20% the full current.

Setting the Output Current

The output current is set by the resistor R_{SET} . R_{SET} is connected from the I_{SET} pin to ground. The output current follows the equation:

$$I_{OUT} = \frac{3570}{R_{SET}}$$

or for a desired I_{OUT} , R_{SET} is calculated by:

$$R_{SET} = \frac{3570}{I_{OUT}}$$

For example:

R_{SET}	I_{OUT}
7140Ω	500mA
8925Ω	400mA
11900Ω	300mA
17850Ω	200mA
35700Ω	100mA

Charge Pump Operation

Normal battery operation will supply a voltage that is initially high (roughly 4.2volts when fully charge) falling to a mid voltage for much of it's life (roughly 3 to 3.6 volts) and finally dropping to a low voltage (roughly 2.7 to 3.0 volts) when fully discharged. At the high end of the battery voltage, the LED can be driven directly from the battery to ground. As the battery discharges, the voltage must be boosted to allow enough forward voltage to turn on the LED. On the MP3214, the boost voltage pushes the charge pump output (CP) below ground to gain the required headroom.

The charge pump gain can be changed on the fly to optimize the charge pump voltage for maximum efficiency. The gain can be configured to be 1, 1.5 or 2. The charge pump gain control is accomplished automatically by an internal feedback network.

Time Out Enable

The TOE function acts to extend the device operation, for a period of time, after the enabled pin goes low. With TOE=1 the time out is enabled. When the enable pin goes high, the part turns on as in normal operation. When the enable pin goes low, the part and the output, remain on for an extra 1.55 seconds.

When TOE=0, the enabled pin functions directly bases on the logic level of the input. The part turns on when enable is high, and off when enable is low.

PACKAGE INFORMATION

QFN16 (3 x 3mm)

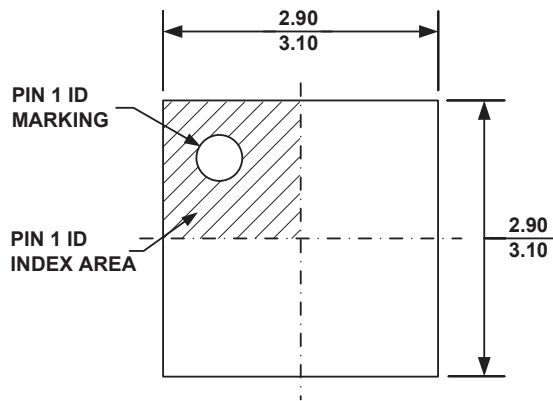

TOP VIEW

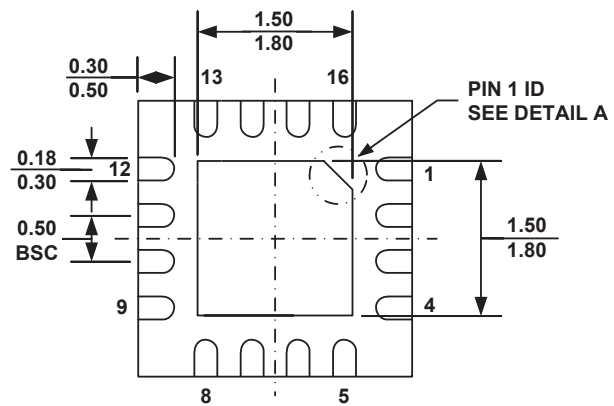

BOTTOM VIEW

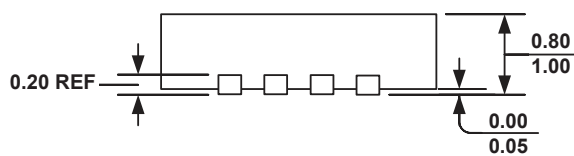

SIDE VIEW

PIN 1 ID OPTION A
0.30x45° TYP.

PIN 1 ID OPTION B
R0.20 TYP.

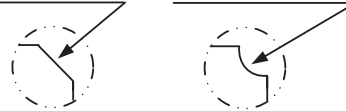

DETAIL A

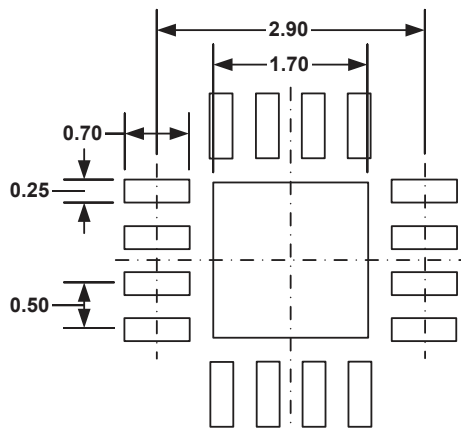

RECOMMENDED LAND PATTERN

NOTE:

- 1) ALL DIMENSIONS ARE IN MILLIMETERS.
- 2) EXPOSED PADDLE SIZE DOES NOT INCLUDE MOLD FLASH.
- 3) LEAD COPLANARITY SHALL BE 0.10 MILLIMETER MAX.
- 4) DRAWING CONFORMS TO JEDEC MO-220, VARIATION VEED-4.
- 5) DRAWING IS NOT TO SCALE.

NOTICE: The information in this document is subject to change without notice. Users should warrant and guarantee that third party Intellectual Property rights are not infringed upon when integrating MPS products into any application. MPS will not assume any legal responsibility for any said applications.

Компания «Океан Электроники» предлагает заключение долгосрочных отношений при поставках импортных электронных компонентов на взаимовыгодных условиях!

Наши преимущества:

- Поставка оригинальных импортных электронных компонентов напрямую с производств Америки, Европы и Азии, а так же с крупнейших складов мира;
- Широкая линейка поставок активных и пассивных импортных электронных компонентов (более 30 млн. наименований);
- Поставка сложных, дефицитных, либо снятых с производства позиций;
- Оперативные сроки поставки под заказ (от 5 рабочих дней);
- Экспресс доставка в любую точку России;
- Помощь Конструкторского Отдела и консультации квалифицированных инженеров;
- Техническая поддержка проекта, помощь в подборе аналогов, поставка прототипов;
- Поставка электронных компонентов под контролем ВП;
- Система менеджмента качества сертифицирована по Международному стандарту ISO 9001;
- При необходимости вся продукция военного и аэрокосмического назначения проходит испытания и сертификацию в лаборатории (по согласованию с заказчиком);
- Поставка специализированных компонентов военного и аэрокосмического уровня качества (Xilinx, Altera, Analog Devices, Intersil, Interpoint, Microsemi, Actel, Aeroflex, Peregrine, VPT, Syfer, Eurofarad, Texas Instruments, MS Kennedy, Miteq, Cobham, E2V, MA-COM, Hittite, Mini-Circuits, General Dynamics и др.);

Компания «Океан Электроники» является официальным дистрибьютором и эксклюзивным представителем в России одного из крупнейших производителей разъемов военного и аэрокосмического назначения «JONHON», а так же официальным дистрибьютором и эксклюзивным представителем в России производителя высокотехнологичных и надежных решений для передачи СВЧ сигналов «FORSTAR».



JONHON

«JONHON» (основан в 1970 г.)

Разъемы специального, военного и аэрокосмического назначения:

(Применяются в военной, авиационной, аэрокосмической, морской, железнодорожной, горно- и нефтедобывающей отраслях промышленности)

«FORSTAR» (основан в 1998 г.)

ВЧ соединители, коаксиальные кабели, кабельные сборки и микроволновые компоненты:

(Применяются в телекоммуникациях гражданского и специального назначения, в средствах связи, РЛС, а так же военной, авиационной и аэрокосмической отраслях промышленности).



Телефон: 8 (812) 309-75-97 (многоканальный)

Факс: 8 (812) 320-03-32

Электронная почта: ocean@oceanchips.ru

Web: <http://oceanchips.ru/>

Адрес: 198099, г. Санкт-Петербург, ул. Калинина, д. 2, корп. 4, лит. А