

MECHANICAL DATA

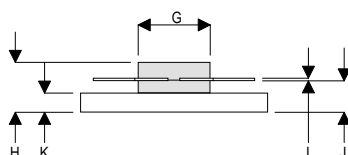
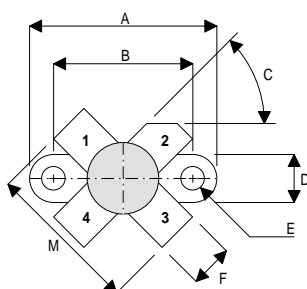

DA

PIN 1 SOURCE                      PIN 2 DRAIN  
 PIN 3 SOURCE                      PIN 4 GATE

DIM	mm	Tol.	Inches	Tol.
A	24.76	0.13	0.975	0.005
B	18.42	0.13	0.725	0.005
C	45°	5°	45°	5°
D	6.35	0.13	0.25	0.005
E	3.17	0.13	0.125 DIA	0.005
F	5.71	0.13	0.225	0.005
G	9.52	0.13	0.375	0.005
H	6.60	REF	0.260	REF
I	0.13	0.02	0.005	0.001
J	4.32	0.13	0.170	0.005
K	2.54	0.13	0.100	0.005
M	20.32	0.25	0.800	0.010

**GOLD METALLISED  
 MULTI-PURPOSE SILICON  
 DMOS RF FET  
 20W – 28V – 175MHz  
 SINGLE ENDED**

**FEATURES**

- SIMPLIFIED AMPLIFIER DESIGN
- SUITABLE FOR BROAD BAND APPLICATIONS
- LOW  $C_{rss}$
- SIMPLE BIAS CIRCUITS
- LOW NOISE
- HIGH GAIN – 16 dB MINIMUM

**APPLICATIONS**

- HF/VHF/UHF COMMUNICATIONS  
 from 1 MHz to 175 MHz

**ABSOLUTE MAXIMUM RATINGS** ( $T_{case} = 25^{\circ}C$  unless otherwise stated)

$P_D$	Power Dissipation	50W
$BV_{DSS}$	Drain – Source Breakdown Voltage	70V
$BV_{GSS}$	Gate – Source Breakdown Voltage	$\pm 20V$
$I_{D(sat)}$	Drain Current	5A
$T_{stg}$	Storage Temperature	$-65$ to $150^{\circ}C$
$T_j$	Maximum Operating Junction Temperature	$200^{\circ}C$

Semelab Plc reserves the right to change test conditions, parameter limits and package dimensions without notice. Information furnished by Semelab is believed to be both accurate and reliable at the time of going to press. However Semelab assumes no responsibility for any errors or omissions discovered in its use. Semelab encourages customers to verify that datasheets are current before placing orders.

## ELECTRICAL CHARACTERISTICS (T<sub>case</sub> = 25°C unless otherwise stated)

Parameter	Test Conditions	Min.	Typ.	Max.	Unit
B <sub>V</sub> DSS Drain-Source Breakdown Voltage	V <sub>GS</sub> = 0      I <sub>D</sub> = 100mA	70			V
I <sub>D</sub> DSS Zero Gate Voltage Drain Current	V <sub>DS</sub> = 28V      V <sub>GS</sub> = 0			1	mA
I <sub>G</sub> DSS Gate Leakage Current	V <sub>GS</sub> = 20V      V <sub>DS</sub> = 0			1	μA
V <sub>GS(th)</sub> Gate Threshold Voltage*	I <sub>D</sub> = 10mA      V <sub>DS</sub> = V <sub>GS</sub>	1		7	V
g <sub>fs</sub> Forward Transconductance*	V <sub>DS</sub> = 10V      I <sub>D</sub> = 1A	0.8			S
G <sub>PS</sub> Common Source Power Gain	P <sub>O</sub> = 20W	16			dB
η Drain Efficiency	V <sub>DS</sub> = 28V      I <sub>DQ</sub> = 0.1A	50			%
VSWR Load Mismatch Tolerance	f = 175MHz	20:1			—
C <sub>iss</sub> Input Capacitance	V <sub>DS</sub> = 28V      V <sub>GS</sub> = -5V      f = 1MHz			60	pF
C <sub>oss</sub> Output Capacitance	V <sub>DS</sub> = 28V      V <sub>GS</sub> = 0      f = 1MHz			30	pF
C <sub>rss</sub> Reverse Transfer Capacitance	V <sub>DS</sub> = 28V      V <sub>GS</sub> = 0      f = 1MHz			2.5	pF
R <sub>dson</sub> Saturation Resistance	V <sub>GS</sub> = 20V      I <sub>DS</sub> = 2.5A		1		Ω

\* Pulse Test: Pulse Duration = 300 μs , Duty Cycle ≤ 2%

## HAZARDOUS MATERIAL WARNING

The ceramic portion of the device between leads and metal flange is beryllium oxide. Beryllium oxide dust is highly toxic and care must be taken during handling and mounting to avoid damage to this area.

**THESE DEVICES MUST NEVER BE THROWN AWAY WITH GENERAL INDUSTRIAL OR DOMESTIC WASTE.**

## THERMAL DATA

R <sub>THj-case</sub>	Thermal Resistance Junction – Case	Max. 3.5°C / W
-----------------------	------------------------------------	----------------

Semelab Plc reserves the right to change test conditions, parameter limits and package dimensions without notice. Information furnished by Semelab is believed to be both accurate and reliable at the time of going to press. However Semelab assumes no responsibility for any errors or omissions discovered in its use. Semelab encourages customers to verify that datasheets are current before placing orders.

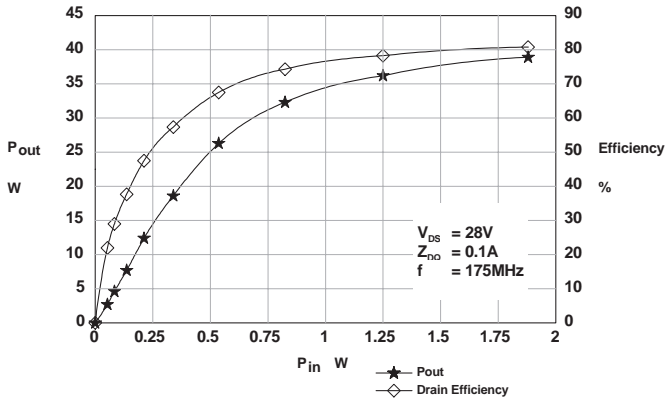

Figure 1 – Power Output and Efficiency vs. Power Input.

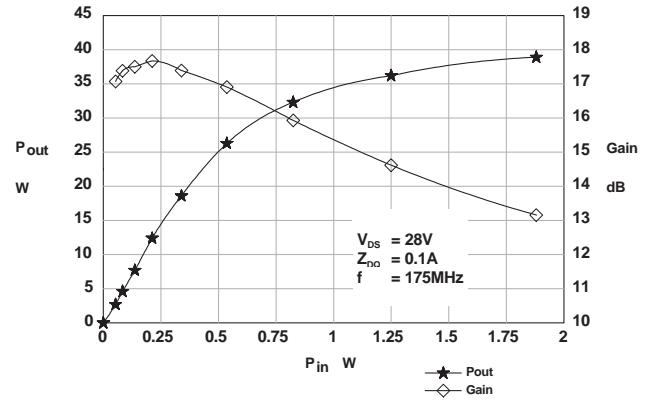

Figure 2 – Power Output & Gain vs. Power Input.

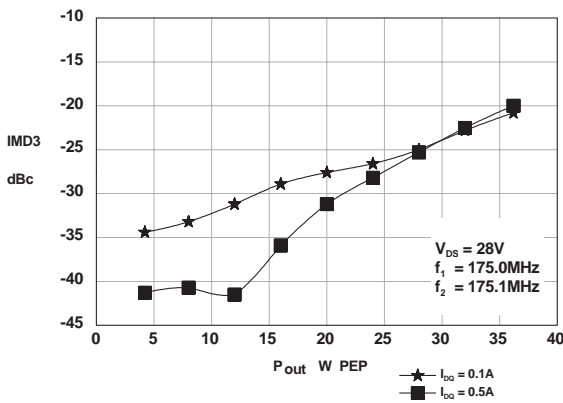

Figure 3 – IMD vs. Output Power.

**D1001UK**  
**OPTIMUM SOURCE AND LOAD IMPEDANCE**

Frequency MHz	Z <sub>S</sub> Ω	Z <sub>L</sub> Ω
175MHz	5 + j14	12 - j14

**Typical S Parameters**

! V<sub>DS</sub> = 28V, I<sub>DQ</sub> = 0.1A  
# MHZ S MA R 50

!Freq MHz	S11		S21		S12		S22	
	mag	ang	mag	ang	mag	ang	mag	ang
50	0.780	-116	18	112	0.034	25	0.642	-85
100	0.775	-135	9.312	85	0.030	11	0.577	-103
150	0.795	-149	6.077	68	0.022	14	0.613	-116
200	0.826	-159	4.193	53	0.017	44	0.669	-128
250	0.853	-169	3.216	43	0.023	74	0.715	-139
300	0.878	-179	2.566	35	0.039	89	0.759	-150
350	0.903	171	1.991	23	0.052	86	0.801	-161
400	0.923	161	1.655	18	0.070	84	0.839	-173
450	0.944	151	1.322	9	0.080	80	0.878	177
500	0.963	142	1.121	4	0.098	76	0.914	167
550	0.978	136	0.899	-2	0.108	72	0.945	159
600	0.985	131	0.762	-7	0.119	66	0.966	153

Semelab Plc reserves the right to change test conditions, parameter limits and package dimensions without notice. Information furnished by Semelab is believed to be both accurate and reliable at the time of going to press. However Semelab assumes no responsibility for any errors or omissions discovered in its use. Semelab encourages customers to verify that datasheets are current before placing orders.

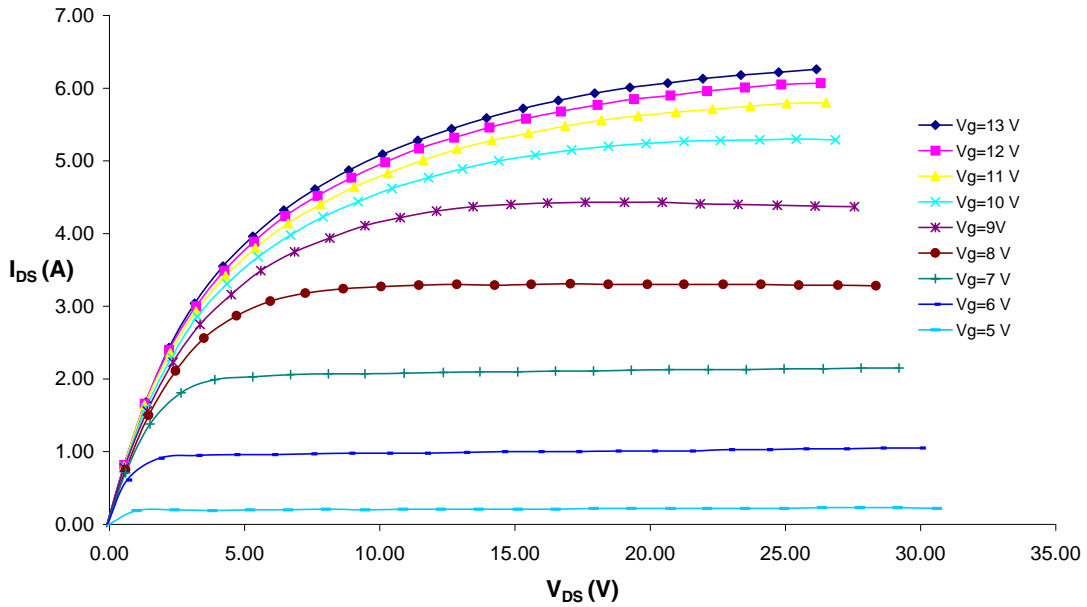

Figure 4 – Typical IV Characteristics.

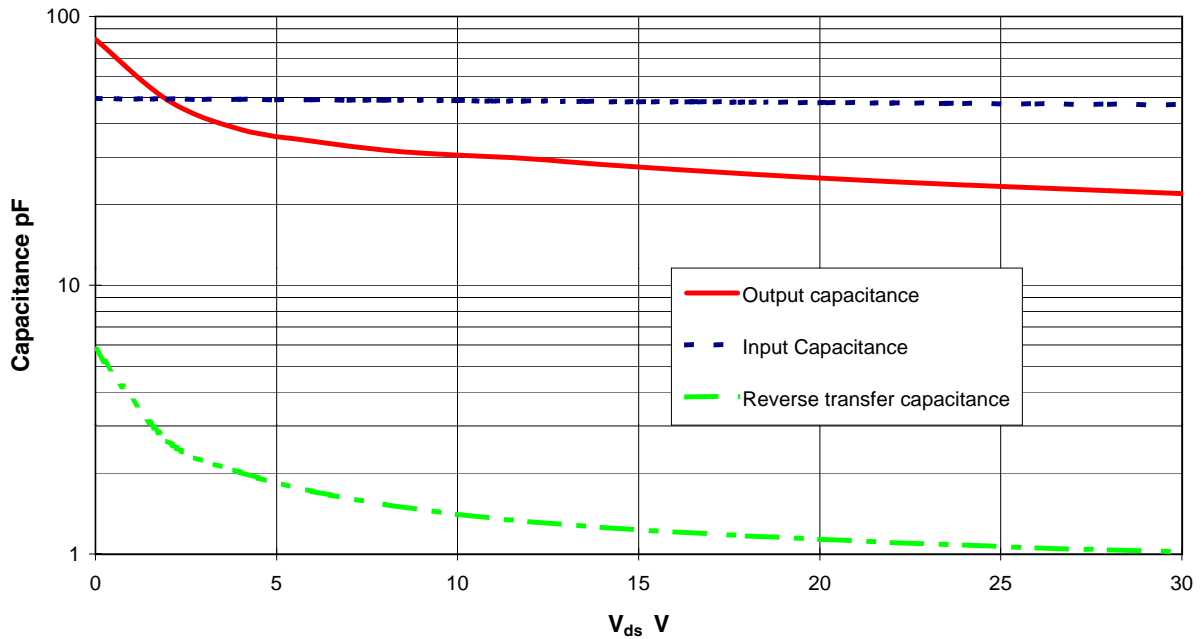
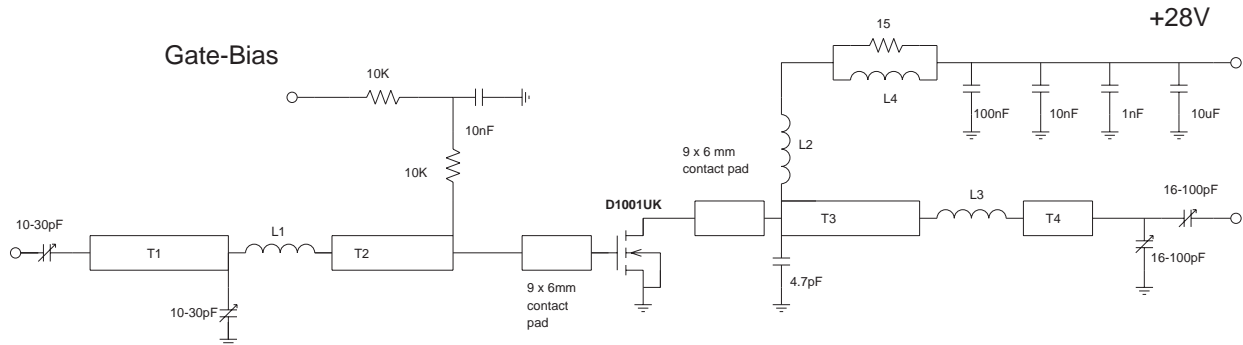

Figure 5 – Typical CV Characteristics.

Semelab Plc reserves the right to change test conditions, parameter limits and package dimensions without notice. Information furnished by Semelab is believed to be both accurate and reliable at the time of going to press. However Semelab assumes no responsibility for any errors or omissions discovered in its use. Semelab encourages customers to verify that datasheets are current before placing orders.



## D1001UK 175MHz TEST FIXTURE

Substrate 1.6mm PTFE/glass, Er=2.5  
All microstrip lines W=4.4mm

T1	10mm	L1	1.5 turns 22swg enamelled copper wire, 6mm i.d.
T2	13mm	L2	10 turns 19swg enamelled copper wire, 6mm i.d.
T3	12mm	L3	1.5 turns 22swg enamelled copper wire, 6mm i.d.
T4	4mm	L4	13.5 turns 19swg enamelled copper wire on Siemens B64920A618X830 ferrite core

# Mouser Electronics

Authorized Distributor

Click to View Pricing, Inventory, Delivery & Lifecycle Information:

[TT Electronics:](#)

[D1001UK](#)

Компания «Океан Электроники» предлагает заключение долгосрочных отношений при поставках импортных электронных компонентов на взаимовыгодных условиях!

Наши преимущества:

- Поставка оригинальных импортных электронных компонентов напрямую с производств Америки, Европы и Азии, а так же с крупнейших складов мира;
- Широкая линейка поставок активных и пассивных импортных электронных компонентов (более 30 млн. наименований);
- Поставка сложных, дефицитных, либо снятых с производства позиций;
- Оперативные сроки поставки под заказ (от 5 рабочих дней);
- Экспресс доставка в любую точку России;
- Помощь Конструкторского Отдела и консультации квалифицированных инженеров;
- Техническая поддержка проекта, помощь в подборе аналогов, поставка прототипов;
- Поставка электронных компонентов под контролем ВП;
- Система менеджмента качества сертифицирована по Международному стандарту ISO 9001;
- При необходимости вся продукция военного и аэрокосмического назначения проходит испытания и сертификацию в лаборатории (по согласованию с заказчиком);
- Поставка специализированных компонентов военного и аэрокосмического уровня качества (Xilinx, Altera, Analog Devices, Intersil, Interpoint, Microsemi, Actel, Aeroflex, Peregrine, VPT, Syfer, Eurofarad, Texas Instruments, MS Kennedy, Miteq, Cobham, E2V, MA-COM, Hittite, Mini-Circuits, General Dynamics и др.);

Компания «Океан Электроники» является официальным дистрибьютором и эксклюзивным представителем в России одного из крупнейших производителей разъемов военного и аэрокосмического назначения «JONHON», а так же официальным дистрибьютором и эксклюзивным представителем в России производителя высокотехнологичных и надежных решений для передачи СВЧ сигналов «FORSTAR».



## JONHON

«JONHON» (основан в 1970 г.)

Разъемы специального, военного и аэрокосмического назначения:

(Применяются в военной, авиационной, аэрокосмической, морской, железнодорожной, горно- и нефтедобывающей отраслях промышленности)

«FORSTAR» (основан в 1998 г.)

ВЧ соединители, коаксиальные кабели, кабельные сборки и микроволновые компоненты:

(Применяются в телекоммуникациях гражданского и специального назначения, в средствах связи, РЛС, а так же военной, авиационной и аэрокосмической отраслях промышленности).



Телефон: 8 (812) 309-75-97 (многоканальный)

Факс: 8 (812) 320-03-32

Электронная почта: [ocean@oceanchips.ru](mailto:ocean@oceanchips.ru)

Web: <http://oceanchips.ru/>

Адрес: 198099, г. Санкт-Петербург, ул. Калинина, д. 2, корп. 4, лит. А