

# MPI40-V2

## High current, low profile, miniature power inductors



### Product features

- High current carrying capacity
- Magnetically shielded, Low EMI
- Rugged flexible construction
- Self resonant frequency (SRF) greater than 9.5 MHz
- Inductance range from 0.1  $\mu$ H to 22  $\mu$ H
- Current range from 1.2 A to 22 A
- 4.75 mm x 4.45 mm footprint surface mount package in 1.2 mm, 1.5 mm, and 2.0 mm heights
- Moisture Sensitivity Level (MSL): 1

### Applications

- Handheld/mobile devices
- Portable media players
- Notebook/netbook/laptop regulators
- Tablets/smartbooks
- Battery operated devices
- LED drivers
- LCD displays
- Point-of-load (POL) converters

### Environmental data

- Storage temperature range (Component): -55 °C to +125 °C
- Operating temperature range: -55 °C to +125 °C (ambient plus self-temperature rise)
- Solder reflow temperature: J-STD-020 (latest revision) compliant
- Halogen free, lead free, RoHS compliant



Product specifications

Part Number <sup>5</sup>	OCL <sup>1</sup> ( $\mu$ H) $\pm$ 20%	Part marking designator	$I_{rms}^2$ (A)	$I_{sat}^3$ (A)	DCR (m $\Omega$ ) typical @ +20 °C	DCR (m $\Omega$ ) maximum @ +20 °C	SRF (MHz) typical	K-factor <sup>4</sup>
<b>1.2 mm height</b>								
MPI4012V2-R33-R	0.33	A	7.5	11	11	13.5	128	2480
MPI4012V2-R47-R	0.47	B	5.6	6.8	19	23	106	2470
MPI4012V2-R68-R	0.68	C	4.5	6.7	28	33.5	98	2223
MPI4012V2-1R0-R	1.0	D	4.3	6.5	38.5	46.5	64	1477
MPI4012V2-1R5-R	1.5	E	3.3	4.3	55	66	63	1264
MPI4012V2-2R2-R	2.2	F	2.9	4.2	75	90	35	1143
MPI4012V2-4R7-R	4.7	G	1.8	2.8	175	210	29	890
<b>1.5 mm height</b>								
MPI4015V2-R22-R	0.22	A	10.5	14	6.0	7.5	153	2649
MPI4015V2-R33-R	0.33	B	9.5	11	7.0	8.5	120	2158
MPI4015V2-R47-R	0.47	C	7.8	9.0	11	14	98	1991
MPI4015V2-R56-R	0.56	D	7.5	8.3	12	14	84	1942
MPI4015V2-R68-R	0.68	E	6.8	8.0	16	19	81	1437
MPI4015V2-1R0-R	1.0	F	5.5	6.0	23	27	56	1382
MPI4015V2-1R5-R	1.5	G	4.2	4.6	48	58	48	1468
MPI4015V2-2R2-R	2.2	H	2.9	4.5	65	78	42	920
MPI4015V2-3R3-R	3.3	I	3.0	3.2	77	92	31	854
MPI4015V2-4R7-R	4.7	J	2.2	3.0	108	130	22	791
MPI4015V2-6R8-R	6.8	K	2.0	2.3	172	207	21	609
MPI4015V2-100-R	10	L	1.8	2.1	245	294	14	766
<b>2.0 mm height</b>								
MPI4020V2-R10-R	0.10	A	16	22	3.5	4.5	343	2692
MPI4020V2-R22-R	0.22	B	13	17	5.5	6.6	165	2036
MPI4020V2-R33-R	0.33	C	9.5	12	7.5	9.0	113	1268
MPI4020V2-R47-R	0.47	D	8.5	11	10.5	13	95	1219
MPI4020V2-R56-R	0.56	E	8.0	10	12	15	87	1205
MPI4020V2-R68-R	0.68	F	7.5	9.0	12.5	16	80	1201
MPI4020V2-1R0-R	1.0	G	6.5	7.0	20	24	65	1168
MPI4020V2-1R2-R	1.2	H	6.5	6.8	23	28	52	1110
MPI4020V2-1R5-R	1.5	I	5.0	6.0	25	30	45	1038
MPI4020V2-2R2-R	2.2	J	3.8	5.5	40	48	33	711
MPI4020V2-3R3-R	3.3	K	3.3	4.0	71	85	25	643
MPI4020V2-4R7-R	4.7	L	2.7	3.2	98	118	24	453
MPI4020V2-6R8-R	6.8	M	2.0	2.6	167	192	23	482
MPI4020V2-100-R	10	N	1.7	2.2	245	281	17	307
MPI4020V2-150-R	15	O	1.5	1.8	320	384	13	257
MPI4020V2-220-R	22	P	1.2	1.65	350	402	9.5	215

1. Open Circuit Inductance (OCL) Test Parameters: 100 kHz, 1.0 Vrms, 0.0 Adc, +25 °C.  
 2.  $I_{rms}$ : DC current for an approximate temperature rise of 40 °C without core loss. Derating is necessary for AC currents. PCB layout, trace thickness and width, air-flow, and proximity of other heat generating components will affect the temperature rise. It is recommended that the temperature of the part not exceed +125 °C under worst case operating conditions verified in the end application.  
 3.  $I_{sat}$ : Peak current for approximately 30% rolloff @ +25 °C.

4. K-factor: Used to determine Bp-p for core loss (see graph).  $Bp-p = K * L * \Delta I$ . Bp-p (Gauss), K: (K-factor from table), L: (Inductance in  $\mu$ H),  $\Delta I$  (Peak to peak ripple current in Amps).  
 5. Part Number Definition: MPI40xxV2-xxx-R  
 MPI40 = Product code  
 xx= Height indicator  
 V2=Version indicator  
 xxx= inductance value in  $\mu$ H, R= decimal point,  
 If no R is present then last character equals number of zeros  
 -R suffix = RoHS compliant

Dimensions (mm)

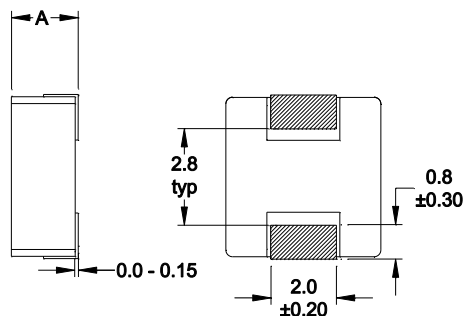
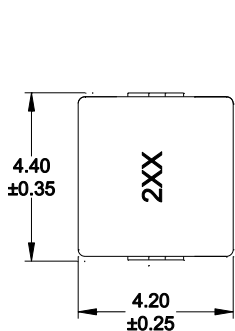

Dimension A	
MPI4012V2	1.00 ±0.20
MPI4015V2	1.30 ±0.20
MPI4020V2	1.80 ±0.20

Recommended Pad Layout

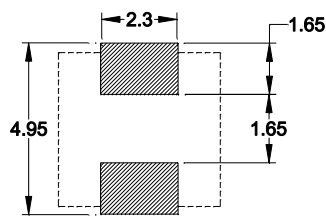

Schematic

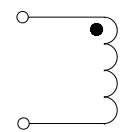

Part marking: 2xx (2 = version, x = inductance value per "Part marking designator" listed in Product specification table, x = bi-weekly date code)

All soldering surfaces to be coplanar within 0.10 millimeters

Tolerances are ±0.3 millimeters unless stated otherwise

Pad layout tolerances are ±0.1 millimeters unless stated otherwise

Do not route traces or vias underneath the inductor

Packaging information (mm)

Drawing not to scale

Supplied in tape and reel packaging , 3000 parts per 13" diameter reel

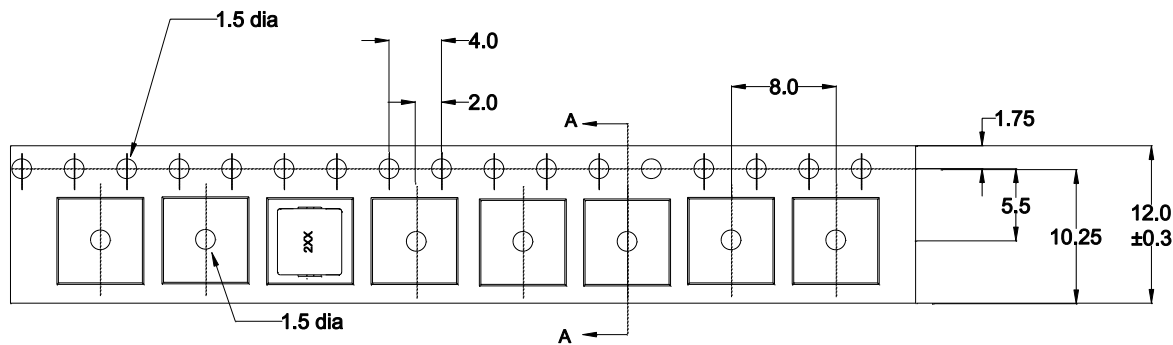

KO	
MPI4012V2	1.4
MPI4015V2	1.8
MPI4020V2	2.5

Direction of feed →

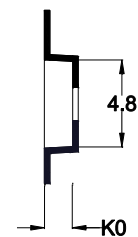

Section A-A

Core loss vs Bp-p

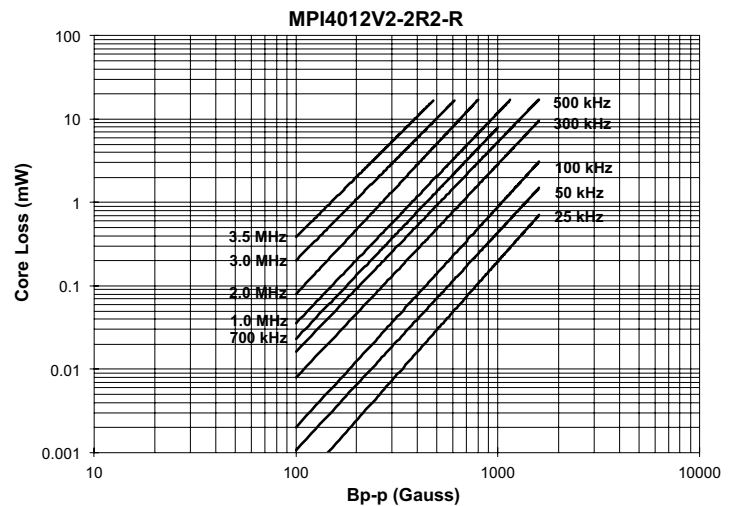
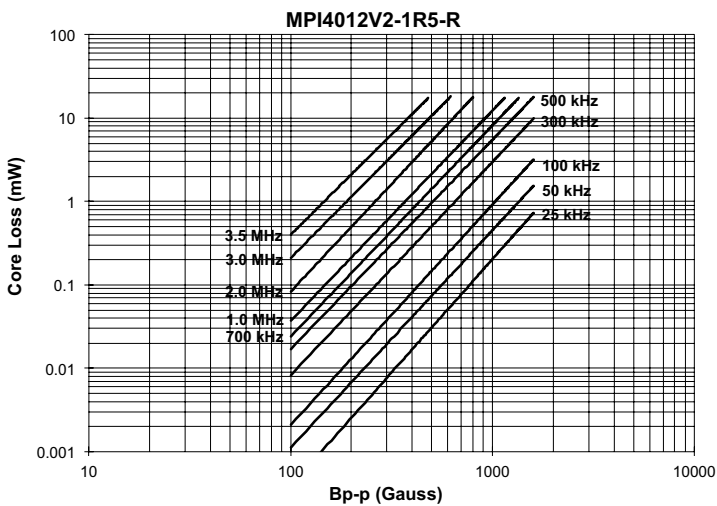
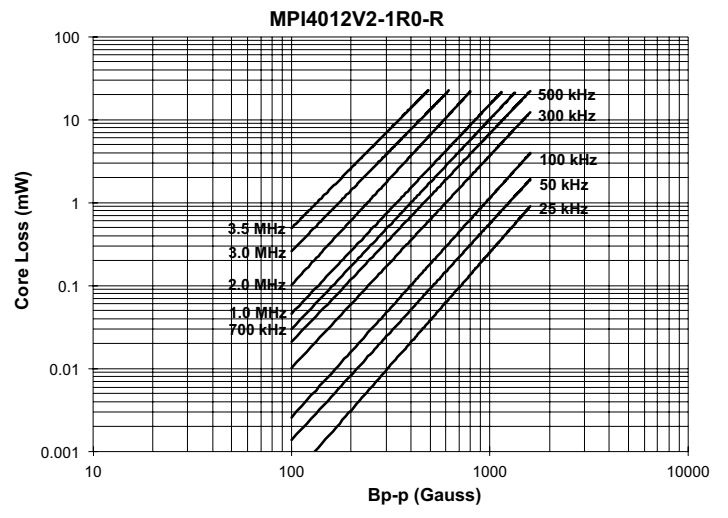
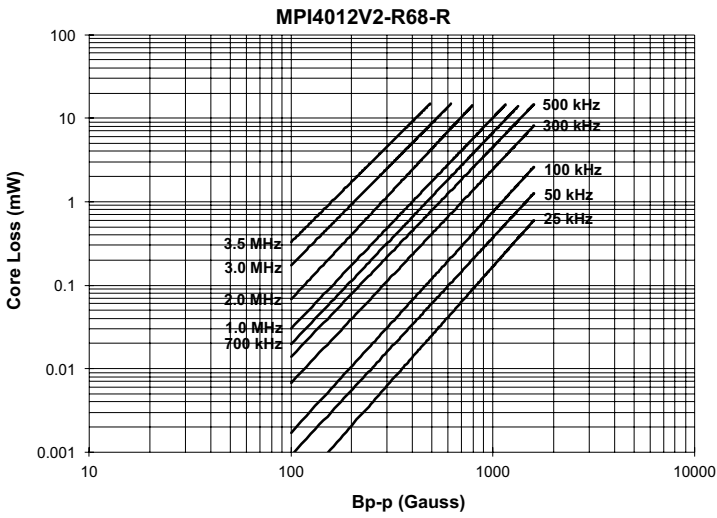
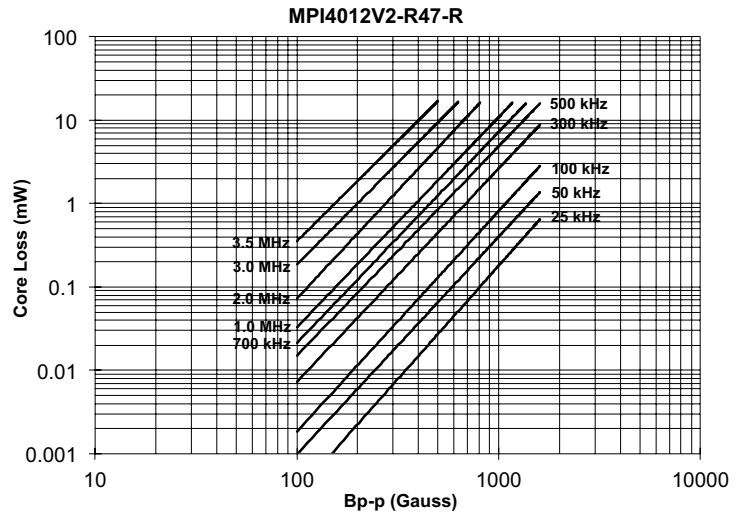
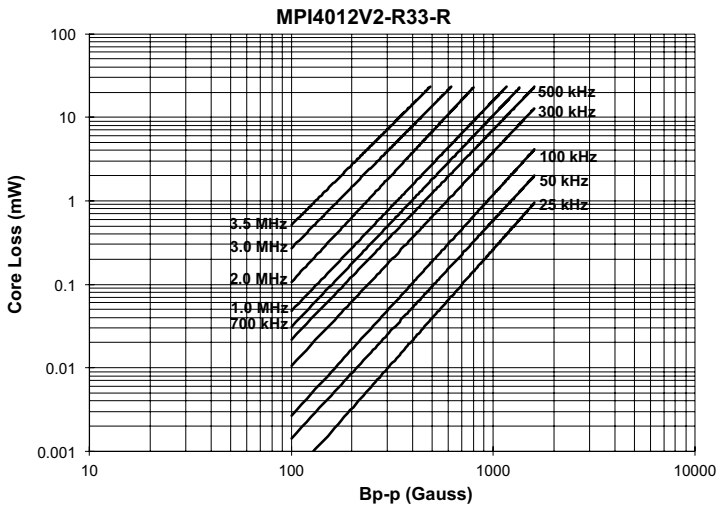

Core loss vs Bp-p

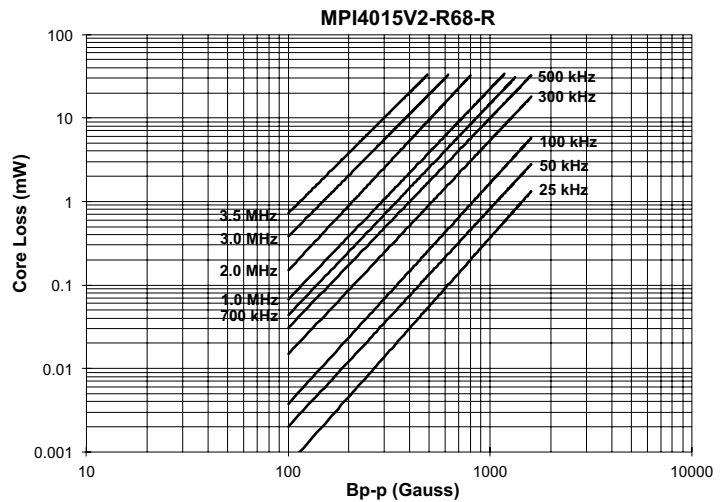
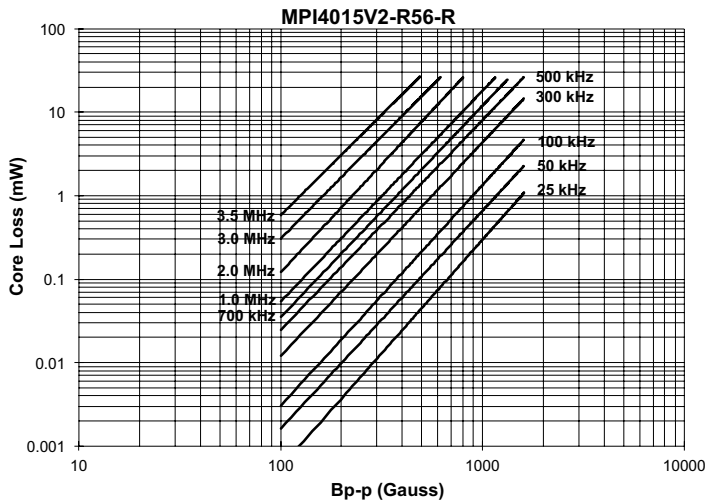
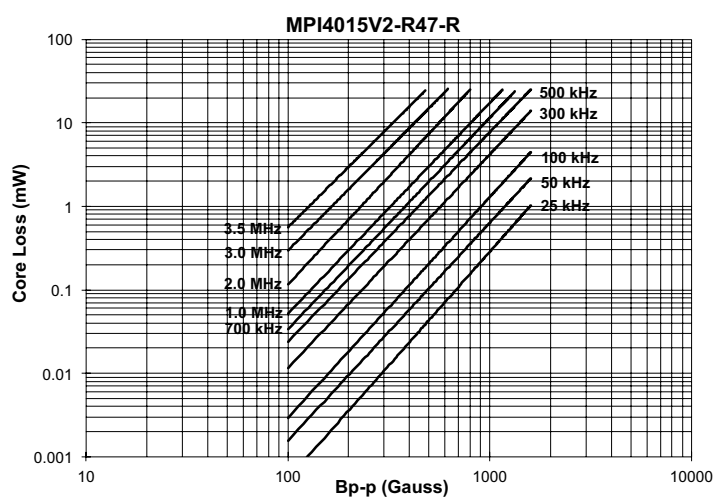
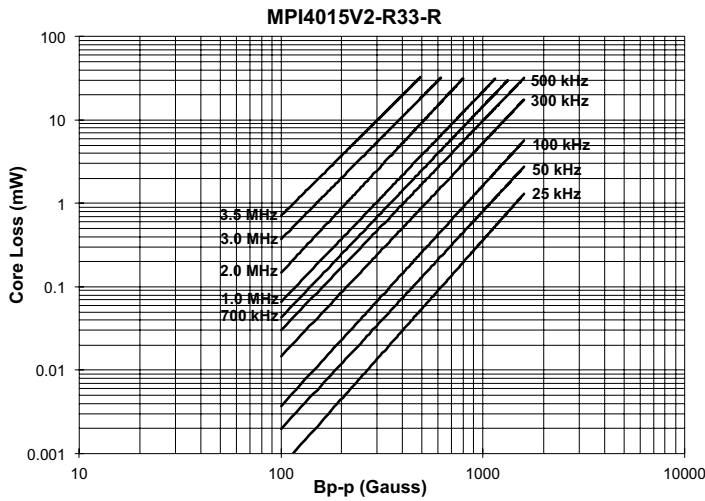
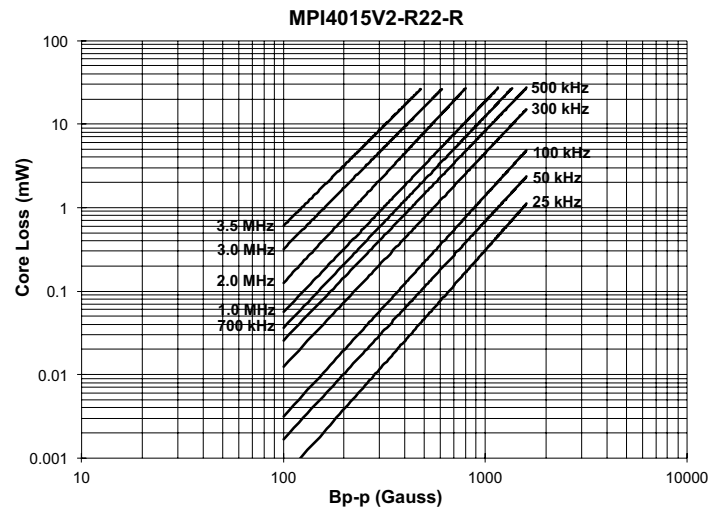
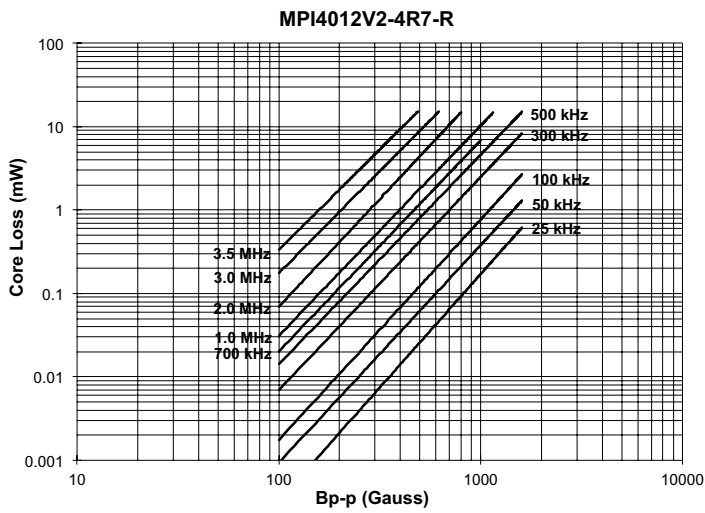

Core loss vs Bp-p

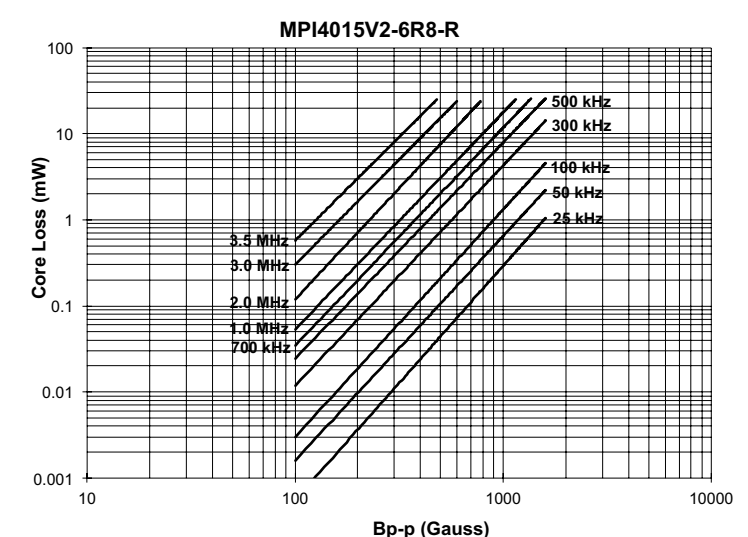
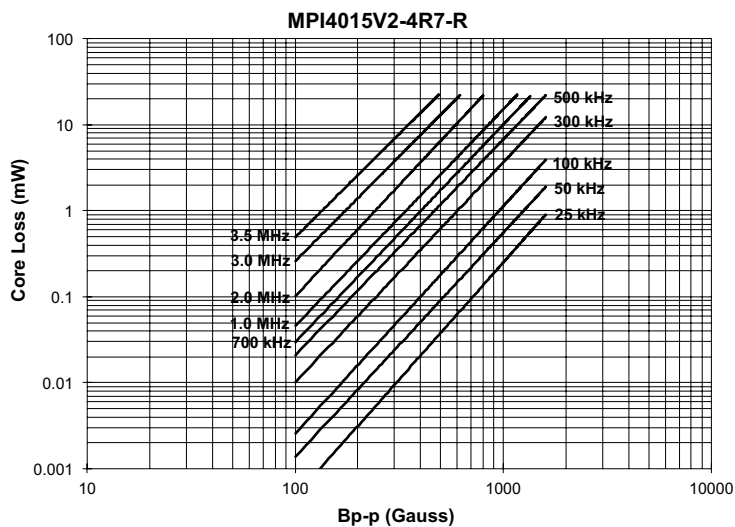
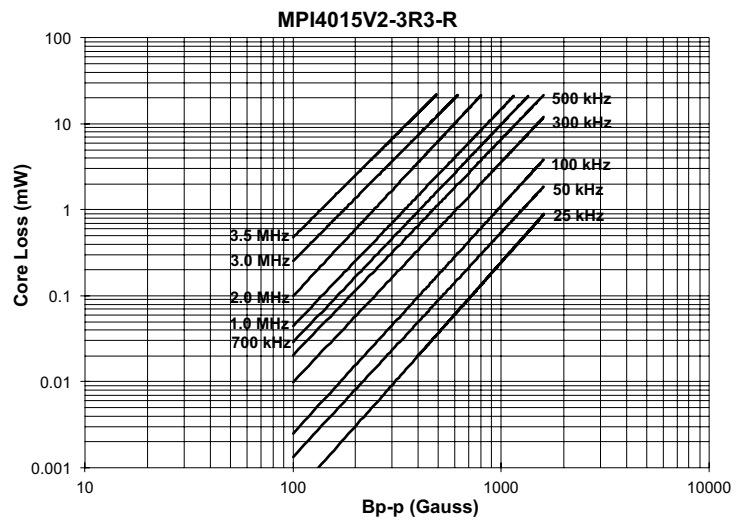
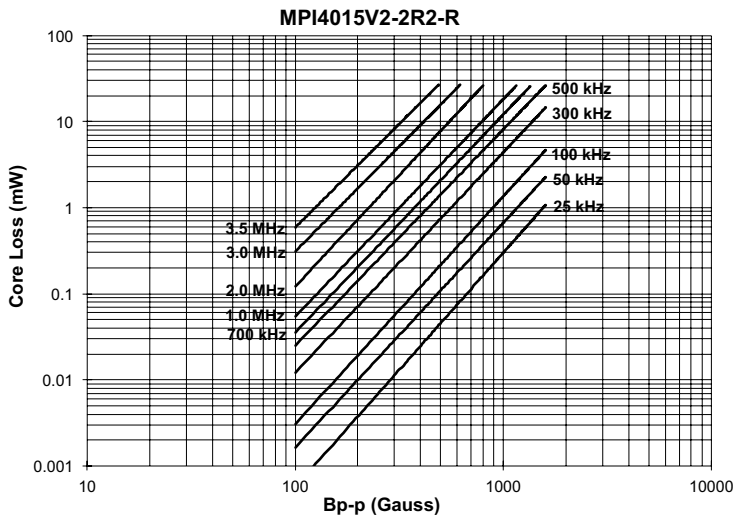
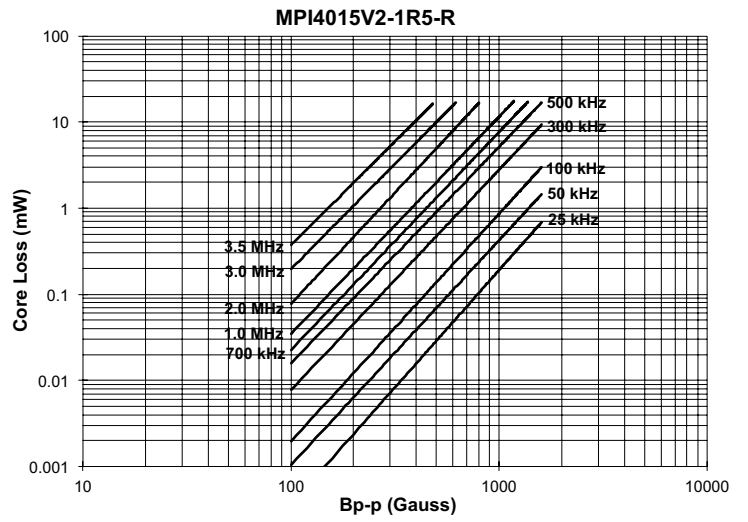
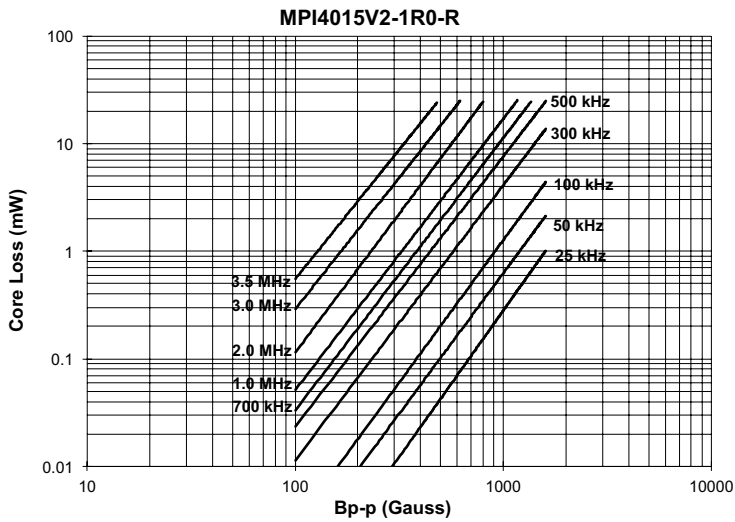

Core loss vs Bp-p

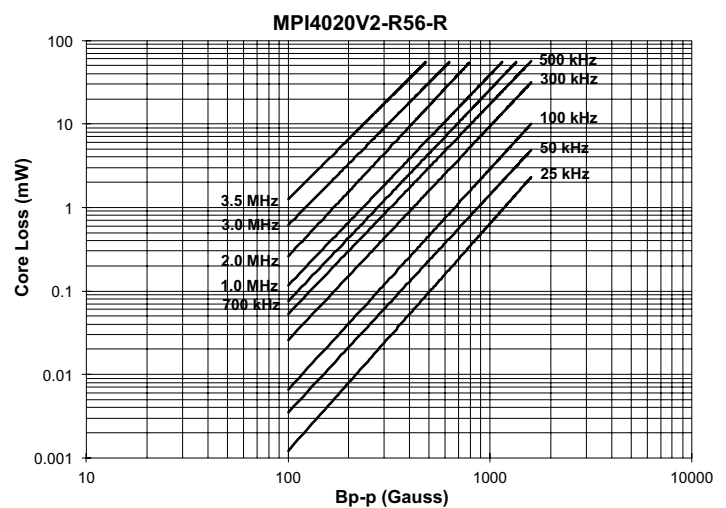
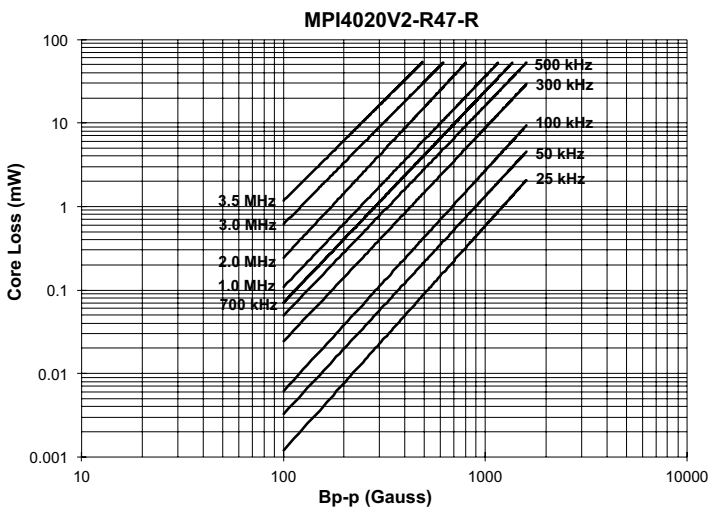
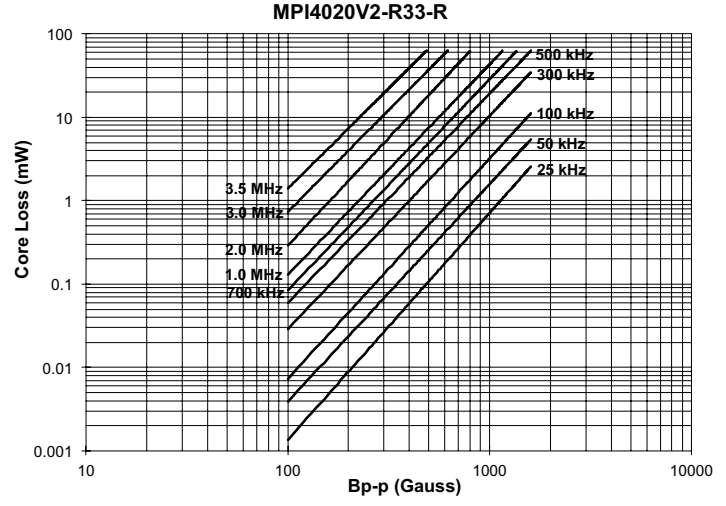
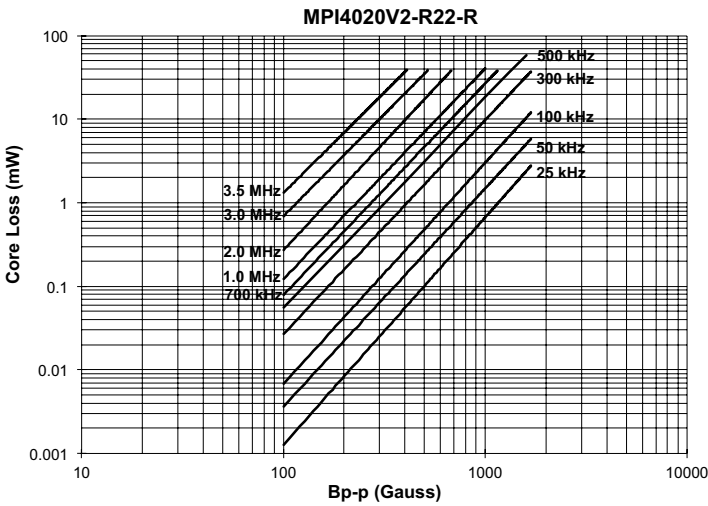
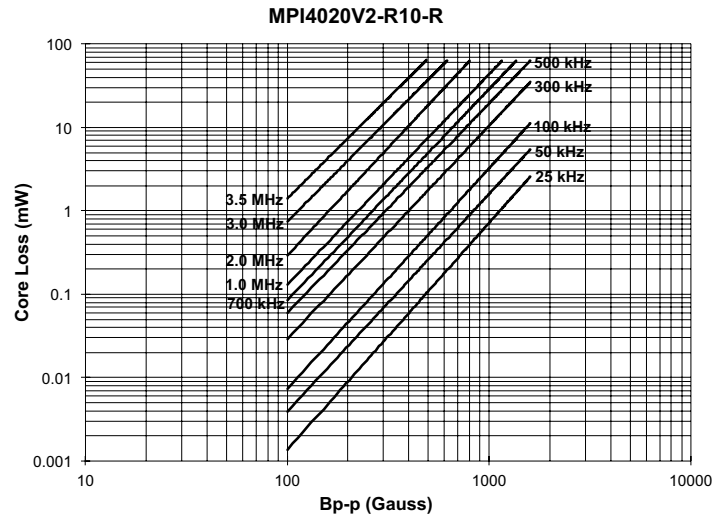
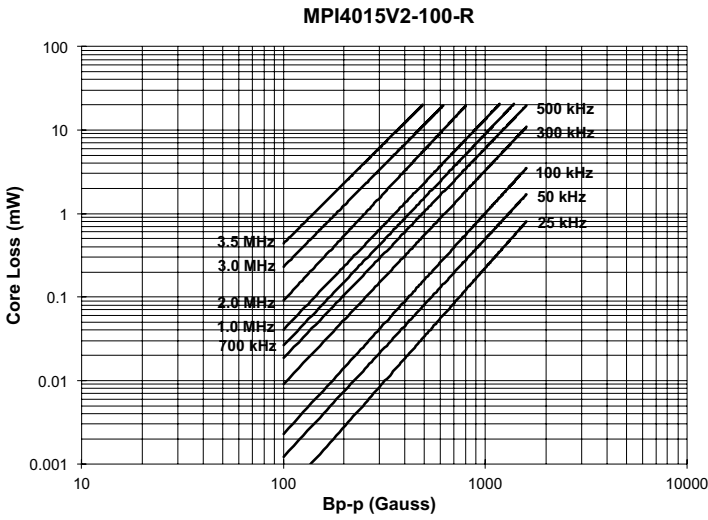

Core loss vs Bp-p

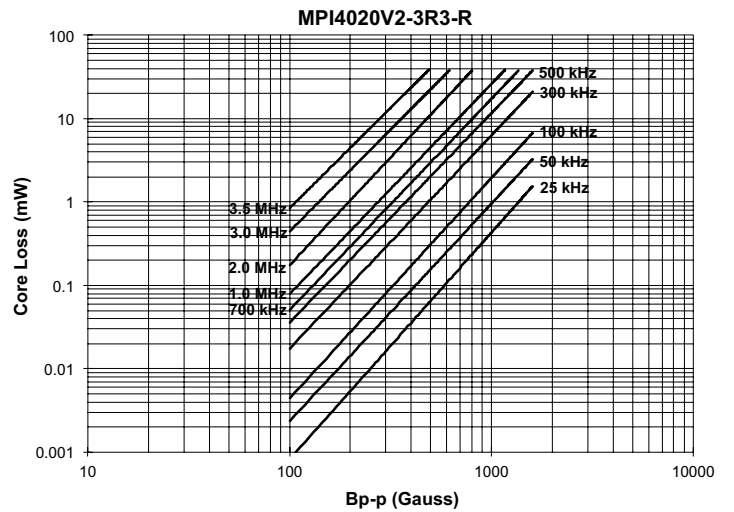
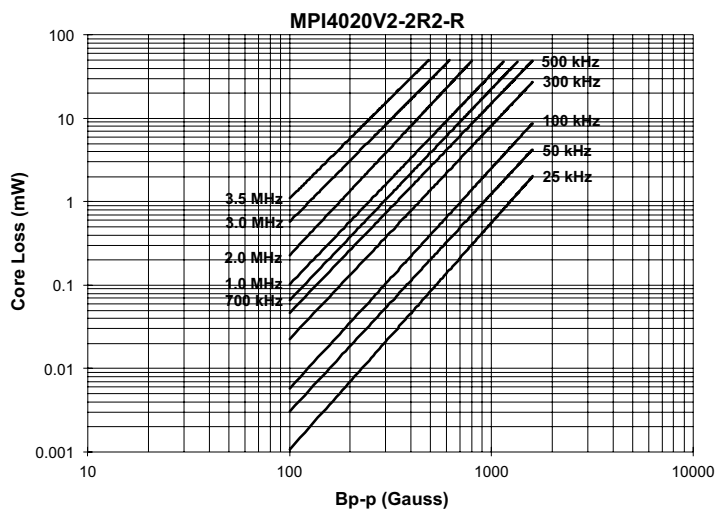
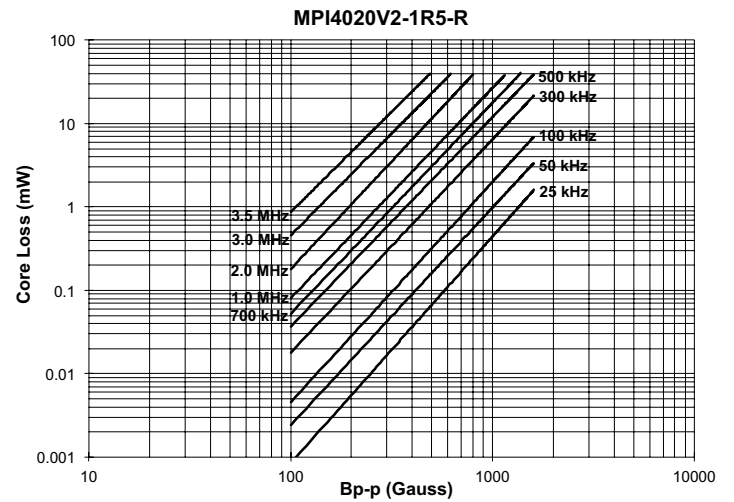
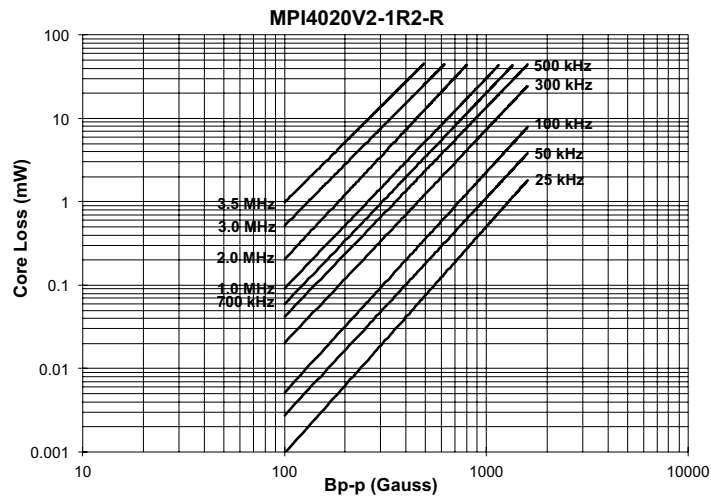
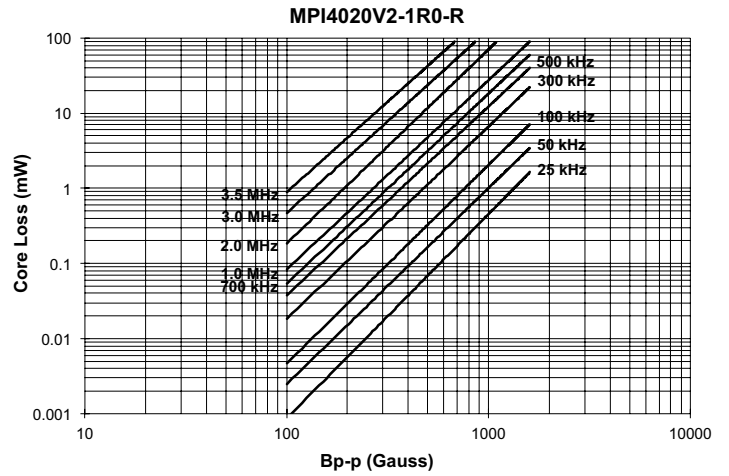
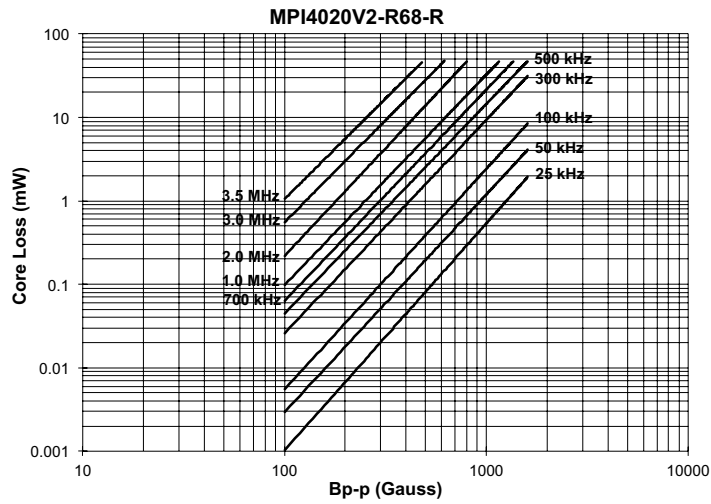



Core loss vs Bp-p

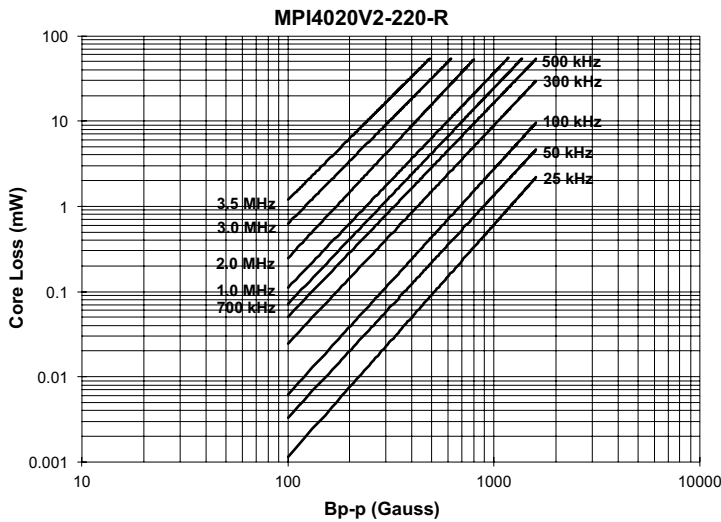
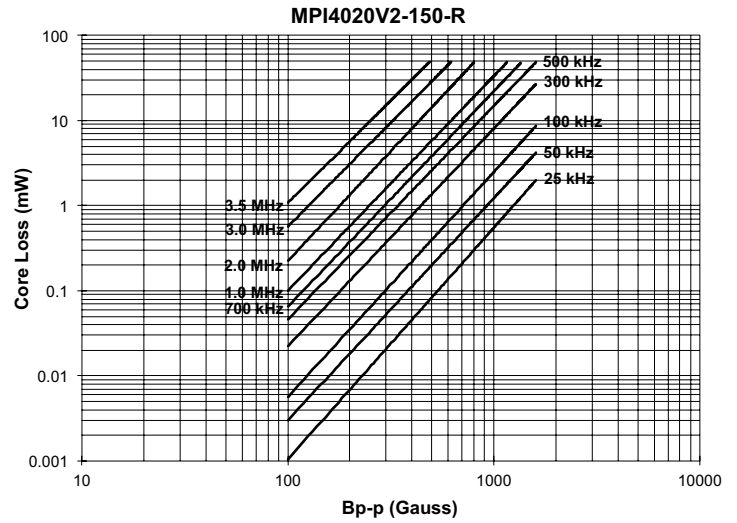
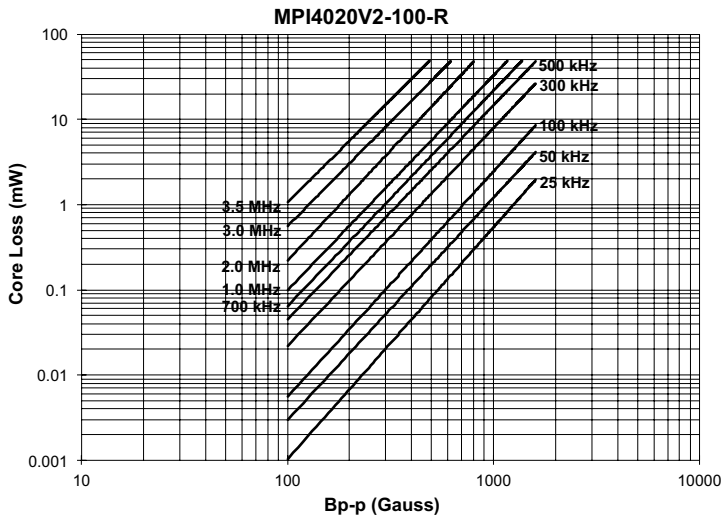
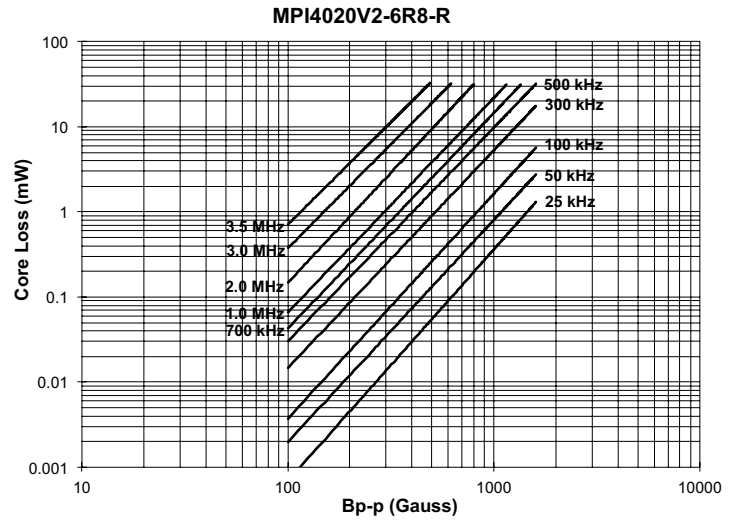
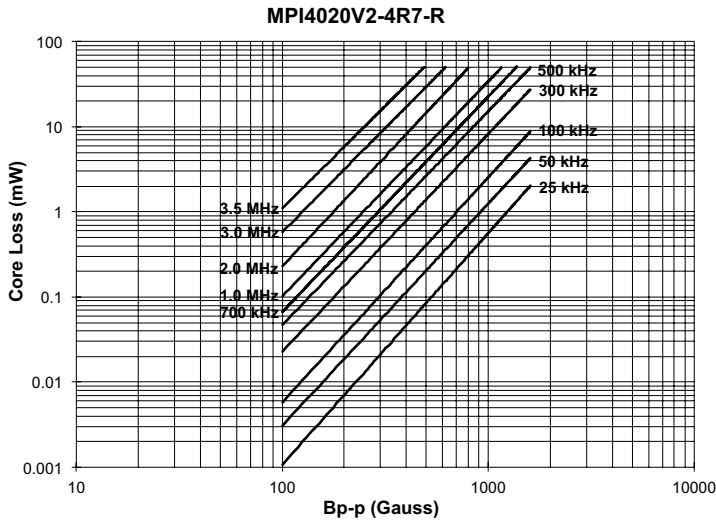

Inductance vs. Frequency

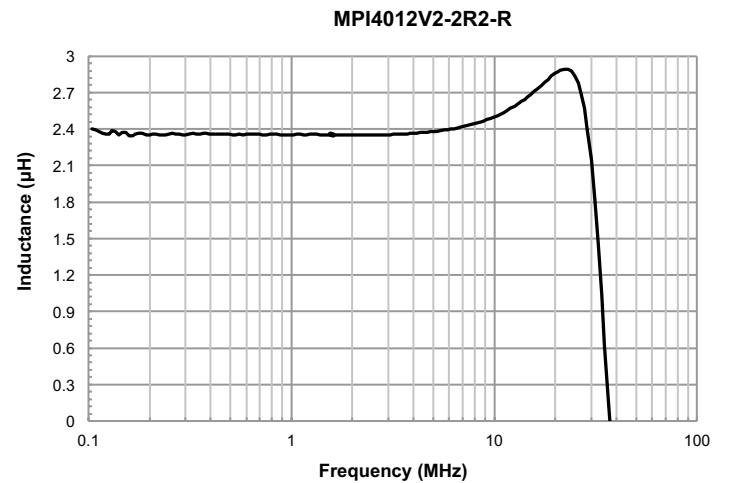
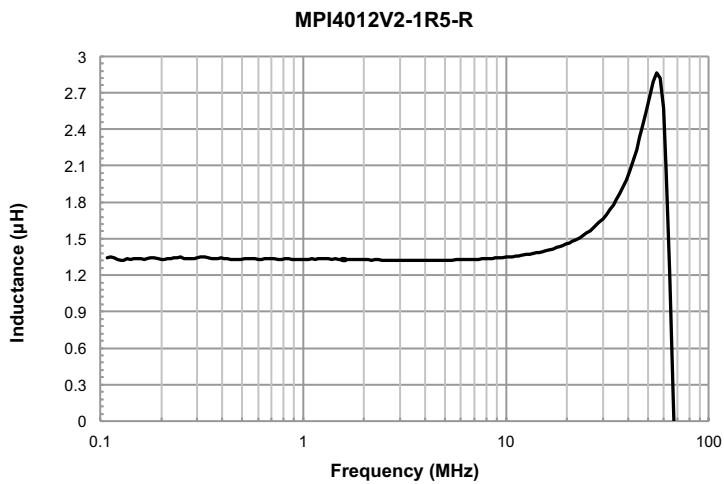
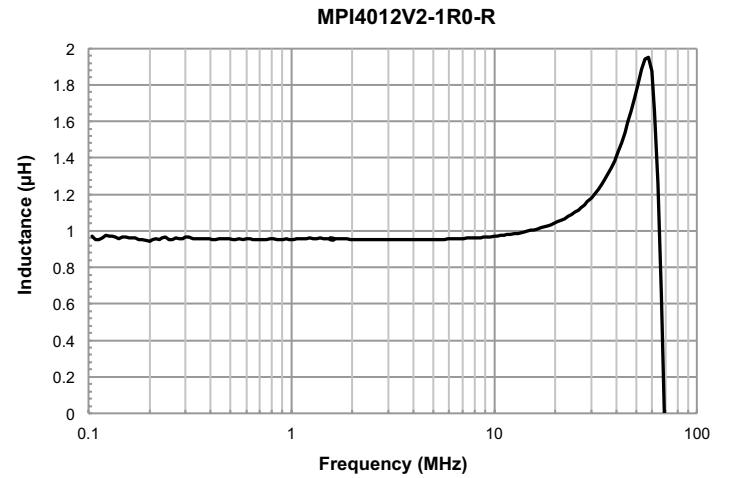
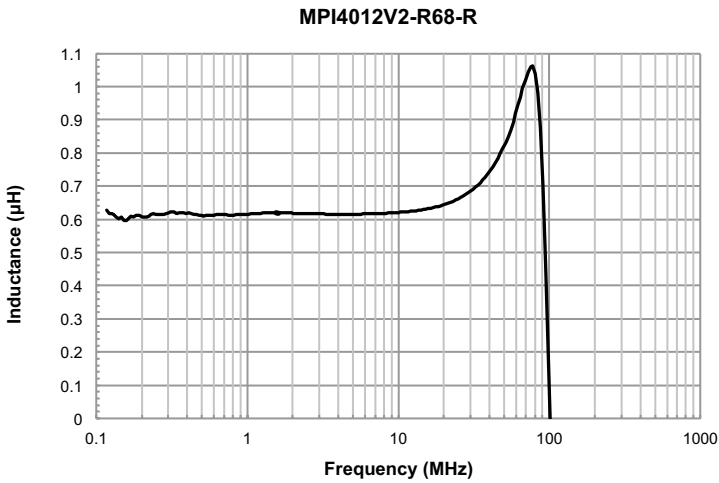
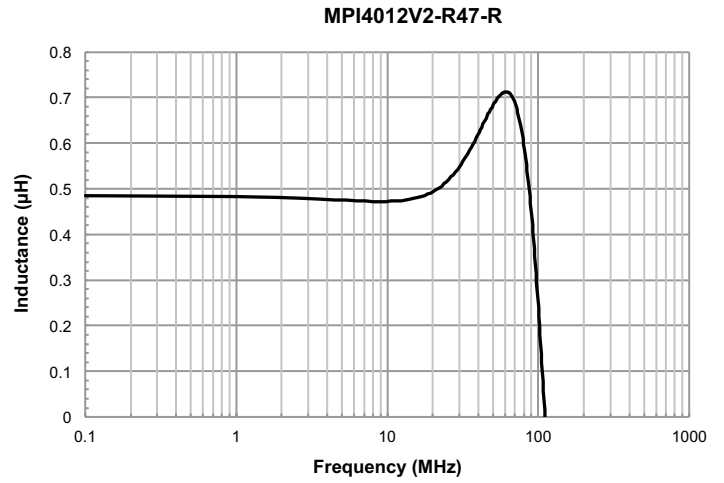
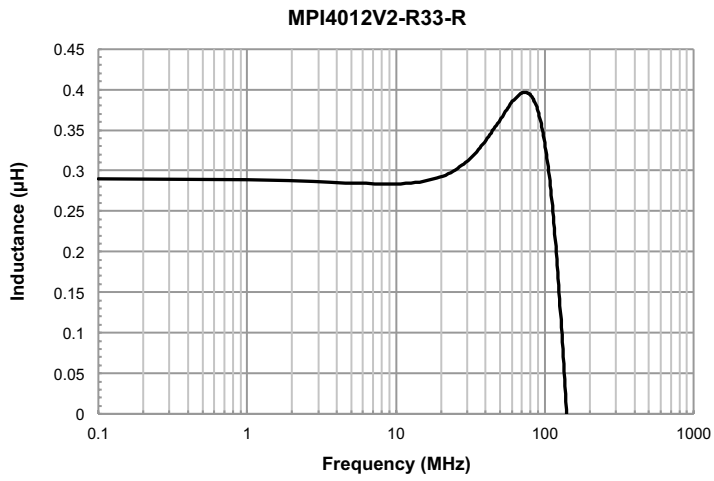

Inductance vs. Frequency

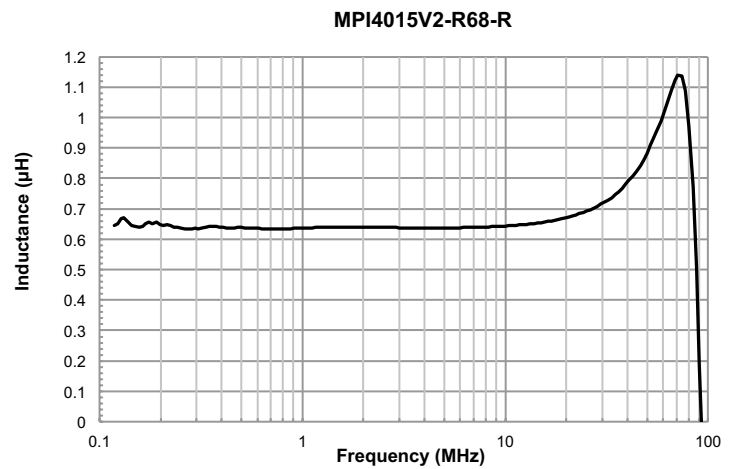
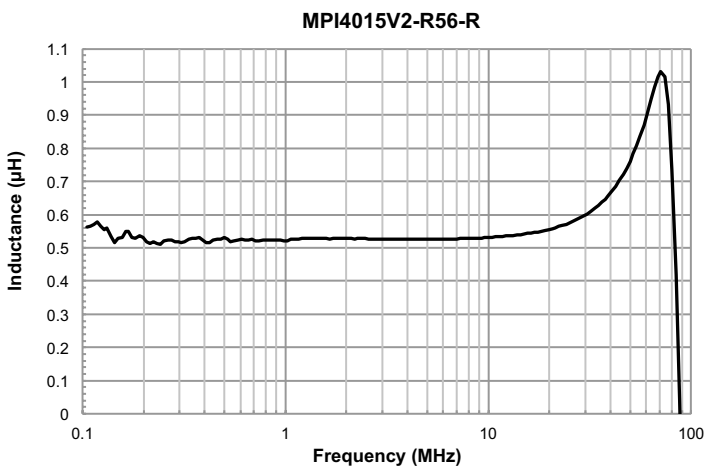
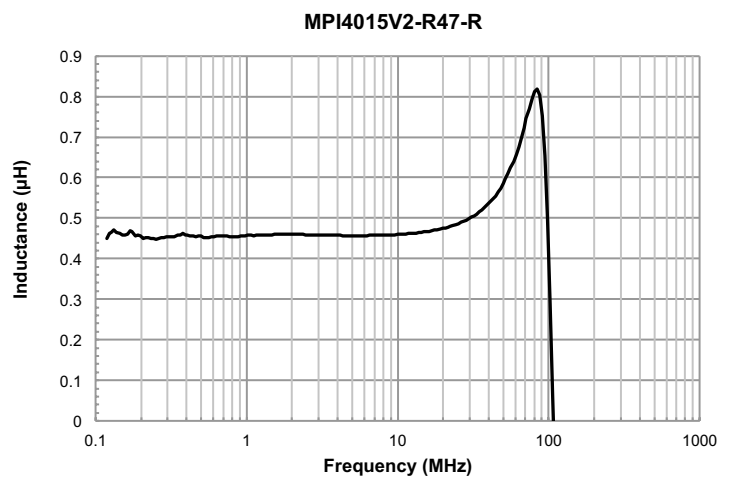
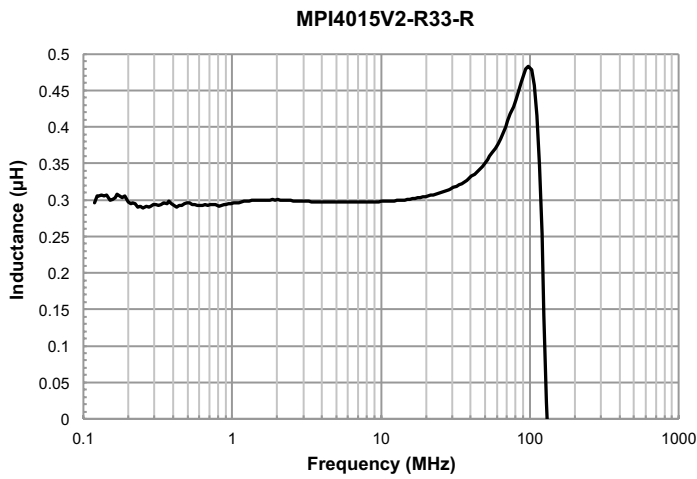
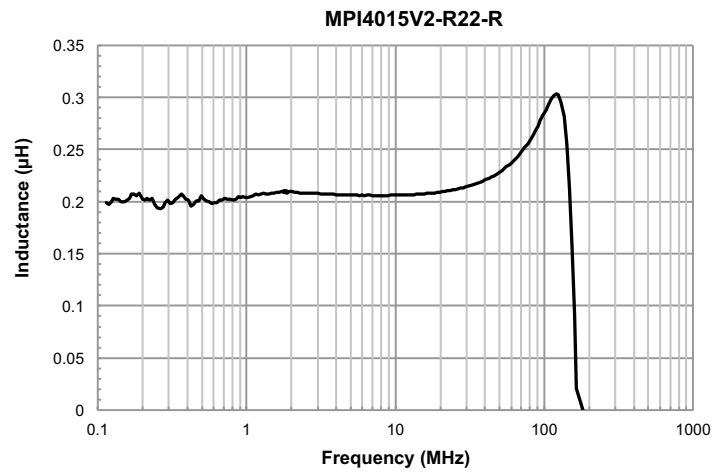
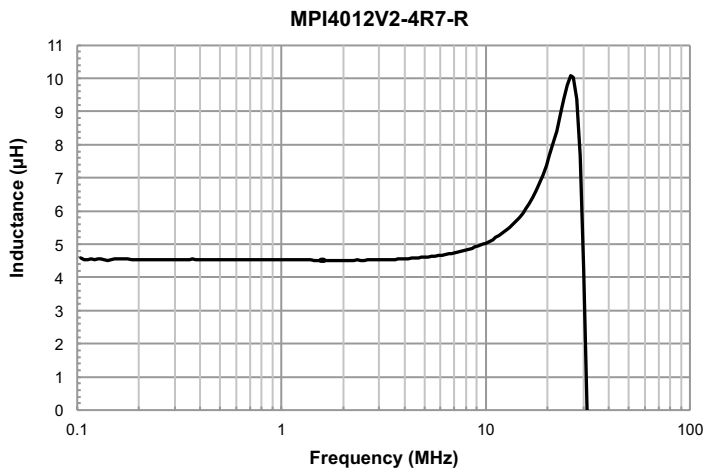

Inductance vs. Frequency

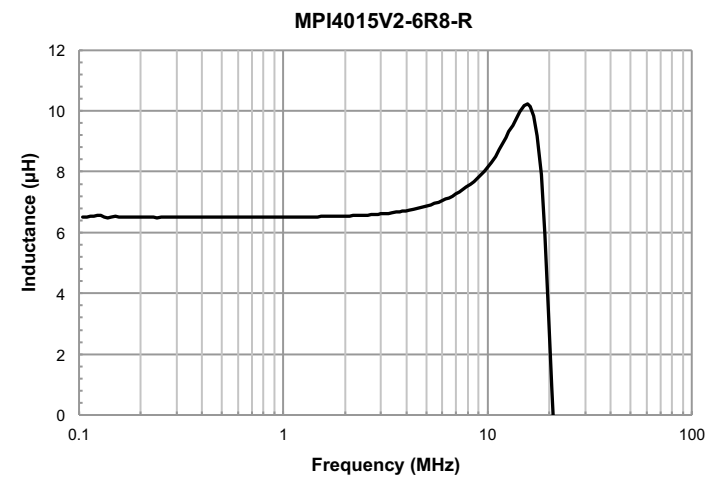
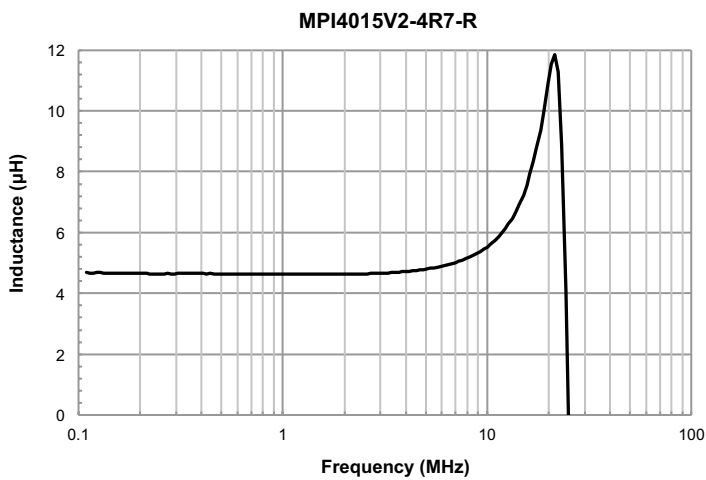
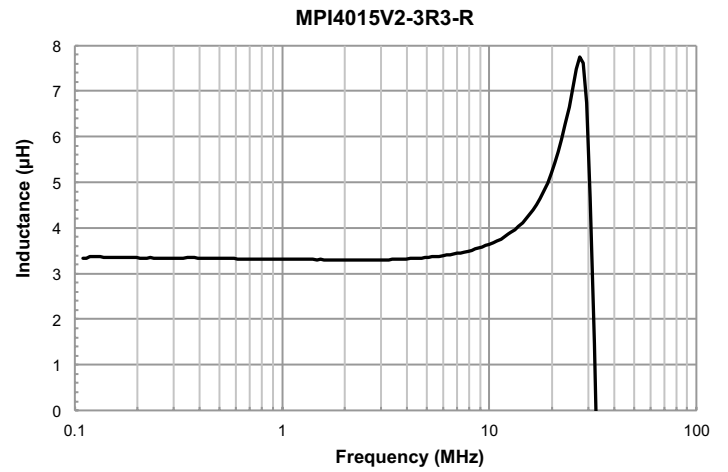
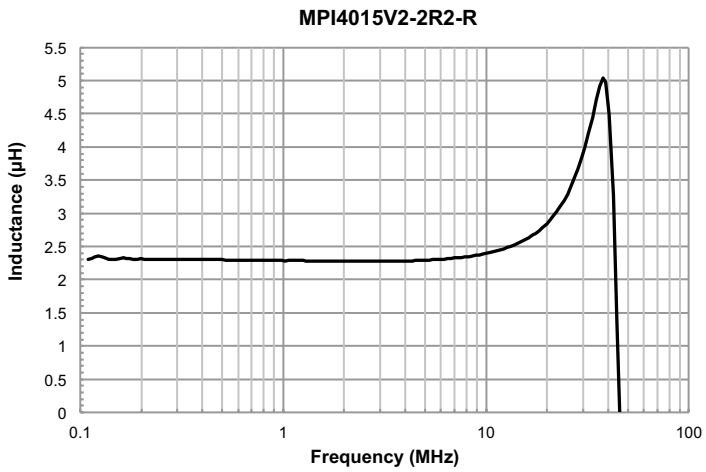
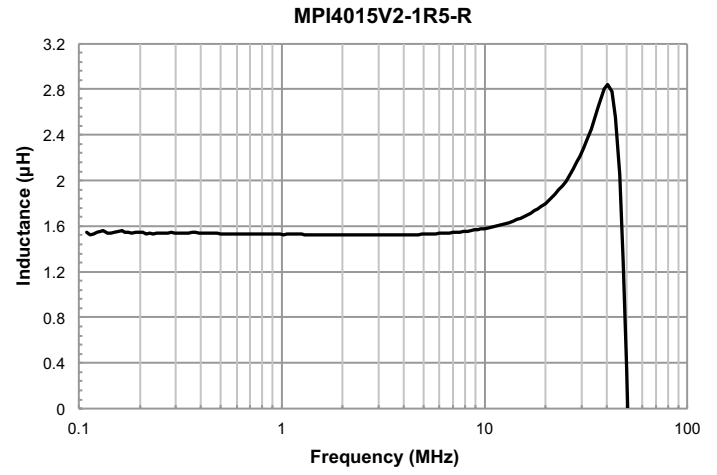
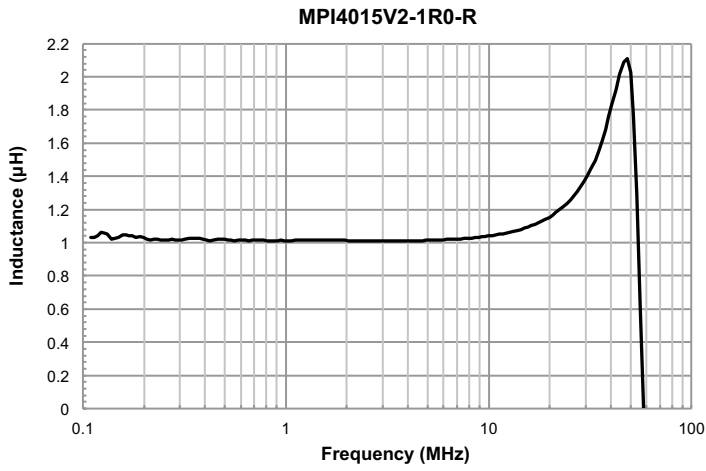

Inductance vs. Frequency

MPI4015V2-100-R

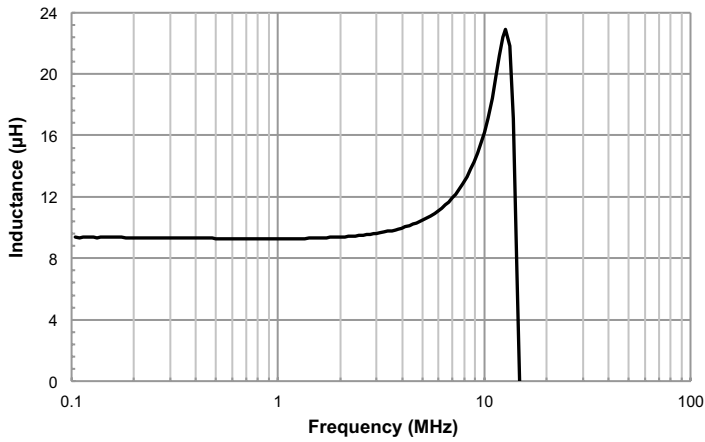

MPI4020V2-R10-R

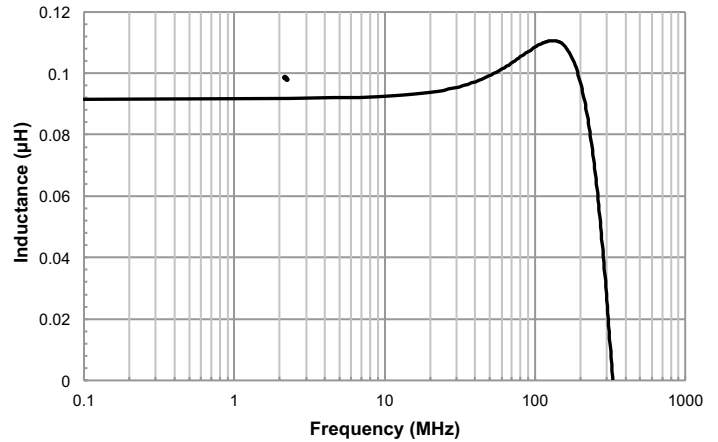

MPI4020V2-R22-R

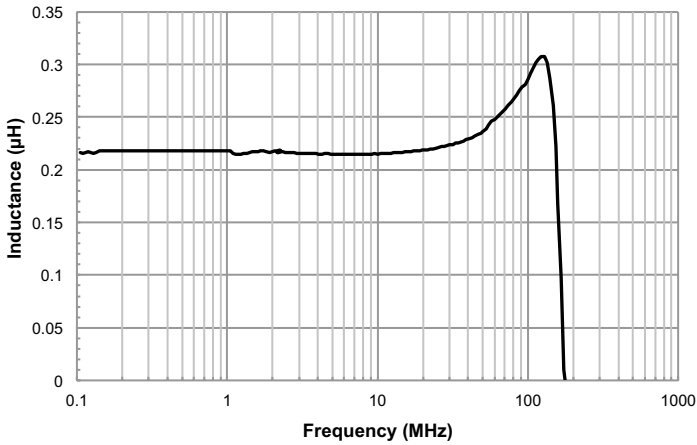

MPI4020V2-R33-R

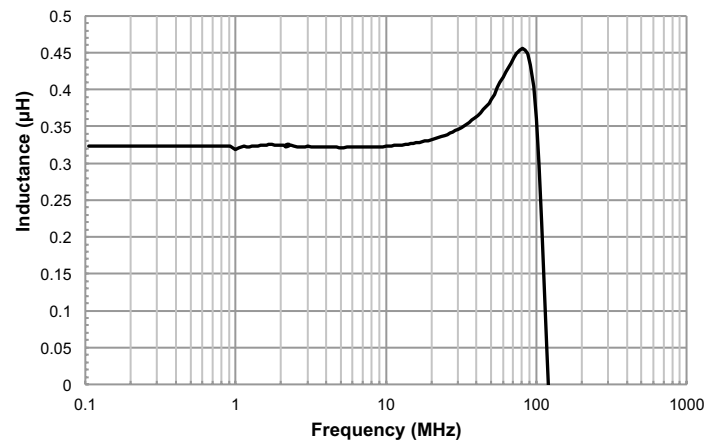

MPI4020V2-R47-R

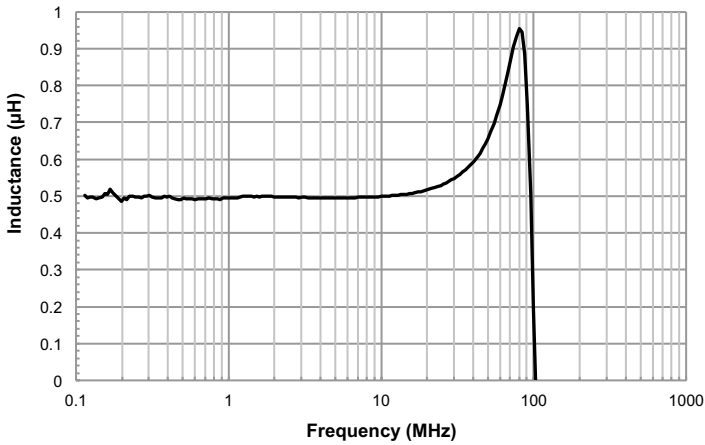

MPI4020V2-R56-R

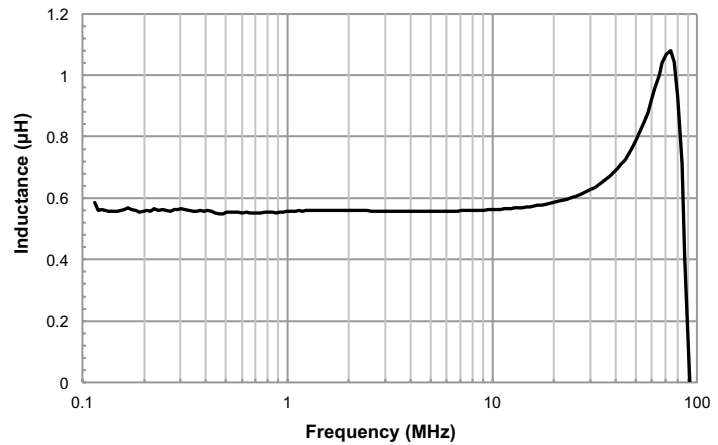

Inductance vs. Frequency

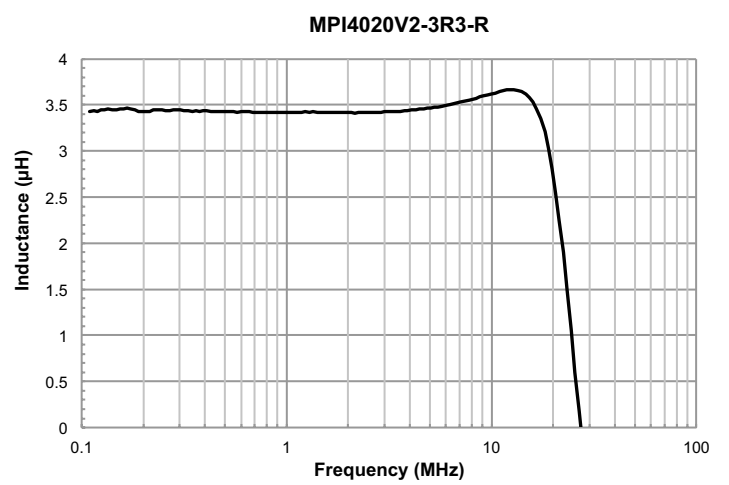
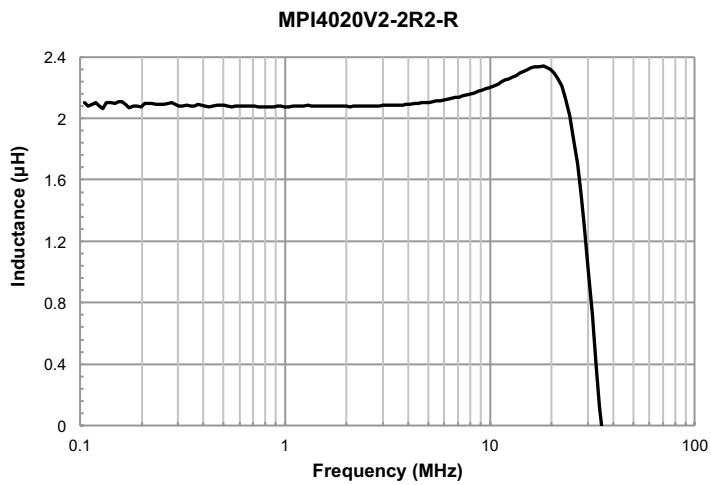
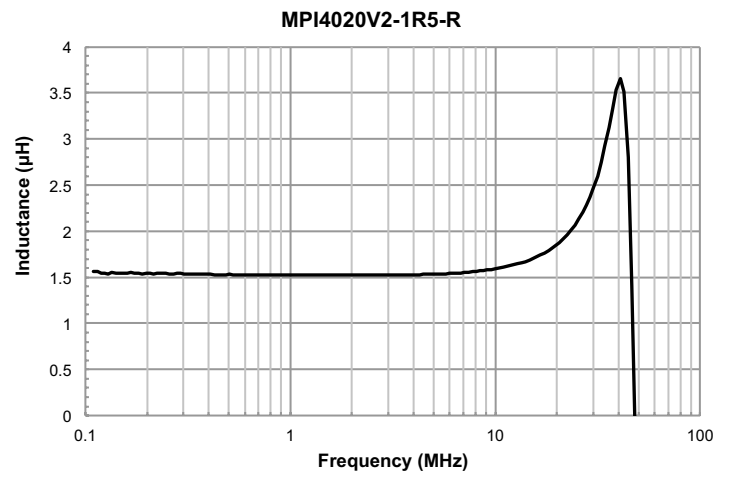
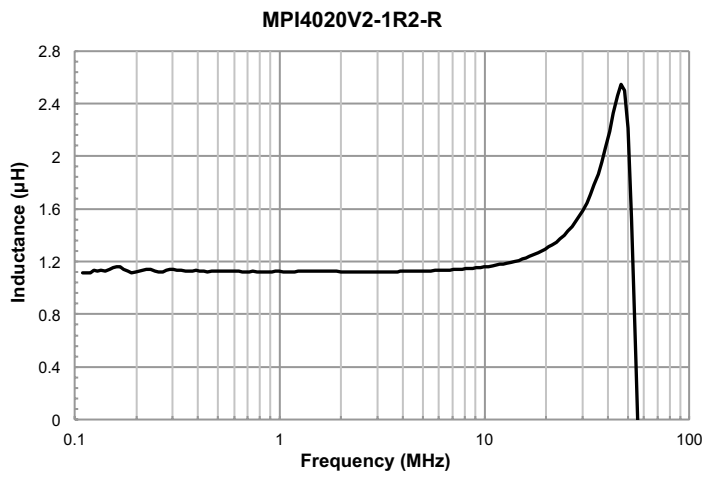
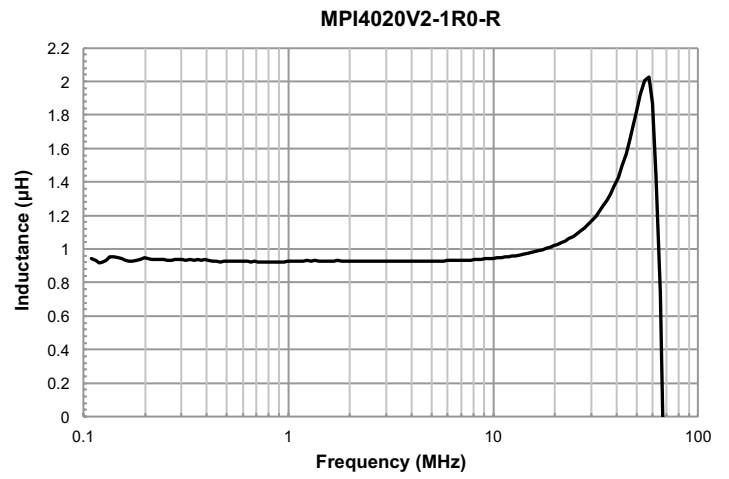
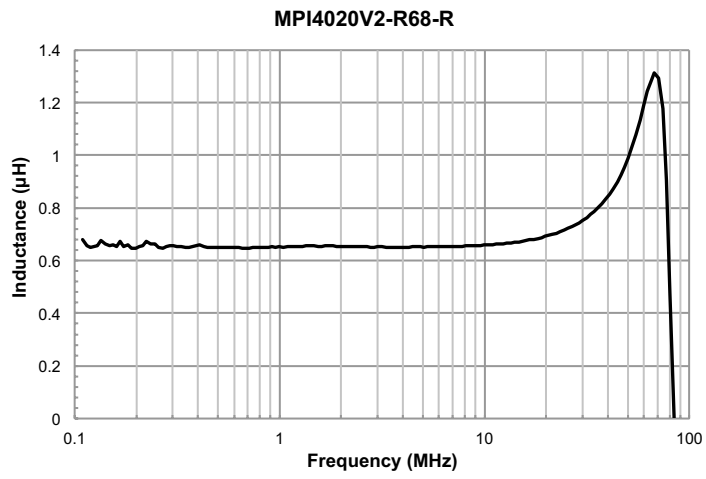

Inductance vs. Frequency

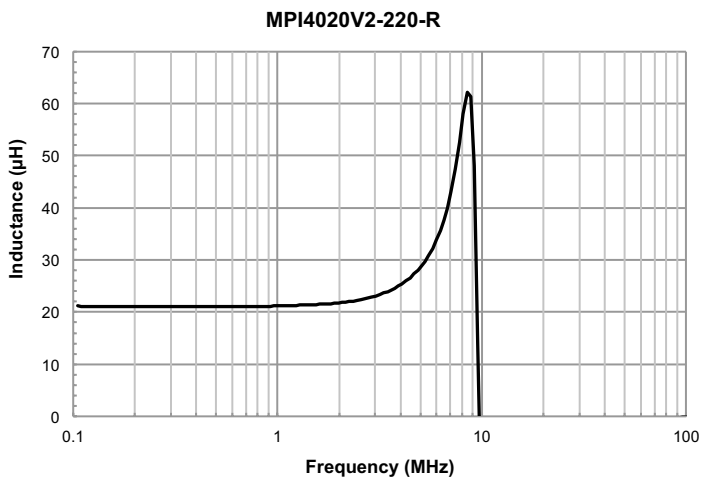
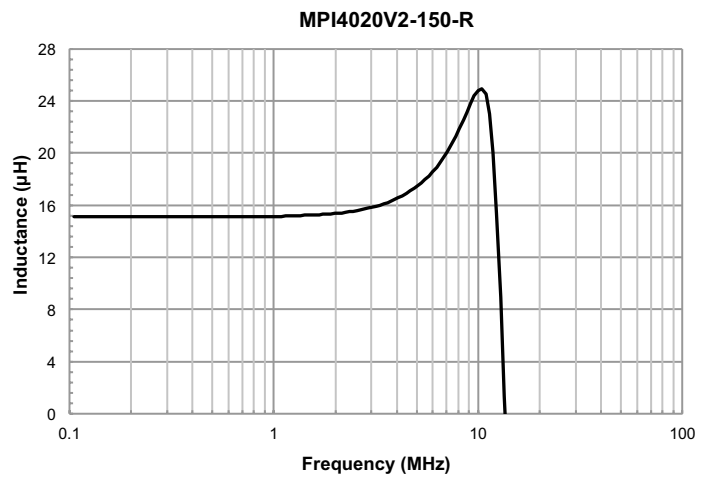
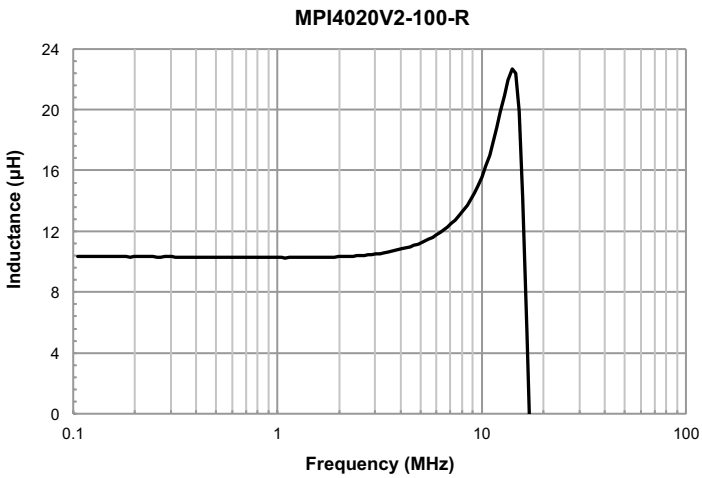
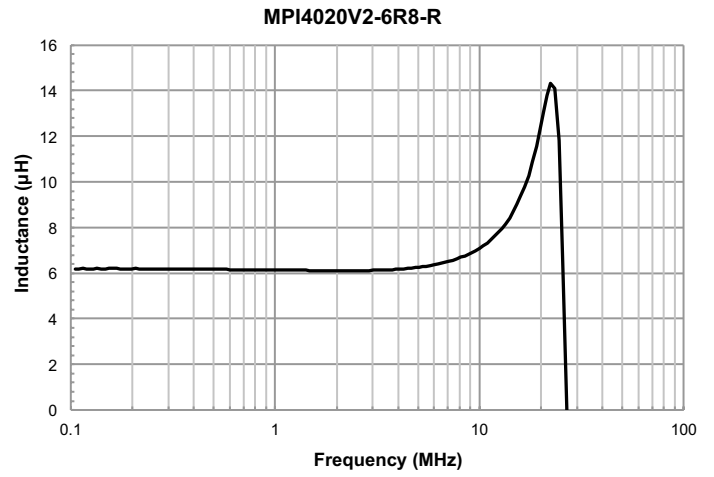
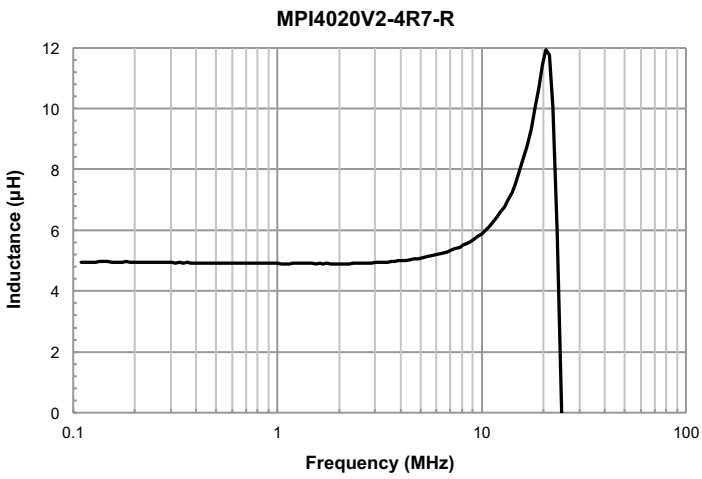

Inductance and temperature rise vs. Current

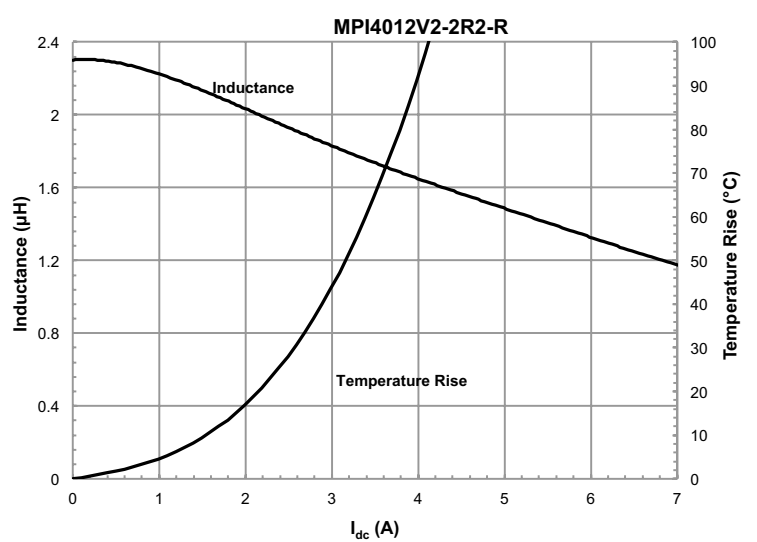
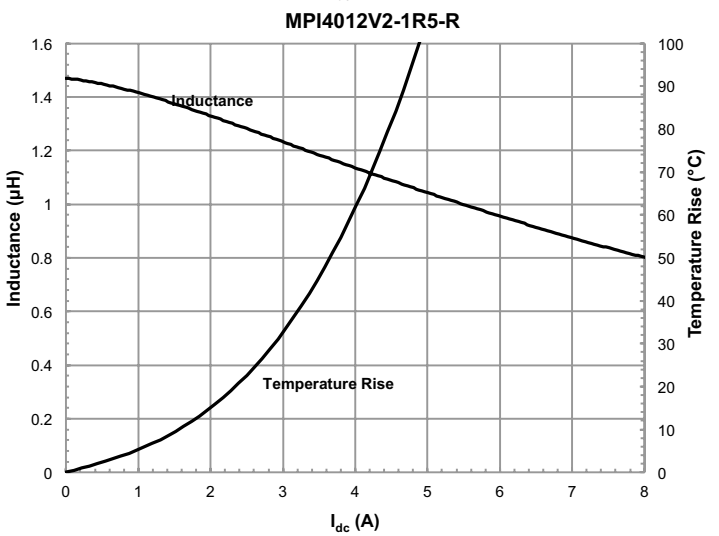
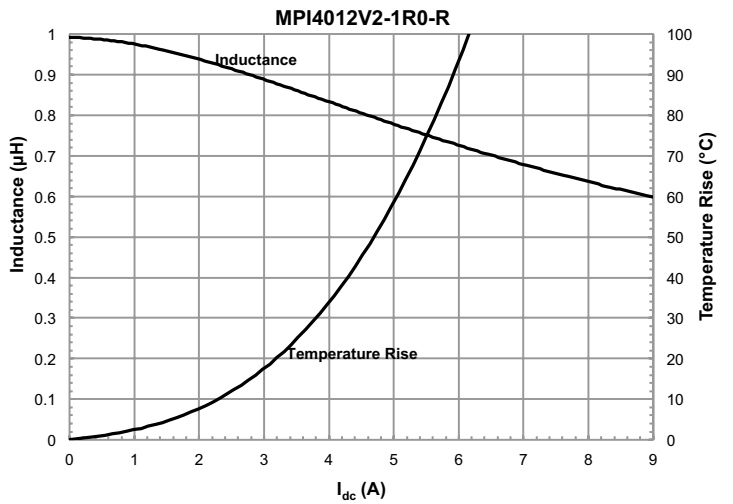
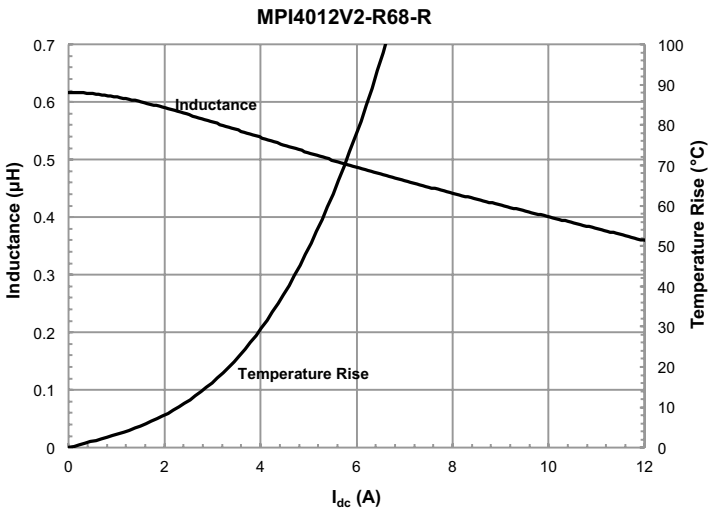
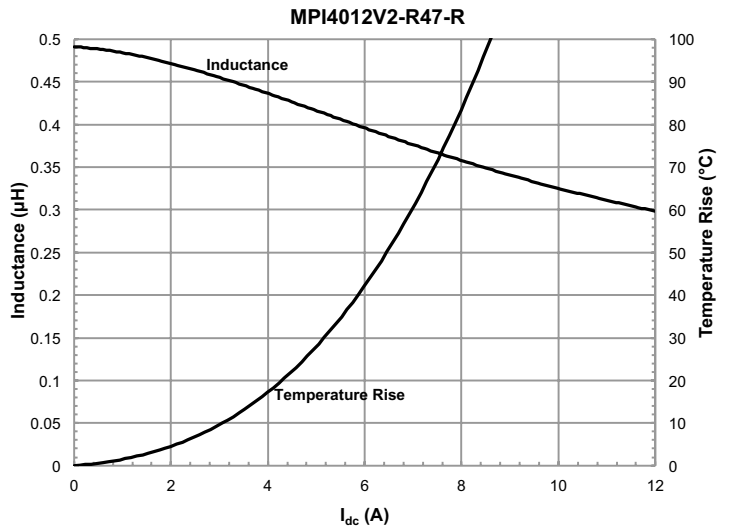
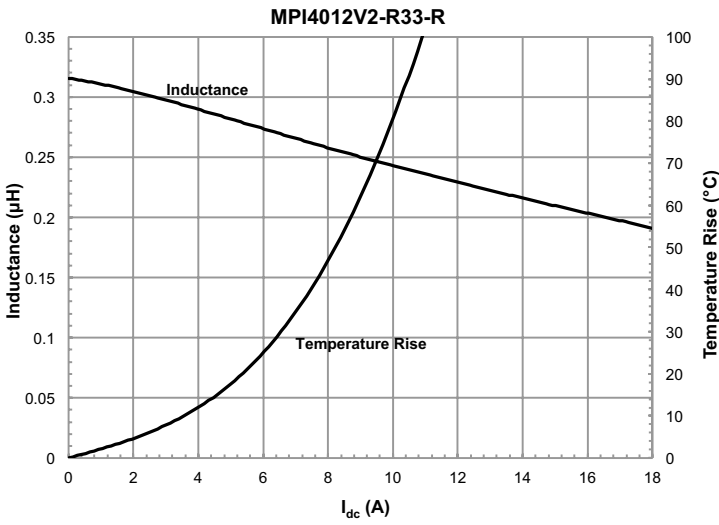



Inductance and temperature rise vs. Current

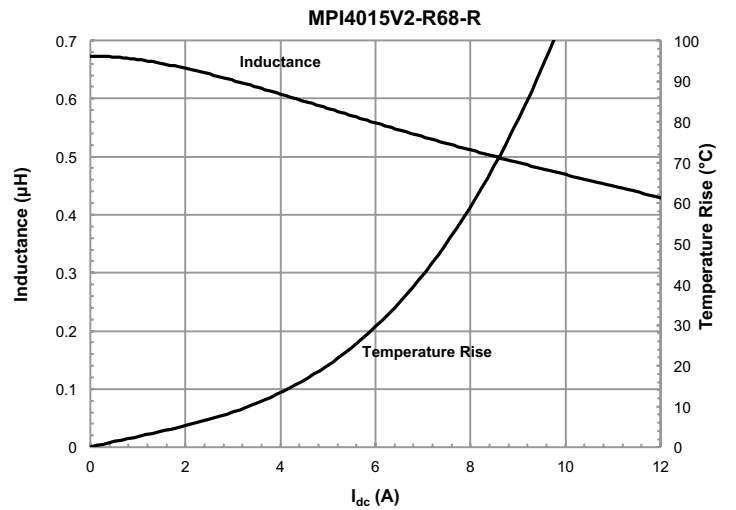
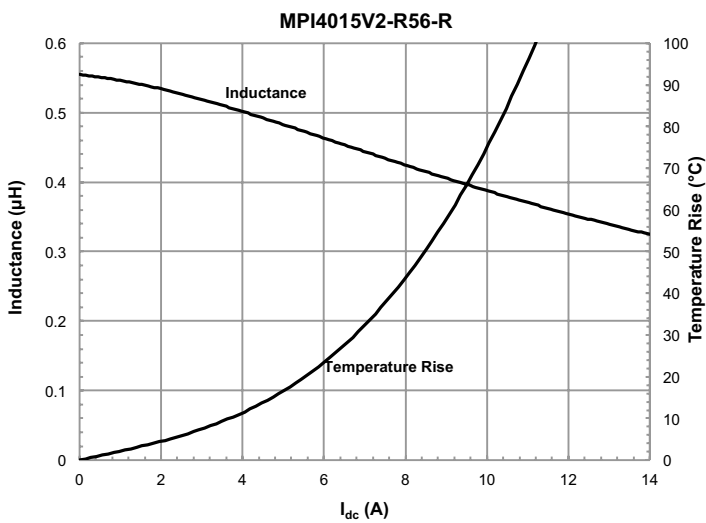
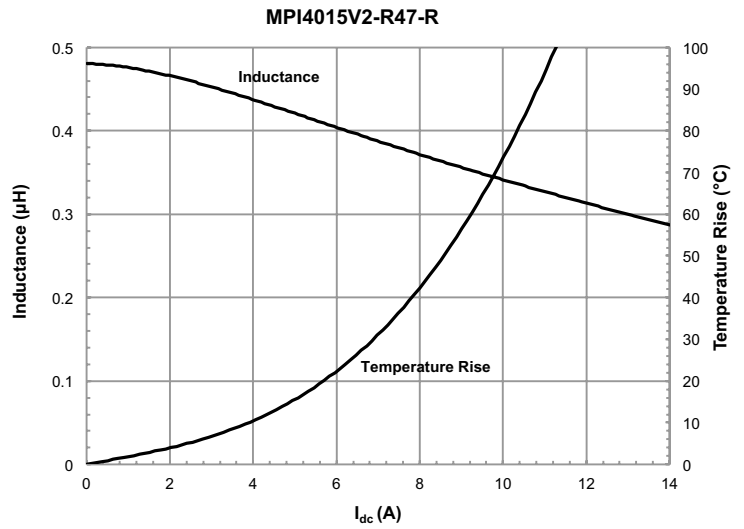
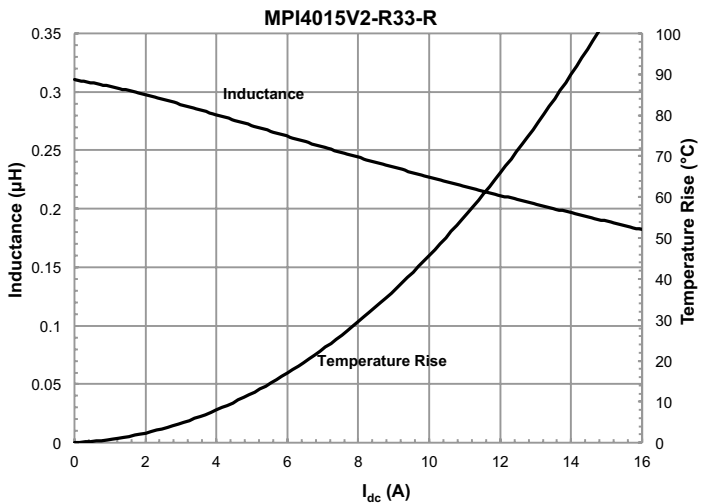
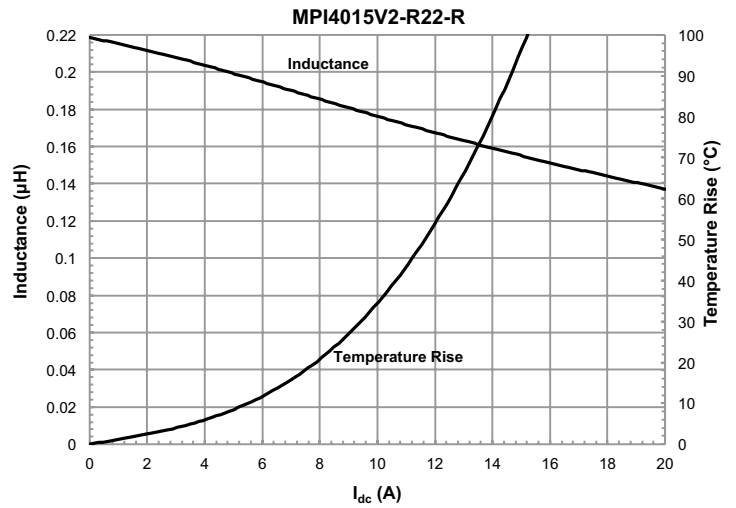
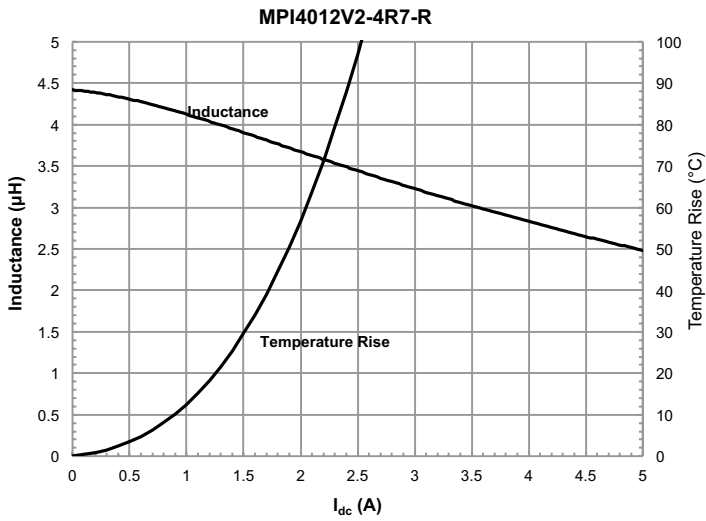

Inductance and temperature rise vs. Current

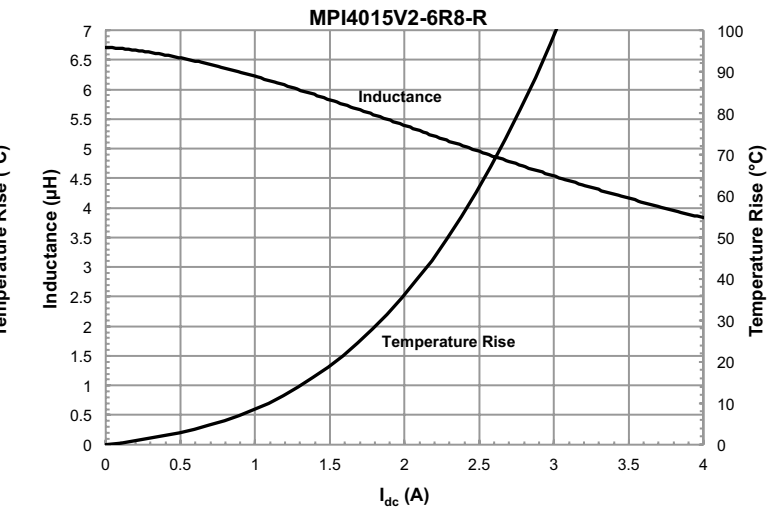
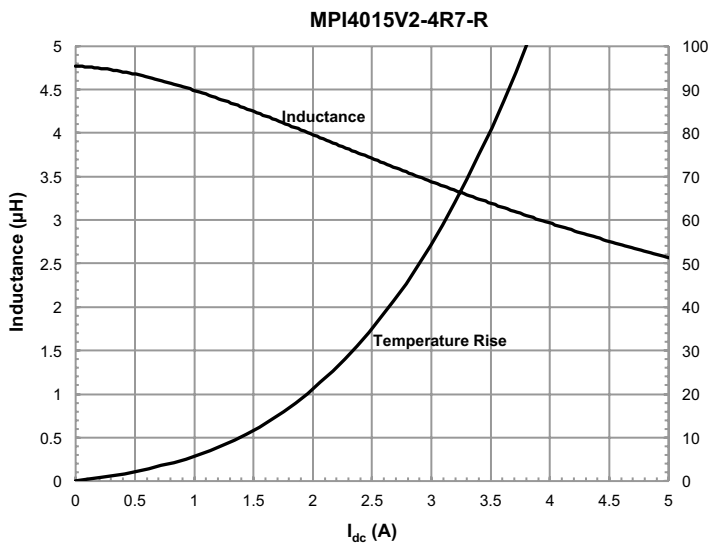
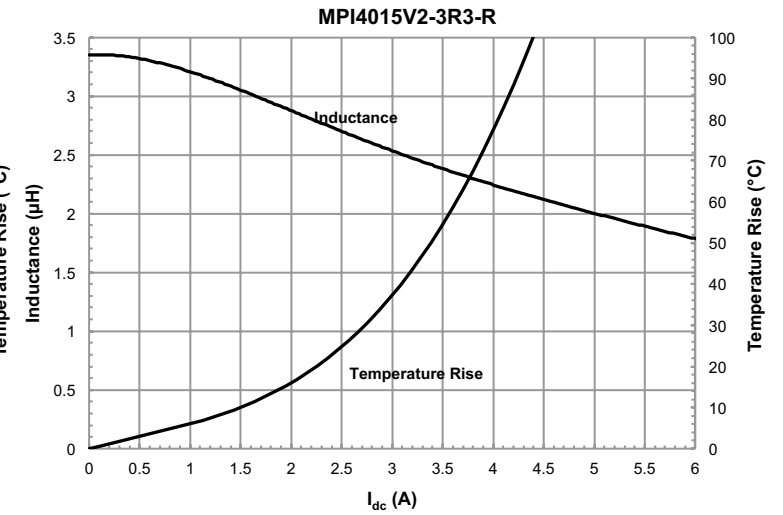
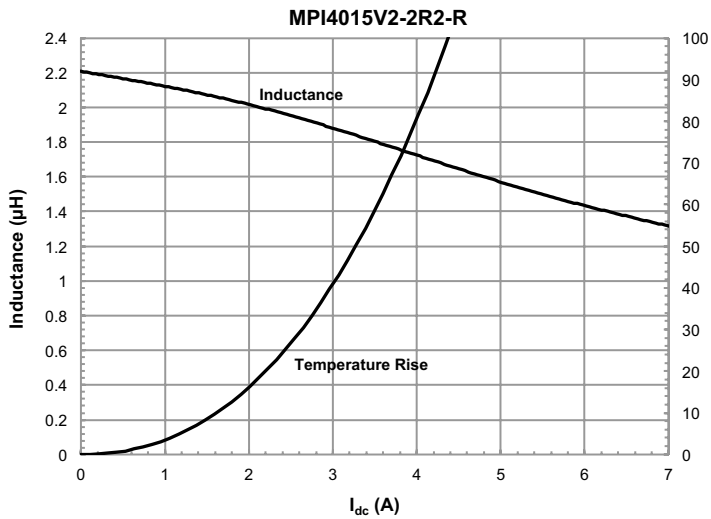
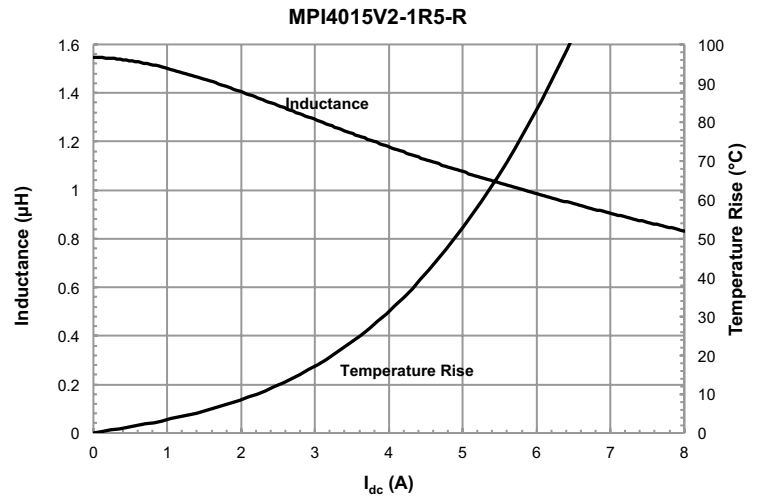
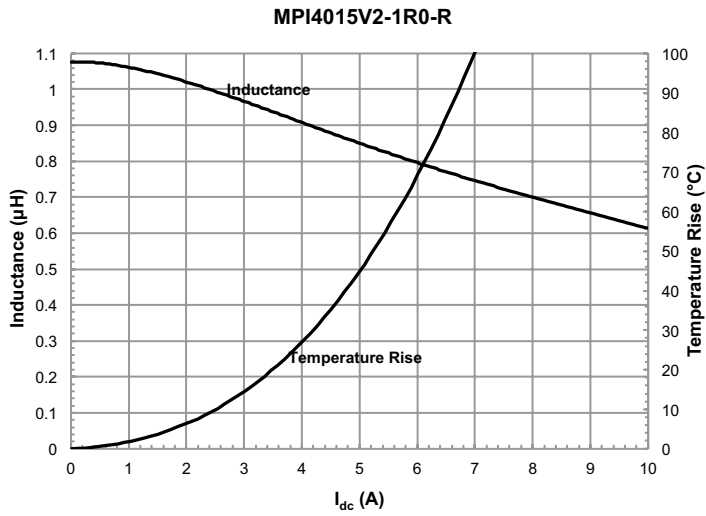

Inductance and temperature rise vs. Current

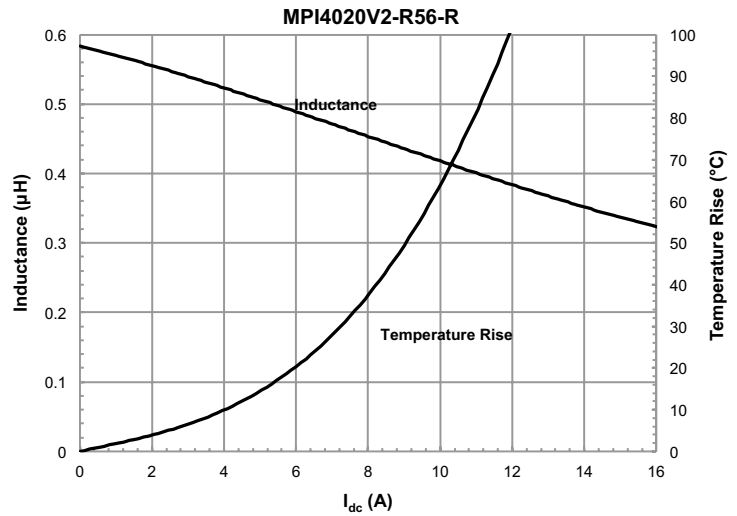
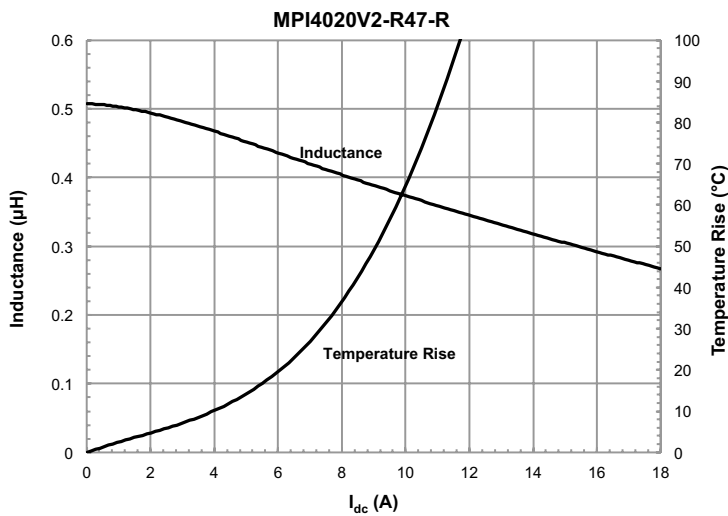
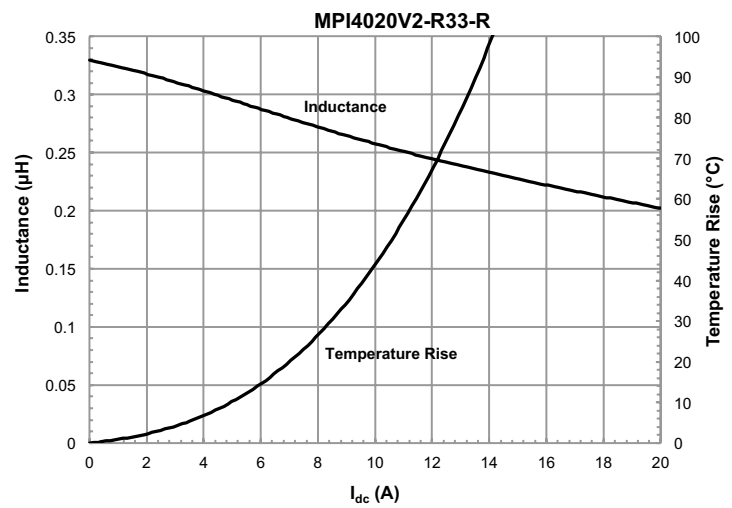
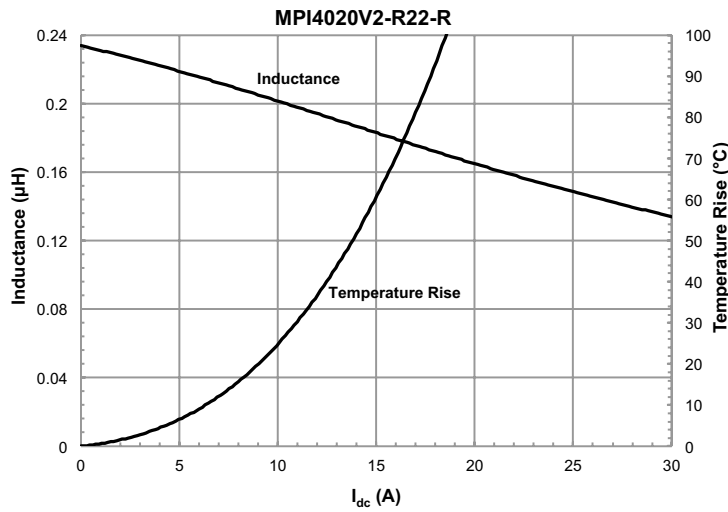
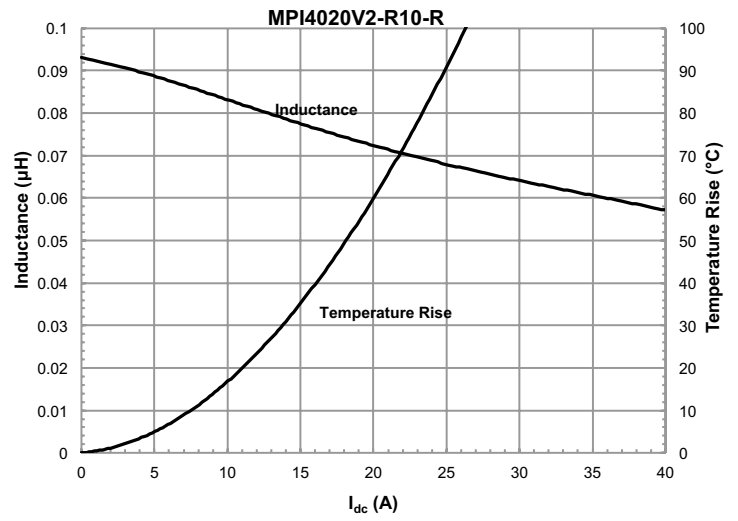
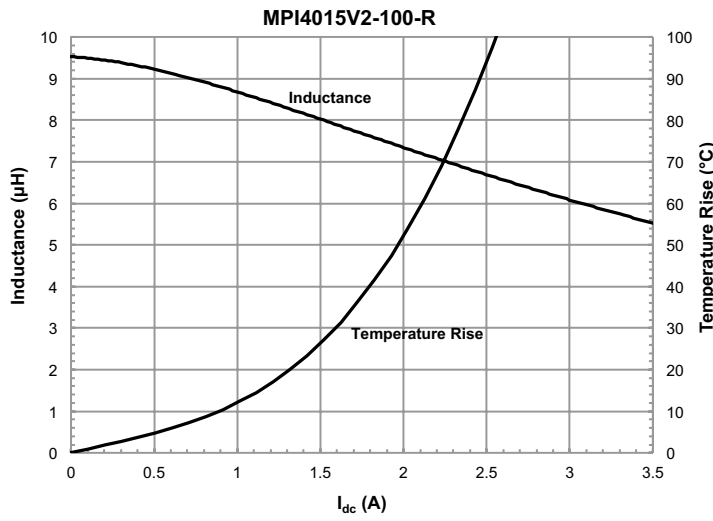

Inductance and temperature rise vs. Current

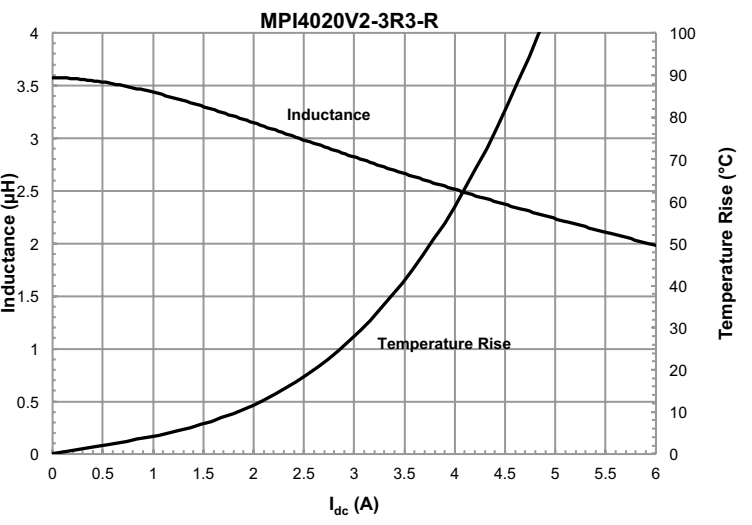
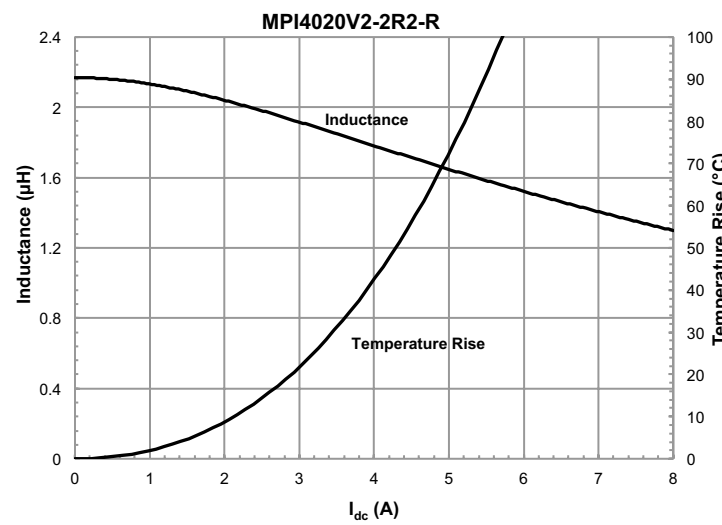
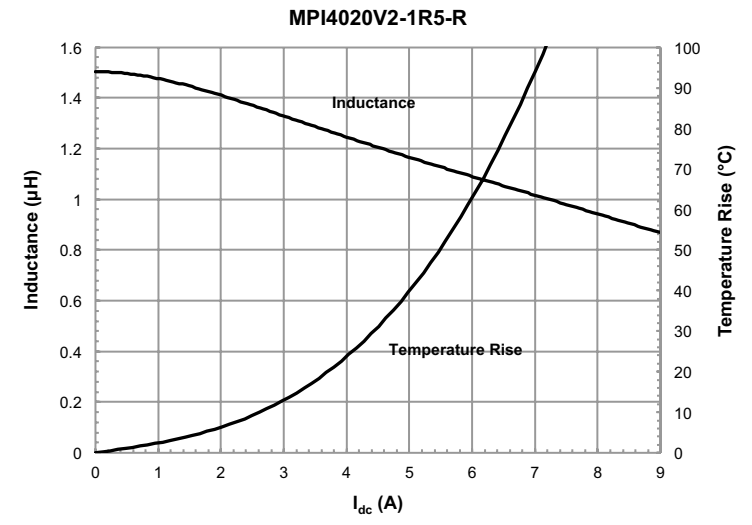
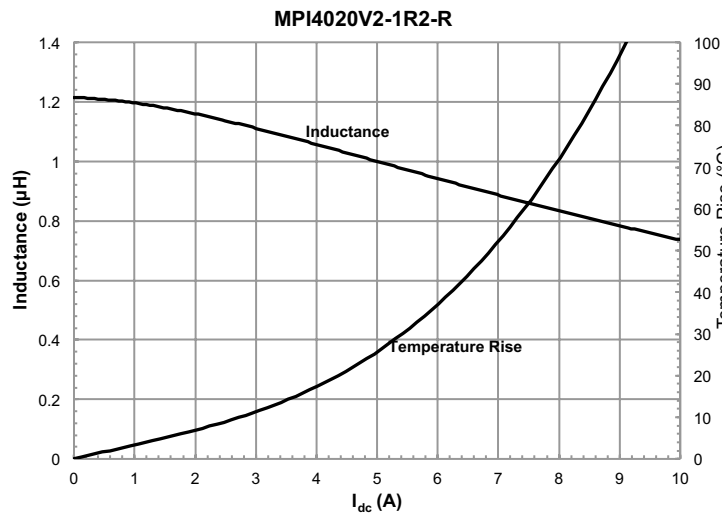
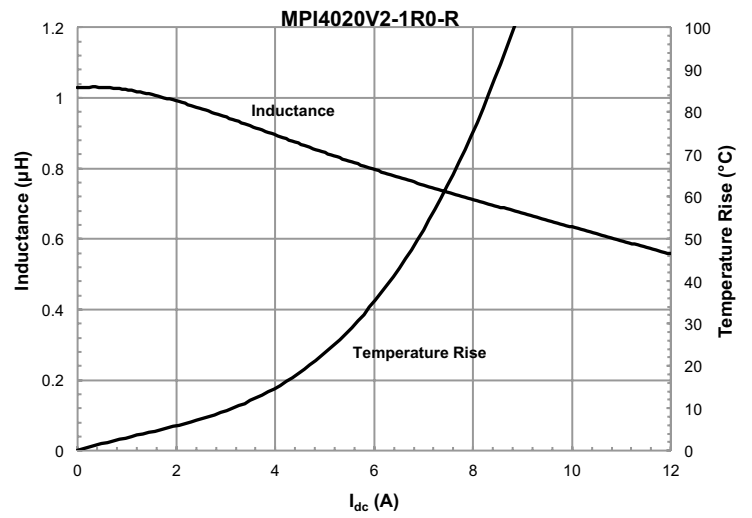
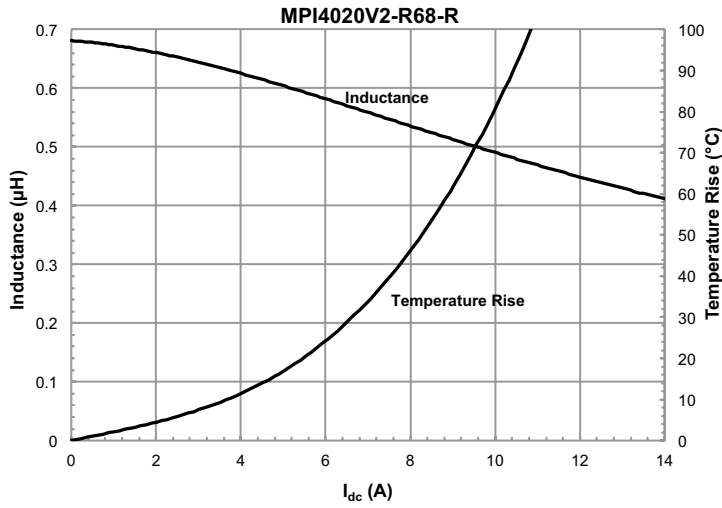

Inductance and temperature rise vs. Current

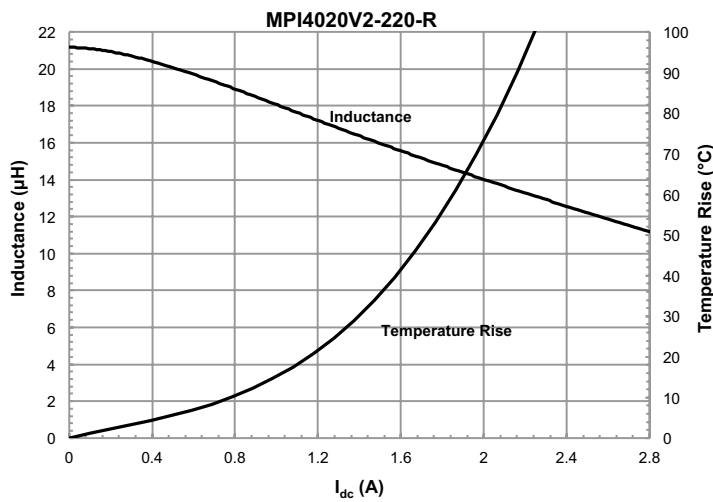
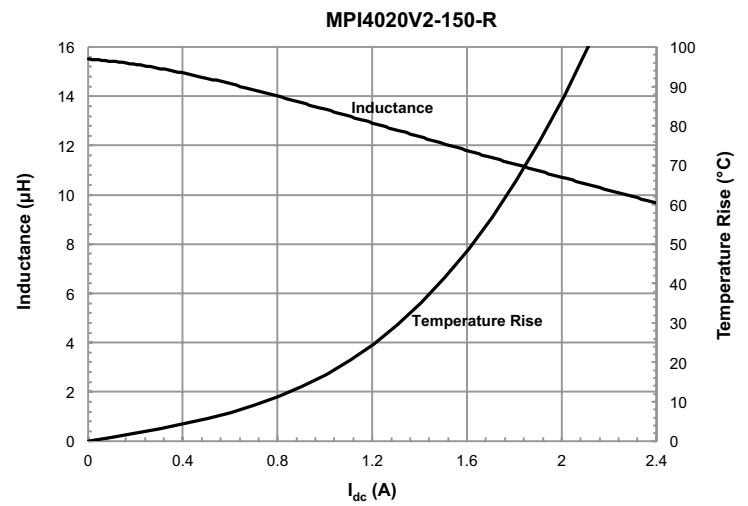
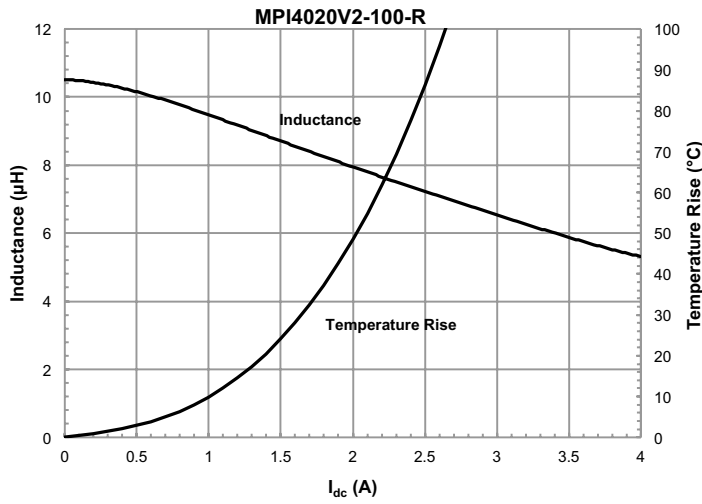
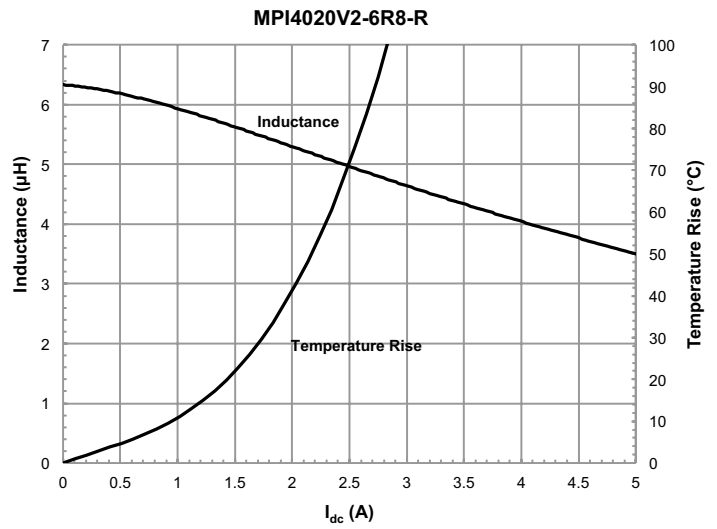
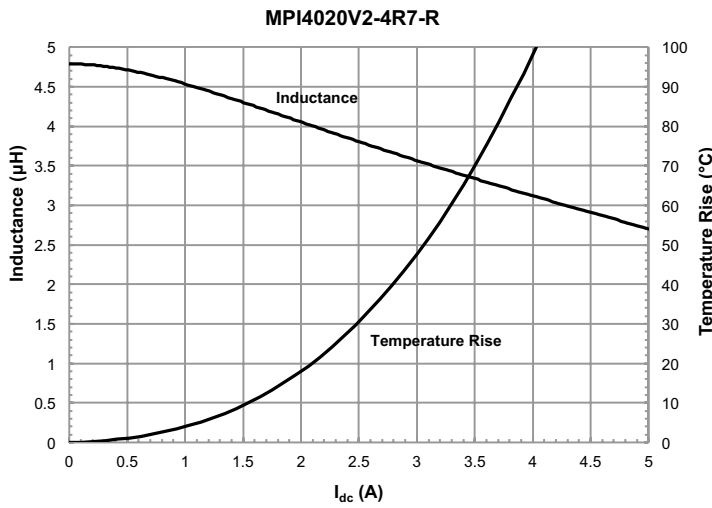

**Solder reflow profile**

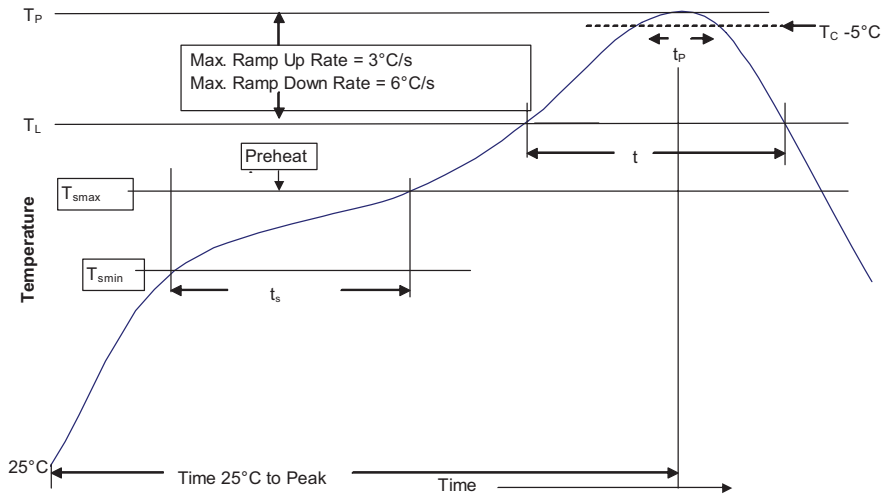

**Table 1 - Standard SnPb Solder (T<sub>C</sub>)**

Package Thickness	Volume mm <sup>3</sup> <350	Volume mm <sup>3</sup> ≥350
<2.5mm)	235 °C	220 °C
≥2.5mm	220 °C	220 °C

**Table 2 - Lead (Pb) Free Solder (T<sub>C</sub>)**

Package Thickness	Volume mm <sup>3</sup> <350	Volume mm <sup>3</sup> 350 - 2000	Volume mm <sup>3</sup> >2000
<1.6mm	260 °C	260 °C	260 °C
1.6 – 2.5mm	260 °C	250 °C	245 °C
>2.5mm	250 °C	245 °C	245 °C

**Reference JDEC J-STD-020**

Profile Feature	Standard SnPb Solder	Lead (Pb) Free Solder
Preheat and Soak		
• Temperature min. (T <sub>smin</sub> )	100 °C	150 °C
• Temperature max. (T <sub>smax</sub> )	150 °C	200 °C
• Time (T <sub>smin</sub> to T <sub>smax</sub> ) (t <sub>s</sub> )	60-120 Seconds	60-120 Seconds
Average ramp up rate T <sub>smax</sub> to T <sub>p</sub>	3 °C/ Second Max.	3 °C/ Second Max.
Liquidous temperature (T <sub>L</sub> )	183 °C	217 °C
Time at liquidous (t <sub>L</sub> )	60-150 Seconds	60-150 Seconds
Peak package body temperature (T <sub>p</sub> )*	Table 1	Table 2
Time (t <sub>p</sub> )** within 5 °C of the specified classification temperature (T <sub>C</sub> )	20 Seconds**	30 Seconds**
Average ramp-down rate (T <sub>p</sub> to T <sub>smax</sub> )	6 °C/ Second Max.	6 °C/ Second Max.
Time 25 °C to Peak Temperature	6 Minutes Max.	8 Minutes Max.

\* Tolerance for peak profile temperature (T<sub>p</sub>) is defined as a supplier minimum and a user maximum.  
 \*\* Tolerance for time at peak profile temperature (t<sub>p</sub>) is defined as a supplier minimum and a user maximum.

Life Support Policy: Eaton does not authorize the use of any of its products for use in life support devices or systems without the express written approval of an officer of the Company. Life support systems are devices which support or sustain life, and whose failure to perform, when properly used in accordance with instructions for use provided in the labeling, can be reasonably expected to result in significant injury to the user.

Eaton reserves the right, without notice, to change design or construction of any products and to discontinue or limit distribution of any products. Eaton also reserves the right to change or update, without notice, any technical information contained in this bulletin.

**Eaton**  
**Electronics Division**  
 1000 Eaton Boulevard  
 Cleveland, OH 44122  
 United States  
[www.eaton.com/electronics](http://www.eaton.com/electronics)

© 2017 Eaton  
 All Rights Reserved  
 Publication 10651 BU-MC17023  
 April 2017

Eaton is a registered trademark.  
 All other trademarks are property of their respective owners.



Компания «Океан Электроники» предлагает заключение долгосрочных отношений при поставках импортных электронных компонентов на взаимовыгодных условиях!

Наши преимущества:

- Поставка оригинальных импортных электронных компонентов напрямую с производств Америки, Европы и Азии, а так же с крупнейших складов мира;
- Широкая линейка поставок активных и пассивных импортных электронных компонентов (более 30 млн. наименований);
- Поставка сложных, дефицитных, либо снятых с производства позиций;
- Оперативные сроки поставки под заказ (от 5 рабочих дней);
- Экспресс доставка в любую точку России;
- Помощь Конструкторского Отдела и консультации квалифицированных инженеров;
- Техническая поддержка проекта, помощь в подборе аналогов, поставка прототипов;
- Поставка электронных компонентов под контролем ВП;
- Система менеджмента качества сертифицирована по Международному стандарту ISO 9001;
- При необходимости вся продукция военного и аэрокосмического назначения проходит испытания и сертификацию в лаборатории (по согласованию с заказчиком);
- Поставка специализированных компонентов военного и аэрокосмического уровня качества (Xilinx, Altera, Analog Devices, Intersil, Interpoint, Microsemi, Actel, Aeroflex, Peregrine, VPT, Syfer, Eurofarad, Texas Instruments, MS Kennedy, Miteq, Cobham, E2V, MA-COM, Hittite, Mini-Circuits, General Dynamics и др.);

Компания «Океан Электроники» является официальным дистрибьютором и эксклюзивным представителем в России одного из крупнейших производителей разъемов военного и аэрокосмического назначения «JONHON», а так же официальным дистрибьютором и эксклюзивным представителем в России производителя высокотехнологичных и надежных решений для передачи СВЧ сигналов «FORSTAR».



## JONHON

«JONHON» (основан в 1970 г.)

Разъемы специального, военного и аэрокосмического назначения:

(Применяются в военной, авиационной, аэрокосмической, морской, железнодорожной, горно- и нефтедобывающей отраслях промышленности)

«FORSTAR» (основан в 1998 г.)

ВЧ соединители, коаксиальные кабели, кабельные сборки и микроволновые компоненты:

(Применяются в телекоммуникациях гражданского и специального назначения, в средствах связи, РЛС, а так же военной, авиационной и аэрокосмической отраслях промышленности).



Телефон: 8 (812) 309-75-97 (многоканальный)

Факс: 8 (812) 320-03-32

Электронная почта: [ocean@oceanchips.ru](mailto:ocean@oceanchips.ru)

Web: <http://oceanchips.ru/>

Адрес: 198099, г. Санкт-Петербург, ул. Калинина, д. 2, корп. 4, лит. А