

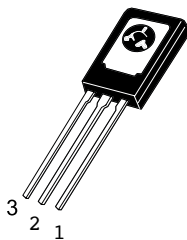

## 2N6071A/B Series



### Pin Out



**REAR VIEW  
SHOW TAB**

**TO-225  
CASE 077  
STYLE 5**

1. Cathode
2. Anode
3. Gate

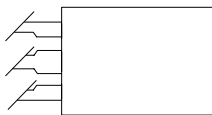

### Description

Designed primarily for full-wave AC control applications, such as light dimmers, motor controls, heating controls and power supplies; or wherever full-wave silicon gate controlled solid-state devices are needed. Triac type thyristors switch from a blocking to a conducting state for either polarity of applied anode voltage with positive or negative gate triggering.

### Features

- Sensitive Gate Triggering Uniquely Compatible for Direct Coupling to TTL, HTL, CMOS and Operational Amplifier Integrated Circuit Logic Functions
- Gate Triggering: 4 Mode - 2N6071A, B; 2N6073A, B; 2N6075A, B
- Blocking Voltages to 600 V
- All Diffused and Glass Passivated Junctions for Greater Parameter Uniformity and Stability
- Small, Rugged, Thermopad Construction for Low Thermal Resistance, High Heat Dissipation and Durability
- Device Marking: Device Type, e.g., 2N6071A, Date Code

### Functional Diagram

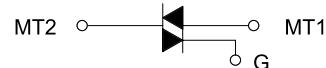

### Additional Information



**Datasheet**



**Resources**



**Samples**

### Maximum Ratings and Thermal Characteristics (T<sub>J</sub> = 25°C unless otherwise noted)

Rating	Symbol	Value	Unit
*Peak Repetitive Off-State Voltage (Note 1) (T <sub>J</sub> = -40 to 110°C, Sine Wave, 50 to 60 Hz, Gate Open) 2N6071A,B 2N6073A,B 2N6075A,B	V <sub>DRM</sub> <sup>*</sup> V <sub>RPM</sub>	200 400 600	-
*On-State RMS Current (T <sub>C</sub> = 85°C) Full Cycle Sine Wave 50 to 60 Hz	I <sub>T(RMS)</sub>	4.0	A
*Peak Non-repetitive Surge Current (One Full cycle, 60 Hz, T <sub>J</sub> = +110°C)	I <sub>TSM</sub>	30	A
Circuit Fusing Considerations (t = 8.3 ms)	I <sub>zt</sub>	3.7	A2s
*Peak Gate Power (Pulse Width "1.0 μs, T <sub>C</sub> = 85°C)	P <sub>GM</sub>	10	W
*Average Gate Power (t = 8.3 ms, T <sub>C</sub> = 85°C)	P <sub>G(AV)</sub>	0.5	W
*Peak Gate Voltage (Pulse Width "1.0 μs, T <sub>C</sub> = 85°C)	V <sub>GM</sub>	5.0	V
*Operating Junction Temperature Range	T <sub>J</sub>	-40 to +110	°C
*Storage Temperature Range	T <sub>stg</sub>	-40 to +150	°C
Mounting Torque (6-32 Screw) (Note 2)	-	8.0	in. lb.

Stresses exceeding Maximum Ratings may damage the device. Maximum Ratings are stress ratings only. Functional operation above the Recommended Operating Conditions is not implied. Extended exposure to stresses above the Recommended Operating Conditions may affect device reliability.

- V<sub>DRM</sub> and V<sub>RPM</sub> for all types can be applied on a continuous basis. Blocking voltages shall not be tested with a constant current source such that the voltage ratings of the devices are exceeded.
- Torque rating applies with use of a compression washer. Mounting torque in excess of 6 in. lb. does not appreciably lower case-to-sink thermal resistance. Main terminal 2 and heatsink contact pad are common.

### Thermal Characteristics

Rating	Symbol	Value	Unit
*Thermal Resistance, Junction to Case	R <sub>θJC</sub>	3.5	°C/W
Thermal Resistance, Junction to Ambient (Note 1)	R <sub>θJA</sub>	75	°C/W
Maximum Lead Temperature for Soldering Purposes, 1/8" from case for 10 seconds	T <sub>L</sub>	260	°C

\*Indicates JEDEC Registered Data.

### Electrical Characteristics - OFF (T<sub>C</sub> = 25°C unless otherwise noted; Electricals apply in both directions)

Characteristic	Symbol	Min	Typ	Max	Unit
*Peak Repetitive Blocking Current (T <sub>J</sub> = 25°C (V <sub>D</sub> = V <sub>DRM</sub> = V <sub>RPM</sub> ; Gate Open) T <sub>J</sub> = 110°C)	I <sub>DRM</sub> , I <sub>RRM</sub>	-	-	10	μA
		-	-	2	mA

### Electrical Characteristics - ON (T<sub>C</sub> = 25°C unless otherwise noted; Electricals apply in both directions)

Characteristic	Symbol	Min	Typ	Max	Unit	
*Peak On-State Voltage (Note 3) (I <sub>TM</sub> = ±6.0 A Peak)	C	-	-	2	V	
*Gate Trigger Voltage (Continuous DC), All Quadrants (Main Terminal Voltage = 12 Vdc, R <sub>i</sub> = 100 Ω, T <sub>J</sub> = -40 °C)	VGT	-	1.4	2.5	V	
Gate Non-Trigger Voltage, All Quadrants (Main Terminal Voltage = 12 Vdc, R <sub>L</sub> = 100 Ω, T <sub>J</sub> = 110°C)	VGD	.02	-	-	V	
*Holding Current (Main Terminal Voltage = 12 Vdc, Gate Open, Initiating Current = ±1 Adc)	I <sub>H</sub>	-	-	30	mA	
		-	-	15	mA	
Turn-On Time (I <sub>TM</sub> = 14 Adc, I <sub>GT</sub> = 100 mAdc)	tgt	-	1.5	-	μs	
QUADRANT (Maximum Value)						
	Type	IGT @ T <sub>J</sub>	I mA	II mA	III mA	IV mA
Gate Trigger Current (Continuous DC) (Main Terminal Voltage = 12 Vdc, R <sub>L</sub> = 100 Ω)	2N6071A	+25°C	5	5	5	10
	2N6073A	-40°C	20	20	20	30
	2N6075A	-40°C	20	20	20	30
	2N6071B	+25°C	3	3	3	5
	2N6073B	-40°C	15	15	15	20
	2N6075B	-40°C	15	15	15	20

3. Pulse Test: Pulse Width ≤ 2.0 ms, Duty Cycle ≤ 2%.

\*Indicates JEDEC Registered Data.

### Dynamic Characteristics

Characteristic	Symbol	Min	Typ	Max	Unit
Critical Rate of Rise of Commutation Voltage @ $V_{DRM}$ , $T_J = 85^\circ\text{C}$ , Gate Open, $I_{TM} = 5.7\text{ A}$ , Exponential Waveform, Commutating $di/dt = 2.0\text{ A/ms}$	$dv/dt(c)$	-	5	10	$\text{V}/\mu\text{s}$

### SAMPLE APPLICATION: TTL-Sensitive Gate 4 Ampere Triac Triggers in Modes II and III



Trigger devices are recommended for gating on Triacs. They provide:

1. Consistent predictable turn-on points.
2. Simplified circuitry.
3. Fast turn-on time for cooler, more efficient and reliable operation.

### Voltage Current Characteristic of Triacs (Bidirectional Device)

Symbol	Parameter
$V_{DRM}$	Peak Repetitive Forward Off State Voltage
$I_{DRM}$	Peak Forward Blocking Current
$V_{RRM}$	Peak Repetitive Reverse Off State Voltage
$I_{RRM}$	Peak Reverse Blocking Current
$V_{TM}$	Maximum On State Voltage
$I_H$	Holding Current



### Sensitive Gate Logic Reference

IC Logic Functions	Firing Quadrant			
	I	II	III	IV
TTL	-	2N6071A Series	2N6071A Series	-
HTL	-	2N6071A Series	2N6071A Series	-
CMOS (NAND)	2N6071B Series	-	-	2N6071B Series
CMOS (Buffer)	-	2N6071B Series	2N6071B Series	-
Operational Amplifier	2N6071A Series	-	-	2N6071A Series
Zero Voltage Switch	-	2N6071A Series	2N6071A Series	-

**Quadrant Definitions for a Triac**



**Ratings and Characteristic Curves**

**Figure 1. Average Current Derating**



**Figure 2. RMS Current Derating**



**Figure 3. Power Dissipation**



**Figure 4. Power Dissipation**



**Figure 5. Typical Gate-Trigger Voltage**



**Figure 6. Typical Gate-Trigger Current**



**Figure 7. Maximum On-State Characteristics**



**Figure 8. Typical Holding Current**



**Figure 9. Maximum Allowable Surge Current**



**Figure 10. Thermal Response**

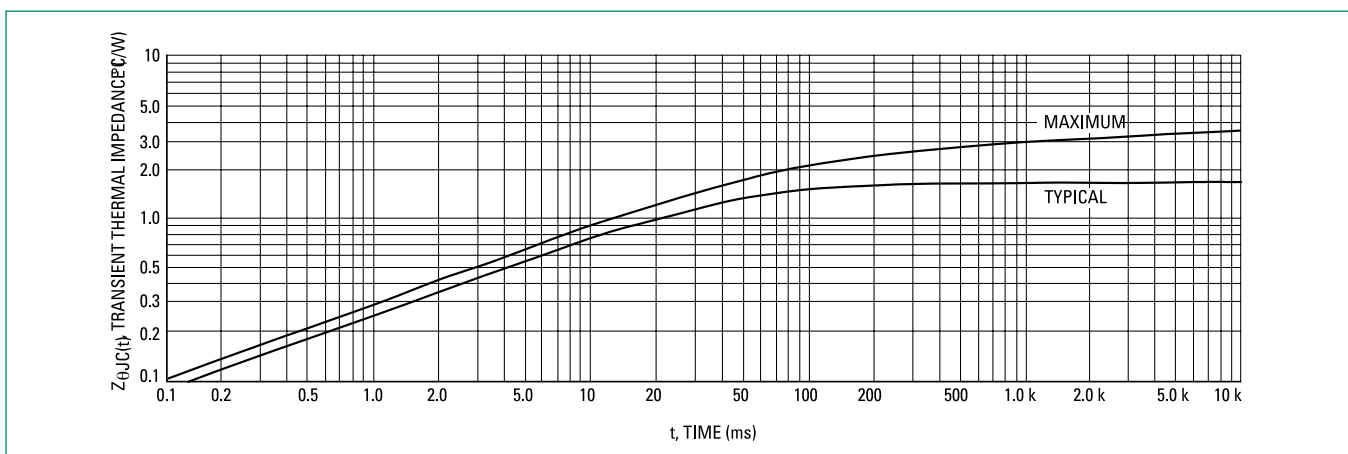

### Dimensions

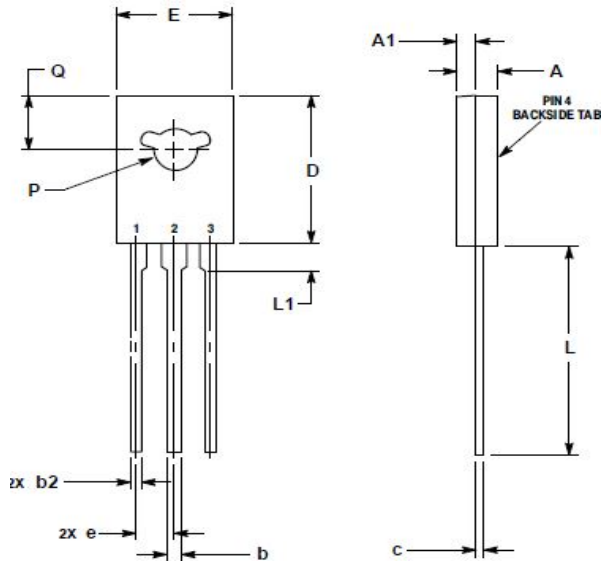

Dim	Inches		Millimeters	
	Min	Max	Min	Max
A	0.102	0.110	2.60	2.80
A1	0.047	0.055	1.20	1.40
b	0.028	0.034	0.70	0.86
b2	0.028	0.034	0.70	0.86
c	0.019	0.022	0.49	0.57
D	0.417	0.449	10.60	11.40
E	0.291	0.323	7.40	8.20
e	0.090 TYP		2.29 TYP	
L	0.551	0.630	14.00	16.00
L1	0.091	0.106	2.30	2.70
P	0.118	0.134	3.00	3.40
Q	0.142	0.157	3.60	4.00

1. DIMENSIONING AND TOLERANCING PER ANSI Y14.5M, 1982.
2. CONTROLLING DIMENSION: INCH.
3. 077-01 THRU -08 OBSOLETE, NEW STANDARD 077-09.

### Part Marking System

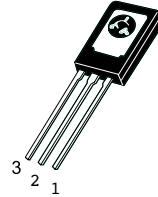

REAR VIEW  
SHOW TAB

TO-225  
CASE 077  
STYLE 5

1. Cathode
2. Anode
3. Gate

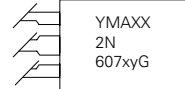

x = 1,3,5  
y = A,B  
Y = Year  
M = Month  
A = Assembly Site  
XX = Lot Serial Code

### Ordering Information

Device	Package	Shipping†
2N6071A	TO-225	2500 Units / Box
2N6071AG	TO-225 (Pb-Free)	
2N6071AT	TO-225	50 Units / Tube 1920 Units / Box
2N6071ATG	TO-225 (Pb-Free)	
2N6071B	TO-225	2500 Units / Box
2N6071BG	TO-225 (Pb-Free)	
2N6071BT	TO-225	50 Units / Tube 1920 Units / Box
2N6071BTG	TO-225 (Pb-Free)	
2N6073A	TO-225	2500 Units / Box
2N6073AG	TO-225 (Pb-Free)	
2N6073B	TO-225	
2N6073BG	TO-225 (Pb-Free)	
2N6075A	TO-225	
2N6075AG	TO-225 (Pb-Free)	
2N6075B	TO-225	
2N6075BG	TO-225 (Pb-Free)	

**Disclaimer Notice** - Information furnished is believed to be accurate and reliable. However, users should independently evaluate the suitability of and test each product selected for their own applications. Littelfuse products are not designed for, and may not be used in, all applications. Read complete Disclaimer Notice at <http://www.littelfuse.com/disclaimer-electronics>.

Компания «Океан Электроники» предлагает заключение долгосрочных отношений при поставках импортных электронных компонентов на взаимовыгодных условиях!

Наши преимущества:

- Поставка оригинальных импортных электронных компонентов напрямую с производств Америки, Европы и Азии, а так же с крупнейших складов мира;
- Широкая линейка поставок активных и пассивных импортных электронных компонентов (более 30 млн. наименований);
- Поставка сложных, дефицитных, либо снятых с производства позиций;
- Оперативные сроки поставки под заказ (от 5 рабочих дней);
- Экспресс доставка в любую точку России;
- Помощь Конструкторского Отдела и консультации квалифицированных инженеров;
- Техническая поддержка проекта, помощь в подборе аналогов, поставка прототипов;
- Поставка электронных компонентов под контролем ВП;
- Система менеджмента качества сертифицирована по Международному стандарту ISO 9001;
- При необходимости вся продукция военного и аэрокосмического назначения проходит испытания и сертификацию в лаборатории (по согласованию с заказчиком);
- Поставка специализированных компонентов военного и аэрокосмического уровня качества (Xilinx, Altera, Analog Devices, Intersil, Interpoint, Microsemi, Actel, Aeroflex, Peregrine, VPT, Syfer, Eurofarad, Texas Instruments, MS Kennedy, Miteq, Cobham, E2V, MA-COM, Hittite, Mini-Circuits, General Dynamics и др.);

Компания «Океан Электроники» является официальным дистрибьютором и эксклюзивным представителем в России одного из крупнейших производителей разъемов военного и аэрокосмического назначения «JONHON», а так же официальным дистрибьютором и эксклюзивным представителем в России производителя высокотехнологичных и надежных решений для передачи СВЧ сигналов «FORSTAR».



## JONHON

«JONHON» (основан в 1970 г.)

Разъемы специального, военного и аэрокосмического назначения:

(Применяются в военной, авиационной, аэрокосмической, морской, железнодорожной, горно- и нефтедобывающей отраслях промышленности)

«FORSTAR» (основан в 1998 г.)

ВЧ соединители, коаксиальные кабели, кабельные сборки и микроволновые компоненты:

(Применяются в телекоммуникациях гражданского и специального назначения, в средствах связи, РЛС, а так же военной, авиационной и аэрокосмической отраслях промышленности).



Телефон: 8 (812) 309-75-97 (многоканальный)

Факс: 8 (812) 320-03-32

Электронная почта: [ocean@oceanchips.ru](mailto:ocean@oceanchips.ru)

Web: <http://oceanchips.ru/>

Адрес: 198099, г. Санкт-Петербург, ул. Калинина, д. 2, корп. 4, лит. А