

Accurax G5 Servo System

Extreme mechatronics meets X-Stream Automation



» Sub micron precision and ms settling time

» Motion network and safety built-in

» Double registration and full closed loop

Extreme mechatronics... At the heart of every great machine

Great machines are born from a perfect match between control and mechanics. Accurax G5 gives you the extra edge to build more accurate, faster, smaller and safer machines. You will benefit from an almost 25% reduction in motor weight, and gain 50% cabinet space.

You will achieve sub micron precision and ms settling time. Some might call it perfection, we just call it tireless innovation to help you build great machines.

Rugged and smart design

- IP67 motor and connectors
- No flying leads
- 5G vibration resistance

40% reduction in motor cogging

- Use of 10 pole motors
- Improved technology to minimize the encoder non-linear errors

8 times higher resolution

- 20 bit encoder
- Faster processor

EtherCAT 

EtherCAT connectivity

- Compliant with CoE –CiA402 Drive Profile–
- Cyclic synchronous Position, Velocity and Torque modes
- Embedded Gear Ratio, Homing and Profile Position mode
- Distributed clock to ensure high precision synchronization

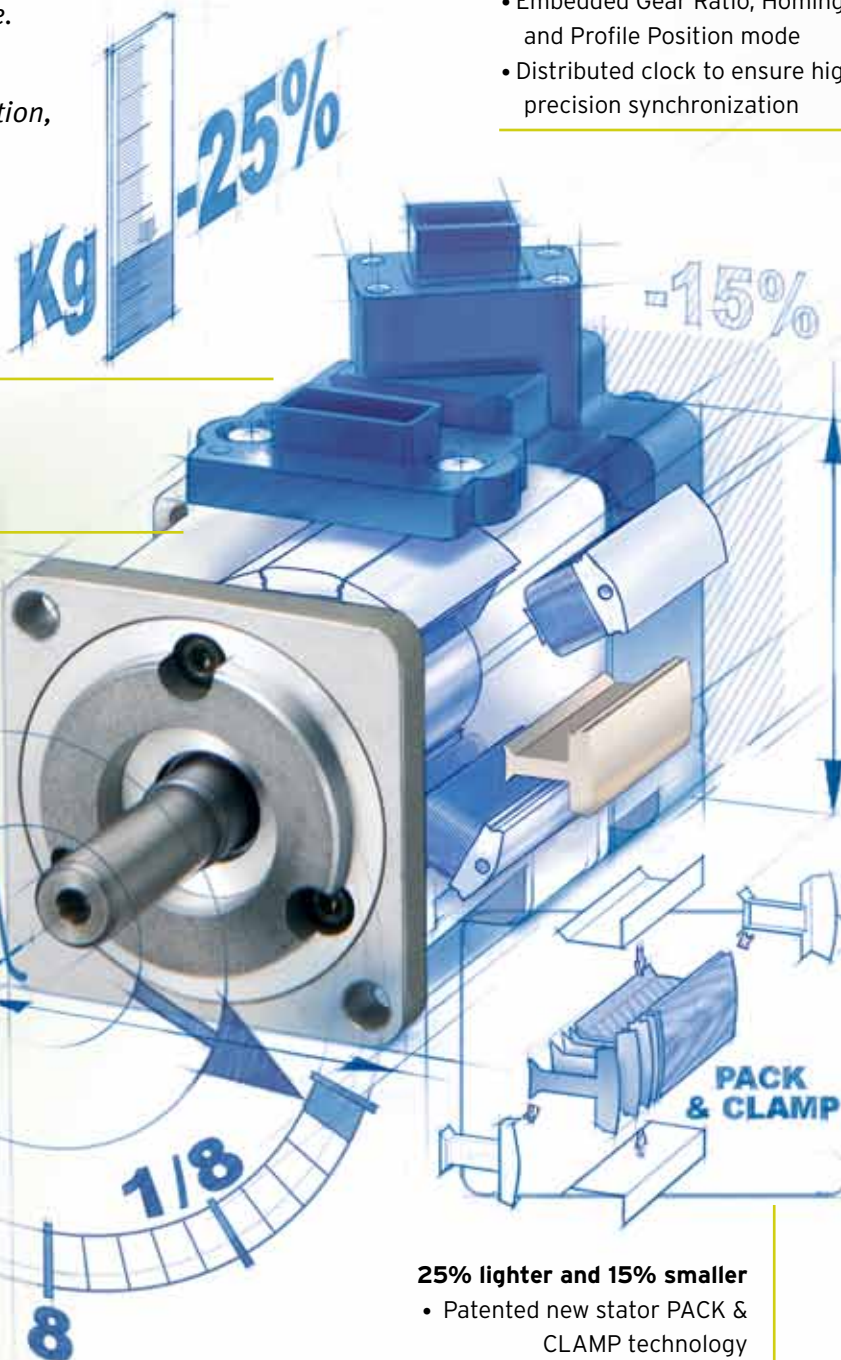

25% lighter and 15% smaller

- Patented new stator PACK & CLAMP technology
- 40% reduction in iron losses
- 45% smaller encoder

Up to 50% cabinet size reduction

- Up to 40% smaller drive
- Extra 10% saving thanks to side by side mounting

Safety conformance

- PL-d according ISO13849-1:2008
- STO: IEC61800-5-2:2007
- SIL2 according to EN61508:2001
- Cat.3: EN954-1:1996



Fast & accurate

- 5 times faster settling time -0~2 ms
- 2 kHz speed response
- Torque feed forward reduces following error

50%

Settling time



Speed response



Torque feed forward



100,000 hr operation in rugged industrial conditions

- No fan below 1 kW
- Long life capacitors

Load vibration suppression

- Up to 4 preset frequencies
- Setting frequency from 1 to 200Hz



Vibration suppression



...meets X-Stream Automation

Accurax G5 is perfectly integrated into the new Sysmac automation platform. The servo is fully configured through the one software Sysmac Studio that includes configuration, programming, simulation and monitoring for the complete machine. The built-in EtherCAT connectivity with the distributed clock functionality allows accurate synchronization between all servos with less than 1 μ jitter. Accurax G5 also simplifies your mechanical and electrical design by including double registration input, full closed loop and multi-drive safety functionality.

① **Built-in safety: multi-drives in a single safety relay circuit**
The two safety inputs and the external device monitoring (EDM) output can be linked from one servo drive to another without using additional safety relays. Up to 8 servo drives can be connected to a single safety relay, saving hardware and wiring costs.

② **Full closed loop**
Accurax G5 has a built-in external encoder input for full closed loop operation, for when additional accuracy is required. The external encoder input eliminates the errors caused by, for example, slip in the material.

③ **Double registration input**
Accurax G5 increases application versatility by providing 2 independent registration inputs per axis, especially relevant for applications such as flow wrappers. By registering the product input position and the mark position on the film, the system can make relative corrections ensuring high accuracy with a simple mechanical design.

INTEGRATED
FUNCTIONALITY



NJ Series Controller

NS HMI

Ethernet

EtherCAT

ETHERNET
CONNECTIVITY

INTUITIVE
SOFTWARE

Open connectivity

- EtherCAT (built-in)
- DeviceNet
- EtherNet/IP (built-in)
- PROFIBUS
- PROFINET

One software - One connection

- Full access to all devices from one connection
- One software for machine control programming and system setup



Sysmac Studio

R88D-KN□□□-ECT, R88D-KN□□□-ML2, R88D-KT□

Accurax G5 Servo System

Accurate motion control in a compact size servo drive family. EtherCAT and safety built-in.

- EtherCAT, ML-II and Analog/Pulse servo drive models
- Safety conforming ISO13849-1 Performance Level D
- High-response frequency of 2 kHz
- High accuracy provided by 20 bits encoder
- Full closed loop encoder built-in
- Real time auto-tuning
- Advanced tuning algorithms (Anti-vibration function, torque feedforward, disturbance observer)
- IP67 protection in all motor models
- Drive Programming: embedded indexer functionality in the Analog/Pulse models



Ratings

- 120 VAC Single-phase 50 W to 400 W
- 230 VAC Single-phase 50 W to 1.5 kW
- 230 VAC Three-phase 2 kW to 5 kW
- 460 VAC Three-phase 600 W to 15 kW

System Configuration



Servo Motor Type Designation

R88M-K05030H-BOS2

Accurax G5 Series servo motor

Capacity

| | | | |
|-----|--------|------|--------|
| 050 | 50 W | 2K0 | 2 kW |
| 100 | 100 W | 3K0 | 3 kW |
| 200 | 200 W | 4K0 | 4 kW |
| 400 | 400 W | 5K0 | 5 kW |
| 600 | 600 W | 6K0 | 6 kW |
| 750 | 750 W | 7K5 | 7.5 kW |
| 900 | 900 W | 11K0 | 11 kW |
| 1K0 | 1 kW | 15K0 | 15 kW |
| 1K5 | 1.5 kW | | |

Rated Speed (r/min)

| | |
|----|------|
| 10 | 1000 |
| 15 | 1500 |
| 20 | 2000 |
| 30 | 3000 |

Shaft end specifications

| | |
|-------|----------------------------------|
| Blank | Straight shaft, no key |
| S2 | Straight, key, tapped (standard) |

Oil seal specifications

| | |
|-------|-------------|
| Blank | No oil seal |
| O | Oil seal |

Brake specifications

| | |
|-------|----------|
| Blank | No brake |
| B | Brake |

Voltage and encoder specifications

- L: 120 V and 20-bit incremental encoder
- S: 120 V and 17-bit absolute encoder
- H: 230 V and 20-bit incremental encoder
- T: 230 V and 17-bit absolute encoder
- F: 460 V and 20-bit incremental encoder
- C: 460 V and 17-bit absolute encoder

Servo Drive Type Designation

R88D-KN01H-ECT

Accurax G5 Series servo drive

Drive Type

- T: Analog/Pulse type
- N: Network type

Model





- Blank: Analog/Pulse type
- ECT: EtherCAT comms
- ML2: MECHATROLINK-II comms

Capacity and Voltage

| Voltage | Code | Output |
|---------|---------|--------|
| 120 V | A5L | 50 W |
| | 01L | 100 W |
| | 02L | 200 W |
| | 04L | 400 W |
| 230 V | 01H | 100 W |
| | 02H | 200 W |
| | 04H | 400 W |
| | 08H | 750 W |
| | 10H | 1 kW |
| | 15H | 1.5 kW |
| | 20H | 2.0 kW |
| | 30H | 3.0 kW |
| 460 V | 50H | 5.0 kW |
| | 75H | 7.5 kW |
| | 06F | 600 W |
| | 10F | 1.0 kW |
| | 15F | 1.5 kW |
| | 20F | 2.0 kW |
| | 30F | 3.0 kW |
| | 50F | 5.0 kW |
| 75F | 7.5 kW | |
| 150F | 15.0 kW | |

Servo Motor/Servo Drive Combination

Servo System Compatibility

| Appearance | Accurax G5 rotary servo motor | | | | | Accurax G5 servo drive models | | | | |
|---|-------------------------------|------------------------|--------------|------------------------|--------------------|-------------------------------|--------------------|-----------------|------------|----------------|
| | Voltage | Speed | Rated torque | Capacity | Model | EtherCAT | Analog/Pulse | MECHATROLINK-II | | |
|  | 120 V | 3000 min ⁻¹ | 0.16 N•m | 50 W | R88M-K05030(H/T)-□ | R88D-KNA5L-ECT | R88D-KTA5L | R88D-KNA5L-ML2 | | |
| | | | 0.32 N•m | 100 W | R88M-K10030(L/S)-□ | R88D-KN01L-ECT | R88D-KT01L | R88D-KN01L-ML2 | | |
| | | | 0.64 N•m | 200 W | R88M-K20030(L/S)-□ | R88D-KN02L-ECT | R88D-KT02L | R88D-KN02L-ML2 | | |
| | | | 1.3 N•m | 400 W | R88M-K40030(L/S)-□ | R88D-KN04L-ECT | R88D-KT04L | R88D-KN04L-ML2 | | |
|  | 230 V | 3000 min ⁻¹ | 0.16 N•m | 50 W | R88M-K05030(H/T)-□ | R88D-KN01H-ECT | R88D-KT01H | R88D-KN01H-ML2 | | |
| | | | 0.32 N•m | 100 W | R88M-K10030(H/T)-□ | R88D-KN01H-ECT | R88D-KT01H | R88D-KN01H-ML2 | | |
| | | | 0.64 N•m | 200 W | R88M-K20030(H/T)-□ | R88D-KN02H-ECT | R88D-KT02H | R88D-KN02H-ML2 | | |
| | | | 1.3 N•m | 400 W | R88M-K40030(H/T)-□ | R88D-KN04H-ECT | R88D-KT04H | R88D-KN04H-ML2 | | |
| | | | 2.4 N•m | 750 W | R88M-K75030(H/T)-□ | R88D-KN08H-ECT | R88D-KT08H | R88D-KN08H-ML2 | | |
|  | 230 V | 3000 min ⁻¹ | 3.18 N•m | 1000 W | R88M-K1K030(H/T)-□ | R88D-KN15H-ECT | R88D-KT15H | R88D-KN15H-ML2 | | |
| | | | 4.77 N•m | 1500 W | R88M-K1K530(H/T)-□ | R88D-KN15H-ECT | R88D-KT15H | R88D-KN15H-ML2 | | |
| | | | 6.37 N•m | 2000 W | R88M-K2K030(H/T)-□ | R88D-KN20H-ECT | R88D-KT20H | R88D-KN20H-ML2 | | |
| | | | 9.55 N•m | 3000 W | R88M-K3K030(H/T)-□ | R88D-KN30H-ECT | R88D-KT30H | R88D-KN30H-ML2 | | |
| | | | 12.7 N•m | 4000 W | R88M-K4K030(H/T)-□ | R88D-KN50H-ECT | R88D-KT50H | R88D-KN50H-ML2 | | |
| | | | 15.9 N•m | 5000 W | R88M-K5K030(H/T)-□ | R88D-KN50H-ECT | R88D-KT50H | R88D-KN50H-ML2 | | |
| | | | 2.39 N•m | 750 W | R88M-K75030(F/C)-□ | R88D-KN10F-ECT | R88D-KT10F | R88D-KN10F-ML2 | | |
| | 460 V | 3000 min ⁻¹ | 3.18 N•m | 1000 W | R88M-K1K030(F/C)-□ | R88D-KN15F-ECT | R88D-KT15F | R88D-KN15F-ML2 | | |
| | | | 4.77 N•m | 1500 W | R88M-K1K530(F/C)-□ | R88D-KN15F-ECT | R88D-KT15F | R88D-KN15F-ML2 | | |
| | | | 6.37 N•m | 2000 W | R88M-K2K030(F/C)-□ | R88D-KN20F-ECT | R88D-KT20F | R88D-KN20F-ML2 | | |
| | | | 9.55 N•m | 3000 W | R88M-K3K030(F/C)-□ | R88D-KN30F-ECT | R88D-KT30F | R88D-KN30F-ML2 | | |
| | | | 12.7 N•m | 4000 W | R88M-K4K030(F/C)-□ | R88D-KN50F-ECT | R88D-KT50F | R88D-KN50F-ML2 | | |
| | | | 15.9 N•m | 5000 W | R88M-K5K030(F/C)-□ | R88D-KN50F-ECT | R88D-KT50F | R88D-KN50F-ML2 | | |
| | | | 230 V | 2000 min ⁻¹ | 4.77 N•m | 1000 W | R88M-K1K020(H/T)-□ | R88D-KN10H-ECT | R88D-KT10H | R88D-KN10H-ML2 |
| | | | | | 7.16 N•m | 1500 W | R88M-K1K520(H/T)-□ | R88D-KN15H-ECT | R88D-KT15H | R88D-KN15H-ML2 |
| 9.55 N•m | 2000 W | R88M-K2K020(H/T)-□ | | | R88D-KN20H-ECT | R88D-KT20H | R88D-KN20H-ML2 | | | |
| 14.3 N•m | 3000 W | R88M-K3K020(H/T)-□ | | | R88D-KN30H-ECT | R88D-KT30H | R88D-KN30H-ML2 | | | |
| 19.1 N•m | 4000 W | R88M-K4K020(H/T)-□ | | | R88D-KN50H-ECT | R88D-KT50H | R88D-KN50H-ML2 | | | |
| 460 V | 2000 min ⁻¹ | 23.9 N•m | | 5000 W | R88M-K5K020(H/T)-□ | R88D-KN50H-ECT | R88D-KT50H | R88D-KN50H-ML2 | | |
| | | 1.91 N•m | | 400 W | R88M-K40020(F/C)-□ | R88D-KN06F-ECT | R88D-KT06F | R88D-KN06F-ML2 | | |
| | | 2.86 N•m | | 600 W | R88M-K60020(F/C)-□ | R88D-KN06F-ECT | R88D-KT06F | R88D-KN06F-ML2 | | |
| | | 4.77 N•m | | 1000 W | R88M-K1K020(F/C)-□ | R88D-KN10F-ECT | R88D-KT10F | R88D-KN10F-ML2 | | |
| | | 7.16 N•m | | 1500 W | R88M-K1K520(F/C)-□ | R88D-KN15F-ECT | R88D-KT15F | R88D-KN15F-ML2 | | |
| 1500 min ⁻¹ | 2000 min ⁻¹ | 9.55 N•m | 2000 W | R88M-K2K020(F/C)-□ | R88D-KN20F-ECT | R88D-KT20F | R88D-KN20F-ML2 | | | |
| | | 14.3 N•m | 3000 W | R88M-K3K020(F/C)-□ | R88D-KN30F-ECT | R88D-KT30F | R88D-KN30F-ML2 | | | |
| | | 19.1 N•m | 4000 W | R88M-K4K020(F/C)-□ | R88D-KN50F-ECT | R88D-KT50F | R88D-KN50F-ML2 | | | |
| | | 23.9 N•m | 5000 W | R88M-K5K020(F/C)-□ | R88D-KN50F-ECT | R88D-KT50F | R88D-KN50F-ML2 | | | |
| | | 47.8 N•m | 7500 W | R88M-K7K515C-□ | R88D-KN75F-ECT | R88D-KT75F | - | | | |
|  | 230 V | 1000 min ⁻¹ | 8.59 N•m | 900 W | R88M-K90010(H/T)-□ | R88D-KN15H-ECT | R88D-KT15H | R88D-KN15H-ML2 | | |
| | | | 19.1 N•m | 2000 W | R88M-K2K010(H/T)-□ | R88D-KN30H-ECT | R88D-KT30H | R88D-KN30H-ML2 | | |
| | | | 28.7 N•m | 3000 W | R88M-K3K010(H/T)-□ | R88D-KN50H-ECT | R88D-KT50H | R88D-KN50H-ML2 | | |
| | 460 V | 1000 min ⁻¹ | 8.59 N•m | 900 W | R88M-K90010(F/C)-□ | R88D-KN15F-ECT | R88D-KT15F | R88D-KN15F-ML2 | | |
| | | | 19.1 N•m | 2000 W | R88M-K2K010(F/C)-□ | R88D-KN30F-ECT | R88D-KT30F | R88D-KN30F-ML2 | | |
| | | | 28.7 N•m | 3000 W | R88M-K3K010(F/C)-□ | R88D-KN50F-ECT | R88D-KT50F | R88D-KN50F-ML2 | | |
| | | | 43.0 N•m | 4500 W | R88M-K4K510C-□ | R88D-KN50F-ECT | R88D-KT50F | R88D-KN50F-ML2 | | |
| | | | 57.3 N•m | 6000 W | R88M-K6K010C-□ | R88D-KN75F-ECT | R88D-KT75F | - | | |

Servo Motor Specifications

Servo motors 3000 r/min rated speed driven with single-phase, 120 V servo drive

| Servo drive input voltage | | Single-phase, 120 V | | | | |
|---------------------------------------|---|---|----------|----------|----------|--------|
| Applicable servo motor R88M-K□ | 20-bit incremental encoder | 05030H-□ | 10030L-□ | 20030L-□ | 40030L-□ | |
| | 17-bit absolute encoder | 05030T-□ | 10030S-□ | 20030S-□ | 40030S-□ | |
| Rated output | W | 50 | 100 | 200 | 400 | |
| Rated torque | N•m | 0.16 | 0.32 | 0.64 | 1.3 | |
| Instantaneous peak torque | N•m | 0.48 | 0.95 | 1.91 | 3.8 | |
| Rated current | A (rms) | 1.1 | 1.6 | 2.5 | 4.6 | |
| Instantaneous max. current | A (rms) | 4.7 | 6.9 | 10.6 | 19.5 | |
| Rated speed | r/min | 3,000 | | | | |
| Max. speed | r/min | 6,000 | | | | |
| Torque constant | N•m/ A (rms) | 0.11±10% | 0.14±10% | 0.20±10% | 0.21±10% | |
| Rotor moment of inertia (JM) | kg•m ² ×10 ⁻⁴ (without brake) | 0.025 | 0.051 | 0.14 | 0.26 | |
| | kg•m ² ×10 ⁻⁴ (with brake) | 0.027 | 0.054 | 0.16 | 0.28 | |
| Allowable load moment of inertia (JL) | Multiple of (JM) | 30 times the rotor inertia max. | | | | |
| Rated power rate | kW/s (without brake) | 10.1 | 19.8 | 28.9 | 62.3 | |
| | kW/s (with brake) | 9.4 | 18.7 | 25.3 | 57.8 | |
| Allowable radial load | N | 68 | 68 | 245 | 245 | |
| Allowable thrust load | N | 58 | 58 | 98 | 98 | |
| Approx. weight | kg (without brake) | 0.31 | 0.45 | 0.78 | 1.2 | |
| | kg (with brake) | 0.51 | 0.65 | 1.2 | 1.6 | |
| Brake specifications | Rated voltage | 24 VDC±10% | | | | |
| | Holding brake moment of inertia (J) | kg•m ² ×10 ⁻⁴ | 0.0002 | 0.0002 | 0.0018 | 0.0018 |
| | Power consumption (at 20°C) | W | 7 | 7 | 9 | 9 |
| | Current consumption (at 20°C) | A | 0.3 | 0.3 | 0.36 | 0.36 |
| | Static friction torque | N•m (minimum) | 0.29 | 0.29 | 1.27 | 1.27 |
| | Rise time for holding torque | ms (max.) | 35 | 35 | 50 | 50 |
| | Release time | ms (max.) | 20 | 20 | 15 | 20 |
| Basic specifications | Time rating | Continuous | | | | |
| | Insulation class | Type B | | | | |
| | Ambient operating/storage temperature | 0 to +40°C/-20 to +65°C | | | | |
| | Ambient operating/storage humidity (RH) | 20% to 85% (non-condensing) | | | | |
| | Vibration class | V-15 | | | | |
| | Insulation resistance | 20 MΩ min. at 500 VDC between the power terminals and FG terminal | | | | |
| | Enclosure | Totally-enclosed, self-cooling, IP67 (excluding shaft opening and motor and encoder pins) | | | | |
| | Vibration resistance | Vibration acceleration 49 m/s ² | | | | |
| | Mounting | Flange-mounted | | | | |

Torque-speed characteristics

R88M-K05030(H/T)-□ (50 W)



R88M-K10030(L/S)-□ (100 W)



R88M-K20030(L/S)-□ (200 W)



R88M-K40030(L/S)-□ (400 W)



Servo Motor Specifications

Servo motors 3000 r/min rated speed driven with single-phase, 230 V servo drive

| Servo drive input voltage | | Single-phase, 230 V | | | | | | |
|---------------------------------------|---|---|----------|----------|----------|----------|----------|-----------------------------|
| Servo motor model R88M-K□ | 20-bit incremental encoder | 05030H-□ | 10030H-□ | 20030H-□ | 40030H-□ | 75030H-□ | 1K030H-□ | 1K530H-□ |
| | 17-bit absolute encoder | 05030T-□ | 10030T-□ | 20030T-□ | 40030T-□ | 75030T-□ | 1K030T-□ | 1K530T-□ |
| Rated output | W | 50 | 100 | 200 | 400 | 750 | 1000 | 1500 |
| Rated torque | N•m | 0.16 | 0.32 | 0.64 | 1.3 | 2.4 | 3.18 | 4.77 |
| Instantaneous peak torque | N•m | 0.48 | 0.95 | 1.91 | 3.8 | 7.1 | 9.55 | 14.3 |
| Rated current | A (rms) | 1.2 | 1.1 | 1.5 | 2.4 | 4.1 | 6.6 | 8.2 |
| Instantaneous max. current | A (rms) | 5.1 | 4.7 | 6.5 | 10.2 | 17.4 | 28 | 35 |
| Rated speed | r/min | 3,000 | | | | | | |
| Max. speed | r/min | 6,000 | | | | | | 5,000 |
| Torque constant | N•m/ A (rms) | 0.11±10% | 0.21±10% | 0.31±10% | 0.39±10% | 0.42±10% | 0.37 | 0.45 |
| Rotor moment of inertia (JM) | kg•m ² ×10 ⁻⁴ (without brake) | 0.025 | 0.051 | 0.14 | 0.26 | 0.87 | 2.03 | 2.84 |
| | kg•m ² ×10 ⁻⁴ (with brake) | 0.027 | 0.054 | 0.16 | 0.28 | 0.97 | 2.35 | 3.17 |
| Allowable load moment of inertia (JL) | Multiple of (JM) | 30 | | | | 20 | 15 | |
| Rated power rate | kW/s (without brake) | 10.1 | 19.9 | 29.0 | 62.4 | 65.6 | 49.8 | 80.1 |
| | kW/s (with brake) | 9.4 | 18.8 | 25.4 | 58 | 58.8 | 43 | 71.8 |
| Allowable radial load | N | 68 | | 245 | | 490 | | |
| Allowable thrust load | N | 58 | | 98 | | 196 | | |
| Approx. mass | kg (without brake) | 0.32 | 0.47 | 0.82 | 1.2 | 2.3 | 3.5 | 4.4 |
| | kg (with brake) | 0.53 | 0.68 | 1.3 | 1.7 | 3.1 | 4.5 | 5.4 |
| Brake specifications | Rated voltage | 24 VDC±10% | | | | | | |
| | Holding brake moment of inertia (J) | kg•m ² ×10 ⁻⁴ | 0.002 | | 0.0018 | | 0.33 | |
| | Power consumption (at 20°C) | W | 7 | | 9 | | 17 | 19 |
| | Current consumption (at 20°C) | A | 0.3 | | 0.36 | | 0.70±10% | 0.81±10% |
| | Static friction torque | N•m (minimum) | 0.29 | | 1.27 | | 2.5 | 7.8 |
| | Rise time for holding torque | ms (max.) | 35 | | 50 | | | |
| | Release time | ms (max.) | | 20 | | 15 | | |
| Basic specifications | Time rating | Continuous | | | | | | |
| | Insulation class | Type B | | | | | | Type F |
| | Ambient operating/storage temperature | 0 to +40°C/-20 to +65°C | | | | | | |
| | Ambient operating/storage humidity (RH) | 20% to 80% (non-condensing) | | | | | | 20% to 85% (non-condensing) |
| | Vibration class | V-15 | | | | | | |
| | Insulation resistance | 20 MΩ min. at 500 VDC between the power terminals and FG terminal | | | | | | |
| | Enclosure | Totally-enclosed, self-cooling, IP67 (excluding shaft opening) | | | | | | |
| | Vibration resistance | Vibration acceleration 49 m/s ² | | | | | | |
| Mounting | Flange-mounted | | | | | | | |

Torque-speed characteristics R88M-K05030H/T (50 W)



R88M-K10030H/T (100 W)



R88M-K20030H/T (200 W)



R88M-K40030H/T (400 W)



R88M-K75030H/T (750 W)



R88M-K1K030H/T (1 kW)



R88M-K1K530H/T (1.5 kW)



Servo Motor Specifications

Servo motors 3000 r/min rated speed driven with three-phase, 230 V servo drive

| Servo drive input voltage | | Three-phase, 230 V | | | | |
|-------------------------------|---|---|-----------|-----------|-----------|----------|
| Applicable servo motor R88M-□ | 20-bit incremental encoder | K2K030H-□ | K3K030H-□ | K4K030H-□ | K5K030H-□ | |
| | 17-bit absolute encoder | K2K030T-□ | K3K030T-□ | K4K030T-□ | K5K030T-□ | |
| Rated output | kW | 2 | 3 | 4 | 5 | |
| Rated torque | N•m | 6.37 | 9.55 | 12.7 | 15.9 | |
| Instantaneous peak torque | N•m | 19.1 | 28.6 | 38.2 | 47.7 | |
| Rated current | A (rms) | 11.3 | 18.1 | 19.6 | 24 | |
| Instantaneous max. current | A (rms) | 48 | 77 | 83 | 102 | |
| Rated speed | r/min | 3,000 | | | | |
| Max. speed | r/min | 5,000 | | | | |
| Torque constant | N•m/ A (rms) | 0.44 | 0.41 | 0.49 | 0.49 | |
| | kg•m ² ×10 ⁻⁴ (without brake) | 3.68 | 6.5 | 12.9 | 17.4 | |
| Rotor moment of inertia (JM) | kg•m ² ×10 ⁻⁴ (with brake) | 4.01 | 7.85 | 14.2 | 18.6 | |
| | Multiple of (JM) | 15 times the rotor inertia max. | | | | |
| Rated power rate | kW/s (without brake) | 110 | 140 | 126 | 146 | |
| | kW/s (with brake) | 101 | 116 | 114 | 136 | |
| Allowable radial load | N | 490 | 490 | 784 | 784 | |
| Allowable thrust load | N | 196 | 196 | 343 | 343 | |
| Approx. weight | kg (without brake) | 5.3 | 8.3 | 11 | 14 | |
| | kg (with brake) | 6.3 | 9.4 | 12.6 | 16 | |
| Brake specifications | Rated voltage | 24 VDC±10% | | | | |
| | Holding brake moment of inertia (J) | kg•m ² ×10 ⁻⁴ | 0.33 | 0.33 | 1.35 | 1.35 |
| | Power consumption (at 20°C) | W | 19 | 19 | 22 | 22 |
| | Current consumption (at 20°C) | A | 0.81±10% | 0.81±10% | 0.90±10% | 0.90±10% |
| | Static friction torque | N•m (minimum) | 7.8 | 11.8 | 16.1 | 16.1 |
| | Rise time for holding torque | ms (max.) | 50 | 80 | 110 | 110 |
| | Release time | ms (max.) | 15 | 15 | 50 | 50 |
| Basic specifications | Time rating | Continuous | | | | |
| | Insulation class | Type F | | | | |
| | Ambient operating/storage temperature | 0 to +40°C/-20 to +65°C | | | | |
| | Ambient operating/storage humidity (RH) | 20% to 85% (non-condensing) | | | | |
| | Vibration class | V-15 | | | | |
| | Insulation resistance | 20 MΩ min. at 500 VDC between the power terminals and FG terminal | | | | |
| | Enclosure | Totally-enclosed, self-cooling, IP67 (excluding shaft opening and motor and encoder pins) | | | | |
| | Vibration resistance | Vibration acceleration 49 m/s ² | | | | |
| Mounting | Flange-mounted | | | | | |

Torque-speed characteristics

R88M-K2K030(H/T)-□ (2 kW)



R88M-K3K030(H/T)-□ (3 kW)



R88M-K4K030(H/T)-□ (4 kW)



R88M-K5K030(H/T)-□ (5 kW)



Servo Motor Specifications

Servo motors 3000 r/min rated speed driven with three-phase, 460 V servo drive

| Servo drive input voltage | | Three-phase, 460 V | | | | | | | | |
|---------------------------------------|---|---|----------|----------|----------|----------|----------|----------|------|--|
| Servo motor model R88M-K□ | 20-bit incremental encoder | 75030F-□ | 1K030F-□ | 1K530F-□ | 2K030F-□ | 3K030F-□ | 4K030F-□ | 5K030F-□ | | |
| | 17-bit absolute encoder | 75030C-□ | 1K030C-□ | 1K530C-□ | 2K030C-□ | 3K030C-□ | 4K030C-□ | 5K030C-□ | | |
| Rated output | W | 750 | 1000 | 1500 | 2000 | 3000 | 4000 | 5000 | | |
| Rated torque | N•m | 2.39 | 3.18 | 4.77 | 6.37 | 9.55 | 12.7 | 15.9 | | |
| Instantaneous peak torque | N•m | 7.16 | 9.55 | 14.3 | 19.1 | 28.6 | 38.2 | 47.7 | | |
| Rated current | A (rms) | 2.4 | 3.3 | 4.2 | 5.7 | 9.2 | 9.9 | 12 | | |
| Instantaneous max. current | A (rms) | 10 | 14 | 18 | 24 | 39 | 42 | 51 | | |
| Rated speed | r/min | 3,000 | | | | | | | | |
| Max. speed | r/min | 5,000 | | | | | | 4,500 | | |
| Torque constant | N•m/ A (rms) | 0.78 | 0.75 | 0.89 | 0.87 | 0.81 | 0.98 | | | |
| Rotor moment of inertia (JM) | kg•m ² ×10 ⁻⁴ (without brake) | 1.61 | 2.03 | 2.84 | 3.68 | 6.5 | 12.9 | 17.4 | | |
| | kg•m ² ×10 ⁻⁴ (with brake) | 1.93 | 2.35 | 3.17 | 4.01 | 7.85 | 14.2 | 18.6 | | |
| Allowable load moment of inertia (JL) | Multiple of (JM) | 30 | | | | | | | | |
| Rated power rate | kW/s (without brake) | 35.5 | 49.8 | 80.1 | 110 | 140 | 126 | 146 | | |
| | kW/s (with brake) | 29.6 | 43 | 71.8 | 101 | 116 | 114 | 136 | | |
| Allowable radial load | N | 490 | | | | | | 784 | | |
| Allowable thrust load | N | 196 | | | | | | | | |
| Approx. mass | kg (without brake) | 3.1 | 3.5 | 4.4 | 5.3 | 8.3 | 11 | 14 | | |
| | kg (with brake) | 4.1 | 4.5 | 5.4 | 6.3 | 9.4 | 12.6 | 16 | | |
| Brake specifications | Rated voltage | 24 VDC±10% | | | | | | | | |
| | Holding brake moment of inertia (J) | kg•m ² ×10 ⁻⁴ | 0.33 | | | | | | 1.35 | |
| | Power consumption (at 20°C) | W | 17 | 19 | | | | | 22 | |
| | Current consumption (at 20°C) | A | 0.70±10% | | 0.81±10% | | 0.90±10% | | | |
| | Static friction torque | N•m (minimum) | 2.5 | 7.8 | | | | 11.8 | 16.1 | |
| | Rise time for holding torque | ms (max.) | 50 | | | | | | 110 | |
| | Release time | ms (max.) | 15 | | | | | | 50 | |
| Basic specifications | Time rating | Continuous | | | | | | | | |
| | Insulation class | Type F | | | | | | | | |
| | Ambient operating/storage temperature | 0 to +40°C/-20 to +65°C | | | | | | | | |
| | Ambient operating/storage humidity (RH) | 20% to 85% (non-condensing) | | | | | | | | |
| | Vibration class | V-15 | | | | | | | | |
| | Insulation resistance | 20 MΩ min. at 500 VDC between the power terminals and FG terminal | | | | | | | | |
| | Enclosure | Totally-enclosed, self-cooling, IP67 (excluding shaft opening) | | | | | | | | |
| | Vibration resistance | Vibration acceleration 49 m/s ² | | | | | | | | |
| Mounting | Flange-mounted | | | | | | | | | |

Torque-speed characteristics

R88M-K75030F/C (750 W)



R88M-K1K030F/C (1 kW)



R88M-K1K530F/C (1.5 kW)



R88M-K2K030F/C (2 kW)



R88M-K3K030F/C (3 kW)



R88M-K4K030F/C (4 kW)



R88M-K5K030F/C (5 kW)



Servo Motor Specifications

Servo motors 2000 r/min rated speed driven with three-phase, 230 V servo drive

| Servo drive input voltage | | Three-phase, 230 V | | | | | | |
|---------------------------------------|---|---|-----------|-----------|-----------|-----------|-----------|---------|
| Applicable servo motor R88M-□ | 20-bit incremental encoder | K1K020H-□ | K1K520H-□ | K2K020H-□ | K3K020H-□ | K4K020H-□ | K5K020H-□ | |
| | 17-bit absolute encoder | K1K020T-□ | K1K520T-□ | K2K020T-□ | K3K020T-□ | K4K020T-□ | K5K020T-□ | |
| Rated output | kW | 1 | 1.5 | 2 | 3 | 4 | 5 | |
| Rated torque | N•m | 4.77 | 7.16 | 9.55 | 14.3 | 19.1 | 23.9 | |
| Instantaneous peak torque | N•m | 14.3 | 21.5 | 28.6 | 43 | 57.3 | 71.6 | |
| Rated current | A (rms) | 5.7 | 9.4 | 11.5 | 17.4 | 21 | 25.9 | |
| Instantaneous max. current | A (rms) | 24 | 40 | 49 | 74 | 89 | 110 | |
| Rated speed | r/min | 2000 | | | | | | |
| Max. speed | r/min | 3000 | | | | | | |
| Torque constant | N•m/ A (rms) | 0.63 | 0.58 | 0.64 | 0.59 | 0.7 | 0.7 | |
| Rotor moment of inertia (JM) | kg•m ² ×10 ⁻⁴ (without brake) | 4.6 | 6.7 | 8.72 | 12.9 | 37.6 | 48 | |
| | kg•m ² ×10 ⁻⁴ (with brake) | 5.9 | 7.99 | 10 | 14.2 | 38.6 | 48.8 | |
| Allowable load moment of inertia (JL) | Multiple of (JM) | 10 times the rotor inertia max. | | | | | | |
| Rated power rate | kW/s (without brake) | 49.5 | 76.5 | 105 | 159 | 97.1 | 119 | |
| | kW/s (with brake) | 38.6 | 64.2 | 91.2 | 144 | 94.5 | 117 | |
| Allowable radial load | N | 490 | 490 | 490 | 784 | 784 | 784 | |
| Allowable thrust load | N | 196 | 196 | 196 | 343 | 343 | 343 | |
| Approx. weight | kg (without brake) | 5.2 | 6.7 | 8 | 11 | 15.5 | 18.6 | |
| | kg (with brake) | 6.7 | 8.2 | 9.5 | 12.6 | 18.7 | 21.8 | |
| Brake specifications | Rated voltage | 24 VDC±10% | | | | | | |
| | Holding brake moment of inertia (J) | kg•m ² ×10 ⁻⁴ | 1.35 | 1.35 | 1.35 | 1.35 | 4.7 | 4.7 |
| | Power consumption (at 20°C) | W | 14 | 19 | 19 | 22 | 31 | 31 |
| | Current consumption (at 20°C) | A | 0.59±10% | 0.79±10% | 0.79±10% | 0.90±10% | 1.3±10% | 1.3±10% |
| | Static friction torque | N•m (minimum) | 4.9 | 13.7 | 13.7 | 16.2 | 24.5 | 24.5 |
| | Rise time for holding torque | ms (max.) | 80 | 100 | 100 | 110 | 80 | 80 |
| | Release time | ms (max.) | 70 | 50 | 50 | 50 | 25 | 25 |
| Basic specifications | Time rating | Continuous | | | | | | |
| | Insulation class | Type F | | | | | | |
| | Ambient operating/storage temperature | 0 to +40 °C/ -20 to 85°C | | | | | | |
| | Ambient operating/storage humidity (RH) | 20% to 85% (non-condensing) | | | | | | |
| | Vibration class | V-15 | | | | | | |
| | Insulation resistance | 20 MΩ min. at 500 VDC between the power terminals and FG terminal | | | | | | |
| | Enclosure | Totally-enclosed, self-cooling, IP67 (excluding shaft opening and motor and encoder pins) | | | | | | |
| | Vibration resistance | Vibration acceleration 49 m/s ² | | | | | | |
| | Mounting | Flange-mounted | | | | | | |

Torque-speed characteristics

R88M-K1K020(H/T)-□ (1 kW)



R88M-K1K520(H/T)-□ (1.5 kW)



R88M-K2K020(H/T)-□ (2 kW)



R88M-K3K020(H/T)-□ (3 kW)



R88M-K4K020(H/T)-□ (4 kW)



R88M-K5K020(H/T)-□ (5 kW)



Servo Motor Specifications

Servo motors 2000 r/min rated speed driven with three-phase, 460 V servo drive

| Servo drive input voltage | | Three-phase, 460 V | | | | | | | | |
|---------------------------------------|---|---|-----------|-----------|-----------|-----------|-----------|-----------|-----------|---------|
| Applicable servo motor R88M-□ | 20-bit incremental encoder | 40020F-□ | 60020F-□ | K1K020F-□ | K1K520F-□ | K2K020F-□ | K3K020F-□ | K4K020F-□ | K5K020F-□ | |
| | 17-bit absolute encoder | 40020C-□ | 60020C-□ | K1K020C-□ | K1K520C-□ | K2K020C-□ | K3K020C-□ | K4K020C-□ | K5K020C-□ | |
| Rated output | kW | 0.4 | 0.6 | 1 | 1.5 | 2 | 3 | 4 | 5 | |
| Rated torque | N•m | 1.91 | 2.86 | 4.77 | 7.16 | 9.55 | 14.3 | 19.1 | 23.9 | |
| Instantaneous peak torque | N•m | 5.73 | 8.59 | 14.3 | 21.5 | 28.7 | 43 | 57.3 | 71.6 | |
| Rated current | A (rms) | 1.2 | 1.5 | 2.8 | 4.7 | 5.9 | 8.7 | 10.6 | 13 | |
| Instantaneous max. current | A (rms) | 4.9 | 6.5 | 12 | 20 | 25 | 37 | 45 | 55 | |
| Rated speed | r/min | 2000 | | | | | | | | |
| Max. speed | r/min | 3000 | | | | | | | | |
| Torque constant | N•m/ A (rms) | 1.27 | 1.38 | 1.27 | 1.16 | 1.27 | 1.18 | 1.4 | 1.46 | |
| Rotor moment of inertia (JM) | kg•m ² ×10 ⁻⁴ (without brake) | 1.61 | 2.03 | 4.6 | 6.7 | 8.72 | 12.9 | 37.6 | 48 | |
| | kg•m ² ×10 ⁻⁴ (with brake) | 1.9 | 2.35 | 5.9 | 7.99 | 10 | 14.2 | 38.6 | 48.8 | |
| Allowable load moment of inertia (JL) | Multiple of (JM) | 10 times the rotor inertia max. | | | | | | | | |
| Rated power rate | kW/s (without brake) | 22.7 | 40.3 | 49.5 | 76.5 | 105 | 159 | 97.1 | 119 | |
| | kW/s (with brake) | 19.2 | 34.8 | 38.6 | 64.2 | 91.2 | 144 | 94.5 | 117 | |
| Allowable radial load | N | 490 | 490 | 490 | 490 | 490 | 784 | 784 | 784 | |
| Allowable thrust load | N | 196 | 196 | 196 | 196 | 196 | 343 | 343 | 343 | |
| Approx. weight | kg (without brake) | 3.1 | 3.5 | 5.2 | 6.7 | 8 | 11 | 15.5 | 18.6 | |
| | kg (with brake) | 4.1 | 4.5 | 6.7 | 8.2 | 9.5 | 12.6 | 18.7 | 21.8 | |
| Brake specifications | Rated voltage | 24 VDC±10% | | | | | | | | |
| | Holding brake moment of inertia (J) | kg•m ² ×10 ⁻⁴ | 1.35 | 1.35 | 1.35 | 1.35 | 1.35 | 1.35 | 4.7 | 4.7 |
| | Power consumption (at 20°C) | W | 17 | 17 | 14 | 19 | 19 | 22 | 31 | 31 |
| | Current consumption (at 20°C) | A | 0.70 ±10% | 0.70 ±10% | 0.59±10% | 0.79±10% | 0.79±10% | 0.90±10% | 1.3±10% | 1.3±10% |
| | Static friction torque | N•m (minimum) | 2.5 | 2.5 | 4.9 | 13.7 | 13.7 | 16.2 | 24.5 | 24.5 |
| | Rise time for holding torque | ms (max.) | 50 | 50 | 80 | 100 | 100 | 110 | 80 | 80 |
| | Release time | ms (max.) | 15 | 15 | 70 | 50 | 50 | 50 | 25 | 25 |
| Basic specifications | Time rating | Continuous | | | | | | | | |
| | Insulation class | Type F | | | | | | | | |
| | Ambient operating/storage temperature | 0 to +40 °C/ -20 to 85°C | | | | | | | | |
| | Ambient operating/storage humidity (RH) | 20% to 85% (non-condensing) | | | | | | | | |
| | Vibration class | V-15 | | | | | | | | |
| | Insulation resistance | 20 MΩ min. at 500 VDC between the power terminals and FG terminal | | | | | | | | |
| | Enclosure | Totally-enclosed, self-cooling, IP67 (excluding shaft opening and motor and encoder pins) | | | | | | | | |
| | Vibration resistance | Vibration acceleration 49 m/s ² | | | | | | | | |
| Mounting | Flange-mounted | | | | | | | | | |

Torque-speed characteristics

R88M-K40020F/C (400 W)



R88M-K60020F/C (600 W)



R88M-K1K020F/C (1 kW)



R88M-K1K520F/C (1.5 kW)



R88M-K2K020F/C (2 kW)



R88M-K3K0F/C (3 kW)



R88M-K4K020F/C (4 kW)



R88M-K5K020F/C (5 kW)



Servo Motor Specifications

Servo motors 1500 r/min rated speed driven with three-phase, 460 V servo drive

| Servo drive input voltage | | Three-phase, 230 V | | Three-phase, 460 V | |
|---------------------------------------|---|---|----------|--------------------|-----------|
| Applicable servo motor R88M-K□ | 17-bit absolute encoder | K7K5015T-□ | 7K515C-□ | 11K015C-□ | 15K015C-□ |
| Rated output | kW | 7500 | 7500 | 11000 | 15000 |
| Rated torque | N•m | 47.8 | 47.8 | 70.0 | 95.5 |
| Instantaneous peak torque | N•m | 119.0 | 119.0 | 175.0 | 224.0 |
| Rated current | A (rms) | 44 | 22.0 | 27.1 | 33.1 |
| Instantaneous max. current | A (rms) | 165 | 83 | 101 | 118 |
| Rated speed | r/min | 1500 | | | |
| Max. speed | r/min | 3000 | 3000 | 2000 | |
| Torque constant | N•m/ A (rms) | 0.77 | 1.54 | 1.84 | 2.10 |
| Rotor moment of inertia (JM) | kg•m ² ×10 ⁻⁴ (without brake) | 101 | 101 | 212 | 302 |
| | kg•m ² ×10 ⁻⁴ (with brake) | 107 | 107 | 220 | 311 |
| Allowable load moment of inertia (JL) | Multiple of (JM) | 10 times the rotor inertia max. | | | |
| Rated power rate | kW/s (without brake) | 226 | 226 | 231 | 302 |
| | kW/s (with brake) | 213 | 213 | 223 | 293 |
| Allowable radial load | N | 1176 | 1176 | 2254 | 2254 |
| Allowable thrust load | N | 490 | 490 | 686 | 686 |
| Approx. weight | kg (without brake) | 36.4 | 36.4 | 52.7 | 70.2 |
| | kg (with brake) | 40.4 | 40.4 | 58.9 | 76.3 |
| Brake specifications | Rated voltage | 24 VDC±10% | | | |
| | Holding brake moment of inertia (J) | kg•m ² ×10 ⁻⁴ | 4.7 | | 7.1 |
| | Power consumption (at 20°C) | W | 34 | | 26 |
| | Current consumption (at 20°C) | A | 1.4±10% | | 1.08±10% |
| | Static friction torque | N•m (minimum) | 58.8 | | 100 |
| | Rise time for holding torque | ms (max.) | 150 | | 300 |
| | Release time | ms (max.) | 50 | | 140 |
| Basic specifications | Time rating | Continuous | | | |
| | Insulation class | Type F | | | |
| | Ambient operating/storage temperature | 0 to +40 °C/ -20 to 65°C | | | |
| | Ambient operating/storage humidity (RH) | 20% to 85% (non-condensing) | | | |
| | Vibration class | V-15 | | | |
| | Insulation resistance | 20 MΩ min. at 500 VDC between the power terminals and FG terminal | | | |
| | Enclosure | Totally-enclosed, self-cooling, IP67 (excluding shaft opening) | | | |
| | Vibration resistance | Vibration acceleration 49 m/s ² | | | |
| | Mounting | Flange-mounted | | | |

Torque-speed characteristics

R88M-K7K515(T/C) (7.5 kW)



R88M-K11K015C (11 kW)



R88M-K15K015C (15 kW)



Servo Motor Specifications

Servo motors 1000 r/min rated speed driven with three-phase, 230 V or 460 V servo drive

| Servo drive input voltage | | Three-phase, 230 V | | | Three-phase, 460 V | | | | |
|---------------------------------------|---|---|-----------|-----------|--------------------|-----------|-----------|-----------|---------|
| Applicable servo motor R88M-□ | 20-bit incremental encoder | K90010H-□ | K2K010H-□ | K3K010H-□ | K90010F-□ | K2K010F-□ | K3K010F-□ | | |
| | 17-bit absolute encoder | K90010T-□ | K2K010T-□ | K3K010T-□ | K90010C-□ | K2K010C-□ | K3K010C-□ | K6K010C-□ | |
| Rated output | kW | 0.9 | 2 | 3 | 0.9 | 2 | 3 | 6 | |
| Rated torque | N•m | 8.59 | 19.1 | 28.7 | 8.59 | 19.1 | 28.7 | 57.3 | |
| Instantaneous peak torque | N•m | 19.3 | 47.7 | 71.7 | 19.3 | 47.7 | 71.7 | 143.0 | |
| Rated current | A (rms) | 7.6 | 17 | 22.6 | 3.8 | 8.5 | 11.3 | 19.4 | |
| Instantaneous max. current | A (rms) | 24 | 60 | 80 | 12 | 30 | 40 | 74 | |
| Rated speed | r/min | 1000 | | | | | | | |
| Max. speed | r/min | 2000 | | | | | | | |
| Torque constant | N•m/ A (rms) | 0.86 | 0.88 | 0.96 | 1.72 | 1.76 | 1.92 | 2.08 | |
| Rotor moment of inertia (JM) | kg•m ² ×10 ⁻⁴ (without brake) | 6.7 | 30.3 | 48.4 | 6.7 | 30.3 | 48.4 | 101 | |
| | kg•m ² ×10 ⁻⁴ (with brake) | 7.99 | 31.4 | 49.2 | 7.99 | 31.4 | 49.2 | 107 | |
| Allowable load moment of inertia (JL) | Multiple of (JM) | 10 times the rotor inertia max. | | | | | | | |
| Rated power rate | kW/s (without brake) | 110 | 120 | 170 | 110 | 120 | 170 | 325 | |
| | kW/s (with brake) | 92.4 | 116 | 167 | 92.4 | 116 | 167 | 307 | |
| Allowable radial load | N | 686 | 1176 | 1470 | 686 | 1176 | 1470 | 1764 | |
| Allowable thrust load | N | 196 | 490 | 490 | 196 | 490 | 490 | 588 | |
| Approx. weight | kg (without brake) | 6.7 | 14 | 20 | 6.7 | 14 | 20 | 36.4 | |
| | kg (with brake) | 8.2 | 17.5 | 23.5 | 8.2 | 17.5 | 23.5 | 40.4 | |
| Brake specifications | Rated voltage | 24 VDC±10% | | | | | | | |
| | Holding brake moment of inertia (J) | kg•m ² ×10 ⁻⁴ | 1.35 | 4.7 | 4.7 | 1.35 | 4.7 | 4.7 | 4.7 |
| | Power consumption (at 20°C) | W | 19 | 31 | 34 | 19 | 31 | 34 | 34 |
| | Current consumption (at 20°C) | A | 0.79±10% | 1.3±10% | 1.4±10% | 0.79±10% | 1.3±10% | 1.4±10% | 1.4±10% |
| | Static friction torque | N•m (minimum) | 13.7 | 24.5 | 58.8 | 13.7 | 24.5 | 58.8 | 58.8 |
| | Rise time for holding torque | ms (max.) | 100 | 80 | 150 | 100 | 80 | 150 | 150 |
| | Release time | ms (max.) | 50 | 25 | 50 | 50 | 25 | 50 | 50 |
| Basic specifications | Time rating | Continuous | | | | | | | |
| | Insulation class | Type F | | | | | | | |
| | Ambient operating/storage temperature | 0 to +40 °C/ -20 to 85°C | | | | | | | |
| | Ambient operating/storage humidity (RH) | 20% to 85% (non-condensing) | | | | | | | |
| | Vibration class | V-15 | | | | | | | |
| | Insulation resistance | 20 MΩ min. at 500 VDC between the power terminals and FG terminal | | | | | | | |
| | Enclosure | Totally-enclosed, self-cooling, IP67 (excluding shaft opening and motor and encoder pins) | | | | | | | |
| | Vibration resistance | Vibration acceleration 49 m/s ² | | | | | | | |
| | Mounting | Flange-mounted | | | | | | | |

Torque-speed characteristics

R88M-K90010(H/T/F/C)-□ (900 W)



R88M-K2K010(H/T/F/C)-□ (2 kW)



R88M-K3K010(H/T/F/C)-□ (3 kW)



R88M-K6K010(C)-□ (6 kW)



Servo Motor Specifications

Single-phase, 120 V

| Servo drive type | R88D-K□ | | A5L □ | 01L□ | 02L□ | 04L□ | |
|------------------------|--------------------------------|-----------------------------------|---|---|---------|---------|--|
| Applicable servo motor | R88M-K□ | | 05030H□ | 10030L□ | 20030L□ | 40030L□ | |
| | | | 05030T□ | 10030S□ | 20030S□ | 40030S□ | |
| Basic specifications | Max. Applicable motor capacity | W | 50 | 100 | 200 | 400 | |
| | Continuous output current | A (rms) | 1.2 | 1.7 | 2.5 | 4.6 | |
| | Input power | Main circuit | Single-phase 100 to 120 VAC + 10 to -15% (50/60 Hz) | | | | |
| | Supply | Control circuit | Single-phase 100 to 120 VAC + 10 to -15% (50/60 Hz) | | | | |
| | Control method | | IGBT-driven PWM method, sinusoidal drive | | | | |
| | Feedback | | Serial encoder (incremental/absolute value) | | | | |
| | Conditions | Usage/storage temperature | | 0 to +55 °C / -20 to 65 °C | | | |
| | | Usage/storage humidity | | 90% RH or less (non-condensing) | | | |
| | | Altitude | | 1000 m or less above sea level | | | |
| | | Vibration/shock resistance (max.) | | 5.88 m/s ² 10-60 Hz (Continuous operation at resonance point is not allowed) / 19.6 m/s ² | | | |
| Configuration | | Base mounted | | | | | |
| Approx. weight | Kg | 0.8 | 0.8 | 1.0 | 1.6 | | |

Single-phase, 230 V

| Servo drive type | R88D-K□ | | 01H□ | 02H□ | 04H□ | 08H□ | 10H□ | 15H□ | |
|------------------------|--------------------------------|-----------------------------------|--|---|-------------|-------------|-------------|-------------|--|
| Applicable servo motor | R88M-K□ | | 05030(H/T)□ | 20030(H/T)□ | 40030(H/T)□ | 75030(H/T)□ | 1K020(H/T)□ | 1K030(H/T)□ | |
| | | | 10030(H/T)□ | - | - | - | - | 1K530(H/T)□ | |
| | | | - | - | - | - | - | 1K520(H/T)□ | |
| | | | - | - | - | - | - | 90010(H/T)□ | |
| Basic specifications | Max. Applicable motor capacity | W | 100 | 200 | 400 | 750 | 1000 | 1500 | |
| | Continuous output current | A (rms) | 1.2 | 1.6 | 2.6 | 4.1 | 5.9 | 9.4 | |
| | Input power | Main circuit | Single-phase/3-phase, 200 to 240 VAC + 10 to -15% (50/60 Hz) | | | | | | |
| | Supply | Control circuit | Single-phase, 200 to 240 VAC + 10 to -15% (50/60 Hz) | | | | | | |
| | Control method | | IGBT-driven PWM method, sinusoidal drive | | | | | | |
| | Feedback | | Serial encoder (incremental/absolute value) | | | | | | |
| | Conditions | Usage/storage temperature | | 0 to +55 °C / -20 to 65 °C | | | | | |
| | | Usage/storage humidity | | 90% RH or less (non-condensing) | | | | | |
| | | Altitude | | 1000 m or less above sea level | | | | | |
| | | Vibration/shock resistance (max.) | | 5.88 m/s ² 10-60 Hz (Continuous operation at resonance point is not allowed) / 19.6 m/s ² | | | | | |
| Configuration | | Base mounted | | | | | | | |
| Approx. weight | Kg | 0.8 | 0.8 | 1.1 | 1.6 | 1.8 | 1.8 | | |

Three-phase, 230 V

| Servo drive type | R88D-K□ | | 20H□ | 30H□ | 50H□ | 75H□ | |
|------------------------|--------------------------------|-----------------------------------|--|---|-------------|------------------|--|
| Applicable servo motor | R88M-K□ | | 2K030(H/T)□ | 3K030(H/T)□ | 3K010(H/T)□ | 7K5015T□ | |
| | | | 2K020(H/T)□ | 3K020(H/T)□ | 4K030(H/T)□ | - | |
| | | | - | 2K010(H/T)□ | 4K020(H/T)□ | - | |
| | | | - | - | 5K030(H/T)□ | - | |
| Basic specifications | Max. Applicable motor capacity | W | 2000 | 3000 | 5000 | 7500 | |
| | Continuous output current | A (rms) | 13.4 | 18.7 | 33.0 | 44.0 | |
| | Input power | Main circuit | 3-phase, 200 to 240 VAC + 10 to -15% (50/60 Hz) | | | | |
| | Supply | Control circuit | Single-phase, 200 to 240 VAC + 10 to -15% (50/60 Hz) | | | | |
| | Control method | | IGBT-driven PWM method, sinusoidal drive | | | | |
| | Feedback | | Serial encoder (incremental/absolute value) | | | Absolute encoder | |
| | Conditions | Usage/storage temperature | | 0 to +55 °C / -20 to 65 °C | | | |
| | | Usage/storage humidity | | 90% RH or less (non-condensing) | | | |
| | | Altitude | | 1000 m or less above sea level | | | |
| | | Vibration/shock resistance (max.) | | 5.88 m/s ² 10-60 Hz (Continuous operation at resonance point is not allowed) / 19.6 m/s ² | | | |
| Configuration | | Base mounted | | | | | |
| Approx. weight | Kg | 2.7 | 4.8 | 4.8 | 13.5 | | |

Three-phase, 460 V

| Servo drive type | R88D-K□ | | 06F-□ | 10F-□ | 15F-□ | 20F-□ | 30F-□ | 50F-□ | 75F-□ | 150F-□ | | |
|------------------------|--------------------------------|----------------------------|--|---|--------------|--------------|--------------|--------------|------------------|-----------|--|--|
| Applicable servo motor | R88M-K□ | | 40020(F/C)-□ | 75030(F/C)-□ | 1K030(F/C)-□ | 2K030(F/C)-□ | 3K030(F/C)-□ | 4K030(F/C)-□ | 6K010C-□ | 11K015C-□ | | |
| | | | 60020(F/C)-□ | 1K020(F/C)-□ | 1K530(F/C)-□ | 2K020(F/C)-□ | 3K020(F/C)-□ | 5K030(F/C)-□ | 7K515C-□ | 15K015C-□ | | |
| | | | - | - | 1K520(F/C)-□ | - | 2K010(F/C)-□ | 4K020(F/C)-□ | - | - | | |
| | | | - | - | 90010(F/C)-□ | - | - | 5K020(F/C)-□ | - | - | | |
| | | | - | - | - | - | - | 4K510C-□ | - | - | | |
| | | | - | - | - | - | - | 3K010(F/C)-□ | - | - | | |
| Basic specifications | Max. Applicable motor capacity | kW | 0.6 | 1.0 | 1.5 | 2.0 | 3.0 | 5.0 | 7.5 | 15.0 | | |
| | Continuous output current | A (rms) | 2.9 | 2.9 | 4.7 | 6.7 | 9.4 | 16.5 | 22.0 | 33.4 | | |
| | Input power | Main circuit | 3-phase, 380 to 480 VAC + 10 to -15% (50/60Hz) | | | | | | | | | |
| | Supply | Control circuit | 24 VDC ±15% | | | | | | | | | |
| | Control method | | IGBT-driven PWM method, sinusoidal drive | | | | | | | | | |
| | Feedback | Serial encoder | Incremental or absolute encoder | | | | | | Absolute encoder | | | |
| | Conditions | Usage/storage temperature | | 0 to +55 °C / -20 to 65 °C | | | | | | | | |
| | | Usage/storage humidity | | 90% RH or less (non-condensing) | | | | | | | | |
| | | Altitude | | 1000 m or less above sea level | | | | | | | | |
| | | Vibration/shock resistance | | 5.88 m/s ² 10-60 Hz (Continuous operation at resonance point is not allowed) / 19.6 m/s ² | | | | | | | | |
| Configuration | | Base mounted | | | | | | | | | | |
| Approx. weight | Kg | 1.9 | | | 2.7 | 4.7 | | 13.5 | 21.0 | | | |

Servo Drive Specifications

General specifications (for EtherCAT servo drives)

| | | | | |
|----------------------|------------------------------------|--|--|--|
| Performance | Frequency characteristics | 2 kHz | | |
| EtherCAT interface | Command input | EtherCAT commands (for sequence, motion, data setting/reference, monitor, adjustment, and other commands). | | |
| | Control Mode (*1 Drive Profile) | CSP, CSV, CST, Homing and Position Profile modes (CiA402 Drive Profile) Homing mode; Position profile mode; Dual touch probe function (Latch function); Torque limit function | | |
| I/O signal | Sequence input signal (8 inputs) | Multi-function input x 8 by parameter setting (forward/reverse drive prohibition, emergency stop, external latch, origin proximity, forward/reverse torque limit, general purpose monitor input). | | |
| | Sequence output signal (3 outputs) | 1 x servo drive error output 2 x multi-function outputs by parameters setting (servo ready, brake release, torque limit detection, zero speed detection, warning output, position completion, error clear attributed, programmable output...) | | |
| Integrated functions | USB Communications | Interface | Personal computer/ Connector mini-USB | |
| | | Communications standard | Compliant with USB 2.0 standard | |
| | | Function | Parameter setting, status monitoring and tuning. | |
| | EtherCAT communications | Communications protocol | IEC 61158 Type 12, IEC 61800-7 | |
| | | Physical layer | 100BASE-TX (IEEE802.3) | |
| | | Connectors | RJ45 x 2; ECAT IN: EtherCAT input x 1; ECAT OUT: EtherCAT output x 1 | |
| | | Communications media | Category 5 or higher(cable with double, aluminium tape and braided shielding is recommended). | |
| | | Communications distance | Distance between nodes: 100 m max. | |
| | | LED indicators | RUN x 1; ERR x 1; L/A IN (Link/Activity IN) x 1; L/A OUT (Link/activity OUT) x 1 | |
| | | Autotuning | Automatic motor parameter setting. One parameter rigidity setting. Inertia detection. | |
| | | Dynamic brake (DB) | Built-in and Configurable. Operates during main power OFF, servo alarm, servo OFF or overtravel. | |
| | | Regenerative processing | Internal resistor included in models from 600 W to 15 kW. Regenerative resistor externally mounted (option). | |
| | | Overtravel (OT) prevention function | DB stop, deceleration stop or coast to stop during P-OT, N-OT operation. | |
| | | Encoder divider function | Gear ratio | |
| | | Protective functions | Overcurrent, overvoltage, undervoltage, overspeed, overload, encoder error, overheat... | |
| | | Analog monitor functions for supervision | Analog monitor of motor speed, speed reference, torque reference, command following error, analog input... The monitoring signals to output and their scaling can be specified with parameters. Number of channels: 2 (Output voltage: ±10V DC). | |
| | | Panel operator | Display functions | 2 x digit 7-segment LED display shows the drive status, alarm codes, parameters... |
| | | | Switches | 2 x rotary switches for setting the node address. |
| | | CHARGE lamp | Lights when the main circuit power supply is turned ON. | |
| | | Safety terminal | Functions | Safety Torque OFF function to cut off the motor current and stop the motor. Output signal for failure monitoring function. |
| | Conformed standards | | EN ISO13849-1:2008 (PL- d, Performance Level d), IEC61800-5 -2:2007 (function STO, Safe Torque OFF), EN61508:2001 (Safety Integrity Level 2, SIL2), EN954-1:1996 (CAT3). | |
| | External encoder feedback | Serial signal and line-driver A-B-Z encoder for full-close control. | | |

*1 The CSV, CST and Homing modes are supported in the servo drive with version 2.0 or higher.

General specifications (for MECHATROLINK-II servo drives)

| | | | | |
|----------------------|--|--|--|--|
| Control mode | Position control, velocity control, torque control, full-closed control. | | | |
| Performance | Frequency characteristics | 2 kHz | | |
| | Speed zero clamp | Preset velocity command can be clamped to zero by the speed zero clamp input. | | |
| | Soft start time setting | 0 to 10 s (acceleration, deceleration can be set separately) | | |
| Command input | MECHATROLINK-II communication | MECHATROLINK-II commands (for sequence, motion, data setting/reference, monitor, adjustment and other commands). | | |
| I/O signal | Sequence input signal (8 inputs) | Multi-function input x 8 by parameter setting (forward/reverse drive prohibition, emergency stop, external latch, origin proximity, forward/reverse torque limit, general purpose monitor input). | | |
| | Sequence output signal (3 outputs) | It is possible to output three types of signal form incl.: brake release, servo ready, servo alarm, positioning complete, motor rotation speed detection, torque limit detection, zero speed detection, speed coincidence detection, warning, position command status, speed limit detection, alarm ouput, speed command status. | | |
| Integrated functions | USB Communications | Interface | Personal computer/ Connector mini-USB | |
| | | Communications standard | Compliant with USB 2.0 standard | |
| | | Function | Parameter setting and status monitoring. | |
| | MECHATROLINK-II communications | Communications protocol | MECHATROLINK-II | |
| | | Station address | 41H to 51 FH (max. number of slaves: 30) | |
| | | Transmission speed | 10 Mbps | |
| | | Transmission cycle | 1, 2 & 4 ms | |
| | | Data length | 17-bytes and 32-bytes | |
| | | Automatic load inertia detection | Automatic motor parameter setting. One parameter rigidity setting. | |
| | | Dynamic brake (DB) | Built-in and Configurable. Operates during main power OFF, servo alarm, servo OFF or overtravel. | |
| | | Regenerative processing | Internal resistor included in models from 600 W to 5 kW. Regenerative resistor externally mounted (option). | |
| | | Overtravel (OT) prevention function | DB stop, deceleration stop or coast to stop during P-OT, N-OT operation. | |
| | | Encoder divider function | Optional division possible. | |
| | | Protective functions | Overcurrent, overvoltage, undervoltage, overspeed, overload, encoder error, overheat... | |
| | | Analog monitor functions for supervision | Analog monitor of motor speed, speed reference, torque reference, command following error, analog input... The monitoring signals to output and their scaling can be specified with parameters. Number of channels: 2 (Output voltage: ±10V DC). | |
| | | Panel operator | Display functions | 2-digit 7-segment LED display shows the drive status, alarm codes, parameters... MECHATROLINK-II communications status LED indicator (COM). |
| | | | Switches | 2 x rotary switches for setting the MECHATROLINK-II node address. |
| | | CHARGE lamp | Lights when the main circuit power supply is turned ON. | |
| | | Safety terminal | Functions | Safety Torque OFF function to cut off the motor current and stop the motor. Output signal for failure monitoring function. |
| | | | Conformed standards | EN ISO13849-1:2008 (PL- d, Performance Level d), IEC61800-5 -2:2007 (function STO, Safe Torque OFF), EN61508:2001 (Safety Integrity Level 2, SIL2), EN954-1:1996 (CAT3). |
| | External encoder feedback | Serial signal and line-driver A-B-Z encoder for full-close control. | | |

Servo Drive Specifications

General specifications (for Analog/Pulse servo drives)

| | | | |
|---|---|---|--|
| Control mode | | | 7 modes selectable by parameter: (1) position control, (2) velocity control, (3) torque control, (4) position/velocity control, (5) position/torque control, (6) velocity/torque control and (7) full-closed control. |
| Speed/ torque control | Performance | | Frequency characteristics 2 kHz |
| | | | Speed zero clamp Preset velocity command can be clamped to zero by the speed zero clamp input. |
| | | | Soft start time setting 0 to 10 s (acceleration, deceleration can be set separately). S-curve acceleration/deceleration is also available. |
| | Input signal | Speed control | Speed reference voltage 6 VDC at rated speed: set at delivery (the scale and polarity can be set by parameters). |
| | | | Torque limit 3 VDC at rated torque (torque can be limited separately in positive/negative direction). |
| | | | Preset speed control Preset speed is selectable from 8 internal settings by digital inputs. |
| | | Torque reference voltage 3 VDC at rated torque: set at delivery (the scale and polarity can be set by parameters). | |
| | | Speed limit Speed limit can be set by parameter. | |
| Position control | Input signal | Command pulse | Input pulse type Sign + pulse train, 90° phase displacement 2-phase pulse (A-phase+ B-phase) or CCW/CW pulse train. |
| | | | Input pulse frequency 4 Mpps max. (200 Kpps max. at open collector). |
| | | | Command pulse scaling (Electronic Gear) Applicable scaling ratio: 1/1000 - 1000 Any value of 1-20 ²⁰ can be set for numerator (encoder resolution) and denominator (command pulse resolution per motor revolution). The combination has to be within the range shown above. |
| Full-closed control | Input signal | Command pulse | Input pulse type Sign + pulse train, 90° phase displacement 2-phase pulse (A-phase+ B-phase) or CCW/CW pulse train. |
| | | | Input pulse frequency 4 Mpps max. (200 Kpps max. at open collector). |
| | | | Command pulse scaling (Electronic Gear) Applicable scaling ratio: 1/1000 - 1000 Any value of 1-20 ²⁰ can be set for numerator (encoder resolution) and denominator (command pulse resolution). The combination has to be within the range shown above. |
| | External encoder scaling Applicable scaling ratio: 1/20 - 160 Any value of 1-20 ²⁰ can be set for numerator (encoder resolution) and denominator (external encoder resolution per motor revolution). The combination has to be within the range shown above. | | |
| I/O signal | Position signal output A-phase, B-phase, Z-phase line driver output and Z-phase open-collector output. | | |
| | Sequence input signal (10 inputs) Multi-function input x 10 by parameter setting (servo ON, control mode switching, forward/reverse drive prohibition, vibration filter switching, gain switching, electronic gear switching, error counter reset, pulse prohibition, alarm reset, internal speed selection, torque limit switching, zero speed, emergency stop, inertia ratio switching, velocity/torque command sign). Dedicated input x 1 (SEN: sensor ON, ABS data request). | | |
| | Sequence output signal (4 outputs) It is possible to output four types of signal form incl.: brake release, servo ready, servo alarm, positioning complete, motor rotation speed detection, torque limit detection, zero speed detection, speed coincidence detection, warning, position command status, speed limit detection, speed command status. | | |
| Integrated functions | USB Communications | Interface Personal computer/ Connector mini-USB | |
| | | Communications standard Compliant with USB 2.0 standard | |
| | | Function Parameter setting and status monitoring | |
| | Automatic load inertia detection Automatic motor parameter setting. One parameter rigidity setting. | | |
| | Dynamic brake (DB) Built-in and Configurable. Operates during main power OFF, servo alarm, servo OFF or overtravel. | | |
| | Regenerative processing Internal resistor included in models from 600 W to 15 kW. Regenerative resistor externally mounted (option). | | |
| | Overtravel (OT) prevention function DB stop, deceleration stop or coast to stop during P-OT, N-OT operation | | |
| | Encoder divider function Optional division possible | | |
| | Electronic gearing (Numerator/Denominator) Up to 4 electronic gear numerators by combining with inputs. | | |
| | Internal speed setting function 8 speeds may be set internally | | |
| | Protective functions Overcurrent, overvoltage, undervoltage, overspeed, overload, encoder error, overheat... | | |
| | Analog monitor functions for supervision Analog monitor of motor speed, speed reference, torque reference, command following error, analog input... The monitoring signals to output and their scaling can be specified by parameters. Number of channels: 2 (Output voltage: ±10V DC) | | |
| | Panel operator | Display functions 6-digit 7-segment LED display shows the drive status, alarm codes, parameters... | |
| | | Switches Used to set/monitor parameters and drive condition (5 key switches). | |
| | CHARGE lamp Lights when the main circuit power supply is turned ON. | | |
| | Safety terminal | Functions Safety torque OFF function to cut off the motor current and stop the motor. Output signal for failure monitoring function. | |
| | | Conformed standards EN ISO13849-1:2008 (PL- d, Performance Level d), IEC61800-5 -2:2007 (function STO, Safe Torque OFF), EN61508:2001 (Safety Integrity Level 2, SIL2), EN954-1:1996 (CAT3). | |
| External encoder feedback Serial signal and line-driver A-B-Z encoder for full-close control | | | |
| Expansion connector Serial bus for option board | | | |

Servo Drive Part Names



EtherCAT servo drives



MECHATROLINK-II servo drives



Analog/pulse servo drives

Note: the above pictures show 230 V servo drives models only. The 460 V servo drives have 24 VDC power input terminals for control circuit instead of L1C and L2C terminals.

Dimensions

SERVO MOTORS

Type 3000 r/min motors (120 V, 100 W and 230 V, 50 - 100 W)



| Dimensions (mm) | Without brake | | With brake | | LN | Shaft End Dimensions | | Approx. Weight (kg) | |
|--------------------------|---------------|----|------------|----|----|----------------------|---------------|---------------------|--|
| | LL | LM | LL | LM | | Tap x Depth | Without brake | With brake | |
| R88M-K05030(H/T)-□S2 | 72 | 48 | 102 | 78 | 23 | M3 x 6L | 0.32 | 0.53 | |
| R88M-K10030(L/S/H/T)-□S2 | 92 | 68 | 122 | 98 | 43 | | 0.47 | 0.68 | |

Type 3000 r/min motors (120 V, 200 - 400 W and 230 V, 200 - 750 W)



| Dimensions (mm) | Without brake | | With brake | | LR | Flange surface | | | | | | Shaft End Dimensions | | | | | | Approx. Weight (kg) | | |
|----------------------|---------------|------|------------|-------|----|------------------|----|----|----|-----|-----|----------------------|----|------|------|-----------------|---|---------------------|---------------|------------|
| | LL | LM | LL | LM | | LB | LC | LD | LE | LG | LZ | S | K | QK | H | B | T | Tap x Depth | Without brake | With brake |
| R88M-K20030(H/T)-□S2 | 79.5 | 56.5 | 116 | 93 | 30 | 50 ^{h7} | 60 | 70 | 3 | 6.5 | 4.5 | 11 ^{h6} | 20 | 18 | 8.5 | 4 ^{h9} | 4 | M4x8L | 0.82 | 1.3 |
| R88M-K20030(L/S)-□S2 | 79.5 | 56.5 | 116 | 93 | 30 | 50 ^{h7} | 60 | 70 | 3 | 6.5 | 4.5 | 11 ^{h6} | 20 | 18 | 8.5 | 4 ^{h9} | 4 | M4x8L | 0.78 | 1.2 |
| R88M-K40030(H/T)-□S2 | 99 | 76 | 135.5 | 112.5 | 30 | 50 ^{h7} | 60 | 70 | 3 | 6.5 | 4.5 | 14 ^{h6} | 25 | 22.5 | 11 | 5 ^{h9} | 5 | M5x10L | 1.2 | 1.7 |
| R88M-K40030(L/S)-□S2 | 99 | 76 | 135.5 | 112.5 | 30 | 50 ^{h7} | 60 | 70 | 3 | 6.5 | 4.5 | 14 ^{h6} | 25 | 22.5 | 11 | 5 ^{h9} | 5 | M5x10L | 1.2 | 1.6 |
| R88M-K75030(H/T)-□S2 | 112.2 | 86 | 148.2 | 122.2 | 35 | 70 ^{h7} | 80 | 90 | 3 | 8 | 6 | 19 ^{h6} | 25 | 22 | 15.5 | 6 ^{h9} | 6 | M5x10L | 2.3 | 3.1 |

Type 3000 r/min motors (230 V, 1 - 5 kW)



| Model | Without brake | | | | | With brake | | | | | Flange surface | | | | | | Shaft End Dimensions | | | | | | Approx. Weight (kg) | | | |
|----------------|---------------|-------|-------|-------|-----|------------|-------|-------|-------|-----|----------------|-----|-------------------|-----|-----|----|----------------------|------------------|-------------|----|----|------|---------------------|---|---------------|------------|
| | LL | LM | KB1 | KB2 | KL1 | LL | LM | KB1 | KB2 | KL1 | LR | LA | LB | LC | LD | LE | LG | S | Tap x Depth | K | QK | H | B | T | Without brake | With brake |
| 1K030(H/T)-□S2 | 141 | 97 | 66 | 119 | 101 | 168 | 124 | 66 | 146 | 101 | 55 | 135 | 95 ^{h7} | 100 | 115 | 3 | 10 | 19 ^{h6} | M5 x 12L | 45 | 42 | 15.5 | 6 ^{h9} | 6 | 3.5 | 4.5 |
| 1K530(H/T)-□S2 | 159.5 | 115.5 | 84.5 | 137.5 | 101 | 186.5 | 142.5 | 84.5 | 164.5 | 101 | 55 | 135 | 95 ^{h7} | 100 | 115 | 3 | 10 | 19 ^{h6} | M5 x 12L | 45 | 42 | 15.5 | 6 ^{h9} | 6 | 4.4 | 5.4 |
| 2K030(H/T)-□S2 | 178.5 | 134.5 | 103.5 | 156.5 | 101 | 205.5 | 161.5 | 103.5 | 183.5 | 101 | 55 | 135 | 95 ^{h7} | 100 | 115 | 3 | 10 | 19 ^{h6} | M5 x 12L | 45 | 42 | 15.5 | 6 ^{h9} | 6 | 5.3 | 6.3 |
| 3K030(H/T)-□S2 | 190 | 146 | 112 | 168 | 113 | 215 | 171 | 112 | 193 | 113 | 55 | 162 | 110 ^{h7} | 120 | 145 | 3 | 12 | 22 ^{h6} | M5 x 12L | 45 | 41 | 18 | 8 ^{h9} | 7 | 8.3 | 9.4 |
| 4K030(H/T)-□S2 | 208 | 164 | 127 | 186 | 118 | 233 | 189 | 127 | 211 | 118 | 65 | 145 | 110 ^{h7} | 130 | 165 | 6 | 12 | 24 ^{h6} | M8 x 20L | 55 | 51 | 20 | 8 ^{h9} | 7 | 11.0 | 12.6 |
| 5K030(H/T)-□S2 | 243 | 199 | 162 | 221 | 118 | 268 | 224 | 162 | 246 | 118 | 65 | 145 | 110 ^{h7} | 130 | 165 | 6 | 12 | 24 ^{h6} | M8 x 20L | 55 | 51 | 20 | 8 ^{h9} | 7 | 14.0 | 16.0 |

Dimensions

SERVO MOTORS

Type 3000 r/min motors (460 V, 750 W - 5 kW)



| Model | Without brake | | | | | With brake | | | | | Flange surface | | | | | | Shaft End Dimensions | | | | | | Approx. Weight (kg) | | | |
|----------------|---------------|-------|-------|-------|-----|------------|-------|-------|-------|-----|----------------|-----|-------------------|-----|-----|----|----------------------|------------------|-------------|----|----|------|---------------------|---|---------------|------------|
| | LL | LM | KB1 | KB2 | KL1 | LL | LM | KB1 | KB2 | KL1 | LR | LA | LB | LC | LD | LE | LG | S | Tap x Depth | K | QK | H | B | T | Without brake | With brake |
| 75030(F/C)-□S2 | 131.5 | 87.5 | 56.5 | 109.5 | 101 | 158.5 | 114.5 | 53.5 | 136.5 | 103 | 55 | 135 | 95 ^{h7} | 100 | 115 | 3 | 10 | 19 ^{h6} | M5 x 12L | 45 | 42 | 15.5 | 6 ^{h9} | 6 | 3.1 | 4.1 |
| 1K030(F/C)-□S2 | 141 | 97 | 66 | 119 | 101 | 168 | 124 | 66 | 146 | 101 | 55 | 135 | 95 ^{h7} | 100 | 115 | 3 | 10 | 19 ^{h6} | M5 x 12L | 45 | 42 | 15.5 | 6 ^{h9} | 6 | 3.5 | 4.5 |
| 1K530(F/C)-□S2 | 159.5 | 115.5 | 84.5 | 137.5 | 101 | 186.5 | 142.5 | 84.5 | 164.5 | 101 | 55 | 135 | 95 ^{h7} | 100 | 115 | 3 | 10 | 19 ^{h6} | M5 x 12L | 45 | 42 | 15.5 | 6 ^{h9} | 6 | 4.4 | 5.4 |
| 2K030(F/C)-□S2 | 178.5 | 134.5 | 103.5 | 156.5 | 101 | 205.5 | 161.5 | 103.5 | 183.5 | 101 | 55 | 135 | 95 ^{h7} | 100 | 115 | 3 | 10 | 19 ^{h6} | M5 x 12L | 45 | 42 | 15.5 | 6 ^{h9} | 6 | 5.3 | 6.3 |
| 3K030(F/C)-□S2 | 190 | 146 | 112 | 168 | 113 | 215 | 171 | 112 | 193 | 113 | 55 | 162 | 110 ^{h7} | 120 | 145 | 3 | 12 | 22 ^{h6} | M5 x 12L | 45 | 41 | 18 | 8 ^{h9} | 7 | 8.3 | 9.4 |
| 4K030(F/C)-□S2 | 208 | 164 | 127 | 186 | 118 | 233 | 189 | 127 | 211 | 118 | 65 | 145 | 110 ^{h7} | 130 | 165 | 6 | 12 | 24 ^{h6} | M8 x 20L | 55 | 51 | 20 | 8 ^{h9} | 7 | 11.0 | 12.6 |
| 5K030(F/C)-□S2 | 243 | 199 | 162 | 221 | 118 | 268 | 224 | 162 | 246 | 118 | 65 | 145 | 110 ^{h7} | 130 | 165 | 6 | 12 | 24 ^{h6} | M8 x 20L | 55 | 51 | 20 | 8 ^{h9} | 7 | 14.0 | 16.0 |

Type 2000 r/min motors



230 V, 1 kW - 5 kW

| Model | Without brake | | | | | With brake | | | | | Flange surface | | | | | | Shaft End Dimensions | | | | | | Approx. Weight (kg) | | | | |
|----------------|---------------|-------|------|-------|-----|------------|-------|------|-------|-----|----------------|-----|---------------------|-----|-----|-----|----------------------|------|------------------|-------------|----|----|---------------------|------------------|---|---------------|------------|
| | LL | LM | KB1 | KB2 | KL1 | LL | LM | KB1 | KB2 | KL1 | LR | LA | LB | LC | LD | LE | LG | LZ | S | Tap x Depth | K | QK | H | B | T | Without brake | With brake |
| 1K020(H/T)-□S2 | 138 | 94 | 60 | 116 | 116 | 163 | 119 | 60 | 141 | 116 | 55 | 145 | 110 ^{h7} | 130 | 165 | 6 | 12 | 9 | 22 ^{h6} | M5 x 12L | 45 | 41 | 18 | 8 ^{h9} | 7 | 5.2 | 6.7 |
| 1K520(H/T)-□S2 | 155.5 | 111.5 | 77.5 | 133.5 | 116 | 180.5 | 136.5 | 77.5 | 158.5 | 116 | 55 | 145 | 110 ^{h7} | 130 | 165 | 6 | 12 | 9 | 22 ^{h6} | M5 x 12L | 45 | 41 | 18 | 8 ^{h9} | 7 | 6.7 | 8.2 |
| 2K020(H/T)-□S2 | 173 | 129 | 95 | 151 | 116 | 198 | 154 | 95 | 176 | 116 | 55 | 145 | 110 ^{h7} | 130 | 165 | 6 | 12 | 9 | 22 ^{h6} | M5 x 12L | 45 | 41 | 18 | 8 ^{h9} | 7 | 8.0 | 9.5 |
| 3K020(H/T)-□S2 | 208 | 164 | 127 | 186 | 118 | 233 | 189 | 127 | 211 | 118 | 65 | 145 | 110 ^{h7} | 130 | 165 | 6 | 12 | 9 | 24 ^{h6} | M8 x 20L | 55 | 51 | 20 | 8 ^{h9} | 7 | 11.0 | 12.6 |
| 4K020(H/T)-□S2 | 177 | 133 | 96 | 155 | 140 | 202 | 158 | 96 | 180 | 140 | 70 | 233 | 114.3 ^{h7} | 176 | 200 | 3.2 | 18 | 13.5 | 35 ^{h6} | M12 x 25L | 55 | 50 | 30 | 10 ^{h9} | 8 | 15.5 | 18.7 |
| 5K020(H/T)-□S2 | 202 | 158 | 96 | 180 | 140 | 221 | 177 | 115 | 199 | 140 | 70 | 233 | 114.3 ^{h7} | 176 | 200 | 3.2 | 18 | 13.5 | 35 ^{h6} | M12 x 25L | 55 | 51 | 30 | 10 ^{h9} | 8 | 18.6 | 21.8 |

460 V, 400 W - 5 kW

| Model | Without brake | | | | | With brake | | | | | Flange surface | | | | | | Shaft End Dimensions | | | | | | Approx. Weight (kg) | | | | |
|----------------|---------------|-------|------|-------|-----|------------|-------|------|-------|-----|----------------|-----|---------------------|-----|-----|-----|----------------------|------|------------------|-------------|----|----|---------------------|------------------|---|---------------|------------|
| | LL | LM | KB1 | KB2 | KL1 | LL | LM | KB1 | KB2 | KL1 | LR | LA | LB | LC | LD | LE | LG | LZ | S | Tap x Depth | K | QK | H | B | T | Without brake | With brake |
| 40020(F/O)-□S2 | 131.5 | 87.5 | 56.5 | 109.5 | 101 | 158.5 | 114.5 | 53.5 | 136.5 | 103 | 55 | 135 | 95 ^{h7} | 100 | 115 | 3 | 10 | 9 | 19 ^{h6} | M5 x 12L | 45 | 42 | 15.5 | 6 ^{h9} | 6 | 3.1 | 4.1 |
| 60020(F/O)-□S2 | 141 | 97 | 66 | 119 | 101 | 168 | 124 | 63 | 146 | 103 | 55 | 135 | 95 ^{h7} | 100 | 115 | 3 | 10 | 9 | 19 ^{h6} | M5 x 12L | 45 | 42 | 15.5 | 6 ^{h9} | 6 | 3.5 | 4.5 |
| 1K020(F/C)-□S2 | 138 | 94 | 60 | 116 | 116 | 163 | 119 | 60 | 141 | 116 | 55 | 145 | 110 ^{h7} | 130 | 165 | 6 | 12 | 9 | 22 ^{h6} | M5 x 12L | 45 | 41 | 18 | 8 ^{h9} | 7 | 5.2 | 6.7 |
| 1K520(F/C)-□S2 | 155.5 | 111.5 | 77.5 | 133.5 | 116 | 180.5 | 136.5 | 77.5 | 158.5 | 116 | 55 | 145 | 110 ^{h7} | 130 | 165 | 6 | 12 | 9 | 22 ^{h6} | M5 x 12L | 45 | 41 | 18 | 8 ^{h9} | 7 | 6.7 | 8.2 |
| 2K020(F/C)-□S2 | 173 | 129 | 95 | 151 | 116 | 198 | 154 | 95 | 176 | 116 | 55 | 145 | 110 ^{h7} | 130 | 165 | 6 | 12 | 9 | 22 ^{h6} | M5 x 12L | 45 | 41 | 18 | 8 ^{h9} | 7 | 8.0 | 9.5 |
| 3K020(F/C)-□S2 | 208 | 164 | 127 | 186 | 118 | 233 | 189 | 127 | 211 | 118 | 65 | 145 | 110 ^{h7} | 130 | 165 | 6 | 12 | 9 | 24 ^{h6} | M8 x 20L | 55 | 51 | 20 | 8 ^{h9} | 7 | 11.0 | 12.6 |
| 4K020(F/C)-□S2 | 177 | 133 | 96 | 155 | 140 | 202 | 158 | 96 | 180 | 140 | 70 | 233 | 114.3 ^{h7} | 176 | 200 | 3.2 | 18 | 13.5 | 35 ^{h6} | M12 x 25L | 55 | 50 | 30 | 10 ^{h9} | 8 | 15.5 | 18.7 |
| 5K020(F/C)-□S2 | 202 | 158 | 96 | 180 | 140 | 221 | 177 | 115 | 199 | 140 | 70 | 233 | 114.3 ^{h7} | 176 | 200 | 3.2 | 18 | 13.5 | 35 ^{h6} | M12 x 25L | 55 | 51 | 30 | 10 ^{h9} | 8 | 18.6 | 21.8 |

Dimensions

SERVO MOTORS

Type 1500 r/min motors (230 V or 460 V, 7.5kW)

| Dimensions (mm) | | Without brake | | | | | | With brake | | | | | | Approx. Mass (Kg) | | |
|-----------------|-----|---------------|-----|-----|-------|-------|-----|------------|-----|-----|-----|-------|-------|-------------------|---------------|------------|
| Model | LL | LM | KB1 | KB2 | L1 | L2 | L3 | LL | LM | KB1 | KB2 | L1 | L2 | L3 | Without brake | With brake |
| R88M-K□ | | | | | | | | | | | | | | | | |
| 7K515T-□S2 | 312 | 268 | 219 | 290 | 117.5 | 117.5 | 149 | 337 | 293 | 253 | 315 | 117.5 | 152.5 | 183 | 36.4 | 40.4 |
| 7K515C-□S2 | 312 | 268 | 219 | 290 | 117.5 | 117.5 | 149 | 337 | 293 | 253 | 315 | 117.5 | 152.5 | 183 | 36.4 | 40.4 |



Type 1500 r/min motors (460 V, 11 - 15 kW)

| Dimensions (mm) | | Without brake | | | | | | With brake | | | | | | Approx. Mass (Kg) | | |
|-----------------|-----|---------------|-----|-----|-------|-------|-----|------------|-----|-----|-----|-------|-------|-------------------|---------------|------------|
| Model | LL | LM | KB1 | KB2 | L1 | L2 | L3 | LL | LM | KB1 | KB2 | L1 | L2 | L3 | Without brake | With brake |
| R88M-K□ | | | | | | | | | | | | | | | | |
| 11K015C-□S2 | 316 | 272 | 232 | 294 | 124.5 | 124.5 | 162 | 364 | 320 | 266 | 342 | 124.5 | 159.5 | 196 | 52.7 | 58.9 |
| 15K015C-□S2 | 384 | 340 | 300 | 362 | 158.5 | 239 | 230 | 432 | 388 | 334 | 410 | 158.5 | 193.5 | 264 | 70.2 | 76.3 |



Type 1000 r/min motors (230 V, 900W - 3 kW/ 460 V, 900W - 3 kW)

| Dimensions (mm) | | Without brake | | | | | With brake | | | | | LR | Flange surface | | | | | | | Shaft End Dimensions | | | | | Approx. Mass (Kg) | | | |
|--------------------|-------|---------------|-------|-------|-----|-------|------------|-------|-------|-----|----|-----|---------------------|-----|-----|-----|----|------|------------------|----------------------|----|----|----|------------------|-------------------|---------------|------------|--|
| Model | LL | LM | KB1 | KB2 | KL1 | LL | LM | KB1 | KB2 | KL1 | LA | | LB | LC | LD | LE | LG | LZ | S | Tap x Depth | K | Q | H | B | T | Without brake | With brake | |
| R88M-K□ | | | | | | | | | | | | | | | | | | | | | | | | | | | | |
| 230 90010(H/T)-□S2 | 155.5 | 111.5 | 77.5 | 133.5 | 116 | 180.5 | 136.5 | 77.5 | 158.5 | 116 | 55 | 165 | 110 ^{h7} | 130 | 145 | 6 | 12 | 9 | 22 ^{m6} | M5x 12L | 45 | 41 | 18 | 8 ^{h9} | 7 | 6.7 | 8.2 | |
| 2K010(H/T)-□S2 | 163.5 | 119.5 | 82.2 | 141.5 | 140 | 209.5 | 165.5 | 128.5 | 187.5 | 140 | 80 | 233 | 114.3 ^{h7} | 176 | 200 | 3.2 | 18 | 13.5 | 35 ^{m6} | M12x 25L | 55 | 50 | 30 | 10 ^{h9} | 8 | 14 | 20 | |
| 3K010(H/T)-□S2 | 208 | 164 | 127 | 186 | | 234.5 | 190.5 | | 212.5 | | | | | | | | | | | | | | | | | | | |
| 400 90010(F/C)-□S2 | 155.5 | 111.5 | 77.5 | 133.5 | 116 | 180.5 | 136.5 | 74.5 | 158.5 | 118 | 55 | 165 | 110 ^{h7} | 130 | 145 | 6 | 12 | 9 | 22 ^{m6} | M5x 10L | 45 | 41 | 18 | 8 ^{h9} | 7 | 6.7 | 8.2 | |
| 2K010(F/C)-□S2 | 163.5 | 119.5 | 82.5 | 141.5 | 140 | 188.5 | 144.5 | 82.5 | 166.5 | 140 | 80 | 233 | 114.3 ^{h7} | 176 | 200 | 3.2 | 18 | 13.5 | 35 ^{m6} | M12x 25L | 55 | 50 | 30 | 10 ^{h9} | 8 | 14 | 17.5 | |
| 3K010(F/C)-□S2 | 209.5 | 165.5 | 128.5 | 187.5 | | 234.5 | 190.5 | 128.5 | 212.5 | | | | | | | | | | | | | | | | | | | |

Servo Motor Specifications



Type 1000 r/min motors (460 V, 4.5 kW)

| Dimensions (mm) | Without brake | | | | | | With brake | | | | | | Approx. Mass (Kg) | |
|-----------------|---------------|-----|-----|-----|----|----|------------|-----|-----|-----|----|-----|-------------------|------------|
| | LL | LM | KB1 | KB2 | L1 | L2 | LL | LM | KB1 | KB2 | L1 | L2 | Without brake | With brake |
| R88M-K□ | | | | | | | | | | | | | | |
| 4K510C-□S2 | 266 | 222 | 185 | 244 | 98 | 98 | 291 | 247 | 185 | 269 | 98 | 133 | 29.4 | 33.3 |



Type 1000 r/min motors (460 V, 6 kW)

| Dimensions (mm) | Without brake | | | | | | | With brake | | | | | | Approx. Mass (Kg) | | |
|-----------------|---------------|-----|-----|-----|-------|-------|-----|------------|-----|-----|-----|-------|-------|-------------------|---------------|------------|
| | LL | LM | KB1 | KB2 | L1 | L2 | L3 | LL | LM | KB1 | KB2 | L1 | L2 | L3 | Without brake | With brake |
| R88M-K□ | | | | | | | | | | | | | | | | |
| 6K010C-□S2 | 312 | 268 | 219 | 290 | 117.5 | 117.5 | 149 | 337 | 293 | 253 | 315 | 117.5 | 152.5 | 183 | 36.4 | 40.4 |



Dimensions

SERVO DRIVES

R88D-KTA5L/01L, R88D-KNA5L/01L-□ (120 V, 50 - 100W)

R88D-KT01H/02H, R88D-KN01H/02H-□ (230 V, 100 - 200W)



R88D-KT02L, R88D-KN02L-□ (120 V, 200 W)

R88D-KT04H, R88D-KN04H-□ (230 V, 400 W)



R88D-KT04L, R88D-KN04L-□ (120 V, 400 W)

R88D-KT08H, R88D-KN08H-□ (230 V, 750 W)



Dimensions

SERVO DRIVES

**R88D-KT10H/15H,
R88D-KN10H/15H-□**
(230 V, 1 - 1.5 kW)



**R88D-KT20H,
R88D-KN20H-□** (230 V, 2 kW)



**R88D-KT30H/50H,
R88D-KN30H/50H-□**
(230 V, 3 - 5 kW)



**R88D-KT06F/10F/15F,
R88D-KN06F/10F/15F-□**
(460 V, 600 W - 1.5 kW)



Dimensions

SERVO DRIVES

R88D-KT20F, R88D-KN20F-□ (460 V, 2 kW)



R88D-KT30F/50F, R88D-KN30F/50F-□ (460 V, 3 - 5 kW)



R88D-KT75H, R88D-KN75H-ECT (230 V, 7.5 kW)

R88D-KT75F, R88D-KN75F-ECT (460 V, 7.5 kW)



Dimensions

SERVO DRIVES

R88D-KT150F, R88D-KN150F-ECT (460 V, 15 kW)



Filters

| Filter Model | External dimensions | | | Mount dimensions | |
|----------------|---------------------|-----|----|------------------|-----|
| | H | W | D | M1 | M2 |
| R88A-FIK102-RE | 190 | 42 | 44 | 180 | 20 |
| R88A-FIK104-RE | 190 | 57 | 30 | 180 | 30 |
| R88A-FIK107-RE | 190 | 64 | 35 | 180 | 40 |
| R88A-FIK114-RE | 190 | 86 | 35 | 180 | 60 |
| R88A-FIK222-RE | 291 | 130 | 45 | 278 | 100 |
| R88A-FIK304-RE | 196 | 92 | 40 | 186 | 70 |
| R88A-FIK306-RE | 238 | 94 | 40 | 228 | 70 |
| R88A-FIK312-RE | 291 | 130 | 40 | 278 | 100 |
| R88A-FIK330-RE | 305 | 233 | 50 | 288 | 180 |
| R88A-FIK350-RE | 506 | 261 | 52 | 491 | 200 |



Installation

Single-phase, 120 VAC (for EtherCAT and MECHATROLINK-II servo drives)



*1 For servo drives from 400 W, B2 and B3 are short-circuited. If the internal regenerative resistor is insufficient, remove the wire between B2 and B3 and connect an external regenerative resistor between B1 and B2.
 *2 For use only with an absolute encoder. If a backup battery is connected to CN1 I/O connector, an encoder cable with a battery is not required.
 *3 Wiring diagram example using the G9SX safety unit. If a safety unit is not used, keep the factory safety bypass connector installed in the CN8.

Note: The input function of pins 5 and 7 to 13, and output function of pins 1, 2, 25 and 26, can be changed via parameter settings.

Installation

Single-phase, 230 VAC (for EtherCAT and MECHATROLINK-II servo drives)



*1 For servo drives from 750 W, B2 and B3 are short-circuited. If the internal regenerative resistor is insufficient, remove the wire between B2 and B3 and connect an external regenerative resistor between B1 and B2.

*2 For use only with an absolute encoder. If a backup battery is connected to CN1 I/O connector, an encoder cable with a battery is not required.

*3 Wiring diagram example using the G9SX safety unit. If a safety unit is not used, keep the factory safety bypass connector installed in the CN8.

Note: The input function of pins 5 and 7 to 13, and output function of pins 1, 2, 25 and 26, can be changed via parameter settings.

Installation

Three-phase, 230 VAC (for EtherCAT and MECHATROLINK-II servo drives)



*1 For servo drives from 750 W, B2 and B3 are short-circuited. If the internal regenerative resistor is insufficient, remove the wire between B2 and B3 and connect an external regenerative resistor between B1 and B2.

*2 For use only with an absolute encoder. If a backup battery is connected to CN1 I/O connector, an encoder cable with a battery is not required.

*3 Wiring diagram example using the G9SX safety unit. If a safety unit is not used, keep the factory safety bypass connector installed in the CNB.

Note: The input function of pins 5 and 7 to 13, and output function of pins 1, 2, 25 and 26, can be changed via parameter settings.

Installation

Three-phase, 460 VAC (for EtherCAT and MECHATROLINK-II servo drives)



*1 For servo drives from 750 W, B2 and B3 are short-circuited. If the internal regenerative resistor is insufficient, remove the wire between B2 and B3 and connect an external regenerative resistor between B1 and B2.

*2 For use only with an absolute encoder. If a backup battery is connected to CN1 I/O connector, an encoder cable with a battery is not required.

*3 Wiring diagram example using the G9SX safety unit. If a safety unit is not used, keep the factory safety bypass connector installed in the CN8.

Note: The input function of pins 5 and 7 to 13, and output function of pins 1, 2, 25 and 26, can be changed via parameter settings.

Installation

Single-phase, 120 VAC (for Analog/Pulse servo drives)



*1 For servo drives from 400 W, B2 and B3 are short-circuited. If the internal regenerative resistor is insufficient, remove the wire between B2 and B3 and connect an external regenerative resistor between B1 and B2.
 *2 For use only with an absolute encoder. If a backup battery is connected to CN1 I/O connector, an encoder cable with a battery is not required.
 *3 Only available in Position control mode.
 *4 The input function depends on control mode used (Position, speed or torque control).
 *5 Wiring diagram example using the G9SX safety unit. If a safety unit is not used, keep the factory safety bypass connector installed in the CN8.
 Note: The input function of pins 8, 9 and 26 to 33, and output function of pins 10, 11, 34, 35, 38 and 39, can be changed via parameter settings.

Installation

Single-phase, 230 VAC (for Analog/Pulse servo drives)



*1 For servo drives from 750 W, B2 and B3 are short-circuited. If the internal regenerative resistor is insufficient, remove the wire between B2 and B3 and connect an external regenerative resistor between B1 and B2.
 *2 For use only with an absolute encoder. If a backup battery is connected to CN1 I/O connector, an encoder cable with a battery is not required.
 *3 Only available in Position control mode.
 *4 The input function depends on control mode used (Position, speed or torque control).
 *5 Wiring diagram example using the G9SX safety unit. If a safety unit is not used, keep the factory safety bypass connector installed in the CN8.
 Note: The input function of pins 8, 9 and 26 to 33, and output function of pins 10, 11, 34, 35, 38 and 39, can be changed via parameter settings.

Installation

Three-phase, 230 VAC (for Analog/Pulse servo drives)



*1 For servo drives from 750 W, B2 and B3 are short-circuited. If the internal regenerative resistor is insufficient, remove the wire between B2 and B3 and connect an external regenerative resistor between B1 and B2.
 *2 For use only with an absolute encoder. If a backup battery is connected to CN1 I/O connector, an encoder cable with a battery is not required.
 *3 Only available in Position control mode.
 *4 The input function depends on control mode used (Position, speed or torque control).
 *5 Wiring diagram example using the G9SX safety unit. If a safety unit is not used, keep the factory safety bypass connector installed in the CN8.
 Note: The input function of pins 8, 9 and 26 to 33, and output function of pins 10, 11, 34, 35, 38 and 39, can be changed via parameter settings.

Installation

Three-phase, 460 VAC (for Analog/Pulse servo drives)



*1 Normally B2 and B3 are short-circuited. If the internal regenerative resistor is insufficient, remove the wire between B2 and B3 and connect an external regenerative resistor between B1 and B2.

*2 For use only with an absolute encoder. If a backup battery is connected to CN1 I/O connector, an encoder cable with a battery is not required.

*3 Only available in Position control mode.

*4 The input function depends on control mode used (Position, speed or torque control).

*5 Wiring diagram example using the G9SX safety unit. If a safety unit is not used, keep the factory safety bypass connector installed in the CN8.

Note: The input function of pins 8, 9 and 26 to 33, and output function of pins 10, 11, 34, 35, 38 and 39, can be changed via parameter settings.

Ordering Information

Accurax G5 Servo System configuration



Note: The symbols ①②③... show the recommended sequence to select the servo motor and cables

Servo motor ① Select motor from R88M-K family using motor tables in next pages.

Servo drive ② Refer to Accurax G5 servo drive section for detailed drive specifications and selection of drive accessories.

Servo Motors 3000 r/min (50 W - 400 W), 120 VAC

| Symbol | Specifications | | | | Servo motor model | Compatible servo drives ② | | | | |
|--|-------------------------|---------------------------------|------------------------------------|------------------|-------------------|---------------------------|------------------|--------------------|-----------------|------------|
| | Voltage | Encoder and design | | Rated torque | | Capacity | G5 EtherCAT | G5 MECHATROLINK-II | G5 Analog/Pulse | |
| ①  | Single-phase 120 VAC | Incremental encoder (20 bit) | Straight shaft with key and tap | Without brake | 0.16 N • m | 50 W | R88M-K05030H-S2 | R88D-KNA5L-ECT | R88D-KNA5L-ML2 | R88D-KTA5L |
| | | | | | 0.32 N • m | 100 W | R88M-K10030L-S2 | R88D-KN01L-ECT | R88D-KN01L-ML2 | R88D-KT01L |
| | | | | | 0.64 N • m | 200 W | R88M-K20030L-S2 | R88D-KN02L-ECT | R88D-KN02L-ML2 | R88D-KT02L |
| | | | | 1.3 N • m | 400 W | R88M-K40030L-S2 | R88D-KN04L-ECT | R88D-KN04L-ML2 | R88D-KT04L | |
| | | | | With brake | 0.16 N • m | 50 W | R88M-K05030H-BS2 | R88D-KNA5L-ECT | R88D-KNA5L-ML2 | R88D-KTA5L |
| | | | | | 0.32 N • m | 100 W | R88M-K10030L-BS2 | R88D-KN01L-ECT | R88D-KN01L-ML2 | R88D-KT01L |
| | | 0.64 N • m | 200 W | | R88M-K20030L-BS2 | R88D-KN02L-ECT | R88D-KN02L-ML2 | R88D-KT02L | | |
| | | Absolute encoder (17 bit) | Straight shaft with key and tap | Without brake | 0.16 N • m | 50 W | R88M-K05030T-S2 | R88D-KNA5L-ECT | R88D-KNA5L-ML2 | R88D-KTA5L |
| | | | | | 0.32 N • m | 100 W | R88M-K10030S-S2 | R88D-KN01L-ECT | R88D-KN01L-ML2 | R88D-KT01L |
| | | | | | 0.64 N • m | 200 W | R88M-K20030S-S2 | R88D-KN02L-ECT | R88D-KN02L-ML2 | R88D-KT02L |
| | | | | 1.3 N • m | 400 W | R88M-K40030S-S2 | R88D-KN04L-ECT | R88D-KN04L-ML2 | R88D-KT04L | |
| | | | | With brake | 0.16 N • m | 50 W | R88M-K05030T-BS2 | R88D-KNA5L-ECT | R88D-KNA5L-ML2 | R88D-KTA5L |
| | | | | | 0.32 N • m | 100 W | R88M-K10030S-BS2 | R88D-KN01L-ECT | R88D-KN01L-ML2 | R88D-KT01L |
| | | 0.64 N • m | 200 W | | R88M-K20030S-BS2 | R88D-KN02L-ECT | R88D-KN02L-ML2 | R88D-KT02L | | |
| | | | | | 1.3 N • m | 400 W | R88M-K40030S-BS2 | R88D-KN04L-ECT | R88D-KN04L-ML2 | R88D-KT04L |

Ordering Information

Servo Motors 3000 r/min (50 W - 5 kW), 230/460 VAC

| Symbol | Specifications | | | | Servo motor model | Compatible servo drives ② | | | | | |
|---|---|---|---|------------------|-------------------|---------------------------|------------------|--------------------|-----------------|----------------|------------|
| | Voltage | Encoder and design | | Rated torque | | Capacity | G5 EtherCAT | G5 MECHATROLINK-II | G5 Analog/Pulse | | |
|  | Single-phase/ Three-phase 230 VAC | Incremental encoder (20 bit) Straight shaft with key and tap | Without brake | 0.16 N • m | 50 W | R88M-K05030H-S2 | R88D-KN01H-ECT | R88D-KN01H-ML2 | R88D-KT01H | | |
| | | | | 0.32 N • m | 100 W | R88M-K10030H-S2 | R88D-KN01H-ECT | R88D-KN01H-ML2 | R88D-KT01H | | |
| | | | | 0.64 N • m | 200 W | R88M-K20030H-S2 | R88D-KN02H-ECT | R88D-KN02H-ML2 | R88D-KT02H | | |
| | | | | 1.3 N • m | 400 W | R88M-K40030H-S2 | R88D-KN04H-ECT | R88D-KN04H-ML2 | R88D-KT04H | | |
| | | | | 2.4 N • m | 750 W | R88M-K75030H-S2 | R88D-KN08H-ECT | R88D-KN08H-ML2 | R88D-KT08H | | |
| | | | | 3.18 N • m | 1 kW | R88M-K1K030H-S2 | R88D-KN10H-ECT | R88D-KN10H-ML2 | R88D-KT10H | | |
| | | | With brake | 4.77 N • m | 1.5 kW | R88M-K1K530H-S2 | R88D-KN15H-ECT | R88D-KN15H-ML2 | R88D-KT15H | | |
| | | | | 0.16 N • m | 50 W | R88M-K05030H-BS2 | R88D-KN01H-ECT | R88D-KN01H-ML2 | R88D-KT01H | | |
| | | | | 0.32 N • m | 100 W | R88M-K10030H-BS2 | R88D-KN01H-ECT | R88D-KN01H-ML2 | R88D-KT01H | | |
| | | | | 0.64 N • m | 200 W | R88M-K20030H-BS2 | R88D-KN02H-ECT | R88D-KN02H-ML2 | R88D-KT02H | | |
| | | | | 1.3 N • m | 400 W | R88M-K40030H-BS2 | R88D-KN04H-ECT | R88D-KN04H-ML2 | R88D-KT04H | | |
| | | | | 2.4 N • m | 750 W | R88M-K75030H-BS2 | R88D-KN08H-ECT | R88D-KN08H-ML2 | R88D-KT08H | | |
| | | Absolute encoder (17 bit) Straight shaft with key and tap | Without brake | 3.18 N • m | 1 kW | R88M-K1K030H-S2 | R88D-KN10H-ECT | R88D-KN10H-ML2 | R88D-KT10H | | |
| | | | | 4.77 N • m | 1.5 kW | R88M-K1K530H-S2 | R88D-KN15H-ECT | R88D-KN15H-ML2 | R88D-KT15H | | |
| | | | | 0.16 N • m | 50 W | R88M-K05030T-S2 | R88D-KN01H-ECT | R88D-KN01H-ML2 | R88D-KT01H | | |
| | | | | 0.32 N • m | 100 W | R88M-K10030T-S2 | R88D-KN01H-ECT | R88D-KN01H-ML2 | R88D-KT01H | | |
| | | | | 0.64 N • m | 200 W | R88M-K20030T-S2 | R88D-KN02H-ECT | R88D-KN02H-ML2 | R88D-KT02H | | |
| | | | | 1.3 N • m | 400 W | R88M-K40030T-S2 | R88D-KN04H-ECT | R88D-KN04H-ML2 | R88D-KT04H | | |
| | | | With brake | 2.4 N • m | 750 W | R88M-K75030T-S2 | R88D-KN08H-ECT | R88D-KN08H-ML2 | R88D-KT08H | | |
| | | | | 3.18 N • m | 1 kW | R88M-K1K030T-S2 | R88D-KN10H-ECT | R88D-KN10H-ML2 | R88D-KT10H | | |
| | | | | 4.77 N • m | 1.5 kW | R88M-K1K530T-S2 | R88D-KN15H-ECT | R88D-KN15H-ML2 | R88D-KT15H | | |
| | | | | 0.16 N • m | 50 W | R88M-K05030T-BS2 | R88D-KN01H-ECT | R88D-KN01H-ML2 | R88D-KT01H | | |
| | | | | 0.32 N • m | 100 W | R88M-K10030T-BS2 | R88D-KN01H-ECT | R88D-KN01H-ML2 | R88D-KT01H | | |
| | | | | 0.64 N • m | 200 W | R88M-K20030T-BS2 | R88D-KN02H-ECT | R88D-KN02H-ML2 | R88D-KT02H | | |
| | | Three-phase 230 VAC | Incremental encoder (20 bit) Straight shaft with key and tap | Without brake | 6.37 N • m | 2 kW | R88M-K2K030H-S2 | R88D-KN20H-ECT | R88D-KN20H-ML2 | R88D-KT20H | |
| | | | | | 9.55 N • m | 3 kW | R88M-K3K030H-S2 | R88D-KN30H-ECT | R88D-KN30H-ML2 | R88D-KT30H | |
| | | | | | 15.9 N • m | 5 kW | R88M-K5K030H-S2 | R88D-KN50H-ECT | R88D-KN50H-ML2 | R88D-KT50H | |
| | | | | With brake | 6.37 N • m | 2 kW | R88M-K2K030H-BS2 | R88D-KN20H-ECT | R88D-KN20H-ML2 | R88D-KT20H | |
| | | | | | 9.55 N • m | 3 kW | R88M-K3K030H-BS2 | R88D-KN30H-ECT | R88D-KN30H-ML2 | R88D-KT30H | |
| | | | | | 15.9 N • m | 5 kW | R88M-K5K030H-BS2 | R88D-KN50H-ECT | R88D-KN50H-ML2 | R88D-KT50H | |
| | | | Absolute encoder (17 bit) Straight shaft with key and tap | Without brake | 6.37 N • m | 2 kW | R88M-K2K030T-S2 | R88D-KN20H-ECT | R88D-KN20H-ML2 | R88D-KT20H | |
| | | | | | 9.55 N • m | 3 kW | R88M-K3K030T-S2 | R88D-KN30H-ECT | R88D-KN30H-ML2 | R88D-KT30H | |
| | | | | | 15.9 N • m | 5 kW | R88M-K5K030T-S2 | R88D-KN50H-ECT | R88D-KN50H-ML2 | R88D-KT50H | |
| | | | | With brake | 6.37 N • m | 2 kW | R88M-K2K030T-BS2 | R88D-KN20H-ECT | R88D-KN20H-ML2 | R88D-KT20H | |
| | | | | | 9.55 N • m | 3 kW | R88M-K3K030T-BS2 | R88D-KN30H-ECT | R88D-KN30H-ML2 | R88D-KT30H | |
| | | | | | 15.9 N • m | 5 kW | R88M-K5K030T-BS2 | R88D-KN50H-ECT | R88D-KN50H-ML2 | R88D-KT50H | |
| | | Three-phase 460 VAC | Incremental encoder (20 bit) Straight shaft with key and tap | Without brake | 2.4 N • m | 750 W | R88M-K75030F-S2 | R88D-KN10F-ECT | R88D-KN10F-ML2 | R88D-KT10F | |
| | | | | | 3.18 N • m | 1 kW | R88M-K1K030F-S2 | R88D-KN10F-ECT | R88D-KN10F-ML2 | R88D-KT10F | |
| | | | | | 4.77 N • m | 1.5 kW | R88M-K1K530F-S2 | R88D-KN15F-ECT | R88D-KN15F-ML2 | R88D-KT15F | |
| | | | | | 6.37 N • m | 2 kW | R88M-K2K030F-S2 | R88D-KN20F-ECT | R88D-KN20F-ML2 | R88D-KT20F | |
| | | | | | 9.55 N • m | 3 kW | R88M-K3K030F-S2 | R88D-KN30F-ECT | R88D-KN30F-ML2 | R88D-KT30F | |
| | | | | | 12.7 N • m | 4 kW | R88M-K4K030F-S2 | R88D-KN50F-ECT | R88D-KN50F-ML2 | R88D-KT50F | |
| | | | | | With brake | 15.9 N • m | 5 kW | R88M-K5K030F-S2 | R88D-KN50F-ECT | R88D-KN50F-ML2 | R88D-KT50F |
| | | | | | | 2.4 N • m | 750 W | R88M-K75030F-BS2 | R88D-KN10F-ECT | R88D-KN10F-ML2 | R88D-KT10F |
| | | | | | | 3.18 N • m | 1 kW | R88M-K1K030F-BS2 | R88D-KN10F-ECT | R88D-KN10F-ML2 | R88D-KT10F |
| | | | | | | 4.77 N • m | 1.5 kW | R88M-K1K530F-BS2 | R88D-KN15F-ECT | R88D-KN15F-ML2 | R88D-KT15F |
| | | | | | | 6.37 N • m | 2 kW | R88M-K2K030F-BS2 | R88D-KN20F-ECT | R88D-KN20F-ML2 | R88D-KT20F |
| | | | | | | 9.55 N • m | 3 kW | R88M-K3K030F-BS2 | R88D-KN30F-ECT | R88D-KN30F-ML2 | R88D-KT30F |
| Absolute encoder (17 bit) Straight shaft with key and tap | Without brake | | | 12.7 N • m | 4 kW | R88M-K4K030F-BS2 | R88D-KN50F-ECT | R88D-KN50F-ML2 | R88D-KT50F | | |
| | | | | 15.9 N • m | 5 kW | R88M-K5K030F-BS2 | R88D-KN50F-ECT | R88D-KN50F-ML2 | R88D-KT50F | | |
| | | | | 2.4 N • m | 750 W | R88M-K75030C-S2 | R88D-KN10F-ECT | R88D-KN10F-ML2 | R88D-KT10F | | |
| | | | | 3.18 N • m | 1 kW | R88M-K1K030C-S2 | R88D-KN10F-ECT | R88D-KN10F-ML2 | R88D-KT10F | | |
| | | | | 4.77 N • m | 1.5 kW | R88M-K1K530C-S2 | R88D-KN15F-ECT | R88D-KN15F-ML2 | R88D-KT15F | | |
| | | | | 6.37 N • m | 2 kW | R88M-K2K030C-S2 | R88D-KN20F-ECT | R88D-KN20F-ML2 | R88D-KT20F | | |
| | With brake | | | 9.55 N • m | 3 kW | R88M-K3K030C-S2 | R88D-KN30F-ECT | R88D-KN30F-ML2 | R88D-KT30F | | |
| | | | | 12.7 N • m | 4 kW | R88M-K4K030C-S2 | R88D-KN50F-ECT | R88D-KN50F-ML2 | R88D-KT50F | | |
| | | | | 15.9 N • m | 5 kW | R88M-K5K030C-S2 | R88D-KN50F-ECT | R88D-KN50F-ML2 | R88D-KT50F | | |
| | | | | 2.4 N • m | 750 W | R88M-K75030C-BS2 | R88D-KN10F-ECT | R88D-KN10F-ML2 | R88D-KT10F | | |
| | | | | 3.18 N • m | 1 kW | R88M-K1K030C-BS2 | R88D-KN10F-ECT | R88D-KN10F-ML2 | R88D-KT10F | | |
| | | | | 4.77 N • m | 1.5 kW | R88M-K1K530C-BS2 | R88D-KN15F-ECT | R88D-KN15F-ML2 | R88D-KT15F | | |
| Three-phase 460 VAC | Without brake | | 6.37 N • m | 2 kW | R88M-K2K030C-BS2 | R88D-KN20F-ECT | R88D-KN20F-ML2 | R88D-KT20F | | | |
| | | | 9.55 N • m | 3 kW | R88M-K3K030C-BS2 | R88D-KN30F-ECT | R88D-KN30F-ML2 | R88D-KT30F | | | |
| | | | 12.7 N • m | 4 kW | R88M-K4K030C-BS2 | R88D-KN50F-ECT | R88D-KN50F-ML2 | R88D-KT50F | | | |
| | | | 15.9 N • m | 5 kW | R88M-K5K030C-BS2 | R88D-KN50F-ECT | R88D-KN50F-ML2 | R88D-KT50F | | | |
| | | | 2.4 N • m | 750 W | R88M-K75030C-S2 | R88D-KN10F-ECT | R88D-KN10F-ML2 | R88D-KT10F | | | |
| | | | 3.18 N • m | 1 kW | R88M-K1K030C-S2 | R88D-KN10F-ECT | R88D-KN10F-ML2 | R88D-KT10F | | | |
| | With brake | | 4.77 N • m | 1.5 kW | R88M-K1K530C-S2 | R88D-KN15F-ECT | R88D-KN15F-ML2 | R88D-KT15F | | | |
| | | | 6.37 N • m | 2 kW | R88M-K2K030C-S2 | R88D-KN20F-ECT | R88D-KN20F-ML2 | R88D-KT20F | | | |
| | | | 9.55 N • m | 3 kW | R88M-K3K030C-S2 | R88D-KN30F-ECT | R88D-KN30F-ML2 | R88D-KT30F | | | |
| | | | 12.7 N • m | 4 kW | R88M-K4K030C-S2 | R88D-KN50F-ECT | R88D-KN50F-ML2 | R88D-KT50F | | | |
| | | | 15.9 N • m | 5 kW | R88M-K5K030C-S2 | R88D-KN50F-ECT | R88D-KN50F-ML2 | R88D-KT50F | | | |
| | | | 2.4 N • m | 750 W | R88M-K75030C-BS2 | R88D-KN10F-ECT | R88D-KN10F-ML2 | R88D-KT10F | | | |

Ordering Information

Servo Motors 2000 r/min (400 W - 5 kW), 230/460 VAC



| Symbol | Specifications | | | | Servo motor model | Compatible servo drives ② | | | | | |
|---|--|--|---|---|-------------------|---------------------------|--------------------|------------------|----------------|----------------|------------|
| | Voltage | Encoder and design | Rated torque | Capacity | | G5 EtherCAT | G5 MECHATROLINK-II | G5 Analog/Pulse | | | |
|  | Single-phase/Three-phase 230 VAC | Incremental encoder (20 bit) Straight shaft with key and tap | Without brake | 4.77 N • m | 1 kW | R88M-K1K020H-S2 | R88D-KN10H-ECT | R88D-KN10H-ML2 | R88D-KT10H | | |
| | Three-phase 230 VAC | | | 7.16 N • m | 1.5 kW | R88M-K1K520H-S2 | R88D-KN15H-ECT | R88D-KN15H-ML2 | R88D-KT15H | | |
| | | | | 9.55 N • m | 2 kW | R88M-K2K020H-S2 | R88D-KN20H-ECT | R88D-KN20H-ML2 | R88D-KT20H | | |
| | | | | 14.3 N • m | 3 kW | R88M-K3K020H-S2 | R88D-KN30H-ECT | R88D-KN30H-ML2 | R88D-KT30H | | |
| | | | | 19.1 N • m | 4 kW | R88M-K4K020H-S2 | R88D-KN50H-ECT | R88D-KN50H-ML2 | R88D-KT50H | | |
| | | | | 23.9 N • m | 5 kW | R88M-K5K020H-S2 | R88D-KN50H-ECT | R88D-KN50H-ML2 | R88D-KT50H | | |
| | | | 4.77 N • m | 1 kW | R88M-K1K020H-BS2 | R88D-KN10H-ECT | R88D-KN10H-ML2 | R88D-KT10H | | | |
| | Three-phase 230 VAC | | 7.16 N • m | 1.5 kW | R88M-K1K520H-BS2 | R88D-KN15H-ECT | R88D-KN15H-ML2 | R88D-KT15H | | | |
| | | | 9.55 N • m | 2 kW | R88M-K2K020H-BS2 | R88D-KN20H-ECT | R88D-KN20H-ML2 | R88D-KT20H | | | |
| | | | 14.3 N • m | 3 kW | R88M-K3K020H-BS2 | R88D-KN30H-ECT | R88D-KN30H-ML2 | R88D-KT30H | | | |
| | | | 19.1 N • m | 4 kW | R88M-K4K020H-BS2 | R88D-KN50H-ECT | R88D-KN50H-ML2 | R88D-KT50H | | | |
| | | | 23.9 N • m | 5 kW | R88M-K5K020H-BS2 | R88D-KN50H-ECT | R88D-KN50H-ML2 | R88D-KT50H | | | |
| | | 4.77 N • m | 1 kW | R88M-K1K020T-S2 | R88D-KN10H-ECT | R88D-KN10H-ML2 | R88D-KT10H | | | | |
| | Single-phase/Three-phase 230 VAC | Absolute encoder (17 bit) Straight shaft with key and tap | Without brake | 7.16 N • m | 1.5 kW | R88M-K1K520T-S2 | R88D-KN15H-ECT | R88D-KN15H-ML2 | R88D-KT15H | | |
| | | | | 9.55 N • m | 2 kW | R88M-K2K020T-S2 | R88D-KN20H-ECT | R88D-KN20H-ML2 | R88D-KT20H | | |
| | | | | 14.3 N • m | 3 kW | R88M-K3K020T-S2 | R88D-KN30H-ECT | R88D-KN30H-ML2 | R88D-KT30H | | |
| | | | | 19.1 N • m | 4 kW | R88M-K4K020T-S2 | R88D-KN50H-ECT | R88D-KN50H-ML2 | R88D-KT50H | | |
| | | | | 23.9 N • m | 5 kW | R88M-K5K020T-S2 | R88D-KN50H-ECT | R88D-KN50H-ML2 | R88D-KT50H | | |
| | | | | 4.77 N • m | 1 kW | R88M-K1K020T-BS2 | R88D-KN10H-ECT | R88D-KN10H-ML2 | R88D-KT10H | | |
| | | | Three-phase 230 VAC | 7.16 N • m | 1.5 kW | R88M-K1K520T-BS2 | R88D-KN15H-ECT | R88D-KN15H-ML2 | R88D-KT15H | | |
| | | | | 9.55 N • m | 2 kW | R88M-K2K020T-BS2 | R88D-KN20H-ECT | R88D-KN20H-ML2 | R88D-KT20H | | |
| | | | | 14.3 N • m | 3 kW | R88M-K3K020T-BS2 | R88D-KN30H-ECT | R88D-KN30H-ML2 | R88D-KT30H | | |
| | | | | 19.1 N • m | 4 kW | R88M-K4K020T-BS2 | R88D-KN50H-ECT | R88D-KN50H-ML2 | R88D-KT50H | | |
| | | | | 23.9 N • m | 5 kW | R88M-K5K020T-BS2 | R88D-KN50H-ECT | R88D-KN50H-ML2 | R88D-KT50H | | |
| 4.77 N • m | | | | 1 kW | R88M-K1K020F-S2 | R88D-KN06F-ECT | R88D-KN06F-ML2 | R88D-KT06F | | | |
| Three-phase 460 VAC | Incremental encoder (20 bit) Straight shaft with key and tap | Without brake | 2.86 N • m | 600 W | R88M-K60020F-S2 | R88D-KN06F-ECT | R88D-KN06F-ML2 | R88D-KT06F | | | |
| | | | 4.77 N • m | 1 kW | R88M-K1K020F-S2 | R88D-KN10F-ECT | R88D-KN10F-ML2 | R88D-KT10F | | | |
| | | | 7.16 N • m | 1.5 kW | R88M-K1K520F-S2 | R88D-KN15F-ECT | R88D-KN15F-ML2 | R88D-KT15F | | | |
| | | | 9.55 N • m | 2 kW | R88M-K2K020F-S2 | R88D-KN20F-ECT | R88D-KN20F-ML2 | R88D-KT20F | | | |
| | | | 14.3 N • m | 3 kW | R88M-K3K020F-S2 | R88D-KN30F-ECT | R88D-KN30F-ML2 | R88D-KT30F | | | |
| | | | 19.1 N • m | 4 kW | R88M-K4K020F-S2 | R88D-KN50F-ECT | R88D-KN50F-ML2 | R88D-KT50F | | | |
| | | | 23.9 N • m | 5 kW | R88M-K5K020F-S2 | R88D-KN50F-ECT | R88D-KN50F-ML2 | R88D-KT50F | | | |
| | | | Three-phase 460 VAC | Absolute encoder (17 bit) Straight shaft with key and tap | Without brake | 1.91 N • m | 400 W | R88M-K40020C-S2 | R88D-KN06F-ECT | R88D-KN06F-ML2 | R88D-KT06F |
| | | | | | | 2.86 N • m | 600 W | R88M-K60020C-S2 | R88D-KN06F-ECT | R88D-KN06F-ML2 | R88D-KT06F |
| | | | | | | 4.77 N • m | 1 kW | R88M-K1K020C-S2 | R88D-KN10F-ECT | R88D-KN10F-ML2 | R88D-KT10F |
| | | | | | | 7.16 N • m | 1.5 kW | R88M-K1K520C-S2 | R88D-KN15F-ECT | R88D-KN15F-ML2 | R88D-KT15F |
| | | | | | | 9.55 N • m | 2 kW | R88M-K2K020C-S2 | R88D-KN20F-ECT | R88D-KN20F-ML2 | R88D-KT20F |
| | | 14.3 N • m | | | | 3 kW | R88M-K3K020C-S2 | R88D-KN30F-ECT | R88D-KN30F-ML2 | R88D-KT30F | |
| | | Three-phase 460 VAC | Absolute encoder (17 bit) Straight shaft with key and tap | Without brake | 19.1 N • m | 4 kW | R88M-K4K020C-S2 | R88D-KN50F-ECT | R88D-KN50F-ML2 | R88D-KT50F | |
| | | | | | 23.9 N • m | 5 kW | R88M-K5K020C-S2 | R88D-KN50F-ECT | R88D-KN50F-ML2 | R88D-KT50F | |
| | | | | | With brake | 1.91 N • m | 400 W | R88M-K40020C-BS2 | R88D-KN06F-ECT | R88D-KN06F-ML2 | R88D-KT06F |
| | | | | | | 2.86 N • m | 600 W | R88M-K60020C-BS2 | R88D-KN06F-ECT | R88D-KN06F-ML2 | R88D-KT06F |
| | | | | | | 4.77 N • m | 1 kW | R88M-K1K020C-BS2 | R88D-KN10F-ECT | R88D-KN10F-ML2 | R88D-KT10F |
| | | | | | | 7.16 N • m | 1.5 kW | R88M-K1K520C-BS2 | R88D-KN15F-ECT | R88D-KN15F-ML2 | R88D-KT15F |
| | | | | 9.55 N • m | | 2 kW | R88M-K2K020C-BS2 | R88D-KN20F-ECT | R88D-KN20F-ML2 | R88D-KT20F | |
| | | | | 14.3 N • m | | 3 kW | R88M-K3K020C-BS2 | R88D-KN30F-ECT | R88D-KN30F-ML2 | R88D-KT30F | |
| | | | | With brake | 19.1 N • m | 4 kW | R88M-K4K020C-BS2 | R88D-KN50F-ECT | R88D-KN50F-ML2 | R88D-KT50F | |
| | | | | | 23.9 N • m | 5 kW | R88M-K5K020C-BS2 | R88D-KN50F-ECT | R88D-KN50F-ML2 | R88D-KT50F | |

Ordering Information

Servo Motors 1500 r/min (7.5 - 15 kW)

| Symbol | Specifications | | | | Servo motor model | Compatible servo drives ^② | | |
|---|------------------------|--|---------------|----------|-------------------|--------------------------------------|-----------------|------------|
| | Voltage | Encoder and design | Rated torque | Capacity | | G5 EtherCAT | G5 Analog/Pulse | |
|  | Three-phase 230 VAC | Absolute encoder (17 bit) Straight shaft with key and tap | Without brake | 47.8 N·m | 7500 W | R88M-K7K515T-S2 | R88D-KN75H-ECT | R88D-KT75H |
| | | | With brake | 47.8 N·m | 7500 W | R88M-K7K515T-BS2 | R88D-KN75H-ECT | R88D-KT75H |
| | Without brake | | 47.8 N·m | 7500 W | R88M-K7K515C-S2 | R88D-KN75F-ECT | R88D-KT75F | |
| | | | 70.0 N·m | 11000 W | R88M-K11K015C-S2 | R88D-KN150F-ECT | R88D-KT150F | |
| | | | 95.5 N·m | 15000 W | R88M-K15K015C-S2 | R88D-KN150F-ECT | R88D-KT150F | |
| | | | 47.8 N·m | 7500 W | R88M-K7K515C-BS2 | R88D-KN75F-ECT | R88D-KT75F | |
| | Three-phase 460 VAC | With brake | 70.0 N·m | 11000 W | R88M-K11K015C-BS2 | R88D-KN150F-ECT | R88D-KT150F | |
| | | | 95.5 N·m | 15000 W | R88M-K15K015C-BS2 | R88D-KN150F-ECT | R88D-KT150F | |

Servo Motors 1000 r/min (900 W - 6 kW)

| Symbol | Specifications | | | | Servo motor model | Compatible servo drives ^② | | | |
|--|---|---|----------------|------------|-------------------|--------------------------------------|-----------------|----------------|----------------|
| | Voltage | Encoder and design | Rated torque | Capacity | | G5 EtherCAT | G5 Analog/Pulse | G5 ML2 | |
|   | Single-phase/ Three-phase 230 VAC | Incremental encoder (20 bit) Straight shaft with key and tap | Without brake | 8.59 N·m | 900 W | R88M-K90010H-S2 | R88D-KN15H-ECT | R88D-KT15H | R88D-KN15H-ML2 |
| | | | 19.1 N·m | 2000 W | R88M-K2K010H-S2 | R88D-KN30H-ECT | R88D-KT30H | R88D-KN30H-ML2 | |
| | | | 28.7 N·m | 3000 W | R88M-K3K010H-S2 | R88D-KN50H-ECT | R88D-KT50H | R88D-KN50H-ML2 | |
| | | | With brake | 8.59 N·m | 900 W | R88M-K90010H-BS2 | R88D-KN15H-ECT | R88D-KT15H | R88D-KN15H-ML2 |
| | | | 19.1 N·m | 2000 W | R88M-K2K010H-BS2 | R88D-KN30H-ECT | R88D-KT30H | R88D-KN30H-ML2 | |
| | | | 28.7 N·m | 3000 W | R88M-K3K010H-BS2 | R88D-KN50H-ECT | R88D-KT50H | R88D-KN50H-ML2 | |
| | | Absolute encoder (17 bit) Straight shaft with key and tap | Without brake | 8.59 N·m | 900 W | R88M-K90010T-S2 | R88D-KN15H-ECT | R88D-KT15H | R88D-KN15H-ML2 |
| | | | 19.1 N·m | 2000 W | R88M-K2K010T-S2 | R88D-KN30H-ECT | R88D-KT30H | R88D-KN30H-ML2 | |
| | | | 28.7 N·m | 3000 W | R88M-K3K010T-S2 | R88D-KN50H-ECT | R88D-KT50H | R88D-KN50H-ML2 | |
| | | | With brake | 8.59 N·m | 900 W | R88M-K90010T-BS2 | R88D-KN15H-ECT | R88D-KT15H | R88D-KN15H-ML2 |
| | | | 19.1 N·m | 2000 W | R88M-K2K010T-BS2 | R88D-KN30H-ECT | R88D-KT30H | R88D-KN30H-ML2 | |
| | | | 28.7 N·m | 3000 W | R88M-K3K010T-BS2 | R88D-KN50H-ECT | R88D-KT50H | R88D-KN50H-ML2 | |
| | Three-phase 460 VAC | Incremental encoder (20 bit) Straight shaft with key and tap | Without brake | 8.59 N·m | 900 W | R88M-K90010F-S2 | R88D-KN15F-ECT | R88D-KT15F | R88D-KN15F-ML2 |
| | | | 19.1 N·m | 2000 W | R88M-K2K010F-S2 | R88D-KN30F-ECT | R88D-KT30F | R88D-KN30F-ML2 | |
| | | | 28.7 N·m | 3000 W | R88M-K3K010F-S2 | R88D-KN50F-ECT | R88D-KT50F | R88D-KN50F-ML2 | |
| | | | With brake | 8.59 N·m | 900 W | R88M-K90010F-BS2 | R88D-KN15F-ECT | R88D-KT15F | R88D-KN15F-ML2 |
| | | | 19.1 N·m | 2000 W | R88M-K2K010F-BS2 | R88D-KN30F-ECT | R88D-KT30F | R88D-KN30F-ML2 | |
| | | | 28.7 N·m | 3000 W | R88M-K3K010F-BS2 | R88D-KN50F-ECT | R88D-KT50F | R88D-KN50F-ML2 | |
| | | Absolute encoder (17 bit) Straight shaft with key and tap | Without brake | 8.59 N·m | 900 W | R88M-K90010C-S2 | R88D-KN15F-ECT | R88D-KT15F | R88D-KN15F-ML2 |
| | | | 19.1 N·m | 2000 W | R88M-K2K010C-S2 | R88D-KN30F-ECT | R88D-KT30F | R88D-KN30F-ML2 | |
| | | | 28.7 N·m | 3000 W | R88M-K3K010C-S2 | R88D-KN50F-ECT | R88D-KT50F | R88D-KN50F-ML2 | |
| | | | 43.0 N·m | 4500 W | R88M-K4K510C-S2 | R88D-KN50F-ECT | R88D-KT50F | - | |
| | | | 57.3 N·m | 6000 W | R88M-K6K010C-S2 | R88D-KN75F-ECT | R88D-KT75F | - | |
| | | | With brake | 8.59 N·m | 900 W | R88M-K90010C-BS2 | R88D-KN15F-ECT | R88D-KT15F | R88D-KN15F-ML2 |
| 19.1 N·m | 2000 W | R88M-K2K010C-BS2 | R88D-KN30F-ECT | R88D-KT30F | R88D-KN30F-ML2 | | | | |
| 28.7 N·m | 3000 W | R88M-K3K010C-BS2 | R88D-KN50F-ECT | R88D-KT50F | R88D-KN50F-ML2 | | | | |
| 43.0 N·m | 4500 W | R88M-K4K510C-BS2 | R88D-KN50F-ECT | R88D-KT50F | - | | | | |
| 57.3 N·m | 6000 W | R88M-K6K010C-BS2 | R88D-KN75F-ECT | R88D-KT75F | - | | | | |

Ordering Information

Accurax G5 series EtherCAT reference configuration



Note: The symbols ①②③... show the recommended sequence to select the Accurax G5 servo system

Servo motors power & encoder cables

Note: ①② Refer to the Accurax G5 servo motor section for servomotor, motor cables or connectors selection.

Servo drives

| Symbol | Specifications | | Servo drive model | Servo motor model ① | |
|--------|-----------------------|----------|--------------------|---------------------|--------------------|
| | Voltage | Capacity | | | |
| ③ | Single-phase, 120 VAC | 50 W | R88D-KNA5L-ECT | R88M-K05030(H/T)-□ | |
| | | 100 W | R88D-KN01L-ECT | R88M-K10030(L/S)-□ | |
| | | 200 W | R88D-KN02L-ECT | R88M-K20030(L/S)-□ | |
| | | 400 W | R88D-KN04L-ECT | R88M-K40030(L/S)-□ | |
| | Single-phase, 230 VAC | 100 W | R88D-KN01H-ECT | R88M-K05030(H/T)-□ | R88M-K10030(H/T)-□ |
| | | | R88D-KN02H-ECT | R88M-K20030(H/T)-□ | |
| | | 400 W | R88D-KN04H-ECT | R88M-K40030(H/T)-□ | |
| | | | R88D-KN08H-ECT | R88M-K75030(H/T)-□ | |
| | | 1.0 kW | R88D-KN10H-ECT | R88M-K1K020(H/T)-□ | R88M-K1K030(H/T)-□ |
| | | | R88D-KN15H-ECT | R88M-K1K530(H/T)-□ | R88M-K1K520(H/T)-□ |
| | | | R88M-K90010(H/T)-□ | | |
| | | | R88M-K2K030(H/T)-□ | R88M-K2K020(H/T)-□ | |
| | Three-phase, 230 VAC | 2.0 kW | R88D-KN20H-ECT | R88M-K3K030(H/T)-□ | R88M-K2K010(H/T)-□ |
| | | | R88D-KN30H-ECT | R88M-K3K020(H/T)-□ | |
| | | 5.0 kW | R88D-KN50H-ECT | R88M-K4K030(H/T)-□ | R88M-K4K020(H/T)-□ |
| | | | R88M-K5K030(H/T)-□ | R88M-K5K020(H/T)-□ | |
| | | | R88D-KN75H-ECT | R88M-K7K515T-□ | |
| | | | R88M-K40020(F/C)-□ | R88M-K60020(F/C)-□ | |
| | Three-phase, 460 VAC | 600 W | R88D-KN06F-ECT | R88M-K75030(F/C)-□ | R88M-K1K030(F/C)-□ |
| | | | R88D-KN10F-ECT | R88M-K1K020(F/C)-□ | R88M-K1K530(F/C)-□ |
| | | 1.5 kW | R88D-KN15F-ECT | R88M-K1K520(F/C)-□ | R88M-K90010(F/C)-□ |
| | | | R88M-K2K030(F/C)-□ | R88M-K2K020(F/C)-□ | |
| | | 2.0 kW | R88D-KN20F-ECT | R88M-K3K030(F/C)-□ | R88M-K3K020(F/C)-□ |
| | | | R88D-KN30F-ECT | R88M-K2K010(F/C)-□ | |

Ordering Information

| Symbol | Specifications | Servo drive model | ① Compatible G5 series rotary servo motors | |
|--------|----------------------|-------------------|--|--------------------|
| ③ | Three-phase, 460 VAC | 5.0 kW | R88D-KN50F-ECT | |
| | | 7.5 kW | R88D-KN75F-ECT | |
| | | 15 kW | R88D-KN150F-ECT | |
| | | | | R88M-K4K030(F/C)-□ |
| | | | | R88M-K5K030(F/C)-□ |
| | | | | R88M-K4K020(F/C)-□ |
| | | | | R88M-K5K020(F/C)-□ |
| | | | | R88M-K4K510C-□ |
| | | | | R88M-K3K010(F/C)-□ |
| | | | R88M-K6K010C-□ | |
| | | | R88M-K7K515C-□ | |
| | | | R88M-K11K015C-□ | |
| | | | R88M-K15K015C-□ | |

Signals cables for I/O general purpose (CN1)

| Symbol | Description | Connect to | Model |
|--------|--|-------------------------|---------------------|
| ④ | I/O connector kit (26 pins) | For I/O general purpose | - R88A-CNW01C |
| ⑤ | I/O signals cable | For I/O general purpose | 1 m R88A-CPKB001S-E |
| | | | 2 m R88A-CPKB002S-E |
| ⑥ | Terminal block cable | For I/O general purpose | 1 m XW2Z-100J-B34 |
| | | | 2 m XW2Z-200J-B34 |
| ⑦ | Terminal block (M3 screw and for pin terminals) | - | XW2B-20G4 |
| | Terminal block (M3.5 screw and for fork/round terminals) | - | XW2B-20G5 |
| | Terminal block (M3 screw and for fork/round terminals) | - | XW2D-20G6 |

External encoder cable (CN4)

| Symbol | Name | Model |
|--------|------------------------|-----------------------|
| ⑧ | External encoder cable | 5 m R88A-CRKM005SR-E |
| | | 10 m R88A-CRKM010SR-E |
| | | 20 m R88A-CRKM020SR-E |

Analog monitor (CN5)

| Symbol | Name | Model |
|--------|----------------------|------------------|
| ⑨ | Analog monitor cable | 1 m R88A-CMK001S |

USB personal computer cable (CN7)

| Symbol | Name | Model |
|--------|--------------------------|-------------------|
| ⑩ | USB mini-connector cable | 2 m AX-CUSBM002-E |

Cable for safety (CN8)

| Symbol | Name | Model |
|--------|--------------|--------------------|
| ⑪ | Safety cable | 3 m R88A-CSK003S-E |

Filters

| Symbol | Specifications | Power | Drive Model | Filter Model | Rated Current (A) | Leakage Current (mA) Nom/Max |
|--------|-----------------------|-----------------|----------------|----------------|----------------------|------------------------------|
| ⑫ | Single-phase, 120 VAC | 50 W | R88D-KTA5L-ECT | R88A-FIK102-RE | 2.4 | 3.5 |
| | | 100 W | R88D-KT01L-ECT | R88A-FIK102-RE | 2.4 | 3.5 |
| | | 200 W | R88D-KT02L-ECT | R88A-FIK104-RE | 4.1 | 3.5 |
| | | 400 W | R88D-KT04L-ECT | R88A-FIK107-RE | 6.6 | 3.5 |
| | Single-phase, 230 VAC | 100 W | R88D-KT01H-ECT | R88A-FIK102-RE | 2.4 | 3.5 |
| | | 200 W | R88D-KT02H-ECT | R88A-FIK102-RE | 2.4 | 3.5 |
| | | 400 W | R88D-KT04H-ECT | R88A-FIK104-RE | 4.1 | 3.5 |
| | | 750 W | R88D-KT08H-ECT | R88A-FIK107-RE | 6.6 | 3.5 |
| | | 1.0 kW | R88D-KT10H-ECT | R88A-FIK114-RE | 14.2 | 3.5 |
| | | 1.5 kW | R88D-KT15H-ECT | R88A-FIK114-RE | 14.2 | 3.5 |
| | Three-phase, 230 VAC | 2.0 kW | R88D-KT20H-ECT | R88A-FIK212-RE | 12 | 0.5/25 ¹ |
| | | 3.0 kW | R88D-KT30H-ECT | R88A-FIK222-RE | 22 | 0.5/25 ¹ |
| | | 5.0 kW | R88D-KT50H-ECT | R88A-FIK222-RE | 22 | 0.5/25 ¹ |
| | | 7.5 kW | R88D-KT75H-ECT | - | - | - |
| | Three-phase, 460 VAC | 600 W | R88D-KT06F-ECT | R88A-FIK304-RE | 4 | 0.3/32 ¹ |
| | | 1.0 kW | R88D-KT10F-ECT | R88A-FIK304-RE | 4 | 0.3/32 ¹ |
| | | 1.5 kW | R88D-KT15F-ECT | R88A-FIK304-RE | 4 | 0.3/32 ¹ |
| | | 2.0 kW | R88D-KT20F-ECT | R88A-FIK306-RE | 6 | 0.3/32 ¹ |
| | | 3.0 kW | R88D-KT30F-ECT | R88A-FIK312-RE | 12.1 | 0.3/32 ¹ |
| | | 5.0 kW | R88D-KT50F-ECT | R88A-FIK312-RE | 12.1 | 0.3/32 ¹ |
| | | 7.5 kW | R88D-KT75F-ECT | R88A-FIK330-RE | 22 | 0.3/40 ¹ |
| 15 kW | | R88D-KT150F-ECT | R88A-FIK350-RE | 44 | 2.0/130 ¹ | |

1. Momentary peak leakage current for the filter at switch-on/off.

Connectors

| Specifications | Model |
|---------------------------------------|-------------|
| External encoder connector (for CN4) | R88A-CNK41L |
| Safety I/O signal connector (for CN8) | R88A-CNK81S |

Computer software

| Specifications | Model |
|---|----------|
| Configuration and monitoring software tool for servo drives and inverters (CX-drive version 2.10 or higher) | CX-Drive |

EtherCAT controllers

| Symbol | Name | Model | |
|--------|---|----------------------|---------------------|
| ⑬ | NJ Series Machine Automation Controller | NJ301-1100 (4 axes) | |
| | | NJ301-1200 (8 axes) | |
| | | NJ501-1300 (16 axes) | |
| | | NJ501-1400 (32 axes) | |
| | | NJ501-1500 (64 axes) | |
| | Trajexia stand-alone | Motion control unit | TJ2-MC64 (64 axes) |
| | | | TJ2-ECT64 (64 axes) |
| | | EtherCAT master unit | TJ2-ECT16(16 axes) |
| | Position Controller Unit for CJ1 PLC series | TJ2-ECT04 (4 axes) | |
| | | CJ1W-NCF8□ (16 axes) | |
| | | CJ1W-NC88□ (8 axes) | |
| | | CJ1W-NC48□ (4 axes) | |
| | | CJ1W-NC281 (2 axes) | |

External regenerative resistor

| Symbol | Regenerative resistor unit model | Model |
|--------|----------------------------------|-------------|
| ⑭ | R88A-RR08050S | 50 Ω, 80 W |
| | R88A-RR080100S | 100 Ω, 80 W |
| | R88A-RR22047S1 | 47 Ω, 220 W |
| | R88A-RR50020S | 20 Ω, 500 W |

Ordering Information

Accurax G5 series MECHATROLINK-II Reference configuration



Note: The symbols ①②③④⑤... show the recommended sequence to select the components in Accurax G5 servo system

Servo motors, power & encoder cables

Note: ①② Refer to the Accurax G5 servo motor section for servomotor, motor cables or connectors selection

MECHATROLINK-II Servo Drives

| Symbol | Specifications | Servo drive model | Compatible G5 series rotary servo motors ① | | | |
|--------|-----------------------|----------------------|--|--|--|--|
| ③ | Single-phase, 120 VAC | 50 W | R88D-KNA5L-ML2 | R88M-K05030(H/T)-□ | | |
| | | 100 W | R88D-KN01L-ML2 | R88M-K10030(L/S)-□ | | |
| | | 200 W | R88D-KN02L-ML2 | R88M-K20030(L/S)-□ | | |
| | | 400 W | R88D-KN04L-ML2 | R88M-K40030(L/S)-□ | | |
| | Single-phase, 230 VAC | 100 W | R88D-KN01H-ML2 | R88M-K05030(H/T)-□ R88M-K10030(H/T)-□ | | |
| | | | R88D-KN02H-ML2 | R88M-K20030(H/T)-□ | | |
| | | 400 W | R88D-KN04H-ML2 | R88M-K40030(H/T)-□ | | |
| | | | R88D-KN08H-ML2 | R88M-K75030(H/T)-□ | | |
| | | 1 kW | R88D-KN10H-ML2 | R88M-K1K020(H/T)-□ R88M-K1K030(H/T)-□ | | |
| | | | 1.5 kW | R88D-KN15H-ML2 | R88M-K1K530(H/T)-□ R88M-K1K520(H/T)-□ R88M-K90010(H/T)-□ | |
| | | Three-phase, 230 VAC | | | 2 kW | R88D-KN20H-ML2 |
| | | | 3 kW | R88D-KN30H-ML2 | R88M-K3K030(H/T)-□ | |
| | 5 kW | | R88D-KN50H-ML2 | R88M-K5K030(H/T)-□ | | |
| | Three-phase, 460 VAC | 600 W | R88D-KN06F-ML2 | R88M-K40020(F/C)-□ R88M-K60020(F/C)-□ | | |
| | | | | 1 kW | R88D-KN10F-ML2 | R88M-K75030(F/C)-□ R88M-K1K020(F/C)-□ R88M-K1K030(F/C)-□ |
| | | 1.5 kW | R88D-KN15F-ML2 | | | R88M-K1K530(F/C)-□ R88M-K1K520(F/C)-□ R88M-K90010(F/C)-□ |
| | | | | 2 kW | R88D-KN20F-ML2 | R88M-K2K030(F/C)-□ R88M-K2K020(F/C)-□ |
| | | | | | | 3 kW |
| | | 5 kW | R88D-KN50F-ML2 | R88M-K4K030(F/C)-□ R88M-K5K030(F/C)-□ R88M-K4K020(F/C)-□ R88M-K5K020(F/C)-□ R88M-K3K010(F/C)-□ | | |

Ordering Information

Control Cables (for CN1)

| Symbol | Description | Connect to | | Model |
|--------|--|-------------------------|-----|---------------|
| ④ | I/O connector kit (26 pins) | For I/O general purpose | - | R88A-CNW01C |
| ⑤ | Terminal block cable | | 1 m | XW2Z-100J-B34 |
| | | | 2 m | XW2Z-200J-B34 |
| ⑥ | Terminal block (M3 screw and for pin terminals) | For I/O general purpose | - | XW2B-20G4 |
| | Terminal block (M3.5 screw and for fork/round terminals) | | - | XW2B-20G5 |
| | Terminal block (M3 screw and for fork/round terminals) | | - | XW2D-20G6 |
| | | | - | |

Analog monitor (for CN5)

| Symbol | Name | | Model |
|--------|----------------------|-----|--------------|
| ⑦ | Analog monitor cable | 1 m | R88A-CMK001S |

MECHATROLINK-II cables (for CN6)

| Symbol | Specifications | Length | Model |
|--------|-------------------------------------|----------------|----------------|
| ⑧ | MECHATROLINK-II Terminator resistor | - | FNY-W6022-E |
| | MECHATROLINK-II cables | 0.5 m | FNY-W6003-A5-E |
| 1 m | | FNY-W6003-01-E | |
| 3 m | | FNY-W6003-03-E | |
| 5 m | | FNY-W6003-05-E | |
| 10 m | | FNY-W6003-10-E | |
| 20 m | | FNY-W6003-20-E | |
| 30 m | | FNY-W6003-30-E | |

USB personal computer cable (for CN7)

| Symbol | Name | | Model |
|--------|--------------------------|-----|------------------|
| ⑨ | USB mini-connector cable | 2 m | 3G3AX-CUSBM002-E |

Filters

| Specifications | Power | Drive model | Filter model | Rated current (A) | Leakage current (mA) |
|-----------------------|--------|----------------|----------------|-------------------|----------------------|
| Single-phase, 120 VAC | 50 W | R88D-KNA5L-ML2 | R88A-FIK102-RE | 2.4 | 3.5 |
| | 100 W | R88D-KN01L-ML2 | R88A-FIK102-RE | 2.4 | 3.5 |
| | 200 W | R88D-KN02L-ML2 | R88A-FIK104-RE | 4.1 | 3.5 |
| | 400 W | R88D-KN04L-ML2 | R88A-FIK107-RE | 6.6 | 3.5 |
| Single-phase, 230 VAC | 100 W | R88D-KN01H-ML2 | R88A-FIK102-RE | 2.4 | 3.5 |
| | 200 W | R88D-KN02H-ML2 | R88A-FIK102-RE | 2.4 | 3.5 |
| | 400 W | R88D-KN04H-ML2 | R88A-FIK104-RE | 4.1 | 3.5 |
| | 750 W | R88D-KN08H-ML2 | R88A-FIK107-RE | 6.6 | 3.5 |
| | 1.0 kW | R88D-KN10H-ML2 | R88A-FIK114-RE | 14.2 | 3.5 |
| | 1.5 kW | R88D-KN15H-ML2 | R88A-FIK114-RE | 14.2 | 3.5 |
| Three-phase, 230 VAC | 2.0 kW | R88D-KN20H-ML2 | R88A-FIK212-RE | 12 | 0.5/25 ¹ |
| | 3.0 kW | R88D-KN30H-ML2 | R88A-FIK222-RE | 22 | 0.5/25 ¹ |
| | 5.0 kW | R88D-KN50H-ML2 | R88A-FIK222-RE | 22 | 0.5/25 ¹ |
| Three-phase, 460 VAC | 600 W | R88D-KN06F-ML2 | R88A-FIK304-RE | 4 | 0.3/32 ¹ |
| | 1.0 kW | R88D-KN10F-ML2 | R88A-FIK304-RE | 4 | 0.3/32 ¹ |
| | 1.5 kW | R88D-KN15F-ML2 | R88A-FIK304-RE | 4 | 0.3/32 ¹ |
| | 2.0 kW | R88D-KN20F-ML2 | R88A-FIK306-RE | 6 | 0.3/32 ¹ |
| | 3.0 kW | R88D-KN30F-ML2 | R88A-FIK312-RE | 12.1 | 0.3/32 ¹ |
| | 5.0 kW | R88D-KN50F-ML2 | R88A-FIK312-RE | 12.1 | 0.3/32 ¹ |

Note: 1. Momentary peak leakage current for the filter at switch-on/off.

Reactors

| MECHATROLINK-II servo drive model | Reactor model |
|---|---------------|
| R88D-KNA5L-ML2/-KN01H-ML2 | 3G3AX-DL2002 |
| R88D-KN01L-ML2/-KN02H-ML2 | 3G3AX-DL2004 |
| R88D-KN02L-ML2/-KN04H-ML2 | 3G3AX-DL2007 |
| R88D-KN04L-ML2/-KN08H-ML2/-KN10H-ML2 | 3G3AX-DL2015 |
| R88D-KN15H-ML2 | 3G3AX-DL2022 |
| R88D-KN08H-ML2/-KN10H-ML2/-KN15H-ML2/-KN06F-ML2/-KN10F-ML2/-KN15F-ML2 | 3G3AX-AL2025 |
| R88D-KN20H-ML2/-KN30H-ML2/-KN20F-ML2/-KN30F-ML2 | 3G3AX-AL2055 |
| R88D-KN50H-ML2/-KN50F-ML2 | 3G3AX-AL2110 |

MECHATROLINK-II Motion controllers

| Symbol | Name | Model |
|---------------------|--|----------------------|
| ⑩ | Trajexia stand-alone motion controller | TJ1-MC04 (4 axes) |
| | | TJ1-MC16 (16 axes) |
| | | TJ2-MC64 (64 axes) |
| | Trajexia-PLC motion controller | CJ1W-MCH72 |
| | | CJ1W-NCF71 (16 axes) |
| | Position Controller Unit for CJ1 PLC | CJ1W-NC471 (4 axes) |
| | | CJ1W-NC271 (2 axes) |
| | | CS1W-NCF71 (16 axes) |
| | Position Controller Unit for CS1 PLC | CS1W-NC471 (4 axes) |
| | | CS1W-NC271 (2 axes) |
| CS1W-NC271 (2 axes) | | |

External regenerative resistor

| Symbol | Regenerative resistor unit model | Specifications |
|--------|----------------------------------|----------------|
| ⑪ | R88A-RR08050S | 50 Ω, 80 W |
| | R88A-RR080100S | 100 Ω, 80 W |
| | R88A-RR22047S | 47 Ω, 220 W |
| | R88A-RR50020S | 20 Ω, 500 W |

Connectors

| Specifications | Model |
|---------------------------------------|-------------|
| External encoder connector (for CN4) | R88A-CNK41L |
| Safety I/O signal connector (for CN8) | R88A-CNK81S |

Computer software

| Specifications | Model |
|--|----------|
| Configuration and monitoring software tool for servo drives and inverters. (CX-drive version 1.91 or higher) | CX-drive |

Ordering Information

Accurax G5 series Analog/Pulse reference configuration



Note: The symbols ①②③... show the recommended sequence to select the Accurax G5 servo system

Servo motors power & encoder cables

Note: ①② Refer to the Accurax G5 servo motor section for servomotor, motor cables or connectors selection.

Servo Drives

| Symbol | Specifications | Servo drive model ¹ | Compatible Accurax G5 series rotary servo motors ① | | |
|--------|-----------------------|--------------------------------|--|--------------------|--------------------|
| ③ | Single-phase, 120 VAC | 50 W | R88D-KTA5L | R88M-K05030(H/T)-□ | |
| | | 100 W | R88D-KT01L | R88M-K10030(L/S)-□ | |
| | | 200 W | R88D-KT02L | R88M-K20030(L/S)-□ | |
| | | 400 W | R88D-KT04L | R88M-K40030(L/S)-□ | |
| | Single-phase, 230 VAC | 100 W | R88D-KT01H | R88M-K05030(H/T)-□ | |
| | | | R88D-KT02H | R88M-K10030(H/T)-□ | |
| | | | R88D-KT04H | R88M-K20030(H/T)-□ | |
| | | 750 W | R88D-KT08H | R88M-K75030(H/T)-□ | |
| | | | 1.0 kW | R88D-KT10H | R88M-K1K020(H/T)-□ |
| | | | | R88D-KT15H | R88M-K1K030(H/T)-□ |
| | Three-phase, 230 VAC | 2.0 kW | R88D-KT20H | R88M-K1K530(H/T)-□ | |
| | | | | R88M-K1K520(H/T)-□ | |
| | | 3.0 kW | R88D-KT30H | R88M-K90010(H/T)-□ | |
| | | | | R88M-K2K030(H/T)-□ | |
| | | 5.0 kW | R88D-KT50H | R88M-K2K020(H/T)-□ | |
| | | | | R88M-K3K030(H/T)-□ | |
| | | | | R88M-K3K020(H/T)-□ | |
| | | | | R88M-K2K010(H/T)-□ | |
| | | | | R88M-K4K030(H/T)-□ | |
| | | | | R88M-K5K030(H/T)-□ | |
| | Three-phase, 460 VAC | 600 W | R88D-KT06F | R88M-K40020(F/C)-□ | |
| | | | | R88M-K60020(F/C)-□ | |
| | | 1.0 kW | R88D-KT10F | R88M-K75030(F/C)-□ | |
| | | | | R88M-K1K020(F/C)-□ | |
| | | | | R88M-K1K030(F/C)-□ | |
| | | 1.5 kW | R88D-KT15F | R88M-K1K530(F/C)-□ | |
| | | | | R88M-K1K520(F/C)-□ | |
| | | | | R88M-K90010(F/C)-□ | |
| | | 2.0 kW | R88D-KT20F | R88M-K2K030(F/C)-□ | |
| | | | | R88M-K2K020(F/C)-□ | |
| 3.0 kW | | R88D-KT30F | R88M-K3K030(F/C)-□ | | |
| | | | R88M-K3K020(F/C)-□ | | |
| | | | R88M-K2K010(F/C)-□ | | |
| | | | R88M-K4K030(F/C)-□ | | |
| | R88M-K5K030(F/C)-□ | | | | |
| | R88M-K4K510(C)-□ | | | | |
| 5.0 kW | R88D-KT50F | R88M-K4K020(F/C)-□ | | | |
| | | R88M-K5K020(F/C)-□ | | | |
| | | R88M-K4K510(C)-□ | | | |
| | | R88M-K3K010(F/C)-□ | | | |
| | | R88M-K6K010(C)-□ | | | |
| 7.5 kW | R88D-KT75F | R88M-K7K515(C)-□ | | | |
| | | R88M-K11K015(C)-□ | | | |
| 15 kW | R88D-KT150F | R88M-K15K015(C)-□ | | | |

Note: 1. Drive Programming – embedded indexer functionality – is available in the Accurax G5 Analog/Pulse models with firmware 1.10 or higher.

Ordering Information

Control cables (for CN1)

| Symbol | Description | Connect to | | Model |
|------------------|--|---|-------|--|
| ④ | Control cable (1 axis) | Motion control units CS1W-MC221 CS1W-MC421 | 1 m | R88A-CPG001M1 |
| | | | 2 m | R88A-CPG002M1 |
| | | | 3 m | R88A-CPG003M1 |
| | | | 5 m | R88A-CPG005M1 |
| | Control cable (2 axis) | Motion control units CS1W-MC221 CS1W-MC421 | 1 m | R88A-CPG001M2 |
| | | | 2 m | R88A-CPG002M2 |
| | | | 3 m | R88A-CPG003M2 |
| | | | 5 m | R88A-CPG005M2 |
| ⑧ | Cable from servo relay unit to servo drive | CS1W-NC1□3, CJ1W-NC1□3, C200HW-NC113, CS1W-NC2□3/4□3, CJ1W-NC2□3/4□3, C200HW-NC213/413, CQM1H-PLB21 or CQM1-CPU43 | 1 m | XW2Z-100J-B25 |
| | | | 2 m | XW2Z-200J-B25 |
| | | CJ1M-CPU21/22/23 | 1 m | XW2Z-100J-B31 |
| | | | 2 m | XW2Z-200J-B31 |
| ⑨ | Servo relay unit | Position control units CS1W-NC1□3, CJ1W-NC1□3 or C200HW-NC113 | - | XW2B-20J6-1B (1 axis) |
| | | Position control units CS1W-NC2□3/4□3, CJ1W-NC2□3/4□3 or C200HW-NC213/413 | - | XW2B-40J6-2B (2 axes) |
| | | CQM1H-PLB21 or CQM1-CPU43 | - | XW2B-20J6-3B (1 axis) |
| | | CJ1M-CPU21/22/23 | - | XW2B-20J6-8A (1 axis) XW2B-40J6-9A (2 axes) |
| ⑩ | Position control unit connecting cable | CQM1H-PLB21 | 0.5 m | XW2Z-050J-A3 |
| | | | 1 m | XW2Z-100J-A3 |
| | | CS1W-NC113 or C200HW-NC113 | 0.5 m | XW2Z-050J-A6 |
| | | | 1 m | XW2Z-100J-A6 |
| | | CS1W-NC213/413 or C200HW-NC213/413 | 0.5 m | XW2Z-050J-A7 |
| | | | 1 m | XW2Z-100J-A7 |
| | | CS1W-NC133 | 0.5 m | XW2Z-050J-A10 |
| | | | 1 m | XW2Z-100J-A10 |
| | | CS1W-NC233/433 | 0.5 m | XW2Z-050J-A11 |
| | | | 1 m | XW2Z-100J-A11 |
| | | CJ1W-NC113 | 0.5 m | XW2Z-050J-A14 |
| | | | 1 m | XW2Z-100J-A14 |
| | | CJ1W-NC213/413 | 0.5 m | XW2Z-050J-A15 |
| | | | 1 m | XW2Z-100J-A15 |
| | | CJ1W-NC133 | 0.5 m | XW2Z-050J-A18 |
| | | | 1 m | XW2Z-100J-A18 |
| | | CJ1W-NC233/433 | 0.5 m | XW2Z-050J-A19 |
| | | | 1 m | XW2Z-100J-A19 |
| CJ1M-CPU21/22/23 | 0.5 m | XW2Z-050J-A33 | | |
| | 1 m | XW2Z-100J-A33 | | |
| ⑪ | General purpose cable | For general purpose controllers | 1 m | R88A-CPG001S |
| | | | 2 m | R88A-CPG002S |
| ⑫ | Terminal block cable | For general purpose controllers | 1 m | XW2Z-100J-B24 |
| | | | 2 m | XW2Z-200J-B24 |
| ⑬ | Terminal block (M3 screw and for pin terminals) | For general purpose controllers | - | XW2B-50G4 |
| | Terminal block (M3.5 screw and for fork/round terminals) | | - | XW2B-50G5 |
| | Terminal block (M3 screw and for fork/round terminals) | | - | XW2D-50G6 |

Ordering Information

Analog monitor (for CN5)

| Symbol | Name | Length | Model |
|--------|----------------------|--------|--------------|
| ⑭ | Analog monitor cable | 1 m | R88A-CMK001S |

USB personal computer cable (for CN7)

| Symbol | Name | Length | Model |
|--------|--------------------------|--------|------------------|
| ⑮ | USB mini-connector cable | 2 m | 3G3AX-CUSBM002-E |

External regenerative resistor

| Symbol | Regenerative resistor unit model | Specifications |
|--------|----------------------------------|----------------|
| ⑯ | R88A-RR08050S | 50 Ω, 80 W |
| | R88A-RR080100S | 100 Ω, 80 W |
| | R88A-RR22047S | 47 Ω, 220 W |
| | R88A-RR50020S | 20 Ω, 500 W |

Filters

| Specifications | Power | Drive model | Filter model | Rated current (A) | Leakage current (mA) |
|-----------------------|--------|-------------|----------------|-------------------|----------------------|
| Single-phase, 120 VAC | 50 W | R88D-KTA5L | R88A-FIK102-RE | 2.4 | 3.5 |
| | 100 W | R88D-KT01L | R88A-FIK102-RE | 2.4 | 3.5 |
| | 200 W | R88D-KT02L | R88A-FIK104-RE | 4.1 | 3.5 |
| | 400 W | R88D-KT04L | R88A-FIK107-RE | 6.6 | 3.5 |
| Single-phase, 230 VAC | 100 W | R88D-KT01H | R88A-FIK102-RE | 2.4 | 3.5 |
| | 200 W | R88D-KT02H | R88A-FIK102-RE | 2.4 | 3.5 |
| | 400 W | R88D-KT04H | R88A-FIK104-RE | 4.1 | 3.5 |
| | 750 W | R88D-KT08H | R88A-FIK107-RE | 6.6 | 3.5 |
| | 1.0 kW | R88D-KT10H | R88A-FIK114-RE | 14.2 | 3.5 |
| | 1.5 kW | R88D-KT15H | R88A-FIK114-RE | 14.2 | 3.5 |
| Three-phase, 230 VAC | 2.0 kW | R88D-KT20H | R88A-FIK212-RE | 12 | 0.5/25 ¹ |
| | 3.0 kW | R88D-KT30H | R88A-FIK222-RE | 22 | 0.5/25 ¹ |
| | 5.0 kW | R88D-KT50H | R88A-FIK222-RE | 22 | 0.5/25 ¹ |
| | 7.5 kW | R88D-KT75H | - | - | - |
| Three-phase, 460 VAC | 600 W | R88D-KT06F | R88A-FIK304-RE | 4 | 0.3/32 ¹ |
| | 1.0 kW | R88D-KT10F | R88A-FIK304-RE | 4 | 0.3/32 ¹ |
| | 1.5 kW | R88D-KT15F | R88A-FIK304-RE | 4 | 0.3/32 ¹ |
| | 2.0 kW | R88D-KT20F | R88A-FIK306-RE | 6 | 0.3/32 ¹ |
| | 3.0 kW | R88D-KT30F | R88A-FIK312-RE | 12.1 | 0.3/32 ¹ |
| | 5.0 kW | R88D-KT50F | R88A-FIK312-RE | 12.1 | 0.3/32 ¹ |
| | 7.5 kW | R88D-KT75F | R88A-FIK330-RE | 22 | 0.3/40 ¹ |
| | 15 kW | R88D-KT150F | R88A-FIK350-RE | 44 | 2.0/130 ¹ |

Note: 1. Momentary peak leakage current for the filter at switch-on/off.

Reactors

| Analog/Pulse servo drive model | Reactor model |
|--------------------------------|---------------|
| R88D-KTA5L/-KT01H | 3G3AX-DL2002 |
| R88D-KT01L/-KT02H | 3G3AX-DL2004 |
| R88D-KT02L/-KT04H | 3G3AX-DL2007 |
| R88D-KT04L/-KT08H/-KT10H | 3G3AX-DL2015 |
| R88D-KT15H | 3G3AX-DL2022 |
| R88D-KT08H/-KT10H/-KT15H | 3G3AX-AL2025 |
| R88D-KT20H/-KT30H | 3G3AX-AL2055 |
| R88D-KT50H | 3G3AX-AL2110 |

Connectors

| Specifications | Model |
|---------------------------------------|-------------|
| I/O connector kit -50 pins-(for CN1) | R88A-CNU11C |
| External encoder connector (for CN4) | R88A-CNK41L |
| Safety I/O signal connector (for CN8) | R88A-CNK81S |

Computer software

| Specifications | Model |
|---|---------------|
| Sysmac Studio version 1.0 or higher | SYSMAC-SE2□□□ |
| CX-Drive version 2.10 or higher | CX-DRIVE 2.10 |
| CX-One software package including CX-Drive 2.10 or higher | CX-ONE |

Ordering Information

Encoder, Power and Brake Cables and Connectors



Note: The symbols ①②③... show the recommended sequence to select the servo motor and cables

Servo motor ① Select motor from R88M-K family using motor tables in next pages.

Servo drive ② Refer to Accurax G5 servo drive section for detailed drive specifications and selection of drive accessories.

Encoder cables for absolute and incremental encoders

| Symbol | Specifications | Model | Appearance | |
|--------|---|-------|--------------------|--|
| ③ | Encoder cable for Servomotors [120 V and 230 V] For 3,000-r/min motors of 50 to 750 W (for both absolute encoders and incremental encoders) | 1.5 m | R88A-CRKA001-5CR-E | |
| | | 3 m | R88A-CRKA003CR-E | |
| | | 5 m | R88A-CRKA005CR-E | |
| | | 10 m | R88A-CRKA010CR-E | |
| | | 15 m | R88A-CRKA015CR-E | |
| | | 20 m | R88A-CRKA020CR-E | |
| | Encoder cable for Servomotors [120 V and 230 V] For 3,000-r/min motors of 1.0 kW or more For 2,000-r/min motors For 1,000-r/min motors [460 V] For 3,000-r/min motors For 2,000-r/min motors For 1,500-r/min motors For 1,000-r/min motors | 1.5 m | R88A-CRKC001-5NR-E | |
| | | 3 m | R88A-CRKC003NR-E | |
| | | 5 m | R88A-CRKC005NR-E | |
| | | 10 m | R88A-CRKC010NR-E | |
| | | 15 m | R88A-CRKC015NR-E | |
| | | 20 m | R88A-CRKC020NR-E | |

Note: For servomotors fitted with an absolute encoder you have to add the extension battery cable R88A-CRGD0R3C□ (see below) or connect a backup battery in the CN1 I/O connector.

Note: Contact Omron for 30, 40 and 50 m long cables.

Ordering Information

Absolute Encoder Battery cable (encoder extension cable only)

| Symbol | Specifications | | | Model | Appearance |
|--------|---------------------------------|--------------------------------|-------|------------------|---|
| ④ | Absolute Encoder battery cable | Battery not included | 0.3 m | R88A-CRGD0R3C |  <p>Battery holder</p> |
| | | Battery included (R88A-BAT01G) | 0.3 m | R88A-CRGD0R3C-BS | |
| | Absolute Encoder backup battery | 2,000 mA.h 3.6 V | - | R88A-BAT01GE |  |

Motor Power Cables

| Symbol | Specifications | | | Model | Appearance |
|--|--|----------------------------------|--------------------|---|--|
| ⑤ | For 230 V servomotors R88M-K(050/100/200/400/750)30(H/T)□ Note: for servomotors with brake R88M-K(050/100/200/400/750)30(H/T)-BS2, the separate brake cable R88A-CAKA□□□BR-E is needed | Power cable only (without brake) | 1.5 m | R88A-CAKA001-5SR-E |  |
| | | | 3 m | R88A-CAKA003SR-E | |
| | | | 5 m | R88A-CAKA005SR-E | |
| | | | 10 m | R88A-CAKA010SR-E | |
| | | | 15 m | R88A-CAKA015SR-E | |
| | | | 20 m | R88A-CAKA020SR-E | |
| | For 230 V servomotors R88M-K(1K0/1K5)30(H/T)□ R88M-K(1K0/1K5)20(H/T)□ R88M-K90010(H/T)□ | without brake □-S2 | 1.5 m | R88A-CAGB001-5SR-E |  |
| | | | 3 m | R88A-CAGB003SR-E | |
| | | | 5 m | R88A-CAGB005SR-E | |
| | | | 10 m | R88A-CAGB010SR-E | |
| | | | 15 m | R88A-CAGB015SR-E | |
| | | | 20 m | R88A-CAGB020SR-E | |
| | For 230 V servomotors R88M-K(1K0/1K5)30(H/T)□ R88M-K(1K0/1K5)20(H/T)□ R88M-K90010(H/T)□ | with brake □-BS2 | 1.5 m | R88A-CAGB001-5BR-E |  |
| | | | 3 m | R88A-CAGB003BR-E | |
| | | | 5 m | R88A-CAGB005BR-E | |
| | | | 10 m | R88A-CAGB010BR-E | |
| | | | 15 m | R88A-CAGB015BR-E | |
| | | | 20 m | R88A-CAGB020BR-E | |
| | For 460 V servomotors R88M-K(750/1K0/1K5/2K)30(F/C)□ R88M-K(400/600/1K0/1K5/2K)20(F/C)□ R88M-K90010(F/C)□ | without brake □-S2 | 1.5 m | R88A-CAGB001-5SR-E |  |
| | | | 3 m | R88A-CAGB003SR-E | |
| | | | 5 m | R88A-CAGB005SR-E | |
| | | | 10 m | R88A-CAGB010SR-E | |
| | | | 15 m | R88A-CAGB015SR-E | |
| | | | 20 m | R88A-CAGB020SR-E | |
| For 460 V servomotors R88M-K(750/1K0/1K5/2K)30(F/C)□ R88M-K(400/600/1K0/1K5/2K)20(F/C)□ R88M-K90010(F/C)□ | with brake □-BS2 | 1.5 m | R88A-CAKF001-5BR-E |  | |
| | | 3 m | R88A-CAKF003BR-E | | |
| | | 5 m | R88A-CAKF005BR-E | | |
| | | 10 m | R88A-CAKF010BR-E | | |
| | | 15 m | R88A-CAKF015BR-E | | |
| | | 20 m | R88A-CAKF020BR-E | | |
| For 460 V servomotors R88M-K(3K0/4K0/5K0)30(F/C)□ R88M-K(3K0/4K0/5K0)20(F/C)□ R88M-K(2K0/3K0)10(F/C)□ R88M-K4K510C□ | without brake □-S2 | 1.5 m | R88A-CAGD001-5SR-E |  | |
| | | 3 m | R88A-CAGD003SR-E | | |
| | | 5 m | R88A-CAGD005SR-E | | |
| | | 10 m | R88A-CAGD010SR-E | | |
| | | 15 m | R88A-CAGD015SR-E | | |
| | | 20 m | R88A-CAGD020SR-E | | |
| For 460 V servomotors R88M-K(3K0/4K0/5K0)30(F/C)□ R88M-K(3K0/4K0/5K0)20(F/C)□ R88M-K(2K0/3K0)10(F/C)□ R88M-K4K510C□ | with brake □-BS2 | 1.5 m | R88A-CAGD001-5BR-E |  | |
| | | 3 m | R88A-CAGD003BR-E | | |
| | | 5 m | R88A-CAGD005BR-E | | |
| | | 10 m | R88A-CAGD010BR-E | | |
| | | 15 m | R88A-CAGD015BR-E | | |
| | | 20 m | R88A-CAGD020BR-E | | |
| For 460 V servomotors R88M-K6K010C□ R88M-K7K515C□ Note: for servomotors with brake R88MK (6K010/7K515)C-BS2 the separate brake cable R88A-CAGE□□□BR-E is needed | Power cable only (without brake) | 1.5 m | R88A-CAKE001-5SR-E |  | |
| | | 3 m | R88A-CAKE003SR-E | | |
| | | 5 m | R88A-CAKE005SR-E | | |
| | | 10 m | R88A-CAKE010SR-E | | |
| | | 15 m | R88A-CAKE015SR-E | | |
| | | 20 m | R88A-CAKE020SR-E | | |
| For 460 V servomotors R88M-K(11K0/15K0)15C Note: for servomotors with brake R88MK (11K0/15K0)15C-BS2, the separate brake cable R88A-CAGE□□□BR-E is needed | Power cable only (without brake) | 1.5 m | R88A-CAKG001-5SR-E |  | |
| | | 3 m | R88A-CAKG003SR-E | | |
| | | 5 m | R88A-CAKG005SR-E | | |
| | | 10 m | R88A-CAKG010SR-E | | |
| | | 15 m | R88A-CAKG015SR-E | | |
| | | 20 m | R88A-CAKG020SR-E | | |

Ordering Information

Brake cable (for 3000 r/min 50-750 W Motors)

| Symbol | Specifications | | Model | Appearance |
|--------|--|-------|--------------------|--|
| ⑥ | Brake cable only. For 230 V servo motors with brake R88M-K(050/100/200/400/750)30(H/T)-BS2 | 1.5 m | R88A-CAKA001-5BR-E |  |
| | | 3 m | R88A-CAKA003BR-E | |
| | | 5 m | R88A-CAKA005BR-E | |
| | | 10 m | R88A-CAKA010BR-E | |
| | | 15 m | R88A-CAKA015BR-E | |
| | | 20 m | R88A-CAKA020BR-E | |

Note: Contact Omron for 30, 40 and 50 m long cables.

Connectors for encoder, power and brake cables

| Specifications | | Applicable Servo motor | Model |
|--------------------------------------|------------------|--|---------------|
| Connectors for making encoder cables | Drive side (CN2) | All models | R88A-CNW01R |
| | Motor side | R88M-K(050/100/200/400/750)30(H/T)□ | R88A-CNK02R |
| Connectors for making power cables | Motor side | R88M-K(1K0/1K5)30(H/T)□ R88M-K(750/1K0/1K5/2K0/3K0/4K0/5K0)30(F/C)□ R88M-K(400/600/1K0/1K5/2K0/3K0/4K0/5K0)20□ R88M-K(900/2K0/3K0)10□ R88M-K(4K5/6K0)10C-□ R88M-K(7K5/11K0/15K0)15C-□ | R88A-CNK04R |
| | Motor side | R88M-K(050/100/200/400/750)30(H/T)□ | R88A-CNK11A |
| | Motor side | R88M-K(1K0/1K5)30(H/T)-S2 R88M-K(1K0/1K5)20(H/T)-S2 R88M-K90010(H/T)-S2 R88M-K(750/1K0/1K5/2K0)30(F/C)-S2, R88M-K(400/600/1K0/1K5/2K0)20(F/C)-S2 R88M-K90010(F/C)-S2 | MS3108E20-4S |
| | Motor side | R88M-K(1K0/1K5)30(H/T)-BS2 R88M-K(1K0/1K5)20(H/T)-BS2 R88M-K90010(H/T)-BS2 | MS3108E20-18S |
| | Motor side | R88M-K(750/1K0/1K5/2K0/3K0/4K0/5K0)30(F/C)-BS2 R88M-K(400/600/1K0/1K5/2K0/3K0/4K0/5K0)20(F/C)-BS2 R88M-K(900/2K0/3K0)10(F/C)-BS2 R88M-K4K510C-BS2 | MS3108E24-11S |
| | Motor side | R88M-K(3K0/4K0/5K0)30(F/C)-S2 R88M-K(3K0/4K0/5K0)20(F/C)-S2 R88M-K(2K0/3K0)10(F/C)-S2 R88M-K4K510C-S2 | MS3108E22-22S |
| Connector for brake cable | Motor side | R88M-K6K010C-□ R88M-K(7K5/11K0/15K0)15C-□ | MS3108E32-17S |
| | Motor side | R88M-K(050/100/200/400/750)30(H/T)-BS2 | R88A-CNK11B |
| | Motor side | R88M-K6K010C-BS2 R88M-K(7K5/11K0/15K0)15C-BS2 | MS3108E14S-2S |

Note: 1. All cables listed are flexible and shielded (except the R88A-CAKA□□□-BR-E which is only a flexible cable).
2. All connectors and cables listed have IP67 class (except R88A-CNW01R connector and R88A-CRGD0R3C cable).

ALL DIMENSIONS SHOWN ARE IN MILLIMETERS.

To convert millimeters into inches, multiply by 0.03937. To convert grams into ounces, multiply by 0.03527.

OMRON AUTOMATION AND SAFETY • THE AMERICAS HEADQUARTERS • Schaumburg, IL USA • 847.843.7900 • 800.556.6766 • www.omron247.com

OMRON CANADA, INC. • HEAD OFFICE

Toronto, ON, Canada • 416.286.6465 • 866.986.6766 • www.omron247.com

OMRON ELECTRONICS DE MEXICO • HEAD OFFICE

México DF • 52.55.59.01.43.00 • 001.800.556.6766 • mela@omron.com

OMRON ELECTRONICS DE MEXICO • SALES OFFICE

Apodaca, N.L. • 52.81.11.56.99.20 • 001.800.556.6766 • mela@omron.com

OMRON ELETRÔNICA DO BRASIL LTDA • HEAD OFFICE

São Paulo, SP, Brasil • 55.11.2101.6300 • www.omron.com.br

OMRON ARGENTINA • SALES OFFICE

Cono Sur • 54.11.4783.5300

OMRON CHILE • SALES OFFICE

Santiago • 56.9.9917.3920

OTHER OMRON LATIN AMERICA SALES

54.11.4783.5300

OMRON EUROPE B.V. • Wegalaan 67-69, NL-2132 JD, Hoofddorp, The Netherlands. • Tel: +31 (0) 23 568 13 00 • Fax: +31 (0) 23 568 13 88 • www.industrial.omron.eu

Authorized Distributor:

Automation Control Systems

- Machine Automation Controllers (MAC) • Programmable Controllers (PLC)
- Operator interfaces (HMI) • Distributed I/O • Software

Drives & Motion Controls

- Servo & AC Drives • Motion Controllers & Encoders

Temperature & Process Controllers

- Single and Multi-loop Controllers

Sensors & Vision

- Proximity Sensors • Photoelectric Sensors • Fiber-Optic Sensors
- Amplified Photomicrosensors • Measurement Sensors
- Ultrasonic Sensors • Vision Sensors

Industrial Components

- RFID/Code Readers • Relays • Pushbuttons & Indicators
- Limit and Basic Switches • Timers • Counters • Metering Devices
- Power Supplies

Safety

- Laser Scanners • Safety Mats • Edges and Bumpers • Programmable Safety Controllers • Light Curtains • Safety Relays • Safety Interlock Switches

Компания «Океан Электроники» предлагает заключение долгосрочных отношений при поставках импортных электронных компонентов на взаимовыгодных условиях!

Наши преимущества:

- Поставка оригинальных импортных электронных компонентов напрямую с производств Америки, Европы и Азии, а так же с крупнейших складов мира;
- Широкая линейка поставок активных и пассивных импортных электронных компонентов (более 30 млн. наименований);
- Поставка сложных, дефицитных, либо снятых с производства позиций;
- Оперативные сроки поставки под заказ (от 5 рабочих дней);
- Экспресс доставка в любую точку России;
- Помощь Конструкторского Отдела и консультации квалифицированных инженеров;
- Техническая поддержка проекта, помощь в подборе аналогов, поставка прототипов;
- Поставка электронных компонентов под контролем ВП;
- Система менеджмента качества сертифицирована по Международному стандарту ISO 9001;
- При необходимости вся продукция военного и аэрокосмического назначения проходит испытания и сертификацию в лаборатории (по согласованию с заказчиком);
- Поставка специализированных компонентов военного и аэрокосмического уровня качества (Xilinx, Altera, Analog Devices, Intersil, Interpoint, Microsemi, Actel, Aeroflex, Peregrine, VPT, Syfer, Eurofarad, Texas Instruments, MS Kennedy, Miteq, Cobham, E2V, MA-COM, Hittite, Mini-Circuits, General Dynamics и др.);

Компания «Океан Электроники» является официальным дистрибьютором и эксклюзивным представителем в России одного из крупнейших производителей разъемов военного и аэрокосмического назначения «JONHON», а так же официальным дистрибьютором и эксклюзивным представителем в России производителя высокотехнологичных и надежных решений для передачи СВЧ сигналов «FORSTAR».



JONHON

«JONHON» (основан в 1970 г.)

Разъемы специального, военного и аэрокосмического назначения:

(Применяются в военной, авиационной, аэрокосмической, морской, железнодорожной, горно- и нефтедобывающей отраслях промышленности)

«FORSTAR» (основан в 1998 г.)

ВЧ соединители, коаксиальные кабели, кабельные сборки и микроволновые компоненты:

(Применяются в телекоммуникациях гражданского и специального назначения, в средствах связи, РЛС, а так же военной, авиационной и аэрокосмической отраслях промышленности).



Телефон: 8 (812) 309-75-97 (многоканальный)

Факс: 8 (812) 320-03-32

Электронная почта: ocean@oceanchips.ru

Web: <http://oceanchips.ru/>

Адрес: 198099, г. Санкт-Петербург, ул. Калинина, д. 2, корп. 4, лит. А