

A

B

C

D

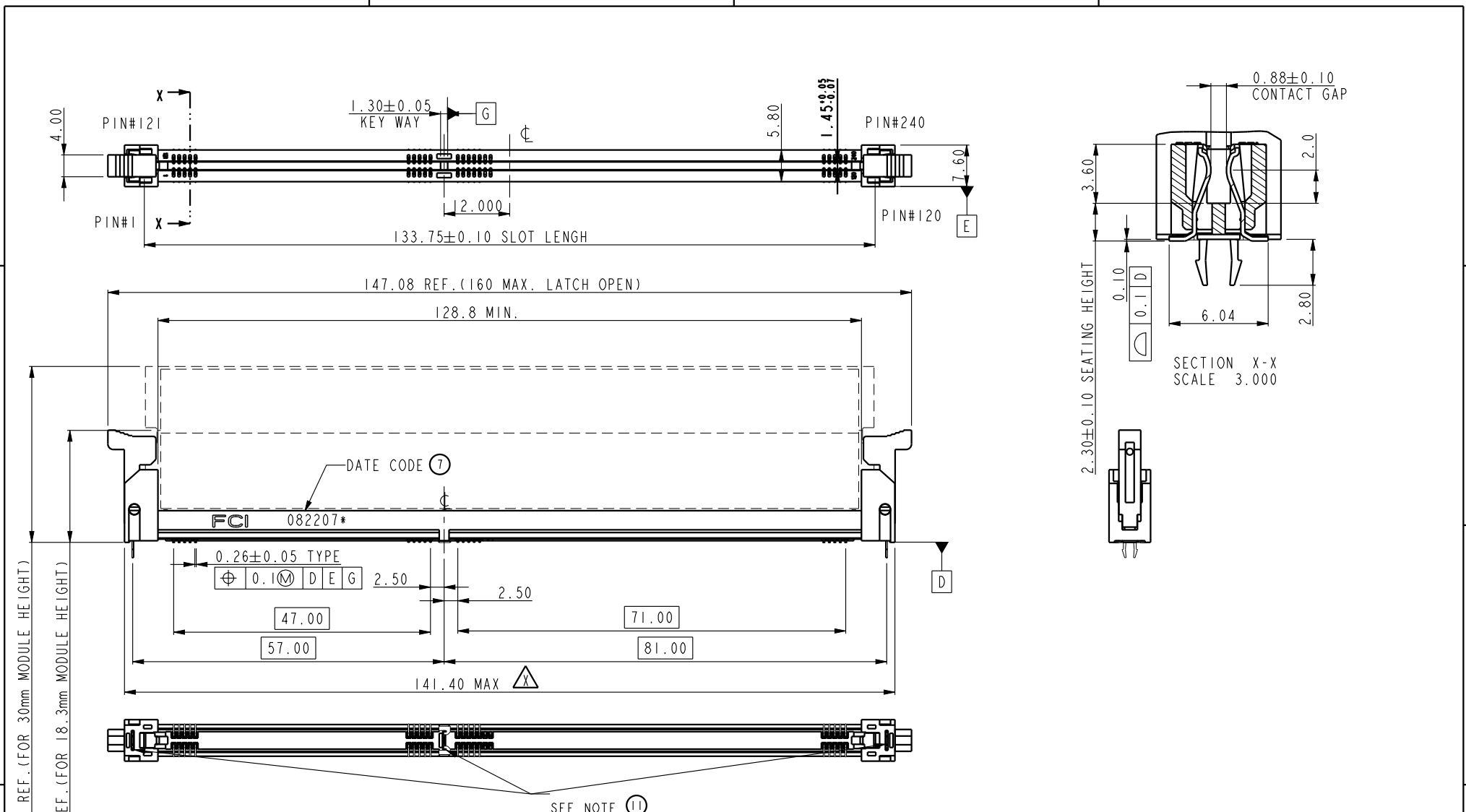

32.20 REF. (FOR 30mm MODULE HEIGHT)  
20.50 REF. (FOR 18.3mm MODULE HEIGHT)

spec ref	*		
tolerance std	ASME Y14.5	TOLERANCES UNLESS OTHERWISE SPECIFIED	
surface	linear	0.X	±0.30
		0.XX	±0.15
		0.XXX	±0.05
	angular	0°	±2°

dr	Rick Bian	2010/07/04
eng	Jeny Ren	2018/02/08
chr	-	-
appr	Nickor Zuo	2018/02/09

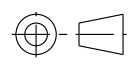
projection  

mm  

size	A4	scale	0.500
ecn no	ELX-DG-28885-1		
rel level	Released		

Amphenol FCi www.fci.com	title	SMT DDRIII SOCKET ASS'Y		dwg no	10079248	rev	Y
	cat. no.	* Product - Customer Drw					

A

B

C

D

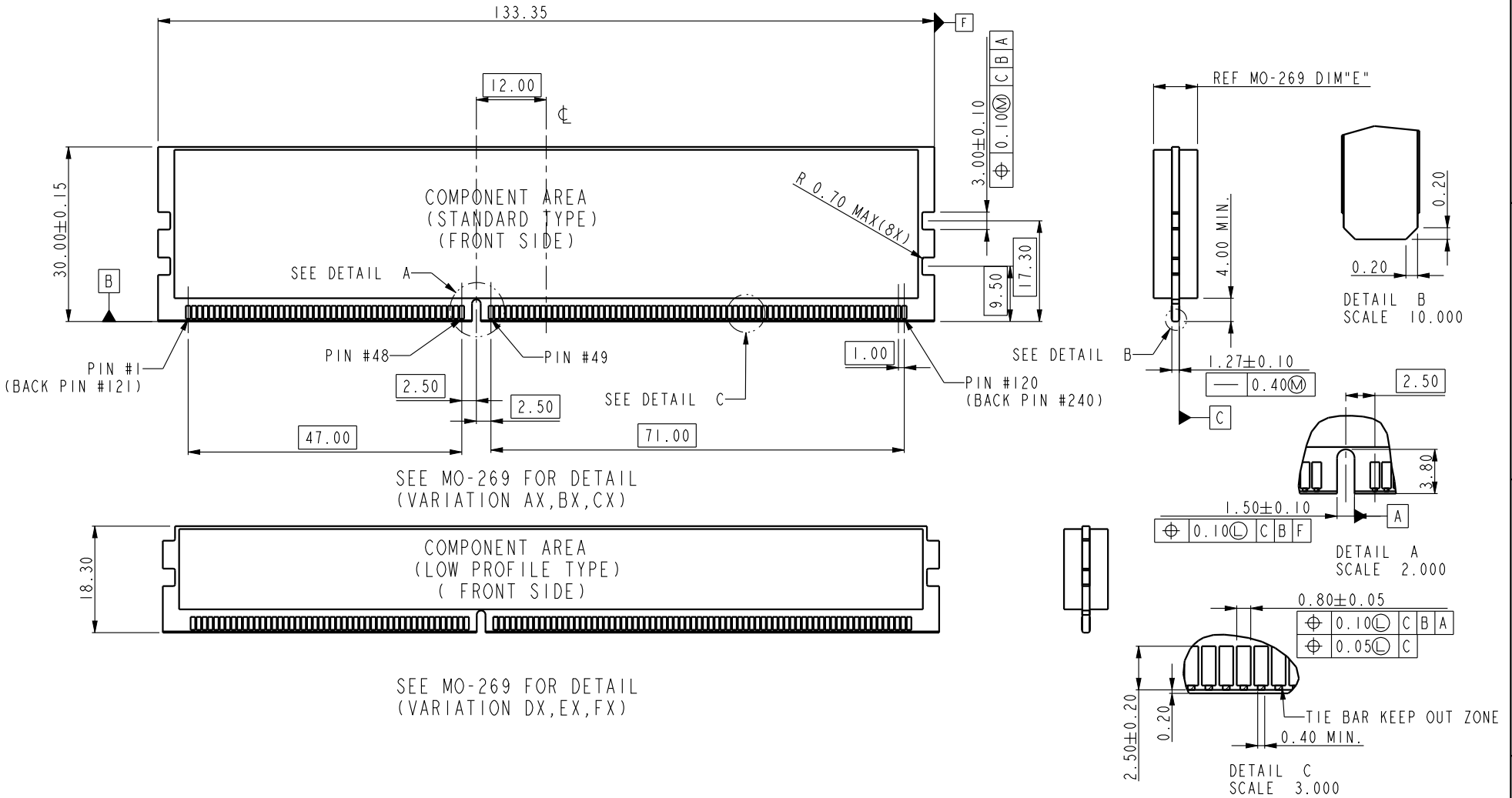

spec ref	*	dr	Rick Bian	2010/07/04	projection	mm	size	A4	scale	0.500
tolerance std	ASME Y14.5	eng	Jeny Ren	2018/02/08			ecn no	ELX-DG-28885-1		
TOLERANCES UNLESS OTHERWISE SPECIFIED		chr	-	-				rel level	Released	
surface		appr	Nickor Zuo	2018/02/09	product family			rev		
ASME Y14.5		linear	0.X	±0.30	SMT DDRIII SOCKET ASS'Y			10079248		
			0.XX	±0.15	DDRIII, 240P SOCKET (FOR RDIMM MODULE)			Y		
			0.XXX	±0.05	cat. no.			Product - Customer Drw		
	angular		0°	±2°	www.fci.com			sheet 2 of 5		

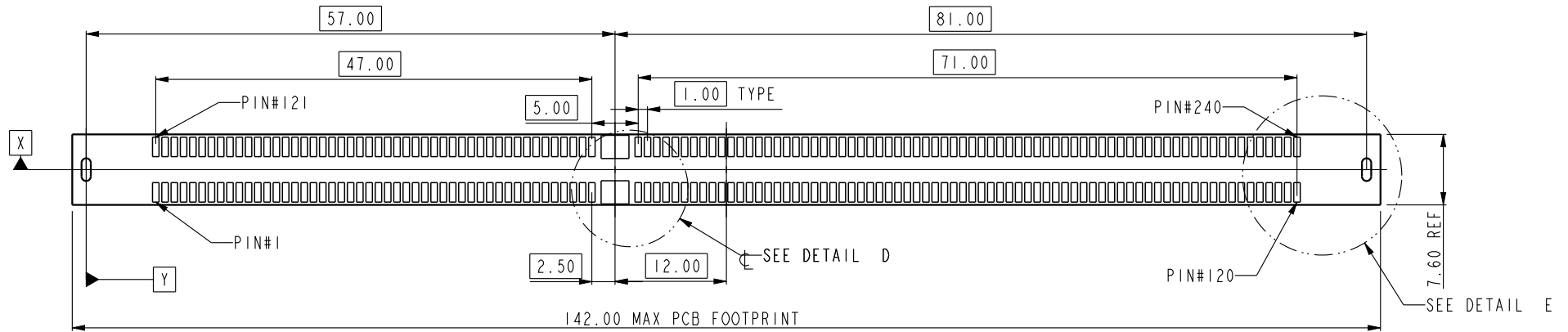

RECOMMEND CIRCUIT BOARD LAYOUT

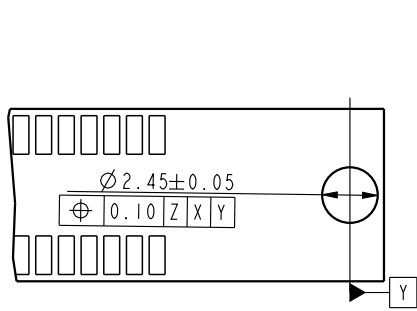

DETAIL E  
SCALE 3.000  
Standard hole for  
hold-down clips

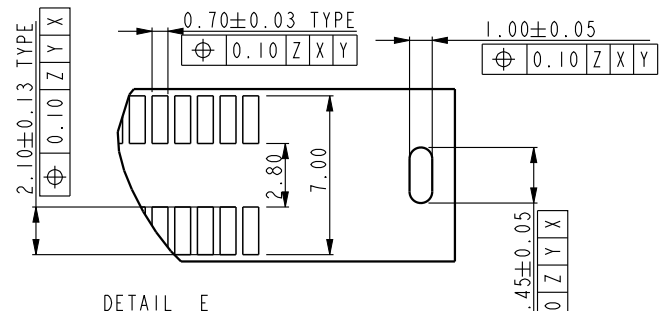

DETAIL E  
SCALE 3.000  
For paste-in-hole applications.  
Can be used to solder clips  
during reflow operation.

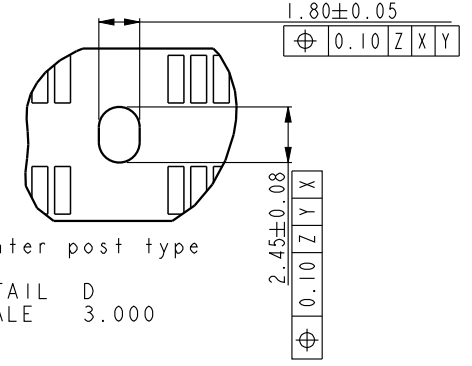

Center post type  
DETAIL D  
SCALE 3.000

spec ref *		dr <b>Rick Bian</b>		2010/07/04		projection		size A4		scale 0.500			
tolerance std		eng <b>Jeny Ren</b>		2018/02/08				mm		ecn no <b>ELX-DG-28885-1</b>			
ASME Y14.5		chr -		-						rel level <b>Released</b>			
surface		appr <b>Nickor Zuo</b>		2018/02/09		product family		rev		10079248			
 ASME Y14.5		linear		0.X ±0.30		<b>Amphenol FCI</b> title SMT DDRIII SOCKET ASS'Y DDRIII,240P SOCKET(FOR RDIMM MODULE)		www.fci.com		cat. no. * Product - Customer Drw		sheet 3 of 5	
		angular		0° ±2°								Y	

A

B

C

D



SCALE 0.500

10079248-10\*\*\*  
CENTER SMT HOLDOWN TYPE



SCALE 0.500

10079248-11\*\*\*  
3 FORK LOCK TYPE



SCALE 0.500

10079248-12\*\*\*  
3 SMT HOLDOWN TYPE

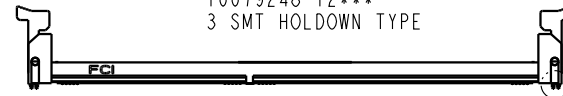

SCALE 0.500

10079248-13\*\*\*  
3 SMT HOLDOWN AND 2 PLASTIC POST TYPE

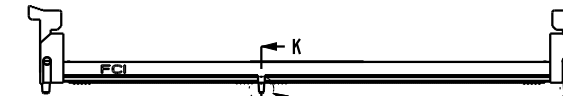

SCALE 0.500

10079248-15\*\*\*  
3 PLASTIC POST TYPE

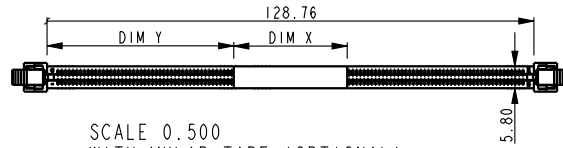

SCALE 0.500  
WITH MYLAR TAPE (OPTIONAL)

10079248 - □ □ □ □

STYLE : MECHANICAL KEYING

1 : 1.5 VOLT. W/ CENTER KEY

HOLD DOWN TYPE

- 0 : CENTER HOLD DOWN, FORKLOCK AT BOTH END
- 1 : 3 FORKLOCK TYPE
- 2 : 3 SMT HOLDOWN TYPE
- 3 : 3 SMT HOLDOWN AND 2 PLASTIC POST
- 5 : 3 PLASTIC POST TYPE

PACKAGE AND MYLAR OPTION

- ~~0 : SOFT TRAY WITHOUT MYLAR (OBSOLETE)~~
- 1 : HARD TRAY WITH MYLAR 1
- 2 : HARD TRAY WITHOUT MYLAR
- ~~3 : SOFT TRAY WITH MYLAR 1 (OBSOLETE)~~
- 4 : SPECIAL HARD TRAY WITH MYLAR 1
- 5 : SPECIAL HARD TRAY WITHOUT MYLAR
- 6 : HARD TRAY WITH MYLAR 2
- 7 : HARD TRAY WITH MYLAR 3
- 8 : HARD TRAY WITH MYLAR 4
- 9 : SMALLER HARD TRAY WITHOUT MYLAR

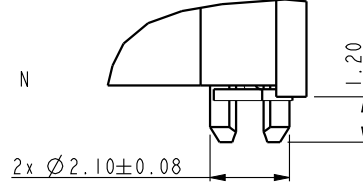

DETAIL N  
SCALE 5.000

PLATING

CODE	CONTACT	SOLDERTAIL	UNDERPLATE	NOTE
1	10u" (0.25um) MIN. GOLD	100u" (2.54um) MIN. TIN-LEAD	50u" (1.27um) MIN. NICKEL OVERALL	CONTACT NON-LUBRICANT
2	15u" (0.38um) MIN. GOLD			
3	30u" (0.76um) MIN. GOLD			
4	GOLD FLASH			
5	10u" (0.25um) MIN. GOLD			CONTACT LUBRICATED
6	15u" (0.38um) MIN. GOLD			
7	30u" (0.76um) MIN. GOLD			
8	GOLD FLASH			
3S	5u" (0.125um) MIN. GOLD			CONTACT LUBRICATED WITH HIGH PERFORMANCE POLY A-OLEFIN LUBRICANT
1LF	10u" (0.25um) MIN. GOLD	100u" (2.54um) MIN. 100% MATT TIN	50u" (1.27um) MIN. NICKEL OVERALL	CONTACT NON-LUBRICANT
2LF	15u" (0.38um) MIN. GOLD			
3LF	30u" (0.76um) MIN. GOLD			
4LF	GOLD FLASH			
5LF	10u" (0.25um) MIN. GOLD			CONTACT LUBRICATED
6LF	15u" (0.38um) MIN. GOLD			
7LF	30u" (0.76um) MIN. GOLD			
8LF	GOLD FLASH			
3SLF	5u" (0.125um) MIN. GOLD			CONTACT LUBRICATED WITH HIGH PERFORMANCE POLY A-OLEFIN LUBRICANT
7SLF	30u" (0.76um) MIN. GOLD			

COLOR OF HOUSING AND EJECTOR

- 0 : BLACK HOUSING + IVORY EJECTOR
- 1 : BLACK HOUSING + BLACK EJECTOR
- 2 : BLACK HOUSING + BLUE(661C) EJECTOR
- 3 : BLACK HOUSING + YELLOW(123C) EJECTOR

spec ref	*	dr	Rick Bian	2010/07/04	projection	mm	size	A4	scale	0.500
tolerance std	ASME Y14.5	eng	Jeny Ren	2018/02/08			ecn no	ELX-DG-28885-1		
TOLERANCES UNLESS OTHERWISE SPECIFIED		chr	-	-				rel level	Released	
surface		appr	Nickor Zuo	2018/02/09	product family	SMT DDRIII SOCKET ASS'Y			rev	Y
linear		0.X	±0.30							
linear		0.XX	±0.15							
linear	0.XXX	±0.05								
angular	0°	±2°	www.fci.com	cat. no.	*	Product - Customer Drw	sheet 4 of 5			

A

B

C

D

A

B

C

D



DETAIL E  
SCALE 3.000

For smt holddown type

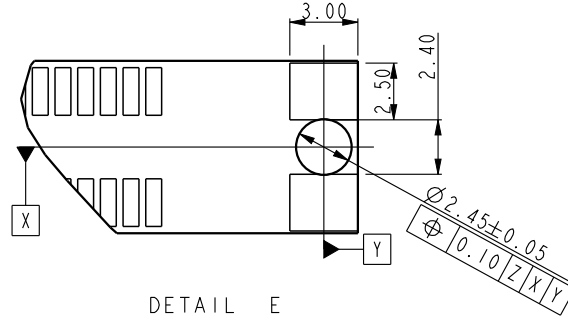

DETAIL E  
SCALE 3.000

For 3smt holddown + 2plastic post type

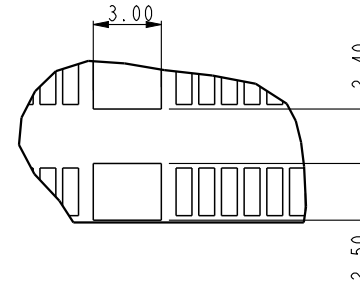

Center smt holddown type

DETAIL D  
SCALE 3.000

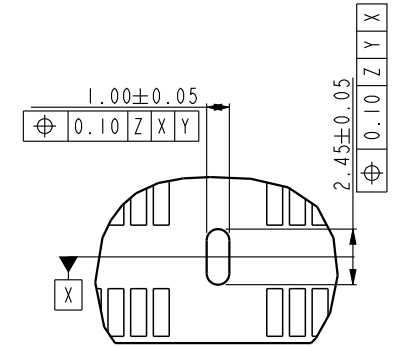

Center forklock type

DETAIL D  
SCALE 3.000

NOTES:

1. MATERIAL:  
HOUSING: HIGH PERFORMANCE RESINS, GLASS FILLED UL94V-0 RATED.  
EJECTOR: HIGH PERFORMANCE RESINS, GLASS FILLED UL94V-0 RATED.  
TERMINAL: HIGH PERFORMANCE COPPER ALLOY  
METAL CLIP: COPPER ALLOY.
2. FCI LOGO TO BE APPROXIMATELY LOCATED AS SHOWN ON PRINT.
3. PRODUCT SPECIFICATION: GS-12-486.
4. PACKAGING SPECIFICATION: GS-14-899.
5. RECOMMENDED STENCIL THICKNESS NO LESS THAN 0.15 mm.
6. FOR OPTIMUM PERFORMANCE. THE TIE BAR IS TO BE ON AN INTERNAL LAYER SO THAT THE REMNANT CANNOT CAUSE CONTACT DAMAGE.
7. THE DATE CODE IS SHOWN "MMDDYY\*": "\*" MEANS PRODUCTION LINE.
8. THIS PRODUCT MEETS EUROPEAN UNION DIRECTIVES AND OTHER COUNTRY REGULATIONS AS DESCRIBED IN GS-22-008.
9. THE HOUSING WILL WITH STAND EXPOSURE TO 260°C PEAK TEMPERATURE FOR 10 SECONDS IN AN IR REFLOW SOLDERING APPLICATION.
10. PRODUCT APPLICATION SPEC GS-20-089.
11. THE HOLDOWN TYPES ARE OPTION FOR HOLDOWN OR FORKLOCK.

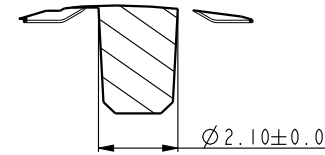

SECTION K-K  
SCALE 5.000

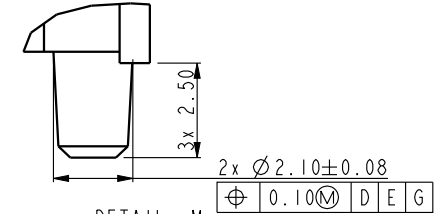

DETAIL M  
SCALE 5.000

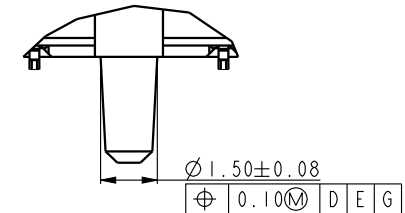

DETAIL J  
SCALE 5.000

spec ref *		dr <b>Rick Bian</b>		2010/07/04		projection		size		scale							
tolerance std		eng <b>Jeny Ren</b>		2018/02/08				A4		0.500							
ASME Y14.5		chr -		-				ecn no		ELX-DG-28885-1							
TOLERANCES UNLESS OTHERWISE SPECIFIED		appr <b>Nickor Zuo</b>		2018/02/09		product family		rel level		Released							
surface				<b>Amphenol FCI</b>		title SMT DDRIII SOCKET ASS'Y DDRIII,240P SOCKET(FOR RDIMM MODULE)		dwg no 10079248		rev Y							
ASME Y14.5												linear		0.X		±0.30	
												angular		0°		±2°	
www.fci.com		cat. no.		*		Product - Customer Drw		sheet 5 of 5									

Компания «Океан Электроники» предлагает заключение долгосрочных отношений при поставках импортных электронных компонентов на взаимовыгодных условиях!

Наши преимущества:

- Поставка оригинальных импортных электронных компонентов напрямую с производств Америки, Европы и Азии, а так же с крупнейших складов мира;
- Широкая линейка поставок активных и пассивных импортных электронных компонентов (более 30 млн. наименований);
- Поставка сложных, дефицитных, либо снятых с производства позиций;
- Оперативные сроки поставки под заказ (от 5 рабочих дней);
- Экспресс доставка в любую точку России;
- Помощь Конструкторского Отдела и консультации квалифицированных инженеров;
- Техническая поддержка проекта, помощь в подборе аналогов, поставка прототипов;
- Поставка электронных компонентов под контролем ВП;
- Система менеджмента качества сертифицирована по Международному стандарту ISO 9001;
- При необходимости вся продукция военного и аэрокосмического назначения проходит испытания и сертификацию в лаборатории (по согласованию с заказчиком);
- Поставка специализированных компонентов военного и аэрокосмического уровня качества (Xilinx, Altera, Analog Devices, Intersil, Interpoint, Microsemi, Actel, Aeroflex, Peregrine, VPT, Syfer, Eurofarad, Texas Instruments, MS Kennedy, Miteq, Cobham, E2V, MA-COM, Hittite, Mini-Circuits, General Dynamics и др.);

Компания «Океан Электроники» является официальным дистрибьютором и эксклюзивным представителем в России одного из крупнейших производителей разъемов военного и аэрокосмического назначения «JONHON», а так же официальным дистрибьютором и эксклюзивным представителем в России производителя высокотехнологичных и надежных решений для передачи СВЧ сигналов «FORSTAR».



## JONHON

«JONHON» (основан в 1970 г.)

Разъемы специального, военного и аэрокосмического назначения:

(Применяются в военной, авиационной, аэрокосмической, морской, железнодорожной, горно- и нефтедобывающей отраслях промышленности)

«FORSTAR» (основан в 1998 г.)

ВЧ соединители, коаксиальные кабели, кабельные сборки и микроволновые компоненты:

(Применяются в телекоммуникациях гражданского и специального назначения, в средствах связи, РЛС, а так же военной, авиационной и аэрокосмической отраслях промышленности).



Телефон: 8 (812) 309-75-97 (многоканальный)

Факс: 8 (812) 320-03-32

Электронная почта: [ocean@oceanchips.ru](mailto:ocean@oceanchips.ru)

Web: <http://oceanchips.ru/>

Адрес: 198099, г. Санкт-Петербург, ул. Калинина, д. 2, корп. 4, лит. А