

## Main

Range of product	Preventa Safety detection
Product or component type	Safety light curtain type 2
Device short name	XUSL2E
Output type	2 safety outputs OSSD solid-state PNP (integrated arc suppression)
Product specific application	For hand protection
Minimum object diameter for detection	1.18 in (30 mm)
[Sn] nominal sensing distance	0...3 m by cabling 3...10 m by cabling
Height protected	29.92 in (760 mm)
Number of beams	38
Type of start	Automatic Manual
Control type	Selected by wiring

## Complementary

Detection system	Transmitter-receiver system
Response time	11 ms
Kit composition	Adjustable mounting bracket(s) 1 receiver(s) 1 transmitter(s) 1 user guide with certificate of conformity on CD-ROM Silicone o-ring(s) 1 PVC cable(s)
[EAA] effective aperture angle	+/- 5 ° at 3 m
Emission	IR LED ( $\lambda = 950$ nm)
[Us] rated supply voltage	24 V DC (+/- 20 %)
Supply	Power supply must meet requirements of IEC 61496-1 Power supply must meet requirements of IEC 60204-1
[Ie] rated operational current	2 A
Current consumption	42 mA no-load (transmitter) 83 mA no-load (receiver) 42 mA (transmitter) 900 mA with maximum load (receiver)
Output current limits	0.4 A for safety outputs OSSD
Output voltage	24 V
Output circuit type	DC
Voltage drop	$\leq 0.5$ V
Local signalling	1 multi-colour LED (transmitter) 2 dual colour LEDs (receiver)
Electrical connection	1 male connector M12 5 pins (transmitter) 1 male connector M12 8 pins (receiver)
Type of cable	AWG 22 unshielded cable of 32.81 ft (10 m)
Ohmic cable resistance	55.31 mOhm
Function available	Test Muting through external safety module XPSLCMUT1160 LED display of operating modes and faults Anti-condensation system
Marking	CE
Material	Tube: PMMA (polymethyl methacrylate) Sealing plug: stainless steel AISI 316L

The information provided in this documentation contains general descriptions and/or technical characteristics of the performance of the products contained herein. This documentation is not intended as a substitute for and is not to be used for determining suitability or reliability of these products for specific user applications. It is the duty of any such user or integrator to perform the appropriate and complete risk analysis, evaluation and testing of the products with respect to the relevant specific application or use thereof. Neither Schneider Electric Industries SAS nor any of its affiliates or subsidiaries shall be responsible or liable for misuse of the information contained herein.

	Cable: PVC (polyvinyl chloride)
Housing colour	RAL 3000: red
Fixing mode	By fixing brackets
Product weight	11.13 lb(US) (5.05 kg)
Offer type	Standard distance
Provided equipment	Without heating system

## Environment

directives	89/336/EEC - electromagnetic compatibility 2002/96/EC - WEEE directive 2002/95/EC - RoHS directive 98/37/EEC - machinery 89/655/EEC - work equipment
product certifications	CE CULus TÜV Ecolab
safety level	Type 2 conforming to IEC 61496-1 Category 2 conforming to EN/ISO 13849-1 SIL 1 conforming to IEC 61508 SILCL 1 conforming to IEC 62061 PL = c conforming to EN/ISO 13849-1
environmental characteristic	Resistance to light disturbance conforming to EN/IEC 61496-2
service life	20 yr
safety reliability data	PFHd = 4.57E-8 1/h conforming to IEC 61508
ambient air temperature for operation	-22...131 °F (-30...55 °C) 14...131 °F
ambient air temperature for storage	-22...158 °F (-30...70 °C) -13...158 °F
relative humidity	0...95 % without condensation
IP degree of protection	IP69K
shock resistance	10 gn 16 ms conforming to IEC 61496-1
vibration resistance	

## Offer Sustainability

Green Premium product	Green Premium product
Compliant - since 1425 - Schneider Electric declaration of conformity	Compliant - since 1425 - Schneider Electric declaration of conformity
Reference not containing SVHC above the threshold	Reference not containing SVHC above the threshold
Available	Available
Available	Available
WARNING: This product can expose you to chemicals including:	WARNING: This product can expose you to chemicals including:
Diisononyl phthalate (DINP), which is known to the State of California to cause cancer, and	Diisononyl phthalate (DINP), which is known to the State of California to cause cancer, and
Di-isodecyl phthalate (DIDP), which is known to the State of California to cause birth defects or other reproductive harm.	Di-isodecyl phthalate (DIDP), which is known to the State of California to cause birth defects or other reproductive harm.
For more information go to <a href="http://www.p65warnings.ca.gov">www.p65warnings.ca.gov</a>	For more information go to <a href="http://www.p65warnings.ca.gov">www.p65warnings.ca.gov</a>

## Dimensions

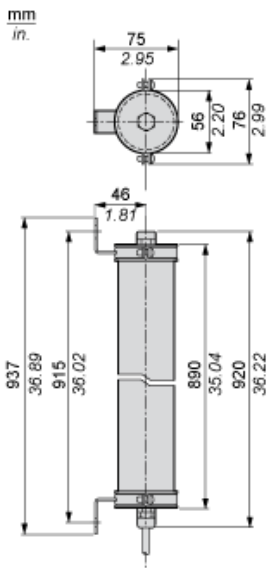

## Mounting and Clearance



## Wiring Diagrams

### Transmitter Pre-wired

- Brown: +24 Vdc
- White: Configuration\_0
- Blue: 0 Vdc
- Green or Black: Configuration\_1
- Grey: Functional Earth
- Pink: Not connected

### Receiver pre-wired

- White: Output signal switching device 1
- Brown: +24 Vdc
- Green: Output signal switching device 2
- Yellow: Configuration\_A
- Grey: K1\_K2 Feedback/Restart
- Pink: Configuration\_B
- Blue: 0 Vdc
- Yellow/Green (or Red): Functional Earth

For configuration\_A and configuration\_B, please refer to receiver configuration and operating modes

## Receiver Configurations and Operating Modes

### Automatic Start/Restart

Without External Device Monitoring (EDM) feedback loop



With External Device Monitoring (EDM) feedback loop

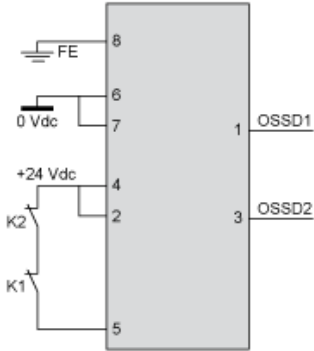

### Manual Start/Restart

Without External Device Monitoring (EDM) feedback loop



(1) Restart

With External Device Monitoring (EDM) feedback loop



(1) Restart

### Connecting to a Safety Interface

**Discover XUSL4E14F016N by**

- Characteristics
- Dimensions Drawings
- Mounting and Clearance
- Connections and Schema
- **Download & Documents**

**Download & Documents 1 to 9 of 9**

**Image of product**

Generic image for XUSL standard sensing distance.	SILENT 2014-12-11	(See ▼)
---	-------------------	---------

**Product environmental**

XUSL4E..., XUSL2E... Safety Light Curtain, Product Environmental Profile	English 2014-09-08	pdf ▼
--	--------------------	-------

**End of life manual**

XUSL4E..., XUSL2E... Safety Light Curtain, Product End-of-Life Instructions	English 2014-09-08	pdf ▼
---	--------------------	-------

**Application solutions**

Safety light curtains association with safety interfaces	English 2016-01-08	pdf ▼
--	--------------------	-------

**Catalog**

Safety light curtains Preventa XUSL	English 2015-05-18	pdf ▼
-------------------------------------	--------------------	-------

**User guide**

XUSL2E..., XUSL4E... Type 2 and Type 4 Safety Light Curtains, User Manual	English 2015-06-25	pdf ▼
---	--------------------	-------

1 : Click on Download & Documents

2 : Click on Application solutions

To have all connection schematics concerning our safety module, select "download and document" and download the file "Safety light curtains association with safety interfaces"

Компания «Океан Электроники» предлагает заключение долгосрочных отношений при поставках импортных электронных компонентов на взаимовыгодных условиях!

Наши преимущества:

- Поставка оригинальных импортных электронных компонентов напрямую с производств Америки, Европы и Азии, а так же с крупнейших складов мира;
- Широкая линейка поставок активных и пассивных импортных электронных компонентов (более 30 млн. наименований);
- Поставка сложных, дефицитных, либо снятых с производства позиций;
- Оперативные сроки поставки под заказ (от 5 рабочих дней);
- Экспресс доставка в любую точку России;
- Помощь Конструкторского Отдела и консультации квалифицированных инженеров;
- Техническая поддержка проекта, помощь в подборе аналогов, поставка прототипов;
- Поставка электронных компонентов под контролем ВП;
- Система менеджмента качества сертифицирована по Международному стандарту ISO 9001;
- При необходимости вся продукция военного и аэрокосмического назначения проходит испытания и сертификацию в лаборатории (по согласованию с заказчиком);
- Поставка специализированных компонентов военного и аэрокосмического уровня качества (Xilinx, Altera, Analog Devices, Intersil, Interpoint, Microsemi, Actel, Aeroflex, Peregrine, VPT, Syfer, Eurofarad, Texas Instruments, MS Kennedy, Miteq, Cobham, E2V, MA-COM, Hittite, Mini-Circuits, General Dynamics и др.);

Компания «Океан Электроники» является официальным дистрибьютором и эксклюзивным представителем в России одного из крупнейших производителей разъемов военного и аэрокосмического назначения «JONHON», а так же официальным дистрибьютором и эксклюзивным представителем в России производителя высокотехнологичных и надежных решений для передачи СВЧ сигналов «FORSTAR».



## JONHON

«JONHON» (основан в 1970 г.)

Разъемы специального, военного и аэрокосмического назначения:

(Применяются в военной, авиационной, аэрокосмической, морской, железнодорожной, горно- и нефтедобывающей отраслях промышленности)

«FORSTAR» (основан в 1998 г.)

ВЧ соединители, коаксиальные кабели, кабельные сборки и микроволновые компоненты:

(Применяются в телекоммуникациях гражданского и специального назначения, в средствах связи, РЛС, а так же военной, авиационной и аэрокосмической отраслях промышленности).



Телефон: 8 (812) 309-75-97 (многоканальный)

Факс: 8 (812) 320-03-32

Электронная почта: [ocean@oceanchips.ru](mailto:ocean@oceanchips.ru)

Web: <http://oceanchips.ru/>

Адрес: 198099, г. Санкт-Петербург, ул. Калинина, д. 2, корп. 4, лит. А