

# Agilent HDSP-331x/332E/333x/334x Series 7.62 mm (0.3 inch) General Purpose Seven-Segment Display Data Sheet



## Description

This 7.62 mm (0.3 inch) LED seven-segment display uses industry standard size package and pinout. The device is available in either common anode

or common cathode. The choice of colors includes High Efficiency Red (HER), Green, AlGaAs Red, and Yellow. The gray face displays are suitable for indoor use.

## Features

- **Industry standard size**
- **Industry standard pinout**  
7.62 mm (0.4 inch) character height  
DIP lead on 2.54 mm
- **Choice of colors**  
High Efficiency Red (HER), Green, AlGaAs Red, and Yellow
- **Excellent appearance**  
Evenly lighted segments gray package gives optimum contrast  
 $\pm 50^\circ$  viewing angle
- **Design flexibility**  
Common anode or common cathode  
Single digit  
Left and right hand decimal point
- **Categorized for luminous intensity**  
Green and yellow categorized for color

## Applications

- **Suitable for indoor use**
- **Not recommended for industrial application, i.e., operating temperature requirements exceeding  $+85^\circ\text{C}$  or below  $-25^\circ\text{C}$ <sup>[1]</sup>**
- **Extreme temperature cycling not recommended**

## Note:

1. For additional details, please contact your local Agilent sales office or an authorized distributor.

## Devices

HER	Green	AlGaAs Red	Yellow	Description	Package Drawing
HDSP-331E	HDSP-331G	HDSP-331A	HDSP-331Y	Common Anode, Right Hand and Left Hand Decimal	A
HDSP-332E				Common Anode, Right Hand and Left Hand Decimal without Pin 4, 5 and 12	A
HDSP-333E	HDSP-333G	HDSP-333A	HDSP-333Y	Common Cathode, Right Hand Decimal	B
HDSP-334E	HDSP-334G	HDSP-334A	HDSP-334Y	Common Cathode, Right Hand Decimal	C



## Part Numbering System

5082 -X X X X-X X X X X

HDSP-X X X X-X X X X X



### Notes:

1. For codes not listed in the figure above, please refer to the respective datasheet or contact your nearest Agilent representative for details.
2. Bin options refer to shippable bins for a part number. Color and Intensity Bins are typically restricted to 1 bin per tube (exceptions may apply). Please refer to respective datasheet for specific bin limit information.

# Package Dimensions

## Package Drawing A

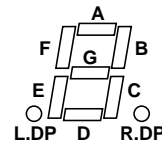
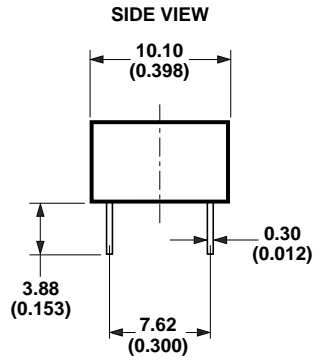
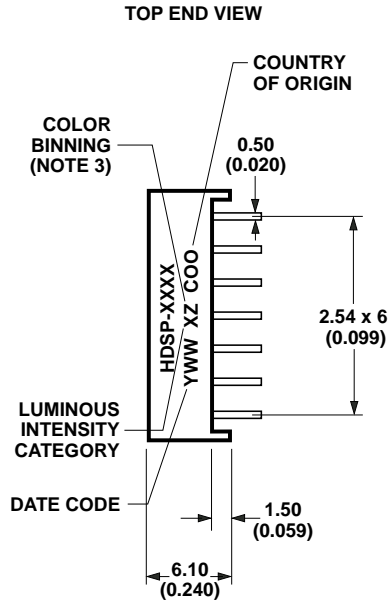
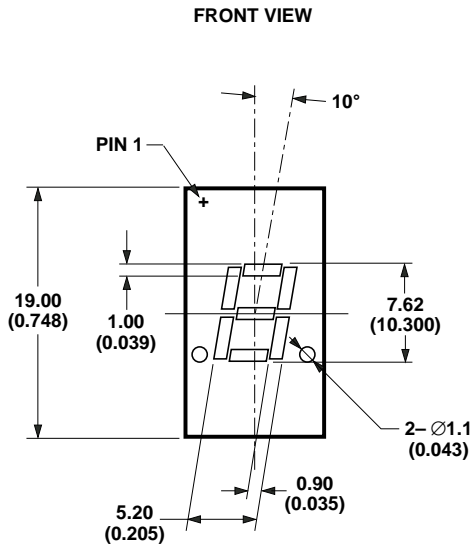

DIMENSIONS IN MILLIMETERS (INCHES)

NOTE: HDSP-332E DOES NOT HAVE PIN 4, 5 AND 12.

# Package Dimensions

## Package Drawing B

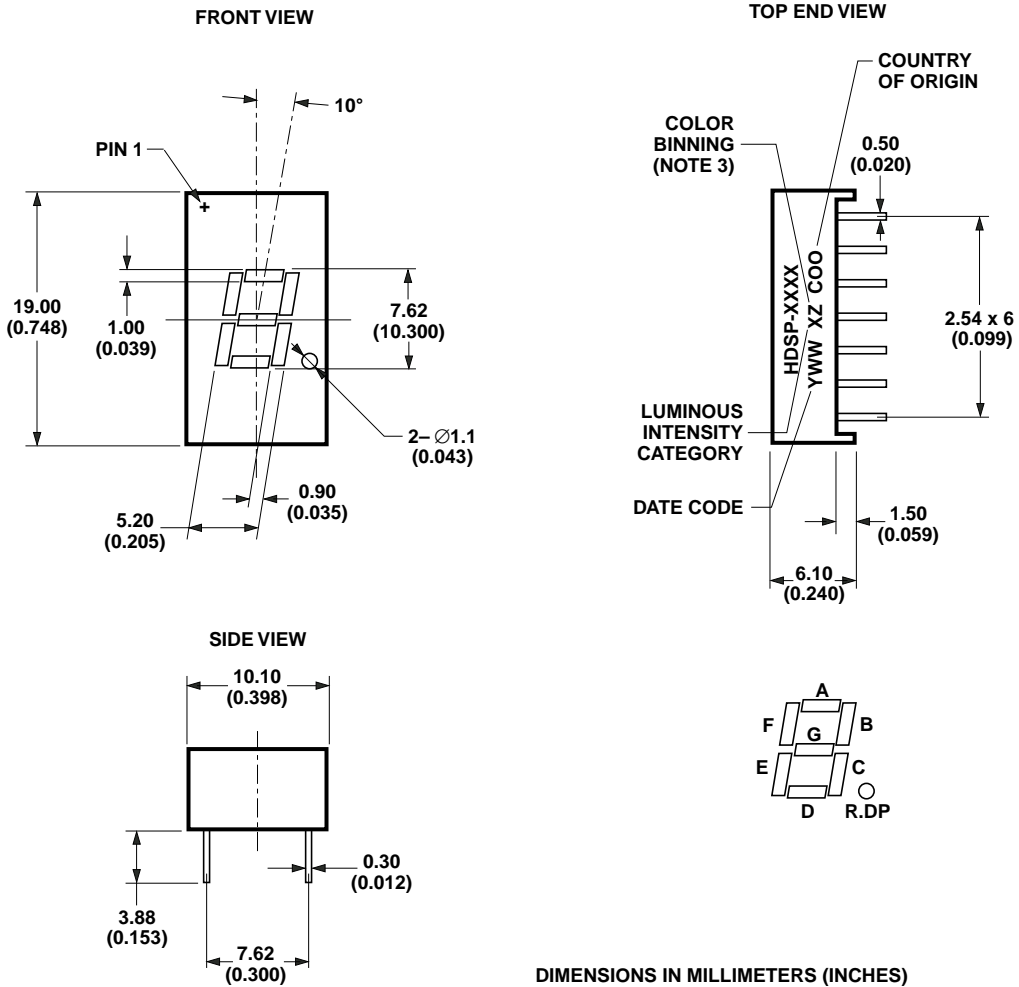

DIMENSIONS IN MILLIMETERS (INCHES)

# Package Dimensions

## Package Drawing C

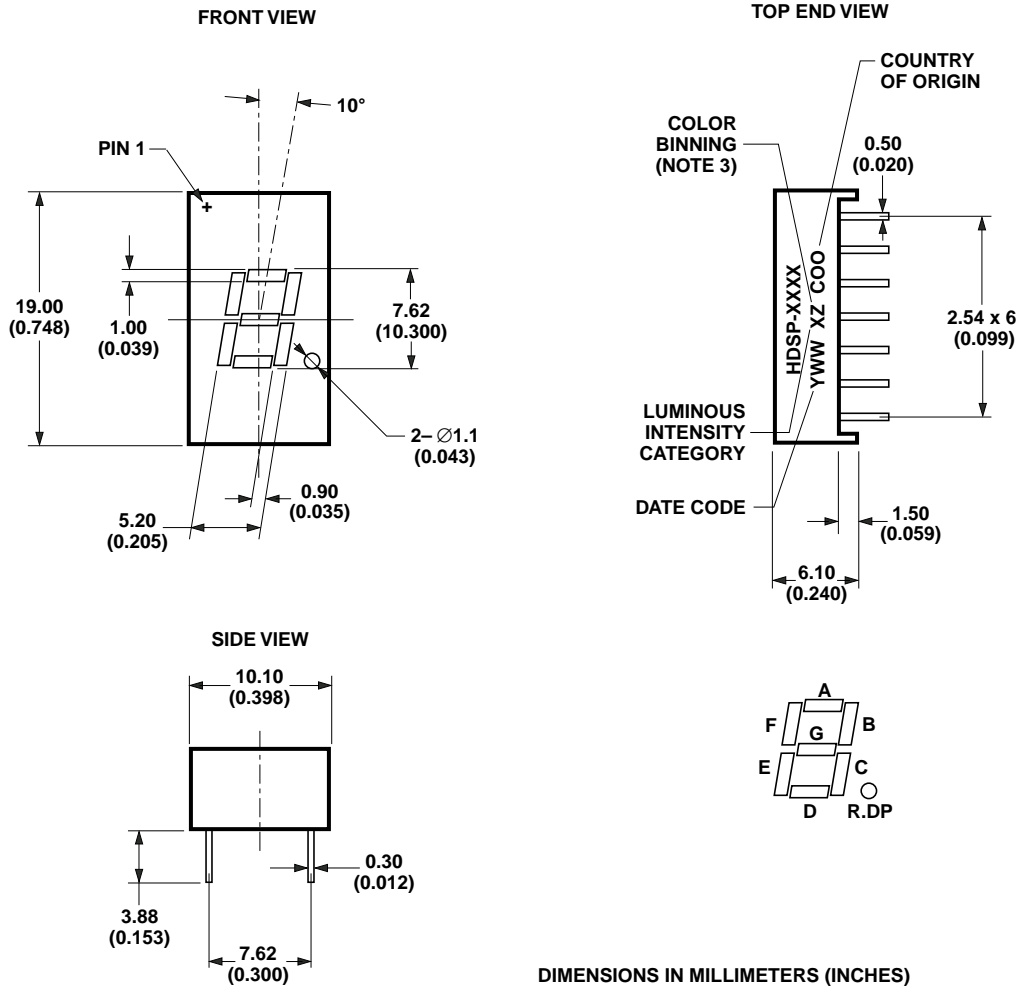

DIMENSIONS IN MILLIMETERS (INCHES)

## Internal Circuit Diagram

### Common Anode



HDSP-331E/331G/331Y/331A/332E

PIN NO.	CONNECTION
1	CATHODE A
2	CATHODE F
3	COMMON ANODE
6	CATHODE L.DP
7	CATHODE E
8	CATHODE D
9	CATHODE R.DP
10	CATHODE C
11	CATHODE G
13	CATHODE B
14	COMMON ANODE
PINS 4, 5, 12: NO CONNECTION FOR HDSP-331E/331G/331Y/331A AND NO PIN FOR HDSP-332E	

### Common Cathode

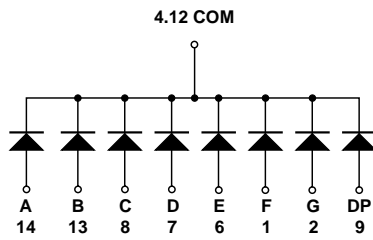

HDSP-333E/333G/333Y/333A

PIN NO.	CONNECTION
1	ANODE F
2	ANODE G
4	COMMON CATHODE
6	ANODE E
7	ANODE D
8	ANODE C
9	ANODE DP
12	COMMON CATHODE
13	ANODE B
14	ANODE A
PINS 3, 5, 10, 11: NC	

## Internal Circuit Diagram

Common Cathode



HDSP-334E/334G/334Y/334A

PIN NO.	CONNECTION
1	COMMON CATHODE
2	ANODE E
3	ANODE G
4	ANODE F
5	ANODE D
6	COMMON CATHODE
7	ANODE DP
8	ANODE C
9	ANODE B
10	ANODE A
PINS 11, 12, 13, 14: NC	

### Absolute Maximum Ratings at T<sub>A</sub> = 25 °C

Description	HER HDSP-33xE	Green HDSP-33xG	AlGaAs Red HDSP-33xA	Yellow HDSP-33xY	Units
Power Dissipation Segment	65	65	30	52	mW
Forward Current Segment	25 <sup>[1]</sup>	25 <sup>[2]</sup>	15 <sup>[3]</sup>	20 <sup>[4]</sup>	mA
Peak Forward Current per Segment (1/10 Duty Factor at 10 kHz)	100	100	80	80	mA
Operating Temperature Range	-35 to +85	-35 to +85	-35 to +85	-35 to +85	°C
Storage Temperature Range	-35 to +85	-35 to +85	-35 to +85	-35 to +85	°C
Reverse Voltage per Segment or DP	5	5	5	5	V
Wave Soldering Temperature for 3 Seconds (at 2 mm Distance from the Body)	250	250	250	250	°C

**Notes:**

1. Derate above 25 °C at 0.33 mA/°C.
2. Derate above 25 °C at 0.33 mA/°C.
3. Derate above 25 °C at 0.2 mA/°C.
4. Derate above 25 °C at 0.27 mA/°C.

### Electrical/Optical Characteristics at T<sub>A</sub> = 25 °C

#### High Efficiency Red (HER)

Devices							
HDSP-	Parameter	Symbol	Min.	Typ.	Max.	Units	Test Conditions
	Luminous Intensity/Segment	I <sub>V</sub>		1.15		mcd	I <sub>F</sub> = 5 mA
			0.8	1.80		mcd	I <sub>F</sub> = 10 mA
331E	Forward Voltage	V <sub>F</sub>		2.05	2.40	V	I <sub>F</sub> = 20 mA
332E	Peak Wavelength	λ <sub>PEAK</sub>		635		nm	
333E	Dominant Wavelength	λ <sub>d</sub>		620		nm	
334E	Reverse Voltage	VR	5			V	I <sub>R</sub> = 100 μA

#### Green

Devices							
HDSP-	Parameter	Symbol	Min.	Typ.	Max.	Units	Test Conditions
	Luminous Intensity/Segment	I <sub>V</sub>	0.8	2.00		mcd	I <sub>F</sub> = 10 mA
				2.07		V	I <sub>F</sub> = 10 mA
331G	Forward Voltage	V <sub>F</sub>	1.80	2.25	2.60	V	I <sub>F</sub> = 20 mA
333G	Peak Wavelength	λ <sub>PEAK</sub>		568		nm	
334G	Dominant Wavelength	λ <sub>d</sub>		573		nm	
	Reverse Voltage	VR	5			V	I <sub>R</sub> = 100 μA



## AlGaAs Red

Devices							
HDSP-	Parameter	Symbol	Min.	Typ.	Max.	Units	Test Conditions
331A 333A 334A	Luminous Intensity/Segment	$I_V$		3.93		mcd	$I_F = 5 \text{ mA}$
			2.001	4.20		mcd	$I_F = 10 \text{ mA}$
	Forward Voltage	$V_F$		1.85	2.00	V	$I_F = 20 \text{ mA}$
	Peak Wavelength	$\lambda_{PEAK}$		660		nm	
	Dominant Wavelength	$\lambda_d$		643		nm	
	Reverse Voltage	$V_R$	5			V	$I_R = 100 \mu\text{A}$

## Yellow

Devices							
HDSP-	Parameter	Symbol	Min.	Typ.	Max.	Units	Test Conditions
331Y 333Y 334Y	Luminous Intensity/Segment	$I_V$		0.71		mcd	$I_F = 5 \text{ mA}$
			0.80	1.50		mcd	$I_F = 10 \text{ mA}$
	Forward Voltage	$V_F$		2.15	2.60	V	$I_F = 20 \text{ mA}$
	Peak Wavelength	$\lambda_{PEAK}$		595		nm	
	Dominant Wavelength	$\lambda_d$		590		nm	
	Reverse Voltage	$V_R$	5			V	$I_R = 100 \mu\text{A}$

## Intensity Bin Limits (mcd at 10 mA)

Bin Name	HER/Green/Yellow		AlGaAs Red	
	Min. <sup>[1]</sup>	Max. <sup>[1]</sup>	Min. <sup>[1]</sup>	Max. <sup>[1]</sup>
G	0.801	1.250	NA	NA
H	1.251	2.000	NA	NA
I	2.001	3.200	2.001	3.200
J	NA	NA	3.201	5.050
K	NA	NA	5.051	8.000

**Note:**

1. Tolerance for each bin limit is  $\pm 10\%$ .

## Color Bin Limits (nm at 10 mA)

Color	Bin	Dominant Wavelength (nm)	
		Min. <sup>[1]</sup>	Max. <sup>[1]</sup>
Green	3	569.1	571.0
	4	571.1	573.0
	5	573.1	575.0
Yellow	1	585.5	588.5
	2	588.5	591.5
	3	591.5	594.5

**Note:**

1. Tolerance for each bin limit is 1 nm.

## High Efficiency Red (HER)

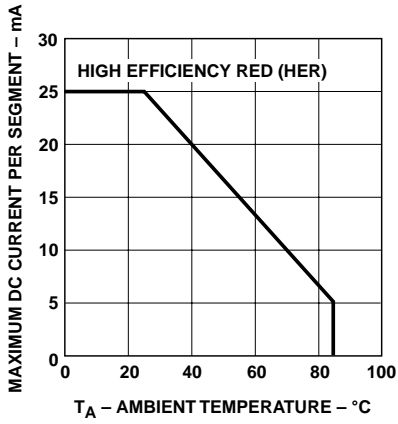

Figure 1. Maximum allowable average or DC current vs. ambient temperature.

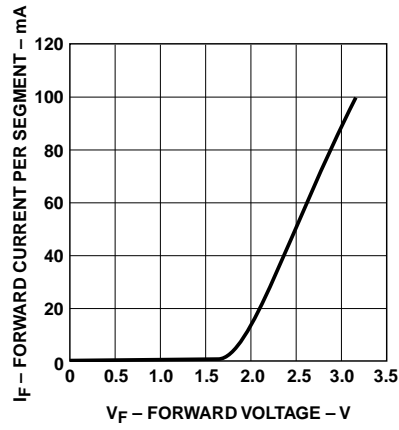

Figure 2. Forward current vs. forward voltage.

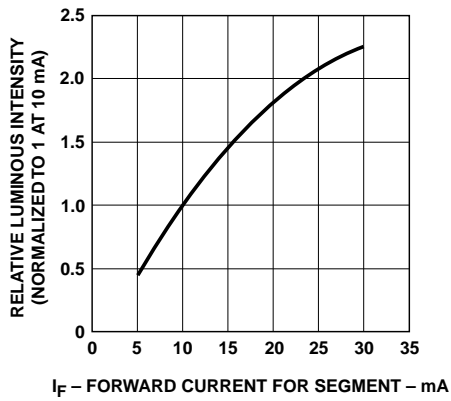

Figure 3. Relative luminous intensity vs. DC forward current.

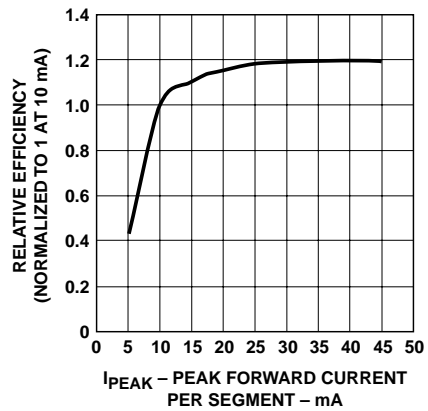

Figure 4. Relative efficiency (luminous intensity per unit current) vs. peak current.

## Green

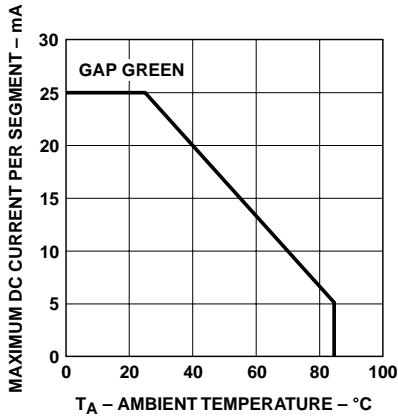

Figure 5. Maximum allowable average or DC current vs. ambient temperature.



Figure 6. Forward current vs. forward voltage.



Figure 7. Relative luminous intensity vs. DC forward current.



Figure 8. Relative efficiency (luminous intensity per unit current) vs. peak current.

## AlGaAs Red

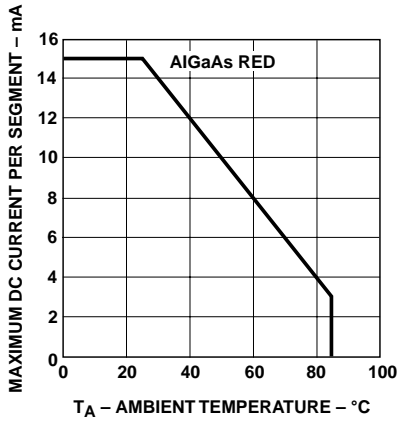

Figure 9. Maximum allowable average or DC current vs. ambient temperature.

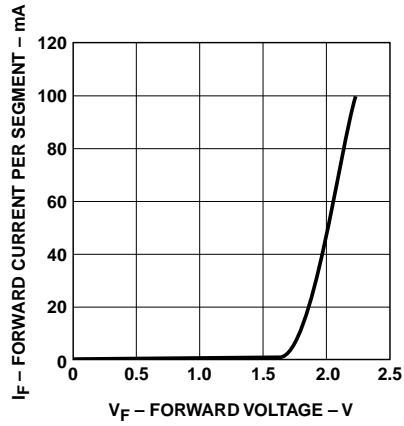

Figure 10. Forward current vs. forward voltage.



Figure 11. Relative luminous intensity vs. DC forward current.



Figure 12. Relative efficiency (luminous intensity per unit current) vs. peak current.

## Yellow

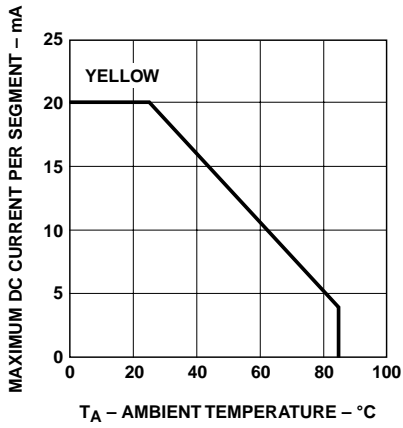

Figure 13. Maximum allowable average or DC current vs. ambient temperature.

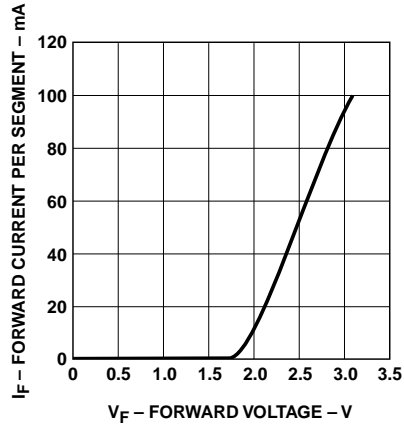

Figure 14. Forward current vs. forward voltage.

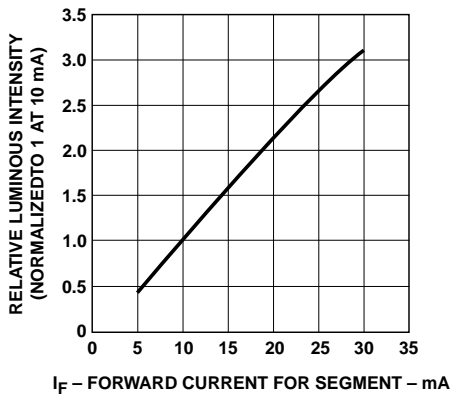

Figure 15. Relative luminous intensity vs. DC forward current.

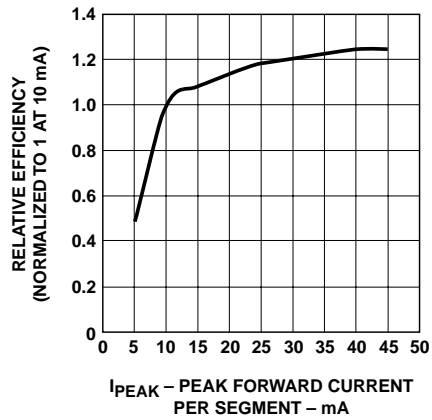

Figure 16. Relative efficiency (luminous intensity per unit current) vs. peak current.

**[www.agilent.com/semiconductors](http://www.agilent.com/semiconductors)**

For product information and a complete list of distributors, please go to our web site.

For technical assistance call:

Americas/Canada: +1 (800) 235-0312 or (916) 788-6763

Europe: +49 (0) 6441 92460

China: 10800 650 0017

Hong Kong: (+65) 6756 2394

India, Australia, New Zealand: (+65) 6755 1939

Japan: (+81 3) 3335-8152(Domestic/International), or 0120-61-1280(Domestic Only)

Korea: (+65) 6755 1989

Singapore, Malaysia, Vietnam, Thailand, Philippines, Indonesia: (+65) 6755 2044

Taiwan: (+65) 6755 1843

Data subject to change.

Obsoletes 5988-2971EN

July 17, 2004

5988-9421EN

Компания «Океан Электроники» предлагает заключение долгосрочных отношений при поставках импортных электронных компонентов на взаимовыгодных условиях!

Наши преимущества:

- Поставка оригинальных импортных электронных компонентов напрямую с производств Америки, Европы и Азии, а так же с крупнейших складов мира;
- Широкая линейка поставок активных и пассивных импортных электронных компонентов (более 30 млн. наименований);
- Поставка сложных, дефицитных, либо снятых с производства позиций;
- Оперативные сроки поставки под заказ (от 5 рабочих дней);
- Экспресс доставка в любую точку России;
- Помощь Конструкторского Отдела и консультации квалифицированных инженеров;
- Техническая поддержка проекта, помощь в подборе аналогов, поставка прототипов;
- Поставка электронных компонентов под контролем ВП;
- Система менеджмента качества сертифицирована по Международному стандарту ISO 9001;
- При необходимости вся продукция военного и аэрокосмического назначения проходит испытания и сертификацию в лаборатории (по согласованию с заказчиком);
- Поставка специализированных компонентов военного и аэрокосмического уровня качества (Xilinx, Altera, Analog Devices, Intersil, Interpoint, Microsemi, Actel, Aeroflex, Peregrine, VPT, Syfer, Eurofarad, Texas Instruments, MS Kennedy, Miteq, Cobham, E2V, MA-COM, Hittite, Mini-Circuits, General Dynamics и др.);

Компания «Океан Электроники» является официальным дистрибьютором и эксклюзивным представителем в России одного из крупнейших производителей разъемов военного и аэрокосмического назначения «JONHON», а так же официальным дистрибьютором и эксклюзивным представителем в России производителя высокотехнологичных и надежных решений для передачи СВЧ сигналов «FORSTAR».



## JONHON

«JONHON» (основан в 1970 г.)

Разъемы специального, военного и аэрокосмического назначения:

(Применяются в военной, авиационной, аэрокосмической, морской, железнодорожной, горно- и нефтедобывающей отраслях промышленности)

«FORSTAR» (основан в 1998 г.)

ВЧ соединители, коаксиальные кабели,  
кабельные сборки и микроволновые компоненты:

(Применяются в телекоммуникациях гражданского и специального назначения, в средствах связи, РЛС, а так же военной, авиационной и аэрокосмической отраслях промышленности).



Телефон: 8 (812) 309-75-97 (многоканальный)

Факс: 8 (812) 320-03-32

Электронная почта: [ocean@oceanchips.ru](mailto:ocean@oceanchips.ru)

Web: <http://oceanchips.ru/>

Адрес: 198099, г. Санкт-Петербург, ул. Калинина, д. 2, корп. 4, лит. А