

FEATURES

- UL60950-1 recognised
- EN60950-1 certified²
- EN/IEC61558-1 recognition pending
- ANSI/AAMI ES60601-1, 1 MOPP/2 MOOP's recognition pending
- Wide input voltage range 85-305VAC/70-400VDC
- Operating temperature range -40°C to 85°C
- 4kVAC isolation 'Hi Pot Test'
- 5V, 12V & 24V single regulated outputs
- Short circuit protection
- No optocoupler
- Low standby power

PRODUCT OVERVIEW

The BAC1 series is the first series release from the BAC family of board mount AC/DC converters. The BAC1 series operates over the wide industrial temperature range of -40°C to +85°C, supporting operation in still air for the most demanding environments. Models are capable of operation to 85°C, and operate from -40°C. The BAC1 has ultra low standby power consumption for demanding energy and cost saving applications.



For full details go to www.murata-ps.com/rohs



SELECTION GUIDE

| Order Code | Output Power W | Output Voltage V | Output Current A | Ripple & Noise | | | | | | Efficiency | | | | | | Isolation Capacitance | | MTTF ¹ | |
|------------------|-------------------|---------------------|---------------------|----------------|------|------|------|------|------|------------|------|------|------|----|---------|-----------------------|------|-------------------|--|
| | | | | 115V & 230V | | 277V | | 115V | | 230V | | 277V | | pF | MIL 217 | Telcordia | kHrs | | |
| | | | | Typ. | Max. | Typ. | Max. | Min. | Typ. | Min. | Typ. | Min. | Typ. | | | | | | |
| | | | | mVp-p | | | | | | % | | | | | | | | | |
| BAC1S05SC | 1 | 5 | 0.2 | 50 | 120 | 50 | 120 | 70 | 74 | 69 | 73 | 67 | 71 | 11 | 1613 | 38213 | | | |
| BAC1S12SC | 1 | 12 | 0.083 | 60 | 120 | 60 | 130 | 70 | 74 | 69 | 73 | 68 | 72 | 11 | 2038 | 44328 | | | |
| BAC1S24SC | 1 | 24 | 0.042 | 85 | 120 | 100 | 150 | 68 | 73 | 67 | 71 | 64 | 69 | 11 | 1816 | 40463 | | | |

INPUT CHARACTERISTICS

| Parameter | Conditions | Min. | Typ. | Max. | Units |
|-----------------------|-------------------------------|--------|-------------|------|-------|
| Voltage range | All input types | 85 | 115/230/277 | 305 | VAC |
| | All input types | 70 | | 400 | VDC |
| Input frequency | | 47 | 50/60 | 63 | Hz |
| Switching frequency | Nominal Vin = 115VAC | | 50 | | kHz |
| | Nominal Vin = 115VAC | 24Vin | 35 | | |
| | Nominal Vin = 230VAC/277VAC | | 40 | | |
| | Nominal Vin = 230VAC/277VAC | 24Vin | 25 | | |
| Input current | Nominal Vin = 115VAC | | 25 | | mA |
| | Nominal Vin = 230VAC | | 17 | | |
| | Nominal Vin = 277VAC | | 16 | | |
| Inrush current | Nominal Vin = 115VAC | | 6 | | A |
| | Nominal Vin = 230VAC & 277VAC | | 9 | | |
| Input leakage current | 230VAC | | 1 | | µA |
| Stand by power | BAC1S05SC | 115VAC | | 20 | mW |
| | | 230VAC | | 61 | |
| | | 277VAC | | 85 | |
| | BAC1S12SC | 115VAC | | 58 | |
| | | 230VAC | | 68 | |
| | | 277VAC | | 92 | |
| | BAC1S24SC | 115VAC | | 26 | |
| | | 230VAC | | 81 | |
| | | 277VAC | | 117 | |

ISOLATION CHARACTERISTICS

| Parameter | Conditions | Min. | Typ. | Max. | Units |
|------------------------|-----------------------------------|------|------|------|-------|
| Isolation test voltage | Production tested for 1 seconds | 4000 | | | VAC |
| | Qualification tested for 1 minute | 4000 | | | |
| Resistance | Viso = 1000VDC | 100 | | | MΩ |

1. Calculated using MIL-HDBK-217F FN2 and Telcordia SR-332 calculation model at T_A=25°C with nominal input voltage at full load.
2. Pending for 277VAC.

All specifications typical at T_A=25°C, nominal input voltage, rated output current and recommended components unless otherwise specified.

| OUTPUT CHARACTERISTICS | | | | | |
|--------------------------|--|------------------------|------|------|-------|
| Parameter | Conditions | Min. | Typ. | Max. | Units |
| Minimum load | | 5 | | | % |
| Initial voltage accuracy | 5V output types | | | ±5 | % |
| | All other output types | | | ±4 | |
| Line regulation | Low line to high line | 5V output types | | ±0.3 | % |
| | | All other output types | | ±0.1 | |
| Load Regulation | 5% total load to 100% total load | | ±0.2 | ±1.5 | % |
| Total regulation | Includes line, load, temperature and drift | | | ±5 | % |
| Temperature coefficient | | | | 0.05 | %/°C |
| Transient Response | Peak deviation - Single Output (50-75% & 75-50% swing) | BAC1S05SC | | ±4 | %Vout |
| | | BAC1S12SC | | ±3 | |
| | | BAC1S24SC | | ±2 | |
| | Settling time (within 1% Vout Nom.) | 24V output type | | 8 | ms |
| All other output types | | 6 | | | |
| Current limit inception | Auto-recovery | 115VAC & 230VAC | | 150 | % |
| | | 277VAC | | 150 | |
| Hold up time | From power fail | 115VAC | | 50 | ms |
| | | 230VAC | | 240 | |
| | | 277VAC | | 380 | |
| | | | | | |

| TEMPERATURE CHARACTERISTICS | | | | | |
|--|-----------------------------|------|------|------|-------|
| Parameter | Conditions | Min. | Typ. | Max. | Units |
| Operation | Sealed box with no air flow | -40 | | 85 | °C |
| Storage | | -40 | | 125 | |
| Product temperature rise above ambient | | | | 16 | |

| ABSOLUTE MAXIMUM RATINGS | |
|---|--|
| Short-circuit protection | Continuous |
| Input voltage Vin | 310VAC |
| Wave solder | Wave Solder profile not to exceed the profile recommended in IEC 61760-1 Section 6.1.3. Please refer to application notes for further information. |
| Lead temperature 1.0mm from case for 7 seconds (to JEDEC JESD22-B106 ISS E) | 270°C |

TECHNICAL NOTES**ISOLATION VOLTAGE**

'Hi Pot Test', 'Flash Tested', 'Withstand Voltage', 'Proof Voltage', 'Dielectric Withstand Voltage' & 'Isolation Test Voltage' are all terms that relate to the same thing, a test voltage, applied for a specified time, across a component designed to provide electrical isolation, to verify the integrity of that isolation.

Murata Power Solutions BAC1 series of AC-DC converters are all 100% production tested at their stated isolation voltage. This is 4kVAC for 3 seconds.

A question commonly asked is, "What is the continuous voltage that can be applied across the part in normal operation?"

The BAC1 series has been recognised by Underwriters Laboratory to 277VAC for Reinforced Insulation.

The BAC1 series has been certified by Demko to 240VAC for Reinforced Insulation.

REPEATED HIGH-VOLTAGE ISOLATION TESTING

It is well known that repeated high-voltage isolation testing of a barrier component can actually degrade isolation capability, to a lesser or greater degree depending on materials, construction and environment. We therefore strongly advise against repeated high voltage isolation testing, but if it is absolutely required, that the voltage be reduced by 20% from specified test voltage.

SAFETY APPROVAL**ANSI/AAMI ES60601-1**

The BAC1 series is pending recognition by Underwriters Laboratory (UL) to ANSI/AAMI ES60601-1 and provides 2 MOOP (Means Of Operator Protection) and 1 MOPP (means of patient protection) based upon a working voltage of 277VAC max., between Primary and Secondary. File number E202895 applies.

EN60950-1

The BAC1 series has been certified by Demko (D) to EN60950 for reinforced insulation to a working voltage of 240VAC, pending for 277VAC. File number D-07177 applies.

UL60950-1

The BAC1 series has been recognised by Underwriters Laboratory (UL) to UL60950 for reinforced insulation to a working voltage of 277VAC. File number E151252 applies.

Creepage 8.3mm and clearance 6.6mm

Working altitude OVC II 5000m

Working altitude OVC III 2000m

EN/IEC61558-1

The BAC1 series is pending recognition by TUV SUD to EN/IEC61558-1.

FUSING

As stated in the application notes, to meet datasheet specifications it is required that a 1W 10Ω fusible resistor is fitted.

RoHS COMPLIANCE INFORMATION

This series is compatible with RoHS soldering systems with a peak wave solder temperature of 260°C for 10 seconds based on IEC 61760-1. The pin termination finish on this product series is Hot Dipped over Matte Tin with Nickel Preplate. The series is backward compatible with Sn/Pb soldering systems. For further information, please visit www.murata-ps.com/rohs

ENVIRONMENTAL VALIDATION TESTING

The following tests have been conducted on this product series, please contact Murata if further information about the tests is required.

| Test | Standard | Condition |
|-------------------------------|---|--|
| Temperature Cycling | JEDEC JESD22-A104E | 200 cycles. -40°C to 105°C, 15 minutes hold at each extreme. |
| HAST (Unbiased) | JEDEC JESD22-A118B | 96Hrs +2/-0Hrs at 130°C ± 2°C, 85% ± 5% R.H. |
| Storage Life | JEDEC JESD22-A103-E, Condition A | 125°C +10/-0°C for ≥1000 hours |
| Vibration | BS EN 61373 with respect to BS EN 60068-2-64 2008, Test Fh Category 1 Class B | 5 – 150Hz. Level at each axis – Vertical, Traverse and Longitudinal: 5.72m/s ² rms. 5 hours in each axis. Crest factor: 3 Sigma. Device is secured via pins/leads. |
| Shock | BS EN 61373: 2010, Category 1 Class B | Test is 30ms duration, 3 shocks in each sense of 3 mutually perpendicular axes (18 shocks total). Level at each axis as follows: Vertical, Traverse and Longitudinal: 50m/s ² . Device is secured via pins/leads. |
| Solderability | IPC/ECA J-STD-002E, Test A1 | Parts are baked for 4 hours at a temperature off 155°C, within 72 hours they are dipped in flux for 10 seconds. Followed by dipping the parts in a solder pot at 255°C ±5°C for 5 seconds (96SC tin/silver/copper) |
| Solvent cleaning | Resistance to cleaning agents. | Solvent – Novec 71IPA & Topklean EL-20A. Pulsed ultrasonic immersion 45°C- 65°C |
| Solvent resistance | MIL-STD-883K, Method 2015.14 | The parts and the bristle portion of the brush are immersed in Isopropanol for a minimum of 1 minute. The parts are brushed 3 times, after the third time the parts are blown dry and inspected. |
| Solder Heat | JEDEC JESD22-B106E | The test sample is subjected to a molten solder bath at 270 ±5°C for 7 +2/-0 seconds (96SC tin/silver/copper). The leads are dipped in the solder bath to within 1mm of the device body. |
| Solder Heat (Hand) | MIL-STD 202H, Method 210, Condition A | The soldering iron is heated to 350°C ± 10°C and applied to the terminations for a duration of 4 to 5 seconds. |
| Lead Integrity (Adhesion) | MIL-STD 883K, Method 2025.4 | Leads are bent through 90° until a fracture occurs. |
| Lead Integrity (Fatigue) | MIL-STD 883K, Method 2004.7, Condition B ₁ | The leads are bent to an angle of 15°. Each lead is subjected to 3 cycles. |
| Lead Integrity (Tension/Pull) | MIL-STD 883K, Method 2004.7, Condition A ₁ | Pull of 0.227kg applied for 30 seconds. The force is then increased until the pins snap. |

EMC STANDARDS

| | |
|------------------------------|--|
| Conducted input noise | EN55032, Class B with external X cap |
| Radiated noise | EN55032, Class B |
| ESD immunity | IEC/EN61000-4-2 level 3 perf criteria A |
| Conducted transient immunity | EN61000-4-6, 10 Vrms, perf criteria A |
| Conducted surge immunity | EN61000-4-5, Installation class 3, perf criteria A |
| EFT/Burst | EN61000-4-4, level 3, perf criteria A |
| Radiated field immunity | EN61000-4-3, 10 V/m, perf criteria A |
| Dips and interruptions | EN61000-4-11, 100% reduction for 20ms (A), 60% reduction for 200ms (A), 30% reduction for 500ms (A), 100% reduction for 5s (B) |
| Magnetic fields | EN61000-4-8 30A/m, perf criteria A |

PART NUMBER STRUCTURE

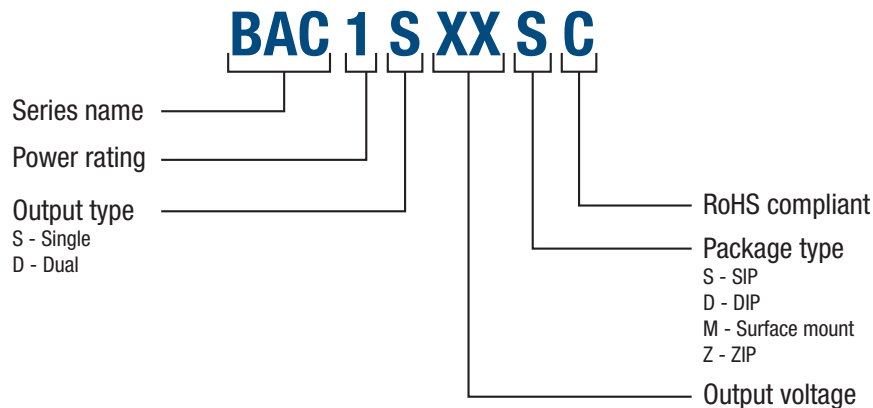

APPLICATION NOTES

Components required to meet datasheet specifications - 5V output types

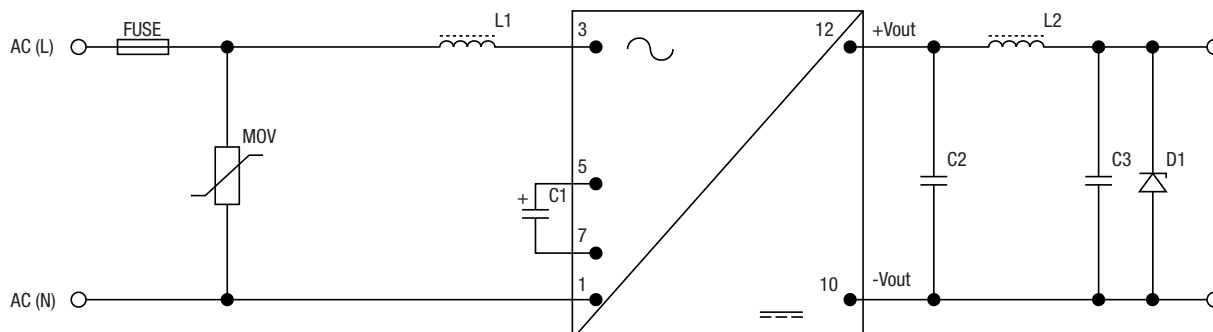

| | |
|------|---|
| FUSE | 1W 10Ω fusible resistor |
| MOV | Component fitted for compliance with EN61000-4-5, Installation class 3, perf criteria A |
| L1 | 330μH |
| C1 | 6.8μF 400V |
| C2 | 68μF 20mΩ low ESR polymer |
| L2 | 6.8μH 84682C |
| C3 | 22μF |
| D1 | SMBJ7.0A transient voltage suppressor - component fitted for overshoot protection |

Components required to meet datasheet specifications - 12V output types

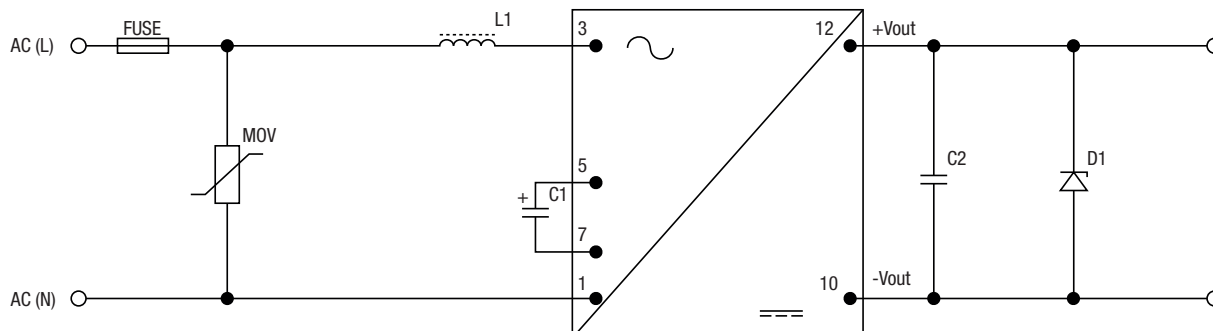

| | |
|------|---|
| FUSE | 1W 10Ω fusible resistor |
| MOV | Component fitted for compliance with EN61000-4-5, Installation class 3, perf criteria A |
| L1 | 330μH |
| C1 | 6.8μF 400V |
| C2 | 68μF 20mΩ low ESR polymer |
| D1 | SMBJ20A transient voltage suppressor - component fitted for overshoot protection |

APPLICATION NOTES (continued)

Components required to meet datasheet specifications - 24V output types

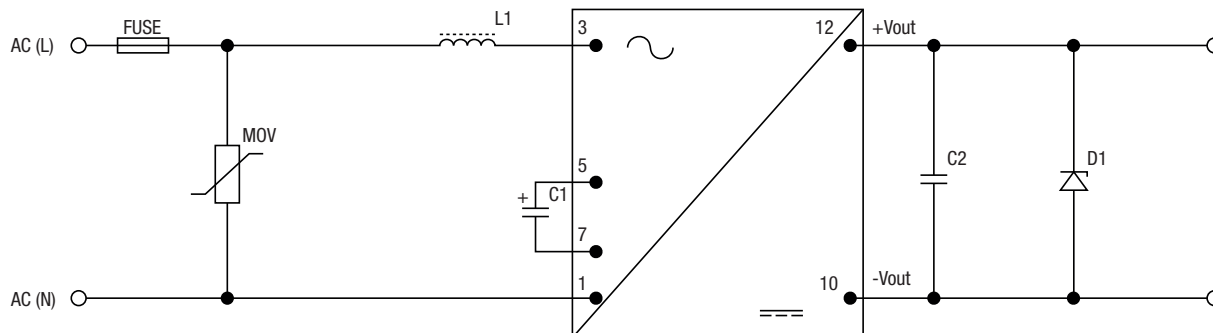

| | |
|------|---|
| FUSE | 1W 10Ω fusible resistor |
| MOV | Component fitted for compliance with EN61000-4-5, Installation class 3, perf criteria A |
| L1 | 330μH |
| C1 | 6.8μF 400V |
| C2 | 47μF 25mΩ low ESR polymer |
| D1 | SMBJ30A transient voltage suppressor - component fitted for overshoot protection |

Advisory Notes

The BAC1 series is not hermetically sealed, customers should ensure that parts are fully dried before input power application.

Output Capacitance and start-up times

The recommended specified caps on page 4 and 5 can already meet datasheet specification, there is no need to add extra caps. However, if customers connects to load capacitance, the below load capacitance are max (additional to recommended specified caps) to ensure start up at minimum AC input.

| Part No. | Maximum Load Capacitance (per output) | Start-up times (AC input) | Start-up times (DC input) |
|------------------|---------------------------------------|---------------------------|---------------------------|
| | μF | s | s |
| BAC1S05SC | 220 | 0.5 | 5 |
| BAC1S12SC | 100 | 1 | 5 |
| BAC1S24SC | 100 | 1 | 5 |

Minimum Load

The minimum load to meet full datasheet specification is 5% of the full rated load across the specified input voltage range.

24V output type - minimum input voltage requirements

At -40C the part is guaranteed to start into 100% load with a minimum input voltage of 115Vac; once the product is operating, the product will continue to operate at lower input voltages with higher output loading.

The product will start at -40C with 80% or lower load with an input voltage of 100VAC; once the product is operating, the product will continue to operate at lower input voltages with higher output loading.

CHARACTERISATION TEST METHODS

Ripple & Noise Characterisation Method

Ripple and noise measurements are performed with the following test configuration.

C1 10µF electrolytic capacitor

Differential Mode Noise Test Schematic

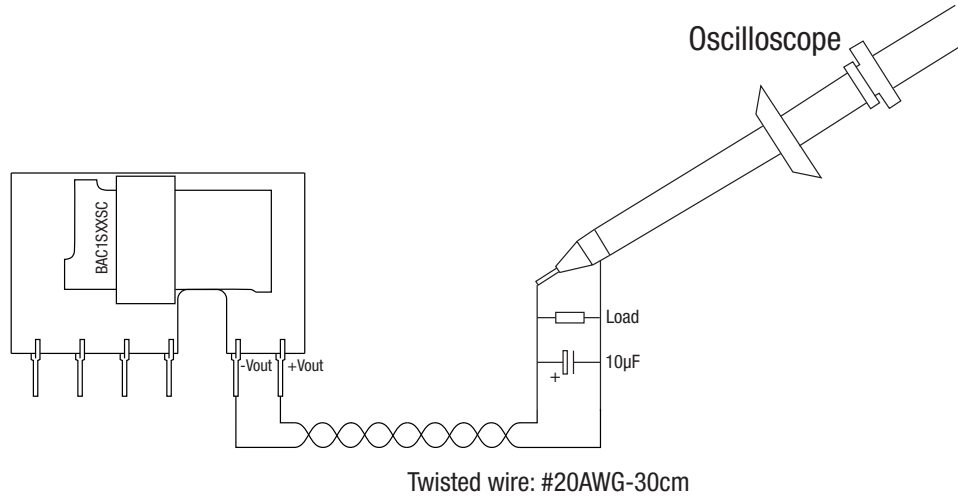

EFFICIENCY VS LOAD

BAC1S05DC

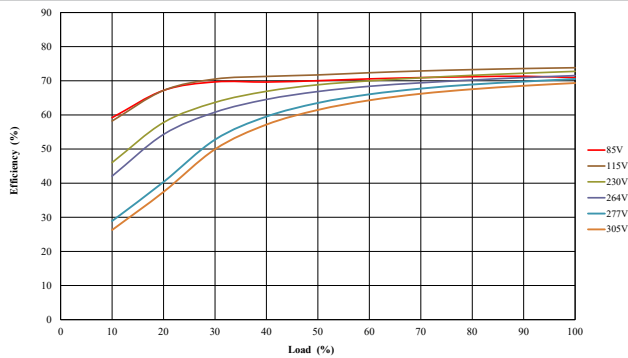

BAC1S12DC

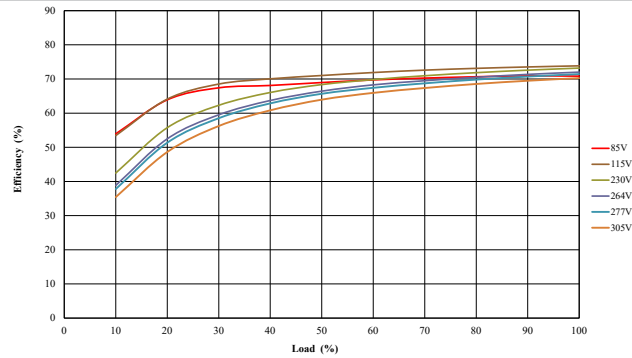

BAC1S24DC

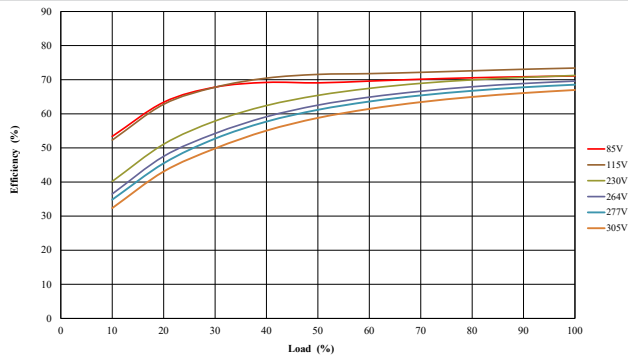

TEMPERATURE DERATING

BAC1S05DC

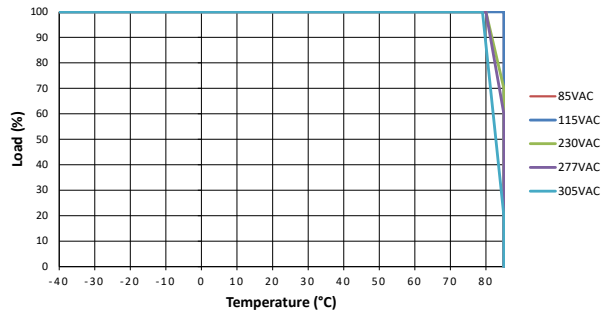

BAC1S12DC

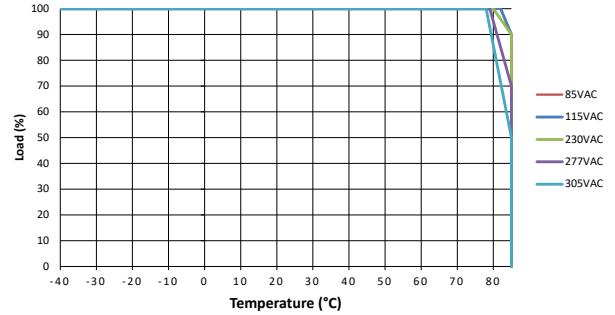

BAC1S24DC

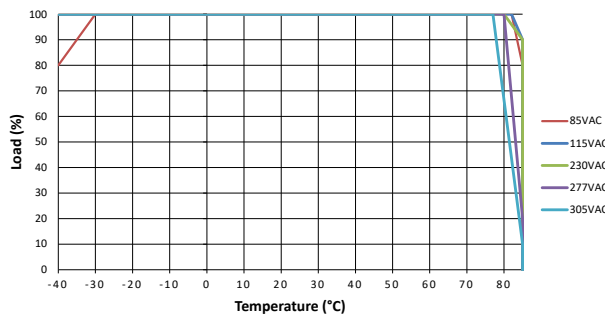

EMC FILTERING AND SPECTRA

FILTERING

The following filter circuit and filter table shows the input filters typically required to meet EN55032 Quasi-Peak (green line) Curve B limit vs peak conducted emissions.

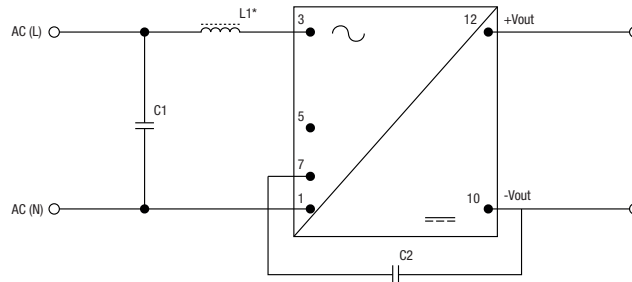

5V and 12V output types

| Component | Description |
|-----------|--|
| C1 | 68nF 305VAC |
| L1 | refer to "components required to match datasheet specifications" |
| C2 | 100pF Y-cap |

Components marked with an asterisk are already fitted and should not be duplicated

BAC1S05SC (110V) - Live

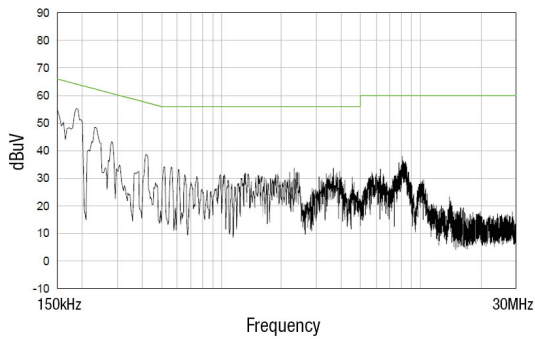

BAC1S05SC (110V) - Neutral

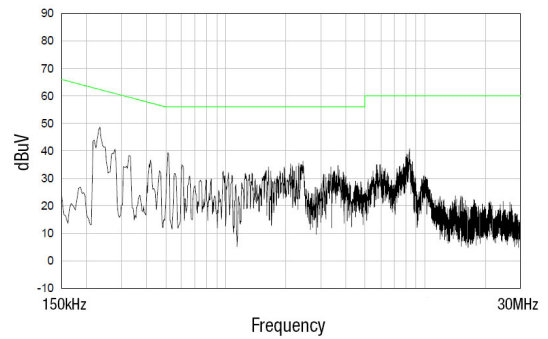

BAC1S12SC (110V) - Live

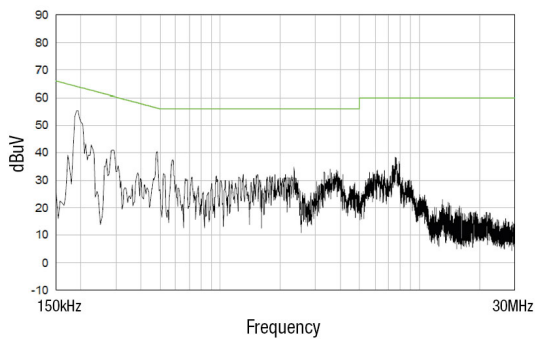

BAC1S12SC (110V) - Neutral

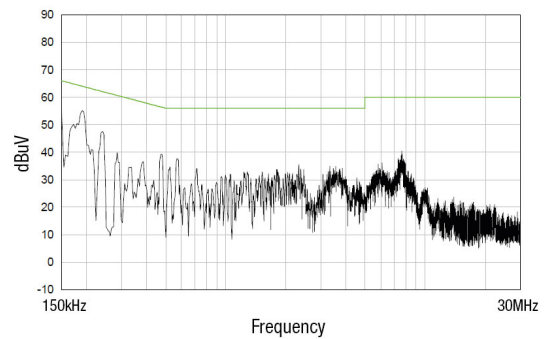

EMC FILTERING AND SPECTRA (continued)

BAC1S05SC (230V) - Live

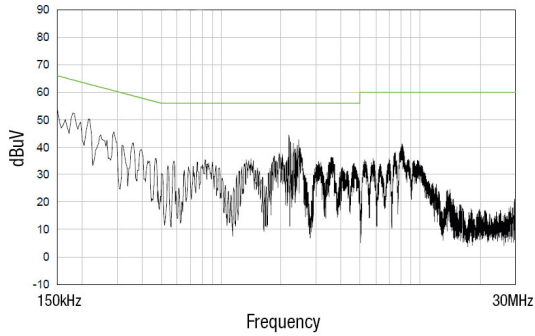

BAC1S05SC (230V) - Neutral

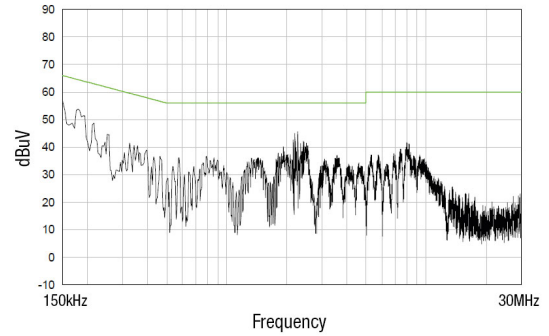

BAC1S12SC (230V) - Live

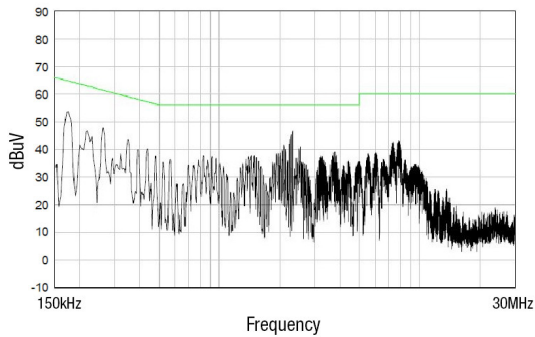

BAC1S12SC (230V) - Neutral

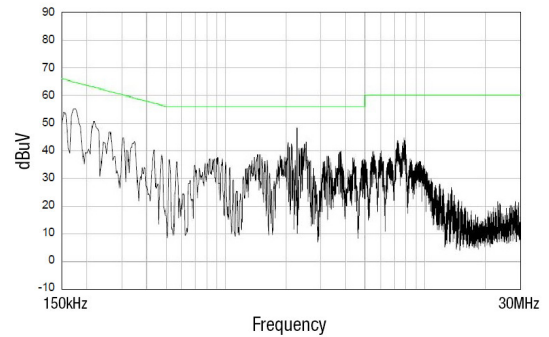

EMC FILTERING AND SPECTRA (continued)

FILTERING

The following filter circuit and filter table shows the input filters typically required to meet EN55032 Quasi-Peak (green line) Curve B peak conducted emissions.

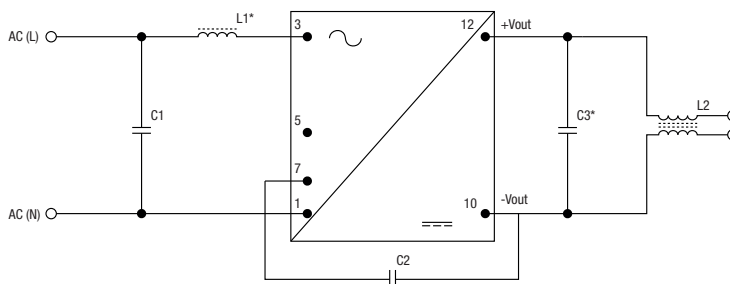

| BAC1S24SC | |
|-----------|--|
| Component | Description |
| C1 | 68nF 305VAC |
| L1 | refer to "components required to match datasheet specifications" |
| C2 | 100pF Y-cap |
| C3 | refer to "components required to match datasheet specifications" |
| L2 | DLW21SN261SQ2L |

Components marked with an asterisk are already fitted and should not be duplicated

BAC1S24SC (110V) - Live

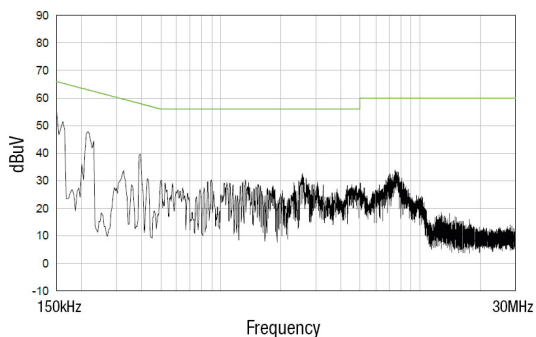

BAC1S24SC (110V) - Neutral

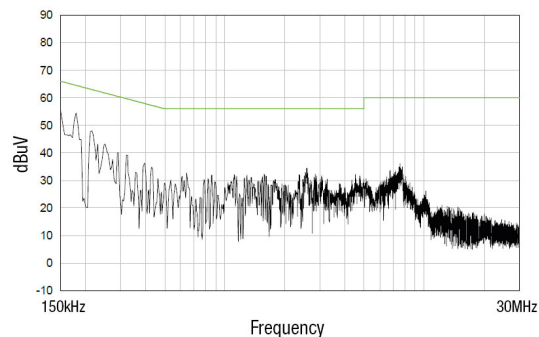

BAC1S24SC (230V) - Live

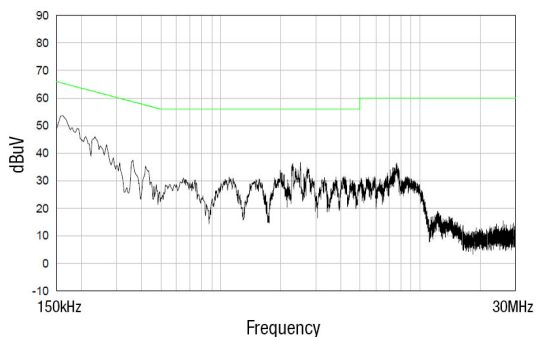

BAC1S24SC (230V) - Neutral

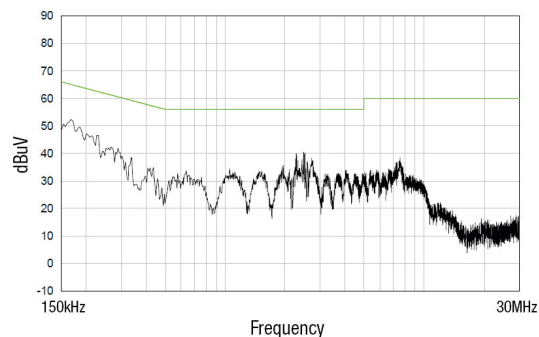

PACKAGE SPECIFICATIONS

MECHANICAL DIMENSIONS

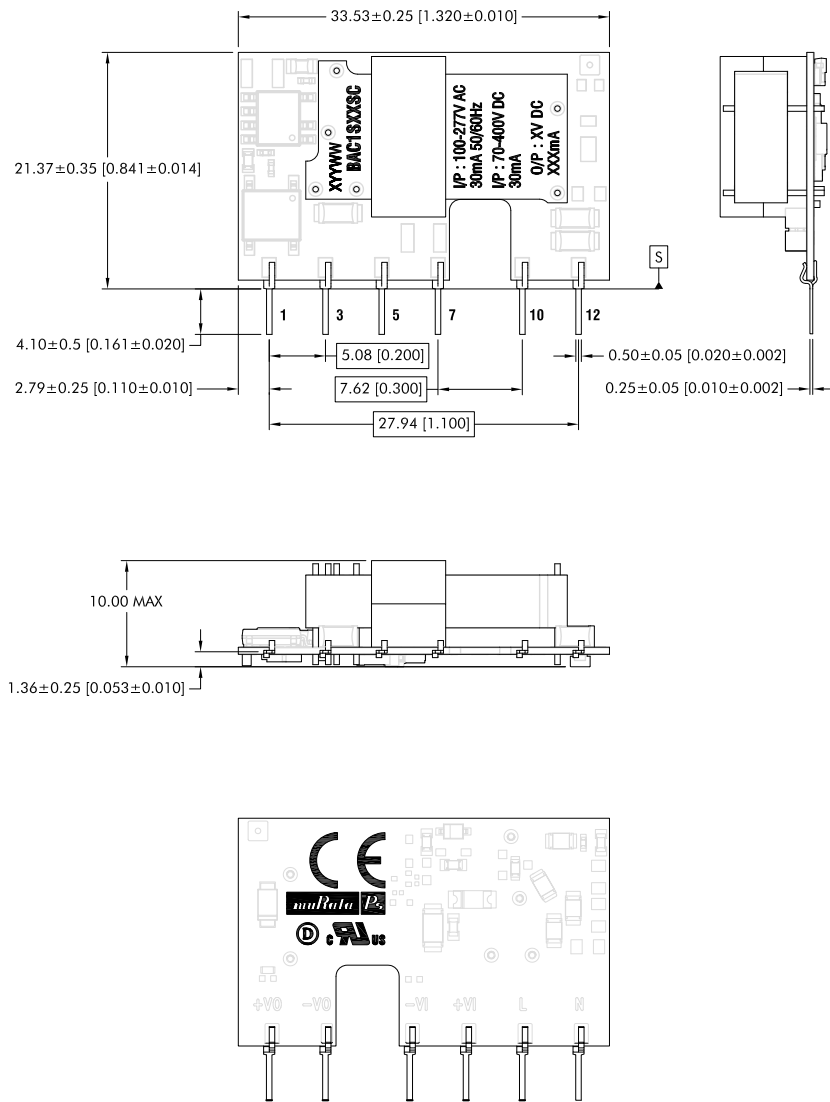

All dimensions in mm (inches) Controlling dimension is mm.
All pins on a 2.54 (0.100) pitch and within ±0.1 (0.004) of true position from pin 1 at seating plane 'S'

Weight: 6.2g

PIN CONNECTIONS

Pin Output

| Pin | Function |
|-----|-----------|
| 1 | AC (N) |
| 3 | AC (L) |
| 5 | +Vin (DC) |
| 7 | -Vin (DC) |
| 10 | -Vout |
| 12 | +Vout |

RECOMMENDED FOOTPRINT DETAILS

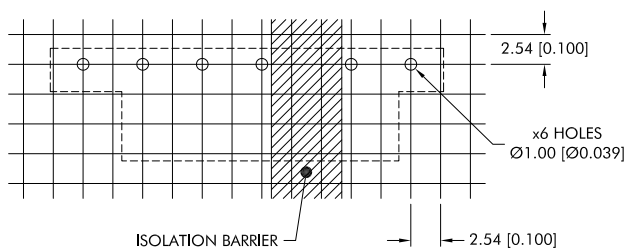

The isolation barrier shown must not have any copper traces even on internal layers. This is to avoid compromising the creepage and clearance distance. PCB layouts must take into consideration the required clearance and creepage requirements to maintain the clearance and creepage of the isolation barrier. All dimensions in mm (inches).

PACKAGING SPECIFICATIONS (continued)

TRAY OUTLINE DIMENSIONS

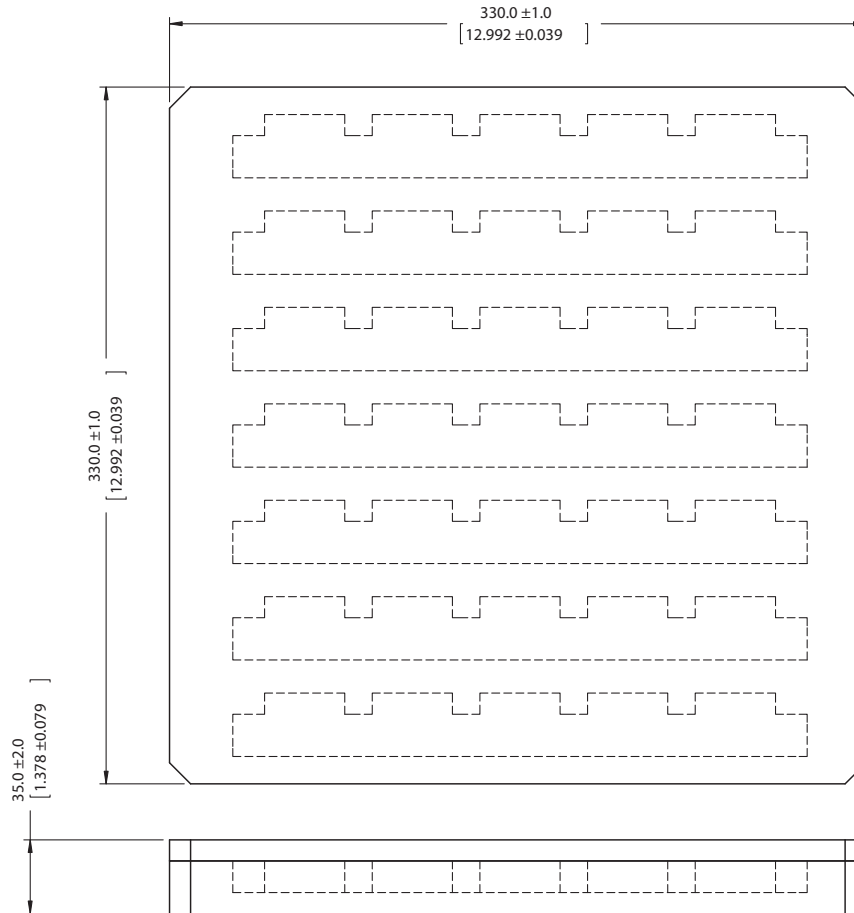

EPE Tray/Lid
Quantity: 35

All dimensions in mm (inches) Controlling dimension is mm.



This product is subject to the following [operating requirements](#) and the [Life and Safety Critical Application Sales Policy](#). Refer to: <http://www.murata-ps.com/requirements/>

Murata Power Solutions (Milton Keynes) Ltd. makes no representation that the use of its products in the circuits described herein, or the use of other technical information contained herein, will not infringe upon existing or future patent rights. The descriptions contained herein do not imply the granting of licenses to make, use, or sell equipment constructed in accordance therewith. Specifications are subject to change without notice.
© 2020 Murata Power Solutions (Milton Keynes) Ltd.

Mouser Electronics

Authorized Distributor

Click to View Pricing, Inventory, Delivery & Lifecycle Information:

[Murata:](#)

[BAC1S24SC](#) [BAC1S05SC](#) [BAC1S12SC](#)

Компания «Океан Электроники» предлагает заключение долгосрочных отношений при поставках импортных электронных компонентов на взаимовыгодных условиях!

Наши преимущества:

- Поставка оригинальных импортных электронных компонентов напрямую с производств Америки, Европы и Азии, а так же с крупнейших складов мира;
- Широкая линейка поставок активных и пассивных импортных электронных компонентов (более 30 млн. наименований);
- Поставка сложных, дефицитных, либо снятых с производства позиций;
- Оперативные сроки поставки под заказ (от 5 рабочих дней);
- Экспресс доставка в любую точку России;
- Помощь Конструкторского Отдела и консультации квалифицированных инженеров;
- Техническая поддержка проекта, помощь в подборе аналогов, поставка прототипов;
- Поставка электронных компонентов под контролем ВП;
- Система менеджмента качества сертифицирована по Международному стандарту ISO 9001;
- При необходимости вся продукция военного и аэрокосмического назначения проходит испытания и сертификацию в лаборатории (по согласованию с заказчиком);
- Поставка специализированных компонентов военного и аэрокосмического уровня качества (Xilinx, Altera, Analog Devices, Intersil, Interpoint, Microsemi, Actel, Aeroflex, Peregrine, VPT, Syfer, Eurofarad, Texas Instruments, MS Kennedy, Miteq, Cobham, E2V, MA-COM, Hittite, Mini-Circuits, General Dynamics и др.);

Компания «Океан Электроники» является официальным дистрибьютором и эксклюзивным представителем в России одного из крупнейших производителей разъемов военного и аэрокосмического назначения «JONHON», а так же официальным дистрибьютором и эксклюзивным представителем в России производителя высокотехнологичных и надежных решений для передачи СВЧ сигналов «FORSTAR».



JONHON

«JONHON» (основан в 1970 г.)

Разъемы специального, военного и аэрокосмического назначения:

(Применяются в военной, авиационной, аэрокосмической, морской, железнодорожной, горно- и нефтедобывающей отраслях промышленности)

«FORSTAR» (основан в 1998 г.)

ВЧ соединители, коаксиальные кабели,
кабельные сборки и микроволновые компоненты:

(Применяются в телекоммуникациях гражданского и специального назначения, в средствах связи, РЛС, а так же военной, авиационной и аэрокосмической отраслях промышленности).



Телефон: 8 (812) 309-75-97 (многоканальный)

Факс: 8 (812) 320-03-32

Электронная почта: ocean@oceanchips.ru

Web: <http://oceanchips.ru/>

Адрес: 198099, г. Санкт-Петербург, ул. Калинина, д. 2, корп. 4, лит. А