

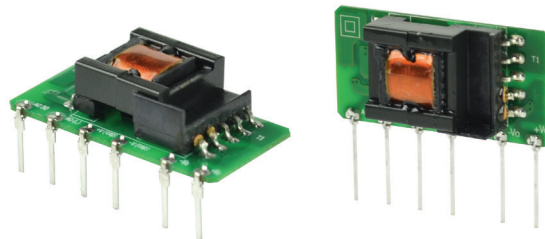

SERIES: PBO-3 | **DESCRIPTION:** AC-DC POWER SUPPLY

FEATURES

- up to 3 W continuous power
- ultra-compact SIP package
- available in straight-pin and bent-pin configurations
- wide input voltage range
- over current and short circuit protections
- 3,000 Vac isolation
- UL 60950-1, CE safety approvals
- efficiency up to 77%



MODEL	output voltage (Vdc)	output current		output power max (W)	ripple and noise ¹ max (mVp-p)	efficiency ² typ (%)
		min (mA)	max (mA)			
PBO-3-S3.3	3.3	60	600	1.98	150	65
PBO-3-S5	5	60	600	3	150	70
PBO-3-S9	9	33.3	333	3	150	73
PBO-3-S12	12	25	250	3	150	74
PBO-3-S15	15	20	200	3	150	75
PBO-3-S24	24	12.5	125	3	150	77

Notes: 1. At full load, nominal input, 20 MHz bandwidth oscilloscope, with a 1 µF ceramic and 10 µF electrolytic capacitor on the output.
 2. At 230 Vac input.
 3. All specifications are measured at Ta=25°C, humidity <75%, 115 or 230 Vac input voltage, and rated output load unless otherwise specified.

PART NUMBER KEY

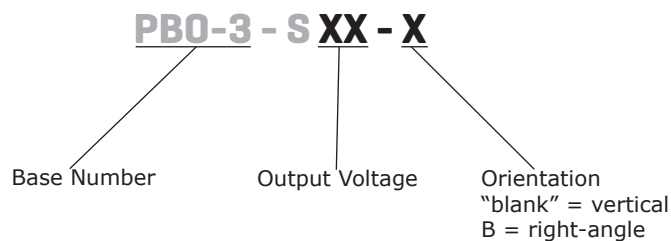

INPUT

parameter	conditions/description	min	typ	max	units
voltage		85		305	Vac
		70		430	Vdc
frequency		47		63	Hz
current	at 115 Vac			0.12	A
	at 277 Vac			0.06	A
inrush current	at 115 Vac at 277 Vac		13		A
			23		A
no load power consumption	at 230 Vac			0.25	W

OUTPUT

parameter	conditions/description	min	typ	max	units
capacitive load	3.3 Vdc output models			820	μF
	5 Vdc output models			680	μF
	9/12 Vdc output models			470	μF
	15 Vdc output models			330	μF
	24 Vdc output models			100	μF
initial set point accuracy	3.3 Vdc output models			±6	%
	all other models			±5	%
line regulation	at full load				
	3.3 Vdc output models all other models		±2.5 ±1.5		% %
load regulation	from 10~100% load		±2.5		%
switching frequency				65	kHz
temperature coefficient			±0.15		%/°C

PROTECTIONS

parameter	conditions/description	min	typ	max	units
over current protection	auto recovery	110		500	%
short circuit protection	continuous, auto recovery				

SAFETY & COMPLIANCE

parameter	conditions/description	min	typ	max	units
isolation voltage	input to output for 1 minute	3,000			Vac
safety approvals	UL 60950-1, EN 60950-1				
safety class	class II				
conducted emissions	CISPR22/EN55022 Class A, (external circuit required, see figure 1)				
	CISPR22/EN55022 Class B, (external circuit required, see figure 2)				
radiated emissions	CISPR22/EN55022 Class A, (external circuit required, see figure 1)				
	CISPR22/EN55022 Class B, (external circuit required, see figure 2)				
ESD	IEC/EN61000-4-2 Class B, contact ±4 kV				
radiated immunity	IEC/EN61000-4-3 Class A, 10V/m (external circuit required, see figure 2)				
EFT/burst	IEC/EN61000-4-4 Class B, ±2 kV (external circuit required, see figure 1)				
	IEC/EN61000-4-4 Class B, ±4 kV (external circuit required, see figure 2)				
surge	IEC/EN61000-4-5 Class B, line to line ±1 kV (external circuit required, see figure 1)				
	IEC/EN61000-4-5 Class B, line to line ±1 kV/line to ground ±2 kV (external circuit required, see figure 2)				
conducted immunity	IEC/EN61000-4-6 Class A, 10 Vr.m.s (external circuit required, see figure 2)				

Notes: 1. The power supply is considered a component which will be installed into final equipment. The final equipment still must be tested to meet the necessary EMC directives.

SAFETY & COMPLIANCE (CONTINUED)

parameter	conditions/description	min	typ	max	units
voltage dips & interruptions	IEC/EN61000-4-11 Class B, 0%-70% (external circuit required, see figure 2)				
MTBF	as per MIL-HDBK-217F at 25 °C	300,000			hours
RoHS	2011/65/EU				

Notes: 1. The power supply is considered a component which will be installed into final equipment. The final equipment still must be tested to meet the necessary EMC directives.

ENVIRONMENTAL

parameter	conditions/description	min	typ	max	units
operating temperature	see derating curves	-40		85	°C
storage temperature		-40		105	°C
storage humidity	non-condensing			85	%

SOLDERABILITY

parameter	conditions/description	min	typ	max	units
hand soldering	for 3~5 seconds	350	360	370	°C
wave soldering	for 5~10 seconds	255	260	265	°C



DERATING CURVES

load vs. ambient temperature
(at 85~110 Vac / 70~130 Vdc input voltage)



load vs. ambient temperature
(at 110~305 Vac / 130~430 Vdc input voltage)

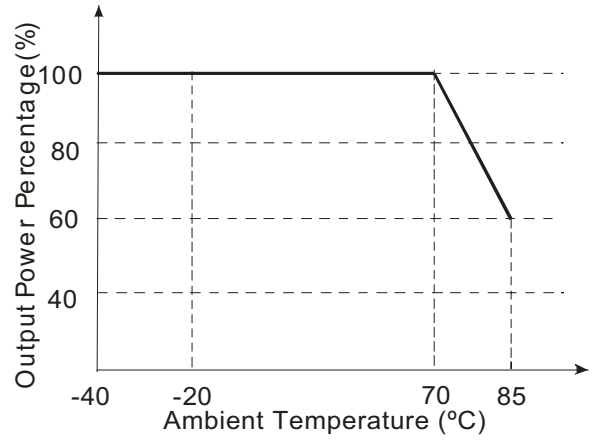

load vs. input voltage
(at 25°C)

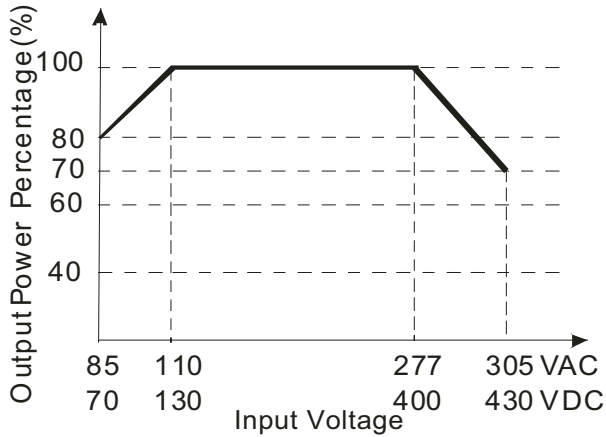

EFFICIENCY CURVES

Efficiency Curve
(Efficiency vs. Input Voltage)

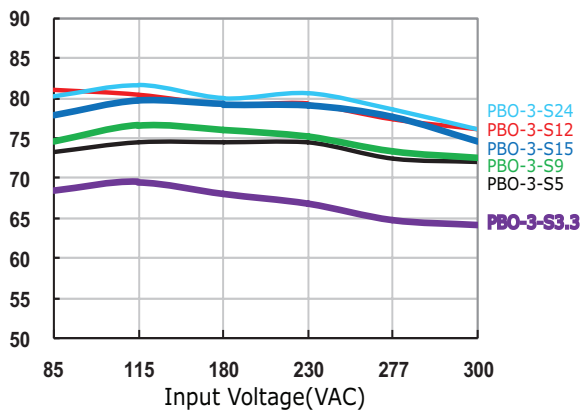

Efficiency Curve
(Efficiency vs. Load Current)

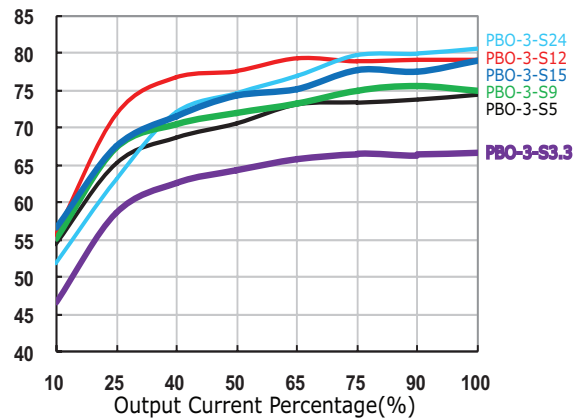

MECHANICAL

parameter	conditions/description	min	typ	max	units
dimensions	vertical models: 35.00 x 11.00 x 18.00 (1.38 x 0.43 x 0.71 inches) right-angle models: 35.00 x 18.00 x 11.00 (1.38 x 0.71 x 0.43 inches)				mm mm
weight			6		g

MECHANICAL DRAWING

Vertical Orientation

units: mm[inch]

tolerance: $\pm 0.50[\pm 0.020]$

pin section tolerance: $\pm 0.10[\pm 0.004]$

PIN CONNECTIONS	
PIN	Function
1	AC (N)
3	AC (L)
5	+V(CAP)
7	-V(CAP)
10	-Vo
12	+Vo

Note: 1. It is required to add C1 between pins 5 & 7 (see application circuits).

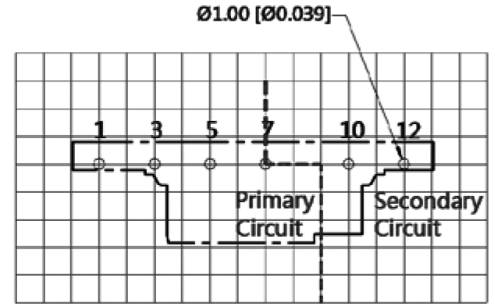
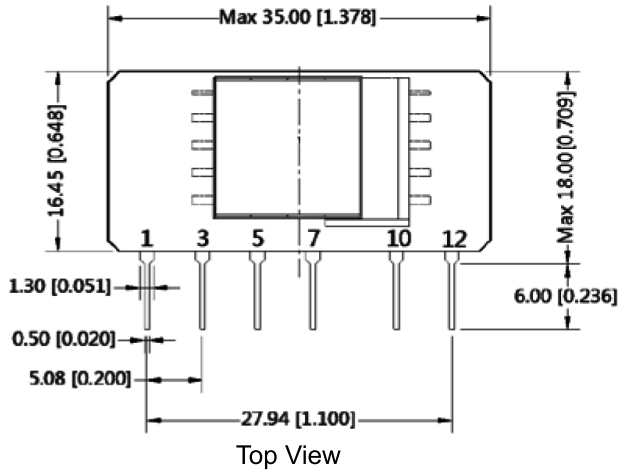

Note: Grid 2.54*2.54mm

Top View
PCB Layout



Bottom View

MECHANICAL DRAWING (CONTINUED)

Right-angle Orientation

units: mm[inch]

tolerance: ± 0.50 [± 0.020]

pin section tolerance: ± 0.10 [± 0.004]

PIN CONNECTIONS	
PIN	Function
1	AC (N)
3	AC (L)
5	+V(CAP)
7	-V(CAP)
10	-Vo
12	+Vo

Note: 1. It is required to add C1 between pins 5 & 7 (see application circuits).

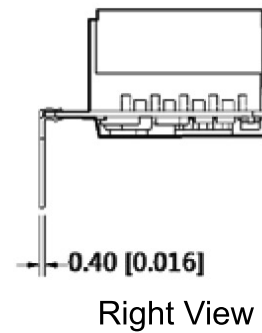
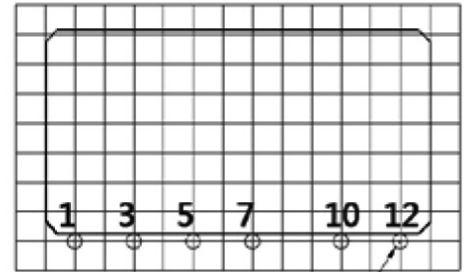

APPLICATION CIRCUIT

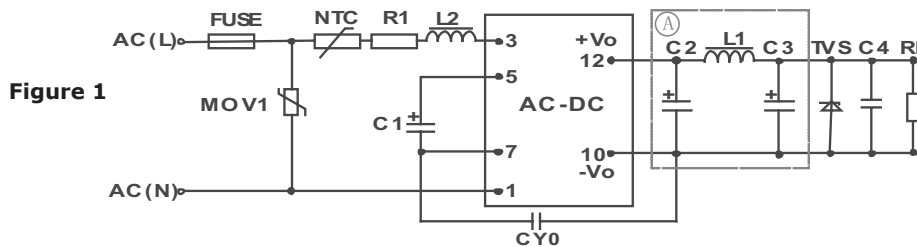

Table 1

Recommended External Circuit Components											
Vo (Vdc)	FUSE ¹	MOV1	NTC	L2	C1 ¹	CY0	C2 ^{1,2}	L1 ¹	C3 ¹	TVS	C4
3.3	1A/300V	S14K350	13D-5	4.7mH	10μF/450V	1nF/400Vac	270μF/16V	4.7μH	120μF/25V	SMBJ7.0A	0.1μF/50V
5	1A/300V	S14K350	13D-5	4.7mH	10μF/450V	1nF/400Vac	270μF/16V	4.7μH	68μF/35V	SMBJ7.0A	0.1μF/50V
9	1A/300V	S14K350	13D-5	4.7mH	10μF/450V	1nF/400Vac	270μF/16V	4.7μH	68μF/35V	SMBJ12A	0.1μF/50V
12	1A/300V	S14K350	13D-5	4.7mH	10μF/450V	1nF/400Vac	270μF/16V	4.7μH	68μF/35V	SMBJ20A	0.1μF/50V
15	1A/300V	S14K350	13D-5	4.7mH	10μF/450V	1nF/400Vac	470μF/35V	4.7μH	47μF/35V	SMBJ20A	0.1μF/50V
24	1A/300V	S14K350	13D-5	4.7mH	10μF/450V	1nF/400Vac	220μF/35V	4.7μH	47μF/35V	SMBJ30A	0.1μF/50V

Note: 1. Required components.
2. For 3.3, 5, 9, & 12 Vdc outputs, C2 should be a solid-state capacitor.

EMC RECOMMENDED CIRCUIT

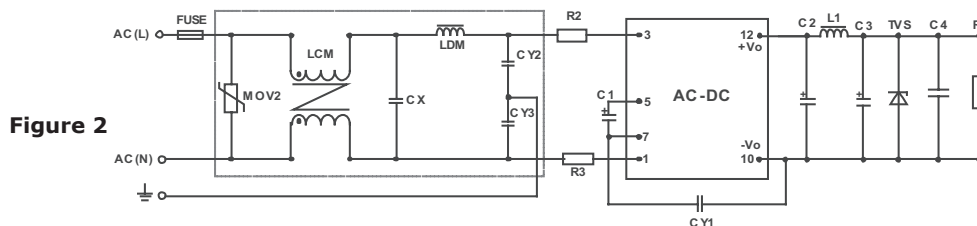

Table 2

Recommended External Circuit Components	
FUSE	1A/300V, slow fusing
MOV2	S14K350
LCM	3.50mH
CX	0.1μF/310 Vac
LDM	0.33mH
CY2/CY3	1nF/400 Vac
R2/R3	12Ω/2W
CY1	2.2nF/400 Vac

Note: Also refer to Table 1.

Notes: 3. C1 is required for both AC and DC inputs.
4. It is required to add pi-type filter circuit (C2, C3, & L1) to the output. The capacitors are recommended to be high frequency and low impedance electrolytic capacitors. For capacitance and rated ripple current of capacitors, refer to the datasheets provided by the manufacturers. Voltage derating of capacitors should be 80% or above.
5. When operating in the -40~+20°C temperature range, it is recommended to use a 22 μF / 450 V capacitor for C1.
6. C4 is a ceramic capacitor used to filter high frequency noise.
7. For current of L1 & L2 refer to the datasheets provided by the manufacturers. Current derating should be 80% or above.
8. TVS is a recommended component to protect post-circuits (if converter fails).
9. It is required to have a distance ≥6.4 mm for safety between external components in primary and secondary circuit.
10. It is recommended to add an insulation sheet between the bottom of the right-angle versions and the PCB when mounting.

REVISION HISTORY

rev.	description	date
1.0	initial release	10/18/2016
1.01	internal IC changed	05/11/2017
1.02	updated efficiency curves	02/05/2018

The revision history provided is for informational purposes only and is believed to be accurate.



Headquarters
20050 SW 112th Ave.
Tualatin, OR 97062
800.275.4899

Fax 503.612.2383
cui.com
techsupport@cui.com

CUI offers a two (2) year limited warranty. Complete warranty information is listed on our website.

CUI reserves the right to make changes to the product at any time without notice. Information provided by CUI is believed to be accurate and reliable. However, no responsibility is assumed by CUI for its use, nor for any infringements of patents or other rights of third parties which may result from its use.

CUI products are not authorized or warranted for use as critical components in equipment that requires an extremely high level of reliability. A critical component is any component of a life support device or system whose failure to perform can be reasonably expected to cause the failure of the life support device or system, or to affect its safety or effectiveness.

Компания «Океан Электроники» предлагает заключение долгосрочных отношений при поставках импортных электронных компонентов на взаимовыгодных условиях!

Наши преимущества:

- Поставка оригинальных импортных электронных компонентов напрямую с производств Америки, Европы и Азии, а так же с крупнейших складов мира;
- Широкая линейка поставок активных и пассивных импортных электронных компонентов (более 30 млн. наименований);
- Поставка сложных, дефицитных, либо снятых с производства позиций;
- Оперативные сроки поставки под заказ (от 5 рабочих дней);
- Экспресс доставка в любую точку России;
- Помощь Конструкторского Отдела и консультации квалифицированных инженеров;
- Техническая поддержка проекта, помощь в подборе аналогов, поставка прототипов;
- Поставка электронных компонентов под контролем ВП;
- Система менеджмента качества сертифицирована по Международному стандарту ISO 9001;
- При необходимости вся продукция военного и аэрокосмического назначения проходит испытания и сертификацию в лаборатории (по согласованию с заказчиком);
- Поставка специализированных компонентов военного и аэрокосмического уровня качества (Xilinx, Altera, Analog Devices, Intersil, Interpoint, Microsemi, Actel, Aeroflex, Peregrine, VPT, Syfer, Eurofarad, Texas Instruments, MS Kennedy, Miteq, Cobham, E2V, MA-COM, Hittite, Mini-Circuits, General Dynamics и др.);

Компания «Океан Электроники» является официальным дистрибьютором и эксклюзивным представителем в России одного из крупнейших производителей разъемов военного и аэрокосмического назначения «JONHON», а так же официальным дистрибьютором и эксклюзивным представителем в России производителя высокотехнологичных и надежных решений для передачи СВЧ сигналов «FORSTAR».



JONHON

«JONHON» (основан в 1970 г.)

Разъемы специального, военного и аэрокосмического назначения:

(Применяются в военной, авиационной, аэрокосмической, морской, железнодорожной, горно- и нефтедобывающей отраслях промышленности)

«FORSTAR» (основан в 1998 г.)

ВЧ соединители, коаксиальные кабели, кабельные сборки и микроволновые компоненты:

(Применяются в телекоммуникациях гражданского и специального назначения, в средствах связи, РЛС, а так же военной, авиационной и аэрокосмической отраслях промышленности).



Телефон: 8 (812) 309-75-97 (многоканальный)

Факс: 8 (812) 320-03-32

Электронная почта: ocean@oceanchips.ru

Web: <http://oceanchips.ru/>

Адрес: 198099, г. Санкт-Петербург, ул. Калинина, д. 2, корп. 4, лит. А