

# COMPACT POWER RELAY

## 1 POLE X 2—12A (28VDC) (FOR 24V BATTERY AUTOMOTIVE APPLICATIONS)

### FBR572, 582 SERIES

#### ■ FEATURES

- Two independent relays mounted in a single package (43% of the volume of the two FRL-270 relays)
- High current contact capacity (carrying current: 40 A/2 minutes, 30 A/1 hour)
- Suitable for controlling 24 V motors in trucks and other large vehicles
- High heat resistance and extended operating voltage
- Two types of contact gap (FBR572: 0.8 mm, FBR582: 1.4 mm)



#### ■ ORDERING INFORMATION

[Example]  $\frac{\text{FBR572}}{\text{(a)}} \frac{\text{N}}{\text{(b)}} \frac{\text{D24}}{\text{(c)}} - \frac{\text{W}}{\text{(d)}} \frac{\text{**}}{\text{(e)}}$

(a)	Series Name	FBR572: FBR572 Series relay (contact gap 0.8 mm) FBR582: FBR582 Series relay (contact gap 1.4 mm)
(b)	Structure	N : Plastic sealed type
(c)	Nominal Voltage	D24 : 24 VDC
(d)	Contact Material	W : Silver-tin oxide indium Y : Silver-tin oxide N : Silver copper nickel
(e)	Custom Designation	To be assigned custom specification

# FBR572, 582 SERIES

## ■ SPECIFICATIONS

Item		FBR570 Series	FBR580 Series
Contact	Arrangement	1 form C × 2 (SPDT ×2)	
	Material	Silver-tin oxide indium (-W type) Silver copper nickel (-N type)	Silver-tin oxide indium (-W type) Silver-tin oxide (-Y type)
	Voltage Drop (Resistance)	Maximum 100 mV (at 12 VDC 2 A)	
	Ratings	28 VDC 12 A (locked motor load) 28 VDC inrush 15 A, break 2.5 A (motor free load)	
	Maximum Carrying Current	40 A/2 minutes, 30 A/ 1 hour (25°C, 100% rated coil voltage)	
	Maximum Inrush Current (Reference)	-W,-Y type: 60 A -N type: 40 A	
	Max. Switching Current (Reference)	12 A 28 VDC	14 A 32 VDC
	Minimum Switching Load*1 (Reference)	-W, -Y Type: 6 VDC 1 A -N Type: 6 VDC 2 A	
Coil	Operating Temperature	-40°C to +85°C (no frost)	
	Storage Temperature	-40°C to +100°C (no frost)	
Time Value	Operate (at nominal voltage)	Maximum 10 ms	
	Release (at nominal voltage)	Maximum 5 ms	
Life	Mechanical	1 × 10 <sup>7</sup> operations minimum	1 × 10 <sup>6</sup> operations minimum
	Electrical	1 × 10 <sup>5</sup> operations minimum (locked motor load) 5 × 10 <sup>5</sup> operations minimum (motor free load)	1 × 10 <sup>5</sup> operations minimum (locked motor load)
Other	Vibration Resistance	10 to 55 Hz (double amplitude of 1.5 mm)	
	Shock Resistance	Misoperation	100 m/s <sup>2</sup>
		Endurance	1,000 m/s <sup>2</sup>
	Weight	Approximately 18 g	

\*1 Values when switching a resistive load at normal room temperature and humidity, and in a clean environment. The minimum switching load varies with the switching frequency and operating environment.

## ■ COIL DATA CHART

ORDERING CODE	Rated coil voltage	Coil resistance (±10%)	Must operate voltage	Thermal resistance
FBR572ND24-W FBR572ND24-N	24 VDC	384 Ω	14.4 VDC (at 20°C)	67°C/W
FBR582ND24-W FBR582ND24-Y		170 Ω	18.0 VDC (at 85°C)	56°C/W

# FBR572, 582 SERIES

## ■ SUITABLE APPLICATIONS

Application	Normal load current	Life x 10 <sup>3</sup>	Recommended model (example)
Power Windows	10 to 12 A (switching at motor locking)	100	FBR572ND24-W
Automatic Door Lock	5 A/2 door (switching at motor locking)	100	FBR572ND24-W
Intermittent Wipers	INRUSH 15 to 30 A BREAK 2 to 8 (motor free)	300	FBR572ND24-W
			FBR572ND24-N

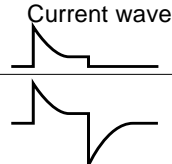

## ■ CHARACTERISTIC DATA

### 1. MAXIMUM BREAK CAPACITY

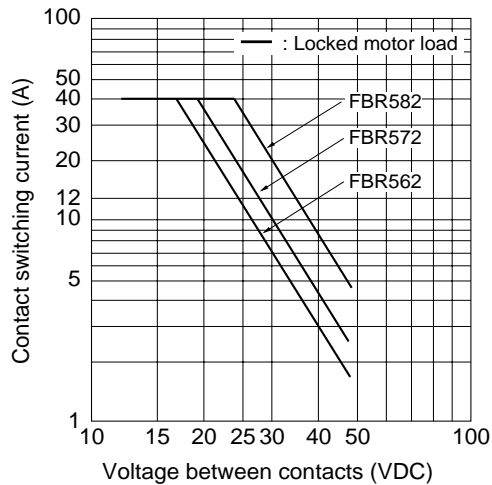

#### • Test circuit

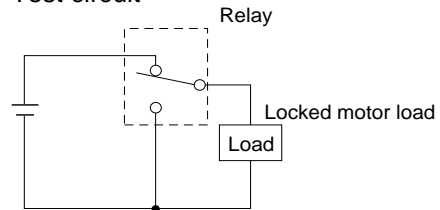

# FBR572, 582 SERIES

## 2. LIFE TEST (EXAMPLE)

[FBR572 type]

- Test item  
28 VDC-12 A  
Motor lock  
100,000 operations minimum  
(FBR572 □-W type)

- Test circuit

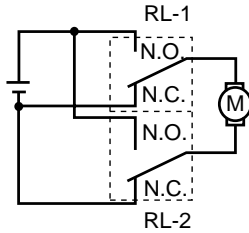

- Current wave form

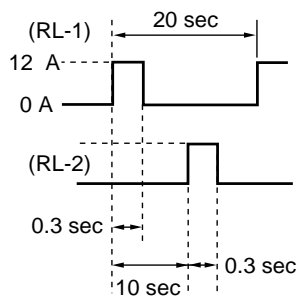

- Shift of pick-up drop-out voltage

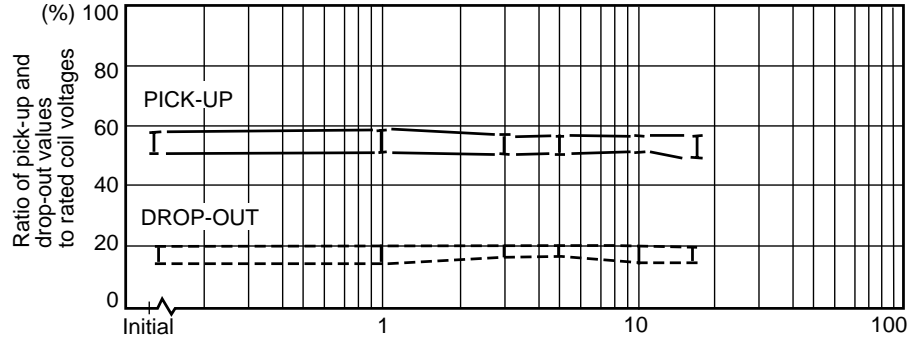

- Shift of contact resistance

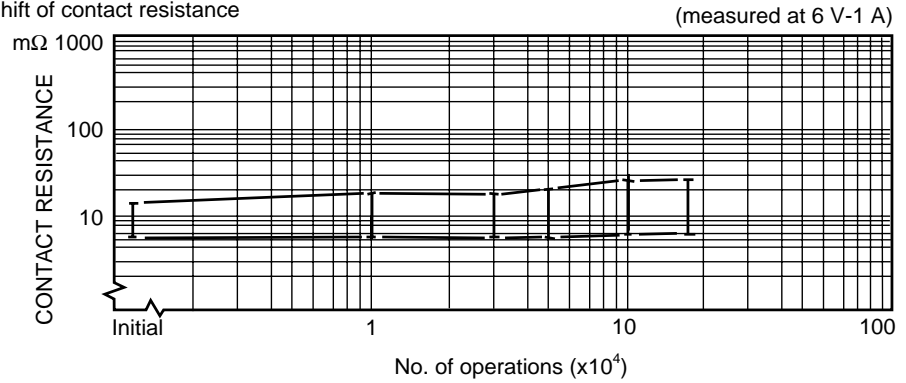

[FBR582 type]

- Test item  
28 VDC-12 A  
Motor lock  
100,000 operations minimum  
(FBR582 □-W type)

- Test circuit

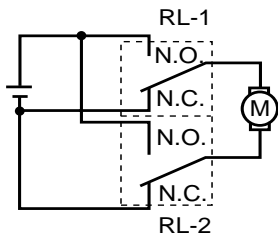

- Current wave form

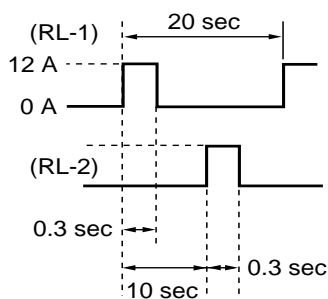

- Shift of pick-up drop-out voltage

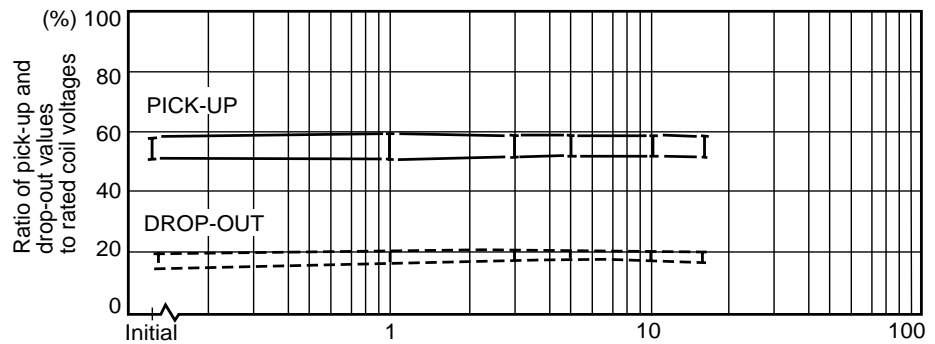

- Shift of contact resistance

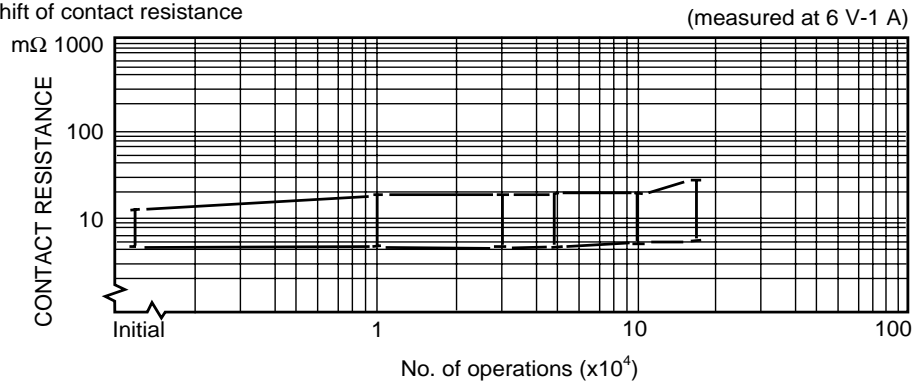

# FBR572, 582 SERIES

## 3. OPERATING COIL VOLTAGE RANGE

[FBR572 type]

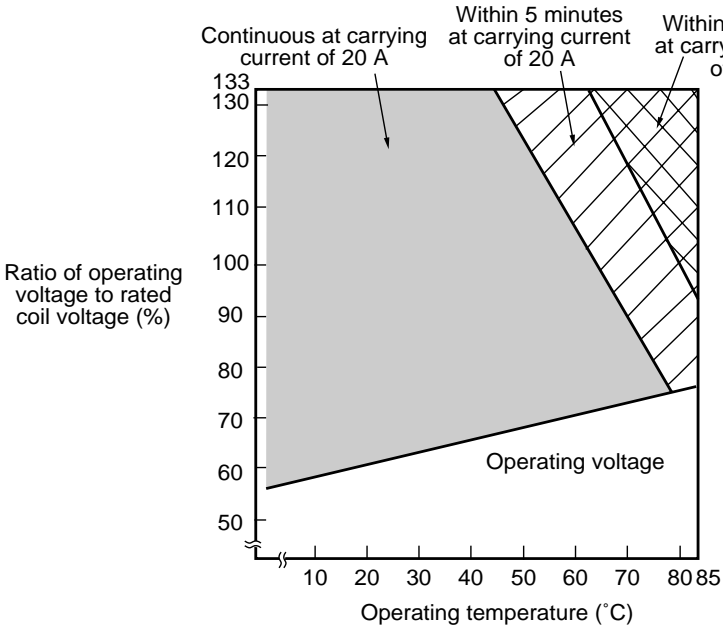

[FBR582 type]

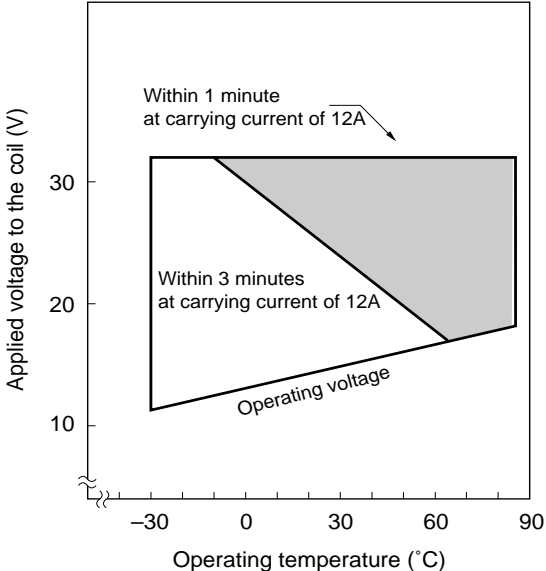

## 4. VIBRATION RESISTANCE CHARACTERISTICS

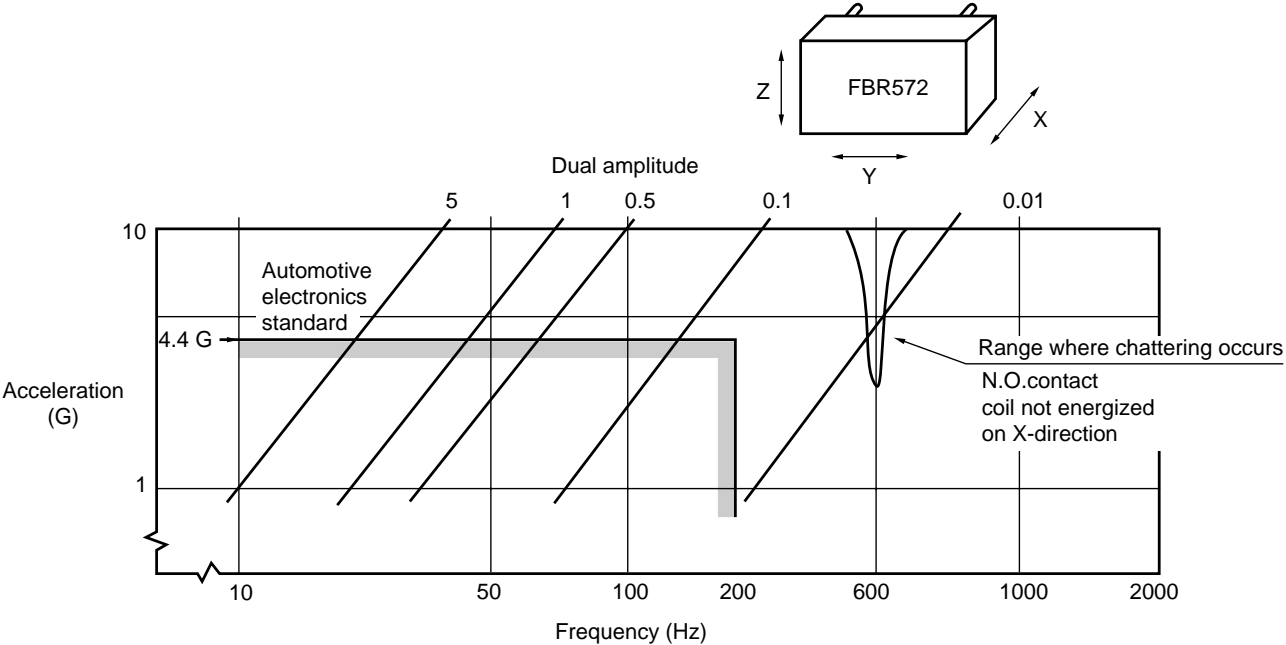

# FBR572, 582 SERIES

## 5. SHOCK RESISTANCE CHARACTERISTICS

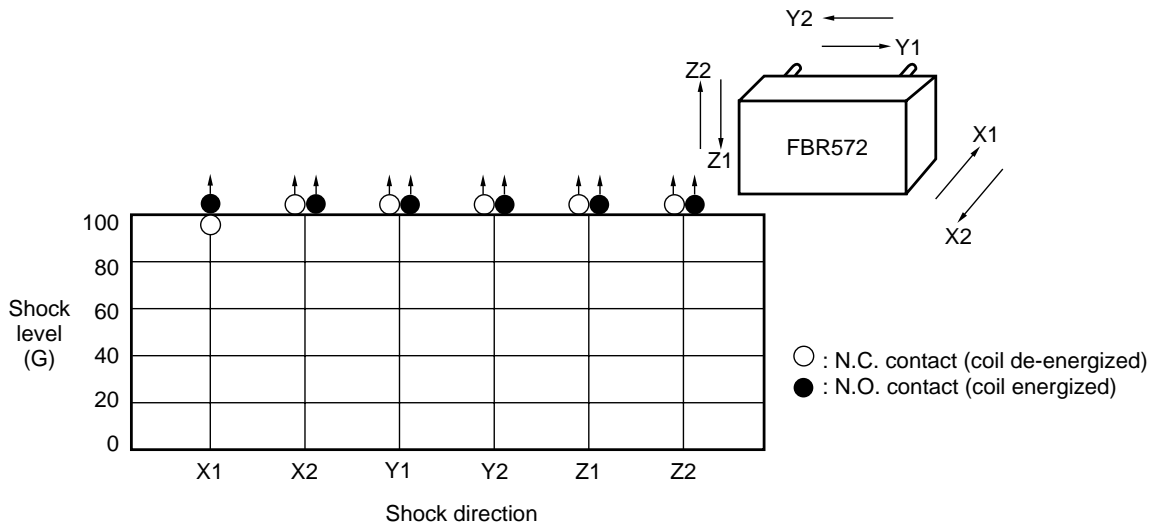

### ■ REFERENCE DATA

[FBR572 type]

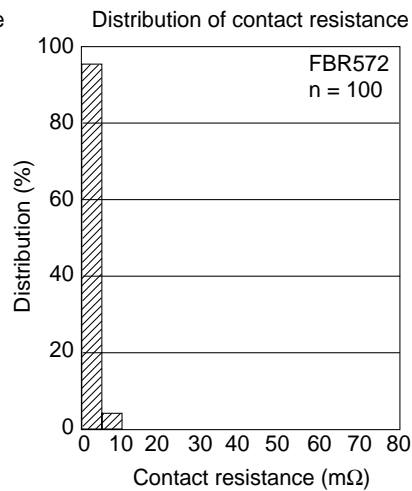
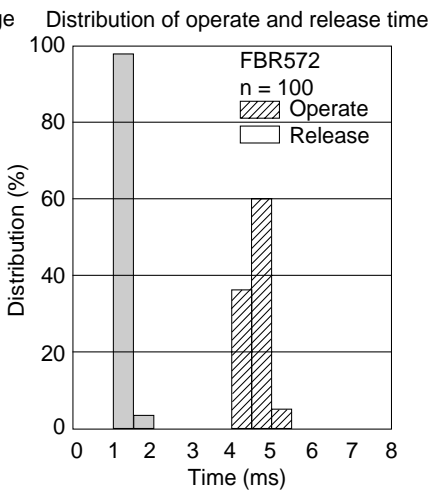
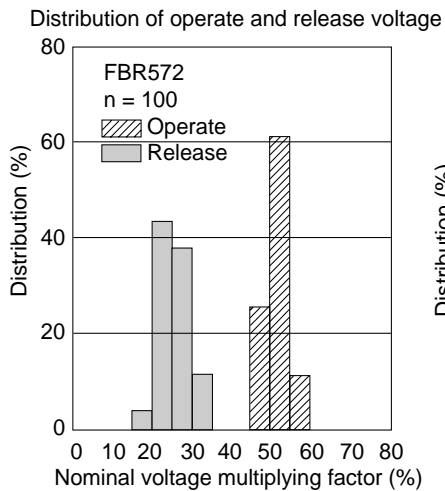

[FBR582 type]

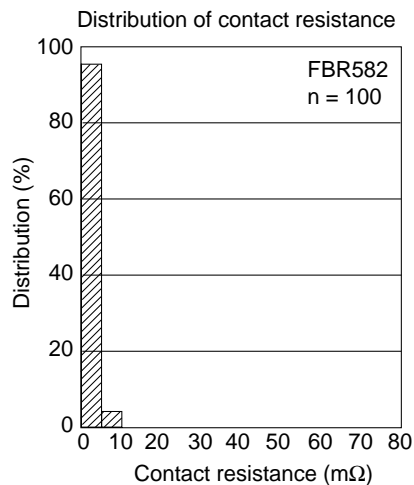
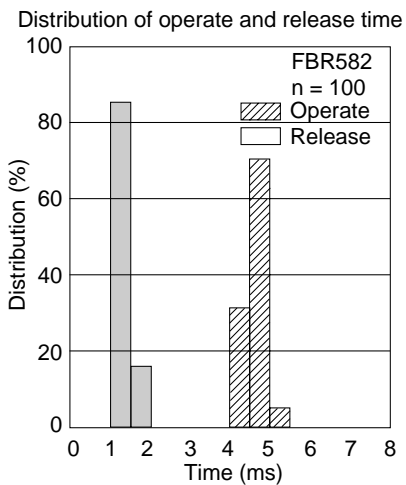
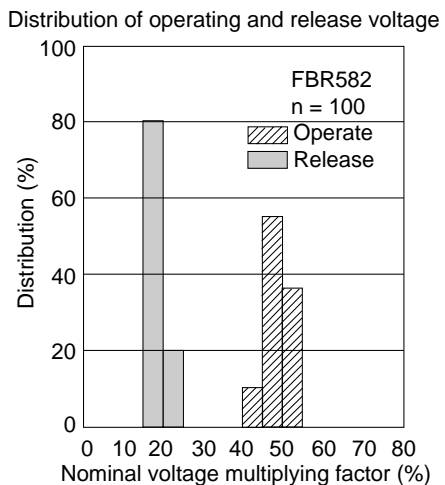

# FBR572, 582 SERIES

## ■ DIMENSIONS

[FBR572 type]

### ● Dimensions

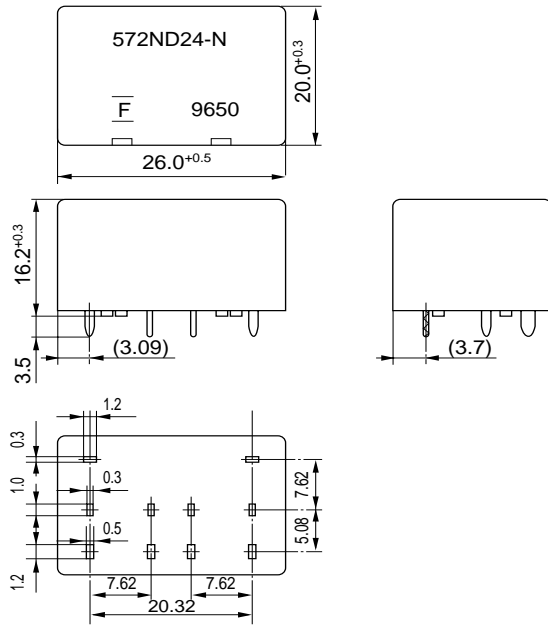

### ● PC board mounting hole layout (BOTTOM VIEW)

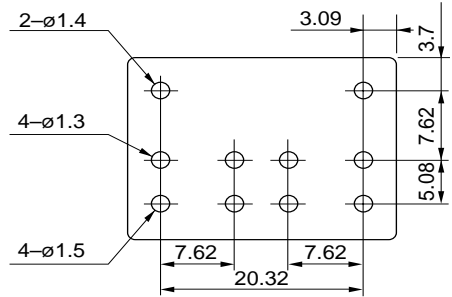

### ● Schematic (BOTTOM VIEW)

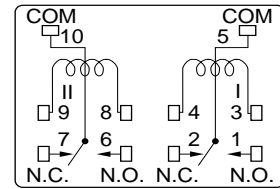

### ● Tube carrier

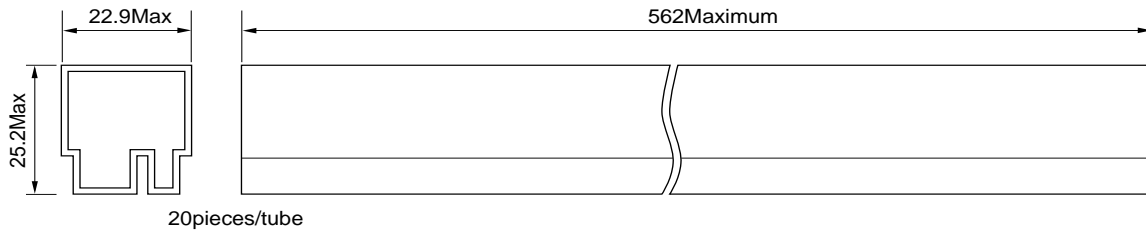

Unit: mm

# FBR572, 582 SERIES

## ■ DIMENSIONS

[FBR582 type]

### ● Dimension

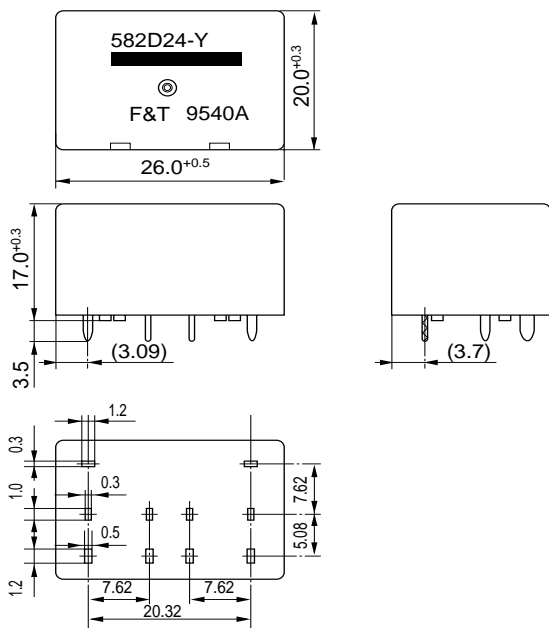

### ● PC board mounting hole layout (BOTTOM VIEW)

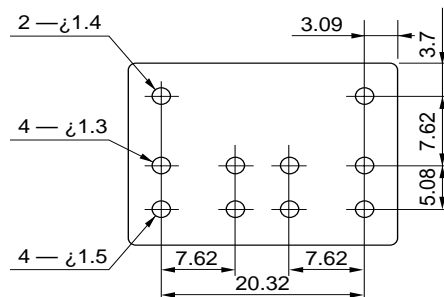

### ● Schematic (BOTTOM VIEW)

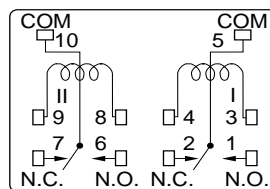

### ● Tube carrier

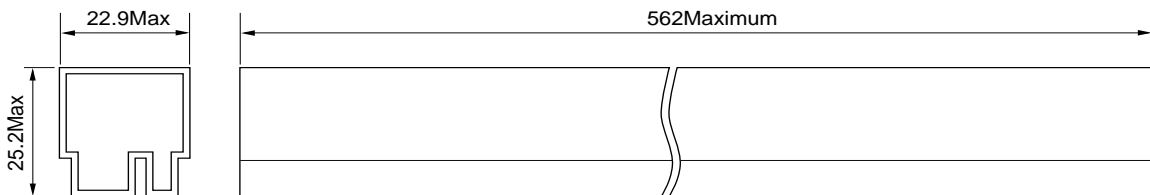

20pieces/tube

Unit: mm

## Fujitsu Components International Headquarter Offices

**Japan**  
Fujitsu Component Limited  
Gotanda-Chuo Building  
3-5, Higashigotanda 2-chome, Shinagawa-ku  
Tokyo 141, Japan  
Tel: (81-3) 5449-7010  
Fax: (81-3) 5449-2626  
Email: [promothq@ft.ed.fujitsu.com](mailto:promothq@ft.ed.fujitsu.com)  
Web: [www.fcl.fujitsu.com](http://www.fcl.fujitsu.com)

**North and South America**  
Fujitsu Components America, Inc.  
250 E. Caribbean Drive  
Sunnyvale, CA 94089 U.S.A.  
Tel: (1-408) 745-4900  
Fax: (1-408) 745-4970  
Email: [marcom@fcai.fujitsu.com](mailto:marcom@fcai.fujitsu.com)  
Web: [www.fcai.fujitsu.com](http://www.fcai.fujitsu.com)

**Europe**  
Fujitsu Components Europe B.V.  
Diamantlaan 25  
2132 WV Hoofddorp  
Netherlands  
Tel: (31-23) 5560910  
Fax: (31-23) 5560950  
Email: [info@fceu.fujitsu.com](mailto:info@fceu.fujitsu.com)  
Web: [www.fceu.fujitsu.com](http://www.fceu.fujitsu.com)

**Asia Pacific**  
Fujitsu Components Asia Ltd.  
102E Pasir Panjang Road  
#04-01 Citilink Warehouse Complex  
Singapore 118529  
Tel: (65) 6375-8560  
Fax: (65) 6273-3021  
Email: [fcal@fcal.fujitsu.com](mailto:fcal@fcal.fujitsu.com)  
Web: [www.fcal.fujitsu.com](http://www.fcal.fujitsu.com)



Компания «Океан Электроники» предлагает заключение долгосрочных отношений при поставках импортных электронных компонентов на взаимовыгодных условиях!

Наши преимущества:

- Поставка оригинальных импортных электронных компонентов напрямую с производств Америки, Европы и Азии, а так же с крупнейших складов мира;
- Широкая линейка поставок активных и пассивных импортных электронных компонентов (более 30 млн. наименований);
- Поставка сложных, дефицитных, либо снятых с производства позиций;
- Оперативные сроки поставки под заказ (от 5 рабочих дней);
- Экспресс доставка в любую точку России;
- Помощь Конструкторского Отдела и консультации квалифицированных инженеров;
- Техническая поддержка проекта, помощь в подборе аналогов, поставка прототипов;
- Поставка электронных компонентов под контролем ВП;
- Система менеджмента качества сертифицирована по Международному стандарту ISO 9001;
- При необходимости вся продукция военного и аэрокосмического назначения проходит испытания и сертификацию в лаборатории (по согласованию с заказчиком);
- Поставка специализированных компонентов военного и аэрокосмического уровня качества (Xilinx, Altera, Analog Devices, Intersil, Interpoint, Microsemi, Actel, Aeroflex, Peregrine, VPT, Syfer, Eurofarad, Texas Instruments, MS Kennedy, Miteq, Cobham, E2V, MA-COM, Hittite, Mini-Circuits, General Dynamics и др.);

Компания «Океан Электроники» является официальным дистрибьютором и эксклюзивным представителем в России одного из крупнейших производителей разъемов военного и аэрокосмического назначения «JONHON», а так же официальным дистрибьютором и эксклюзивным представителем в России производителя высокотехнологичных и надежных решений для передачи СВЧ сигналов «FORSTAR».



## JONHON

«JONHON» (основан в 1970 г.)

Разъемы специального, военного и аэрокосмического назначения:

(Применяются в военной, авиационной, аэрокосмической, морской, железнодорожной, горно- и нефтедобывающей отраслях промышленности)

«FORSTAR» (основан в 1998 г.)

ВЧ соединители, коаксиальные кабели, кабельные сборки и микроволновые компоненты:

(Применяются в телекоммуникациях гражданского и специального назначения, в средствах связи, РЛС, а так же военной, авиационной и аэрокосмической отраслях промышленности).



Телефон: 8 (812) 309-75-97 (многоканальный)

Факс: 8 (812) 320-03-32

Электронная почта: [ocean@oceanchips.ru](mailto:ocean@oceanchips.ru)

Web: <http://oceanchips.ru/>

Адрес: 198099, г. Санкт-Петербург, ул. Калинина, д. 2, корп. 4, лит. А