12A High-Speed MOSFET Drivers

Features

- High Peak Output Current: 13A (typical)
- Low Shoot-Through/Cross-Conduction Current in Output Stage
- Wide Input Supply Voltage Operating Range:
 - 4.5V to 18V
- High Continuous Output Current: 2.6A (max.)
- Matched Fast Rise and Fall Times:
 - 21 ns with 10,000 pF Load
 - 42 ns with 22,000 pF Load
- Matched Short Propagation Delays: 44 ns (typ.)
- Low Supply Current:
 - With Logic '1' Input – 140 μ A (typical)
 - With Logic '0' Input – 40 μ A (typical)
- Low Output Impedance: 0.9 Ω (typical)
- Latch-Up Protected: Will Withstand 1.5A Output Reverse Current
- Input Will Withstand Negative Inputs Up To 5V
- Pin-Compatible with the TC4420/TC4429, TC4421/TC4422 and TC4421A/TC4422A MOSFET Drivers
- Space-Saving, Thermally-Enhanced, 8-Pin DFN Package

Applications

- Line Drivers for Extra Heavily-Loaded Lines
- Pulse Generators
- Driving the Largest MOSFETs and IGBTs
- Local Power ON/OFF Switch
- Motor and Solenoid Driver
- LF Initiator

General Description

The TC4451/TC4452 are single-output MOSFET drivers. These devices are high-current buffer/drivers capable of driving large MOSFETs and Insulated Gate Bipolar Transistors (IGBTs). The TC4451/TC4452 have matched output rise and fall times, as well as matched leading and falling-edge propagation delay times. The TC4451/TC4452 devices also have very low cross-conduction current, reducing the overall power dissipation of the device.

These devices are essentially immune to any form of upset, except direct overvoltage or over-dissipation. They cannot be latched under any conditions within their power and voltage ratings. These parts are not subject to damage or improper operation when up to 5V of ground bounce is present on their ground terminals. They can accept, without damage or logic upset, more than 1.5A inductive current of either polarity being forced back into their outputs. In addition, all terminals are fully protected against up to 4 kV of electrostatic discharge.

The TC4451/TC4452 inputs may be driven directly from either TTL or CMOS (3V to 18V). In addition, 300 mV of hysteresis is built into the input, providing noise immunity and allowing the device to be driven from slowly rising or falling waveforms.

With both surface-mount and pin-through-hole packages, in addition to a wide operating temperature range, the TC4451/TC4452 family of 12A MOSFET drivers fit into most any application where high gate/line capacitance drive is required.

TC4451/TC4452

Package Types

8-Pin PDIP/SOIC^(1, 2)

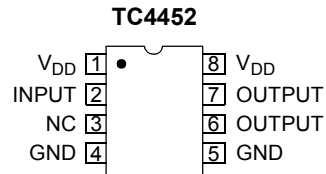
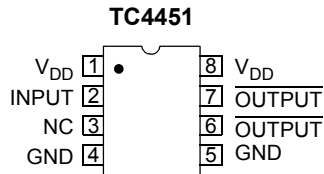

8-Pin DFN^(1, 2)

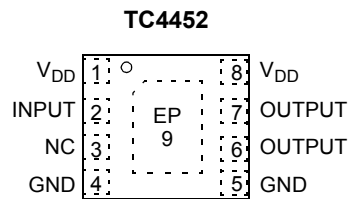
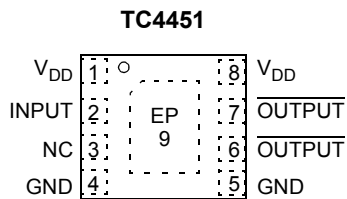

5-Pin TO-220^(1, 2)

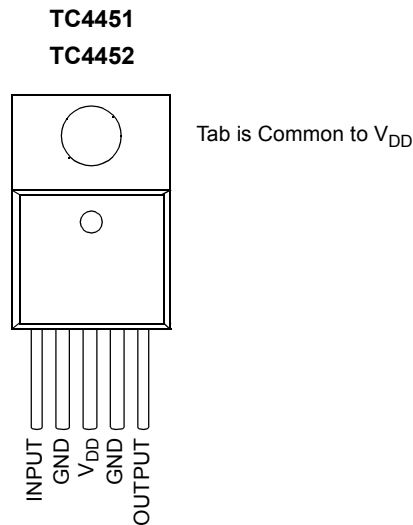

Note 1: Duplicate pins must both be connected for proper operation.

2: Exposed Thermal Pad (EP) of the DFN package is electrically isolated; see [Table 3-1](#).

Functional Block Diagram

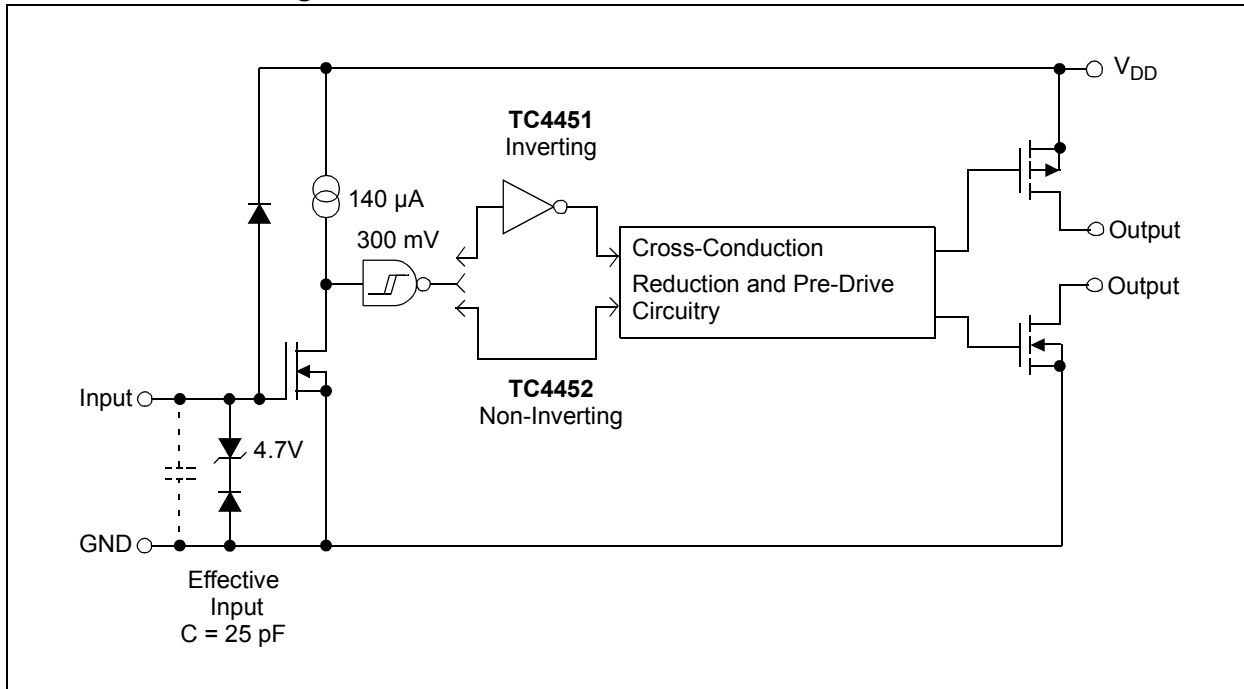

TC4451/TC4452

1.0 ELECTRICAL CHARACTERISTICS

Absolute Maximum Ratings †

Supply Voltage	+20V
Input Voltage	(V _{DD} + 0.3V) to (GND – 5V)
Input Current (V _{IN} > V _{DD})	50 mA

† **Notice:** Stresses above those listed under “Absolute Maximum Ratings” may cause permanent damage to the device. These are stress ratings only and functional operation of the device at these or any other conditions above those indicated in the operation sections of the specifications is not implied. Exposure to Absolute Maximum Rating conditions for extended periods may affect device reliability.

DC CHARACTERISTICS

Electrical Specifications: Unless otherwise noted, T _A = +25°C with 4.5V ≤ V _{DD} ≤ 18V.						
Parameters	Sym	Min	Typ	Max	Units	Conditions
Input						
Logic ‘1’, High Input Voltage	V _{IH}	2.4	1.5	—	V	
Logic ‘0’, Low Input Voltage	V _{IL}	—	1.3	0.8	V	
Input Current	I _{IN}	–10	—	+10	μA	0V ≤ V _{IN} ≤ V _{DD}
Input Voltage	V _{IN}	–5	—	V _{DD} + 0.3	V	
Output						
High Output Voltage	V _{OH}	V _{DD} – 0.025	—	—	V	DC Test
Low Output Voltage	V _{OL}	—	—	0.025	V	DC Test
Output Resistance, High	R _{OH}	—	1.0	1.5	Ω	I _{OUT} = 10 mA, V _{DD} = 18V
Output Resistance, Low	R _{OL}	—	0.9	1.5	Ω	I _{OUT} = 10 mA, V _{DD} = 18V
Peak Output Current	I _{PK}	—	13	—	A	V _{DD} = 18V
Continuous Output Current	I _{DC}	2.6	—	—	A	10V ≤ V _{DD} ≤ 18V (Note 2, Note 3)
Latch-Up Protection Withstand Reverse Current	I _{REV}	—	>1.5	—	A	Duty cycle ≤ 2%, t ≤ 300 μs
Switching Time (Note 1)						
Rise Time	t _R	—	30	40	ns	Figure 4-1, C _L = 15,000 pF
Fall Time	t _F	—	32	40	ns	Figure 4-1, C _L = 15,000 pF
Propagation Delay Time	t _{D1}	—	44	52	ns	Figure 4-1, C _L = 15,000 pF
Propagation Delay Time	t _{D2}	—	44	52	ns	Figure 4-1, C _L = 15,000 pF
Power Supply						
Power Supply Current	I _S	—	140	200	μA	V _{IN} = 3V
		—	40	100	μA	V _{IN} = 0V
Operating Input Voltage	V _{DD}	4.5	—	18.0	V	
V _{DD} Ramp Rate	SV _{DD}	0.2	—	—	V/ms	

- Note 1:** Switching times ensured by design.
Note 2: Tested during characterization, not production tested.
Note 3: Valid for AT and MF packages only. T_A = +25°C.

DC CHARACTERISTICS (OVER OPERATING TEMPERATURE RANGE)

Electrical Specifications: Unless otherwise noted, over operating temperature range with $4.5V \leq V_{DD} \leq 18V$.						
Parameters	Sym	Min	Typ	Max	Units	Conditions
Input						
Logic '1', High Input Voltage	V_{IH}	2.4	—	—	V	
Logic '0', Low Input Voltage	V_{IL}	—	—	0.8	V	
Input Current	I_{IN}	-10	—	+10	μA	$0V \leq V_{IN} \leq V_{DD}$
Output						
High Output Voltage	V_{OH}	$V_{DD} - 0.025$	—	—	V	DC Test
Low Output Voltage	V_{OL}	—	—	0.025	V	DC Test
Output Resistance, High	R_{OH}	—	—	2.2	Ω	$I_{OUT} = 10 \text{ mA}$, $V_{DD} = 18V$
Output Resistance, Low	R_{OL}	—	—	2.0	Ω	$I_{OUT} = 10 \text{ mA}$, $V_{DD} = 18V$
Switching Time (Note 1)						
Rise Time	t_R	—	35	60	ns	Figure 4-1, $C_L = 15,000 \text{ pF}$
Fall Time	t_F	—	38	60	ns	Figure 4-1, $C_L = 15,000 \text{ pF}$
Propagation Delay Time	t_{D1}	—	55	65	ns	Figure 4-1, $C_L = 15,000 \text{ pF}$
Propagation Delay Time	t_{D2}	—	55	65	ns	Figure 4-1, $C_L = 15,000 \text{ pF}$
Power Supply						
Power Supply Current	I_S	—	200	400	μA	$V_{IN} = 3V$
		—	50	150	μA	$V_{IN} = 0V$
Operating Input Voltage	V_{DD}	4.5	—	18.0	V	
V_{DD} Ramp Rate	SV_{DD}	0.2	—	—	V/ms	

Note 1: Switching times ensured by design.

TEMPERATURE CHARACTERISTICS

Electrical Specifications: Unless otherwise noted, all parameters apply with $4.5V \leq V_{DD} \leq 18V$.						
Parameters	Sym	Min	Typ	Max	Units	Conditions
Temperature Ranges						
Specified Temperature Range (V)	T_A	-40	—	+125	$^{\circ}C$	
Maximum Junction Temperature	T_J	—	—	+150	$^{\circ}C$	
Storage Temperature Range	T_A	-65	—	+150	$^{\circ}C$	
Package Thermal Resistances						
Thermal Resistance, 5L-TO-220	θ_{JA}	—	39.5	—	$^{\circ}C/W$	Without heat sink
Thermal Resistance, 8L-6x5 DFN	θ_{JA}	—	35.7	—	$^{\circ}C/W$	Typical 4-layer board with vias to ground plane
Thermal Resistance, 8L-PDIP	θ_{JA}	—	89.3	—	$^{\circ}C/W$	
Thermal Resistance, 8L-SOIC	θ_{JA}	—	149.5	—	$^{\circ}C/W$	

TC4451/TC4452

2.0 TYPICAL PERFORMANCE CURVES

Note: The graphs and tables provided following this note are a statistical summary based on a limited number of samples and are provided for informational purposes only. The performance characteristics listed herein are not tested or guaranteed. In some graphs or tables, the data presented may be outside the specified operating range (e.g., outside specified power supply range) and therefore outside the warranted range.

Note: Unless otherwise indicated, $T_A = +25^\circ\text{C}$ with $4.5\text{V} \leq V_{DD} \leq 18\text{V}$.

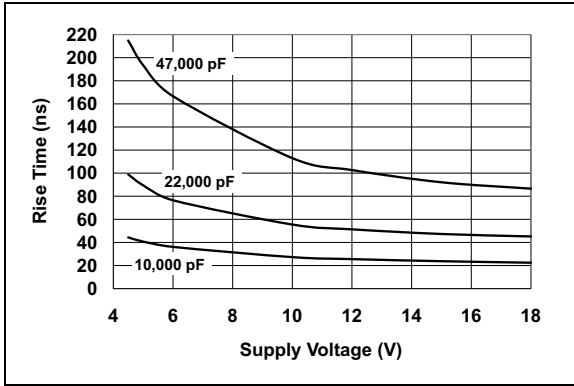

FIGURE 2-1: Rise Time vs. Supply Voltage.

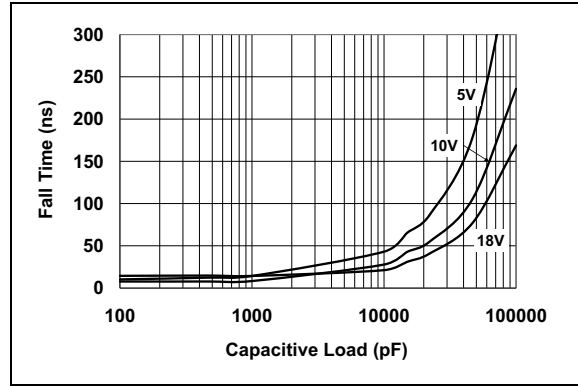

FIGURE 2-4: Fall Time vs. Capacitive Load.

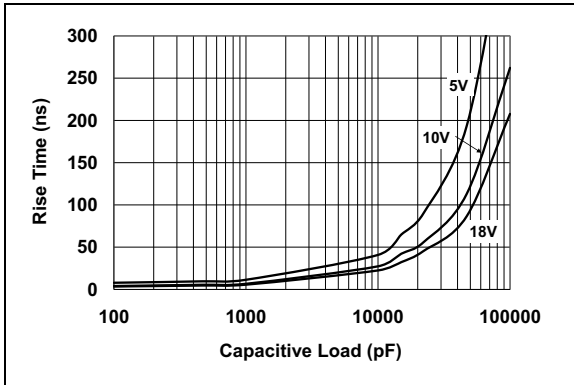

FIGURE 2-2: Rise Time vs. Capacitive Load.

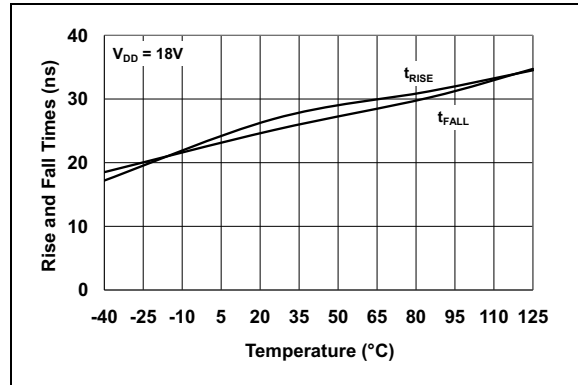

FIGURE 2-5: Rise and Fall Times vs. Temperature.

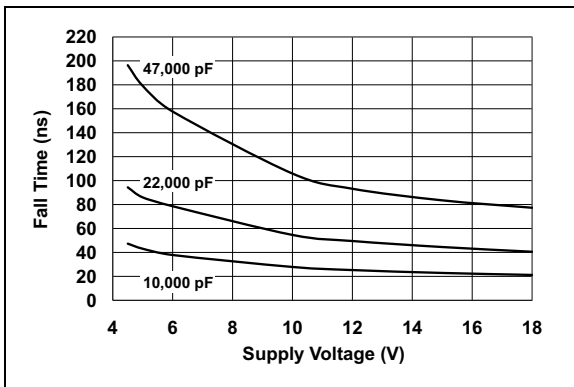

FIGURE 2-3: Fall Time vs. Supply Voltage.

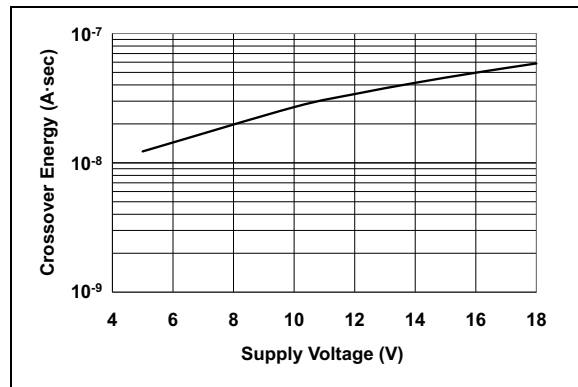

FIGURE 2-6: Crossover Energy vs. Supply Voltage.

TC4451/TC4452

Note: Unless otherwise indicated, $T_A = +25^\circ\text{C}$ with $4.5\text{V} \leq V_{DD} \leq 18\text{V}$.

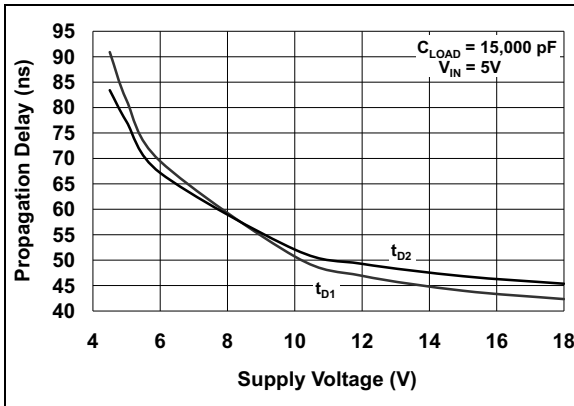

FIGURE 2-7: Propagation Delay vs. Supply Voltage.

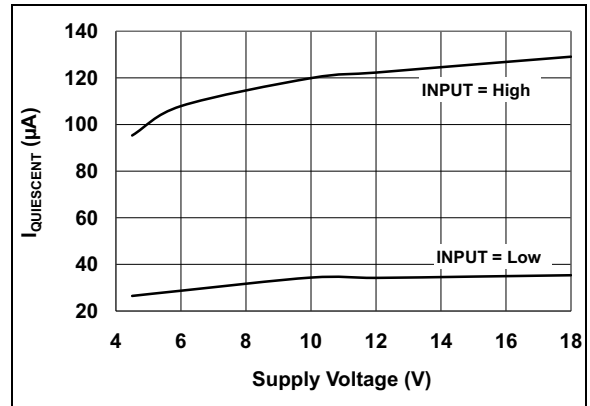

FIGURE 2-10: Quiescent Supply Current vs. Supply Voltage.

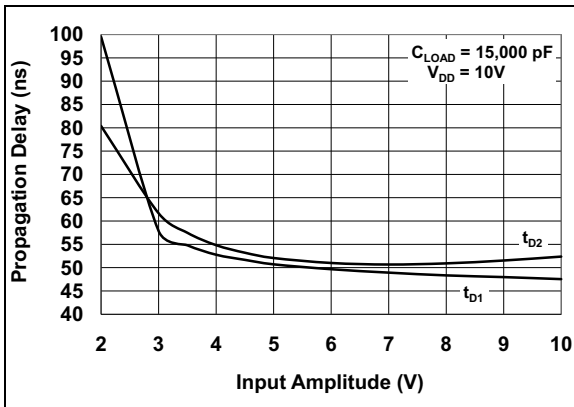

FIGURE 2-8: Propagation Delay vs. Input Amplitude.

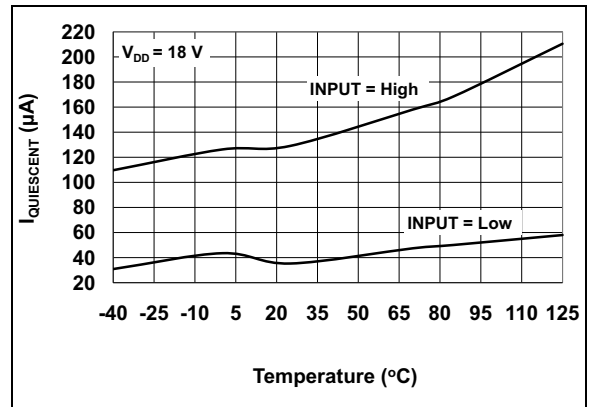

FIGURE 2-11: Quiescent Supply Current vs. Temperature.

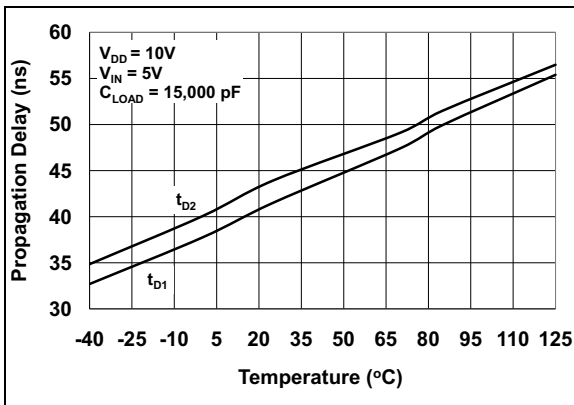

FIGURE 2-9: Propagation Delay vs. Temperature.

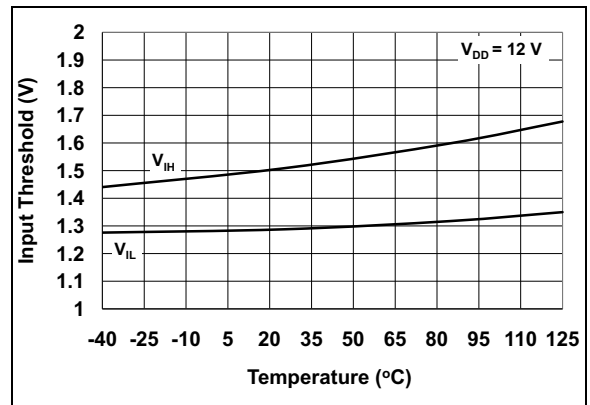

FIGURE 2-12: Input Threshold vs. Temperature.

TC4451/TC4452

Note: Unless otherwise indicated, $T_A = +25^\circ\text{C}$ with $4.5\text{V} \leq V_{DD} \leq 18\text{V}$.

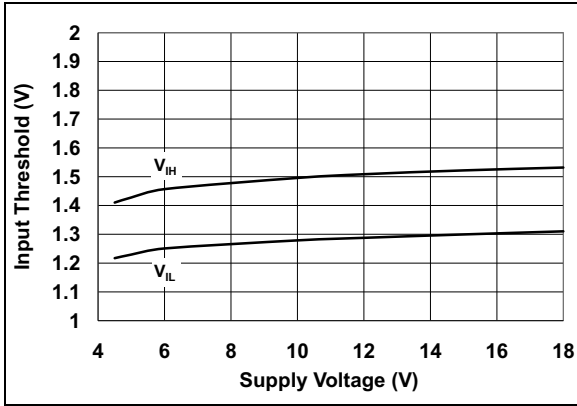

FIGURE 2-13: Input Threshold vs. Supply Voltage.

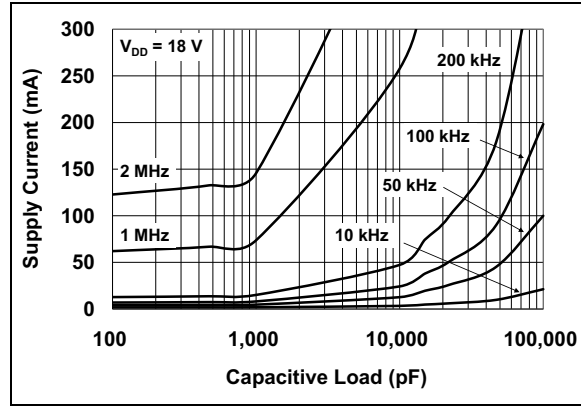

FIGURE 2-16: Supply Current vs. Capacitive Load ($V_{DD} = 18\text{V}$).

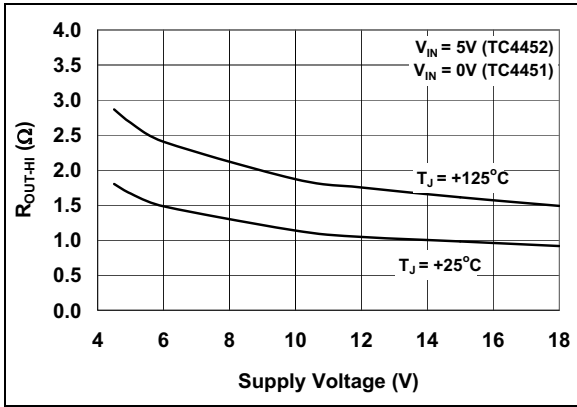

FIGURE 2-14: High-State Output Resistance vs. Supply Voltage.

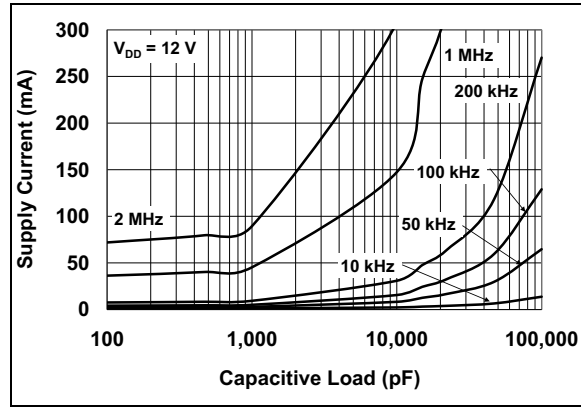

FIGURE 2-17: Supply Current vs. Capacitive Load ($V_{DD} = 12\text{V}$).

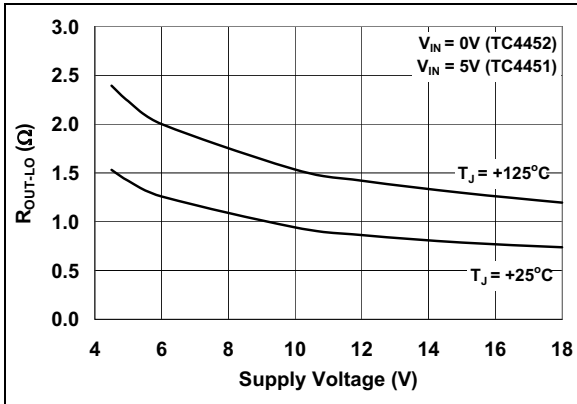

FIGURE 2-15: Low-State Output Resistance vs. Supply Voltage.

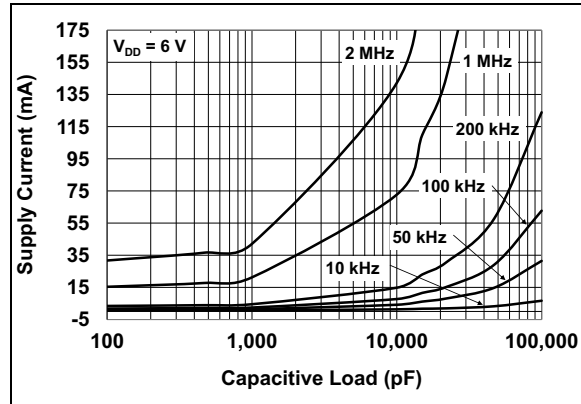

FIGURE 2-18: Supply Current vs. Capacitive Load ($V_{DD} = 6\text{V}$).

Note: Unless otherwise indicated, $T_A = +25^\circ\text{C}$ with $4.5\text{V} \leq V_{DD} \leq 18\text{V}$.

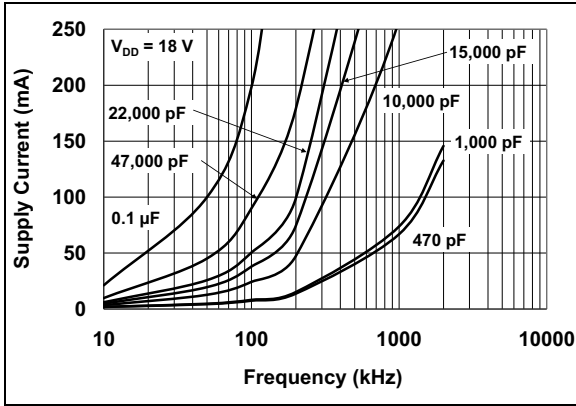

FIGURE 2-19: Supply Current vs. Frequency ($V_{DD} = 18\text{V}$).

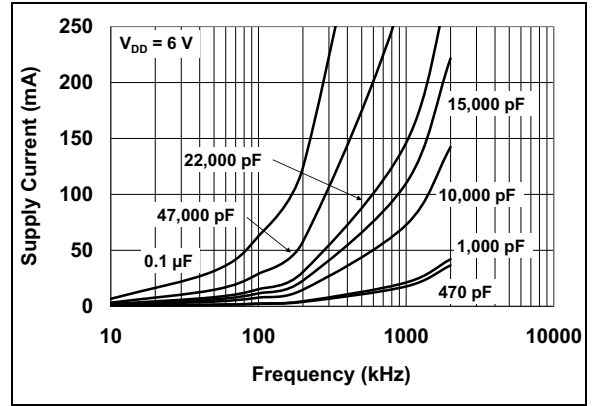

FIGURE 2-21: Supply Current vs. Frequency ($V_{DD} = 6\text{V}$).

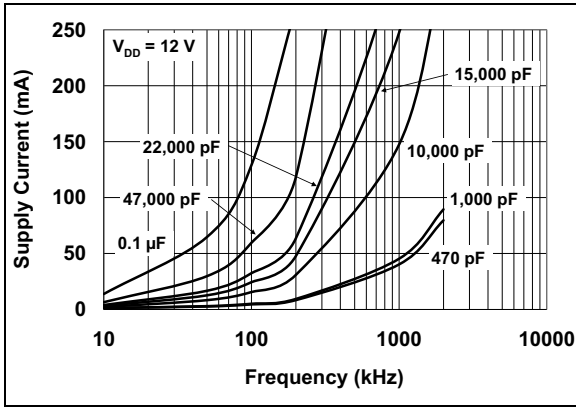

FIGURE 2-20: Supply Current vs. Frequency ($V_{DD} = 12\text{V}$).

TC4451/TC4452

3.0 PIN DESCRIPTIONS

The descriptions of the pins are listed in [Table 3-1](#).

TABLE 3-1: PIN FUNCTION TABLE

8-Pin PDIP, SOIC	8-Pin DFN	5-Pin TO-220	Symbol	Description
1	1	—	V_{DD}	Supply input, 4.5V to 18V
2	2	1	INPUT	Control input, TTL/CMOS-compatible input
3	3	—	NC	No connection
4	4	2	GND	Ground
5	5	4	GND	Ground
6	6	5	OUTPUT	CMOS push-pull output
7	7	—	OUTPUT	CMOS push-pull output
8	8	3	V_{DD}	Supply input, 4.5V to 18V
—	9	—	EP	Exposed metal pad
—	—	TAB	V_{DD}	Metal tab is at the V_{DD} potential

3.1 Supply Input (V_{DD})

The V_{DD} input is the bias supply for the MOSFET driver and is rated for 4.5V to 18V with respect to the ground pin. The V_{DD} input should be bypassed to ground with a local ceramic capacitor. The value of the capacitor should be chosen based on the capacitive load that is being driven. A minimum value of 1.0 μ F is suggested.

3.2 Control Input (INPUT)

The MOSFET driver input is a high-impedance, TTL/CMOS-compatible input. The input also has 300 mV of hysteresis between the high and low thresholds that prevents output glitching even when the rise and fall time of the input signal is very slow.

3.3 CMOS Push-Pull Output (OUTPUT)

The MOSFET driver output is a low-impedance, CMOS, push-pull style output capable of driving a capacitive load with 12A peak currents. The MOSFET driver output is capable of withstanding 1.5A peak reverse currents of either polarity.

3.4 Ground (GND)

The ground pins are the return path for the bias current and for the high peak currents that discharge the load capacitor. The ground pins should be tied into a ground plane or have very short traces to the bias supply source return.

3.5 Exposed Metal Pad (EP)

The exposed metal pad of the 6x5 DFN package is not internally connected to any potential. Therefore, this pad can be connected to a ground plane or other copper plane on a Printed Circuit Board (PCB) to aid in heat removal from the package.

3.6 Metal Tab

The metal tab of the TO-220 package is connected to the V_{DD} potential of the device. This connection to V_{DD} can be used as a current carrying path for the device.

4.0 APPLICATIONS INFORMATION

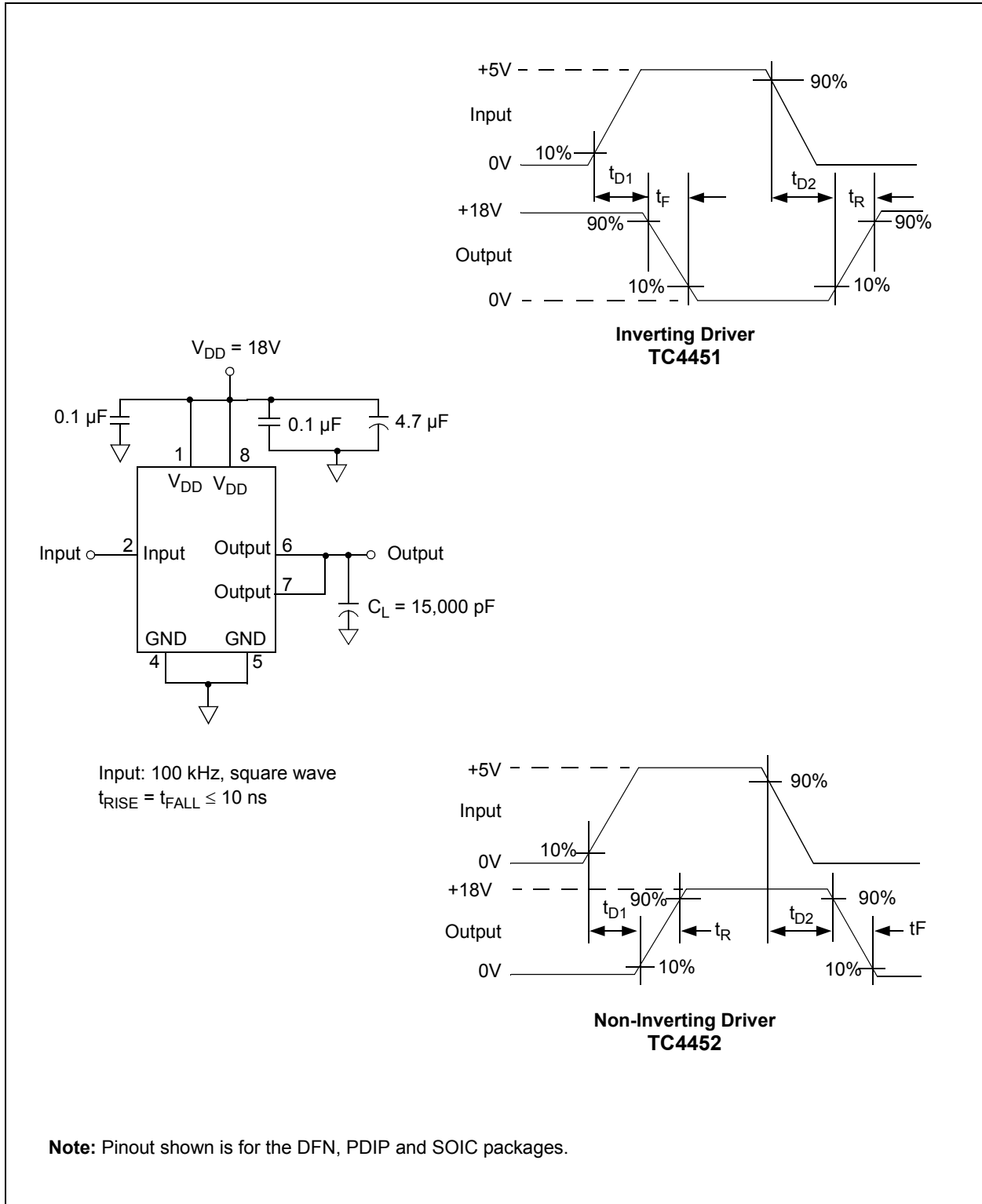

FIGURE 4-1: Switching Time Test Circuits.

TC4451/TC4452

5.0 PACKAGING INFORMATION

5.1 Package Marking Information

5-Lead TO-220

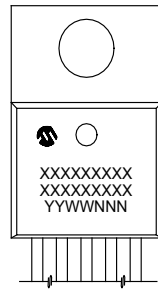

Example:

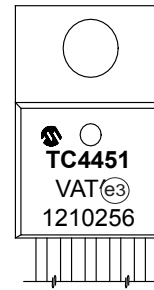

8-Lead DFN-S (6x5x0.9 mm)

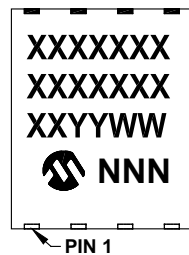

Example:

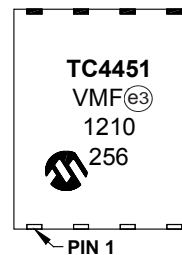

8-Lead PDIP (300 mil)

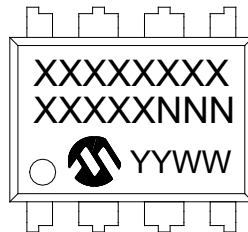

Example

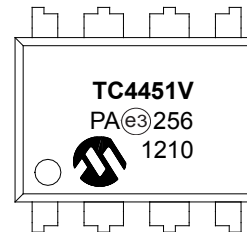

8-Lead SOIC (3.90 mm)

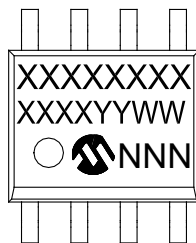

Example

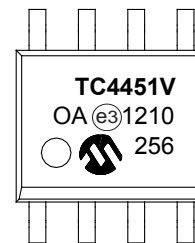

Legend:	XX...X	Customer-specific information
	Y	Year code (last digit of calendar year)
	YY	Year code (last 2 digits of calendar year)
	WW	Week code (week of January 1 is week '01')
	NNN	Alphanumeric traceability code
	(e3)	Pb-free JEDEC designator for Matte Tin (Sn)
	*	This package is Pb-free. The Pb-free JEDEC designator (e3) can be found on the outer packaging for this package.

Note: In the event the full Microchip part number cannot be marked on one line, it will be carried over to the next line, thus limiting the number of available characters for customer-specific information.

5-Lead Plastic Transistor Outline (AT) [TO-220]

Note: For the most current package drawings, please see the Microchip Packaging Specification located at <http://www.microchip.com/packaging>

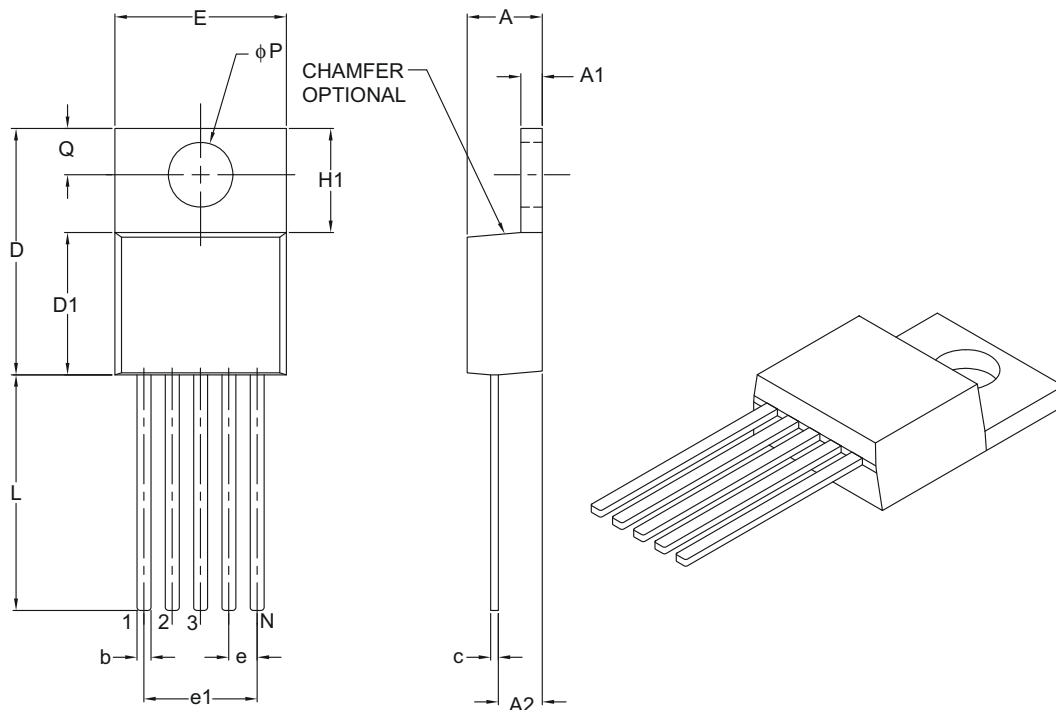

Dimension Limits	Units	INCHES		
		MIN	NOM	MAX
Number of Pins	N	5		
Pitch	e	.067 BSC		
Overall Pin Pitch	e1	.268 BSC		
Overall Height	A	.140	–	.190
Overall Width	E	.380	–	.420
Overall Length	D	.560	–	.650
Molded Package Length	D1	.330	–	.355
Tab Length	H1	.204	–	.293
Tab Thickness	A1	.020	–	.055
Mounting Hole Center	Q	.100	–	.120
Mounting Hole Diameter	φP	.139	–	.156
Lead Length	L	.482	–	.590
Base to Bottom of Lead	A2	.080	–	.115
Lead Thickness	c	.012	–	.025
Lead Width	b	.015	.027	.040

Notes:

- Dimensions D and E do not include mold flash or protrusions. Mold flash or protrusions shall not exceed .005" per side.
- Dimensioning and tolerancing per ASME Y14.5M.
BSC: Basic Dimension. Theoretically exact value shown without tolerances.

Microchip Technology Drawing C04-036B

TC4451/TC4452

8-Lead Plastic Dual Flat, No Lead Package (MF) – 6x5 mm Body [DFN-S]

Note: For the most current package drawings, please see the Microchip Packaging Specification located at <http://www.microchip.com/packaging>

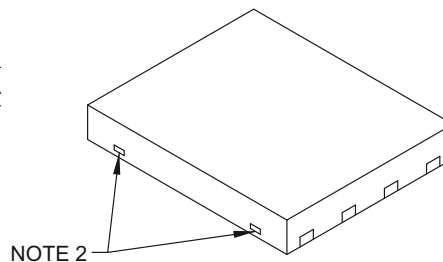
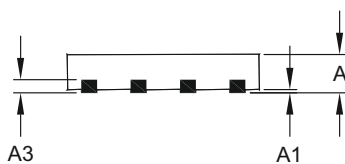
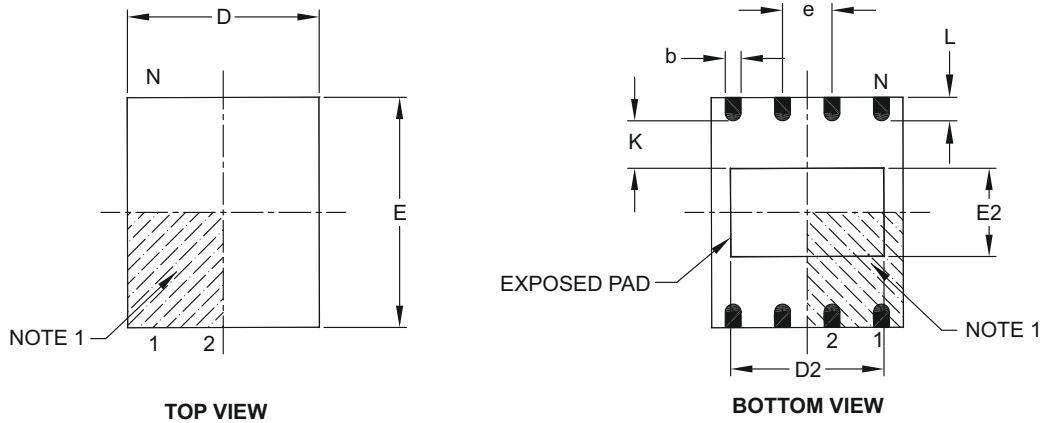

Dimension Limits	Units	MILLIMETERS		
		MIN	NOM	MAX
Number of Pins	N	8		
Pitch	e	1.27 BSC		
Overall Height	A	0.80	0.85	1.00
Standoff	A1	0.00	0.01	0.05
Contact Thickness	A3	0.20 REF		
Overall Length	D	5.00 BSC		
Overall Width	E	6.00 BSC		
Exposed Pad Length	D2	3.90	4.00	4.10
Exposed Pad Width	E2	2.20	2.30	2.40
Contact Width	b	0.35	0.40	0.48
Contact Length	L	0.50	0.60	0.75
Contact-to-Exposed Pad	K	0.20	-	-

Notes:

- Pin 1 visual index feature may vary, but must be located within the hatched area.
- Package may have one or more exposed tie bars at ends.
- Package is saw singulated.
- Dimensioning and tolerancing per ASME Y14.5M.

BSC: Basic Dimension. Theoretically exact value shown without tolerances.

REF: Reference Dimension, usually without tolerance, for information purposes only.

Microchip Technology Drawing C04-122B

8-Lead Plastic Dual Flat, No Lead Package (MF) - 6x5 mm Body [DFN-S]

Note: For the most current package drawings, please see the Microchip Packaging Specification located at <http://www.microchip.com/packaging>

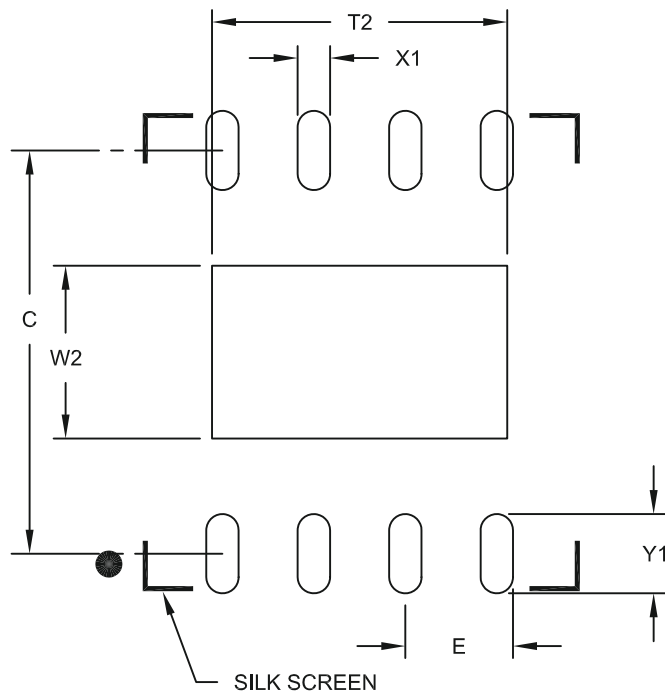

RECOMMENDED LAND PATTERN

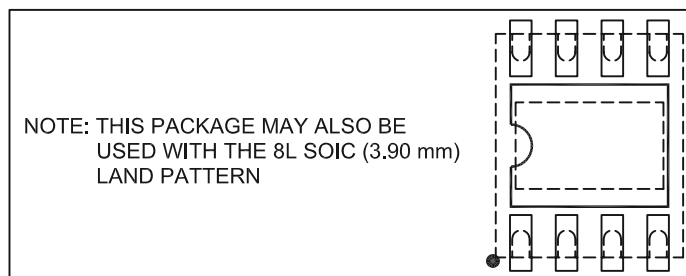

Dimension Limits	Units	MILLIMETERS		
		MIN	NOM	MAX
Contact Pitch	E	1.27 BSC		
Optional Center Pad Width	W2			2.40
Optional Center Pad Length	T2			4.10
Contact Pad Spacing	C	5.60		
Contact Pad Width (X8)	X1			0.45
Contact Pad Length (X8)	Y1			1.10

Notes:

1. Dimensioning and tolerancing per ASME Y14.5M

BSC: Basic Dimension. Theoretically exact value shown without tolerances.

Microchip Technology Drawing No. C04-2122A

TC4451/TC4452

8-Lead Plastic Dual In-Line (PA) – 300 mil Body [PDIP]

Note: For the most current package drawings, please see the Microchip Packaging Specification located at <http://www.microchip.com/packageing>

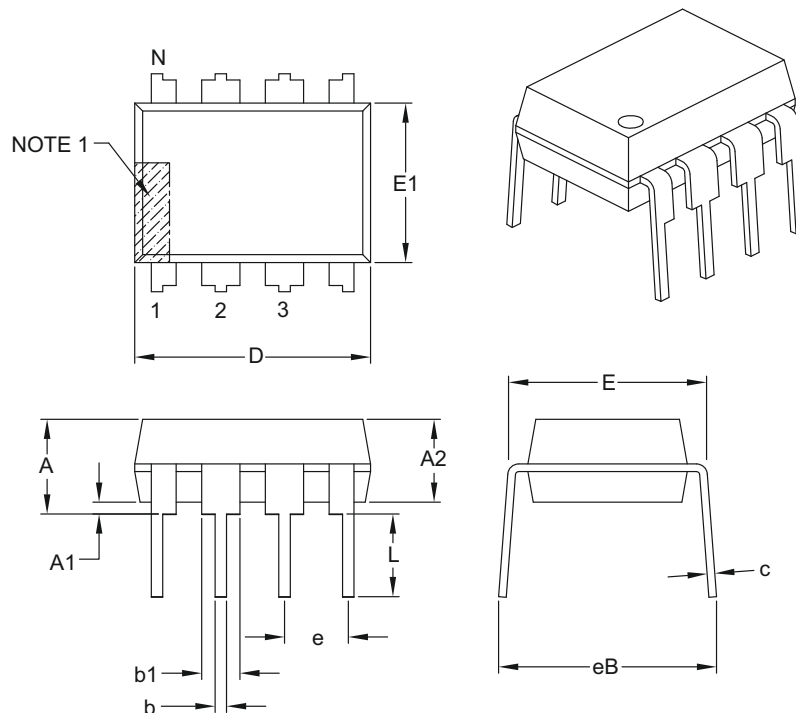

Dimension Limits	Units	INCHES		
		MIN	NOM	MAX
Number of Pins	N	8		
Pitch	e	.100 BSC		
Top to Seating Plane	A	–	–	.210
Molded Package Thickness	A2	.115	.130	.195
Base to Seating Plane	A1	.015	–	–
Shoulder to Shoulder Width	E	.290	.310	.325
Molded Package Width	E1	.240	.250	.280
Overall Length	D	.348	.365	.400
Tip to Seating Plane	L	.115	.130	.150
Lead Thickness	c	.008	.010	.015
Upper Lead Width	b1	.040	.060	.070
Lower Lead Width	b	.014	.018	.022
Overall Row Spacing §	eB	–	–	.430

Notes:

- Pin 1 visual index feature may vary, but must be located with the hatched area.
- § Significant Characteristic.
- Dimensions D and E1 do not include mold flash or protrusions. Mold flash or protrusions shall not exceed .010" per side.
- Dimensioning and tolerancing per ASME Y14.5M.

BSC: Basic Dimension. Theoretically exact value shown without tolerances.

Microchip Technology Drawing C04-018B

8-Lead Plastic Small Outline (OA) - Narrow, 3.90 mm Body [SOIC]

Note: For the most current package drawings, please see the Microchip Packaging Specification located at <http://www.microchip.com/packaging>

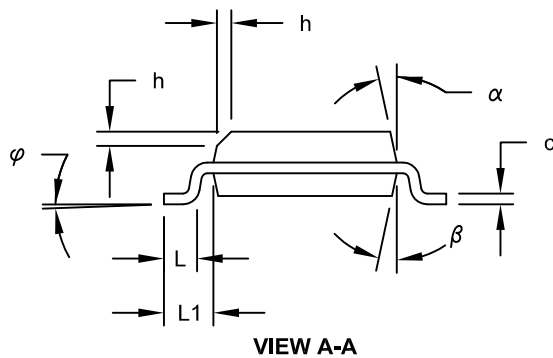
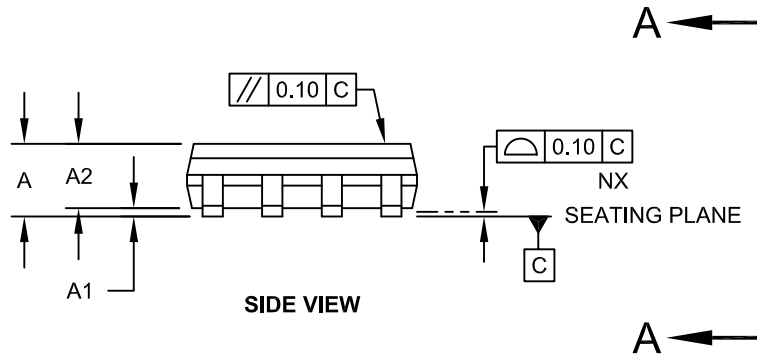
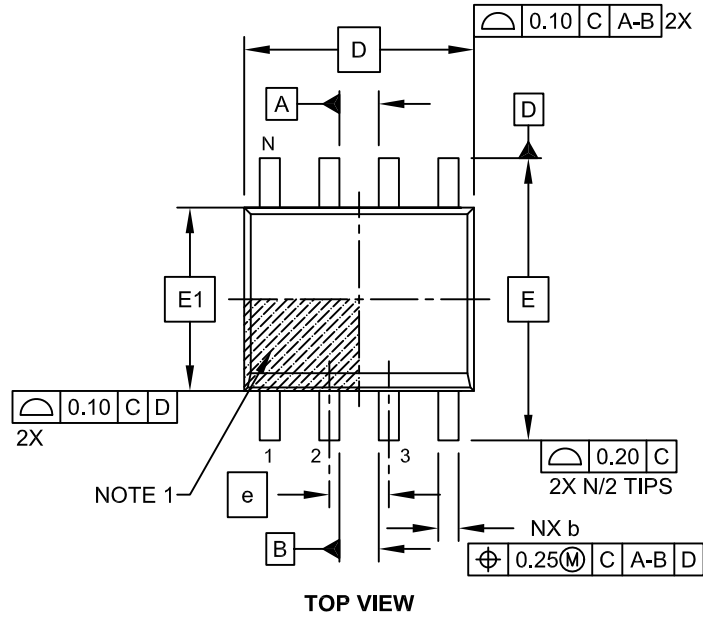

TC4451/TC4452

8-Lead Plastic Small Outline (OA) - Narrow, 3.90 mm Body [SOIC]

Note: For the most current package drawings, please see the Microchip Packaging Specification located at <http://www.microchip.com/packaging>

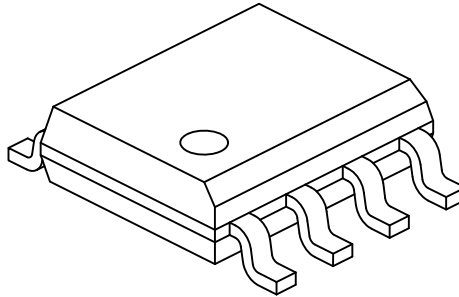

Dimension Limits	Units	MILLIMETERS		
		MIN	NOM	MAX
Number of Pins	N	8		
Pitch	e	1.27 BSC		
Overall Height	A	-	-	1.75
Molded Package Thickness	A2	1.25	-	-
Standoff §	A1	0.10	-	0.25
Overall Width	E	6.00 BSC		
Molded Package Width	E1	3.90 BSC		
Overall Length	D	4.90 BSC		
Chamfer (Optional)	h	0.25	-	0.50
Foot Length	L	0.40	-	1.27
Footprint	L1	1.04 REF		
Foot Angle	φ	0°	-	8°
Lead Thickness	c	0.17	-	0.25
Lead Width	b	0.31	-	0.51
Mold Draft Angle Top	α	5°	-	15°
Mold Draft Angle Bottom	β	5°	-	15°

Notes:

1. Pin 1 visual index feature may vary, but must be located within the hatched area.
2. § Significant Characteristic
3. Dimensions D and E1 do not include mold flash or protrusions. Mold flash or protrusions shall not exceed 0.15mm per side.
4. Dimensioning and tolerancing per ASME Y14.5M

BSC: Basic Dimension. Theoretically exact value shown without tolerances.

REF: Reference Dimension, usually without tolerance, for information purposes only.

Microchip Technology Drawing No. C04-057C Sheet 2 of 2

8-Lead Plastic Small Outline (OA) – Narrow, 3.90 mm Body [SOIC]

Note: For the most current package drawings, please see the Microchip Packaging Specification located at <http://www.microchip.com/packaging>

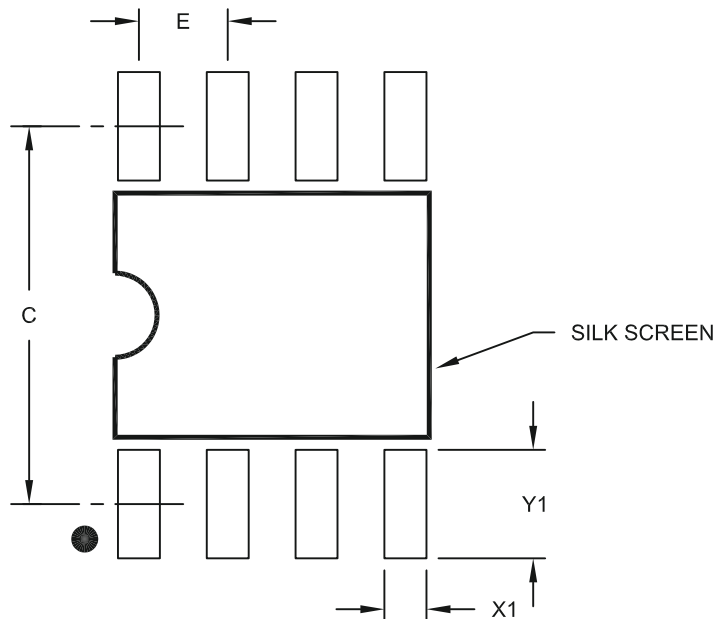

RECOMMENDED LAND PATTERN

Dimension Limits	Units	MILLIMETERS		
		MIN	NOM	MAX
Contact Pitch	E	1.27 BSC		
Contact Pad Spacing	C		5.40	
Contact Pad Width (X8)	X1			0.60
Contact Pad Length (X8)	Y1			1.55

Notes:

1. Dimensioning and tolerancing per ASME Y14.5M

BSC: Basic Dimension. Theoretically exact value shown without tolerances.

Microchip Technology Drawing No. C04-2057A

TC4451/TC4452

NOTES:

APPENDIX A: REVISION HISTORY

Revision B (March 2012)

The following is the list of modifications:

1. Added V_{DD} Ramp Rate value in both [DC Characteristics](#) and [DC Characteristics \(Over Operating Temperature Range\)](#) tables.
2. Updated package thermal resistances values in [Temperature Characteristics](#) table.
3. Updated package specification drawings in [Section 5.0, Packaging Information](#) to show all available drawings.

Revision A (February 2006)

Original release of this document.

TC4451/TC4452

NOTES:

PRODUCT IDENTIFICATION SYSTEM

To order or obtain information, e.g., on pricing or delivery, refer to the factory or the listed sales office.

<u>PART NO.</u>	<u>X</u>	<u>XX</u>	<u>XXX</u>	Examples:
Device	Temperature Range	Package	Tape & Reel	
Device:		TC4451: 12A High-Speed MOSFET Driver, Inverting TC4452: 12A High-Speed MOSFET Driver, Non-Inverting		a) TC4451VAT: 12A High-Speed Inverting MOSFET Driver, TO-220 package b) TC4451VOA: 12A High-Speed Inverting MOSFET Driver, SOIC package c) TC4451VMF: 12A High-Speed Inverting MOSFET Driver, DFN package
Temperature Range:	V	= -40°C to +125°C		a) TC4452VPA: 12A High-Speed Non-Inverting MOSFET Driver, PDIP package b) TC4452VOA: 12A High-Speed Non-Inverting MOSFET Driver, SOIC package c) TC4452VMF: 12A High-Speed Non-Inverting MOSFET Driver, DFN package
Package: *		AT = TO-220, 5-lead MF = Dual, Flat, No-Lead (6x5 mm Body), 8-lead MF713 = Dual, Flat, No-Lead (6x5 mm Body), 8-lead (Tape and Reel) PA = Plastic DIP (300 mil Body), 8-lead OA = Plastic SOIC (150 mil Body), 8-lead OA713 = Plastic SOIC (150 mil Body), 8-lead (Tape and Reel)		
		*All package offerings are Pb Free (Lead Free).		

TC4451/TC4452

NOTES:

Note the following details of the code protection feature on Microchip devices:

- Microchip products meet the specification contained in their particular Microchip Data Sheet.
- Microchip believes that its family of products is one of the most secure families of its kind on the market today, when used in the intended manner and under normal conditions.
- There are dishonest and possibly illegal methods used to breach the code protection feature. All of these methods, to our knowledge, require using the Microchip products in a manner outside the operating specifications contained in Microchip's Data Sheets. Most likely, the person doing so is engaged in theft of intellectual property.
- Microchip is willing to work with the customer who is concerned about the integrity of their code.
- Neither Microchip nor any other semiconductor manufacturer can guarantee the security of their code. Code protection does not mean that we are guaranteeing the product as “unbreakable.”

Code protection is constantly evolving. We at Microchip are committed to continuously improving the code protection features of our products. Attempts to break Microchip's code protection feature may be a violation of the Digital Millennium Copyright Act. If such acts allow unauthorized access to your software or other copyrighted work, you may have a right to sue for relief under that Act.

Information contained in this publication regarding device applications and the like is provided only for your convenience and may be superseded by updates. It is your responsibility to ensure that your application meets with your specifications. MICROCHIP MAKES NO REPRESENTATIONS OR WARRANTIES OF ANY KIND WHETHER EXPRESS OR IMPLIED, WRITTEN OR ORAL, STATUTORY OR OTHERWISE, RELATED TO THE INFORMATION, INCLUDING BUT NOT LIMITED TO ITS CONDITION, QUALITY, PERFORMANCE, MERCHANTABILITY OR FITNESS FOR PURPOSE. Microchip disclaims all liability arising from this information and its use. Use of Microchip devices in life support and/or safety applications is entirely at the buyer's risk, and the buyer agrees to defend, indemnify and hold harmless Microchip from any and all damages, claims, suits, or expenses resulting from such use. No licenses are conveyed, implicitly or otherwise, under any Microchip intellectual property rights.

Trademarks

The Microchip name and logo, the Microchip logo, dsPIC, KEELOQ, KEELOQ logo, MPLAB, PIC, PICmicro, PICSTART, PIC³² logo, rPIC and UNI/O are registered trademarks of Microchip Technology Incorporated in the U.S.A. and other countries.

FilterLab, Hampshire, HI-TECH C, Linear Active Thermistor, MXDEV, MXLAB, SEEVAL and The Embedded Control Solutions Company are registered trademarks of Microchip Technology Incorporated in the U.S.A.

Analog-for-the-Digital Age, Application Maestro, chipKIT, chipKIT logo, CodeGuard, dsPICDEM, dsPICDEM.net, dsPICworks, dsSPEAK, ECAN, ECONOMONITOR, FanSense, HI-TIDE, In-Circuit Serial Programming, ICSP, Mindi, MiWi, MPASM, MPLAB Certified logo, MPLIB, MPLINK, mTouch, Omniscient Code Generation, PICC, PICC-18, PICDEM, PICDEM.net, PICKIT, PICtail, REAL ICE, rLAB, Select Mode, Total Endurance, TSHARC, UniWinDriver, WiperLock and ZENA are trademarks of Microchip Technology Incorporated in the U.S.A. and other countries.

SQTP is a service mark of Microchip Technology Incorporated in the U.S.A.

All other trademarks mentioned herein are property of their respective companies.

© 2006-2012, Microchip Technology Incorporated, Printed in the U.S.A., All Rights Reserved.

 Printed on recycled paper.

ISBN: 978-1-62076-077-2

**QUALITY MANAGEMENT SYSTEM
CERTIFIED BY DNV
= ISO/TS 16949 =**

Microchip received ISO/TS-16949:2009 certification for its worldwide headquarters, design and wafer fabrication facilities in Chandler and Tempe, Arizona; Gresham, Oregon and design centers in California and India. The Company's quality system processes and procedures are for its PIC[®] MCUs and dsPIC[®] DSCs, KEELOQ[®] code hopping devices, Serial EEPROMs, microperipherals, nonvolatile memory and analog products. In addition, Microchip's quality system for the design and manufacture of development systems is ISO 9001:2000 certified.



MICROCHIP

Worldwide Sales and Service

AMERICAS

Corporate Office
2355 West Chandler Blvd.
Chandler, AZ 85224-6199
Tel: 480-792-7200
Fax: 480-792-7277
Technical Support:
<http://www.microchip.com/support>
Web Address:
www.microchip.com

Atlanta
Duluth, GA
Tel: 678-957-9614
Fax: 678-957-1455

Boston
Westborough, MA
Tel: 774-760-0087
Fax: 774-760-0088

Chicago
Itasca, IL
Tel: 630-285-0071
Fax: 630-285-0075

Cleveland
Independence, OH
Tel: 216-447-0464
Fax: 216-447-0643

Dallas
Addison, TX
Tel: 972-818-7423
Fax: 972-818-2924

Detroit
Farmington Hills, MI
Tel: 248-538-2250
Fax: 248-538-2260

Indianapolis
Noblesville, IN
Tel: 317-773-8323
Fax: 317-773-5453

Los Angeles
Mission Viejo, CA
Tel: 949-462-9523
Fax: 949-462-9608

Santa Clara
Santa Clara, CA
Tel: 408-961-6444
Fax: 408-961-6445

Toronto
Mississauga, Ontario,
Canada
Tel: 905-673-0699
Fax: 905-673-6509

ASIA/PACIFIC

Asia Pacific Office
Suites 3707-14, 37th Floor
Tower 6, The Gateway
Harbour City, Kowloon
Hong Kong
Tel: 852-2401-1200
Fax: 852-2401-3431

Australia - Sydney
Tel: 61-2-9868-6733
Fax: 61-2-9868-6755

China - Beijing
Tel: 86-10-8569-7000
Fax: 86-10-8528-2104

China - Chengdu
Tel: 86-28-8665-5511
Fax: 86-28-8665-7889

China - Chongqing
Tel: 86-23-8980-9588
Fax: 86-23-8980-9500

China - Hangzhou
Tel: 86-571-2819-3187
Fax: 86-571-2819-3189

China - Hong Kong SAR
Tel: 852-2401-1200
Fax: 852-2401-3431

China - Nanjing
Tel: 86-25-8473-2460
Fax: 86-25-8473-2470

China - Qingdao
Tel: 86-532-8502-7355
Fax: 86-532-8502-7205

China - Shanghai
Tel: 86-21-5407-5533
Fax: 86-21-5407-5066

China - Shenyang
Tel: 86-24-2334-2829
Fax: 86-24-2334-2393

China - Shenzhen
Tel: 86-755-8203-2660
Fax: 86-755-8203-1760

China - Wuhan
Tel: 86-27-5980-5300
Fax: 86-27-5980-5118

China - Xian
Tel: 86-29-8833-7252
Fax: 86-29-8833-7256

China - Xiamen
Tel: 86-592-2388138
Fax: 86-592-2388130

China - Zhuhai
Tel: 86-756-3210040
Fax: 86-756-3210049

ASIA/PACIFIC

India - Bangalore
Tel: 91-80-3090-4444
Fax: 91-80-3090-4123

India - New Delhi
Tel: 91-11-4160-8631
Fax: 91-11-4160-8632

India - Pune
Tel: 91-20-2566-1512
Fax: 91-20-2566-1513

Japan - Osaka
Tel: 81-66-152-7160
Fax: 81-66-152-9310

Japan - Yokohama
Tel: 81-45-471-6166
Fax: 81-45-471-6122

Korea - Daegu
Tel: 82-53-744-4301
Fax: 82-53-744-4302

Korea - Seoul
Tel: 82-2-554-7200
Fax: 82-2-558-5932 or
82-2-558-5934

Malaysia - Kuala Lumpur
Tel: 60-3-6201-9857
Fax: 60-3-6201-9859

Malaysia - Penang
Tel: 60-4-227-8870
Fax: 60-4-227-4068

Philippines - Manila
Tel: 63-2-634-9065
Fax: 63-2-634-9069

Singapore
Tel: 65-6334-8870
Fax: 65-6334-8850

Taiwan - Hsin Chu
Tel: 886-3-5778-366
Fax: 886-3-5770-955

Taiwan - Kaohsiung
Tel: 886-7-536-4818
Fax: 886-7-330-9305

Taiwan - Taipei
Tel: 886-2-2500-6610
Fax: 886-2-2508-0102

Thailand - Bangkok
Tel: 66-2-694-1351
Fax: 66-2-694-1350

EUROPE

Austria - Wels
Tel: 43-7242-2244-39
Fax: 43-7242-2244-393

Denmark - Copenhagen
Tel: 45-4450-2828
Fax: 45-4485-2829

France - Paris
Tel: 33-1-69-53-63-20
Fax: 33-1-69-30-90-79

Germany - Munich
Tel: 49-89-627-144-0
Fax: 49-89-627-144-44

Italy - Milan
Tel: 39-0331-742611
Fax: 39-0331-466781

Netherlands - Drunen
Tel: 31-416-690399
Fax: 31-416-690340

Spain - Madrid
Tel: 34-91-708-08-90
Fax: 34-91-708-08-91

UK - Wokingham
Tel: 44-118-921-5869
Fax: 44-118-921-5820

11/29/11

Компания «Океан Электроники» предлагает заключение долгосрочных отношений при поставках импортных электронных компонентов на взаимовыгодных условиях!

Наши преимущества:

- Поставка оригинальных импортных электронных компонентов напрямую с производств Америки, Европы и Азии, а так же с крупнейших складов мира;
- Широкая линейка поставок активных и пассивных импортных электронных компонентов (более 30 млн. наименований);
- Поставка сложных, дефицитных, либо снятых с производства позиций;
- Оперативные сроки поставки под заказ (от 5 рабочих дней);
- Экспресс доставка в любую точку России;
- Помощь Конструкторского Отдела и консультации квалифицированных инженеров;
- Техническая поддержка проекта, помощь в подборе аналогов, поставка прототипов;
- Поставка электронных компонентов под контролем ВП;
- Система менеджмента качества сертифицирована по Международному стандарту ISO 9001;
- При необходимости вся продукция военного и аэрокосмического назначения проходит испытания и сертификацию в лаборатории (по согласованию с заказчиком);
- Поставка специализированных компонентов военного и аэрокосмического уровня качества (Xilinx, Altera, Analog Devices, Intersil, Interpoint, Microsemi, Actel, Aeroflex, Peregrine, VPT, Syfer, Eurofarad, Texas Instruments, MS Kennedy, Miteq, Cobham, E2V, MA-COM, Hittite, Mini-Circuits, General Dynamics и др.);

Компания «Океан Электроники» является официальным дистрибьютором и эксклюзивным представителем в России одного из крупнейших производителей разъемов военного и аэрокосмического назначения «JONHON», а так же официальным дистрибьютором и эксклюзивным представителем в России производителя высокотехнологичных и надежных решений для передачи СВЧ сигналов «FORSTAR».



JONHON

«JONHON» (основан в 1970 г.)

Разъемы специального, военного и аэрокосмического назначения:

(Применяются в военной, авиационной, аэрокосмической, морской, железнодорожной, горно- и нефтедобывающей отраслях промышленности)

«FORSTAR» (основан в 1998 г.)

ВЧ соединители, коаксиальные кабели, кабельные сборки и микроволновые компоненты:

(Применяются в телекоммуникациях гражданского и специального назначения, в средствах связи, РЛС, а так же военной, авиационной и аэрокосмической отраслях промышленности).



Телефон: 8 (812) 309-75-97 (многоканальный)

Факс: 8 (812) 320-03-32

Электронная почта: ocean@oceanchips.ru

Web: <http://oceanchips.ru/>

Адрес: 198099, г. Санкт-Петербург, ул. Калинина, д. 2, корп. 4, лит. А