

# Ultra Compact and Versatile Filtered Power Entry Module



- Dual stage filter
- Ultra compact design
- Rated currents up to 10 A
- Dual fuse holder
- 2-pole rocker switch
- Good attenuation performance
- Faston or spring cage terminals



Check the video of our IEC Inlet Filters FN 9280 and FN 9290 on Youtube!

### Performance indicators

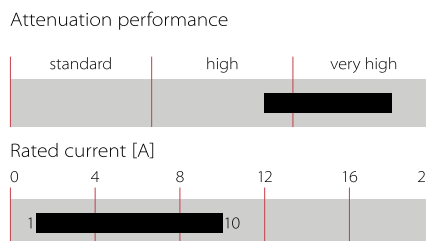

### Approvals



(CQC except HI-types; Patent US 20110227692/US 8766761; CN ZL201080069589.0)

Choosing FN 9280/90 product line brings you the rapid availability of a standard filter associated with the necessary safety acceptances and a high attenuation performance. For higher attenuation performance the FN 9290 family with a dual stage filter and identical panel cut-out can be used.

Standard IEC connector filters are a practical solution to pass EMI system approval in a short time. A wide selection of amperage ratings, mounting possibilities and also filters for medical applications are designed to offer you the best solution.

### Features and benefits

- Best conducted attenuation performance, based on chokes with high saturation resistance and excellent thermal behavior
- Deep-drawn iron-sheet housing for best possible shielding against magnetic fields
- Rear/front flange mounting or snap-in versions
- Dual and additional spare fuse holder
- 2-pole rocker switch
- Faston or spring cage terminals for more flexible assembly
- FN 929X B versions comply with the requirements of 1MOP acc. to IEC/EN 60601-1
- All versions according IEC/EN 62368-1

### Technical specifications

<b>Maximum continuous operating voltage</b>	250 VAC, 50/60 Hz
<b>Rated currents</b>	1 to 10 A @ 40°C max.
<b>Operating frequency</b>	DC to 400 Hz
<b>Leakage current</b>	Standard: <500 uA at 250 VAC/50 Hz Medical: <5 uA at 250 VAC/50 Hz
<b>High potential test voltage</b>	P → PE 2000 VAC for 2 sec (standard types) P → PE 2500 VAC for 2 sec (B types) P → N 760 VAC for 2 sec
<b>Design corresponding to</b>	UL 1283, CSA 22.2 No. 8 1986, EN 60939, EN 60950, EN 60601-1, UL 544, EN 60320
<b>Flammability corresponding to</b>	UL 94 V-2 or better
<b>Temperature range (operation and storage)</b>	-25°C to +85°C (25/85/21)
<b>Protection category</b>	IP 40 according to IEC 60529 (front side)
<b>Terminals</b>	IP 20 spring cage safe against finger touch
<b>Spring cage wire range</b>	0.2 – 1.5 mm <sup>2</sup> /24 – 16 AWG single or flexible wire
<b>MTBF @ 40°C/230 V (Mil-HB-217F)</b>	> 1,000,000 hours
<b>Switch ratings</b>	
<b>Rocker switch</b>	2-pole, dark not illuminated, Marking I - 0
<b>USA (UL) and Canada (C-UL)</b>	10 A, 125 VAC; 10 A, 250 VAC; 1/3 HP
<b>Europe (ENEC)</b>	10 A (4 A), 250 VAC**
<b>Mechanical life</b>	50,000 cycles
<b>Electrical specifications</b>	Inrush current 82 A 6,000 on-off operations according to UL 1054 10,000 on-off operations according to ENEC
<b>Fuse holder</b>	2 fuses (Ø5 x 20 mm) max. 250 V (certified to IEC 60127-6)
<b>Power acceptance @ amb. temperature</b>	

\* 10 A version is 8 A UL and CSA approved

\*\* Value in () relates to the inductive current charge: cos γ = 0.65

### Typical applications

- Portable electrical and electronic equipment
- Consumer goods
- EDP and office equipment
- Single-phase and switch-mode power supplies
- Test and measurement equipment
- Medical electrical devices (MD) and *In-Vitro*-Diagnostics (IVD) equipment
- Audio/Video, information and communication technologies

### Typical electrical schematic

FN 9290 Standard types (B types without Cy)

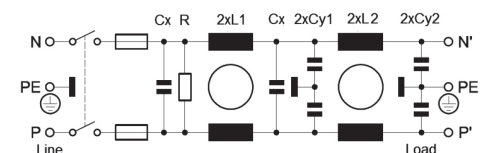

## Filter selection table

Filter*	Rated current @ 40°C	Leakage current** @ 250 VAC /50 Hz (@ 120 VAC /60 Hz)	Inductance		Capacitance			Resistance R	Output connections		Weight [g]
			L1	L2	Cx	Cy1	Cy2		[kOhm]		
	[A]	[mA]	[mH]	[mH]	[nF]	[nF]	[nF]	[kOhm]			
FN 9290-1-..	1	0.28 (0.16)	10.9	10.9	220	1.5	0.47	1000	-06	-100	147
FN 9290-2-..	2	0.28 (0.16)	4.4	4.4	220	1.5	0.47	1000	-06	-100	148
FN 9290-4-..	4	0.28 (0.16)	1.7	1.7	220	1.5	0.47	1000	-06	-100	148
FN 9290-6-..	6	0.28 (0.16)	0.78	0.78	220	1.5	0.47	1000	-06	-100	153
FN 9290-10-..	10	0.28 (0.16)	0.32	0.32	220	1.5	0.47	1000	-06	-100	154
FN 9290 B-1-..	1	0.00	10.9	10.9	220	0	0	1000	-06	-100	147
FN 9290 B-2-..	2	0.00	4.4	4.4	220	0	0	1000	-06	-100	148
FN 9290 B-4-..	4	0.00	1.7	1.7	220	0	0	1000	-06	-100	148
FN 9290 B-6-..	6	0.00	0.78	0.78	220	0	0	1000	-06	-100	153
FN 9290 B-10-..	10	0.00	0.32	0.32	220	0	0	1000	-06	-100	154
FN 9299-1-..	1	0.28 (0.16)	10.9	10.9	220	1.5	0.47	1000	-06	-100	147
FN 9299-2-..	2	0.28 (0.16)	4.4	4.4	220	1.5	0.47	1000	-06	-100	148
FN 9299-4-..	4	0.28 (0.16)	1.7	1.7	220	1.5	0.47	1000	-06	-100	148
FN 9299-6-..	6	0.28 (0.16)	0.78	0.78	220	1.5	0.47	1000	-06	-100	153
FN 9299-10-..	10	0.28 (0.16)	0.32	0.32	220	1.5	0.47	1000	-06	-100	154
FN 9299 B-1-..	1	0.00	10.9	10.9	220	0	0	1000	-06	-100	147
FN 9299 B-2-..	2	0.00	4.4	4.4	220	0	0	1000	-06	-100	148
FN 9299 B-4-..	4	0.00	1.7	1.7	220	0	0	1000	-06	-100	148
FN 9299 B-6-..	6	0.00	0.78	0.78	220	0	0	1000	-06	-100	153
FN 9299 B-10-..	10	0.00	0.32	0.32	220	0	0	1000	-06	-100	154

\* To compile a complete part number, please replace the .. with the required output connection style (e.g. FN 9289-1-06, FN 9282-4-100)

\*\* Maximum leakage current under normal conditions (according to IEC60939-3)

## Product selector:

FN 92www-xx-yy-zz

- Blank: Snap in range 1.0 to 2.5 mm
- Optional: 30: Snap in range >2.5 to 3.5 mm
- 06: Fast-On 6.3 x 0.8 mm (spade/soldering)
- 100: Spring cage
- 1 to 10: Rated current [A]
- Blank: Standard version
- B: Medical version (without Y2-capacitor)
- Optional: B: Medical version (without YZ-capacitor)
- 0: Flange version vertical/horizontal/front/rear mounting set
- 9: Snap-in version, snapper on horizontal side (top / bottom)
- Optional: 1: Rear Flange mounting (top / bottom)
- 2: Front Flange mounting (top / bottom)
- 3: Rear Flange mounting (left / right)
- 4: Front Flange mounting (left / right)
- 8: Snap-in version, snapper on vertical side (left / right)
- 9: Dual stage filter

All FN 9280/FN 9290 are equipped with a dual fuse holder with a spare fuse holder.

**Note: All FN 9280/FN 9280 B/FN 9289/FN 9289 B/FN 9290/FN 9290 B/FN 9299/FN 9299 B are stock types from our distribution partners.**

Order Examples:

FN 9280 B-6-100: Medical version of single stage, dual fuse EMC/EMI filter, flange set for vertical/horizontal/front/rear mounting, 6 A, spring cage terminals, from stock available.

FN 9298-6-06-30: Dual stage, dual fuse EMC/EMI filter, snap-in version, snappers for snap-in panel thickness range >2.5 to 3.5 mm, snapper on vertical side, 6 A, fast-on terminals, non-stock order type

Accessories: The 4D flanges can be ordered separately. The order number is 427532. Please note that the minimum order quantity is one box of 50 pieces. One item includes both type of flanges (vertical and horizontal).

## Typical filter attenuation

**FN 9290 Series | Typical filter attenuation** | Per CISPR 17; A=50  $\Omega$ /50  $\Omega$  sym; B=50  $\Omega$ /50  $\Omega$  asym

1 A types

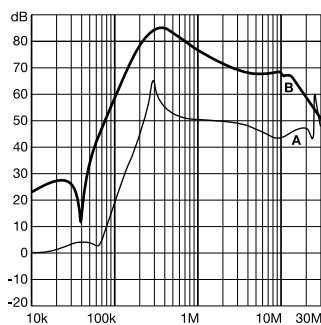

2 A types

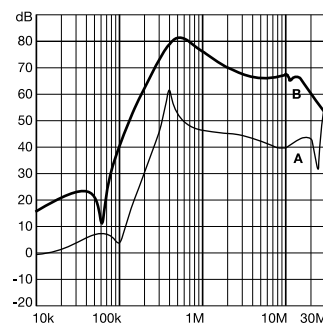

4 – 6 A types

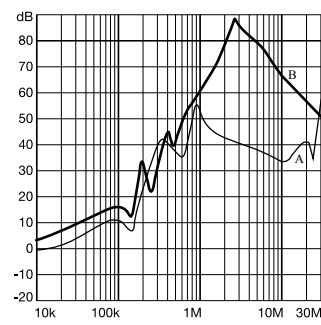

10 A types

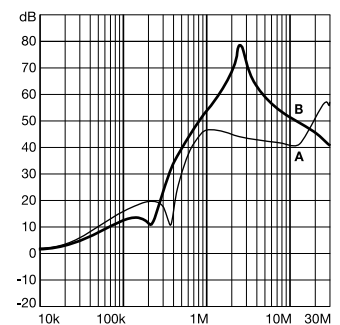

**FN 9290 B Series | Typical filter attenuation** | Per CISPR 17; A=50  $\Omega$ /50  $\Omega$  sym; B=50  $\Omega$ /50  $\Omega$  asym

1 A types

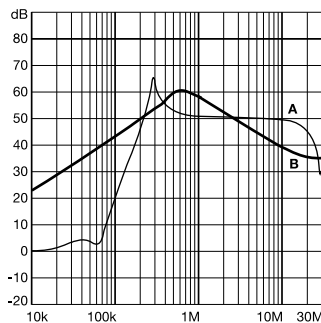

2 A types

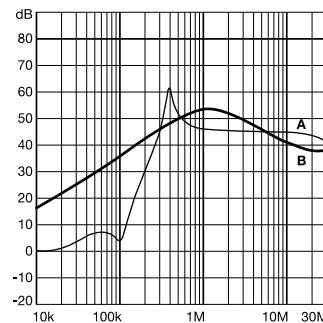

4 – 6 A types

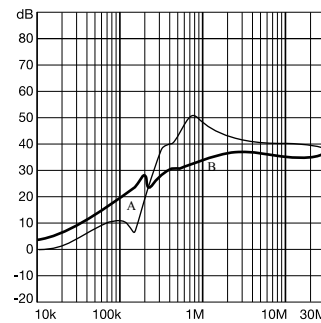

10 A types

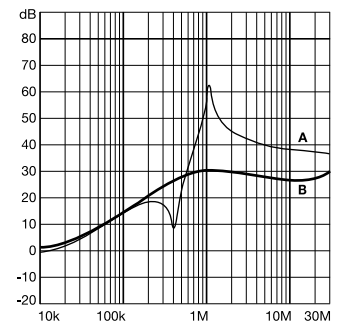

**Mechanical Data**

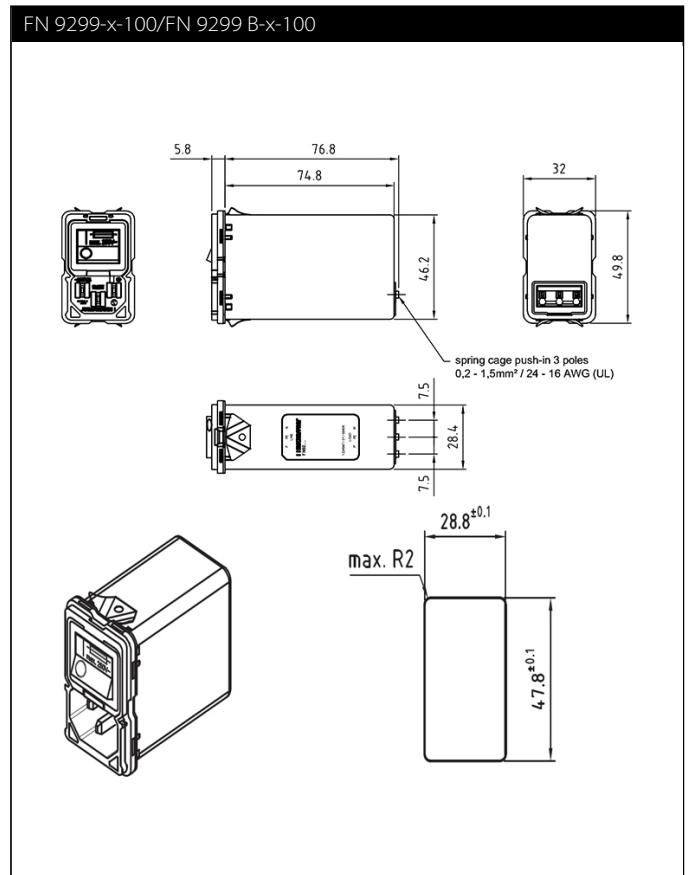
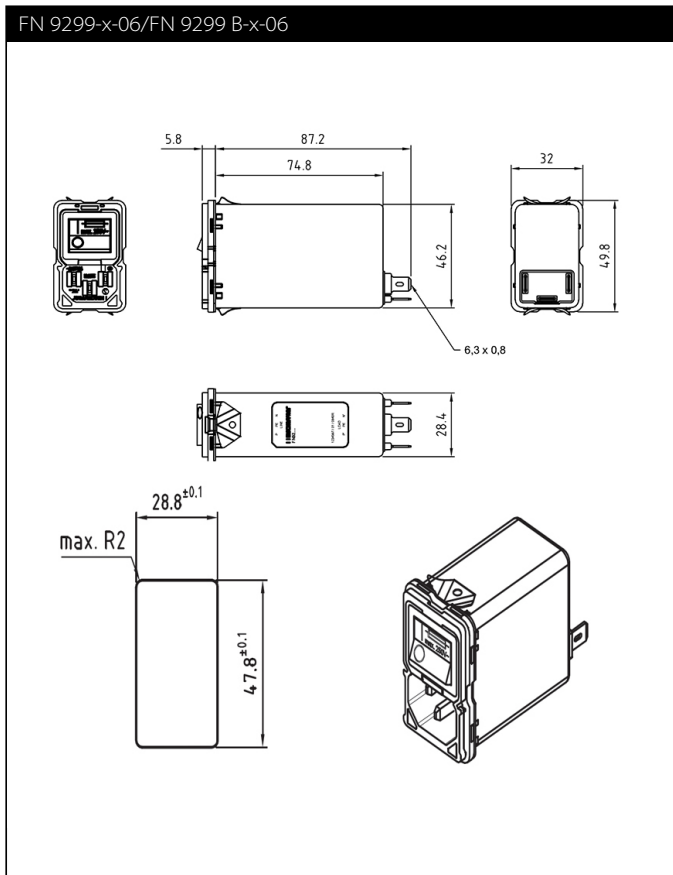
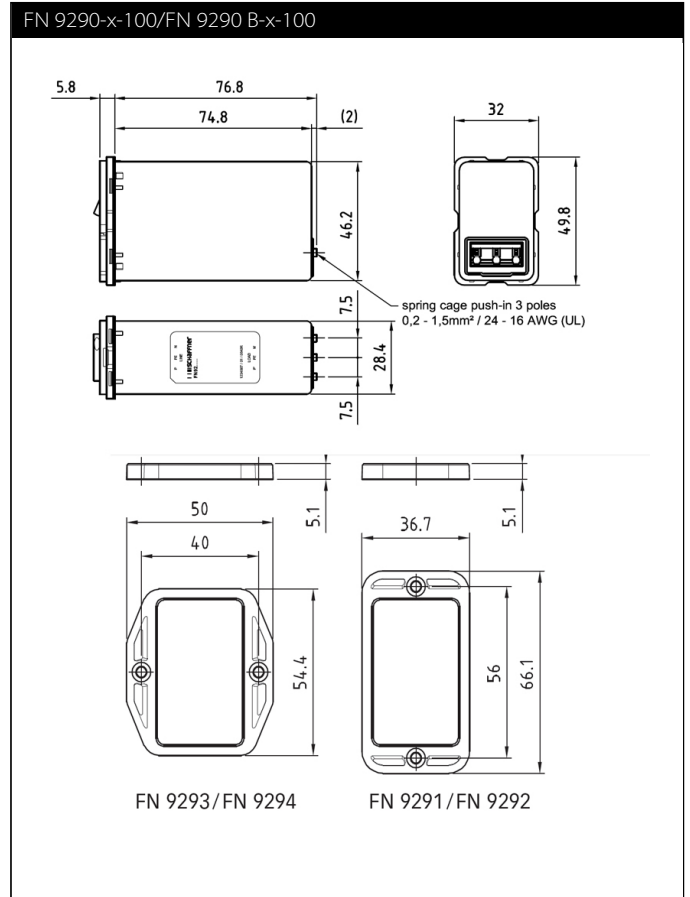
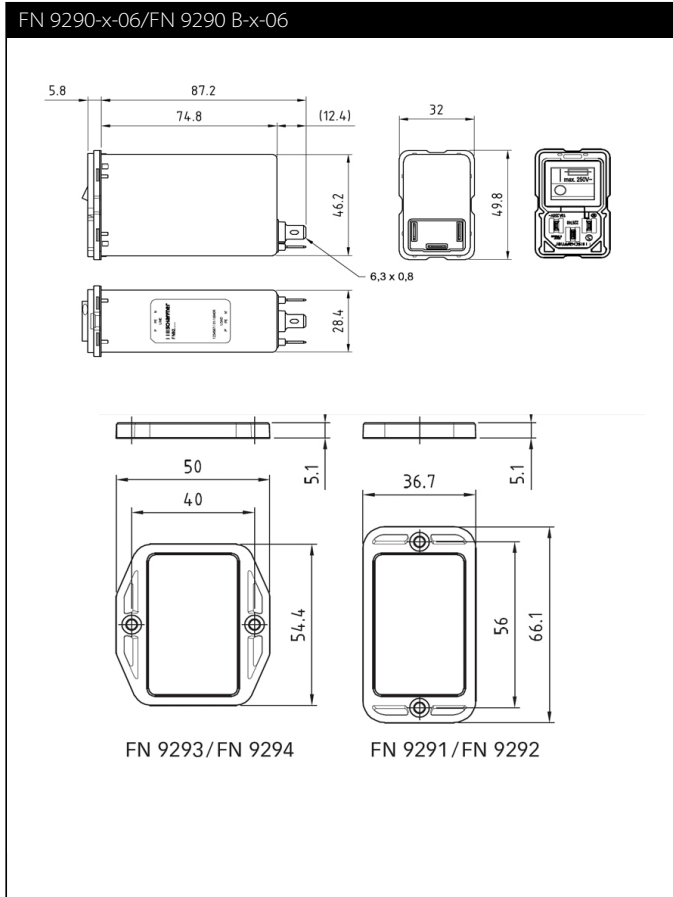

Assembly Instructions

REAR MOUNTING

vertical:

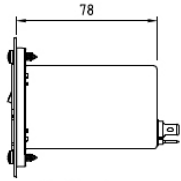

Cutout:

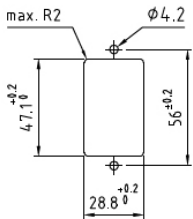

horizontal:

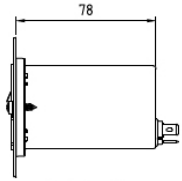

Cutout:

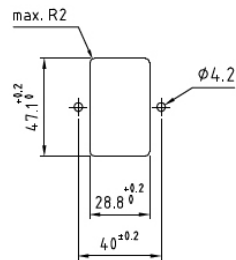

Assembly:

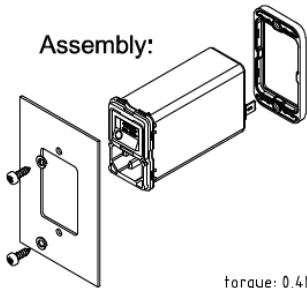

torque: 0,4Nm

Recommended screw:  
Panhead tapping screw d x l 3,9 x 9,5 mm

Assembly:

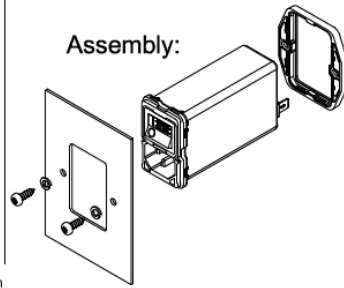

FRONT MOUNTING

vertical:

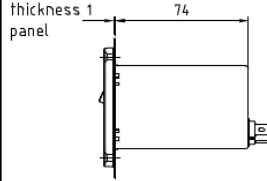

Cutout:

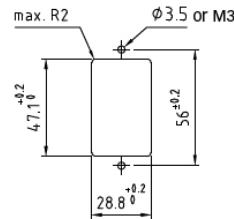

horizontal:

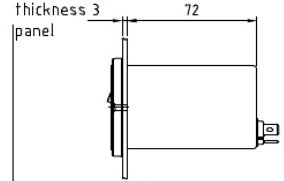

Cutout:

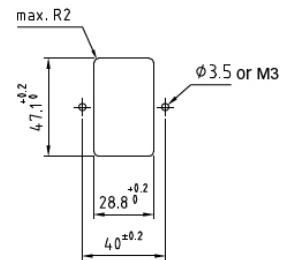

Assembly:

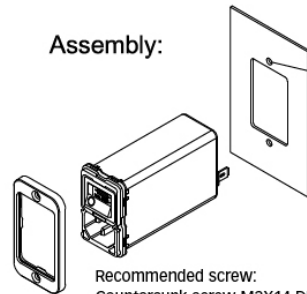

Recommended screw:  
Countersunk screw M3X14 DIN963A

Assembly:

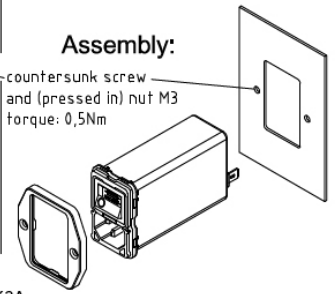

countersunk screw  
and (pressed in) nut M3  
torque: 0,5Nm

Terminal -100

clamping range, solid wire / flex wire

0,20 mm<sup>2</sup> - 1,5 mm<sup>2</sup>, AWG24 - AWG16

operating force of slider

max. 40 N

recommended stripped length

8 mm

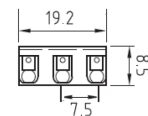

Push the knob above the terminal to insert the wire.

Removal of the combined switch / fuse holder unit

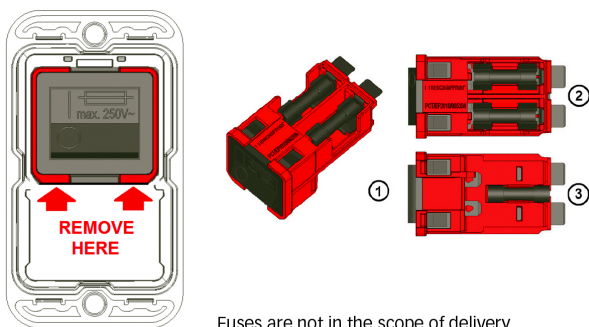

Fuses are not in the scope of delivery.

An additional fuse mark on the switch indicates the fuses holders behind the switch. The red frame shows the outline of the removable unit.

With a simple tool like a Swiss Army knife or a screwdriver No 1 or smaller the unit (1) can be removed from the filter. On the topside (2) behind the switch there are two fuse holders for each live connection. On the bottom side (3) is a clip to carry an additional spare fuse.

## Accessories for IEC Inlet Filters and Power Entry Modules

The accessories displayed are a selection of available accessories for IEC Inlet filters and IEC Power entry modules. As they are displayed in a general way there might be variants of the filters where the accessories are not available.

For further information please ask your local Schaffner Sales Partner and visit our homepage <https://www.schaffner.com/>.

### Power Cord with Locking System for Inlet Filters IL 13, IL 13 P, IL 19



Link to Datasheet: [Datasheet IEC C13/C19 locking cable](#)

The locking system has a tensile force of typical 200N.

It is recommended to use it with flange mount filters.

Lock Power Cords with IEC Inlets and Filters"

Schaffner power cords with IEC lock guard against

accidental disconnection of all electrical appliances

with an IEC inlet. No exchange or modification of the

IEC inlet or IEC inlet filter system is needed. Easy

retrofit for all electronic equipments and devices.

### IEC C13 Rewireable Connector for individual Power Cord with Locking System



Link to Datasheet: [Dataseheet IEC C13 rewireable](#)

The locking system has a tensile force of typical 300N. It is recommended to

use it with flange mount filters. For details refer to our Application Note

"Using IEC Lock Power Cords with IEC

Inlets and Filters" Schaffner power connector with IEC lock guard against

accidental disconnection of all electrical appliances with an IEC inlet.

No exchange or modification of the IEC inlet or IEC inlet filter system is

needed. Easy retrofit for all electronic equipments and devices.



## Headquarters, global innovation and development

### Switzerland

#### Schaffner Group

Industrie Nord  
Nordstrasse 11e  
4542 Luterbach  
T +41 32 681 66 26  
[info@schaffner.com](mailto:info@schaffner.com)



## Sales and application centers

### China

#### Schaffner EMC Ltd. Shanghai

T20-3 C, No 565 Chuangye Road,  
Pudong district  
201201 Shanghai  
T +86 21 3813 9500  
[cschina@schaffner.com](mailto:cschina@schaffner.com)  
[www.schaffner.com.cn](http://www.schaffner.com.cn)

### Finland

#### Schaffner Oy

Sauvonrinne 19 H  
08500 Lohja  
T +358 10 567 2855  
[finlandsales@schaffner.com](mailto:finlandsales@schaffner.com)

### France

#### Schaffner EMC S.A.S.

16-20 Rue Louis Rameau  
95875 Bezons  
T +33 1 34 34 30 60  
F +33 1 39 47 02 28  
[francesales@schaffner.com](mailto:francesales@schaffner.com)

### Germany

#### Schaffner Deutschland GmbH

Schoemperlenstrasse 12B  
76185 Karlsruhe  
T +49 721 56910  
F +49 721 569110  
[germanysales@schaffner.com](mailto:germanysales@schaffner.com)

### India

#### Schaffner India Pvt. Ltd

REGUS WORLD TRADE CENTRE  
WTC, 22nd Floor Unit No 2238, Brigade  
Gateway Campus, 26/1, Dr. Rajkumar Road  
Malleshwaram (W)  
560055 Bangalore  
T +91 80 67935355  
[indiasales@schaffner.com](mailto:indiasales@schaffner.com)

### Italy

#### Schaffner EMC S.r.l.

Via Ticino, 30  
20900 Monza (MB)  
T +39 039 21 41 070  
[italysales@schaffner.com](mailto:italysales@schaffner.com)

### Japan

#### Schaffner EMC K.K.

Taiju-Seimei Sangenjaya Bldg.  
1-32-12, Kamiuma, Setagaya-ku  
154-0011 Tokyo  
T +81 3 5712 3650  
F +81 3 5712 3651  
[japansales@schaffner.com](mailto:japansales@schaffner.com)  
[www.schaffner.jp](http://www.schaffner.jp)

### Singapore

#### Schaffner EMC Pte Ltd.

#05-09, Kg Ubi Ind. Estate  
408705 Singapore  
T +65 6377 3283  
F +65 6377 3281  
[singaporesales@schaffner.com](mailto:singaporesales@schaffner.com)

### Spain

#### Schaffner EMC España

Calle Caléndula 93, Miniparc III, Edificio E  
El Soto de Moraleja, Alcobendas  
28109 Madrid  
T +34 917 912 900  
F +34 917 912 901  
[spainsales@schaffner.com](mailto:spainsales@schaffner.com)

### Sweden

#### Schaffner EMC AB

Östermalmstorg 1  
114 42 Stockholm  
T +46 8 5050 2425  
[swedensales@schaffner.com](mailto:swedensales@schaffner.com)  
[www.schaffner.com](http://www.schaffner.com)

### Switzerland

#### Schaffner EMV AG

Industrie Nord  
Nordstrasse 11e  
4542 Luterbach  
T +41 32 681 66 26  
[switzerlandsales@schaffner.com](mailto:switzerlandsales@schaffner.com)

### Taiwan R.O.C.

#### Schaffner EMV Ltd.

20 Floor-2, No 97, Section 1, XinTai 5th Road  
22175 XiZhi District New Taipei City 22175  
T +886 2 2697 5500  
F +886 2 2697 5533  
[taiwansales@schaffner.com](mailto:taiwansales@schaffner.com)  
[www.schaffner.com.tw](http://www.schaffner.com.tw)

### Thailand

#### Schaffner EMC Co. Ltd.

Northern Region Industrial Estate  
67 Moo 4 Tambon Ban Klang  
Amphur Muangng P.O. Box 14  
51000 Lamphun  
T +66 53 58 11 04  
F +66 53 58 10 19  
[thailandsales@schaffner.com](mailto:thailandsales@schaffner.com)

### United Kingdom

#### Schaffner Ltd.

1, Oakmede Place  
Binfield  
RG42 4JF Berkshire  
T +44 118 9770070  
F +44 118 9792969  
[uksales@schaffner.com](mailto:uksales@schaffner.com)

### USA

#### Schaffner EMC Inc.

52 Mayfield Avenue  
Edison, New Jersey  
T +1 732 225 9533  
F +1 732 225 4789  
[usasales@schaffner.com](mailto:usasales@schaffner.com)  
[www.schaffnerusa.com](http://www.schaffnerusa.com)

#### Schaffner North America

6722 Thirlane Road  
24019 Roanoke, Virginia  
T +1 276 228 7943  
F +1 276 228 7953

#### Schaffner North America

823 Fairview Road  
24382 Wytheville, Virginia  
T +1 276 228 7943  
F +1 276 228 7258

To find your local partner within Schaffner's global network: [www.schaffner.com](http://www.schaffner.com)

© 2018 Schaffner Group

The content of this document has been carefully checked and understood. However, neither Schaffner nor its subsidiaries assume any liability whatsoever for any errors or inaccuracies of this document and the consequences thereof. Published specifications are subject to change without notice. Product suitability for any area of application must ultimately be determined by the customer. In all cases, products must never be operated outside their published specifications. Schaffner does not guarantee the availability of all published products. This disclaimer shall be governed by substantive Swiss law and resulting disputes shall be settled by the courts at the place of business of Schaffner Holding AG. Latest publications and a complete disclaimer can be downloaded from the Schaffner website. All trademarks recognized.



Компания «Океан Электроники» предлагает заключение долгосрочных отношений при поставках импортных электронных компонентов на взаимовыгодных условиях!

Наши преимущества:

- Поставка оригинальных импортных электронных компонентов напрямую с производств Америки, Европы и Азии, а так же с крупнейших складов мира;
- Широкая линейка поставок активных и пассивных импортных электронных компонентов (более 30 млн. наименований);
- Поставка сложных, дефицитных, либо снятых с производства позиций;
- Оперативные сроки поставки под заказ (от 5 рабочих дней);
- Экспресс доставка в любую точку России;
- Помощь Конструкторского Отдела и консультации квалифицированных инженеров;
- Техническая поддержка проекта, помощь в подборе аналогов, поставка прототипов;
- Поставка электронных компонентов под контролем ВП;
- Система менеджмента качества сертифицирована по Международному стандарту ISO 9001;
- При необходимости вся продукция военного и аэрокосмического назначения проходит испытания и сертификацию в лаборатории (по согласованию с заказчиком);
- Поставка специализированных компонентов военного и аэрокосмического уровня качества (Xilinx, Altera, Analog Devices, Intersil, Interpoint, Microsemi, Actel, Aeroflex, Peregrine, VPT, Syfer, Eurofarad, Texas Instruments, MS Kennedy, Miteq, Cobham, E2V, MA-COM, Hittite, Mini-Circuits, General Dynamics и др.);

Компания «Океан Электроники» является официальным дистрибьютором и эксклюзивным представителем в России одного из крупнейших производителей разъемов военного и аэрокосмического назначения «JONHON», а так же официальным дистрибьютором и эксклюзивным представителем в России производителя высокотехнологичных и надежных решений для передачи СВЧ сигналов «FORSTAR».



## JONHON

«JONHON» (основан в 1970 г.)

Разъемы специального, военного и аэрокосмического назначения:

(Применяются в военной, авиационной, аэрокосмической, морской, железнодорожной, горно- и нефтедобывающей отраслях промышленности)

«FORSTAR» (основан в 1998 г.)

ВЧ соединители, коаксиальные кабели,  
кабельные сборки и микроволновые компоненты:

(Применяются в телекоммуникациях гражданского и специального назначения, в средствах связи, РЛС, а так же военной, авиационной и аэрокосмической отраслях промышленности).



Телефон: 8 (812) 309-75-97 (многоканальный)

Факс: 8 (812) 320-03-32

Электронная почта: [ocean@oceanchips.ru](mailto:ocean@oceanchips.ru)

Web: <http://oceanchips.ru/>

Адрес: 198099, г. Санкт-Петербург, ул. Калинина, д. 2, корп. 4, лит. А