

TIP31, TIP31A, TIP31B, TIP31C, (NPN), TIP32, TIP32A, TIP32B, TIP32C, (PNP)



ON Semiconductor®

<http://onsemi.com>

Complementary Silicon Plastic Power Transistors

Designed for use in general purpose amplifier and switching applications.

Features

- Collector–Emitter Saturation Voltage –
 $V_{CE(sat)} = 1.2 \text{ Vdc (Max) @ } I_C = 3.0 \text{ Adc}$
- Collector–Emitter Sustaining Voltage –
 $V_{CEO(sus)} = 40 \text{ Vdc (Min) – TIP31, TIP32}$
 $= 60 \text{ Vdc (Min) – TIP31A, TIP32A}$
 $= 80 \text{ Vdc (Min) – TIP31B, TIP32B}$
 $= 100 \text{ Vdc (Min) – TIP31C, TIP32C}$
- High Current Gain – Bandwidth Product
 $f_T = 3.0 \text{ MHz (Min) @ } I_C = 500 \text{ mAdc}$
- Compact TO–220 AB Package
- Pb–Free Packages are Available*

MAXIMUM RATINGS

| Rating | Symbol | Value | Unit |
|---|----------------|-----------------------|--------------------------|
| Collector – Emitter Voltage TIP31, TIP32 TIP31A, TIP32A TIP31B, TIP32B TIP31C, TIP32C | V_{CEO} | 40 60 80 100 | Vdc |
| Collector–Base Voltage TIP31, TIP32 TIP31A, TIP32A TIP31B, TIP32B TIP31C, TIP32C | V_{CB} | 40 60 80 100 | Vdc |
| Emitter–Base Voltage | V_{EB} | 5.0 | Vdc |
| Collector Current Continuous Peak | I_C | 3.0 5.0 | Adc |
| Base Current | I_B | 1.0 | Adc |
| Total Power Dissipation @ $T_C = 25^\circ\text{C}$ Derate above 25°C | P_D | 40 0.32 | W W/ $^\circ\text{C}$ |
| Total Power Dissipation @ $T_A = 25^\circ\text{C}$ Derate above 25°C | P_D | 2.0 0.016 | W W/ $^\circ\text{C}$ |
| Unclamped Inductive Load Energy (Note 1) | E | 32 | mJ |
| Operating and Storage Junction Temperature Range | T_J, T_{stg} | –65 to +150 | $^\circ\text{C}$ |

Stresses exceeding Maximum Ratings may damage the device. Maximum Ratings are stress ratings only. Functional operation above the Recommended Operating Conditions is not implied. Extended exposure to stresses above the Recommended Operating Conditions may affect device reliability.

1. $I_C = 1.8 \text{ A}$, $L = 20 \text{ mH}$, $P.R.F. = 10 \text{ Hz}$, $V_{CC} = 10 \text{ V}$, $R_{BE} = 100 \Omega$

*For additional information on our Pb–Free strategy and soldering details, please download the ON Semiconductor Soldering and Mounting Techniques Reference Manual, SOLDERRM/D.

3 AMPERE POWER TRANSISTORS COMPLEMENTARY SILICON 40–60–80–100 VOLTS, 40 WATTS

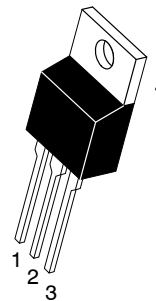

TO–220AB
CASE 221A
STYLE 1

PIN 1. BASE
2. COLLECTOR
3. EMITTER
4. COLLECTOR

MARKING DIAGRAM



TIP3xx = Device Code
xx = 1, 1A, 1B, 1C,
2, 2A, 2B, 2C,
A = Assembly Location
Y = Year
WW = Work Week
G = Pb–Free Package

ORDERING INFORMATION

See detailed ordering and shipping information in the package dimensions section on page 3 of this data sheet.

TIP31, TIP31A, TIP31B, TIP31C, (NPN), TIP32, TIP32A, TIP32B, TIP32C, (PNP)

THERMAL CHARACTERISTICS

| Characteristic | Symbol | Max | Unit |
|---|-----------------|-------|------|
| Thermal Resistance, Junction-to-Ambient | $R_{\theta JA}$ | 62.5 | °C/W |
| Thermal Resistance, Junction-to-Case | $R_{\theta JC}$ | 3.125 | °C/W |

ELECTRICAL CHARACTERISTICS ($T_C = 25^\circ\text{C}$ unless otherwise noted)

| Characteristic | Symbol | Min | Max | Unit |
|----------------|--------|-----|-----|------|
|----------------|--------|-----|-----|------|

OFF CHARACTERISTICS

| | | | | | |
|---|--|---------------|-----------------------|--------------------------|-----------------|
| Collector-Emitter Sustaining Voltage (Note 2) ($I_C = 30 \text{ mAdc}$, $I_B = 0$) | TIP31, TIP32 TIP31A, TIP32A TIP31B, TIP32B TIP31C, TIP32C | $V_{CE(sus)}$ | 40 60 80 100 | - - - - | Vdc |
| Collector Cutoff Current ($V_{CE} = 30 \text{ Vdc}$, $I_B = 0$) ($V_{CE} = 60 \text{ Vdc}$, $I_B = 0$) | TIP31, TIP32, TIP31A, TIP32A TIP31B, TIP31C, TIP32B, TIP32C | I_{CEO} | - - | 0.3 0.3 | mAdc |
| Collector Cutoff Current ($V_{CE} = 40 \text{ Vdc}$, $V_{EB} = 0$) ($V_{CE} = 60 \text{ Vdc}$, $V_{EB} = 0$) ($V_{CE} = 80 \text{ Vdc}$, $V_{EB} = 0$) ($V_{CE} = 100 \text{ Vdc}$, $V_{EB} = 0$) | TIP31, TIP32 TIP31A, TIP32A TIP31B, TIP32B TIP31C, TIP32C | I_{CES} | - - - - | 200 200 200 200 | μAdc |
| Emitter Cutoff Current ($V_{BE} = 5.0 \text{ Vdc}$, $I_C = 0$) | | I_{EBO} | - | 1.0 | mAdc |

ON CHARACTERISTICS (Note 2)

| | | | | | |
|--|--|---------------|----------|---------|-----|
| DC Current Gain ($I_C = 1.0 \text{ Adc}$, $V_{CE} = 4.0 \text{ Vdc}$) ($I_C = 3.0 \text{ Adc}$, $V_{CE} = 4.0 \text{ Vdc}$) | | h_{FE} | 25 10 | - 50 | - |
| Collector-Emitter Saturation Voltage ($I_C = 3.0 \text{ Adc}$, $I_B = 375 \text{ mAdc}$) | | $V_{CE(sat)}$ | - | 1.2 | Vdc |
| Base-Emitter On Voltage ($I_C = 3.0 \text{ Adc}$, $V_{CE} = 4.0 \text{ Vdc}$) | | $V_{BE(on)}$ | - | 1.8 | Vdc |

DYNAMIC CHARACTERISTICS

| | | | | | |
|--|--|----------|-----|---|-----|
| Current-Gain – Bandwidth Product ($I_C = 500 \text{ mAdc}$, $V_{CE} = 10 \text{ Vdc}$, $f_{test} = 1.0 \text{ MHz}$) | | f_T | 3.0 | - | MHz |
| Small-Signal Current Gain ($I_C = 0.5 \text{ Adc}$, $V_{CE} = 10 \text{ Vdc}$, $f = 1.0 \text{ kHz}$) | | h_{fe} | 20 | - | - |

2. Pulse Test: Pulse Width $\leq 300 \mu\text{s}$, Duty Cycle $\leq 2.0\%$.

TIP31, TIP31A, TIP31B, TIP31C, (NPN), TIP32, TIP32A, TIP32B, TIP32C, (PNP)

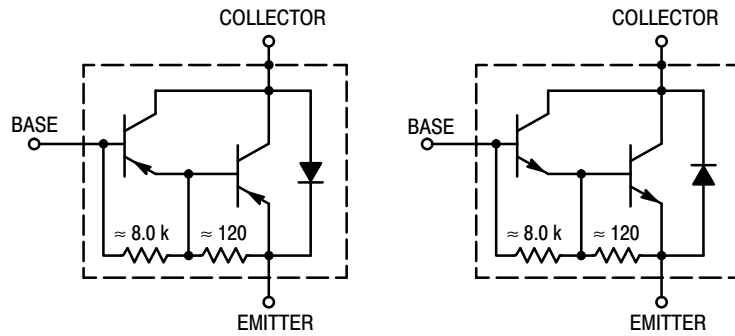

Figure 1. Darlington Circuit Schematic

ORDERING INFORMATION

| Device | Package | Shipping |
|---------|---------------------|-----------------|
| TIP31 | TO-220 | 50 Units / Rail |
| TIP31G | TO-220 (Pb-Free) | 50 Units / Rail |
| TIP31A | TO-220 | 50 Units / Rail |
| TIP31AG | TO-220 (Pb-Free) | 50 Units / Rail |
| TIP31B | TO-220 | 50 Units / Rail |
| TIP31BG | TO-220 (Pb-Free) | 50 Units / Rail |
| TIP31C | TO-220 | 50 Units / Rail |
| TIP31CG | TO-220 (Pb-Free) | 50 Units / Rail |
| TIP32 | TO-220 | 50 Units / Rail |
| TIP32G | TO-220 (Pb-Free) | 50 Units / Rail |
| TIP32A | TO-220 | 50 Units / Rail |
| TIP32AG | TO-220 (Pb-Free) | 50 Units / Rail |
| TIP32B | TO-220 | 50 Units / Rail |
| TIP32BG | TO-220 (Pb-Free) | 50 Units / Rail |
| TIP32C | TO-220 | 50 Units / Rail |
| TIP32CG | TO-220 (Pb-Free) | 50 Units / Rail |

TIP31, TIP31A, TIP31B, TIP31C, (NPN), TIP32, TIP32A, TIP32B, TIP32C, (PNP)

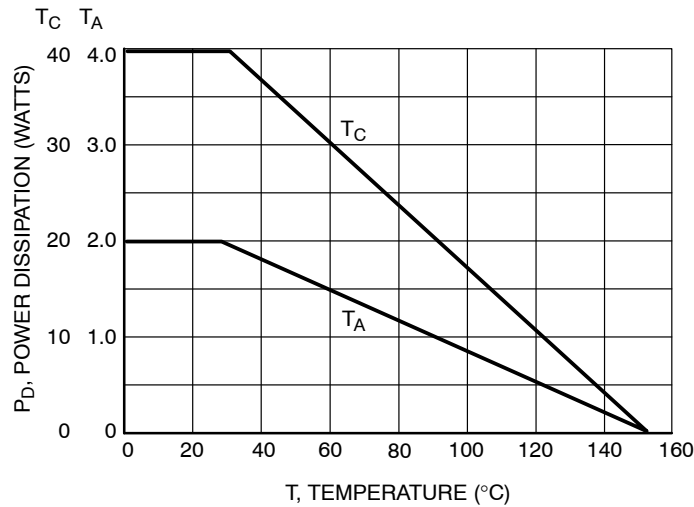
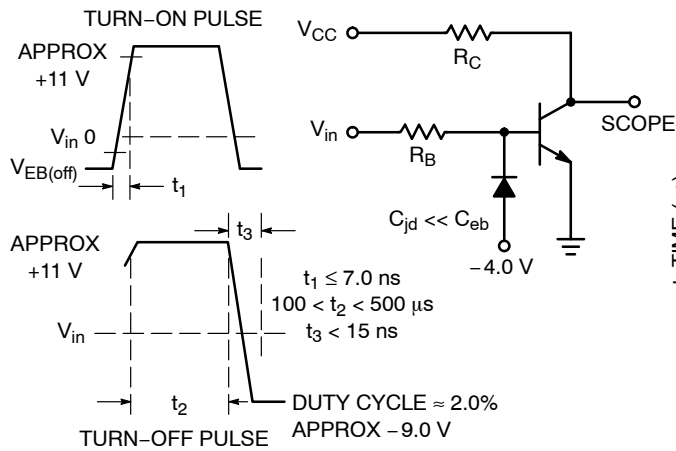

Figure 2. Power Derating



R_B and R_C VARIED TO OBTAIN DESIRED CURRENT LEVELS.

Figure 3. Switching Time Equivalent Circuit

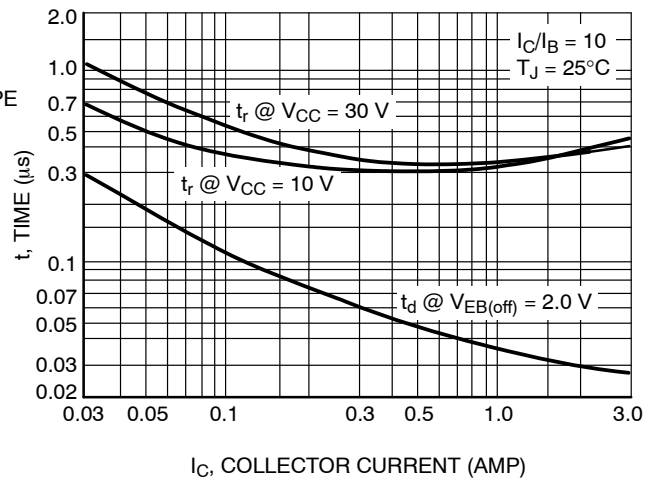

Figure 4. Turn-On Time

TIP31, TIP31A, TIP31B, TIP31C, (NPN), TIP32, TIP32A, TIP32B, TIP32C, (PNP)

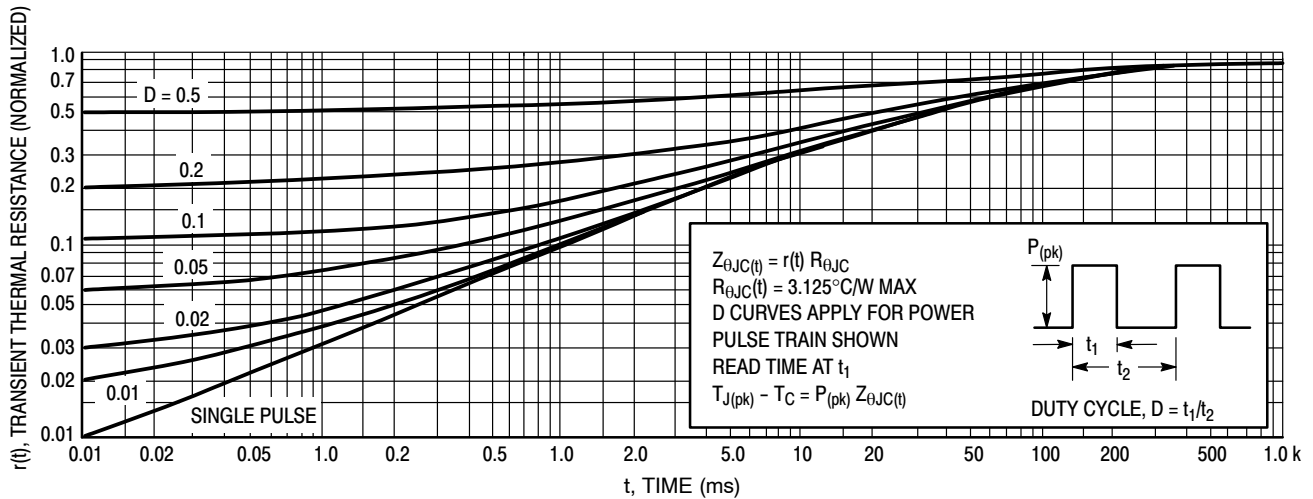

Figure 5. Thermal Response

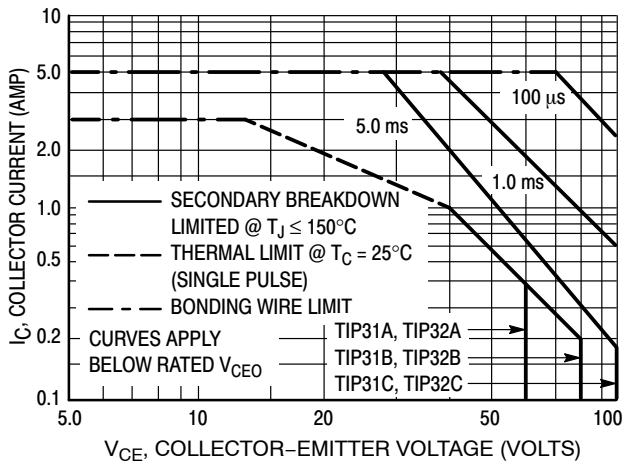

Figure 6. Active Region Safe Operating Area

There are two limitations on the power handling ability of a transistor: average junction temperature and second breakdown. Safe operating area curves indicate $I_C - V_{CE}$ limits of the transistor that must be observed for reliable operation; i.e., the transistor must not be subjected to greater dissipation than the curves indicate.

The data of Figure 6 is based on $T_{J(pk)} = 150^\circ\text{C}$; T_C is variable depending on conditions. Second breakdown pulse limits are valid for duty cycles to 10% provided $T_{J(pk)} \leq 150^\circ\text{C}$. $T_{J(pk)}$ may be calculated from the data in Figure 5. At high case temperatures, thermal limitations will reduce the power that can be handled to values less than the limitations imposed by second breakdown.

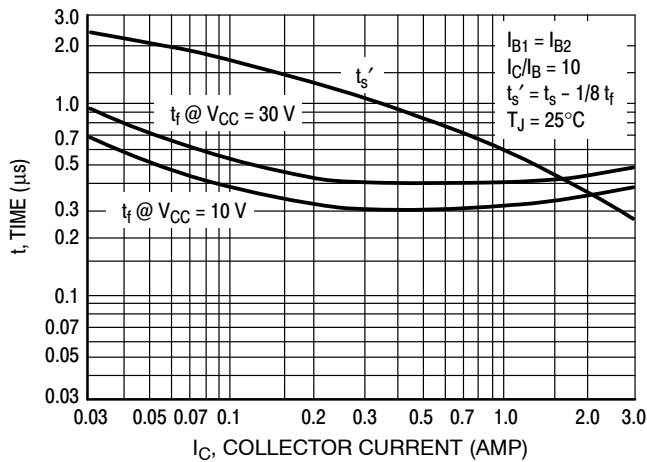

Figure 7. Turn-Off Time

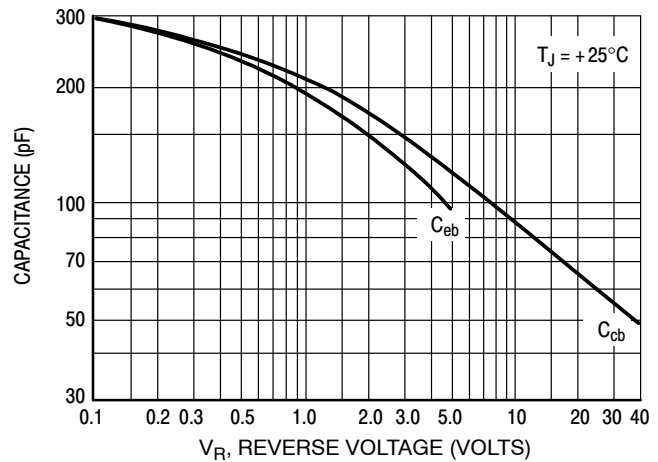

Figure 8. Capacitance

TIP31, TIP31A, TIP31B, TIP31C, (NPN), TIP32, TIP32A, TIP32B, TIP32C, (PNP)

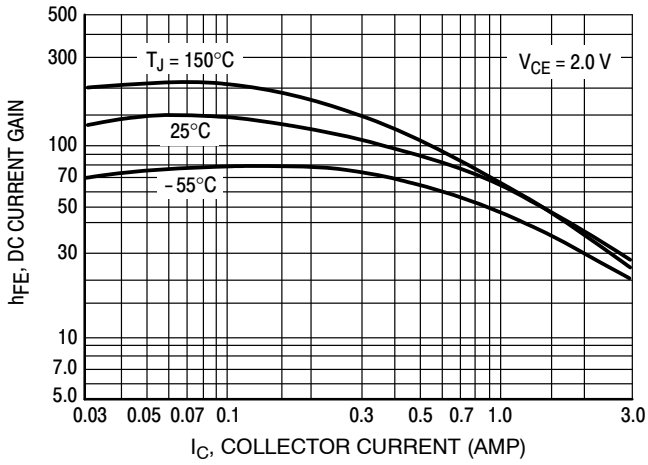

Figure 9. DC Current Gain

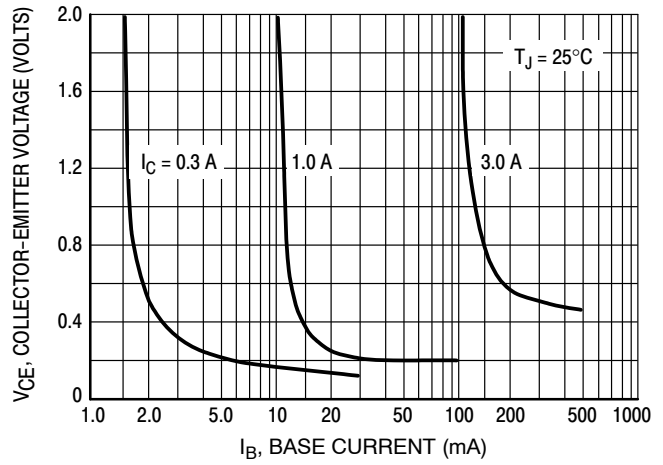

Figure 10. Collector Saturation Region

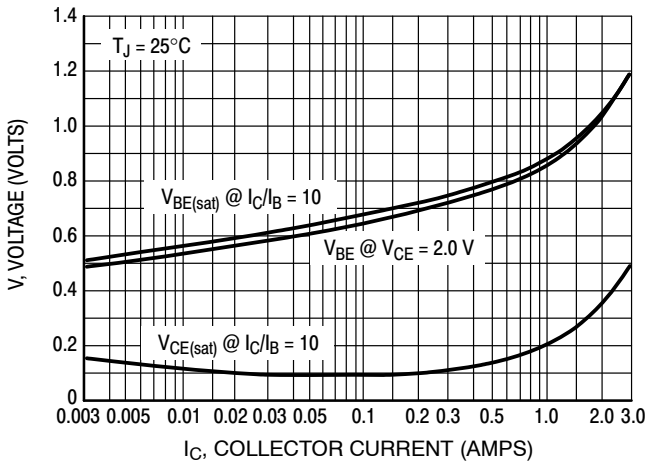

Figure 11. "On" Voltages

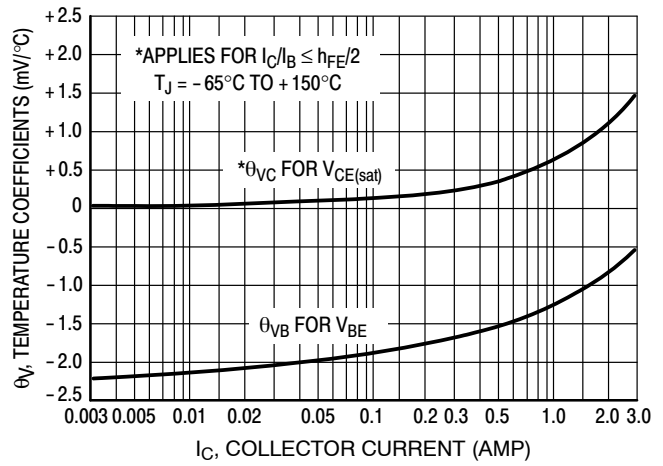

Figure 12. Temperature Coefficients

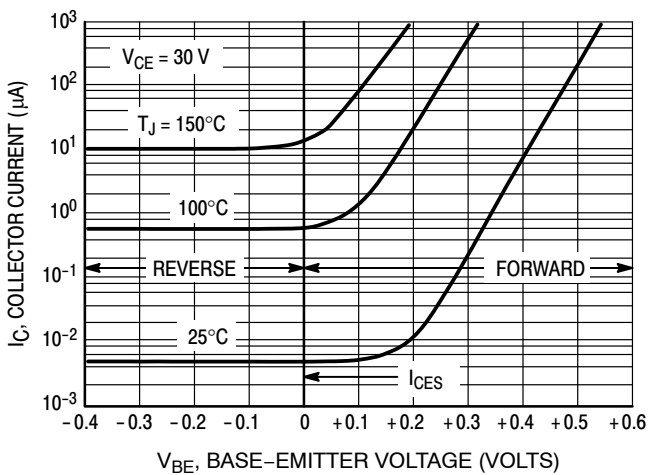

Figure 13. Collector Cut-Off Region

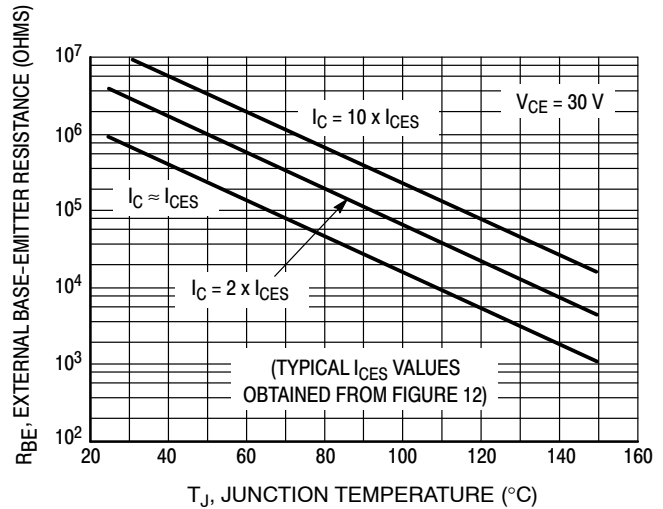
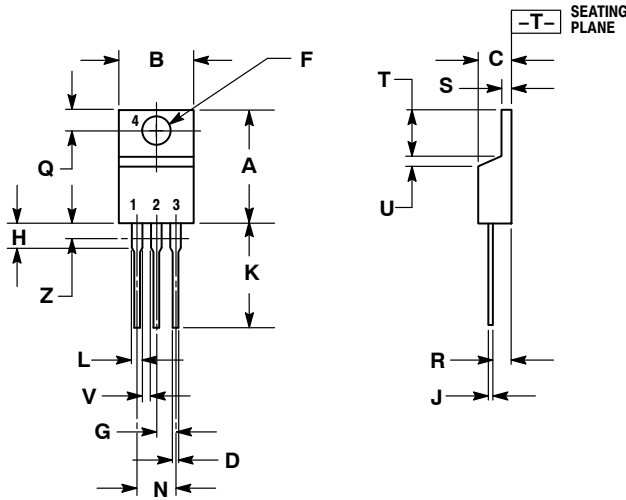

Figure 14. Effects of Base-Emitter Resistance

TIP31, TIP31A, TIP31B, TIP31C, (NPN), TIP32, TIP32A, TIP32B, TIP32C, (PNP)

PACKAGE DIMENSIONS

TO-220 CASE 221A-09 ISSUE AG



NOTES:

1. DIMENSIONING AND TOLERANCING PER ANSI Y14.5M, 1982.
2. CONTROLLING DIMENSION: INCH.
3. DIMENSION Z DEFINES A ZONE WHERE ALL BODY AND LEAD IRREGULARITIES ARE ALLOWED.

| DIM | INCHES | | MILLIMETERS | |
|-----|--------|-------|-------------|-------|
| | MIN | MAX | MIN | MAX |
| A | 0.570 | 0.620 | 14.48 | 15.75 |
| B | 0.380 | 0.405 | 9.66 | 10.28 |
| C | 0.160 | 0.190 | 4.07 | 4.82 |
| D | 0.025 | 0.036 | 0.64 | 0.91 |
| F | 0.142 | 0.161 | 3.61 | 4.09 |
| G | 0.095 | 0.105 | 2.42 | 2.66 |
| H | 0.110 | 0.161 | 2.80 | 4.10 |
| J | 0.014 | 0.025 | 0.36 | 0.64 |
| K | 0.500 | 0.562 | 12.70 | 14.27 |
| L | 0.045 | 0.060 | 1.15 | 1.52 |
| N | 0.190 | 0.210 | 4.83 | 5.33 |
| Q | 0.100 | 0.120 | 2.54 | 3.04 |
| R | 0.080 | 0.110 | 2.04 | 2.79 |
| S | 0.045 | 0.055 | 1.15 | 1.39 |
| T | 0.235 | 0.255 | 5.97 | 6.47 |
| U | 0.000 | 0.050 | 0.00 | 1.27 |
| V | 0.045 | --- | 1.15 | --- |
| Z | --- | 0.080 | --- | 2.04 |

STYLE 1:

- PIN 1. BASE
- COLLECTOR
- EMITTER
- COLLECTOR

ON Semiconductor and are registered trademarks of Semiconductor Components Industries, LLC (SCILLC). SCILLC reserves the right to make changes without further notice to any products herein. SCILLC makes no warranty, representation or guarantee regarding the suitability of its products for any particular purpose, nor does SCILLC assume any liability arising out of the application or use of any product or circuit, and specifically disclaims any and all liability, including without limitation special, consequential or incidental damages. "Typical" parameters which may be provided in SCILLC data sheets and/or specifications can and do vary in different applications and actual performance may vary over time. All operating parameters, including "Typicals" must be validated for each customer application by customer's technical experts. SCILLC does not convey any license under its patent rights nor the rights of others. SCILLC products are not designed, intended, or authorized for use as components in systems intended for surgical implant into the body, or other applications intended to support or sustain life, or for any other application in which the failure of the SCILLC product could create a situation where personal injury or death may occur. Should Buyer purchase or use SCILLC products for any such unintended or unauthorized application, Buyer shall indemnify and hold SCILLC and its officers, employees, subsidiaries, affiliates, and distributors harmless against all claims, costs, damages, and expenses, and reasonable attorney fees arising out of, directly or indirectly, any claim of personal injury or death associated with such unintended or unauthorized use, even if such claim alleges that SCILLC was negligent regarding the design or manufacture of the part. SCILLC is an Equal Opportunity/Affirmative Action Employer. This literature is subject to all applicable copyright laws and is not for resale in any manner.

PUBLICATION ORDERING INFORMATION

LITERATURE FULFILLMENT:

Literature Distribution Center for ON Semiconductor
P.O. Box 5163, Denver, Colorado 80217 USA
Phone: 303-675-2175 or 800-344-3860 Toll Free USA/Canada
Fax: 303-675-2176 or 800-344-3867 Toll Free USA/Canada
Email: orderlit@onsemi.com

N. American Technical Support: 800-282-9855 Toll Free USA/Canada
Europe, Middle East and Africa Technical Support:
Phone: 421 33 790 2910
Japan Customer Focus Center
Phone: 81-3-5773-3850

ON Semiconductor Website: www.onsemi.com

Order Literature: <http://www.onsemi.com/orderlit>

For additional information, please contact your local Sales Representative

Компания «Океан Электроники» предлагает заключение долгосрочных отношений при поставках импортных электронных компонентов на взаимовыгодных условиях!

Наши преимущества:

- Поставка оригинальных импортных электронных компонентов напрямую с производств Америки, Европы и Азии, а так же с крупнейших складов мира;
- Широкая линейка поставок активных и пассивных импортных электронных компонентов (более 30 млн. наименований);
- Поставка сложных, дефицитных, либо снятых с производства позиций;
- Оперативные сроки поставки под заказ (от 5 рабочих дней);
- Экспресс доставка в любую точку России;
- Помощь Конструкторского Отдела и консультации квалифицированных инженеров;
- Техническая поддержка проекта, помощь в подборе аналогов, поставка прототипов;
- Поставка электронных компонентов под контролем ВП;
- Система менеджмента качества сертифицирована по Международному стандарту ISO 9001;
- При необходимости вся продукция военного и аэрокосмического назначения проходит испытания и сертификацию в лаборатории (по согласованию с заказчиком);
- Поставка специализированных компонентов военного и аэрокосмического уровня качества (Xilinx, Altera, Analog Devices, Intersil, Interpoint, Microsemi, Actel, Aeroflex, Peregrine, VPT, Syfer, Eurofarad, Texas Instruments, MS Kennedy, Miteq, Cobham, E2V, MA-COM, Hittite, Mini-Circuits, General Dynamics и др.);

Компания «Океан Электроники» является официальным дистрибьютором и эксклюзивным представителем в России одного из крупнейших производителей разъемов военного и аэрокосмического назначения «JONHON», а так же официальным дистрибьютором и эксклюзивным представителем в России производителя высокотехнологичных и надежных решений для передачи СВЧ сигналов «FORSTAR».



JONHON

«JONHON» (основан в 1970 г.)

Разъемы специального, военного и аэрокосмического назначения:

(Применяются в военной, авиационной, аэрокосмической, морской, железнодорожной, горно- и нефтедобывающей отраслях промышленности)

«FORSTAR» (основан в 1998 г.)

ВЧ соединители, коаксиальные кабели,
кабельные сборки и микроволновые компоненты:

(Применяются в телекоммуникациях гражданского и специального назначения, в средствах связи, РЛС, а так же военной, авиационной и аэрокосмической отраслях промышленности).



Телефон: 8 (812) 309-75-97 (многоканальный)

Факс: 8 (812) 320-03-32

Электронная почта: ocean@oceanchips.ru

Web: <http://oceanchips.ru/>

Адрес: 198099, г. Санкт-Петербург, ул. Калинина, д. 2, корп. 4, лит. А