

SinglFuse™ SF-2410SPxxxW Series Features

- Single blow fuse for overcurrent protection
- 6125 (EIA 2410) footprint
- Time lag fuse
- UL 248-14 listed
- RoHS compliant* and halogen free**
- Wire core SMD design
- Surface mount packaging for automated assembly
- High AC power one-time protection fuse

SF-2410SPxxxW Series - Time Lag Wire Core Surface Mount Fuses

Electrical Characteristics

| Model | Rated Current (Amps) | Fusing Time | Resistance (Ω) Typ.*** | Rated Voltage | Interrupting Rating | Voltage Drop Max. (mV) | Typical I ² t (A ² s)**** |
|-----------------|----------------------|---|------------------------|---------------|---------------------------------|------------------------|---|
| SF-2410SP050W-2 | 0.50 | Open within 120 sec. at 200 % rated current | 0.206 | AC 250 V | AC 250 V 100 A DC 125 V 50 A | 166 | 0.11 |
| SF-2410SP063W-2 | 0.63 | | 0.148 | | | 144 | 0.20 |
| SF-2410SP080W-2 | 0.80 | | 0.109 | | | 139 | 0.35 |
| SF-2410SP100W-2 | 1.00 | | 0.084 | | | 129 | 0.62 |
| SF-2410SP125W-2 | 1.25 | | 0.065 | | | 128 | 1.00 |
| SF-2410SP160W-2 | 1.60 | | 0.049 | | | 127 | 1.80 |
| SF-2410SP200W-2 | 2.00 | | 0.038 | | | 123 | 3.00 |

*** Resistance value measured with ≤10 % rated current at 25 °C ambient.

**** Melting I²t calculated at 0.001 second pre-arcing time.

Reliability Testing

| No. | Test | Requirement | Test Condition | Test Reference |
|-----|---------------------------|---|--|------------------------|
| 1 | Reflow and bend | DCR change ≤ 20 % (≤ 10 % for ≤1 A) No mechanical damage | 3 reflows at 245 °C followed by a 2 mm bend | Refer to STP document |
| 2 | Solderability | Minimum 90 % coverage | One dip at 245 °C for 5 seconds | MIL-STD-202 Method 208 |
| 3 | Soldering heat resistance | DCR change ≤ 20 % (≤ 10 % for ≤1 A) New solder coverage ≤ 75 % | One dip at 260 °C for 10 seconds | MIL-STD-202 Method 210 |
| 4 | Moisture resistance | DCR change ≤ ±15 % No excessive corrosion | 10 cycles | MIL-STD-202 Method 106 |
| 5 | Salt spray | DCR change ≤ ±10 % No excessive corrosion | 48 hour exposure, 5 % salt solution | MIL-STD-202 Method 101 |
| 6 | Mechanical vibration | DCR change ≤ ±10 % No mechanical damage | 0.4 inch D.A. or 30 G between 5-3000 Hz | MIL-STD-202 Method 204 |
| 7 | Mechanical shock | DCR change ≤ ±10 % No mechanical damage | 1500 G, 0.5 ms, half-sine shocks | MIL-STD-202 Method 213 |
| 8 | Thermal Shock | DCR change ≤ ±10 % No mechanical damage | 100 cycles between -65 °C and +125 °C | MIL-STD-202 Method 107 |
| 9 | Life | No electrical "opens" during testing Voltage drop change shall be less than ±20 % of initial value | 80 % rated current (75 % for < 1 A fuses) for 2000 hours at ambient temperature +25 °C | Refer to STP document |

Agency Recognition

UL File Number E198545

http://www.ul.com/ Follow link to Online Certificates Directory, then enter UL File No. E198545, or [click here](#)

BOURNS®

Asia-Pacific: Tel: +886-2 2562-4117 • Email: asiacus@bourns.com

EMEA: Tel: +36 88 520 390 • Email: eurocus@bourns.com

The Americas: Tel: +1-951 781-5500 • Email: americus@bourns.com

www.bourns.com

* RoHS Directive 2002/95/EC Jan. 27, 2003 including annex and RoHS Recast 2011/65/EU June 8, 2011.

** Bourns considers a product to be "halogen free" if (a) the Bromine (Br) content is 900 ppm or less; (b) the Chlorine (Cl) content is 900 ppm or less; and (c) the total Bromine (Br) and Chlorine (Cl) content is 1500 ppm or less.

"SinglFuse" is a trademark of Bourns, Inc.

Specifications are subject to change without notice.

The device characteristics and parameters in this data sheet can and do vary in different applications and actual device performance may vary over time.

Users should verify actual device performance in their specific applications.

SingIFuse™ SF-2410SPxxxW Series Applications

- White goods
- Lighting ballasts
- LED drivers
- Medical equipment (*excluding critical life support*)
- DC/DC converters
- Power chargers
- Power adapters
- Industrial equipment

SF-2410SPxxxW Series - Time Lag Wire Core Surface Mount Fuses BOURNS®

Environmental Characteristics

| | |
|---------------------------------|---------------------------------|
| Operating Temperature..... | -55 °C to +125 °C |
| Storage Conditions | |
| Temperature | +5 °C to +35 °C |
| Humidity..... | 40 % to 75 % |
| Shelf Life..... | 2 years from manufacturing date |
| Moisture Sensitivity Level..... | 1 |
| ESD Classification (HBM)..... | Class 6 |

Typical Part Marking

Represents total content. Layout may vary.



| | |
|-------------------|----------|
| RATED CURRENT (A) | |
| C = 0.50 | F = 1.25 |
| S = 0.63 | T = 1.60 |
| H = 0.80 | I = 2.00 |
| E = 1.00 | |

How to Order

SF - 2410 SP 100 W - 2

SingIFuse™
 Product Designator
 SMD Footprint
 2410 = 6125 (EIA 2410) size
 Fuse Blow Type
 SP = Time Lag
 Rated Current
 050 ~ 200 (0.5 A ~ 2.0 A)
 Structure Type
 W = Wire Core
 Packaging Type
 - 2 = Tape & Reel

Construction

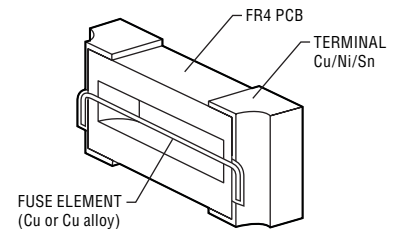

Packaging Quantity

2,000 pieces per 7-inch reel

Product Dimensions

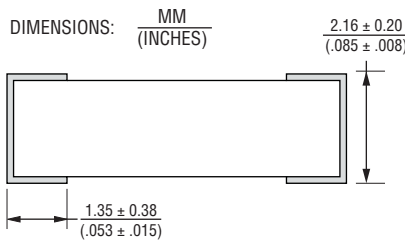
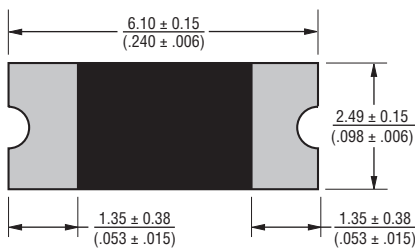

Recommended Pad Layout

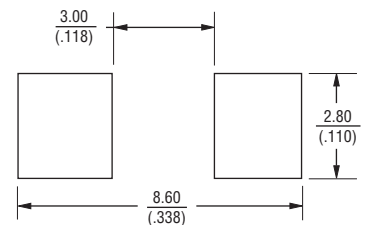

Current Rating Thermal Derating Curve

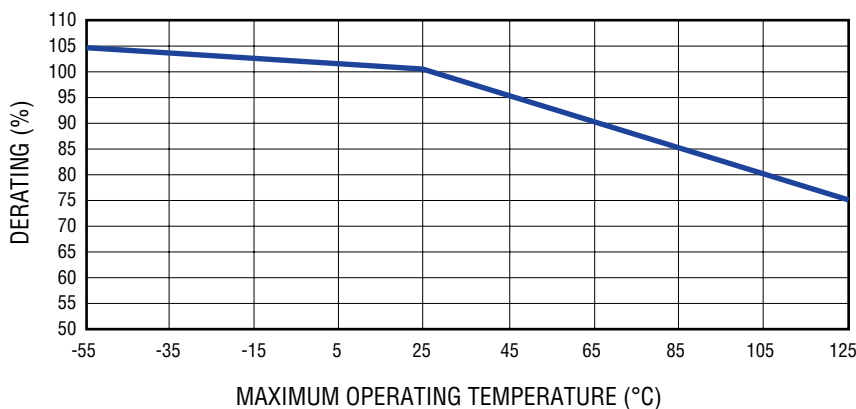

Specifications are subject to change without notice. The device characteristics and parameters in this data sheet can and do vary in different applications and actual device performance may vary over time. Users should verify actual device performance in their specific applications.

Solder Reflow Recommendations



| Profile Feature | Pb-Free Assembly |
|---|------------------------------------|
| Preheat / Soak: Temperature Min. (T_{smin}) Temperature Max. (T_{smax}) Time (t_s) from (T_{smin} to T_{smax}) | 150 °C 200 °C 60~120 seconds |
| Ramp Up Rate (T_l to T_d) | 3 °C / second max. |
| Liquidous Temperature (T_l) Time (t_L) maintained above T_l | 217 °C 60~150 seconds |
| Peak Package Body Temperature (T_d) | 260 °C |
| Time (t_p)* within 5 °C of the specified classification temperature (T_c) | 30 seconds* |
| Ramp Down Rate (T_d to T_l) | 6 °C / second max. |
| Time 25 °C to Peak Temperature | 8 minutes max. |

* Tolerance for peak profile temperature (T_p) is defined as a supplier minimum and a user maximum.

Recommended Temperature Profile for Wave Soldering

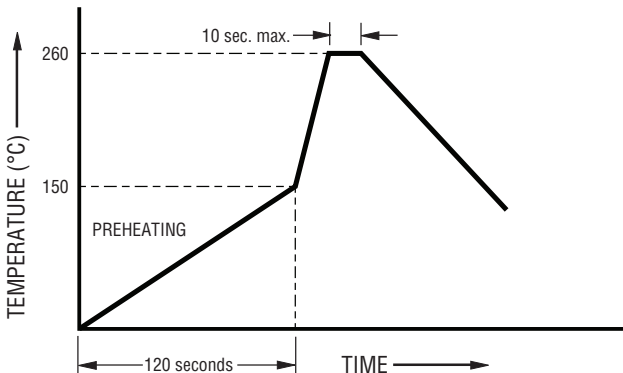

Wave soldering is suitable for 2410 size models.

SF-2410SPxxxW Series Tape and Reel Packaging Specifications



SF-2410SPxxxW Series per EIA 481-2

Tape Dimensions

| | |
|----------------|---|
| W | $\frac{12.00 \pm 0.10}{(.48 \pm .004)}$ |
| P ₀ | $\frac{4.0 \pm 0.10}{(.157 \pm .004)}$ |
| P ₁ | $\frac{4.0 \pm 0.10}{(.157 \pm .004)}$ |
| P ₂ | $\frac{2.0 \pm 0.05}{(.079 \pm .002)}$ |
| A ₀ | $\frac{2.85 \pm 0.10}{(.114 \pm .004)}$ |
| B ₀ | $\frac{6.40 \pm 0.10}{(.256 \pm .004)}$ |
| F | $\frac{5.50 \pm 0.10}{(.220 \pm .004)}$ |
| E | $\frac{1.75 \pm 0.10}{(.069 \pm .004)}$ |
| D ₀ | $\frac{1.55 \pm 0.10}{(.059 \pm .004)}$ |
| D ₁ | $\frac{1.55 \pm 0.10}{(.059 \pm .004)}$ |
| K ₀ | $\frac{2.35 \pm 0.10}{(.094 \pm .004)}$ |
| T | $\frac{0.25 \pm 0.05}{(.010 \pm .002)}$ |

PACKAGING: Plastic tape, 2,000 pcs. per reel

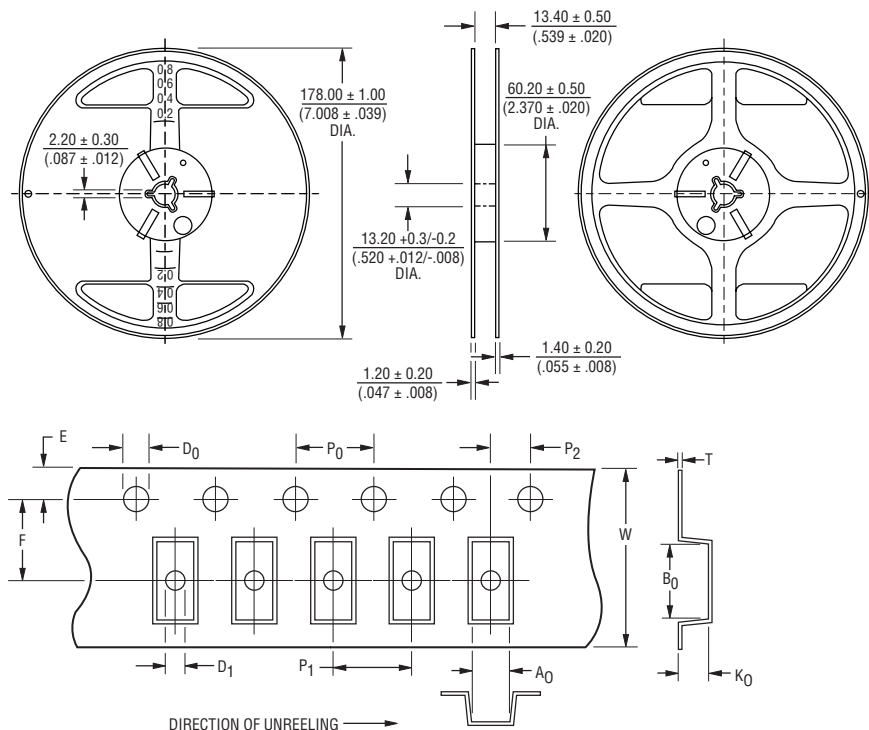

DIMENSIONS: $\frac{\text{MM}}{(\text{INCHES})}$

Specifications are subject to change without notice.

The device characteristics and parameters in this data sheet can and do vary in different applications and actual device performance may vary over time. Users should verify actual device performance in their specific applications.

Компания «Океан Электроники» предлагает заключение долгосрочных отношений при поставках импортных электронных компонентов на взаимовыгодных условиях!

Наши преимущества:

- Поставка оригинальных импортных электронных компонентов напрямую с производств Америки, Европы и Азии, а так же с крупнейших складов мира;
- Широкая линейка поставок активных и пассивных импортных электронных компонентов (более 30 млн. наименований);
- Поставка сложных, дефицитных, либо снятых с производства позиций;
- Оперативные сроки поставки под заказ (от 5 рабочих дней);
- Экспресс доставка в любую точку России;
- Помощь Конструкторского Отдела и консультации квалифицированных инженеров;
- Техническая поддержка проекта, помощь в подборе аналогов, поставка прототипов;
- Поставка электронных компонентов под контролем ВП;
- Система менеджмента качества сертифицирована по Международному стандарту ISO 9001;
- При необходимости вся продукция военного и аэрокосмического назначения проходит испытания и сертификацию в лаборатории (по согласованию с заказчиком);
- Поставка специализированных компонентов военного и аэрокосмического уровня качества (Xilinx, Altera, Analog Devices, Intersil, Interpoint, Microsemi, Actel, Aeroflex, Peregrine, VPT, Syfer, Eurofarad, Texas Instruments, MS Kennedy, Miteq, Cobham, E2V, MA-COM, Hittite, Mini-Circuits, General Dynamics и др.);

Компания «Океан Электроники» является официальным дистрибьютором и эксклюзивным представителем в России одного из крупнейших производителей разъемов военного и аэрокосмического назначения «**JONHON**», а так же официальным дистрибьютором и эксклюзивным представителем в России производителя высокотехнологичных и надежных решений для передачи СВЧ сигналов «**FORSTAR**».



JONHON

«**JONHON**» (основан в 1970 г.)

Разъемы специального, военного и аэрокосмического назначения:

(Применяются в военной, авиационной, аэрокосмической, морской, железнодорожной, горно- и нефтедобывающей отраслях промышленности)

«**FORSTAR**» (основан в 1998 г.)

ВЧ соединители, коаксиальные кабели, кабельные сборки и микроволновые компоненты:

(Применяются в телекоммуникациях гражданского и специального назначения, в средствах связи, РЛС, а так же военной, авиационной и аэрокосмической отраслях промышленности).



Телефон: 8 (812) 309-75-97 (многоканальный)

Факс: 8 (812) 320-03-32

Электронная почта: ocean@oceanchips.ru

Web: <http://oceanchips.ru/>

Адрес: 198099, г. Санкт-Петербург, ул. Калинина, д. 2, корп. 4, лит. А