

General Description

The MAX15062A evaluation kit (EV kit) is a fully assembled and tested circuit board that demonstrates the performance of the MAX15062A 60V, 300mA ultra-small, high-efficiency, synchronous step-down converter. The EV kit operates over a wide 4.5V to 60V input voltage range, and provides up to 300mA at the preset 3.3V output. The device features undervoltage lockout, overcurrent protection, and thermal shutdown. The EV kit switches at a fixed frequency of 500kHz, and delivers a peak efficiency of 90% with the supplied components.

The EV kit comes installed with the MAX15062AATA+ in an 8-pin (2mm x 2mm) lead(Pb)-free/RoHS-compliant TDFN package.

Features

- 4.5V to 60V Input Voltage Range
- 3.3V Output, 300mA Continuous Current
- Internal Compensation
- EN/UVLO for On/Off Control and Programmable Input Undervoltage Lockout
- 90% Peak Efficiency
- 500kHz Fixed-Frequency PWM Operation
- PFM or Forced-PWM Mode of Operation
- Hiccup Mode Overcurrent Protection
- Open-Drain $\overline{\text{RESET}}$ Output
- Thermal Shutdown
- Proven PCB Layout
- Fully Assembled and Tested

Ordering Information appears at end of data sheet.

Component List

DESIGNATION	QTY	DESCRIPTION
C1	1	22 μ F, 100V electrolytic capacitor (8mm x 10.2mm) Panasonic EEEHA2A220UP
C2	1	1 μ F \pm 10%, 100V X7R ceramic capacitor (1206) Murata GRM31CR72A105KA
C3	1	1 μ F \pm 10%, 6.3V X7R ceramic capacitor (0603) Murata GRM188R70J105K
C4	1	10 μ F \pm 10%, 6.3V X7R ceramic capacitor (1206) Murata GRM31CR70J106K
JU1–JU3	3	2-pin headers

DESIGNATION	QTY	DESCRIPTION
L1	1	33 μ H, 680mA inductor Coilcraft LPS4018-333ML
R1	1	2.2M Ω \pm 1% resistor (0402)
R2	1	806k Ω \pm 1% resistor (0402)
R3	1	100k Ω \pm 1% resistor (0402)
U1	1	60V, 300mA, ultra-small, high-efficiency, synchronous step-down DC-DC converter (8 TDFN) Maxim MAX15062AATA+
—	3	Shunts
—	1	PCB: MAX15062A EVALUATION KIT

Component Suppliers

SUPPLIER	PHONE	WEBSITE
Coilcraft, Inc.	847-639-6400	www.coilcraft.com
Murata Electronics North America, Inc.	770-436-1300	www.murata-northamerica.com
Panasonic Corp.	800-344-2112	www.panasonic.com

Note: Indicate that you are using the MAX15062A when contacting these component suppliers.



Quick Start

Recommended Equipment

- MAX15062A EV kit
- 60V adjustable, 0.5A DC power supply
- Electronic load up to 300mA
- Voltmeter

Procedure

The EV kit is fully assembled and tested. Follow the steps below to verify board operation. **Caution: Do not turn on the power supply until all connections are completed.**

- 1) Verify that shunts are installed on jumpers JU1 and JU2 (EN/UVLO).
- 2) Verify that jumper JU3 (MODE PFM operation) is open.
- 3) Set the electronic load to constant-current mode, 300mA, and disable the electronic load.
- 4) Connect the electronic load's positive terminal to the VOUT PCB pad. Connect the negative terminal to the GND PCB pad.
- 5) Connect the voltmeter across the VOUT and GND PCB pads.
- 6) Set the power-supply output to 24V. Disable the power supply.
- 7) Connect the 24V power-supply output to the VIN PCB pad. Connect the supply ground to the GND PCB pad.
- 8) Turn on the power supply and verify that VOUT is at 3.3V with respect to GND.
- 9) Enable the electronic load and verify that VOUT is at 3.3V with respect to GND.

Detailed Description

The MAX15062A evaluation kit (EV kit) is a fully assembled and tested circuit board that demonstrates the performance of the MAX15062A 60V, 300mA ultra-small, high-efficiency, synchronous step-down converter. The EV kit operates over a wide 4.5V to 60V input voltage range, and provides up to 300mA at the preset 3.3V output. The device features undervoltage lockout, overcurrent protection, and thermal shutdown. The EV kit switches at a fixed frequency of 500kHz, and delivers a peak efficiency of 90% with the supplied components.

The EV kit includes an EN/UVLO PCB pad and jumpers JU1 and JU2 to enable control of the converter output. The MODE PCB pad and jumper JU3 are provided for selecting the mode of operation of the converter. The VCC PCB pad helps measure the internal LDO voltage. An additional $\overline{\text{RESET}}$ PCB pad is available for monitoring the open-drain logic output.

Enable Control (JU1, JU2)

The EN/UVLO pin of the device serves as an on/off control while also allowing the user to program the input undervoltage lockout (UVLO) threshold. Jumpers JU1 and JU2 configure the EV kit's output for turn-on/turn-off control. Install a shunt across pins 1-2 on jumper JU2 to disable VOUT. See Table 1 for proper jumper settings.

Additionally, resistors R1 and R2 are included to set the UVLO to a desired turn-on voltage. Refer to the *Enable Input (EN/UVLO)*, *Soft-Start* section in the MAX15062A/MAX15062B IC data sheet for additional information on setting the UVLO threshold voltage.

Table 1. Enable Control (EN/UVLO)

SHUNT POSITION		EN/UVLO PIN	VOUT OUTPUT
JU1	JU2		
1-2	Open	Connected to VIN	Enabled
Open	1-2	Connected to GND	Disabled
1-2*	1-2	Connected to midpoint of the R1, R2 resistor-divider	Enabled at $V_{IN} \geq 4.5V$

*Default position.

Active-Low Open-Drain Reset Output ($\overline{\text{RESET}}$)

The EV kit provides a PCB pad to monitor the status of the $\overline{\text{RESET}}$ output. $\overline{\text{RESET}}$ goes high when V_{OUT} rises above 95% (typ) of its nominal regulated output voltage. When V_{OUT} falls below 92% (typ) of its nominal regulated voltage, $\overline{\text{RESET}}$ is pulled low.

PFM or Forced-PWM Mode (MODE)

The EV kit includes a jumper (JU3) to program the mode of operation of the converter. Install a shunt across JU3 before powering up the EV kit to enable the forced-PWM

operation. Keep JU3 open to enable the light-load PFM operation. See Table 2 for proper JU3 configuration.

Table 2. Mode Control (JU3)

SHUNT POSITION	MODE PIN	MODE OF OPERATION
1-2	Connected to GND	Forced PWM
Open*	Unconnected	PFM

*Default position.

EV Kit Performance Report

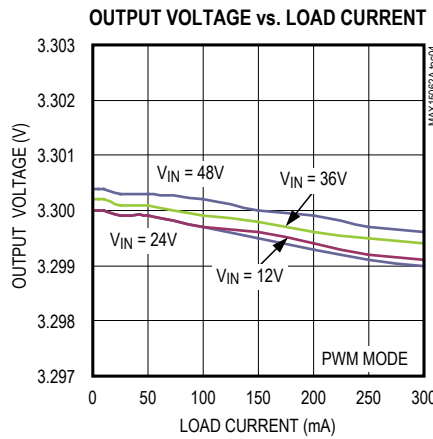
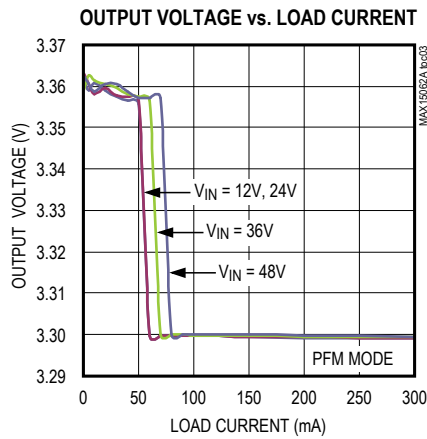
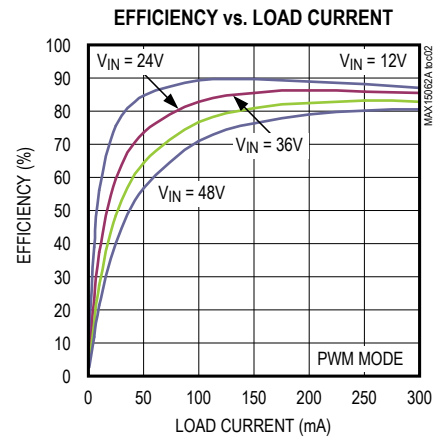
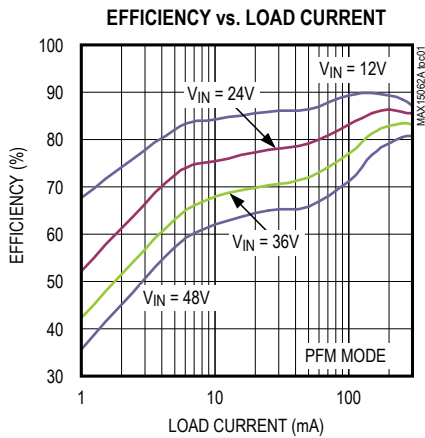

EV Kit Performance Report (continued)

LOAD TRANSIENT RESPONSE—
PFM MODE (LOAD CURRENT
STEPPED FROM 5mA TO 150mA)

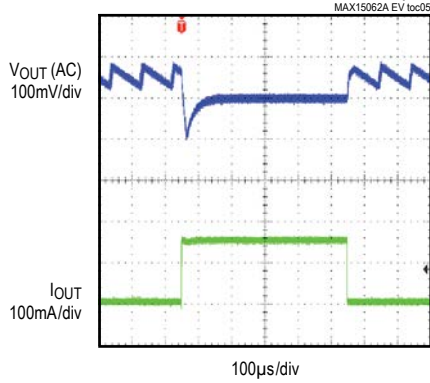

LOAD TRANSIENT RESPONSE—
PFM OR PWM MODE (LOAD CURRENT
STEPPED FROM 150mA TO 300mA)

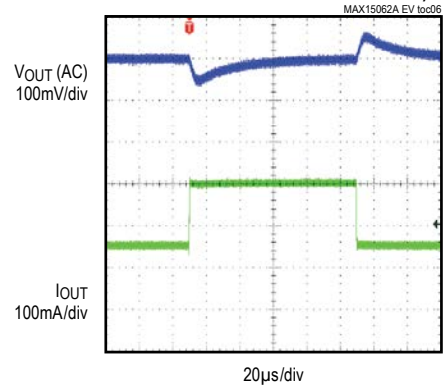

LOAD TRANSIENT RESPONSE—
PWM MODE (LOAD CURRENT
STEPPED FROM NO LOAD TO 150mA)

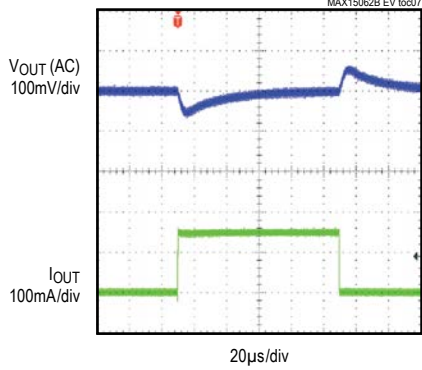

SOFT-START

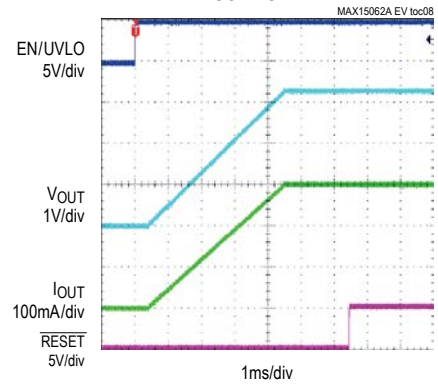

BODE PLOT

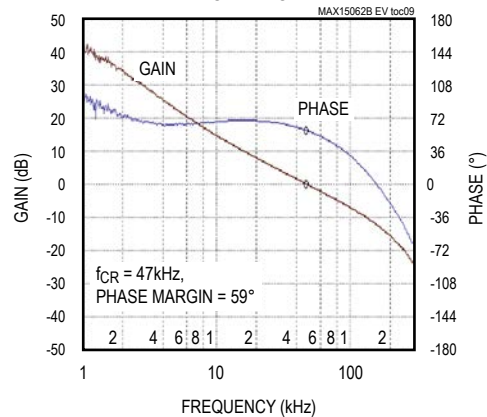

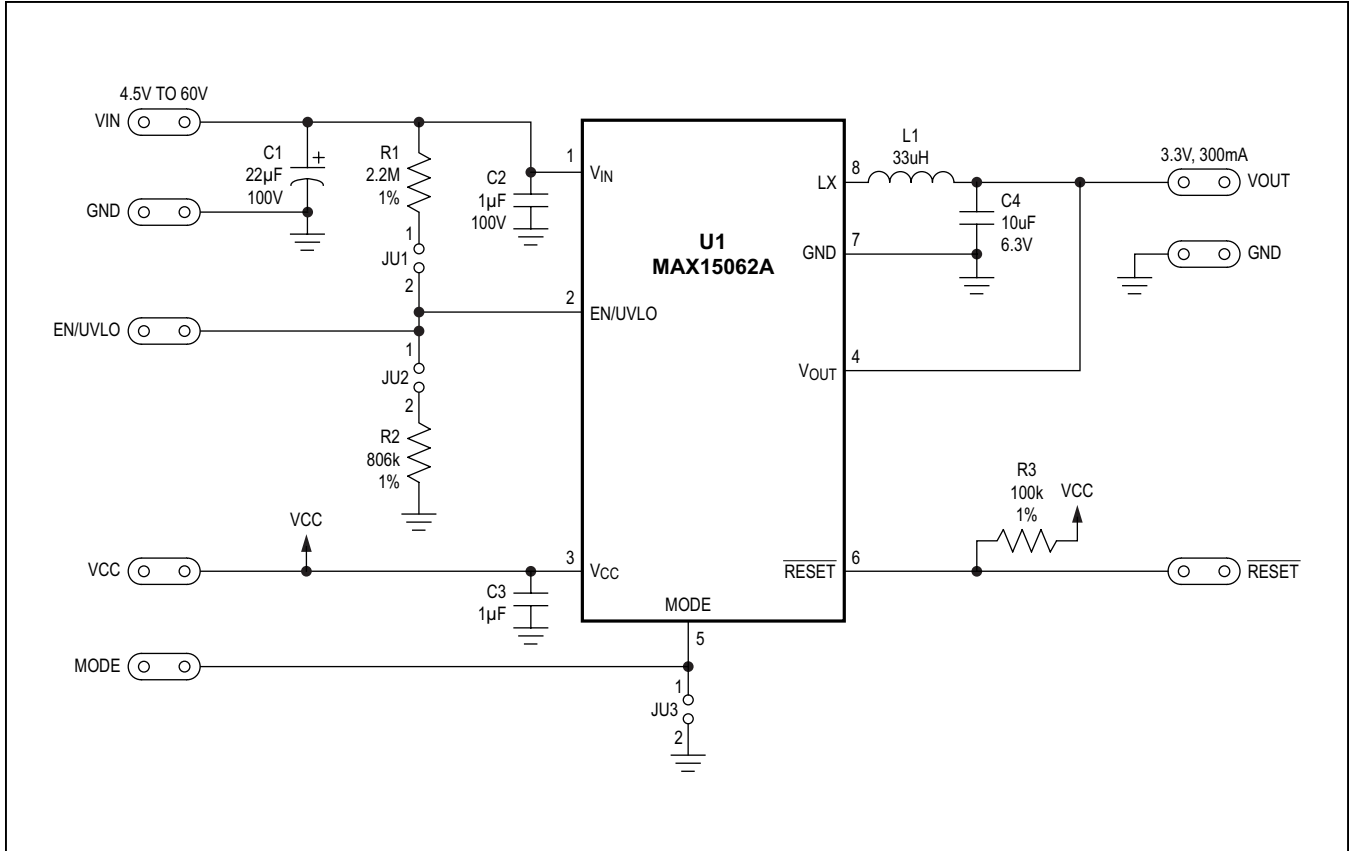

Figure 1. MAX15062A EV Kit Schematic

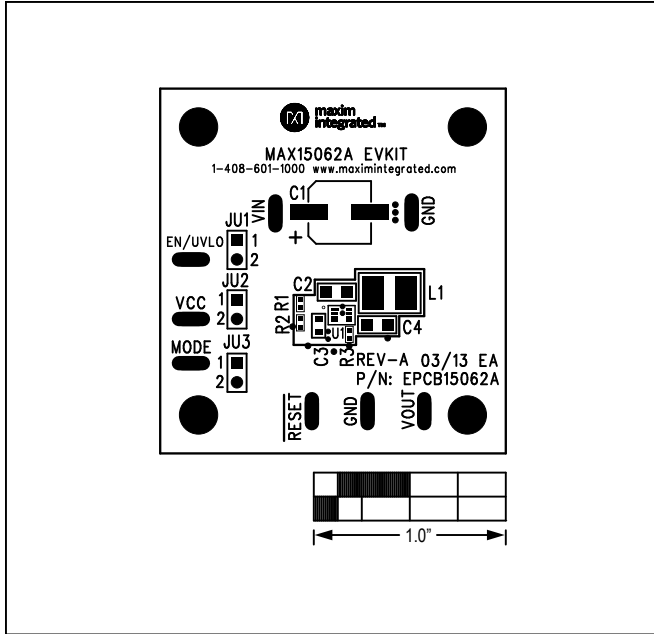

Figure 2. MAX15062A EV Kit Component Placement Guide—Component Side

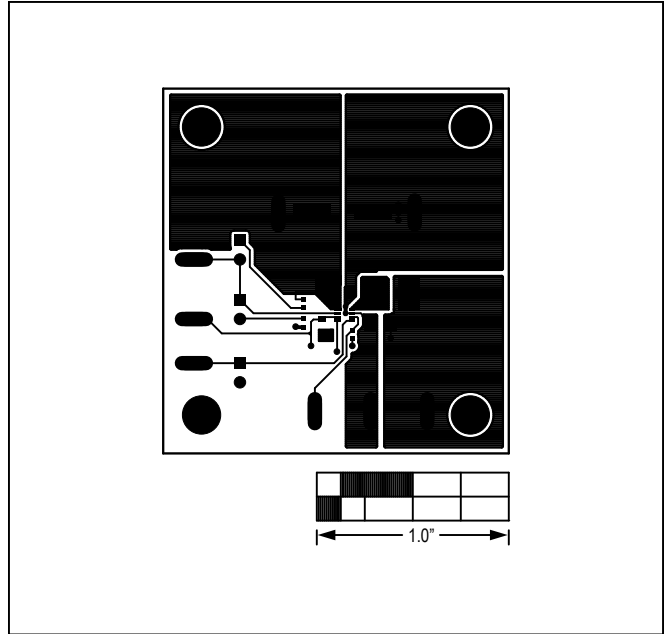

Figure 3. MAX15062A EV Kit PCB Layout—Component Side

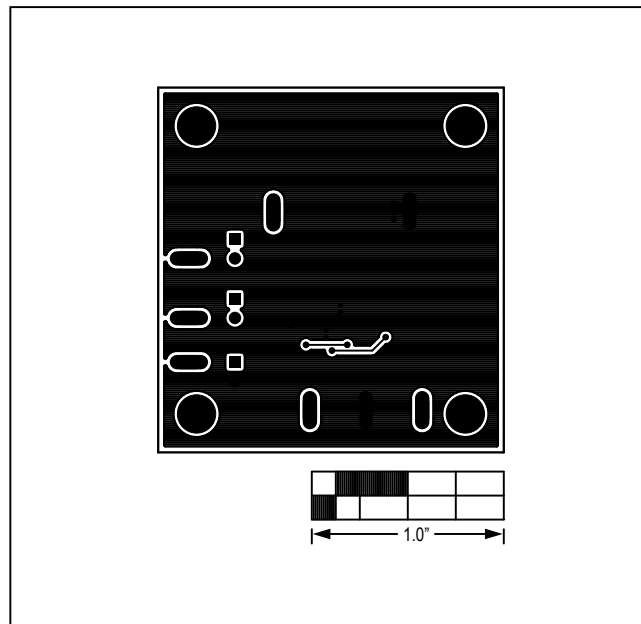

Figure 4. MAX15062A EV Kit PCB Layout—Solder Side

Ordering Information

PART	TYPE
MAX15062AEVKIT#	EVKIT

#Denotes RoHS compliant.

Revision History

REVISION NUMBER	REVISION DATE	DESCRIPTION	PAGES CHANGED
0	4/13	Initial release	—

For pricing, delivery, and ordering information, please contact Maxim Direct at 1-888-629-4642, or visit Maxim Integrated's website at www.maximintegrated.com.

Maxim Integrated cannot assume responsibility for use of any circuitry other than circuitry entirely embodied in a Maxim Integrated product. No circuit patent licenses are implied. Maxim Integrated reserves the right to change the circuitry and specifications without notice at any time.

Компания «Океан Электроники» предлагает заключение долгосрочных отношений при поставках импортных электронных компонентов на взаимовыгодных условиях!

Наши преимущества:

- Поставка оригинальных импортных электронных компонентов напрямую с производств Америки, Европы и Азии, а так же с крупнейших складов мира;
- Широкая линейка поставок активных и пассивных импортных электронных компонентов (более 30 млн. наименований);
- Поставка сложных, дефицитных, либо снятых с производства позиций;
- Оперативные сроки поставки под заказ (от 5 рабочих дней);
- Экспресс доставка в любую точку России;
- Помощь Конструкторского Отдела и консультации квалифицированных инженеров;
- Техническая поддержка проекта, помощь в подборе аналогов, поставка прототипов;
- Поставка электронных компонентов под контролем ВП;
- Система менеджмента качества сертифицирована по Международному стандарту ISO 9001;
- При необходимости вся продукция военного и аэрокосмического назначения проходит испытания и сертификацию в лаборатории (по согласованию с заказчиком);
- Поставка специализированных компонентов военного и аэрокосмического уровня качества (Xilinx, Altera, Analog Devices, Intersil, Interpoint, Microsemi, Actel, Aeroflex, Peregrine, VPT, Syfer, Eurofarad, Texas Instruments, MS Kennedy, Miteq, Cobham, E2V, MA-COM, Hittite, Mini-Circuits, General Dynamics и др.);

Компания «Океан Электроники» является официальным дистрибьютором и эксклюзивным представителем в России одного из крупнейших производителей разъемов военного и аэрокосмического назначения «JONHON», а так же официальным дистрибьютором и эксклюзивным представителем в России производителя высокотехнологичных и надежных решений для передачи СВЧ сигналов «FORSTAR».



JONHON

«JONHON» (основан в 1970 г.)

Разъемы специального, военного и аэрокосмического назначения:

(Применяются в военной, авиационной, аэрокосмической, морской, железнодорожной, горно- и нефтедобывающей отраслях промышленности)

«FORSTAR» (основан в 1998 г.)

ВЧ соединители, коаксиальные кабели, кабельные сборки и микроволновые компоненты:

(Применяются в телекоммуникациях гражданского и специального назначения, в средствах связи, РЛС, а так же военной, авиационной и аэрокосмической отраслях промышленности).



Телефон: 8 (812) 309-75-97 (многоканальный)

Факс: 8 (812) 320-03-32

Электронная почта: ocean@oceanchips.ru

Web: <http://oceanchips.ru/>

Адрес: 198099, г. Санкт-Петербург, ул. Калинина, д. 2, корп. 4, лит. А