

Cree® XLamp® XQ-A LEDs



PRODUCT DESCRIPTION

The XLamp® XQ-A LED brings a mid-power, cost-effective option to the proven, compact ceramic XQ package, enabling lighting manufacturers to quickly and easily expand their product portfolio by leveraging a common XQ design. Unlike plastic mid-power LEDs, the ceramic-based XQ-A LEDs are designed to deliver the long-term calculated lifetimes of Cree's other high-power LEDs. The XQ-A LED's combination of optical symmetry and consistency across all colors improves color mixing and simplifies the production process for lighting manufacturers. Available in both white and color configurations, the XQ-A LED family opens up new design possibilities for a wide spectrum of lighting applications, such as portable, directional, architectural and vehicle lighting.

FEATURES

- Cree's smallest lighting class LED: 1.6 X 1.6 mm
- Available in 70-, 80- & 90-CRI white, and royal blue, blue, green, PC amber, red-orange & red
- Maximum drive current: white: 300 mA, color: 250 mA
- Wide viewing angle: white: 100°, royal blue, blue, PC amber: 105°, green, red-orange, red: 110°
- Reflow solderable - JEDEC J-STD-020C compatible
- Unlimited floor life at $\leq 30\text{ }^{\circ}\text{C}/85\%\text{ RH}$
- RoHS-compliant
- UL® recognized component (E349212)



TABLE OF CONTENTS

| | |
|---|----|
| Characteristics | 2 |
| Flux Characteristics - White..... | 3 |
| Flux Characteristics - Color | 4 |
| Relative Spectral Power Distribution | 6 |
| Relative Flux vs. Junction Temperature..... | 7 |
| Electrical Characteristics..... | 8 |
| Relative Flux vs. Current | 9 |
| Relative Chromaticity vs. Current and Temperature | 11 |
| Typical Spatial Distribution..... | 12 |
| Thermal Design | 13 |
| Reflow Soldering Characteristics..... | 14 |
| Notes | 15 |
| Mechanical Dimensions | 17 |
| Tape and Reel..... | 18 |
| Packaging..... | 19 |

CHARACTERISTICS

| Characteristics | Unit | Minimum | Typical | Maximum |
|--|---------|---------|----------|---------|
| Thermal resistance, junction to solder point - white | °C/W | | 20 | |
| Thermal resistance, junction to solder point - royal blue, blue | °C/W | | 17 | |
| Thermal resistance, junction to solder point - green | °C/W | | 30 | |
| Thermal resistance, junction to solder point - PC amber | °C/W | | 20 | |
| Thermal resistance, junction to solder point - red-orange, red | °C/W | | 18 | |
| Viewing angle (FWHM) - white | degrees | | 100 | |
| Viewing angle (FWHM) - royal blue, blue, PC amber | degrees | | 105 | |
| Viewing angle (FWHM) - green, red-orange, red | degrees | | 110 | |
| Temperature coefficient of voltage - white | mV/°C | | -2.8 | |
| Temperature coefficient of voltage - royal blue, blue | mV/°C | | -4 | |
| Temperature coefficient of voltage - green | mV/°C | | -4.3 | |
| Temperature coefficient of voltage - PC amber | mV/°C | | -4.2 | |
| Temperature coefficient of voltage - red-orange, red | mV/°C | | -2.0 | |
| ESD withstand voltage (HBM per Mil-Std-883D) - white, royal blue, blue, green, red-orange, red | | | Class 3A | |
| ESD classification (HBM per Mil-Std-883D) - PC amber | | | Class 2 | |
| DC forward current-white | mA | | | 300 |
| DC forward current - color | mA | | | 250 |
| Reverse voltage | V | | | 5 |
| Forward voltage (@ 175 mA, 85 °C) - white | V | | 3.0 | 3.3 |
| Forward voltage (@ 175 mA, 25 °C) - royal blue, blue | V | | 3.25 | 3.6 |
| Forward voltage (@ 175 mA, 25 °C) - green | V | | 3.4 | 3.6 |
| Forward voltage (@ 175 mA, 25 °C) - PC amber | V | | 3.4 | 3.7 |
| Forward voltage (@ 175 mA, 25 °C) - red-orange, red | V | | 2.2 | 2.6 |
| LED junction temperature | °C | | | 150 |

FLUX CHARACTERISTICS - WHITE ($T_j = 85\text{ °C}$)

The following table provides several base order codes for XLamp XQ-A white LEDs. It is important to note that the base order codes listed here are a subset of the total available order codes for the product family. For more order codes, as well as a complete description of the order-code nomenclature, please consult the XLamp XQ Family LEDs Binning and Labeling document.

| Color | CCT Range | | Minimum Luminous Flux @ 175 mA | | | Calculated Minimum Luminous Flux (lm) @ 85 °C** | Order Code |
|----------------------|-----------|---------|--------------------------------|-------------------|--------------------|---|--------------------------|
| | Minimum | Maximum | Group | Flux (lm) @ 85 °C | Flux (lm) @ 25 °C* | | |
| Cool White | 5000 K | 8300 K | M3 | 45.7 | 52.6 | 65.6 | XQAAWT-00-0000-00000L3E2 |
| | | | N2 | 51.7 | 59.5 | 74.2 | XQAAWT-00-0000-00000L4E2 |
| | | | N3 | 56.8 | 65.3 | 81.6 | XQAAWT-00-0000-00000L5E2 |
| 70-CRI Minimum White | 3700 K | 8300 K | M3 | 45.7 | 52.6 | 65.6 | XQAAWT-00-0000-00000B3E2 |
| | | | N2 | 51.7 | 59.5 | 74.2 | XQAAWT-00-0000-00000B4E2 |
| | | | N3 | 56.8 | 65.3 | 81.6 | XQAAWT-00-0000-00000B5E2 |
| Neutral White | 3700 K | 5300 K | M2 | 39.8 | 45.8 | 57.1 | XQAAWT-00-0000-00000L2E4 |
| | | | M3 | 45.7 | 52.6 | 65.6 | XQAAWT-00-0000-00000L3E4 |
| Warm White | 2700 K | 3500 K | K3 | 35.2 | 40.5 | 50.5 | XQAAWT-00-0000-00000LZE7 |
| | | | M2 | 39.8 | 45.8 | 57.1 | XQAAWT-00-0000-00000L2E7 |
| 80-CRI Minimum White | 2700 K | 3500 K | K3 | 35.2 | 40.5 | 50.5 | XQAAWT-00-0000-00000HZE7 |
| | | | M2 | 39.8 | 45.8 | 57.1 | XQAAWT-00-0000-00000H2E7 |
| 90-CRI Minimum White | 2850 K | 3000 K | J2 | 23.5 | 26.6 | 37.3 | XQAAWT-00-0000-00000UYE7 |
| | | | K2 | 30.6 | 35.2 | 43.9 | XQAAWT-00-0000-00000UZE7 |

Notes:

- Cree maintains a tolerance of $\pm 7\%$ on flux and power measurements, ± 0.005 on chromaticity (CCx, CCy) measurements and ± 2 on CRI measurements. See the Measurements section (page 15).
- Typical CRI for Cool White (5000 K – 8300 K CCT) is 70.
- Typical CRI for Neutral White (3700 K – 5300 K CCT) is 75.
- Typical CRI for Warm White (2600 K – 3700 K CCT) is 80.
- Minimum CRI for 70-CRI Minimum White is 70.
- Minimum CRI for 80-CRI Minimum White is 80.
- Minimum CRI for 90-CRI Minimum White is 90.
- * Flux values @ 25 °C are calculated and for reference only.
- ** Calculated flux values at 350 mA are for reference only.

FLUX CHARACTERISTICS - COLOR (T_j = 25 °C)

The following table provides several base order codes for XLamp XQ-A color LEDs. It is important to note that the base order codes listed here are a subset of the total available order codes for the product family. For more order codes, as well as a complete description of the order-code nomenclature, please consult the XLamp XQ Family LEDs Binning and Labeling document.

| Color | Dominant Wavelength Range | | | | Minimum Radiant Flux @ 175 mA | | Order Code |
|------------|---------------------------|----------|---------|----------|-------------------------------|-----------|--------------------------|
| | Minimum | | Maximum | | Group | Flux (mW) | |
| | Group | DWL (nm) | Group | DWL (nm) | | | |
| Royal Blue | D36 | 450 | D57 | 465 | 11 | 210 | XQAROY-00-0000-000000601 |
| | | | | | 12 | 250 | XQAROY-00-0000-000000701 |

| Color | Dominant Wavelength Range | | | | Minimum Luminous Flux @ 175 mA | | Order Code |
|-------|---------------------------|----------|---------|----------|--------------------------------|-----------|--------------------------|
| | Minimum | | Maximum | | Group | Flux (lm) | |
| | Group | DWL (nm) | Group | DWL (nm) | | | |
| Blue | B3 | 465 | B6 | 485 | F2 | 10.7 | XQABLU-00-0000-000000T01 |
| | | | | | G2 | 13.9 | XQABLU-00-0000-000000U0 |

| Color | Dominant Wavelength Range | | | | Minimum Luminous Flux @ 175 mA | | Order Code |
|-------|---------------------------|----------|---------|----------|--------------------------------|-----------|--------------------------|
| | Minimum | | Maximum | | Group | Flux (lm) | |
| | Group | DWL (nm) | Group | DWL (nm) | | | |
| Green | G2 | 520 | G4 | 535 | K2 | 30.6 | XQAGRN-00-0000-000000Y01 |
| | | | | | K3 | 35.2 | XQAGRN-00-0000-000000Z01 |
| | | | | | M2 | 39.8 | XQAGRN-00-0000-000000201 |
| | | | | | M3 | 45.7 | XQAGRN-00-0000-000000301 |

| Color | Color Bin | Minimum Luminous Flux @ 175 mA | | Order Code |
|----------|-----------|--------------------------------|-----------|--------------------------|
| | | Group | Flux (lm) | |
| PC Amber | Y2 | J3 | 26.8 | XQAAPA-00-0000-000000X01 |
| | | K2 | 30.6 | XQAAPA-00-0000-000000Y01 |
| | | K3 | 35.2 | XQAAPA-00-0000-000000Z01 |

| Color | Dominant Wavelength Range | | | | Minimum Luminous Flux @ 175 mA | | Order Code |
|------------|---------------------------|----------|---------|----------|--------------------------------|-----------|--------------------------|
| | Minimum | | Maximum | | Group | Flux (lm) | |
| | Group | DWL (nm) | Group | DWL (nm) | | | |
| Red-Orange | O3 | 610 | O4 | 620 | K2 | 30.6 | XQARDO-00-0000-000000Y01 |
| | | | | | K3 | 35.2 | XQARDO-00-0000-000000Z01 |
| | | | | | M2 | 39.8 | XQARDO-00-0000-000000201 |

FLUX CHARACTERISTICS - COLOR ($T_j = 25\text{ }^\circ\text{C}$) - CONTINUED

| Color | Dominant Wavelength Range | | | | Minimum Luminous Flux @ 175 mA | | Order Code |
|-------|---------------------------|----------|---------|----------|--------------------------------|-----------|--------------------------|
| | Minimum | | Maximum | | Group | Flux (lm) | |
| | Group | DWL (nm) | Group | DWL (nm) | | | |
| Red | R2 | 620 | R3 | 630 | J2 | 23.5 | XQARED-00-0000-000000W01 |
| | | | | | J3 | 26.8 | XQARED-00-0000-000000X01 |
| | | | | | K2 | 30.6 | XQARED-00-0000-000000Y01 |

Note: Cree maintains a tolerance of $\pm 7\%$ on flux and power measurements and $\pm 1\text{ nm}$ on dominant wavelength measurements. See the Measurements section (page 15).

RELATIVE SPECTRAL POWER DISTRIBUTION



RELATIVE FLUX VS. JUNCTION TEMPERATURE ($I_F = 175 \text{ mA}$)

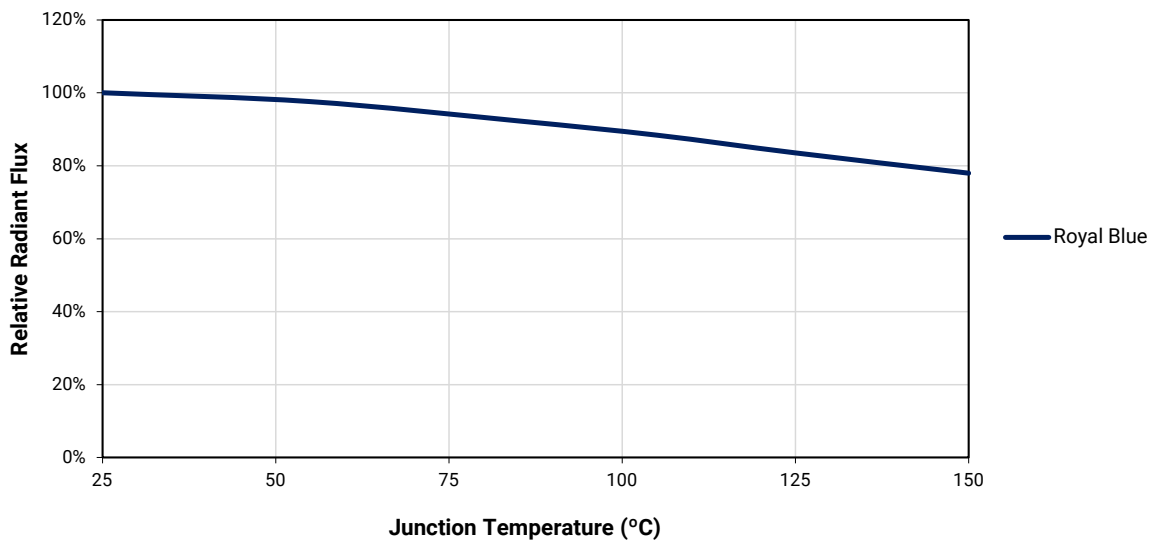
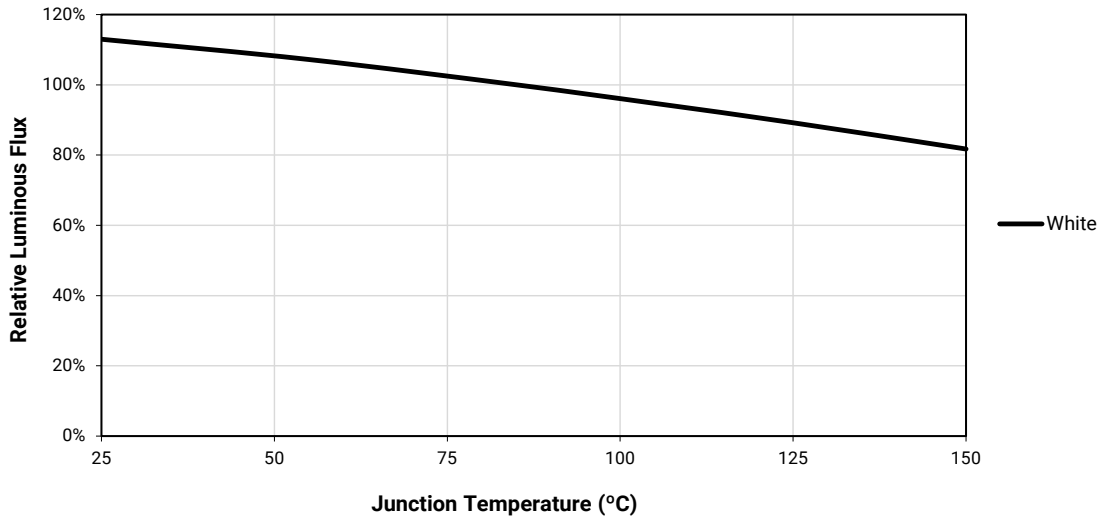

RELATIVE FLUX VS. JUNCTION TEMPERATURE ($I_F = 175 \text{ mA}$) - CONTINUED



ELECTRICAL CHARACTERISTICS ($T_J = 85 \text{ °C}$)



ELECTRICAL CHARACTERISTICS ($T_j = 25\text{ }^\circ\text{C}$)



RELATIVE FLUX VS. CURRENT ($T_j = 85\text{ }^\circ\text{C}$)



RELATIVE FLUX VS. CURRENT ($T_j = 25\text{ }^\circ\text{C}$)



RELATIVE CHROMATICITY VS. CURRENT AND TEMPERATURE (WARM WHITE)

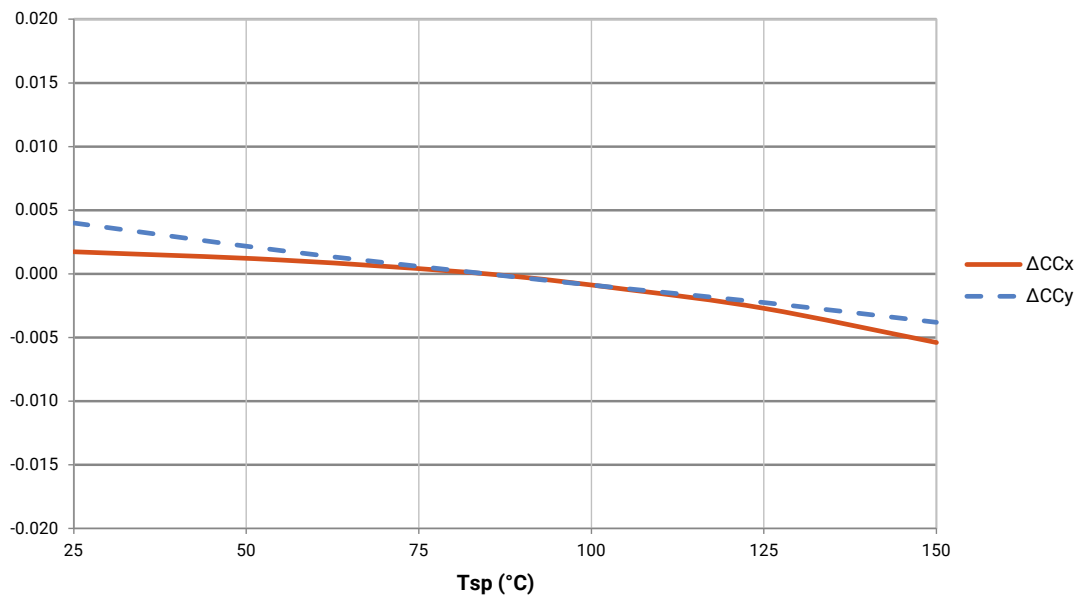

TYPICAL SPATIAL DISTRIBUTION



THERMAL DESIGN

The maximum forward current is determined by the thermal resistance between the LED junction and ambient. It is crucial for the end product to be designed in a manner that minimizes the thermal resistance from the solder point to ambient in order to optimize lamp life and optical characteristics.

White



Royal Blue, Blue

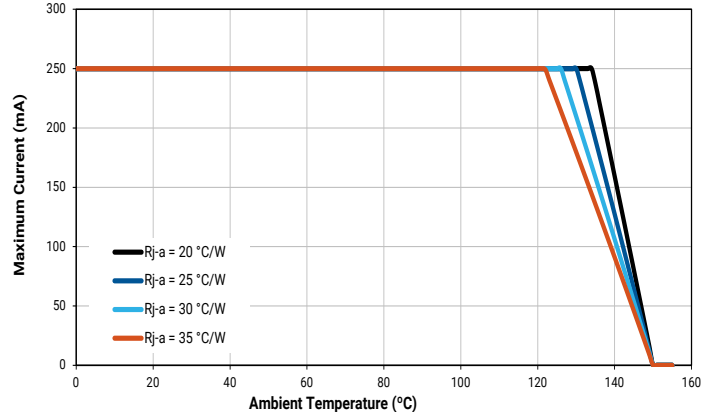

Green

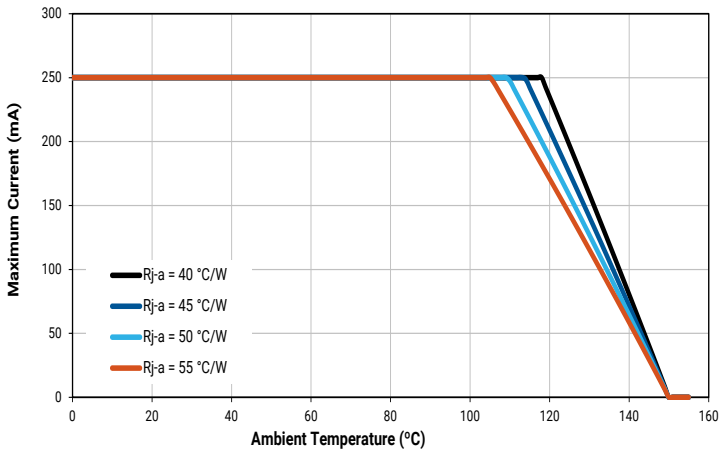

PC Amber

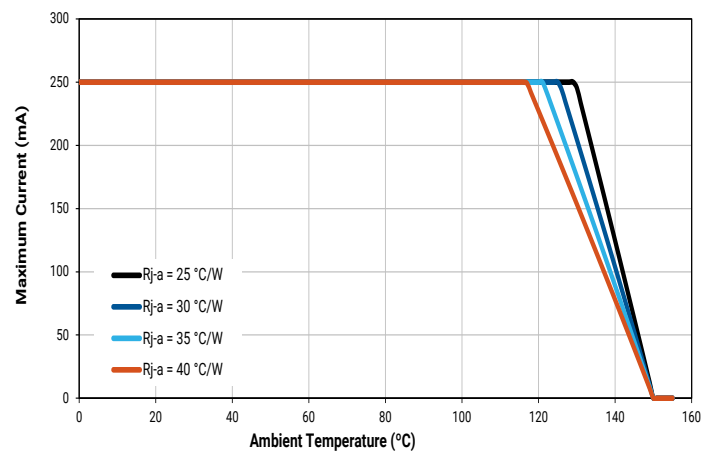

Red-Orange, Red



REFLOW SOLDERING CHARACTERISTICS

In testing, Cree has found XLamp XQ-A LEDs to be compatible with JEDEC J-STD-020C, using the parameters listed below. As a general guideline, Cree recommends that users follow the recommended soldering profile provided by the manufacturer of the solder paste used.

Note that this general guideline may not apply to all PCB designs and configurations of reflow soldering equipment.



IPC/JEDEC J-STD-020C

| Profile Feature | Lead-Free Solder |
|---|------------------|
| Average Ramp-Up Rate ($T_{s_{max}}$ to T_p) | 1.2 °C/second |
| Preheat: Temperature Min ($T_{s_{min}}$) | 120 °C |
| Preheat: Temperature Max ($T_{s_{max}}$) | 170 °C |
| Preheat: Time ($t_{s_{min}}$ to $t_{s_{max}}$) | 65-150 seconds |
| Time Maintained Above: Temperature (T_L) | 217 °C |
| Time Maintained Above: Time (t_L) | 45-90 seconds |
| Peak/Classification Temperature (T_p) | 235 - 245 °C |
| Time Within 5 °C of Actual Peak Temperature (t_p) | 20-40 seconds |
| Ramp-Down Rate | 1 - 6 °C/second |
| Time 25 °C to Peak Temperature | 4 minutes max. |

Note: All temperatures refer to topside of the package, measured on the package body surface.

NOTES

Measurements

The luminous flux, radiant power, chromaticity and CRI measurements in this document are binning specifications only and solely represent product measurements as of the date of shipment. These measurements will change over time based on a number of factors that are not within Cree's control and are not intended or provided as operational specifications for the products. Calculated values are provided for informational purposes only and are not intended as specifications.

Pre-Release Qualification Testing

Please read the [LED Reliability Overview](#) for details of the qualification process Cree applies to ensure long-term reliability for XLamp LEDs and details of Cree's pre-release qualification testing for XLamp LEDs. Cree did not perform Room Temperature Operating Life (RTOL) testing on the XQ-A LED.

Lumen Maintenance

Cree now uses standardized IES LM-80-08 and TM-21-11 methods for collecting long-term data and extrapolating LED lumen maintenance. For information on the specific LM-80 data sets available for this LED, refer to the public [LM-80 results document](#).

Please read the [Long-Term Lumen Maintenance application note](#) for more details on Cree's lumen maintenance testing and forecasting. Please read the [Thermal Management application note](#) for details on how thermal design, ambient temperature, and drive current affect the LED junction temperature.

Moisture Sensitivity

Cree recommends keeping XLamp LEDs in the provided, resealable moisture-barrier packaging (MBP) until immediately prior to soldering. Unopened MBPs that contain XLamp LEDs do not need special storage for moisture sensitivity.

Once the MBP is opened, XLamp XQ-A LEDs may be stored as MSL 1 per JEDEC J-STD-033, meaning they have unlimited floor life in conditions of ≤ 30 °C/85% relative humidity (RH). Regardless of storage condition, Cree recommends sealing any unsoldered LEDs in the original MBP.

RoHS Compliance

The levels of RoHS restricted materials in this product are below the maximum concentration values (also referred to as the threshold limits) permitted for such substances, or are used in an exempted application, in accordance with EU Directive 2011/65/EC (RoHS2), as implemented January 2, 2013. RoHS Declarations for this product can be obtained from your Cree representative or from the Product Documentation sections of www.cree.com.

UL® Recognized Component

Level 1 enclosure consideration. The LED package or a portion thereof has not been investigated as a fire enclosure or a fire and electrical enclosure per ANSI/UL 8750.

NOTES - CONTINUED

Vision Advisory

WARNING: Do not look at an exposed lamp in operation. Eye injury can result. For more information about LEDs and eye safety, please refer to the [LED Eye Safety application note](#).

MECHANICAL DIMENSIONS

Thermal vias, if present, are not shown on these drawings.

All dimensions in mm.

Measurement tolerances unless indicated otherwise: ± 0.13 mm

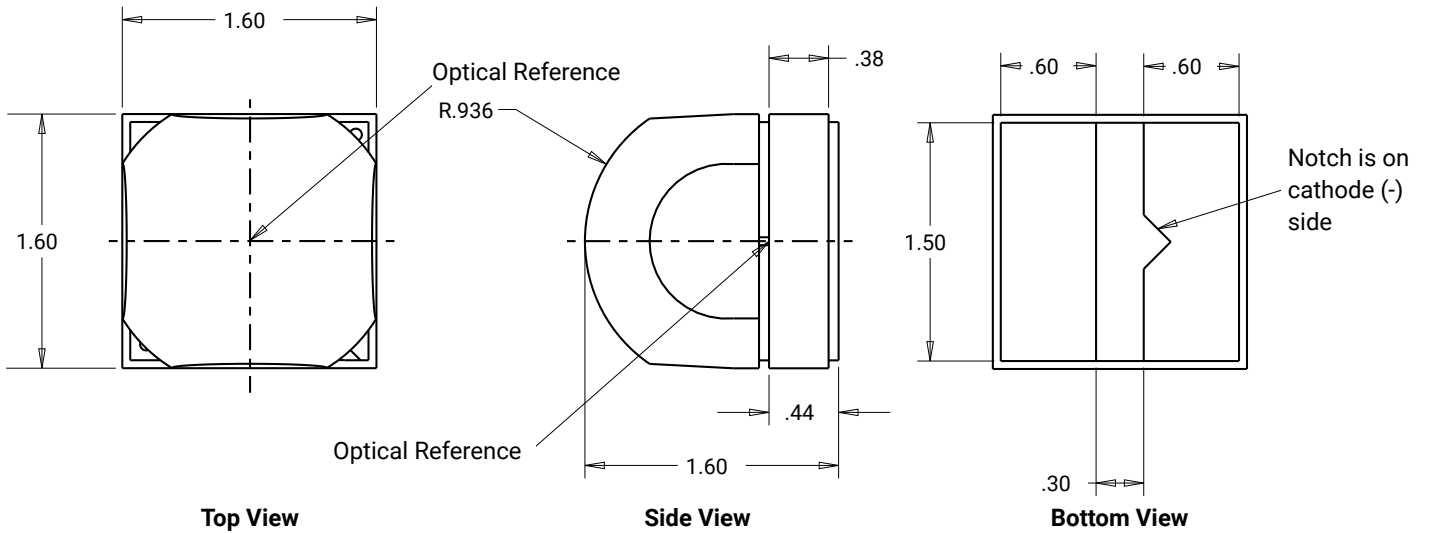

Top View

Side View

Bottom View

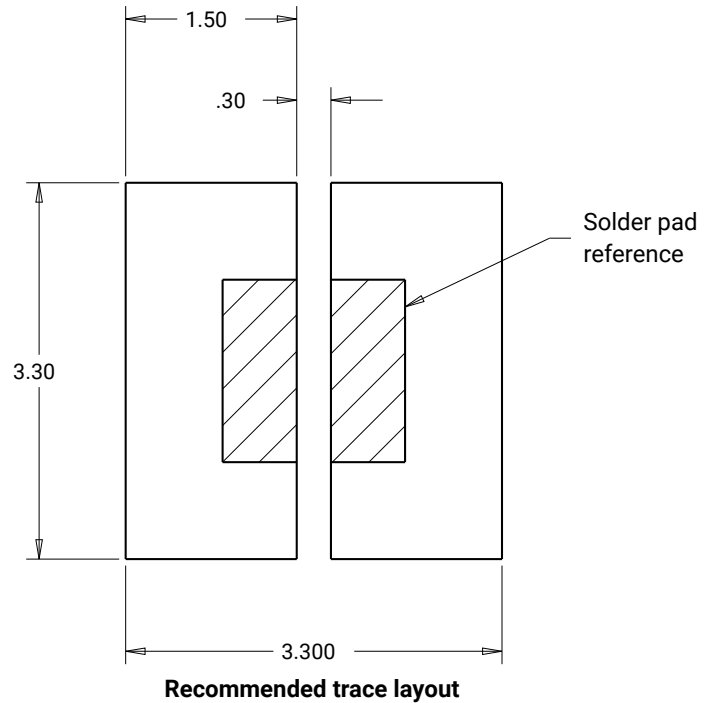
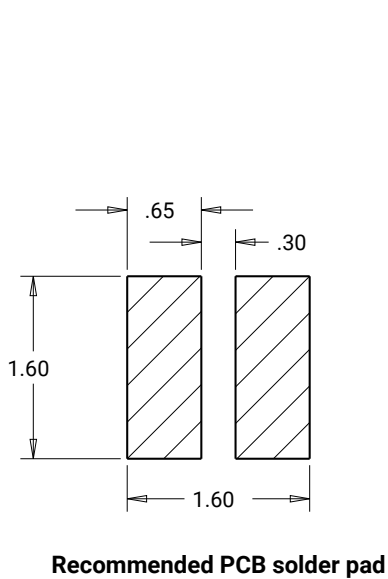

TAPE AND REEL

All Cree carrier tapes conform to EIA-481D, Automated Component Handling Systems Standard.

Except as noted, all dimensions in mm [in].

Measurement tolerances unless indicated otherwise: .xx = ±.25 mm, .xxx = . ± 125 mm

| POCKET SIZE | |
|-------------|------------------|
| Ao | - 1.75mm [.069"] |
| Bo | - 1.75mm [.069"] |
| Ko | - 1.60mm [.063"] |

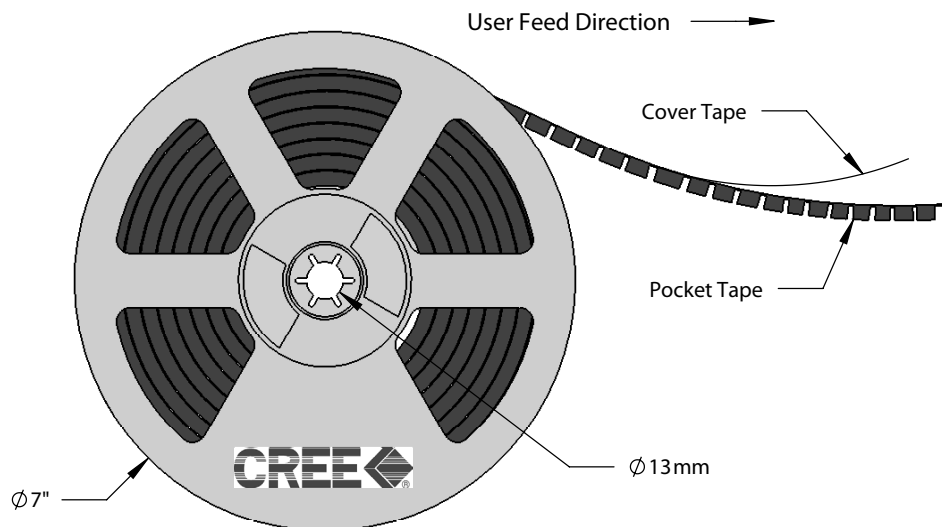
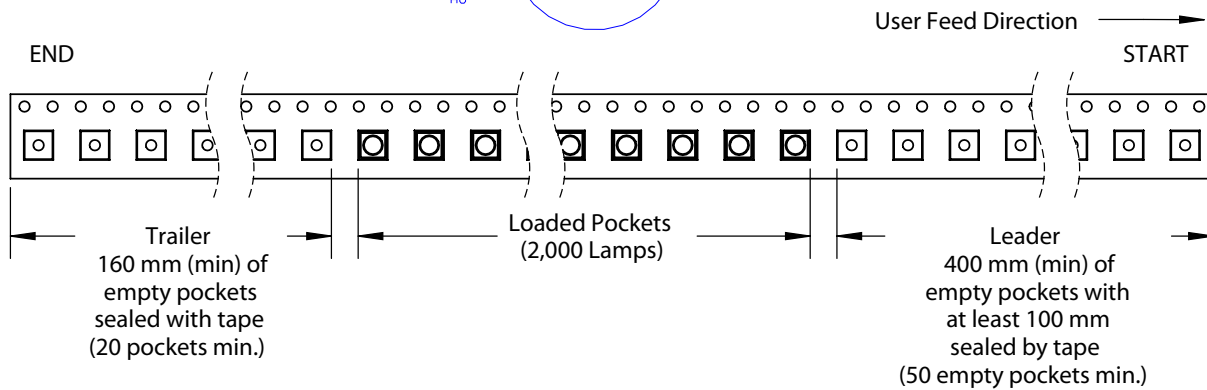
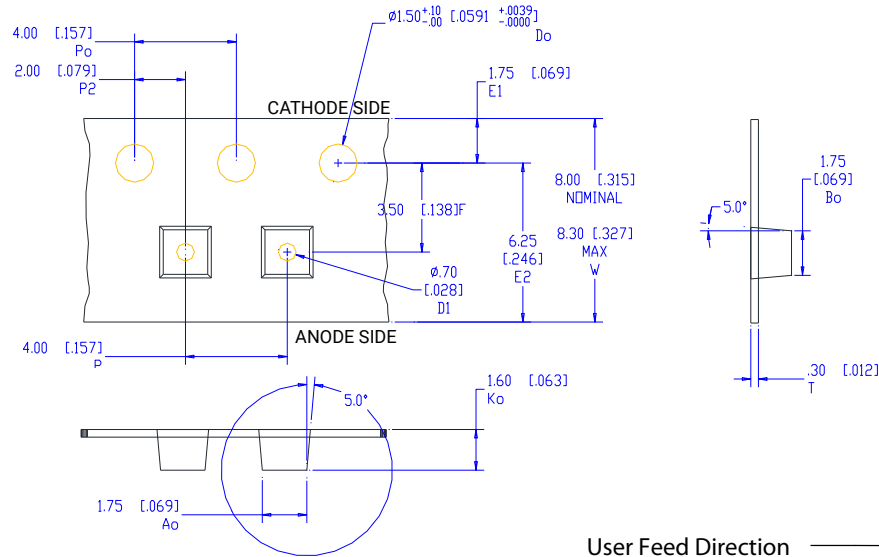

PACKAGING

The diagrams below show the packaging and labels Cree uses to ship XLamp XQ-A LEDs. XLamp XQ-A LEDs are shipped in tape loaded on a reel. Each box contains only one reel in a moisture barrier bag.

Unpackaged Reel

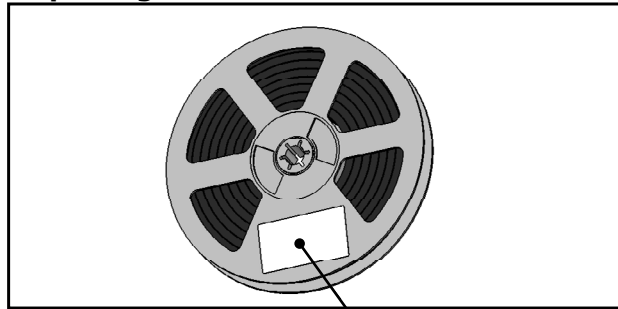

Label with Cree Bin Code, Quantity, Reel ID

Packaged Reel

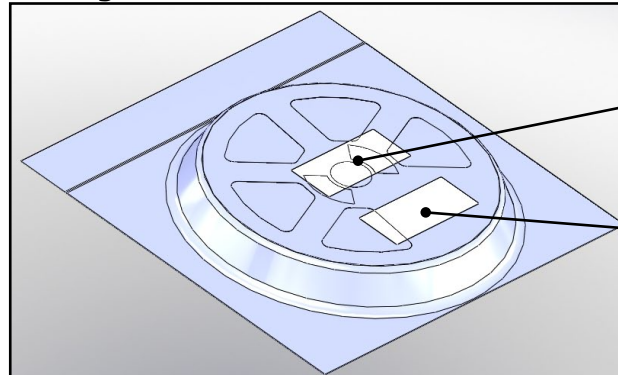

Label with Cree Order Code, Quantity, Reel ID, PO #

Label with Cree Bin Code, Quantity, Reel ID

Boxed Reel

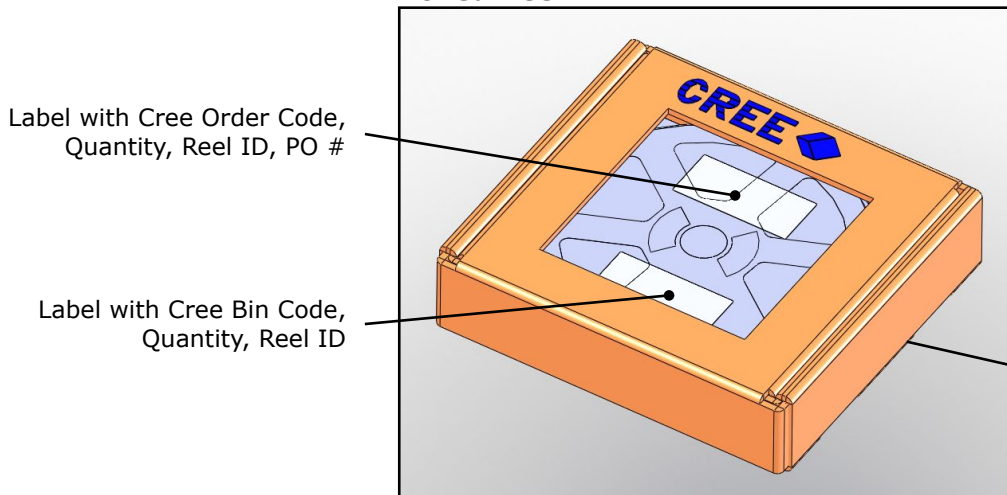

Label with Cree Order Code, Quantity, Reel ID, PO #

Label with Cree Bin Code, Quantity, Reel ID

Patent Label (on bottom of box)

Компания «Океан Электроники» предлагает заключение долгосрочных отношений при поставках импортных электронных компонентов на взаимовыгодных условиях!

Наши преимущества:

- Поставка оригинальных импортных электронных компонентов напрямую с производств Америки, Европы и Азии, а так же с крупнейших складов мира;
- Широкая линейка поставок активных и пассивных импортных электронных компонентов (более 30 млн. наименований);
- Поставка сложных, дефицитных, либо снятых с производства позиций;
- Оперативные сроки поставки под заказ (от 5 рабочих дней);
- Экспресс доставка в любую точку России;
- Помощь Конструкторского Отдела и консультации квалифицированных инженеров;
- Техническая поддержка проекта, помощь в подборе аналогов, поставка прототипов;
- Поставка электронных компонентов под контролем ВП;
- Система менеджмента качества сертифицирована по Международному стандарту ISO 9001;
- При необходимости вся продукция военного и аэрокосмического назначения проходит испытания и сертификацию в лаборатории (по согласованию с заказчиком);
- Поставка специализированных компонентов военного и аэрокосмического уровня качества (Xilinx, Altera, Analog Devices, Intersil, Interpoint, Microsemi, Actel, Aeroflex, Peregrine, VPT, Syfer, Eurofarad, Texas Instruments, MS Kennedy, Miteq, Cobham, E2V, MA-COM, Hittite, Mini-Circuits, General Dynamics и др.);

Компания «Океан Электроники» является официальным дистрибьютором и эксклюзивным представителем в России одного из крупнейших производителей разъемов военного и аэрокосмического назначения «JONHON», а так же официальным дистрибьютором и эксклюзивным представителем в России производителя высокотехнологичных и надежных решений для передачи СВЧ сигналов «FORSTAR».



JONHON

«JONHON» (основан в 1970 г.)

Разъемы специального, военного и аэрокосмического назначения:

(Применяются в военной, авиационной, аэрокосмической, морской, железнодорожной, горно- и нефтедобывающей отраслях промышленности)

«FORSTAR» (основан в 1998 г.)

ВЧ соединители, коаксиальные кабели, кабельные сборки и микроволновые компоненты:

(Применяются в телекоммуникациях гражданского и специального назначения, в средствах связи, РЛС, а так же военной, авиационной и аэрокосмической отраслях промышленности).



Телефон: 8 (812) 309-75-97 (многоканальный)

Факс: 8 (812) 320-03-32

Электронная почта: ocean@oceanchips.ru

Web: <http://oceanchips.ru/>

Адрес: 198099, г. Санкт-Петербург, ул. Калинина, д. 2, корп. 4, лит. А