

Programmable Controllers

SYSMAC

CS1

Multiple-application Controllers with a Wide Range of Functions



- » High Performance
- » Human Efficiency
- » Heritage

Multi-application Controllers: From High-performance Machine Control to Highly Reliable Process Control

CONTENTS

- ▶ Concepts F-2
- ▶ System Design Guide 1
 - System Configuration 2
 - Dimensions/Mounting Dimensions 9
 - General Specifications 11
 - Common Specifications for CPU Units 12
 - Current Consumption for Power Supply Units 15
- ▶ Ordering Information 17
 - Basic Configuration Units 18
 - Programming Devices 22
 - Optional Products and Maintenance Products 25
 - DIN Track Accessories 25
 - Basic I/O Units 26
 - Special I/O Units and CPU Bus Units 32
 - Replacing C200H I/O Units 54



Ultimate Controller Performance

High Performance

In order to create facilities that have the production capability to withstand sudden changes in demand, or to create machinery that is easily distinguished from that created by market competitors, a top-speed controller that can deliver the performance required to support these needs is required. The SYSMAC CS1 PLCs have been equipped with the highest I/O responsiveness and data control functionality to significantly reduce processing time and to control machinery movement with greater precision.

User-friendly Development Environment

Human Efficiency

In order to allow easier development of complex programs, in addition to an integrated Windows-based development environment, the new PLCs are equipped with a variety of instructions. Structured programming functionality has been improved to allow programs to be reused with greater efficiency and thereby reduce labor requirements and cut costs.

Efficient Use of Valuable Assets

Heritage

The know-how that our customers have accumulated through the years forms the core of their competitive strength. At OMRON, we believe in enhancing this knowhow to the utmost. The key to doing this is 100% upward compatibility. CS1 PLCs allow existing Units and programs to be used without any changes.

Use the improved SYSMAC CS1 PLCs to scale advanced systems to the optimum size.

1

Wide Lineup Makes It Easy to Build the Optimum System

A total of nine CPU Unit models provide for a wide range of applications, from small-scale systems to large. The lineup also includes Memory Cards, Serial

Communications Boards, and a wide selection of Special I/O Units that can be used with any CPU Units to flexibly build the system that meets the requirements.

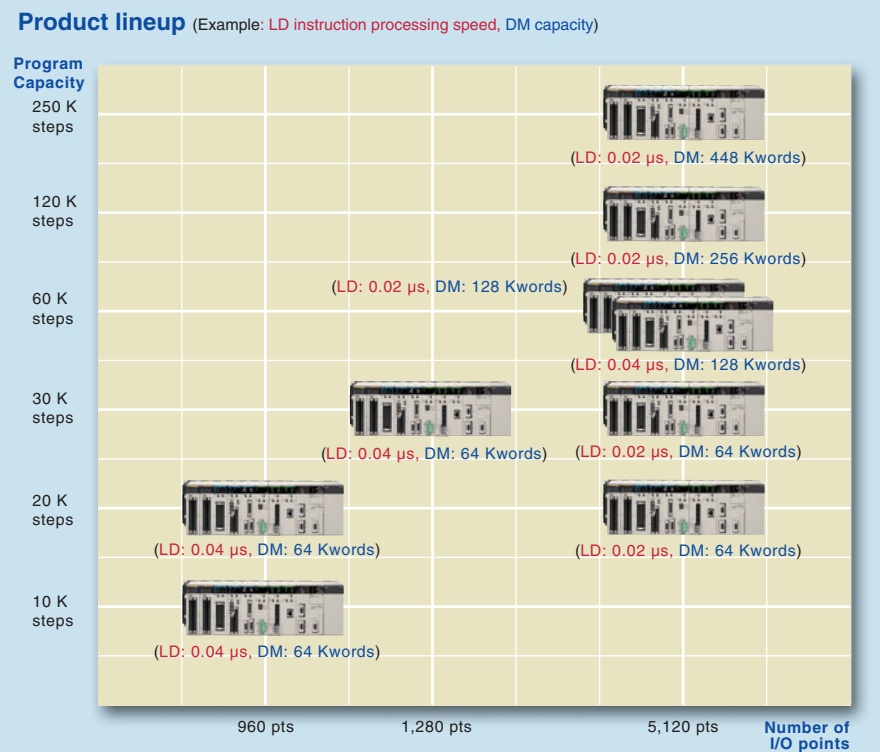

Control Up to 960 Points with Units Mounted to the CPU Rack

The CS1 provides a high level of space efficiency. As many as 960 I/O points can be controlled by simply mounting ten Basic I/O Units, with 96 I/O points each, to the CPU Rack. Alternatively, as many as 80 analog I/O points can be used by mounting five Analog Input Units and five Analog Output Units.

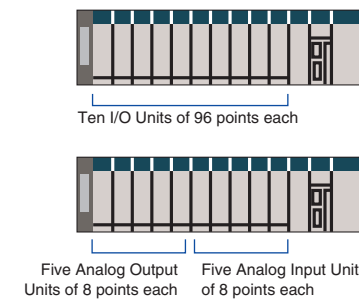

Large Capacity CPU Units for Greater Component Control Power

The CS1 CPU Units boast amazing capacity with up to 5,120 I/O points, 250 Ksteps of programming, 448 Kwords of data memory (including expanded data memory) and 4,096 timers/counters each. With a large programming capacity, CS1 PLCs are not only ideal for large-scale systems but easily handle value-added applications and other advanced data processing.

System Bus Baud Rate Doubled

The data transfer rate between the CPU Unit and certain Units has been doubled to further improve total system performance.

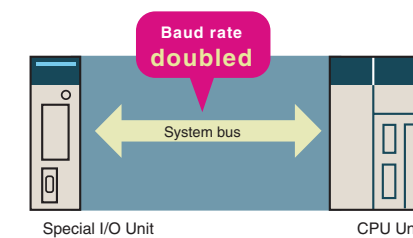

Improved Refresh Performance for Data Links, Remote I/O Communications, and Protocol Macros

In the past, I/O refresh processing with the CPU Bus Unit only occurred during I/O refresh after instructions were executed. With the new CS1, however, I/O can be refreshed immediately by using the DLNK instruction. Immediate refreshing for processes peculiar to the CPU Bus Unit, such as for data links and DeviceNet remote I/O communications, and for allocated CIO Area/DM Area words when instructions are executed, means greater refresh responsiveness for CPU Bus Units.

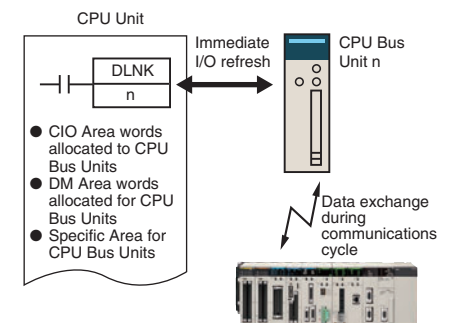

Unit name	Refresh function
Controller Link Unit	Data links
DeviceNet Unit	Remote I/O
Serial Communications Unit	Protocol macros
Ethernet Unit	Socket service based on manipulation of specific bits.

Reduced Variation in Cycle Time During Data Processing

Instructions that require long execution time, such as table data processing instructions and text string processing instructions, are

processed over multiple cycles to minimize variations in cycle time and maintain stable I/O response.

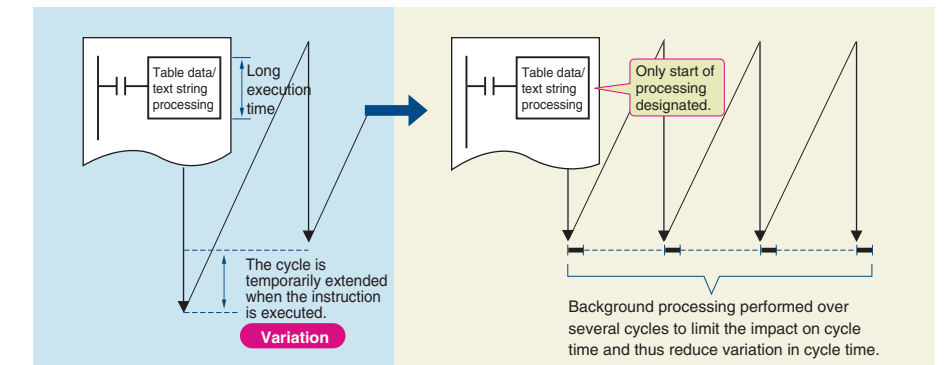

Faster Instruction Execution and Faster Overall Performance

In addition to further improvements to the instruction execution engine, which is the core of overall PLC performance, the high-speed RISC chip has been upgraded to realize the fastest instruction execution

performance in the industry. Also, the new models have a mode where instruction execution and peripheral processing are processed in parallel, enabling balanced improvements in overall speed.

● Common Processing	0.3 ms
● PCMIX Value	16
● Cycle Time (Cycle time for 128 inputs and 128 outputs)	Basic instructions only: 38 Ksteps/ms Including special instructions: 22 Ksteps/ms
● LD Instruction Processing Speed	20 ns
● OUT Instruction Processing Speed	20 ns
● Subroutine Processing Speed	2.1 μs

Two Series of Expansion Racks Up to 50 m Long for Long-distance Expansion with Up to 72 Units and 7 Racks

With an expansion capacity of up to 80 Units and 7 Racks over a distance of 12 meters, the CS1 can meet large-scale control needs. Alternatively, an I/O Control Unit and I/O Interface Units can be used to connect two series of CS1 Longdistance Expansion Racks extending up to 50 m each and containing a total of up to 72 Units and 7 Racks. CS1 Basic I/O Units, CS1 Special I/O Units, and CS1 CPU Bus Units can be mounted anywhere on the Racks and programmed without being concerned about special remote programming requirements.

Note: C200H Units cannot be mounted on the Longdistance Expansion Racks.

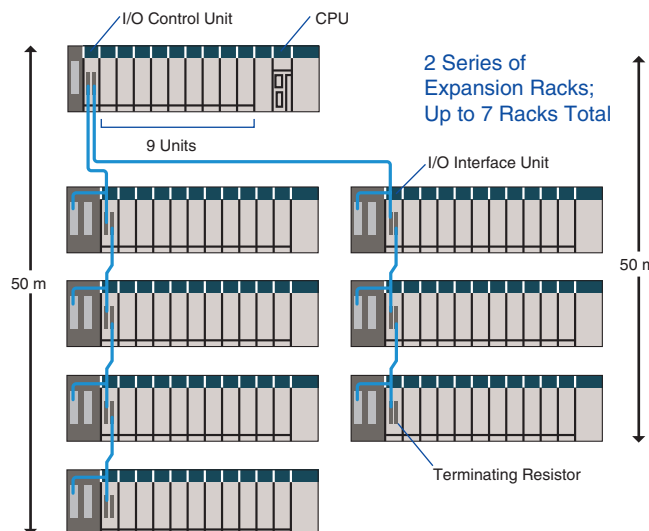

Equipped with functions demanded by the production site to suit a variety of applications.

2

Nested Interlocks (for CPU Unit Ver. 2.0 or Later)

Although strictly speaking the present interlock instructions do not allow nesting, applications can be created to include combination of complete and partial interlock conditions that achieve nested interlocks.

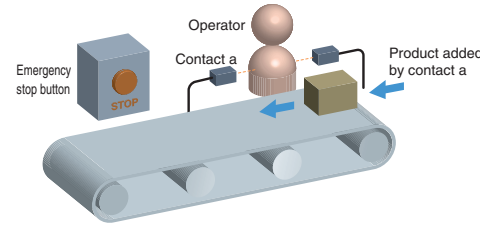

- (1) Conveyor operates
- (2) Contact "a" turns ON when operator is present and products are supplied.
- (3) When the emergency stop button is pressed, the conveyor and product addition both stop.

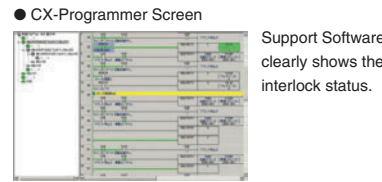
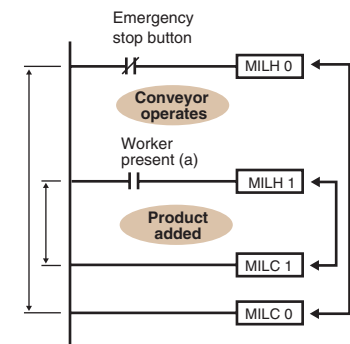

Easy Cam Switch Control with Ladder Instructions (for CPU Unit Ver. 2.0 or Later)

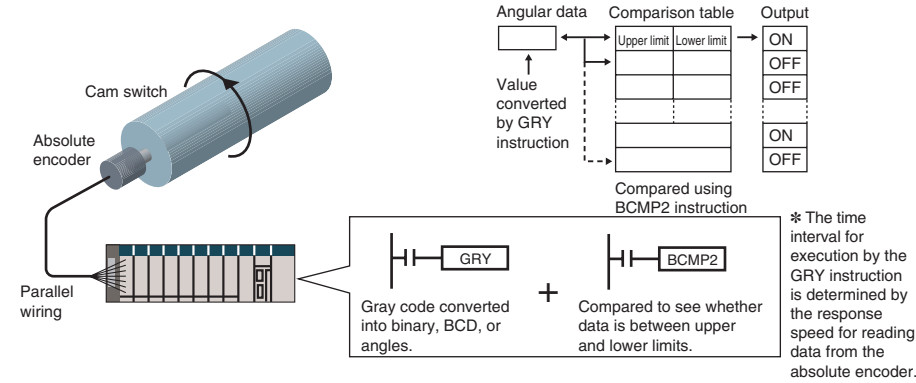

Easy Calendar Timer Function (for CPU Unit Ver. 2.0 or Later)

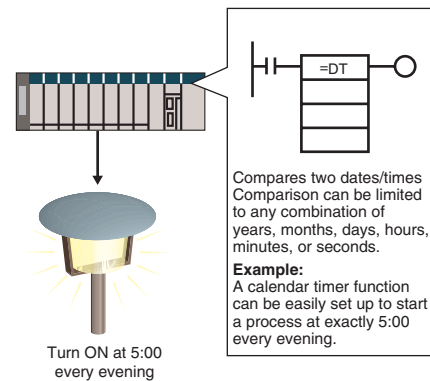

TIME-PROPORTIONAL OUTPUT (TPO) Instruction (for CPU Unit Ver. 2.0 or Later)

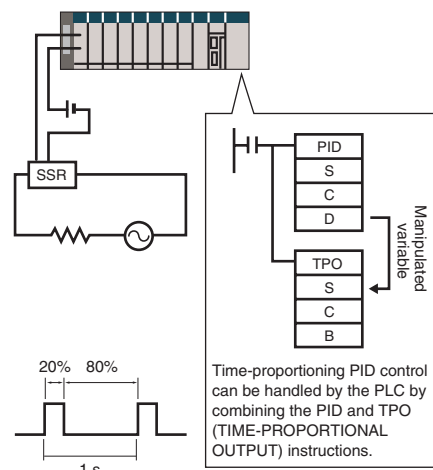

Convert Between Floating-point Decimal and Character Strings

The new CS1 can convert floating-point decimal (real numbers) to character strings (ASCII) for display on a PT (operator interface). The data can be displayed on the PT as a character string display element.

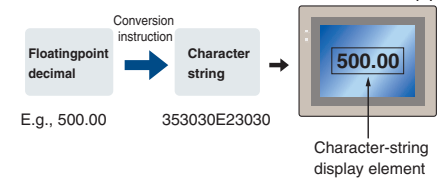

PID Autotuning

The new CS1 can autotune PID constants with a PID control instruction. The limit cycle method is used for autotuning, so the tuning is completed quickly. This is particularly effective for multiple-loop PID control.

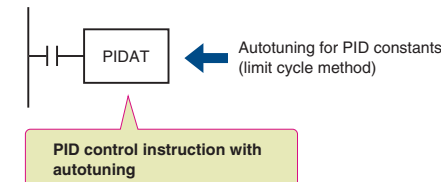

Error Status Generation for Debugging

A specified error status can be simulated by executing the diagnostic instructions (FAL/FALS). With the new CS1, debugging is simple for applications that display messages on a PT or other display device based on the error status of the CPU Unit.

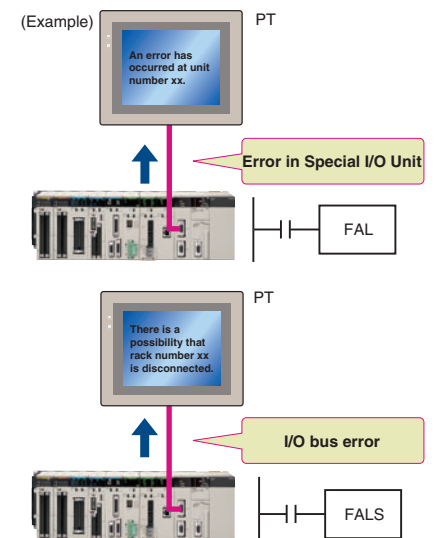

The new CS1 can convert ASCII character strings read from measurement devices by serial communications to floating-point decimal data for use in data processing.

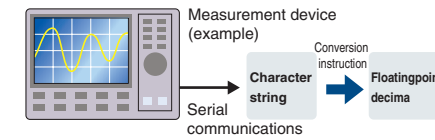

Highly Accurate Positioning with XY Tables

The new CS1 has many doubleprecision processing instructions for floating-point decimal operations, enabling positioning with greater accuracy.

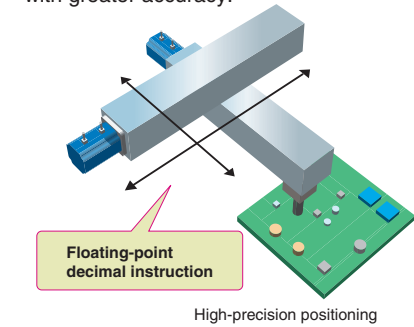

Easy Reading of Maintenance Data via CompoNet/DeviceNet

The addition of special explicit message instructions makes it easy to send explicit messages without having to consider FINS commands. Transferring data among PLCs with explicit messages is also simplified.

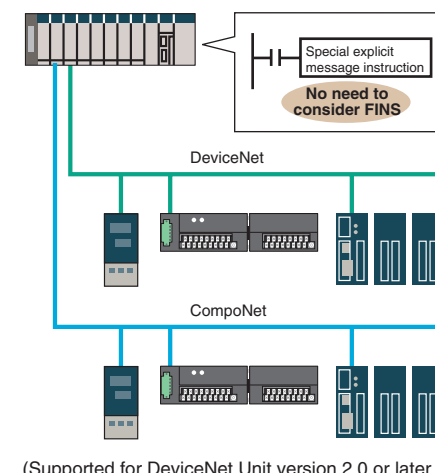

Simpler Ladder Programs

Ladder programs that use a lot of basic instructions can be simplified using differentiation instructions LD NOT, AND NOT, and OR NOT, and instructions that access bits in the DM and EM Areas.

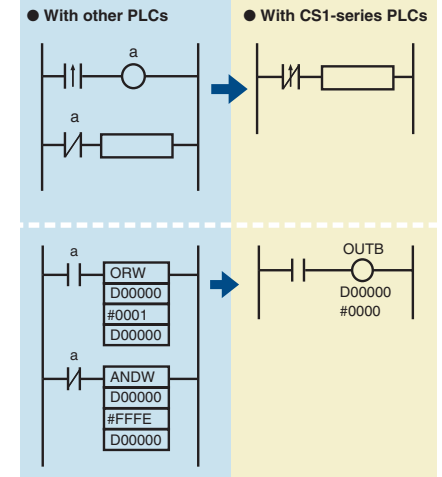

Binary Set Values for Timer/Counter Instructions

The SV for a timer or counter instruction can be specified using either BCD or binary. Using binary SV enables longer timers and higher-value counters.

Examples: Timer/Counter Instructions

- TIM (BCD): 0 to 999.0 s
- TIMX (550) (binary) 0 to 6553.5 s
- CNT (BCD): 0 to 999 counts
- CNTX (546) (binary) 0 to 65,535 counts

[Applicable Instructions] Timer/Counter Instructions

- TIMER: TIMX (550)
- COUNTER: CNTX (546)
- HIGH-SPEED TIMER: TIMHX (551)
- ONE-MS TIMER: TMHX (552)
- ACCUMULATIVE TIMER: TTIMX (555)
- LONG TIMER: TIMLX (553)
- MULTI-OUTPUT TIMER: MTIMX (554)
- REVERSIBLE COUNTER: CNRX (548)
- RESET TIMER/COUNTER: CNRX (547)

The CX-One FA Integrated Tool Package makes design, development, and maintenance easy and efficient.

3

Integrated OMRON PLCs and Component Support Software

FA Integrated Tool Package



The CX-One is an FA Integrated Tool Package for connecting, setting, and programming OMRON components, including PLCs. CS1 programming and settings can be done with just the CX-Programmer, but the CX-One provides Support Software for setting and programming PTs, Temperature Controllers, and many other components. Using the CX-One makes programming and setup easy, shortening the total lead time required for starting up machines and equipment.

CX-One Configuration

- | | |
|--|--|
| 1 Network Software | CX-Integrator CX-FLnet CX-Protocol CX-Configurator FDT Network Configurator |
| 2 PLC Software | CX-Programmer CX-Simulator SwitchBox Utility |
| 3 HMI Software | CX-Designer
The Ladder Monitor Software is included. (See note 1.)
NV-Designer (See note 2.) |
| 4 Motion Control Software | CX-Drive
CX-Motion-NCF CX-Motion-MCH
CX-Position
CX-Motion |
| 5 PLC-based Process Control Software | CX-Process Tool
Face Plate Auto-Builder for NS |
| 6 Component Software for Temperature Controllers | CX-Thermo |

Note: 1. The Ladder Monitor is required to monitor ladder programs running on CS1/CJ-series PLCs from an NS-series PT.
2. Include with CX-One Lite version 4.0 and in CX-One version 3.2 or later.

Easy Programming

Smart Input

A complete range of intuitive programming functions is provided, including instruction and address input assistance, address incrementing, and address Incremental Copy. These functions enable waste-free programming with minimal effort.

Instruction and Address Input Assistance

When you begin typing an instruction from the keyboard while in the Ladder Editor Window, suggested instructions are displayed.

All you have to do is select the instruction from the list for easy input even if you do not remember the entire mnemonic.

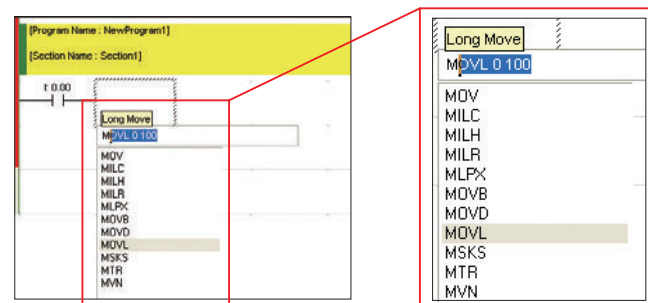

Suggested instructions displayed

Automatic Insertion of Connecting Lines

When an output or application instruction is input, the required connecting line is inserted automatically starting at the cursor location. This greatly simplifies the work required to insert lines.

Address Incremental Copy

To create the same group of ladder instructions more than once, the address incremental copy function can be used to reuse the instructions simply by inputting an address offset. Also, address offsets can be set individually and I/O comments can be created automatically.

Improved Programming Efficiency with Single-key Operation

The CX-Programmer features the "Single-key Concept" to increase operability. Apart from inputs to ladder diagrams, history searches, and model jumps, single-key operation can be used for simulation debugging as well.

Single-key Inputs

The allocation of shortcut keys can be checked in the guidance for ladder input key operations. Key inputs, such as the **C** Key for NO input conditions, the **O** Key for OUTPUT instruction, and the **I** Key for special instructions are convenient when programming.

Just press the **C** Key and enter the bit number and comment to complete the input condition. Special instruction can be input as shown in the following figure.



Lines can be easily connected using key operations.

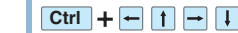

Single-key Searches and Jumps

Search functions, such as Find Back (searching for input conditions or outputs with the same address) and Find Address can be executed with a single key.

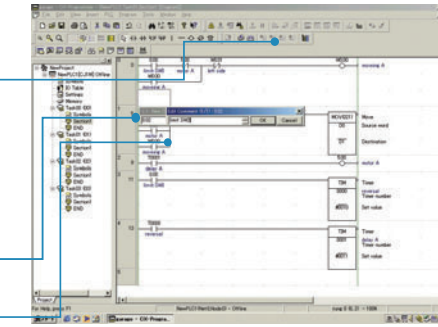

Single-key Simulation

Simulation and debugging of a PLC program can also be executed with a single key. Applications using both a PLC and Programmable Terminal can be debugged using a computer without the actual devices using PLC-PT Integrated Simulation.



Icons for the simulation function can be accessed directly.

Debugging

Management of Multiple Networks

The operation of networks with configurations consisting of multiple networks including PLC networks such as EtherNet/IP and Controller Link, field networks such as DeviceNet and CompoNet, and networks for Programmable Terminals and Serial Devices, can be restored simultaneously from the CX-One. Onsite start up and debugging can be conducted efficiently and without errors because PLCs and devices can be selected from the window to transfer programs and parameter data to the computer during operation.

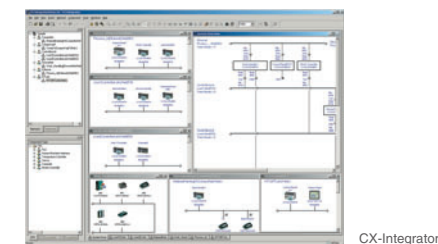

Ladder diagram Monitoring for Multiple PLCs

Multiple PLCs can be monitored by displaying them in series on the screen. This way it is easy to debug data links between PLCs and monitor the inputs and outputs of different PLCs.

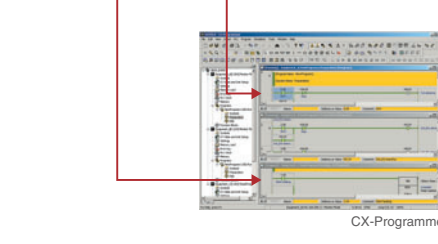
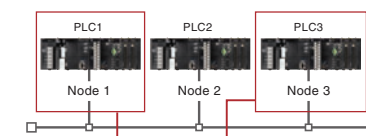

Time Require for Debugging and Maintenance Has Been Reduced with the Comprehensive Data Trace Function

Functionality and operability has been significantly upgraded compared to the previous data trace function. The new data trace function provides comprehensive debugging, such as I/O comment display of sampled addresses, specification using symbols, checking the measurement time between two selected points, and layering waveforms. Furthermore, data sampled from the CPU Unit's trace memory can be saved to a file on the computer at a specified frequency. This can be used as for long-term logging of data.

Data Trace Function

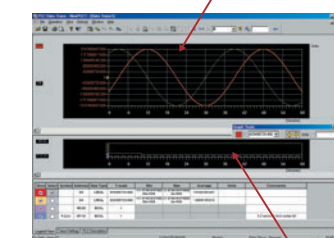

The traced waveforms can be displayed as layers.

Sampled value from a specific input bit will be displayed.

Multiple Languages Can Be Combined To Make Programming Flexible

The multilingual feature supports IEC 61131-3. Programming is possible in a language that is appropriate for the process by combining ladder diagram and ST languages. Function blocks can be created to make programming even more efficient.

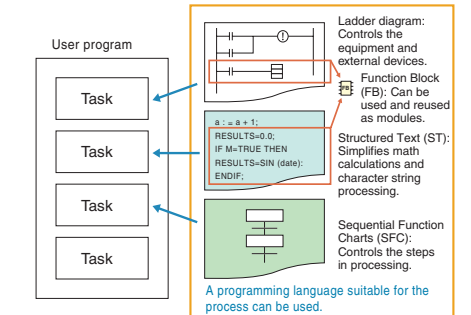

OMRON FB Library, SAP

Ladder diagrams, communications programs, and control screens can be created simply by selecting and pasting program modules from the extensive libraries. Using FB and SAP modules to build the programs, it is possible to create programs that are easier to understand.

Batch Backup

Batch Backup/Restore with a Computer

A computer can be used to backup, compare, or restore data for all or specific PLC Units when connected online. Backup information is automatically tagged with a date stamp. It is thus possible to return to the state before an error occurred. It is also easy to identify the file for restoring data when an error occurs.

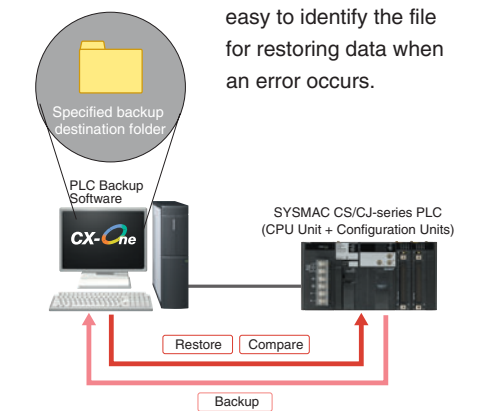

Further improvements to communications functions. Seamless networks increase production site transparency.

4

High-speed, High-capacity Data Links between PLCs via EtherNet/IP

EtherNet/IP is supported. EtherNet/IP is a global-standard network that uses cutting-edge general Ethernet technology for control and information network integration. This enables data links between PLCs, data links between a PLC and multi-vendor devices, and communications between PLCs and PTs over a general Ethernet network.

CompoNet Greatly Advances Wiring Reductions, Greater Information Handling, and Standardization

CompoNet is a multi-vendor network for bit-level control of approximately 1,000 points in 1.0 ms. It supports message communications at the sensor and actuator levels. Maintenance information can be controlled in each Slave for preventative maintenance of equipment.

Flexible System Building Based on the DeviceNet

The CS1 Series supports the worldwide multivendor bus standard, DeviceNet. Component connections in a multivendor environment are greatly enhanced by connecting to up to 64 nodes for a wide range of FA applications, and by device profiles and configurator tools that ensure high reliability and easy maintenance. Production systems can be configured even more flexibly by incorporating products such as the MULTIPLE I/O TERMINAL.

Functions for Better Ethernet Support

Ethernet is becoming increasingly important standard for information networks. Up to eight socket interfaces for TCP/IP and UDP/IP are supported, in addition to FINS messages, FTP file transfers, and mail notification, so that production management can now be organically linked with the production site.

The Solution for Communicating across Network Levels

The SYSMAC CS1 enables FINS message communications across a maximum of eight levels (See note.) (using CX-Programmer Ver. 4.0 or higher) in comparison with three levels in previous OMRON systems. Expansion up to eight levels lets you build a

seamless communications system for sending FINS messages across multiple levels of Ethernet and Controller Link networks.

Note: For CPU Unit Ver. 2.0 or later.

A Wide Range of Systems, from Small-scale to Large

OMRON offers a full lineup of reliable PLCs including the "flagship" CS1 Series, and ranging from the small scale CP1H to the large-scale CV Series. The CS1 Series meets the needs not only of small-scale to large-scale systems, but of distributed systems as well. This allows the construction of the optimum system for the scale and applications of the production site.

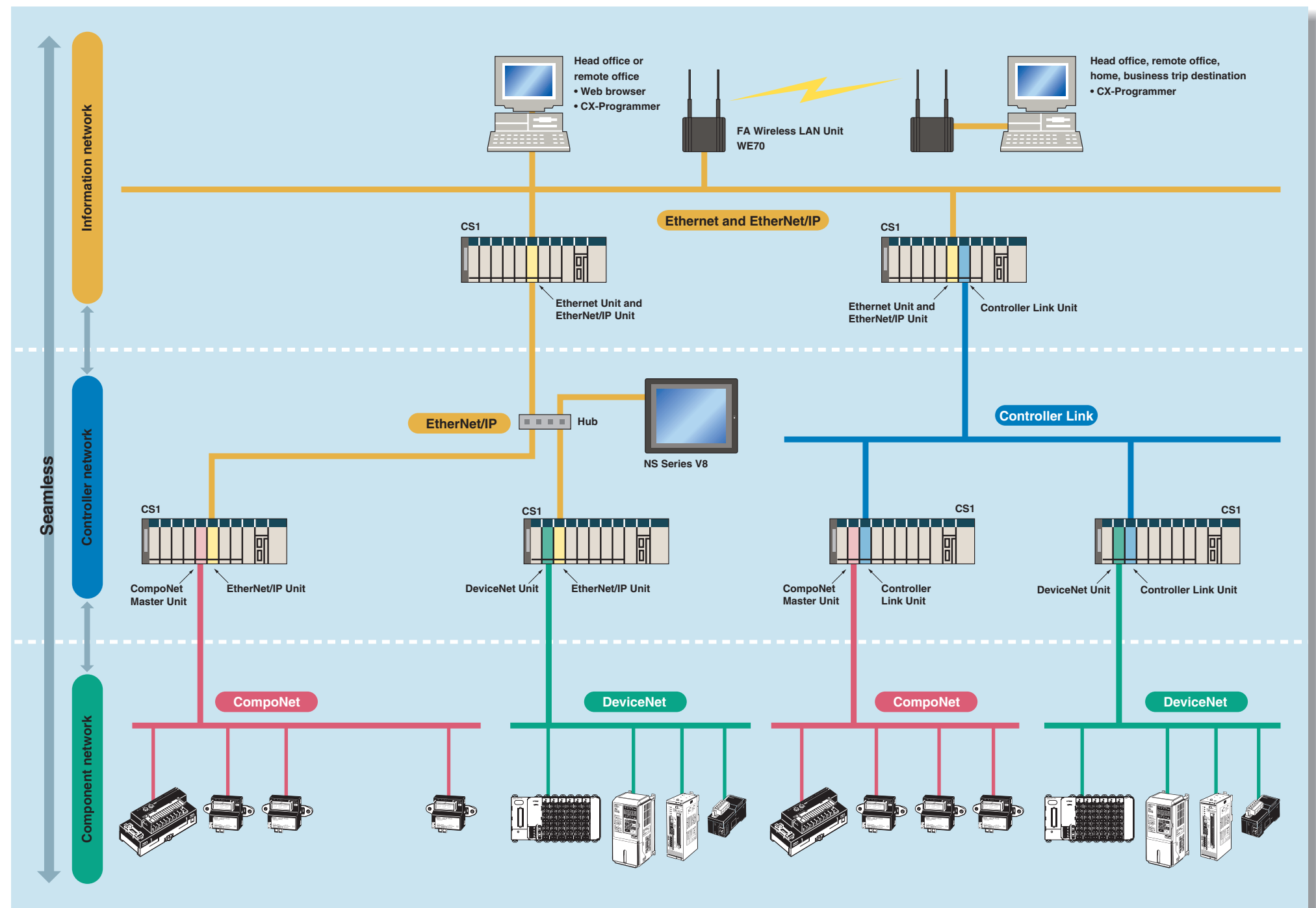

Construction of systems in multi-vendor environments simplified with Serial Gateway Function.

5

Serial Gateway (CPU Unit Ver. 3.0 or later) (Serial Communications Units/Boards with Ver. 1.2 or later)

Truly Seamless Incorporation of OMRON Components and Other Devices into Networks

When the CPU Unit (Ver. 3.0 or later) or Serial Communications Board or Serial Communications Unit (Ver. 1.2 or later) receive a FINS command containing a CompoWay/F command (see note 1.) via network or serial communications, the command is automatically converted to a protocol suitable for the message and forwarded using serial communications.

- **CompoWay/F** (See note 2.)
- **Host Link FINS** (Possible only with Serial Communications Units or Serial Communications Boards)

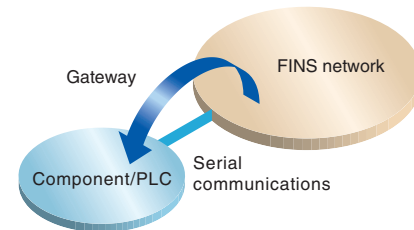

Note 1: FINS
Abbreviation for Factory Interface Network Service. A command system for message services common to OMRON networks. FINS commands can be sent across up to 8 network levels*, including serial communications paths using a serial gateway. (*Possible only with CS/CJ-series CPU Unit Ver. 2.0 or later.)

Note 2: CompoWay/F
CompoWay/F is an integrated communications protocol used for OMRON general-purpose serial communications. It is used by Temperature Controllers, Digital Panel Meters, Timer/Counters, Smart Sensors, Cam Positioners, Safety Controllers, etc. (as of July 2004).

Serial Gateway System (Reference)

When CompoWay/F commands are enclosed in FINS commands and sent to Serial Communications Boards or Serial Communications Units (Ver. 1.2) or serial ports on CPU Unit Ver. 3.0, the enclosed CompoWay/F command is retrieved using a Serial Gateway Function and sent as a CompoWay/F command.

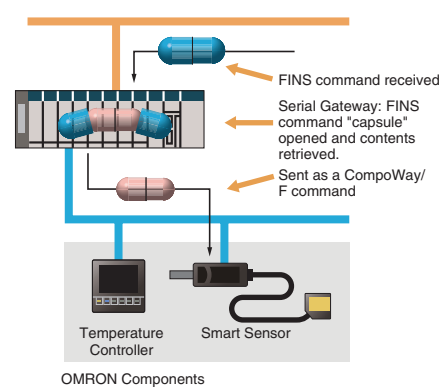

More Ports for Even More Serial Device Connections

Protocol macros make it easy to create serial communications protocols (communications frames, error checks, retries, error processing, etc.) to match those of remote communications devices. Multiple ports are provided for this function. Each PLC supports up to 16 Serial Communications Units (32 ports total) and one Serial Communications Board (with 2 ports). This makes it possible to connect up to 34 devices with serial communications at a speed of 38.4 Kbps. Message length has been increased from 256 to 1,000 bytes to give communications more power than ever before.

Windows-based Software Simplifies Serial Device Connections

Protocol macros for Serial Communications Units and Boards can be created using the CX-Protocol, thus enabling message tracing and greatly reducing the time involved in connecting various serial devices.

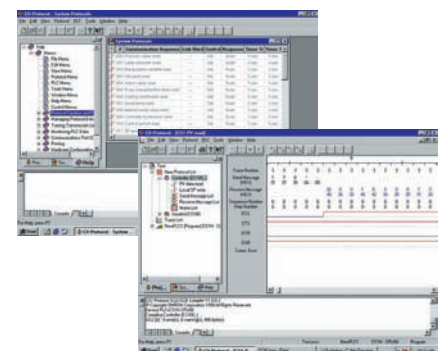

Enhanced Protocol Macro Functionality

(Serial Communications Units/Boards with Ver. 1.2 or later)

- Baud rate increased from 38,400 bps to 57,600 bps for faster communications.
- Standard system protocol added for greater connectivity with components and PLCs.
- **CompoWay/F Master**
- **Host Link Master functions**
- **Mitsubishi Computer Link Master**

Wide Range of Applicable Protocols Allows for High Value-added Programs

The CS1 Series supports a wide range of serial communications protocols, such as Host Link, no-protocol, NT Link, peripheral bus, and more. These allow for high value-added programs such as MMI, communications, and data processing.

The Fastest Communications in the Industry with High-speed NT Links

Combine with one of the NS Series Programmable Terminals (NS12, NS10, or NS7) to enable connecting Highspeed NT Links. Using NT Link terminology together with a communications speed of 115 Kbps provides high-speed response.

NT Links (1:N Mode)

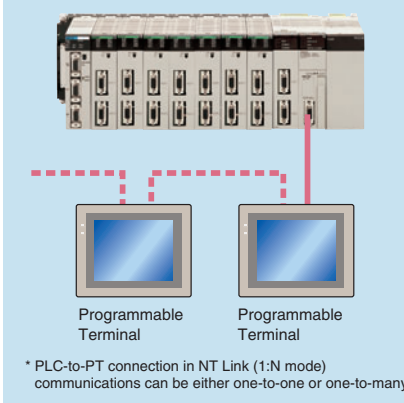

Serial Communications Configuration Example

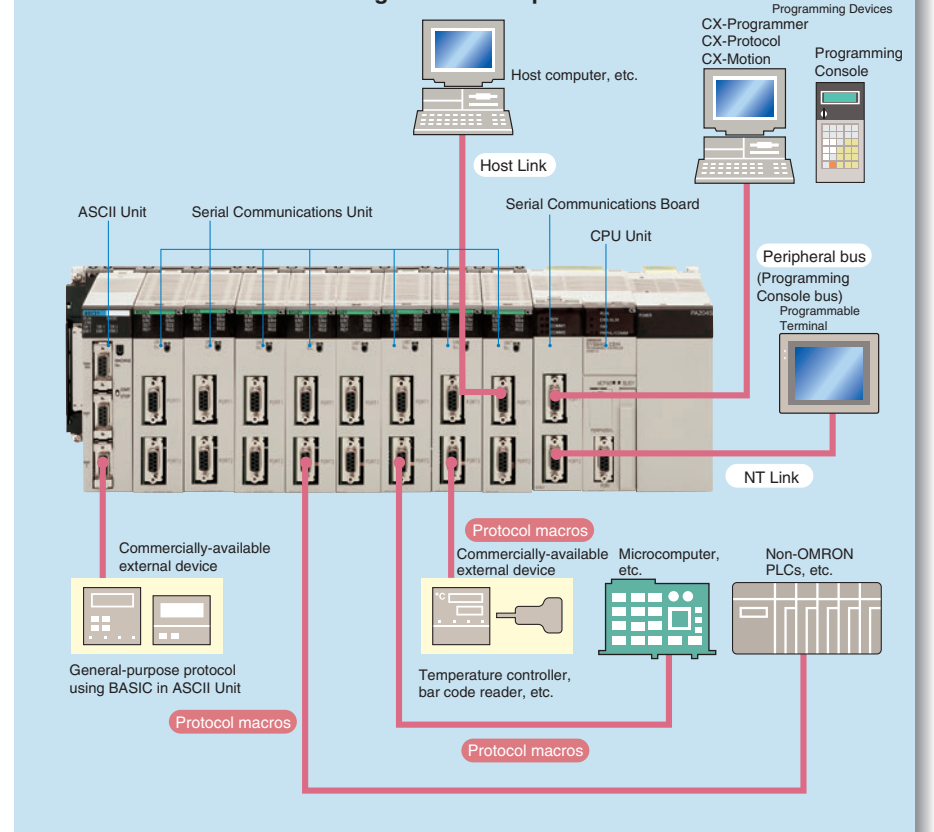

Host Links

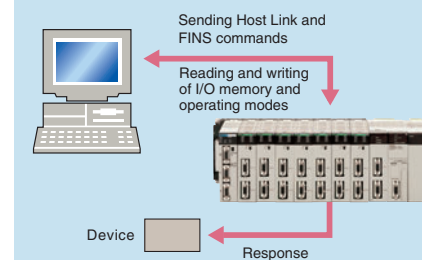

No-protocol

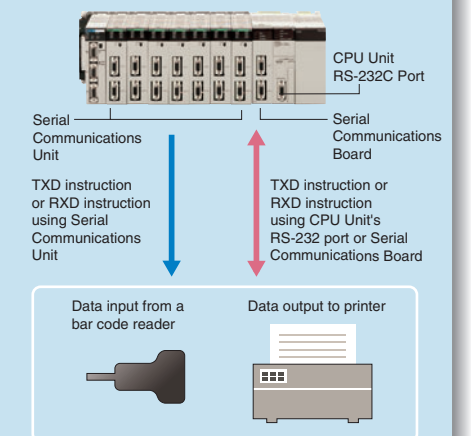

Supports No-protocol Communications

- (Serial Communications Units/Boards with Ver. 1.2 or later)
- No-protocol communications supported for Serial Communications Units and Serial Communications Boards.
 - This mode enables components to be connected to multiple communications ports using no-protocol communications.
 - Serial port I/O instructions executable using no-protocol communications from Serial Communications Units and Serial Communications Boards (TXDU, RXDU, TXD, and RXD) are supported for CPU Units with Ver. 3.0 or later.

Advanced management and resource inheritance providing powerful support for maintenance and operation.

6

Remote Maintenance

1. Program or monitor a remote PLC via a modem connection.
2. Program or monitor a network PLC via a Host Link connection.
3. Send e-mail for errors from PLCs connected to Ethernet.

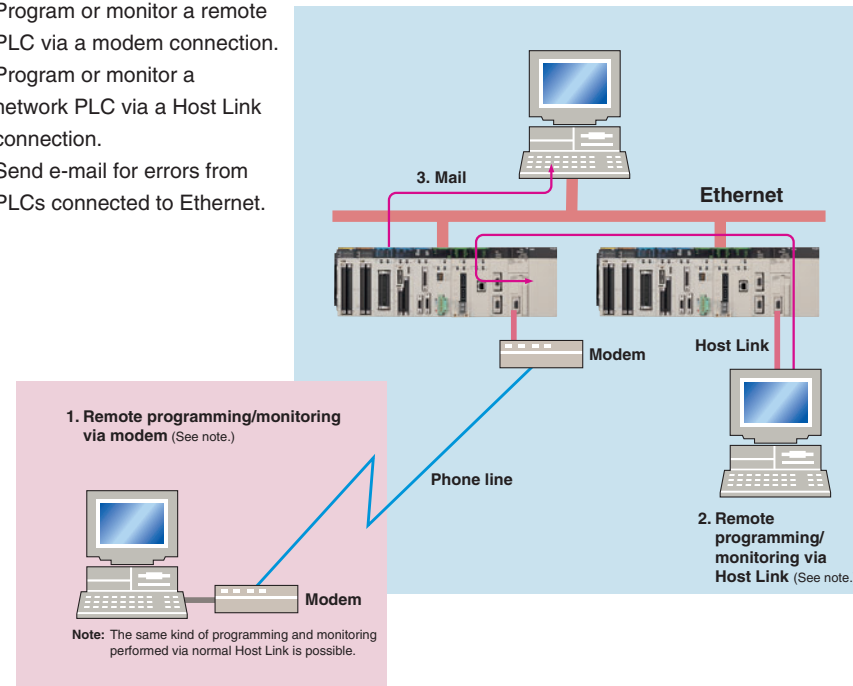

Memory Cards for Data File Management

User programs, I/O memory, or system parameters can be converted to Windows-based files and stored in Memory Cards or in EM file memory in the CPU Unit. It is also possible to automatically read the user program and other data from the Memory Card to the CPU Unit at startup, replacing ROM operation. Change programs on-site using only a Memory Card and Programming Console, or use Memory Cards to store symbol tables or I/O comments. Connecting a Programming Device allows monitoring operations with ladder programs with comments. It is also possible to save and read data such as DM data to a Memory Card during operation, and the Memory Cards are ideal for operations such as saving quality data and reading recipes.

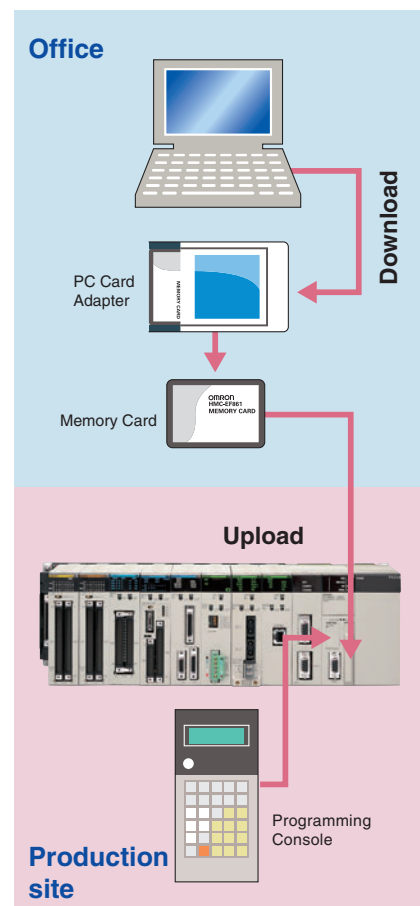

Boost Program Security by Keeping Part of It Hidden (for CPU Unit Ver. 2.0 or Later)

You can prevent access to special tasks by requiring the user to have a password to read them.

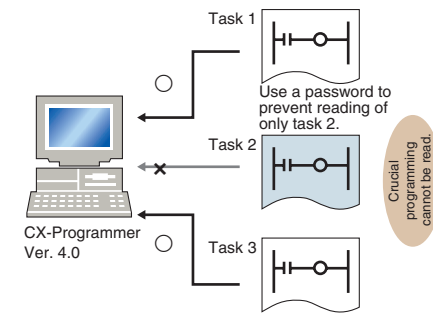

This allows you to hide crucial parts of the program.

By applying write protection, you can also prevent a user from inadvertently writing over the hidden part of the program. This provides additional protection for your program.

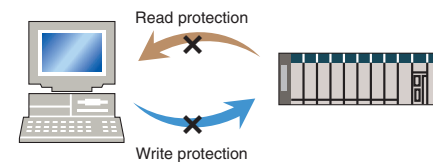

Internal Flash Memory-based Battery-free Operation

Flash memory (non-volatile memory) is built into the new CS1's CPU Unit. User programs and system parameters (e.g., PC Setup and data link tables) are automatically saved to this flash memory. This means that the new CS1 can operate without a Memory Card and battery.

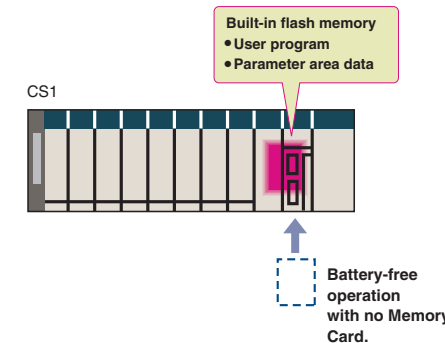

Prevent Information Leaks from PLCs (for CPU Unit Ver. 2.0 or Later)

In addition to applying read protection functions to the user program area and tasks, you can also protect against the transfer of user programs to a Memory Card. This prevents leaks of proprietary information by completely protecting against the reading of programs inside the PLC.

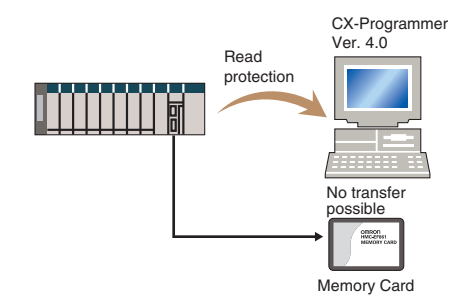

Easy Replacement of Existing Models

Programs designed for existing models (C200HX/HG/HE, CVM1, or CV-series PLCs) using the CX-Programmer can be converted for use with the new CS1. The following functions are available to make the conversion to the new CS1 even easier.

- CV-CS address conversion instruction to convert programs designed for the CVM1/CV that include internal I/O memory addresses.
- C200HX/HG/HE: Region comparison (ZCP and ZCPL) instructions.

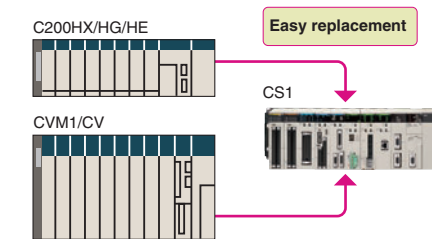

Store All I/O Comments, Symbol Names, Rung Comments, and Other Information in CPU Unit Comment Memory (See note.) (Unit Ver. 3.0 or later)

When downloading projects, the Memory Card, EM file memory, or comment memory (in the CPU Unit's flash memory) can be selected as the transfer destination for I/O comments, symbol names, rung comments, and other data. This enables data such as

Write Protection from a Specific Node over the Network (for CPU Unit Ver. 2.0 or Later)

You can now stop specific nodes from writing over the network. By preventing unintentionally writes to the PLC while monitoring data over the network, you can prevent potential problems.

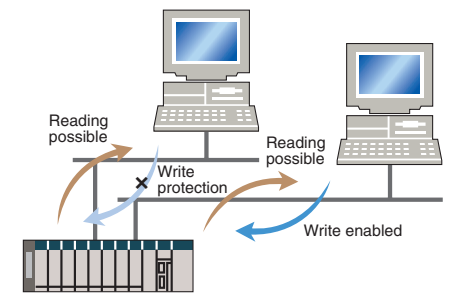

Replace Malfunctioning Units without Turning OFF the Power (Online Unit Replacement)

When an I/O Unit, a Special I/O Unit, or a CPU Bus Unit is malfunctioning, it is now possible to replace the faulty Unit while the system continues operating. This is particularly effective for systems that cannot be stopped when a problem has occurred in another part of the system.

(This function requires a CS1D-CPU□□S, CPU Unit, a CS1D-BC082 or CS1D-BI092 Backplane, and a CS1D-PA207R or CS1D-PD024 Power Supply Unit.)

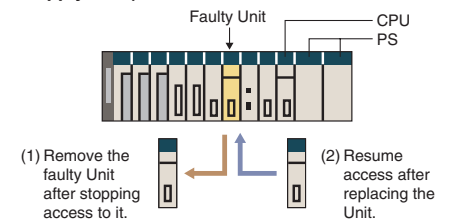

Note: CX-Programmer Ver. 5.0 or higher required.

The CS1 Duplex System Boosts the Reliability of Facilities and Equipment

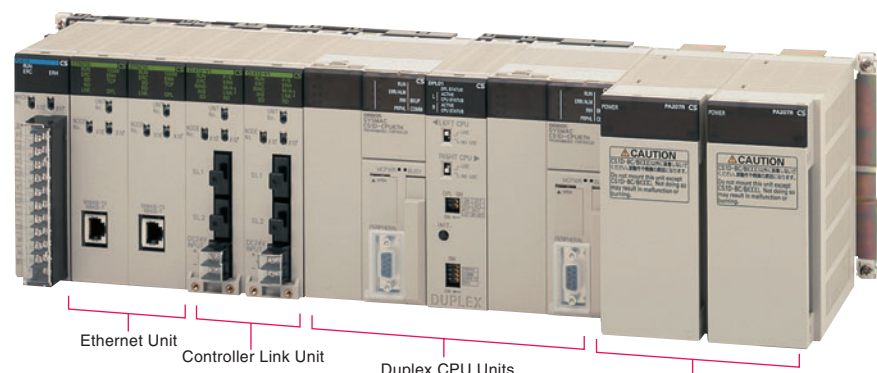

- Communications Units can be either duplexed or used individually.
- Power Supply Units can be either duplexed or used individually.

Hot Standby System Adopted for CPU Unit Duplexing

- When a problem occurs in the CPU Unit, the system instantly switches control to the other CPU Unit, enabling continuous operation with minimal effect on the system.
 - Because there is no need for special duplex programming, the design process is simple and design steps are reduced.
- The system can also be configured with only one each of the CPU, Power Supply, and Communications Units. This lets you optimize the system cost by selecting the Units that you need. (The Duplex Unit must be used even when using only one each of the CPU, Power Supply, and Communications Units.)

Online Unit Replacement

With either a Duplex-CPU or Single-CPU CS1D System, Basic I/O Units, Special I/O Units, and CPU Bus Units can be replaced online while the system continues operation. Although operation will stop for the Unit being replaced, all other Units will continue operation.

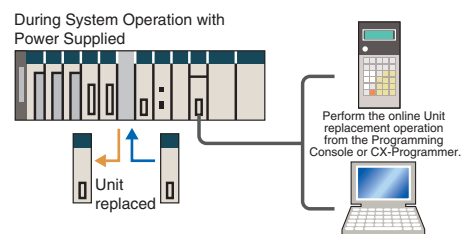

Duplex operation is possible for any or all of the following: CPU Units, Power Supply Units, and Communications Units.

Use duplex operation for the CPU Unit, power supply, or communications depending on system requirements for reliability, costs, and functionality. For example, use duplex operation for all of

these for systems that must never go down or use duplex operation for only the power supply (which has a relatively short service life). Just build in the redundancy required by the system.

Increase the Reliability of Information with Duplex Networks

Duplex Ethernet for Greater Information Network Reliability

With redundant networks and Communications Units, communications will continue even if a network line is broken or one of the Communications Units fails. The communications path is automatically

selected for each communications process (as opposed to switching the entire line), to enable creating a highly reliable network even against a network line broken in more than one location.

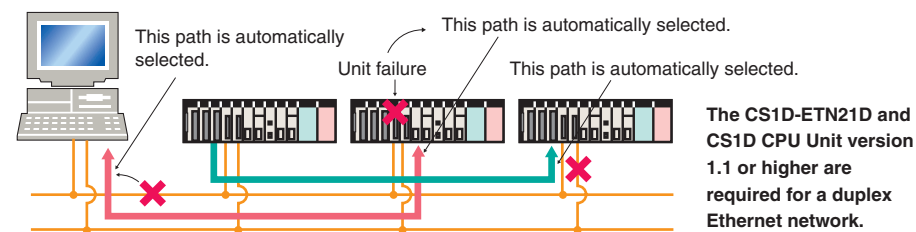

Duplex Networks between PLCs with Controller Link

Even if one Unit fails, the other Unit will back it up and continue communications. Even if a line breaks, a loopback will be used to maintain the network.

Either the CS1W-CLK13 or CS1W-CLK53 is required for a Duplex Controller Link network.

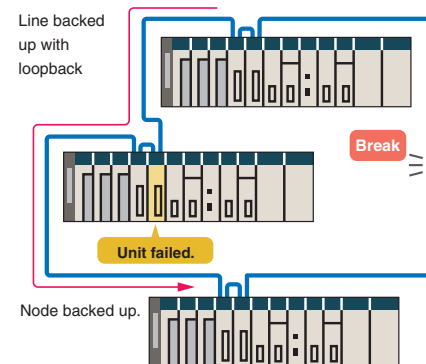

Program without Being Concerned with Duplex Operation

No special programming is required to use duplex communications with the CS1D, making it simple to design programs for duplex systems.

- The complex programming required in previous applications for duplex communications with Ethernet is eliminated.

Previously it was necessary to program operation for both Ethernet Units.

Just program the operation as if for one Ethernet Unit, and the PLC will determine the destination and send the message.

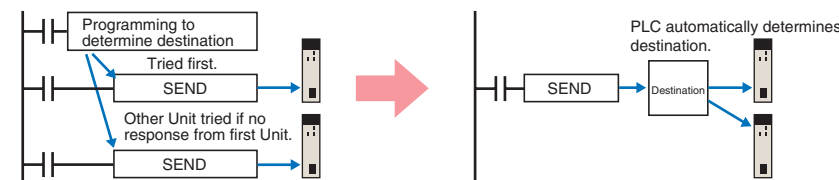

- Controller Link networks enable allocating data link areas without wasting memory.

Previously, twice the memory was required to implement data links for two Controller Link Units, and it was necessary to determine which data could be used.

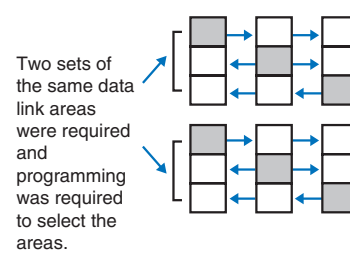

Just create the data links for one Controller Link Unit to eliminate wasted data memory. The Duplex Controller Link Units share the data links.

Expansion Cables and Expansion Backplanes can be duplexed and replaced online.

Expansion Cables can be duplexed and replaced online.

By mounting Duplexed Expansion I/O Units and Expansion Cables, the Expansion Cables can be replaced during operation. In addition, problems such as cable disconnections are monitored, so the location of the failure can be easily identified.

Expansion Backplanes can be added online.

- Even in systems where the power cannot be turned OFF or operation cannot be stopped, it is easy to add functions after system operation has started.
- Modifications can be easily made after startup for devices for which the power is not easily turned OFF.

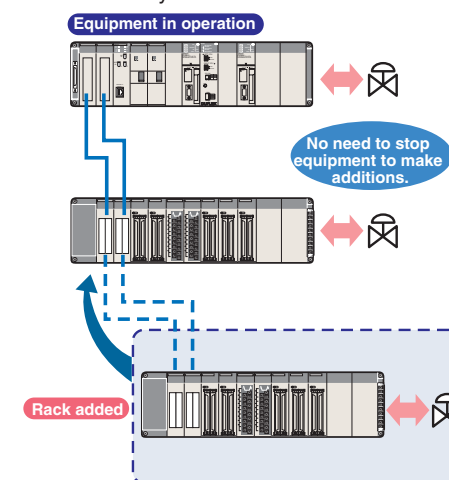

Initial and maintenance costs are reduced.

Allows effective use of software assets.

The same support software can be used in systems combining the CS1 and CJ1 Series, and all software programs and data are compatible. Their application and reuse are extremely easy. There is also no need for ladder programs for duplexing. This means that when converting an existing system to a Duplex System, there is almost no need to revise ladder programs.

Complete compatibility among Units.

The CS1D Duplex System is fully compatible with the I/O Units of the entire CS Series. Accordingly, the same Units and materials can be used for restoring the system and conducting maintenance. There is no need to purchase different Units and materials for each system, making the CS1D Duplex System highly economical. (C200H Units, however, cannot be used with CS1D PLCs. Refer to user documentation for details.)

Refer to CS1D Catalog (Cat. No. R103) for details.



Machine performance improved with high-speed, high-precision, flexible motion control.



● Position Control Unit with MECHATROLINK-II interface

Single Cable Connection and Flexible Routing!

With MECHATROLINK-II*, the Servo Drive can be easily connected with a single cable (2-core shielded twisted pair cable). The wire savings over the total length of 50 m (or 30 m for 16 axes) enables Racks to be more freely located.

Time Saved in Startup and Maintenance

Servo Drive parameters can be set from the PLC. Settings and adjustments can be made from one location, without connecting the Support Software to individual Servo Drives. In addition, Servo Drive alarm status, speed, and torque monitoring can be centralized at the PLC.

● Position Control Units

Two Types of Outputs and Control of 1, 2, or 4 Axes

Select from 1-axis, 2-axis, and 4-axis models with either open-collector output or line-driver output to suit a number of different applications.

A Variety of Positioning Functions

There are 2 operating modes: direct operation (position, speed, acceleration, and deceleration data specified from the ladder program), which is effective for setting target positions, speeds, and acceleration rates immediately or during operation, and memory operation, where fixed patterns are stored beforehand in the Unit and used for operation. There are also a variety of positioning functions, such as interrupt feeding, which is effective for feeder control, and forced interrupt, which is useful in emergencies.

● Motion Control Unit with MECHATROLINK-II interface

Easy System Construction

Up to 30 physical axes and two virtual axes, making a total of 32, can be controlled, and the servo interface is handled by high-speed servo communications (MECHATROLINK-II*). This makes it possible to control multiple axes with less wiring.

Easy Data Control

High-speed servo communications lets you read programs and parameter settings from CX-Programmer on a PC. You can also read and track the operating status of parameter settings inside the Servo Driver.

Easy Motion Control

Motion control, including positioning, synchronizing (electronic gears, electronic cams, tracking), speed, and torque control, can all be handled by the CS1. Eight motion tasks can be used for simultaneous motion program execution.

● Motion Control Units

Easy Programming with G Language and Multitasking

The Motion Control Units use G language to ensure easy programming. The Units have a large programming capacity of up to 100 programs and 2,000 program blocks, and allow independent operation of 4 tasks.

High-speed Interlocks

Interrupt programs can be executed from the motion control program using D codes (interrupt codes). Easy, fast interlocks ensure greater production efficiency. Synchronous control (electronic gears, electronic cams) is also possible.

● Customizable Counter Units

A Whole New Concept, Customizable Counter Units

A high-speed PLC with 20 I/O points, a 2-axis high-speed counter, and 2 pulse or analog outputs have all been combined into 1 Unit. The Customizable Counter Units allow easy execution of complicated applications.

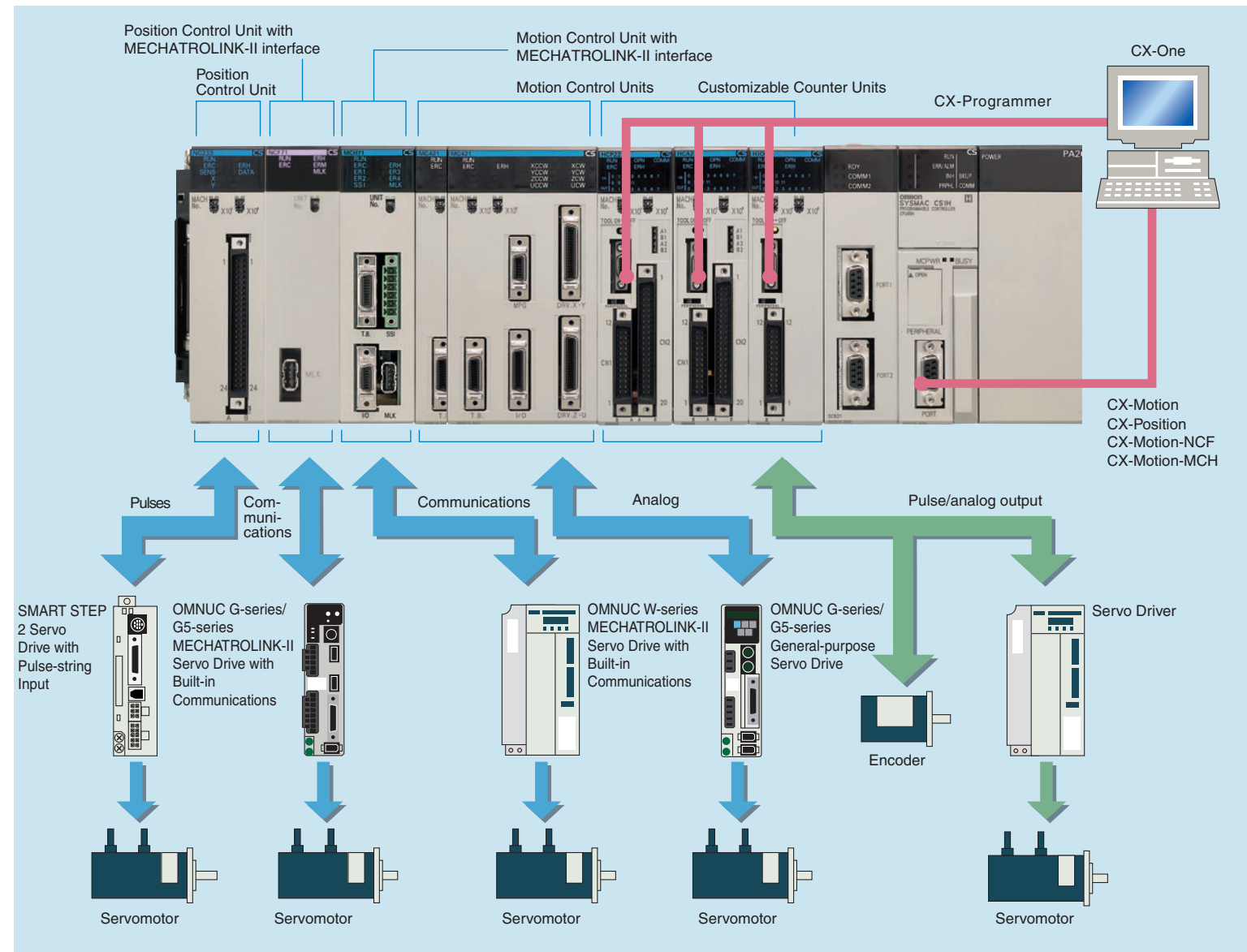
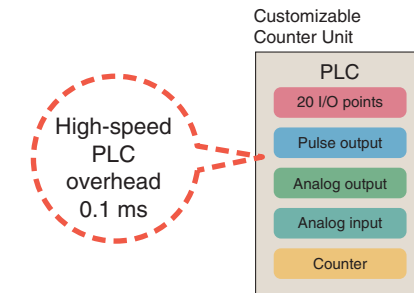

Easy Control for Bending and Pressing

It is possible to switch between speed control and torque control from the ladder program, enabling bending operation for metals and pressing operation for bonding.

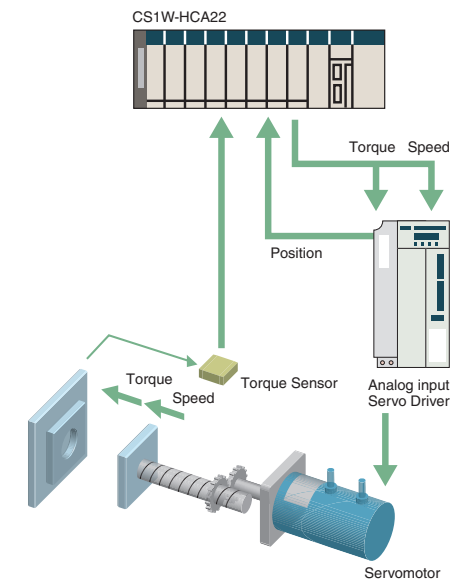

Motion Applications with High-speed Response

A wide range of interrupt functions and superior response performance enable motion applications requiring high-speed response using pulse I/O.

Note: MECHATROLINK-II is a registered trademark of the MECHATROLINK Members Association.

Smart Process Control OMRON PLC-based

Process Control brings Major Innovations to Process Automation

9



- DCS functionality in a PLC
- Analog Units with signal conversion functions
- A scalable system configuration

Down Sizing

Easy Engineering

High Reliability

- Function block programming
- Sequence programming using either step ladders or sequence tables
- A direct link to HMI products

- Duplex operation supported
- Complete maintenance functions

SMARTPROCESS CONTROL

Provides an exceptionally open environment with PLC-based process control to advance standardization and IT integration of the process control system.

Operation, Monitoring, and Data Logging

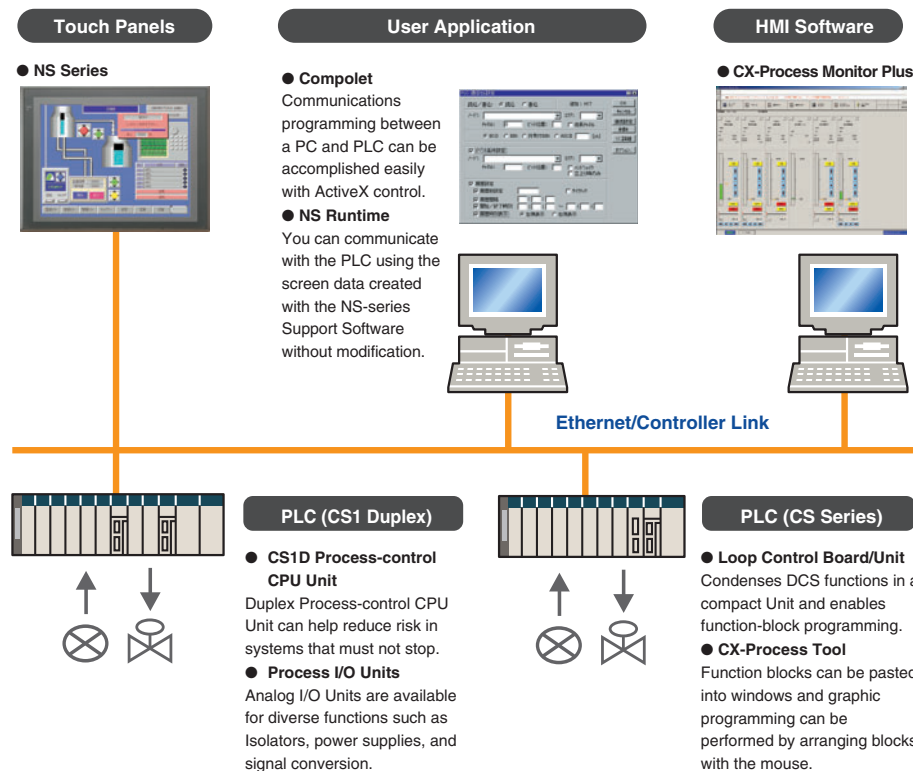

Diversified Loop Control is even easier to use. Programming becomes even easier with function-block programming.

Depending on the function block software connections, all functions such as operation block I/O combination specification can be achieved using only function blocks. Moreover, combining function blocks makes possible a wide array of control methods, from basic PID control to cascade control, feed forward control, and variable gain control.

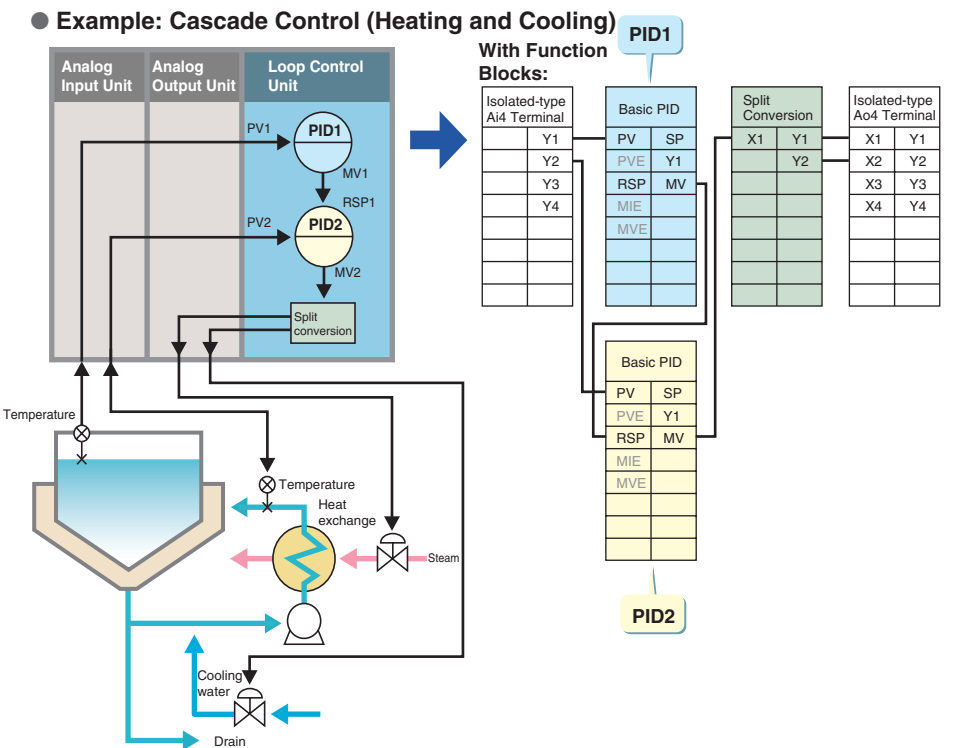

PLC-based Process Control Application Examples

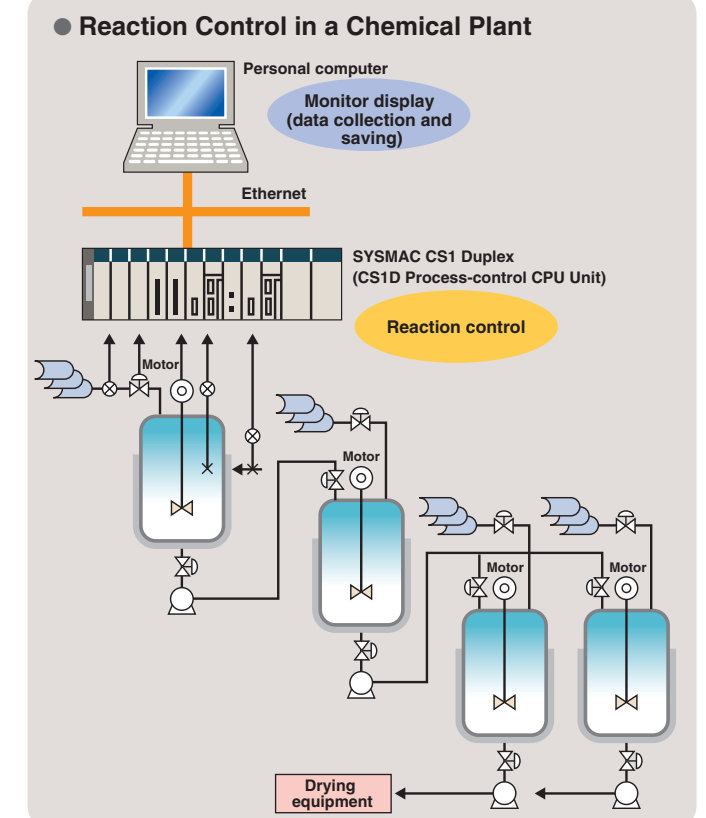
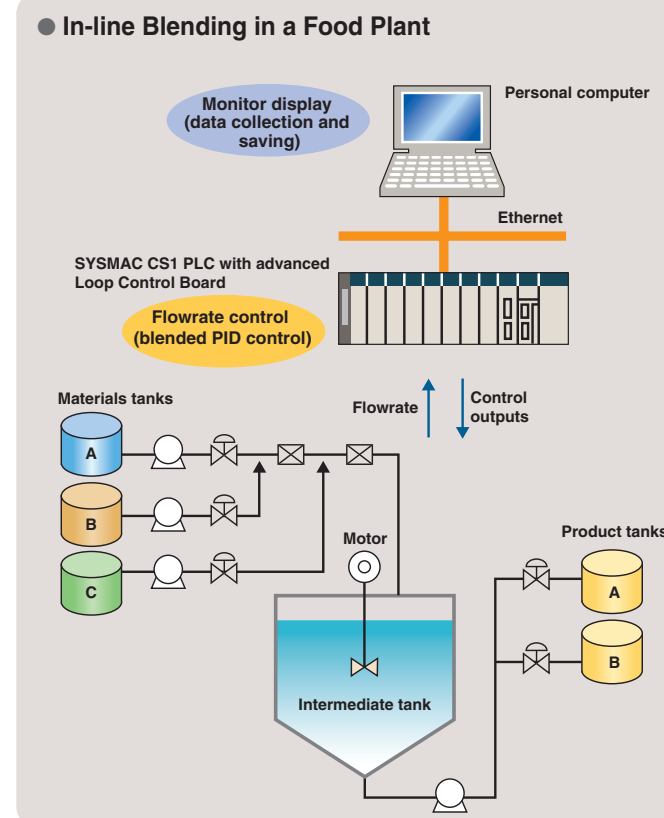

System Design Guide

System Configuration	2
Dimensions/Mounting Dimensions	9
General Specifications	11
Common Specifications for CPU Units	12
Current Consumption for Power Supply Units	15

System Configuration

Basic System Configuration

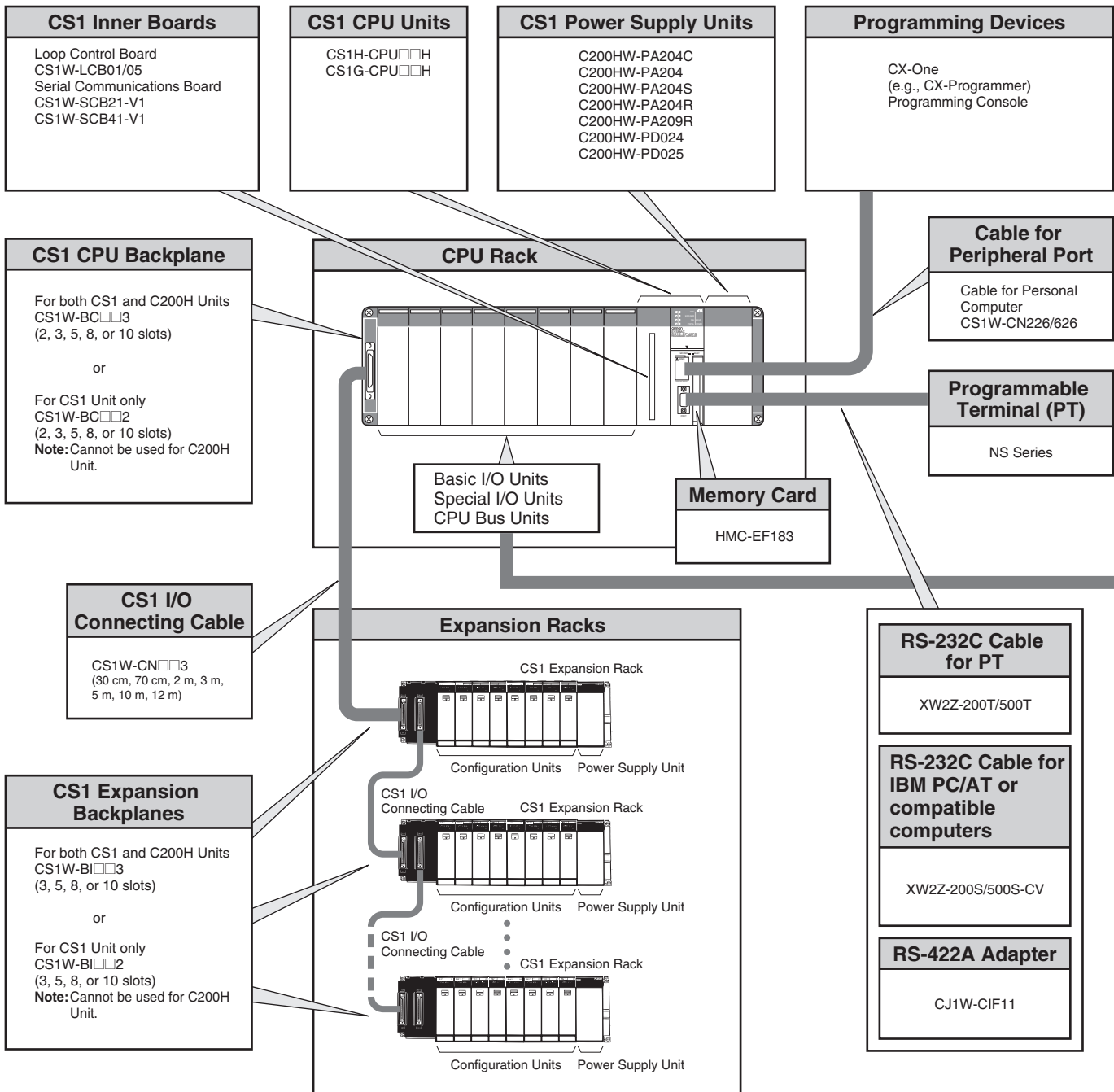

■ Configuration Units

CS1 Basic I/O Units				
8-point Units	16-point Units	32-point Units	64-point Units	96-point Units
Input Units				
---	<ul style="list-style-type: none"> ● DC Input Unit CS1W-ID211 ● AC Input Unit CS1W-IA□11 	<ul style="list-style-type: none"> ● DC Input Unit CS1W-ID231 	<ul style="list-style-type: none"> ● DC Input Unit CS1W-ID261 	<ul style="list-style-type: none"> ● DC Input Unit CS1W-ID291
Output Units				
<ul style="list-style-type: none"> ● Triac Output Unit CS1W-OA201 ● Relay Contact Output Unit (independent commons) CS1W-OC201 	<ul style="list-style-type: none"> ● Transistor Output Units CS1W-OD21□ ● Triac Output Unit CS1W-OA211 ● Relay Contact Output Unit CS1W-OC211 	<ul style="list-style-type: none"> ● Transistor Output Units CS1W-OD23□ 	<ul style="list-style-type: none"> ● Transistor Output Units CS1W-OD26□ 	<ul style="list-style-type: none"> ● Transistor Output Units CS1W-OD29□
I/O Units				
---	---	---	(32 inputs, 32 outputs) <ul style="list-style-type: none"> ● DC Input/Transistor Output Units CS1W-MD26□ (32 inputs, 32 outputs) <ul style="list-style-type: none"> ● TTL I/O Unit CS1W-MD561 	(48 inputs, 48 outputs) <ul style="list-style-type: none"> ● DC Input/Transistor Output Units CS1W-MD29□
Other Units				
<ul style="list-style-type: none"> ● Safety Relay Unit CS1W-SF200 	<ul style="list-style-type: none"> ● Interrupt Input Unit CS1W-INT01 ● Quick-response Input Unit CS1W-IDP01 	<ul style="list-style-type: none"> ● B7A Interface Units (32 inputs) CS1W-B7A12 (32 inputs) CS1W-B7A02 (16 inputs, 16 outputs) CS1W-B7A21 	<ul style="list-style-type: none"> ● B7A Interface Units (32 inputs, 32 outputs) CS1W-B7A22 	---
C200H Basic I/O Units and C200H Group-2 High-density I/O Units				
<ul style="list-style-type: none"> ● Input Units C200H-I□□□□ (Including group-2 high-density input units) 	<ul style="list-style-type: none"> ● Output Units C200H-O□□□□ (Including group-2 high-density output units) 	<ul style="list-style-type: none"> ● Interrupt Input Unit C200HS-INT01 	<ul style="list-style-type: none"> ● Analog Timer Unit C200H-TM001 	<ul style="list-style-type: none"> ● B7A Interface Units C200H-B7A□□□

CS1 Special I/O Units, CPU Bus Units, and Inner Boards			
<ul style="list-style-type: none"> ■ Temperature Sensor Input Units (Process I/O Units) CS1W-PTS□□ ■ Analog Input Units ● Analog Input Units CS1W-AD□□□□(-V1) ● Isolated-type DC Input Units (Process I/O Units) CS1W-PDC□□ CS1W-PTW01 CS1W-PTR0□ ■ Analog Output Units ● Analog Output Units CS1W-DA0□□ ● Isolated-type Control Output Units (Process I/O Units) CS1W-PMV0□ ■ Analog I/O Units CS1W-MAD44 ■ Isolated-type Pulse Input Units (Process I/O Units) CS1W-PPS01 ■ Loop Control Board CS1W-LCB0□ 	<ul style="list-style-type: none"> ■ High-speed Counter Units CS1W-CT0□□ ■ Customizable Counter Units CS1W-HCP22-V1 CS1W-HCA□2-V1 CS1W-HIO01-V1 ■ Position Control Units CS1W-NC□□3 ■ Position Control Unit with MECHATROLINK-II interface CS1W-NCF71 CS1W-NC□71 ■ Motion Control Units CS1W-MC□21-V1 ■ Motion Control Unit with MECHATROLINK-II interface CS1W-MCH71 	<ul style="list-style-type: none"> ■ Serial Communications Units/ Serial Communications Boards CS1W-SCB□1-V1 CS1W-SCU□1-V1 ■ EtherNet/IP Unit CS1W-EIP21 ■ Ethernet Unit CS1W-ETN21 ■ Controller Link Units CS1W-CLK□3 ■ SYSMAC Link Units CS1W-SLK□1 ■ FL-net Unit CS1W-FLN22 ■ DeviceNet Units CS1W-DRM21-V1 ■ CompoNet Master Unit CS1W-CRM21 ■ CompoBus/S Master Unit CS1W-SRM21 	<ul style="list-style-type: none"> ■ ID Sensor Units CS1W-V680C1□ CS1W-V600C1□ ■ GP-IB Interface Unit CS1W-GPI01 ■ High-speed Data Storage Unit CS1W-SPU0□-V2
C200H Special I/O Units			
<ul style="list-style-type: none"> ■ I/O Units (Special I/O Units) C200H-ID□□□ C200H-OD□□□ C200H-MD□□□ ■ Temperature Sensor Units C200H-TS□□□ ■ Analog Input Units C200H-AD□□□ ■ Analog Output Units C200H-DA□□□ ■ Analog I/O Units C200H-MAD01 ■ Temperature Control Units C200H-TC□□□ ■ Heat/Cool Control Units C200H-TV□□□ ■ PID Control Units C200H-PID0□ 	<ul style="list-style-type: none"> ■ High-speed Counter Units C200H-CT□□□□(-V1) ■ Cam Positioner Unit C200H-CP114 ■ Position Control Units C200HW-NC□□3 ■ Motion Control Units C200H-MC221 	<ul style="list-style-type: none"> ■ DeviceNet Master Unit C200HW-DRM21-V1 ■ CompoBus/S Master Unit C200HW-SRM21-V1 ■ PC Link Unit C200H-LK401 ■ SYSBUS Bus Remote I/O Master Units C200H-RM□□□□(-PV1) 	<ul style="list-style-type: none"> ■ ID Sensor Units C200H-IDS01-V1 ■ ASCII Units C200H-ASC□□

■ CS1 CPU Rack

A CS1 CPU Rack consists of a CPU Unit, Power Supply Unit, and Configuration Units (Basic I/O Units, Special I/O Units, and CPU Bus Units).

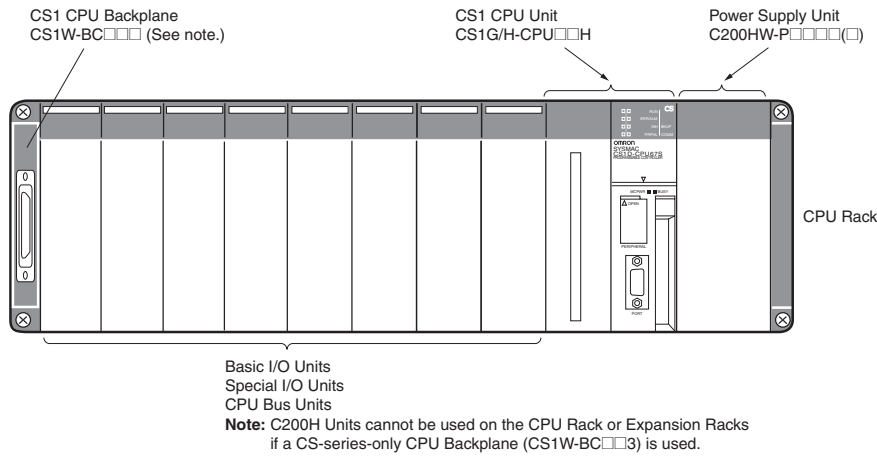

● Required Units

Rack	Unit name	Required number of units
CPU Rack	CS1 CPU Backplane (CS1W-BC□□□□)	1
	Power Supply Unit	1
	CPU Unit	1
	Maximum Number of Configuration Units	Varies by backplane model

● Types of Units

In the SYSMAC CS Series, Units are classified into the following three types. The number of Racks differs depending on the type.

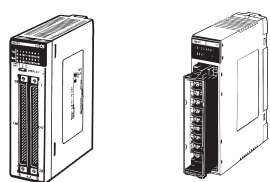
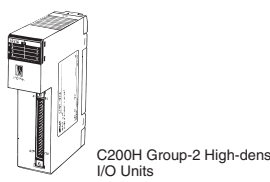
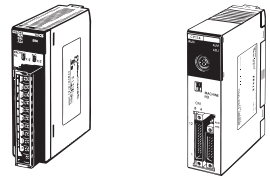
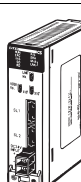
Type	Appearance (example)	Description	Unit recognition method	No. of Units
Basic I/O Units	 <p>CS1 Basic I/O Units C200H Basic I/O Units</p>  <p>C200H Group-2 High-density I/O Units</p>	Units with contact inputs and contact outputs.	In the CS1 System, CS1 Basic I/O Units, C200H Basic I/O Units, and Group-2 High-density I/O Units are identified by their mounting positions (Rack and slot).	The Units mounted must not exceed the maximum I/O capacity of the CPU Unit.
Special I/O Units	 <p>CS1 Special I/O Units C200H Special I/O Units</p>	Special I/O Units provide more advanced functions than do Basic I/O Units, including I/O other than contact inputs and contact outputs. Examples of Special I/O Units are Analog I/O Units and High-speed Counter Units. They differ from CPU Bus Units (including Network Communications Units) in having a smaller area for exchanging data with the CPU Unit.	Recognized by the CPU Unit according to the unit number (CS-series Special I/O Units: 0 to 95, C200J Special I/O Units: 0 to 9, or 0 to 15) set with the rotary switches on the front panel.	CS-series Special I/O Units: 96 Units max.; C200H Special I/O Units: 10 or 16 Units max. (From 1 to 4 unit numbers are assigned per Unit, depending on the model of the Unit.)
CPU Bus Units	 <p>CS1 CPU Bus Units</p>	CPU Bus Units exchange data with the CPU Unit via the CPU Bus. Examples of CPU Bus Units are Network Communications Units and Serial Communications Units. They differ from Special I/O Units in having a larger area for exchanging data with the CPU Unit.	Recognized by the CPU Unit according to the unit number (0 to F) set with the rotary switch on the front panel.	A maximum of 16 Units can be mounted.

■ CS1 Expansion Racks

● CS1 CPU Racks and Expansion Racks

Use this system configuration for an expansion of 12 m or less.

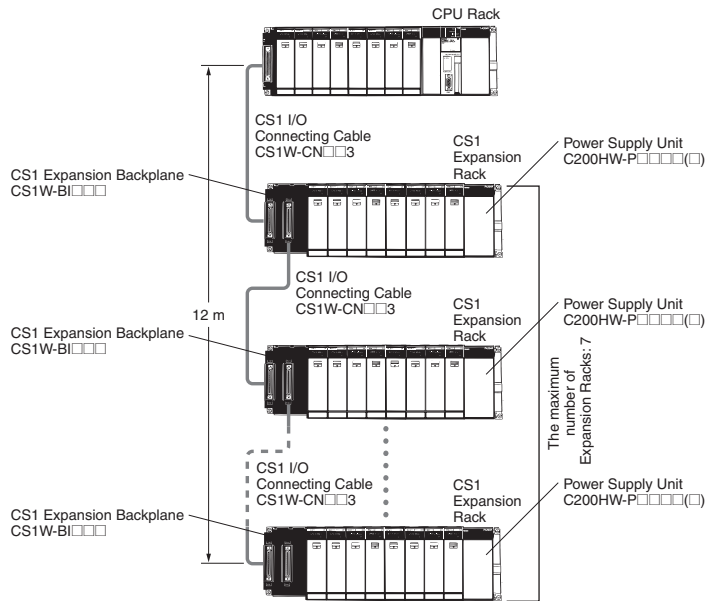

Expansion Racks Configuration

Unit name	Required number of units
Expansion Backplane (CS1W-BI□□□)	One required for each Expansion Rack
Power Supply Unit	One required for each Expansion Rack
Maximum Number of Configuration Units	Varies by backplane model

• Cable

Cable name	Required number of Cables
CS1 I/O Connecting Cable (CS1W-CN□□3)	One required for each Expansion Rack

● When Using a C200HX/HG/HE Expansion I/O Rack

It is possible to connect to an existing C200HX/HG/HE Expansion I/O Rack.

CS1 CPU Rack, CS1 Expansion Racks, and C200HX/HG/HE Expansion I/O Racks

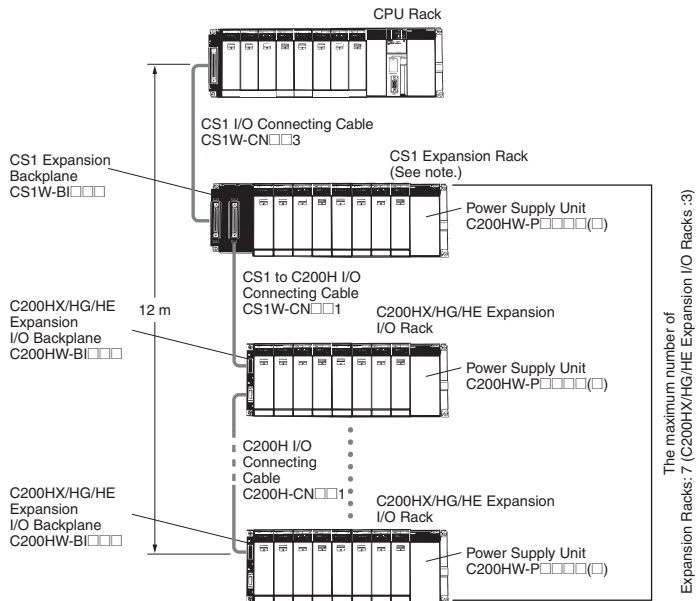

Note: Multiple CS1 Expansion Racks can be connected, but the total number of Expansion Racks must not exceed the maximum of 7. In addition, the Racks must be connected in order, with CS1 Expansion Racks connected before C200HX/HG/HE Expansion I/O Racks.

Expansion Racks Configuration

• CS1 Expansion Racks

Unit name	Required number of units
Expansion Backplane (CS1W-BI□□□□)	1
Power Supply Unit	1
Maximum Number of Configuration Units	Varies by backplane model

• C200HX/HG/HE Expansion Racks

Unit name	Required number of units
C200HX/HG/HE Expansion I/O Backplane (C200HW-BI□□□□)	One required for each Expansion Rack
Power Supply Unit	One required for each Expansion Rack
Maximum Number of Configuration Units	Varies by backplane model

• Cables

Cable name	Required number of cables
CS1 I/O Connecting Cable (CS1W-CN□□3)	Number of CS1 Expansion Racks
CS1 to C200H I/O Connecting Cable (CS1W-CN□□1)	1
C200H I/O Connecting Cable (C200H-CN□□1)	Number of C200HX/HG/HE Expansion I/O Racks minus 1

CS1 CPU Rack and C200HX/HG/HE Expansion I/O Racks

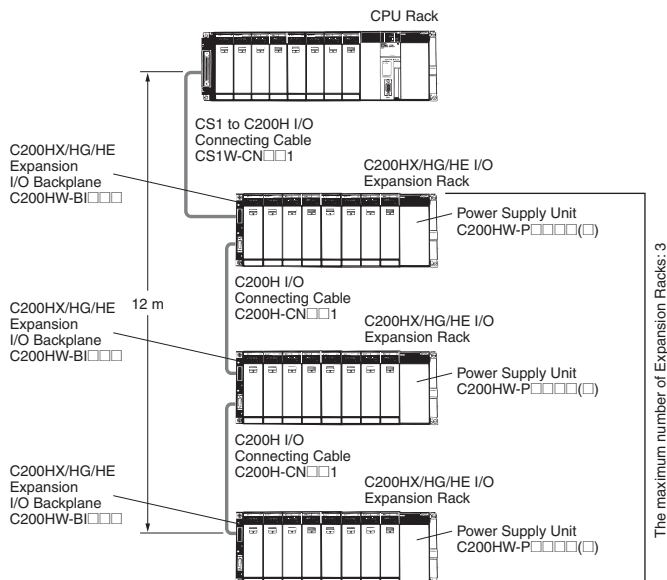

Expansion Racks Configuration

• C200HX/HG/HE Expansion I/O Racks

Unit name	Required number of units
C200HX/HG/HE Expansion I/O Backplane (C200HW-BI□□□□)	One required for each Expansion Rack
Power Supply Unit	One required for each Expansion Rack
Maximum Number of Configuration Units	Varies by backplane model

• Cables

Cable name	Required number of cables
CS1 to C200H I/O Connecting Cable (CS1W-CN□□1)	1
C200H I/O Connecting Cable (C200H-CN□□1)	Number of C200HX/HG/HE Expansion I/O Racks minus 1

● Long-distance Expansion

Use this system configuration for an expansion of more 12 m. Expansion is possible by up to 50 m.

Using CS1 Connecting Cable and Long-distance Expansion Connecting Cable

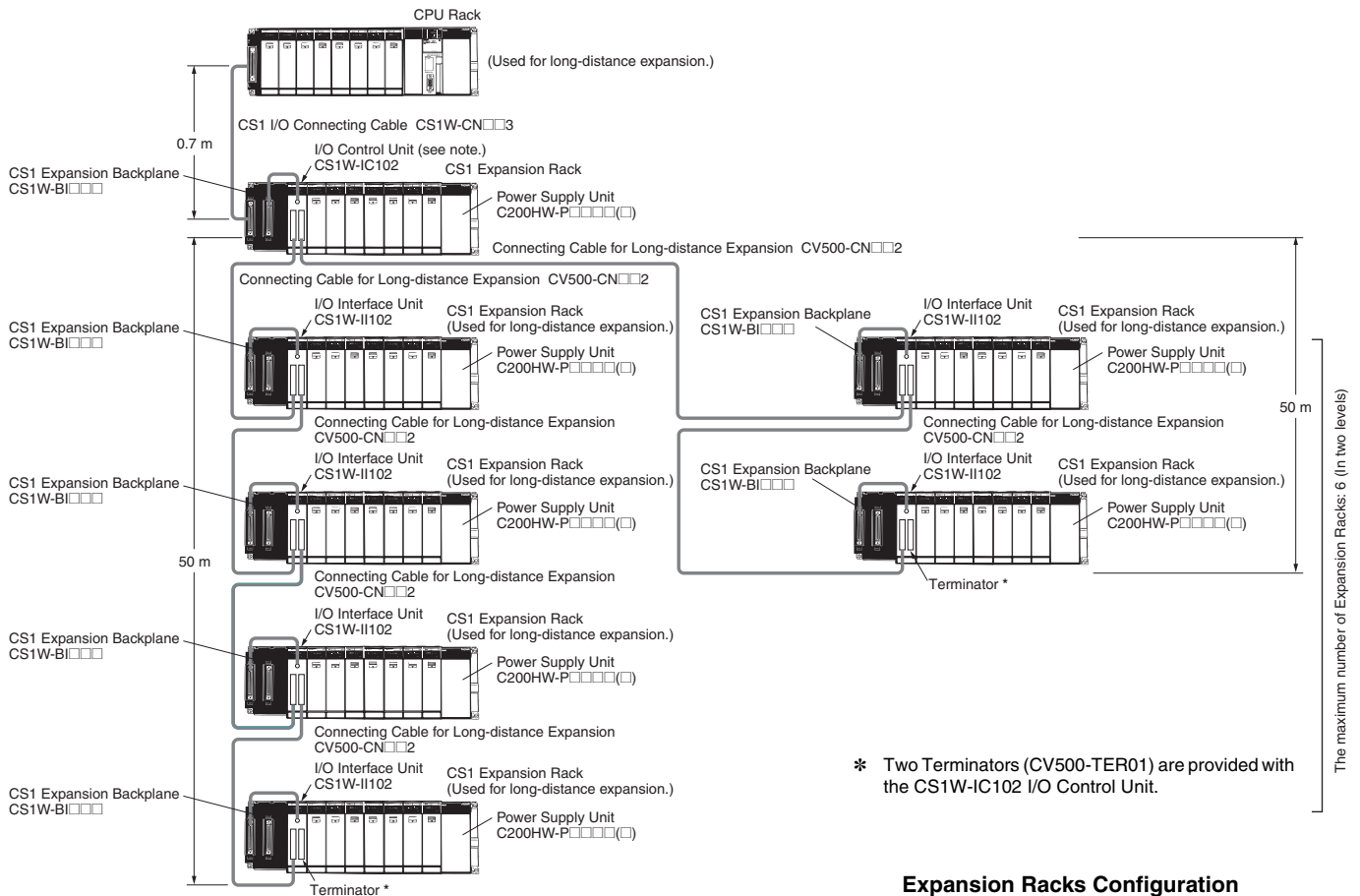

Note: If even one Long-distance Expansion Connecting Cable to be used, it is necessary for an I/O Control Unit to be mounted to the CS1 Expansion Rack where the Cable is connected.

* Two Terminators (CV500-TER01) are provided with the CS1W-IC102 I/O Control Unit.

Expansion Racks Configuration

• CS1 Expansion Rack

Unit name	Required number of units
I/O Control Unit (CS1W-IC102)	1

• CS1 Expansion Rack (Long-distance expansion)

Unit name	Required number of units
CS1 Expansion Backplane (CS1W-BI□□□□)	One required for each Expansion Rack
Power Supply Unit	One required for each Expansion Rack
I/O Interface Unit (CS1W-II102)	One required for each Expansion Rack
Maximum Number of Configuration Units	Varies by backplane model

• Cable

Cable name	Required number of cables
CS1 I/O Connecting Cable (CS1W-CN□□3)	1
Connecting Cable for Long-distance Expansion (CV500-CN□□2)	Number of CS1 Expansion Racks minus 1

Using Long-distance Expansion Connecting Cable

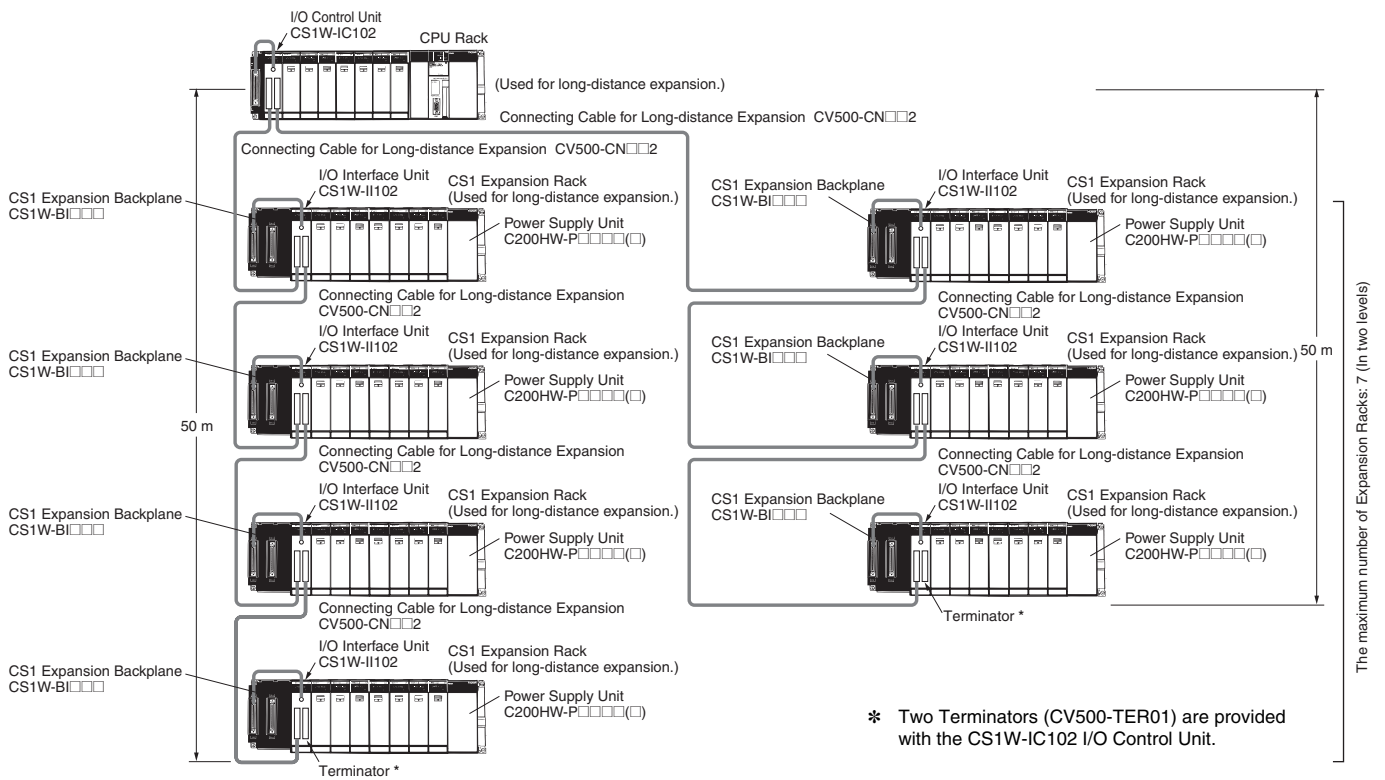

CS1 CPU Rack

Unit name	Required number of units
I/O Control Unit (CS1W-IC102)	1

Expansion Racks Configuration

- CS1 Expansion Rack (Long-distance expansion)

Unit name	Required number of units
CS1 Expansion Backplane (CS1W-BI□□□)	One required for each Expansion Rack
Power Supply Unit	One required for each Expansion Rack
I/O Interface Unit (CS1W-II102)	One required for each Expansion Rack
Maximum Number of Configuration Units	Varies by backplane model

- Cable

Cable name	Required number of cables
Connecting Cable for Long-distance Expansion (CV500-CN□□2)	Number of Long-distance Expansion Racks

Dimensions/Mounting Dimensions

(Unit: mm)

External Dimensions

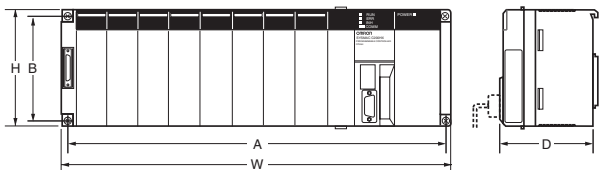

Backplane model	A	B	W	H	D*
CS1W-BC022/023 (2 slots)	172.3	145	198.5	157	123
CS1W-BC032/033 (3 slots)	246	118	260	132	123
CS1W-BC052/053 (5 slots)	316	118	330	132	123
CS1W-BC082/083 (8 slots)	421	118	435	132	123
CS1W-BC102/103 (10 slots)	491	118	505	132	123

* The depth is 153 mm for the C200HW-PA209R/PD025 Power Supply Unit.
The depth is 111 mm for the C200HW-PA204C Power Supply Unit.

Backplane Mounting Dimensions

For 2 I/O Slots

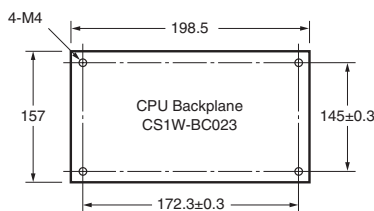

Note: An Expansion Backplane cannot be connected to a 2-slot CPU Backplane.

For 3, 5, 8, or 10 I/O Slots

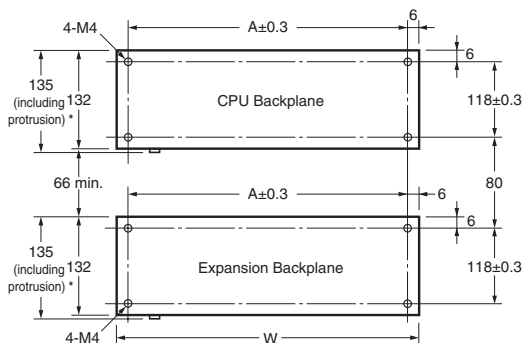

Product name		Model	A	W
CPU Backplanes		CS1W-BC022/023 (2 slots)	172.3	198.5
		CS1W-BC032/033 (3 slots)	246	260
		CS1W-BC052/053 (5 slots)	316	330
		CS1W-BC082/083 (8 slots)	421	435
		CS1W-BC102/103 (10 slots)	491	505
Expansion Backplanes	CS1 Expansion Backplane	CS1W-BI032/033 (3 slots)	246	260
		CS1W-BI052/053 (5 slots)	316	330
		CS1W-BI082/083 (8 slots)	421	435
		CS1W-BI102/103 (10 slots)	491	505
	C200HX/HG/HE Expansion Backplane	C200HW-BI031 (3 slots)	175	189
		C200HW-BI051 (5 slots)	245	259
		C200HW-BI081-V1 (8 slots)	350	364
	C200HW-BI101-V1 (10 slots)	420	434	

■ Mounting Height

The mounted height of CPU Racks, Expansion Racks, and Slave Racks is 118 to 153 mm, depending on I/O Units that are mounted.

If Programming Devices or connecting cables are attached, the additional dimensions must be taken into account. Allow sufficient clearance in the control panel in which the PLC is mounted.

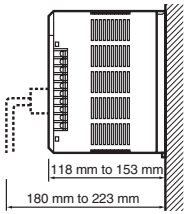

Note: When using Expansion Racks, the total length of the I/O Connecting Cables must be less than 12 m. When bending an I/O Connecting Cables, provide at least the minimum bending radius shown in the following diagrams.

● CS1 I/O Connecting Cable

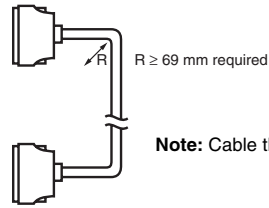

Note: Cable thickness: 8.6 mm dia.

● C200H I/O Connecting Cable

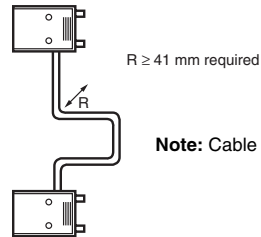

Note: Cable thickness: 5.1 mm dia.

● CS1 to C200H I/O Connecting Cable

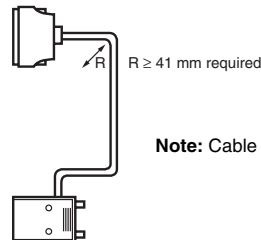

Note: Cable thickness: 5.1 mm dia.

● Connecting Cable for Long-distance Expansion

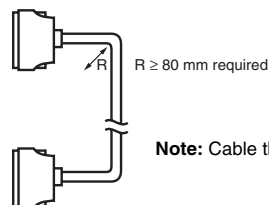

Note: Cable thickness: 10 mm dia.

General Specifications

Power Supply Unit model	Specifications						
	C200HW-PA204	C200HW-PA204C	C200HW-PA204R	C200HW-PA204S	C200HW-PA209R	C200HW-PD024	C200HW-PD025
Power supply voltage	100 to 240 VAC (wide range), 50/60 Hz *1			100 to 120 VAC/200 to 240 V, 50/60 Hz		24 VDC	
Operating voltage range	85 to 264 VAC			85 to 132 VAC/170 to 264 V		19.2 to 28.8 VDC	
Power consumption	120 VA max.	100 VA max.	120 VA max.		180 VA max.	40 W max.	60 W max.
Inrush current	100 to 120 VAC input 15 A/8 ms max. (cold start at room temperature) 200 to 240 VAC input 30 A/8 ms max. (cold start at room temperature)			100 to 120 VAC input 20 A/8 ms max. (cold start at room temperature) 200 to 240 VAC input 30 A/8 ms max. (cold start at room temperature)	100 to 120 VAC: 30 A max. 200 to 240 VAC: 40 A max.	30 A max.	
Insulation resistance	20 MΩ min. (at 500 VDC) between AC external and GR terminals *2	<ul style="list-style-type: none"> • 20 MΩ min. (at 500 VDC) between all AC external terminals and GR terminal and between all alarm output terminals. • 20 MΩ min. (at 250 VDC) between all alarm output terminals and GR terminal. 		20 MΩ min. (at 500 VDC) between all AC external and GR terminals *2		20 MΩ min. (at 500 VDC) between all DC external and GR terminals *2	
Dielectric strength	2,300 VAC 50/60 Hz for 1 min between AC external and GR terminals *2 Leakage current: 10 mA max.	<ul style="list-style-type: none"> • 2,300 VAC, 50/60 Hz for 1 minute between all AC external terminals and GR terminal and between all alarm output terminals. Leakage current: 10 mA max. • 1,000 VAC, 50/60 Hz for 1 minute between all alarm output terminals and GR terminal. Leakage current: 10 mA max. 		2,300 VAC 50/60 Hz for 1 min between all AC external and GR terminals *2 Leakage current: 10 mA max.		1,000 VAC 50/60 Hz for 1 min between all DC external and GR terminals *2 Leakage current: 10 mA max.	
	1,000 VAC 50/60 Hz for 1 min between all DC external and GR terminals *2 Leakage current: 10 mA max.						
Noise immunity	2 kV on power supply line (conforming to IEC61000-4-4)						
Vibration resistance	Conforms to JIS 0040, 10 to 57 Hz, 0.075-mm amplitude, 57 to 150 Hz, acceleration: 9.8 m/s ² in X, Y, and Z directions for 80 minutes (Time coefficient: 8 minutes x coefficient factor 10 = total time 80 min.) (CPU Unit mounted to a DIN track: 2 to 55 Hz, 2.9 m/s ² in X, Y, and Z directions for 20 minutes)						
Shock resistance	Conforms to JIS 0041, 147 m/s ² 3 times each in X, Y, and Z directions						
Ambient operating temperature	0 to 55°C						
Ambient operating humidity	10% to 90% (with no condensation)	10% to 90% (with no condensation) *4	10% to 90% (with no condensation)				
Ambient operating atmosphere	No corrosive gases						
Ambient storage temperature	-20 to 75°C (excluding battery)						
Grounding	Less than 100 Ω						
Enclosure	Mounted in a panel.						
Weight	Each Rack: 6 kg max.						
CPU Rack dimensions (mm)	2 slots: 198.5 x 157 x 123 (W x H x D) *3 3 slots: 260 x 130 x 123 (W x H x D) *3 5 slots: 330 x 130 x 123 (W x H x D) *3 8 slots: 435 x 130 x 123 (W x H x D) *3 10 slots: 505 x 130 x 123 (W x H x D) *3						
Standards	Conforms to UL, CSA, cULus, NK, Lloyd's, and EC Directives.						

- *1. C200HW-PA204/PA204R Power Supply Units shipped before March 2010 have power supply voltage specifications of 100 to 120 VAC/200 to 240 VAC, 50/60 Hz.
- *2. Disconnect the Power Supply Unit's LG terminal from the GR terminal when testing insulation and dielectric strength.
Testing the insulation and dielectric strength with the LG terminal and the GR terminals connected will damage internal circuits in the CPU Unit.
- *3. The depth is 153 mm for the C200HW-PA209R/PD025 Power Supply Unit. The depth is 111 mm for the C200HW-PA204C Power Supply Unit.
- *4. Maintain an ambient storage temperature of -25 to 30°C and relative humidity of 25% to 70% when storing the C200HW-PA204C for longer than 3 months to keep the replacement notification function in optimum working condition.

Common Specifications for CPU Units

Item		Specifications
Control method		Stored program
I/O control method		Cyclic scan and immediate processing are both possible.
Programming		<ul style="list-style-type: none"> •Ladder diagrams •SFC (sequential function charts) •ST (structured text) •Mnemonics
Instruction length		1 to 7 steps per instruction
Ladder instructions		Approx. 400 (3-digit function codes)
Execution time	Basic instructions	0.02 μs min.
	Special instructions	0.04 μs min.
Number of tasks		288 (cyclic tasks: 32, interrupt tasks: 256) Note 1: Cyclic tasks are executed each cycle and are controlled with TKON(820) and TKOF(821) instructions. Note 2: The following 4 types of interrupt tasks are supported. Power OFF interrupt tasks: 1 max. Scheduled interrupt tasks: 2 max. I/O interrupt tasks: 32 max. External interrupt tasks: 256 max.
Interrupt types		Scheduled Interrupts: Interrupts generated at a time scheduled by the CPU Unit's built-in timer. I/O Interrupts: Interrupts from Interrupt Input Units. Power OFF Interrupts: Interrupts executed when the CPU Unit's power is turned OFF. External I/O Interrupts: Interrupts from the Special I/O Units, CS-series CPU Bus Units, or the Inner Board.
Function blocks *1		Languages in function block definitions: ladder programming, structured text
CIO (Core I/O) Area	I/O Area	5,120: CIO 000000 to CIO 031915 (320 words from CIO 0000 to CIO 0319) The setting of the first word can be changed from the default (CIO 0000) so that CIO 0000 to CIO 0999 can be used. I/O bits are allocated to Basic I/O Units, such as CS-series Basic I/O Units, C200H Basic I/O Units, and C200H Group-2 High-density I/O Units.
	Link Area	3,200 (200 words): CIO 10000 to CIO 119915 (words CIO 1000 to CIO 1199) Link bits are used for data links and are allocated to Units in Controller Link Systems and PLC Link Systems.
	CPU Bus Unit Area	6,400 (400 words): CIO 150000 to CIO 189915 (words CIO 1500 to CIO 1899) CS-series CPU Bus Unit bits store the operating status of CS-series CPU Bus Units. (25 words per Unit, 16 Units max.)
	Special I/O Unit Area	15,360 (960 words): CIO 200000 to CIO 295915 (words CIO 2000 to CIO 2959) Special I/O Unit bits are allocated to CS-series Special I/O Units and C200H Special I/O Units. (See Note.) (10 words per Unit, 96 Units max. The maximum total number of slots, however, is limited to 80 including expansion slots, so the maximum number of Units is actually 80. Note: A maximum of 16 C200H Special I/O Units can be mounted. Also, depending on the Units, the maximum may be 10. Some I/O Units are classified as Special I/O Units.
	Inner Board Area	1,600 (100 words): CIO 190000 to CIO 199915 (words CIO 1900 to CIO 1999) Inner Board bits are allocated to Inner Boards. (100 I/O words max.)
	SYSMAC BUS Area	800 (50 words): CIO 300000 to CIO 304915 (words CIO 3000 to CIO 3049) SYSMAC BUS bits are allocated to Slave Racks connected to SYSMAC BUS Remote I/O Master Units. (10 words per Rack, 5 Racks max.)
	I/O Terminal Area	512 (32 words): CIO 310000 to CIO 313115 (words CIO 3100 to CIO 3131) I/O Terminal bits are allocated to I/O Terminal Units (but not to Slave Racks) connected to SYSMAC BUS Remote I/O Master Units. (1 word per Terminal, 32 Terminals max.)
	C200H Special I/O Unit Area	8,192 bits (512 words): W00000 to W51115 (W000 to W511) C200H Special I/O Unit bits are allocated to C200H Special I/O Units, and accessed separately from I/O refreshing.
	DeviceNet Area	1,600 (100 words): Outputs: CIO 005000 to CIO 009915 (words CIO 0050 to CIO 0099) Inputs: CIO 035000 to CIO 039915 (words CIO 0350 to CIO 0399) DeviceNet bits are allocated to Slaves according to DeviceNet remote I/O communications.
PLC Link Area	64 bits (4 words): CIO 024700 to CIO 025015 (words CIO 0247 to CIO 0250) When a PLC Link Unit is used in a PLC Link, use these bits to monitor PLC Link errors and the operating status of other CPU Units in the PLC Link.	
Internal I/O Area		4,800 (300 words): CIO 120000 to CIO 149915 (words CIO 1200 to CIO 1499) 37,504 (2,344 words): CIO 380000 to CIO 614315 (words CIO 3800 to CIO 6143) These bits in the CIO Area are used as work bits in programming to control program execution. (They cannot be used for external I/O.)
Work Area		8,192 bits (512 words): H00000 to H51115 (H000 to H511) These bits in the CIO Area are used as work bits in programming to control program execution. (They cannot be used for external I/O.) When using work bits in programming, use the bits in the Work Area first before using bits from other areas.
Holding Area		8,192 bits (512 words): H00000 to H51115 (H000 to H511) Holding bits are used to control the execution of the program, and maintain their ON/OFF status when the PLC is turned OFF or the operating mode is changed. Note: The Function Block Holding Area words are allocated from H512 to H1535. These words can be used only for the function block instance area (internally allocated variable area).
Auxiliary Area		Read only: 7,168 bits (448 words): A00000 to A44715 (words A000 to A447) Read/write: 8,192 bits (512 words): A44800 to A95915 (words A448 to A959) Auxiliary bits are allocated specific functions.
Temporary Area		16 bits (TR0 to TR15) Temporary bits are used to temporarily store the ON/OFF execution conditions at program branches.
Timer Area		4,096: T0000 to T4095 (separate from counters) Note: The time units for timer settings are 0.1 s, 0.01 s, and 0.001 s (depending on the timer instruction that is used).
Counter Area		C0000 to C4095 (separate from timers)
DM Area		32K words: D00000 to D32767 Internal Special I/O Unit DM Area: D20000 to D29599 (100 words x 96 Units) Used to set parameters for Special I/O Units. CPU Bus Unit DM Area: D30000 to D31599 (100 words x 16 Units) Used to set parameters for CPU Bus Units. Inner Board DM Area: D32000 to D32099 Used to set parameters for Inner Boards. Used as a general-purpose data area for reading and writing data in word units (16 bits). Words in the DM Area maintain their status when the PLC is turned OFF or the operating mode is changed.

The CIO Area can be used as work bits if the bits are not used as shown here.

Item		Specifications	
EM Area		32K words per bank, 13 banks max.: E0_0000 to EC_32767 max. (Varies by CPU Unit model.) Used as a general-purpose data area for reading and writing data in word units (16 bits). Words in the EM Area maintain their status when the PLC is turned OFF or the operating mode is changed. The EM Area is divided into banks, and the addresses can be set by either of the following methods. Changing the current bank using the EMBC(281) instruction and setting addresses for the current bank. Setting bank numbers and addresses directly. EM data can be stored in files by specifying the number of the first bank.	
Data Registers		DR0 to DR15: Store offset values for indirect addressing. One register is 16 bits (1 word).	
Index Registers		IR0 to IR15: Store PLC memory addresses for indirect addressing. One register is 32 bits (2 words).	
Task Flag Area		32 (TK0000 to TK0031): Task Flags are read-only flags that are ON when the corresponding cyclic task is executable and OFF when the corresponding task is not executable or in standby status.	
Trace Memory		4,000 words (The maximum amount of data that can be traced in a data trace is 500 samples for 31 bits and 6 words.)	
File Memory		Memory Cards: Compact flash memory cards can be used (MS-DOS format). EM file memory: Part of the EM Area can be converted to file memory (MS-DOS format).	
Functions	Parallel Processing Modes	Program execution and peripheral servicing can be performed simultaneously.	
	Battery-free operation	The user program and the system's parameters are backed up automatically in flash memory, which is standard equipment.	
	Constant cycle time	Possible (1 to 32,000 ms) (Unit: 1 ms)	
	Cycle time monitoring	Possible (Unit stops operating if the cycle is too long): 10 to 40,000 ms (Unit: 10 ms)	
	I/O refreshing	Cyclic refreshing, immediate refreshing, refreshing with I/O REFRESH instruction	
	I/O memory holding when changing operating modes	Possible (Depends on the ON/OFF status of the IOM Hold Bit in the Auxiliary Area.)	
	Load OFF	All outputs on Output Units can be turned OFF.	
	Input response time setting	Time constants can be set for inputs from Basic I/O Units. The time constant can be increased to reduce the influence of noise and chattering or it can be decreased to detect shorter pulses on the inputs (CS1 Basic I/O Units only).	
	Startup mode setting	Supported.	
	Memory Card functions	Automatically reading programs (autoboot) from the Memory Card when the power is turned ON.	
		Format in which data is stored in Memory Card	User program: Program file format PLC Setup and other parameters: Data file format (binary format) I/O memory: Data file format (binary format), text format, or CSV format
		Functions for which Memory Card read/write is supported	User program instructions, Programming Devices (including Programming Consoles), Host Link computers
	Filing	Memory Card data and the EM (Extended Data Memory) Area can be handled as files.	
	Debugging	Control set/reset, differential monitoring, data tracing (scheduled, each cycle, or when instruction is executed), storing location generating error when a program error occurs	
	Online editing	User programs can be overwritten in program-block units when the CPU Unit is in MONITOR or PROGRAM mode. (This function is not available for block programming areas.)	
	Program protection	Overwrite protection: Set using DIP switch. Copy protection: Password set using Programming Device.	
	Error check	User-defined errors (i.e., user can define fatal errors and non-fatal errors) The FPD(269) instruction can be used to check the execution time and logic of each programming block.	
	Error log	Up to 20 errors are stored in the error log. Information includes the error code, error details, and the time the error occurred.	
	Serial communications	Built-in peripheral port: Programming Device (including Programming Console) connections, Host Links, NT Links Built-in RS-232C port: Programming Device (excluding Programming Console) connections, Host Links, no-protocol communications, NT Links, and Serial Gateway *3	
		Serial communications board (order separately): protocol macros, Host Links, no-protocol communications *3, NT Links, Serial Gateway *3, and Modbus-RTU Slave *5	
	Clock	Provided on all models. Note: Used to store the time when power is turned ON and when errors occur.	
	Power OFF detection time	10 to 25 ms (not fixed)	
	Power OFF detection delay time	0 to 10 ms (user-defined, default: 0 ms)	
	Memory retention during power interruptions	Held Areas: Holding bits, contents of Data Memory and Extended Data Memory, and status of the counter Completion Flags and present values. Note: If the IOM Hold Bit in the Auxiliary Area is turned ON, and the PLC Setup is set to maintain the IOM Hold Bit status when power to the PLC is turned ON, the contents of the CIO Area, the Work Area, part of the Auxiliary Area, timer Completion Flags and PVs, Index Registers, and the Data Registers will be saved.	
	Sending commands to a Host Link computer	FINS commands can be sent to a computer connected via the Host Link System by executing Network Communications Instructions from the PLC.	
	Remote programming and monitoring	Host Link communications can be used for remote programming and remote monitoring through a Controller Link System or Ethernet network.	
	8-level communications *2	Remote programming and monitoring across up to eight network layers (Controller Link or Ethernet) by using Host Link. (They are possible between different types of networks.)	
Storing comments in CPU Unit	I/O comments can be stored in the CPU Unit in Memory Cards *1 or EM file memory.		
Program check	Program checks are performed at the beginning of operation for items such as no END instruction and instruction errors. Programming Devices (except for the Programming Consoles) can also be used to check programs.		
Control output signals	RUN output: The internal contacts will be ON (closed) while the CPU Unit is operating in RUN mode or MONITOR mode. These terminals are provided only on C200HW-PA204R, C200HW-PA209R, and CS1D-PA207R Power Supply Units.		
Battery service life	The battery life is 5 years at an ambient temperature of 25°C, although the lifetime can be as short as 1.1 years under adverse temperature and power conditions. (Battery Set: CS1W-BAT01) *3 *4		
Self-diagnostics	CPU errors (watchdog timer), I/O verification errors, I/O bus errors, memory errors, and battery errors.		
Other functions	Words in the Auxiliary Area store the number of power interruptions, time of the last power interruption, and total power ON time.		

- *1. CPU Units with unit version 3.0 or later only.
- *2. CPU Units with unit version 2.0 or later only. (Communications across three network layers is supported for Pre-Ver. 2.0 CPU Units.)
- *3. CPU Units with unit version 3.0 or later only or Serial Communications Board/Unit with unit version 1.2 or later only.
- *4. Use a replacement battery that was manufactured within the last two years.
- *5. Serial Communications Board/Unit with unit version 1.3 or later only.

■ Functions Added by Unit Version

The following functions have been added for the unit versions of CS1G/H CPU Units.

OK: Supported, ---: Not supported

Function	Model Unit version	CS1□-CPU□□H			
		No unit version	Unit version 2.0	Unit version 3.0	Unit version 4.0
Downloading and Uploading Individual Tasks		---	OK	OK	OK
Improved Read Protection Using Passwords		---	OK	OK	OK
Write Protection from FINS Commands Sent to CPU Units via Networks		---	OK	OK	OK
Online Network Connections without I/O Tables		---	OK	OK	OK
Communications through a Maximum of 8 Network Levels		---	OK	OK	OK
Connecting Online to PLCs via NS-series PTs		OK (from lot number 030201)	OK	OK	OK
Setting First Slot Words		OK (for up to 8 group)	OK (for up to 64 group)	OK (for up to 64 group)	OK
Automatic Transfers at Power ON without a Parameter File (.STD)		---	OK	OK	OK
Automatic Detection of I/O Allocation Method for Automatic Transfer at Power ON		---	---	---	OK
Operation Start/End Times		---	OK	OK	OK
Support of new instructions	MILH, MILR, MILC	---	OK	OK	OK
	= DT, <>DT, <DT, <= DT, >DT, >= DT	---	OK	OK	OK
	BCMP2	---	OK	OK	OK
	GRY	OK (from lot number 030201)	OK	OK	OK
	TPO	---	OK	OK	OK
	DSW, TKY, HKY, MTR, 7SEG	---	OK	OK	OK
	EXPLT, EGATR, ESATR, ECHRD, ECHWR	---	OK	OK	OK
	IORD/IOWR reading/writing to CPU Bus Units	OK (from lot number 030418)	OK	OK	OK
PRV2	---	---	---	OK	
Function blocks (CX-Programmer Ver.5.0 or later)		---	---	OK	OK
Serial Gateway (converting FINS commands to CompoWay/F commands at the built-in serial port)		---	---	OK	OK
Comment memory (in internal flash memory)		---	---	OK	OK
Expanded simple backup data		---	---	OK	OK
TXDU(256), RXDU(255) (support no-protocol communications with Serial Communications Units with unit version 1.2 or later)		---	---	OK	OK
Model conversion instructions: XFERC(565), DISTC(566), COLLC(567), MOVBC(568), BCNTC(621)		---	---	OK	OK
Special function block instructions: GETID(286)		---	---	OK	OK
Additional instruction functions	TXD(236), RXD(235) (support no-protocol communications with Serial Communications Units with unit version 1.2 or later)	---	---	OK	OK
Use of new special instructions	Conversion instructions from numbers to ASCII and ASCII to numbers	---	---	---	OK
	Flowchart conversion instructions (one type of block programming instructions) to convert flowchart programs from C-series Flowchart PLCs to ladder programs for CS/CJ-series PLCs	---	---	---	OK
Function block (FB) functional upgrades	Online editing of function blocks	---	---	---	OK
	Support for I/O variables (including array variables for I/O variables)	---	---	---	OK
	Support for STRING data type and processing functions for ST language.	---	---	---	OK

● Unit Versions

Unit versions have been introduced to control differences in functions featured by CPU Units that are the result of version upgrades.

The unit version is marked on the nameplates of products subject to version control, as shown in the diagram.

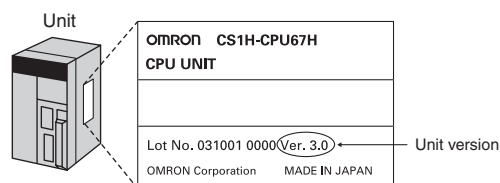

■ Unit Versions and Programming Devices

Applicable PLCs		Name	CX-Programmer
CS1G/H-series	CS1H-CPU67H/66H/65H/64H/63H CS1G-CPU45H/44H/43H/42H	No unit version	Version 2.1 or later
		Unit version 2.0	Version 4.0 or later
		Unit version 3.0	Version 5.0 or later
		Unit version 4.0	Version 7.0 or later

Current Consumption for Power Supply Units

■ Checking Current Consumption and Power Consumption

After selecting a Power Supply Unit based on considerations such as the power supply voltage, calculate the current and power requirements for each Rack.

Condition 1: Current Requirements

There are three voltage groups for internal power consumption: 5 V, 26 V, and 24 V.

- Current consumption at 5 V (internal logic power supply)
- Current consumption at 26 V (relay driving power supply)
- Current consumption at 24 V (power supply output terminals) (C200HW-PA204S only)

Condition 2: Power Requirements

For each Rack, the upper limits are determined for the current and power that can be provided to the mounted Units. Design the system so that the total current consumption for all the mounted Units does not exceed the maximum total power or the maximum current supplied for the voltage groups shown in the following tables.

● CPU Racks and Expansion Racks

The maximum current and total power supplied for CPU Racks and Expansion Racks according to the Power Supply Unit model are shown below.

Note 1: For CPU Racks, include the CPU Backplane and CPU Unit current and power consumption in the calculations.
Note 2: For Expansion Racks, include the Expansion Backplanes current and power consumption in the calculations.

Power Supply Units	Max. current supplied			(D) Max. total power supplied
	(A) 5 V	(B) 26 V	(C) 24 V	
C200HW-PA204C	4.6 A	0.6 A	---	30 W
C200HW-PA204	4.6 A	0.6 A	---	30 W
C200HW-PA204S	4.6 A	0.6 A	0.8 A	30 W
C200HW-PA204R	4.6 A	0.6 A	---	30 W
C200HW-PA209R	9 A	1.3 A	---	45 W
C200HW-PD024	4.6 A	0.6 A	---	30 W
C200HW-PD025	5.3 A	1.3 A	---	40 W
CS1D-PA207R	7 A	1.3 A	---	35 W
CS1D-PD024	4.3 A	0.56 A	---	28 W

Conditions 1 and 2 below must be satisfied.

Condition 1: Maximum Current

- (1) Total Unit current consumption at 5 V \leq (A) value
- (2) Total Unit current consumption at 26 V \leq (B) value
- (3) Current consumption for service power supply at 24 V \leq (C) value (Only when using the service power supply from the C200HW-PA204S.)

Condition 2: Maximum Power

$$(1) \times 5 \text{ V} + (2) \times 26 \text{ V} + (3) \times 24 \text{ V} \leq (D) \text{ value}$$

■ Example: Calculating Total Current and Power Consumption

Example: When the Following Units are Mounted to a CS-series CPU Rack Using a CS1W-PA204S Power Supply Unit

Type	Model	Quantity	Voltage group		
			5 V	26 V	24 V
CPU Backplanes (8 slots)	CS1W-BC083	1	0.11 A	---	---
CPU Unit	CS1H-CPU67H	1	0.82 A	---	---
Input Unit	CS1W-ID211	2	0.10 A	---	---
	CS1W-ID291	2	0.20 A	---	---
Output Unit	CS1W-OC201	2	0.10 A	0.048 A	---
Special I/O Unit	CS1W-NC213	1	0.25 A	---	---
CPU Bus Unit	CS1W-CLK23	1	0.33 A	---	---
Service power supply		0.3 A used	---	---	0.3 A
Current consumption	Total		0.11 A + 0.82 A + 0.10 A x 2 + 0.20 A x 2 + 0.10 A x 2 + 0.25 A + 0.33 A	0.048 A x 2	0.3 A
	Result		2.31 A (\leq 4.6 A)	0.096 A (\leq 0.6 A)	0.3 A (\leq 0.8 A)
Power consumption	Total		2.31 A x 5 V = 11.55 W	0.096 A x 26 V = 2.496 W	0.3 A x 24 V = 7.2 W
	Result		11.55 + 2.496 + 7.2 = 21.246 W (\leq 30 W)		

Note: For details on Unit current consumption, refer to *Ordering Information*.

■ Using the CX-Programmer to Display Current Consumption and Width

CPU Rack and Expansion Rack current consumption and width can be displayed by selecting Current Consumption and Width from the Options Menu in the CS1 Table Window. If the capacity of the Power Supply Unit is exceeded, it will be displayed in red characters.

Example:

Rack	Power Supply Unit	Consumption(mA)		Total power consumption [W]	Long-distance expansion	Width(mm)
		5V	26V/24V			
CPU Rack	C200Hw-PA204	1850		9	<input checked="" type="checkbox"/>	
Rack 01	C200Hw-PA204				<input checked="" type="checkbox"/>	
Rack 02	C200Hw-PA204				<input checked="" type="checkbox"/>	
Rack 03	C200Hw-PA204				<input checked="" type="checkbox"/>	
Rack 04	C200Hw-PA204				<input checked="" type="checkbox"/>	
Rack 05	C200Hw-PA204				<input checked="" type="checkbox"/>	
Rack 06	C200Hw-PA204				<input checked="" type="checkbox"/>	
Rack 07	C200Hw-PA204				<input checked="" type="checkbox"/>	

Ordering Information

Basic Configuration Units	18
Programming Devices.....	22
Accessories and Maintenance Parts	25
DIN Track Mounting Accessories	25
Basic I/O Units	26
Special I/O Units, CPU Bus Units, and Inner Boards	32
Replacing C200H I/O Units	54

Ordering Information

● International Standards

- The standards are abbreviated as follows: U: UL, U1: UL (Class I Division 2 Products for Hazardous Locations), C: CSA, UC: cULus, UC1: cULus (Class I Division 2 Products for Hazardous Locations), CU: cUL, N: NK, L: Lloyd, and CE: EC Directives.
- Contact your OMRON representative for further details and applicable conditions for these standards.

● EC Directives

The EC Directives applicable to PLCs include the EMC Directives and the Low Voltage Directive. OMRON complies with these directives as described below manufacturing installations.

● EMC Directives

Applicable Standards EMI: EN61000-6-4
EN61131-2
EMS: EN61000-6-2
EN61131-2

OMRON PLCs conform to the related EMC standards so that the devices and machines into which they are built can more easily conform to EMC standards. The actual PLCs have been checked for conformity to EMC standards. Whether these standards are satisfied for the actual system, however, must be checked by the customer.

EMC-related performance will vary depending on the configuration, wiring, and other conditions of the equipment or control panel in which the PLC is installed.

The customer must, therefore, perform final checks to confirm that the overall machine or device conforms to EMC standards.

● Low Voltage Directive

Applicable Standard: EN61131-2

Devices that operate at voltages from 50 to 1,000 VAC or 75 to 150 VDC must satisfy the appropriate safety requirements. With PLCs, this applies to Power Supply Units and I/O Units that operate in these voltage ranges.

These Units have been designed to conform to EN61131-2, which is the applicable standard for PLCs.

Ordering Information

Basic Configuration Units

CPU Rack



CS1 CPU Units

Product name	Specifications							Mountable Racks			Current consumption (A)		Model	Standards
								CS1 CPU Rack		CS1D CPU Rack				
	Number of I/O points	Program capacity	Data memory capacity	LD instruction execution time	Online Unit replacement	Duplex Communications Units	Duplex Power Supply Units	CS-series CPU Backplane CS1W-BC□□2	CS/C200H-series CPU Backplane CS1W-BC□□3	CS1D CPU Backplane CS1D-BC082S or CS1D-BC052	5 V system	26 V system		
CS1 CPU Units 	5,120 (Expansion Racks: 7)	250K steps	448K words (DM: 32K words, EM: 32K words x 13 banks)	0.02 μs	No	No	No	Yes	Yes	No	* 0.82	---	CS1H-CPU67H	UC1, N, L, CE
	5,120 (Expansion Racks: 7)	120K steps	256K words (DM: 32K words, EM: 32K words x 7 banks)								* 0.82	---	CS1H-CPU66H	
	5,120 (Expansion Racks: 7)	60K steps	128K words (DM: 32K words, EM: 32K words x 3 banks)								* 0.82	---	CS1H-CPU65H	
	5,120 (Expansion Racks: 7)	30K steps	64K words (DM: 32K words, EM: 32K words x 1 bank)								* 0.82	---	CS1H-CPU64H	
	5,120 (Expansion Racks: 7)	20K steps	64K words (DM: 32K words, EM: 32K words x 1 bank)								* 0.82	---	CS1H-CPU63H	
	5,120 (Expansion Racks: 7)	60K steps	128K words (DM: 32K words, EM: 32K words x 3 banks)	0.04 μs	No	No	No				* 0.78	---	CS1G-CPU45H	
	1,280 (Expansion Racks: 3)	30K steps	64K words (DM: 32K words, EM: 32K words x 1 bank)								* 0.78	---	CS1G-CPU44H	
	960 (Expansion Racks: 2)	20K steps	64K words (DM: 32K words, EM: 32K words x 1 bank)								* 0.78	---	CS1G-CPU43H	
	960 (Expansion Racks: 2)	10K steps	64K words (DM: 32K words, EM: 32K words x 1 bank)								* 0.78	---	CS1G-CPU42H	

* These values include the current consumption of a connected Programming Console. NT-AL001 Link Adapters consume an additional 0.15 A each when used.

■ Power Supply Units

One Power Supply Unit is required for each Rack.

Product name	Power supply voltage	Output capacity			Options			Mountable Racks						Model	Standards		
		5-VDC Model Standards output capacity	26-VDC output capacity	Total power consumption	24-VDC 0.8 A service power supply	RUN output	Maintenance forecast monitor	CPU Rack	C200HX/HG/HE Expansion I/O Rack	CS1 Expansion Rack	CS1 Long-distance Expansion Rack	CS1D CPU Rack	CS1D Expansion Rack			SYSMAC BUS Slave Rack	
 AC Power Supply Unit	100 to 240 VAC (wide range)	4.6 A	0.625 A	30 W	No	No	Yes									C200HW-PA204C	U, C, N, L, CE
																C200HW-PA204	U, C, N, L, CE
 AC Power Supply Unit	100 to 240 VAC (wide range) *	4.6 A	0.625 A (with 0.8 A, 24 VDC service power supply)	30 W	Yes	No	No	Yes	No	Yes		No	Yes		C200HW-PA204R	U, C	
															C200HW-PA204S	U, C, N, L, CE	
															C200HW-PA209R	U, C, N, L, CE	
 DC Power Supply Unit	24 VDC	4.6 A	0.625 A	30 W	No	No	No								C200HW-PD024	U, C, N, L, CE	
															C200HW-PD025		U, C, N, L, CE

*C200HW-PA204/PA204R Power Supply Units shipped before March 2010 have power supply voltage specifications of 100 to 120 VAC/200 to 240 VAC, 50/60 Hz.

■ CS1 CPU Backplane

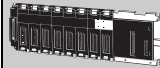
Product name	Specifications	Applicable CPU Unit	Mountable configuration units						Current consumption (A)		Model	Standards			
			Basic I/O Units			Special I/O Units		CPU Bus Units	5 V system	26 V system					
			CS-series Basic I/O Unit	C200H-series Basic I/O Unit	C200H Group-2 High-density I/O Unit	CS-series Special I/O Unit	C200H-series Special I/O Unit	CS-series CPU Bus Unit							
 CS1 CPU Backplane	For CS-series Unit only Note: C200H-series Units cannot be mounted.	CS1 CPU Unit	Yes	No		Yes	No	Yes	0.11	---	CS1W-BC022	U, C, N, L, CE			
									3 slots	0.11	---		CS1W-BC032		
									5 slots	0.11	---		CS1W-BC052		
									8 slots	0.11	---		CS1W-BC082		
									10 slots	0.11	---		CS1W-BC102		
	For both CS/ C200H-series Units			Yes							0.11		---	CS1W-BC023	
											3 slots		0.11	---	CS1W-BC033
											5 slots		0.11	---	CS1W-BC053
											8 slots		0.11	---	CS1W-BC083
											10 slots		0.11	---	CS1W-BC103
Dimensions (mm)	2 slots (CS1W-BC022/023): 198.5 x 157 (W x H) 3 slots (CS1W-BC032/033): 260 x 132 (W x H) 5 slots (CS1W-BC052/053): 330 x 132 (W x H) 8 slots (CS1W-BC082/083): 435 x 132 (W x H) 10 slots (CS1W-BC102/103): 505 x 132 (W x H)														

Note 1: C200H-series Units cannot be mounted to CS-series Expansion Backplanes (CS1W-BI□□2).

Note 2: CS-series Units cannot be mounted to C200HX/HG/HE Expansion I/O Backplanes (C200HW-BI□□2).

Expansion Racks

Select the Backplane, Power Supply Unit, and Expansion Cable. If the expansion length is more than 12 m, an I/O Interface Unit is also required.

Expansion Backplanes

● Normal Expansion (Not Long-distance Expansion)

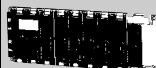
Product name	Specifications		Mountable configuration units					Current consumption (A)		Model	Standards						
			Basic I/O Units			Special I/O Units		CPU Bus Units	5 V system			26 V system					
			CS-series Basic I/O Unit	C200H-series Basic I/O Unit	C200H Group-2 High-density I/O Unit	CS-series Special I/O Unit	C200H-series Special I/O Unit	CS-series CPU Bus Unit									
CS1 Expansion Backplanes 	For CS-series Unit only Note: C200H-series Units cannot be mounted.	3 slots	Yes	No	No	Yes	No	Yes	0.23	---	CS1W-BI032	U, C, N, L, CE					
		5 slots							0.23	---	CS1W-BI052						
		8 slots							0.23	---	CS1W-BI082						
		10 slots							0.23	---	CS1W-BI102						
	For both CS/C200H-series Units	3 slots							Yes	Yes	Yes		Yes	Yes	0.23	---	CS1W-BI033
		5 slots													0.23	---	CS1W-BI053
		8 slots													0.23	---	CS1W-BI083
		10 slots													0.23	---	CS1W-BI103
	Dimensions (mm)		3 slots (CS1W-BI032/033): 260 x 132 (W x H) 5 slots (CS1W-BI052/053): 330 x 132 (W x H) 8 slots (CS1W-BI082/083): 435 x 132 (W x H) 10 slots (CS1W-BI102/103): 505 x 132 (W x H)														
	C200HX/HG/HE Expansion I/O Backplane 	For C200H-series Unit only Note: CS-series Units cannot be mounted.	3 slots	No	Yes	Yes	No	Yes	No	0.15	---		C200HW-BI031	U, C, N, L, CE			
5 slots			0.15							---	C200HW-BI051						
8 slots			0.15							---	C200HW-BI081-V1						
10 slots			0.15							---	C200HW-BI101-V1						
Dimensions (mm)		3 slots (C200HW-BI031): 189 x 132 (W x H) 5 slots (C200HW-BI051): 259 x 132 (W x H) 8 slots (C200HW-BI081-V1): 364 x 132 (W x H) 10 slots (C200HW-BI101-V1): 434 x 132 (W x H)															

● Long-distance Expansion

Product name	Specifications		CPU Unit mounted to CPU Backplane	Mountable configuration units					Current consumption (A)		Model	Standards						
				Basic I/O Units			Special I/O Units		CPU Bus Units	5 V system			26 V system					
				CS-series Basic I/O Unit	C200H-series Basic I/O Unit	C200H Group-2 High-density I/O Unit	CS-series Special I/O Unit	C200H-series Special I/O Unit	CS-series CPU Bus Unit									
CS1 Expansion Backplanes 	For CS-series Unit only Note: C200H-series Units cannot be mounted.	3 slots	CS1 CPU Unit	Yes	No	Yes	No	Yes *	0.23	---	CS1W-BI032	U, C, N, CE						
		5 slots							0.23	---	CS1W-BI052							
		8 slots							0.23	---	CS1W-BI082							
		10 slots							0.23	---	CS1W-BI102							
	For both CS/C200H-series Units	3 slots							CS1 CPU Unit	Yes	No	Yes	No	Yes *	0.23	---	CS1W-BI033	U, C, N, L, CE
		5 slots													0.23	---	CS1W-BI053	
		8 slots													0.23	---	CS1W-BI083	
		10 slots													0.23	---	CS1W-BI103	

*CS-series CPU Bus Units can be mounted in a Long-distance Expansion Rack, but the I/O refreshing time is longer than it is when the CPU Bus Unit is mounted in the CPU Rack.

- Note 1:** C200H-series Units cannot be mounted to CS-series Expansion Backplanes (CS1W-BI□□2).
Note 2: CS-series Units cannot be mounted to C200HX/HG/HE Expansion I/O Backplanes (C200HW-BI□□2).

■ I/O Control Unit (Required for long-distance expansion)

The CS1W-IC102 I/O Control Unit is mounted to a CPU Backplane or CS1 Expansion Backplane when expanding more than 12 m. A CV500-CN□□2 Long-distance Expansion Connecting Cable is used to connect the I/O Control Unit to a CS1W-II102 I/O Interface Unit.



Product name	Specifications	Mountable backplanes		Current consumption (A)		Model	Standards
		CPU backplane	CS1 Expansion Backplanes	5 V system	26 V system		
 I/O Control Unit	Required to expand more than 12 m. (Two CV500-TER01 Terminators are included.) Connecting cable: Connecting Cable for Long-distance Expansion CV500-CN□□2 Connecting unit: Interface Unit CS1W-II102	Yes	Yes	0.92	---	CS1W-IC102	U, C, N, L, CE

■ I/O Interface Unit (Required for long-distance expansion)

The CS1W-II102 I/O Interface Unit is mounted to a CS1 Expansion Backplane and connected to a CV500-CN□□2 Long-distance Expansion Connecting Cable when expanding more than 12 m.

Product name	Specifications	Current consumption (A)		Model	Standards
		5 V system	24 V system		
 I/O Interface Unit	Required to expand more than 12 m. Mountable backplane: CS1 Expansion Backplanes Connecting cable: Connecting Cable for Long-distance Expansion CV500-CN□□2	0.23	---	CS1W-II102	U, C, N, L, CE

■ Connecting Cables for Expansion Backplanes

Product name	Specifications	Model	Standards
 CS1 I/O Connecting Cables	Connects a CPU Backplane or CS1 Expansion Backplane to a CS1 Expansion Backplane.	Cable length: 0.3 m CS1W-CN313	N, L, CE
		Cable length: 0.7 m CS1W-CN713	
		Cable length: 2 m CS1W-CN223	
		Cable length: 3 m CS1W-CN323	
		Cable length: 5 m CS1W-CN523	
		Cable length: 10 m CS1W-CN133	
 CS1 to C200H I/O Connecting Cables	Connects a CPU Backplane or CS1 Expansion Backplane to a C200HX/HG/HE Expansion I/O Backplane.	Cable length: 0.3 m CS1W-CN311	N, L, CE
		Cable length: 0.7 m CS1W-CN711	
		Cable length: 2 m CS1W-CN221	
		Cable length: 3 m CS1W-CN321	
		Cable length: 5 m CS1W-CN521	
		Cable length: 10 m CS1W-CN131	
 C200H I/O Connecting Cables	Connects a C200HX/HG/HE Expansion I/O Backplane to a C200HX/HG/HE Expansion I/O Backplane.	Cable length: 0.3 m C200H-CN311	N, L, CE
		Cable length: 0.7 m C200H-CN711	
		Cable length: 2 m C200H-CN221	
		Cable length: 5 m C200H-CN521	L, CE
		Cable length: 10 m C200H-CN131	

■ Connecting Cables for Long-distance Expansion

Product name	Specifications	Model	Standards
 Connecting Cables for Long-distance Expansion	Connects a Long-distance I/O Control Unit to an I/O Interface Unit.	Cable length: 0.3 m CV500-CN312	N, L, CE
		Cable length: 0.6 m CV500-CN612	
		Cable length: 1 m CV500-CN122	
		Cable length: 2 m CV500-CN222	
		Cable length: 3 m CV500-CN322	
		Cable length: 5 m CV500-CN522	
		Cable length: 10 m CV500-CN132	
		Cable length: 20 m CV500-CN232	
		Cable length: 30 m CV500-CN332	
		Cable length: 40 m CV500-CN432	
Cable length: 50 m CV500-CN532			

Reading the production number

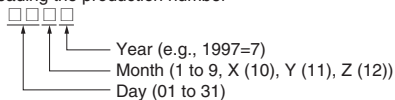

Programming Devices

Support Software

Product name	Specifications	Model		Standards	
		Number of Model Standards licenses	Media		
FA Integrated Tool Package CX-One Ver.4.□	The CX-One is a comprehensive software package that integrates Support Software for OMRON PLCs and components. CX-One runs on the following OS. Windows 2000 (Service Pack 4 or higher), XP, Vista, or 7 Note: Except for 64-bit version. CX-One Version 4.□ includes CX-Programmer Ver.9.□ and CX-Simulator Ver. 1.□. For details, refer to the CX-One catalog (Cat. No. R134).	1 license	CD	CXONE-AL01C-V4	---
			DVD	CXONE-AL01D-V4	
		3 licenses	CD	CXONE-AL03C-V4	
			DVD	CXONE-AL03D-V4	
		10 licenses	CD	CXONE-AL10C-V4	
			DVD	CXONE-AL10D-V4	
		30 licenses	CD	CXONE-AL30C-V4	
			DVD	CXONE-AL30D-V4	
		50 licenses	CD	CXONE-AL50C-V4	
			DVD	CXONE-AL50D-V4	

Note 1: Site licenses are available for users who will run CX-One on multiple computers. Ask your OMRON sales representative for details.

Note 2: Before ordering the software on a DVD, be sure that your computer and drive are compatible with the DVD format.

Support Software in CX-One Ver.4.□

The following tables lists the Support Software that can be installed from CX-One.

Support Software in CX-One	Outline
CX-Programmer Ver.9.□	Application software to create and debug programs for SYSMAC CS/CJ/CP/NSJ-series, C-series, and CVM1/C-series CPU Units, and to create and monitor data for SYSMAC CS/CJ-series Position Control Units.
CX-Integrator Ver.2.□	Application software to build and set up FA networks, such as Controller Link, DeviceNet, CompoNet, CompoWay/F, and Ethernet networks. The Routing Table Component and Data Link Component can be started from here. DeviceNet Configuration functionality is also included.
Switch Box Utility Ver.1.□	Utility software that helps you to debug PLCs. It helps you to monitor the I/O status and to monitor/change present values within the PLC you specify.
CX-Protocol Ver.1.□	Application software to create protocols (communications sequences) between SYSMAC CS/CJ/CP/NSJ-series or C200HX/HG/HE Serial Communications Boards/Units and general-purpose external devices.
CX-Simulator Ver.1.□	Application software to simulate SYSMAC CS/CJ/CP/NSJ-series CPU Unit operation on the computer to debug PLC programs without a CPU Unit.
CX-Position Ver.2.□	Application software to create and monitor data for SYSMAC CS/CJ-series Position Control Units. (except for High-speed type)
CX-Motion-NCF Ver.1.□	Application software to create and monitor data for SYSMAC CS/CJ-series Position Control Units with MECHATROLINK-II * interface (NC□71).
CX-Motion-MCH Ver.2.□	Application software to create data, and monitor program, and monitor data for SYSMAC CS/CJ-series Motion Control Units with MECHATROLINK-II * interface (MCH71).
CX-Motion Ver.2.□	Application software to create data for SYSMAC CS/CJ-series, C200HX/HG/HE, and CVM1/CV-series Motion Control Units, and to create and monitor motion control programs.
CX-Drive Ver.1.□	Application software to set and control data for Inverters and Servos.
CX-Process Tool Ver.5.□	Application software to create and debug function block programs for SYSMAC CS/CJ-series Loop Controllers (Loop Control Units/Boards, Process Control CPU Units, and Loop Control CPU Units).
Faceplate Auto-Builder for NS Ver.3.□	Application software that automatically outputs screen data as project files for NS-series PTs from tag information in function block programs created with the CX-Process Tool.
CX-Designer Ver.3.□	Application software to create screen data for NS-series PTs.
NV-Designer Ver.1.□	Applications software to create screen data for NV-series small PTs.
CX-Configurator FDT Ver.1.□	Applications software to setting various units by installing its DTM module.
CX-Thermo Ver.4.□	Application software to set and control parameters in components such as Temperature Control Units.
CX-FLnet Ver.1.□	Application software for system setting and monitoring of SYSMAC CS/CJ-series FL-net Units.
Network Configurator Ver.3.□	Application software for setting the tag datalink at the built-in EtherNet/IP port.
CX-Server Ver.4.□	Middleware necessary for CX-One applications to communicate with OMRON components, such, such as PLCs, Display Devices, and Temperature Control Units.
PLC Tools (Installed automatically.)	A group of components used with CX-One applications, such as the CX-Programmer and CX-Integrator. Includes the following: I/O tables, PLC memory, PLC Setup, Data Tracing/Time Chart Monitoring, PLC Error Logs, File Memory, PLC clock, Routing Tables, and Data Link Tables.

*MECHATROLINK II is a registered trademark of the MECHATROLINK Members Association.

Note: If the complete CX-One package is installed, approximately 2.8 GB of Hard disk space will be required.



■ Connecting Cables for CX-One Components (e.g. CX-Programmer)

Product name		Specifications			Model	Standards	
		Applicable computers	Connection configuration	Cable length			Remarks
Cables between Programming Device (computer) and peripheral port		IBM PC/AT or compatible computer	IBM PC/AT or compatible computer + CS1W-CN226/626 + Peripheral port of CPU Unit	2 m	Can be used for both peripheral bus and host link.	CS1W-CN226	
				6 m		CS1W-CN626	
		IBM PC/AT or compatible computer (D-Sub 9-pin)	The following configuration can be used when using an RS-232C cable to connect to an IBM PC/AT or compatible computer. IBM PC/AT or compatible computer + XW2Z-200S-CV/V or XW2Z-500S-CV/V + Peripheral port of CPU Unit.	0.1 m	Use when connecting to the peripheral port with a XW2Z-200S-CV/V or XW2Z-500S-CV/V RS-232C Cable.	CS1W-CN118	
Connecting Cables between Programming Device (computer) and RS-232C port		IBM PC/AT or compatible computer (D-Sub 9-pin)	IBM PC/AT or compatible computer + XW2Z-200S-CV/V or XW2Z-500S-CV/V + RS-232C port of CPU Unit or Serial Communications Board/Unit	2 m	Can be used for both peripheral bus and host link, and is equipped with an anti-static connector.	XW2Z-200S-CV	
				5 m		XW2Z-500S-CV	
			Note: We recommend the following configuration if the CX-Programmer is always connected and you want to avoid switching to the other CPU Unit when an error occurs.	2 m	Can be used for host link only. Cannot be used for peripheral bus.	XW2Z-200S-V	
				5 m		XW2Z-500S-V	
USB-Serial Conversion Cable (PC driver CD-ROM included) Conforms to USB 1.1 Specifications.		IBM PC/AT or compatible computer (D-Sub 9-pin)	IBM PC/AT or compatible computer + CS1W-CIF31 + CS1W-CN226/626 + Peripheral port of CPU Unit	0.5 m	The USB Serial Conversion Cable connects to the serial connecting cable, which connects to the PLC's peripheral port or RS-232C port.	CS1W-CIF31	
							Can be used for both peripheral bus and host link.
			IBM PC/AT or compatible computer + CS1W-CIF31 + XW2Z-200S-CV/500S-CV + CS1W-CN118 + Peripheral port of CPU Unit				Can be used for both peripheral bus and host link.
			IBM PC/AT or compatible computer + CS1W-CIF31 + XW2Z-200S-V/500S-V + CS1W-CN118 + Peripheral port of CPU Unit				Can be used for host link only. Cannot be used for peripheral bus.
			IBM PC/AT or compatible computer + CS1W-CIF31 + XW2Z-200S-CV/500S-CV + CS1W-CN118 + RS-232C port of CPU Unit or Serial Communications Board/Unit				Can be used for both peripheral bus and host link.
IBM PC/AT or compatible computer + CS1W-CIF31 + XW2Z-200S-V/500S-V + RS-232C port of CPU Unit or Serial Communications Board/Unit	Can be used for host link only. Cannot be used for peripheral bus.						

Note: Either of the serial communications modes listed in the following table can be used to connect CX-One Support Software (e.g., the CX-Programmer) to a CS1-series PLC.

Serial communications mode	Features
Peripheral bus	This mode can provide high-speed communications, so this mode is normally used to connect when using CX-One component software such as the CX-Programmer. <ul style="list-style-type: none"> • Supports 1:1 connections only. • The Programming Device's baud rate
Host Link (SYSWAY)	This is a general host computer communications protocol, which supports 1:1 and 1:N connections. <ul style="list-style-type: none"> • Host link operates at a slower speed than peripheral bus. • Host link supports 1:N connections as well as long-distance connections when RS-422A/RS-485 is used for a connection through a modem or optical adapter.

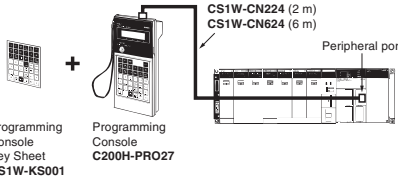
■ Programming Console





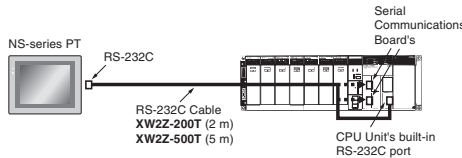



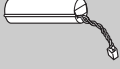

Product name	Specifications	Cable model (Separate item)	Connection configuration	Model	Standards
Programming Console 	Can be connected to the CPU Unit's peripheral port only. Cannot be connected to the RS-232C port. A CS1W-KS001-E Programming Console Key Sheet is required (sold separately).	CS1W-CN224: 2 m CS1W-CN624: 6 m		C200H-PRO27-E	U, C, N, CE
Programming Console Key Sheet	For the following Programming Consoles: C200H-PRO27			CS1W-KS001-E	CE
Programming Console Connecting Cable 	For C200H-PRO27 connection, Cable length: 2 m			CS1W-CN224	
	For C200H-PRO27 connection, Cable length: 6 m			CS1W-CN624	

■ Connecting Cables for NS-series PTs





Product name	Specifications		Model	Standards
	Connection configuration	Cable length		
Connecting Cables for NS-series PTs 	Connecting Cables between an NS-series PT and the RS-232C port of CPU Unit or Serial Communications Board/Unit 	2 m	XW2Z-200T	---
		5 m	XW2Z-500T	
	Connecting Cables between an NS-series PT and the peripheral port of CPU Unit	2 m	XW2Z-200T-2	
		5 m	XW2Z-500T-2	

Accessories and Maintenance Parts

Product name	Specifications	Model	Standards
Memory Cards 	Flash Memory, 128 MB	HMC-EF183	---
	Memory Card Adapter (Adapts to a computer's PCMCIA card slot.)	HMC-AP001	CE

Product name	Specifications	Model	Standards	
Battery Set 	Battery for CS-series maintenance Note 1: A battery is included with the CPU Unit as standard equipment. 2: The battery life is 5 years at an ambient temperature of 25°C, although the lifetime can be as short as 1.1 years under adverse temperature and power conditions. 3: Use a replacement battery that was manufactured within the last two years.	CS1W-BAT01		
I/O Terminal Cover 	Cover for 10-pin Terminal Blocks	C200H-COV11	---	
Terminal Block Cover 	Short-circuit protection for 10-pin Terminal Blocks (package of 10 covers); for 8 I/O points	C200H-COV02		
	Short-circuit protection for 19-pin Terminal Blocks (package of 10 covers); for 12 I/O points	C200H-COV03		
Connector Cover 	Protective cover for unused Power Supply Unit connector in C200H Backplane	C500-COV01		
	Protective cover for unused CS-series Unit connector in Backplane	CV500-COV01		
Space Units 	For unused I/O slot spaces in the CS1W-BC□□3/BI□□3 or C200HW-BI□□□	C200H-SP001	N, L	
	For unused I/O slot spaces in the CS1W-BC□□2/BI□□2 or CS1W-BC□□3/BI□□3	CS1W-SP001	---	
Backplane Insulation Plate (for C200HX/HG/HE Expansion I/O Backplane) 	Used to electrically insulate the Backplane from the control panel as a noise countermeasure.	10 slots	C200HW-ATTA2	N, L, CE
		8 slots	C200HW-ATT82	
		5 slots	C200HW-ATT52	
		3 slots	C200HW-ATT32	
Contact relays 	24 VDC For Relay Output Unit C200H-OC221/222/223/224/225	G6B-1174P-FD-US-M DC24		
Programming Console Mounting Bracket 	Use to mount a C200H-PRO27 Programming Console in a control panel.	C200H-ATT01	---	
Terminator 	Connected to last Long-distance Expansion Rack (for CS1W-IC102). Two are included with the CS1W-IC102 I/O Control Unit.	CV500-TER01	U, C	
RS-422A Converter 	Converts RS-232C to RS-422A/RS-485.	CJ1W-CIF11	UC1, N, L, CE	
RS-232C/RS-422A Link Adapter	RS-232C × 1 port RS-422A terminal block	NT-AL001	---	



DIN Track Mounting Accessories

Product name	Specifications	Model	Standards
DIN Track Mounting Bracket 	1 set (package of 2 brackets)	C200H-DIN01	---
DIN Track 	Track length: 50 cm Height: 7.3 mm	PFP-50N	
	Track length: 1 m Height: 7.3 mm	PFP-100N	
	Track length: 1 m Height: 16 mm	PFP-100N2	
End Plate 	Note: Order in lots of 10.	PFP-M	
Spacer 		PFP-S	



Basic I/O Units

CS1 Basic I/O Units



Input Units

Unit type	Product name	Specifications	Mountable Racks						Words required	Current consumption (A)		Model	Standards	
			CPU Rack		C200HX/HG/HE Expansion I/O Rack	CS1 Expansion Rack		CS1 Long-distance Expansion Rack		SYSMAC BUS Slave Rack	I/O bits: CIO 0000 to CIO 0319			5 V system
			□□3	□□2		□□3	□□2							
CS1 Basic I/O Units	DC Input Unit 	24 VDC, 7 mA, 16 inputs	Yes	Yes	No	Yes	Yes	Yes	No	1 word	0.10	---	CS1W-ID211	UC1, N, L, CE
		24 VDC, 6 mA, 32 inputs	Yes	Yes	No	Yes	Yes	Yes	No	2 words	0.15	---	CS1W-ID231	
		24 VDC, 7 mA, 64 inputs	Yes	Yes	No	Yes	Yes	Yes	No	4 words	0.15	---	CS1W-ID261	
		24 VDC, approx. 5 mA, 96 inputs	Yes	Yes	No	Yes	Yes	Yes	No	6 words	0.20	---	CS1W-ID291	U, C, N, L, CE
	AC Input Unit 	100 to 120 VAC, 16 inputs 100 to 120 VDC, 16 inputs	Yes	Yes	No	Yes	Yes	Yes	No	1 word	0.11	---	CS1W-IA111	UC1, N, L, CE
		200 to 240 VAC, 16 inputs	Yes	Yes	No	Yes	Yes	Yes	No	1 word	0.11	---	CS1W-IA211	UC, N, L, CE

Output Units

Unit type	Product name	Specifications	Mountable Racks						Words required	Current consumption (A)		Model	Standards		
			CPU Rack		C200HX/HG/HE Expansion I/O Rack	CS1 Expansion Rack		CS1 Long-distance Expansion Rack		SYSMAC BUS Slave Rack	5 V system			26 V system	
			□□3	□□2		□□3	□□2								
CS1 Basic I/O Units	Relay Output Units 	250 VAC or 120 VDC, 2 A max. Independent contacts, 8 outputs	Yes	Yes	No	Yes	Yes	Yes	No	1 word	0.10	0.006 per simultaneously ON outputs	CS1W-OC201	UC1, N, L, CE	
		250 VAC or 120 VDC, 2 A max. 16 outputs	Yes	Yes	No	Yes	Yes	Yes	No	1 word	0.13	---	CS1W-OC211		
	Transistor Output Units 	12 to 24 VDC, 0.5 A 16 outputs	Sinking	Yes	Yes	No	Yes	Yes	Yes	No	1 word	0.17	---	CS1W-OD211	UC1, N, L, CE
		24 VDC, 0.5 A 16 outputs	Sourcing	Yes	Yes	No	Yes	Yes	Yes	No	1 word	0.17	---	CS1W-OD212	U, C, N, L, CE
		12 to 24 VDC, 0.5 A 32 outputs	Sinking	Yes	Yes	No	Yes	Yes	Yes	No	2 words	0.27	---	CS1W-OD231	UC1, N, L, CE
		24 VDC, 0.5 A 32 outputs	Sourcing	Yes	Yes	No	Yes	Yes	Yes	No	2 words	0.27	---	CS1W-OD232	U, C, N, L, CE
		12 to 24 VDC, 0.3 A 64 outputs	Sinking	Yes	Yes	No	Yes	Yes	Yes	No	4 words	0.39	---	CS1W-OD261	UC1, N, L, CE
		24 VDC, 0.3 A 64 outputs	Sourcing	Yes	Yes	No	Yes	Yes	Yes	No	4 words	0.39	---	CS1W-OD262	
		12 to 24 VDC, 0.1 A 96 outputs	Sinking	Yes	Yes	No	Yes	Yes	Yes	No	6 words	0.48	---	CS1W-OD291	U, C, N, L, CE
		12 to 24 VDC, 0.1 A 96 outputs	Sourcing	Yes	Yes	No	Yes	Yes	Yes	No	6 words	0.48	---	CS1W-OD292	
	Triac Output Units 	250 VAC, 2 A max. 8 outputs		Yes	Yes	No	Yes	Yes	Yes	No	1 word	0.23 max. (0.07 + 0.02 × number of ON points)	---	CS1W-OA201	UC, N, L, CE
		250 VAC, 0.5 A max. 16 outputs		Yes	Yes	No	Yes	Yes	Yes	No	1 word	0.406 max. (0.07 + 0.021 × number of ON points)	---	CS1W-OA211	

■ I/O Units

Unit type	Product name	Specifications	Mountable Racks							Words required	Current consumption (A)		Model	Standards
			CPU Rack	C200HX/HG/HE Expansion I/O Rack	CS1 Expansion Rack	CS1 Long-distance Expansion Rack	SYSMAC BUS Slave Rack	5 V system	26 V system					
			CS1W-BC □□3 □□2		CS1W-BI □□3 □□2									
CS1 Basic I/O Units	DC Input/Transistor Output Unit 	24 VDC, 6 mA 32 inputs	Yes	Yes	No	Yes	Yes	Yes	No	2 input words and 2 output words	0.27	---	CS1W-MD261	UC1, N, L, CE
		12 to 24 VDC, 0.3 A 32 outputs Sourcing												
		24 VDC, 6 mA 32 inputs											CS1W-MD262	
		24 VDC, 0.3 A 32 outputs Sourcing												
	TTL I/O Unit 	24 VDC, approx. 5 mA 48 inputs	Yes	Yes	No	Yes	Yes	Yes	No	3 input words and 3 output words	0.35	---	CS1W-MD291	U, C, N, L, CE
		12 to 24 VDC, 0.1 A 48 outputs Sinking												
		24 VDC, approx. 5 mA 48 inputs												
		12 to 24 VDC, 0.1 A 48 outputs Sourcing	CS1W-MD292											
		5 VDC 32 inputs, 32 outputs		CS1W-MD561	UC, N, L, CE									

Note: The C200H-ID001 (8 no-voltage contact inputs, NPN) and C200H-ID002 (8 no-voltage contact inputs, PNP) cannot be used.

● Applicable Connectors

Connector for CS1 Basic I/O Units (32 inputs, 64 inputs, 32 outputs, 64 outputs, 32 inputs/32 outputs)

Name	Connection	Applicable Units	Model	Standards
Applicable Connectors	Soldered	FCN-361J040-AU Connector FCN-360C040-J2 Connector cover	C500-CE404 (Included with Unit)	---
	Crimped	FCN-363J040 Housing FCN-363J-AU Contact FCN-360C040-J2 Connector cover	C500-CE405	
	Pressure welded	FCN-367J040-AU/F	C500-CE403	

Connector for CS1 Basic I/O Units (96 inputs, 96 outputs, 48 inputs/48 outputs)

Name	Connection	Applicable Units	Model	Standards
Applicable Connectors	Soldered	FCN-361J056-AU Connector FCN-360C056-J3 Connector cover	CS1W-CE561 (Included with Unit)	---
	Crimped	FCN-363J056 Housing FCN-363J-AU Contact FCN-360C056-J3 Connector cover	CS1W-CE562	
	Pressure welded	FCN-367J056-AU	CS1W-CE563	

■ Interrupt Input Unit

Unit type	Product name	Specifications						Mountable Racks						Words required	Current consumption (A)		Model	Standards	
		I/O points	Input voltage	Input current	Input pulse width		External connection	CPU Rack		C200HX/HG/HE Expansion I/O Rack	CS1 Expansion Rack		CS1 Long-distance Expansion Rack		SYSMAC BUS Slave Rack	5 V system			26 V system
					ON time	OFF time		CS1W-BC □□3 □□2	CS1W-BI □□3 □□2										
CS1 Basic I/O Units	Interrupt Input Unit 	16 inputs	24 VDC	7 mA	0.1 ms max.	0.5 ms max.	Removable terminal block	Yes	Yes	No	* Yes	* Yes	* Yes	No	1 word	0.10	---	CS1W-INT01	UC1, N, L, CE

*Interrupt inputs are not supported on these Racks (i.e., used as normal I/O Unit).

■ Quick-response Input Unit

Unit type	Product name	Specifications						Mountable Racks						Words required	Current consumption (A)		Model	Standards	
		I/O points	Input voltage	Input current	Input pulse width (ON time)		External connection	CPU Rack		C200HX/HG/HE Expansion I/O Rack	CS1 Expansion Rack		CS1 Long-distance Expansion Rack		SYSMAC BUS Slave Rack	5 V system			26 V system
					CS1W-BC □□3 □□2	CS1W-BI □□3 □□2													
CS1 Basic I/O Units	Quick-response Input Unit 	16 inputs	24 VDC	7 mA	0.1 ms max.		Removable terminal block	Yes	Yes	No	Yes	Yes	Yes	No	1 word	0.10	---	CS1W-IDP01	UC1, N, L, CE

■ B7A Interface Unit





Unit type	Product name	Specifications	Mountable Racks						Words required	Current consumption (A)		Model	Standards	
			CPU Rack		C200HX/HG/HE Expansion I/O Rack	CS1 Expansion Rack		CS1 Long-distance Expansion Rack		SYSMAC BUS Slave Rack	5 V system			26 V system
			CS1W-BC □□3 □□2	CS1W-BI □□3 □□2										
CS1 Basic I/O Unit	B7A Interface Unit 	32 inputs	Yes	Yes	No	Yes	Yes	Yes	No	2 words	0.09	---	CS1W-B7A12	UC1, CE
		32 outputs	Yes	Yes	No	Yes	Yes	Yes	No	2 words	0.09	---	CS1W-B7A02	
		16 inputs/outputs	Yes	Yes	No	Yes	Yes	Yes	No	1 input word and 1 output word	0.09	---	CS1W-B7A21	
		32 inputs/outputs	Yes	Yes	No	Yes	Yes	Yes	No	2 input words and 2 output words	0.09	---	CS1W-B7A22	

■ Safety Relay Unit





Unit type	Product name	Specifications						Mountable Racks						Words required	Current consumption (A)		Model	Standards	
		Function	Power supply voltage	Number of input words	Contact type (Safety output)	Number of general inputs	External connections	CPU Rack		C200HX/HG/HE Expansion I/O Rack	CS1 Expansion Rack		CS1 Long-distance Expansion Rack		SYSMAC BUS Slave Rack	5 V system			26 V system
								CS1W-BC □□3 □□2	CS1W-BI □□3 □□2										
CS1 Basic I/O Units	Safety Relay Unit 	Emergency stop Unit	24 VDC	1 word or 2 words (Shared inputs)	DPST-NO	4 inputs/common	Removable terminal block	Yes	Yes	No	Yes	Yes	Yes	No	1 word	0.10	---	CS1W-SF200	U, C, CE

C200H Basic I/O Units and C200H Group-2 High-density I/O Units

■ Input Units

Unit type	Product name	Specifications	Mountable Racks							Words required (I/O bits: CIO 0000 to CIO 0319)	Current consumption (A)		Model	Standards
			CPU Rack		C200HX/HG/HE Expansion I/O Rack	CS1 Expansion Rack		CS1 Long-distance Expansion Rack	SYSMAC BUS Slave Rack		5 V system	26 V system		
			CS1W-BC □□3 □□2	Yes No		CS1W-BI □□3 □□2	Yes No							
C200H Basic I/O Units	DC Input Unit 	12 to 24 VDC, 8 inputs	Yes	No	Yes	Yes	No	No	Yes	1 word	0.01	---	C200H-ID211	U, C, N, L, CE
		24 VDC, 16 inputs	Yes	No	Yes	Yes	No	No	Yes	1 word	0.01	---	C200H-ID212	UC1, N, L, CE
	AC Input Unit 	100 to 120 VAC, 8 inputs	Yes	No	Yes	Yes	No	No	Yes	1 word	0.01	---	C200H-IA121	U, C, N, L
		100 to 120 VAC, 16 inputs	Yes	No	Yes	Yes	No	No	Yes	1 word	0.01	---	C200H-IA122	
		100 to 120 VAC, 16 inputs	Yes	No	Yes	Yes	No	No	Yes	1 word	0.01	---	C200H-IA122V	CE
		200 to 240 VAC, 8 inputs	Yes	No	Yes	Yes	No	No	Yes	1 word	0.01	---	C200H-IA221	U, C, N, L
		200 to 240 VAC, 16 inputs	Yes	No	Yes	Yes	No	No	Yes	1 word	0.01	---	C200H-IA222	
	200 to 240 VAC, 16 inputs	Yes	No	Yes	Yes	No	No	Yes	1 word	0.01	---	C200H-IA222V	CE	
	AC/DC Input Unit 	12 to 24 VAC/VDC, 8 inputs	Yes	No	Yes	Yes	No	No	Yes	1 word	0.01	---	C200H-IM211	U, C, N, L, CE
		24 VAC/VDC, 16 inputs	Yes	No	Yes	Yes	No	No	Yes	1 word	0.01	---	C200H-IM212	
C200H Group-2 High-density I/O Units	DC Input Unit 	24 VDC, 32 inputs	Yes	No	Yes	Yes	No	No	No	2 words	0.10	---	C200H-ID216	U, C, N, L, CE
		24 VDC, 64 inputs	Yes	No	Yes	Yes	No	No	No	4 words	0.12	---	C200H-ID217	
		24 VDC, 32 inputs, 6 mA	Yes	No	Yes	Yes	No	No	No	2 words	0.10	---	C200H-ID218	
		24 VDC, 64 inputs, 6 mA	Yes	No	Yes	Yes	No	No	No	4 words	0.12	---	C200H-ID219	
		12 VDC, 64 inputs	Yes	No	Yes	Yes	No	No	No	4 words	0.12	---	C200H-ID111	U, C, N, L

■ Output Units

Unit type	Product name	Specifications	Mountable Racks							Words required	Current consumption (A)		Model	Standards
			CPU Rack		C200HX/HG/HE Expansion I/O Rack	CS1 Expansion Rack		CS1 Long-distance Expansion Rack	SYSMAC BUS Slave Rack		5 V system	26 V system		
			CS1W-BC □□3 □□2	Yes No		CS1W-BI □□3 □□2	Yes No							
C200H Basic I/O Units	Relay Contact Output Unit 	250 VAC or 24 VDC, 2 A max. 8 outputs	Yes	No	Yes	Yes	No	No	Yes	1 word	0.01	0.075 per 8 simultaneously ON outputs	C200H-OC221	U, C, N, L
		250 VAC or 24 VDC, 2 A max. 12 outputs	Yes	No	Yes	Yes	No	No	Yes	1 word	0.01		C200H-OC222	
		250 VAC or 24 VDC, 2 A max. 12 outputs	Yes	No	Yes	Yes	No	No	Yes	1 word	0.008	0.09 per 8 simultaneously ON outputs	C200H-OC222N	CE
		250 VAC or 24 VDC, 2 A max. 16 outputs	Yes	No	Yes	Yes	No	No	Yes	1 word	0.05	0.075 per 8 simultaneously ON outputs	C200H-OC225	UC1, N, L
		250 VAC or 24 VDC, 2 A max. 16 outputs	Yes	No	Yes	Yes	No	No	Yes	1 word	0.03	0.09 per 8 simultaneously ON outputs	C200H-OC226N	CE
		250 VAC or 24 VDC, 2 A max. Independent contacts: 5 outputs	Yes	No	Yes	Yes	No	No	Yes	1 word	0.01	0.075 per 8 simultaneously ON outputs	C200H-OC223	U, C, N, L
		250 VAC or 24 VDC, 2 A max. Independent contacts: 8 outputs	Yes	No	Yes	Yes	No	No	Yes	1 word	0.01	0.075 per 8 simultaneously ON outputs	C200H-OC224	
		250 VAC or 24 VDC, 2 A max. Independent contacts: 8 outputs	Yes	No	Yes	Yes	No	No	Yes	1 word	0.01	0.09 per 8 simultaneously ON outputs	C200H-OC224N	CE
	Transistor Output Unit 	12 to 48 VDC, 1 A 8 outputs Sinking	Yes	No	Yes	Yes	No	No	Yes	1 word	0.14	---	C200H-OD411	U, C, N, L, CE
		24 VDC, 2.1 A 8 outputs Sinking	Yes	No	Yes	Yes	No	No	Yes	1 word	0.14	---	C200H-OD213	
		5 to 24 VDC, 0.3 A 8 outputs Sourcing	Yes	No	Yes	Yes	No	No	Yes	1 word	0.01	0.075 per 8 simultaneously ON outputs	C200H-OD216	U, C, N, L
		24 VDC, 0.3 A 12 outputs Sinking	Yes	No	Yes	Yes	No	No	Yes	1 word	0.16	---	C200H-OD211	U, C, N, L, CE
		5 to 24 VDC, 0.3 A 12 outputs Sourcing	Yes	No	Yes	Yes	No	No	Yes	1 word	0.01	0.075 per 8 simultaneously ON outputs	C200H-OD217	
		24 VDC, 0.3 A 16 outputs Sinking	Yes	No	Yes	Yes	No	No	Yes	1 word	0.18	---	C200H-OD212	
		24 VDC, 1 A 16 outputs Sourcing Short-circuit protection	Yes	No	Yes	Yes	No	No	Yes	1 word	0.16	---	C200H-OD21A	CE
		Triac Output Unit 	250 VAC, 1.2 A max. 8 outputs	Yes	No	Yes	Yes	No	No	Yes	1 word	0.18	---	C200H-OA223
	250 VAC, 0.5 A max. 12 outputs		Yes	No	Yes	Yes	No	No	Yes	1 word	0.27	---	C200H-OA224	U, C, N, L, CE
	C200H Group-2 High-density I/O Units	Transistor Output Units 	4.5 to 26.4 V, 16 to 100 mA 32 outputs Sinking	Yes	No	Yes	Yes	No	No	No	2 words	0.27	---	C200H-OD218
24 VDC, 0.5 A 32 outputs Sourcing Short-circuit protection			Yes	No	Yes	Yes	No	No	No	2 words	0.48	---	C200H-OD21B	U, C, CE
4.5 to 26.4 V, 16 to 100 mA 64 outputs Sinking			Yes	No	Yes	Yes	No	No	No	4 words	0.48	---	C200H-OD219	U, C, N, L, CE

Interrupt Input Unit

Unit type	Product name	Specifications						Mountable Racks					Words required	Current consumption (A)		Model	Standards		
		I/O points	Input voltage	Input current	Input pulse width		External connection	CPU Rack		C200HX/HG/HE Expansion I/O Rack	CS1 Expansion Rack			CS1 Long-distance Expansion Rack	SYSMAC BUS Slave Rack			5 V system	26 V system
					ON time	OFF time		□□3	□□2		□□3	□□2							
C200H Basic I/O Units	Interrupt Input Unit 	8 inputs	12 to 24 VDC	10 mA	0.2 ms max.	0.5 ms max.	Removable terminal block	Yes	No	*	*	No	No	1 word	0.02	---	C200HS-INT01	U, C, CE	

*Interrupt inputs are not supported on these Racks (i.e., used as normal I/O Unit).

Analog Timer Unit

Unit type	Product name	Specifications	Mountable Racks					Words required	Current consumption (A)		Model	Standards		
			CPU Rack		C200HX/HG/HE Expansion I/O Rack	CS1 Expansion Rack			CS1 Long-distance Expansion Rack	SYSMAC BUS Slave Rack			5 V system	26 V system
			□□3	□□2		□□3	□□2							
C200H Basic I/O Units	Analog Timer Unit 	4-point timer	Yes	No	Yes	Yes	No	No	Yes	1 word	0.06	---	C200H-TM001	U, C



B7A Interface Units

Unit type	Product name	Specifications	Mountable Racks					Words required	Current consumption (A)		Model	Standards		
			CPU Rack		C200HX/HG/HE Expansion I/O Rack	CS1 Expansion Rack			CS1 Long-distance Expansion Rack	SYSMAC BUS Slave Rack			5 V system	26 V system
			□□3	□□2		□□3	□□2							
C200H Basic I/O Units	B7A Interface Units	16 inputs	Yes	No	Yes	Yes	No	No	Yes	1 word	0.10	---	C200H-B7A11	U, C, CE
		16 outputs	Yes	No	Yes	Yes	No	No	Yes	1 word	0.10	---	C200H-B7A01	
C200H Group-2 High-density I/O Units		32 inputs	Yes	No	Yes	Yes	No	No	No	2 words	0.10	---	C200H-B7A12	U, C
		32 outputs	Yes	No	Yes	Yes	No	No	No	2 words	0.10	---	C200H-B7A02	U, C, CE
		16 inputs/outputs	Yes	No	Yes	Yes	No	No	No	1 input word and 1 output word	0.10	---	C200H-B7A21	
		32 inputs/outputs	Yes	No	Yes	Yes	No	No	No	2 input words and 2 output words	0.10	---	C200H-B7A22	

Special I/O Units, CPU Bus Units, and Inner Boards

CS1 Special I/O Units, CPU Bus Units, and Inner Boards

■ Temperature Sensor Input Units (Process I/O Units)



Unit type	Product name	Specifications					External connection	Mountable Racks						No. of unit numbers allocated	Current consumption (A)		Model	Standards
		I/O points	Signal range selection	Signal range	Conversion speed	CPU Rack		C200HX/HG/HE Expansion I/O Rack	CS1 Expansion Rack		CS1 Long-distance Expansion Rack	SYSMAC BUS Slave Rack	5 V system		26 V system			
									CS1W-BC	CS1W-BI								
						<input type="checkbox"/> 3 <input type="checkbox"/> 2	<input type="checkbox"/> 3 <input type="checkbox"/> 2											
CS1 Special I/O Units	Isolated-type Thermocouple Input Units 	4 inputs	4 independent	B, E, J, K, L, N, R, S, T, U, WRe5-26, PL II, ±100 mV	20 ms/4 inputs, 10 ms/2 inputs	Yes	Yes	No	Yes	Yes	Yes	No	1	0.12	0.08	CS1W-PTS11	UC1, N, CE	
		4 inputs	4 independent	R, S, K, J, T, L, B	250 ms/4 inputs	Yes	Yes	No	Yes	Yes	Yes	No	1	0.25	---	CS1W-PTS51	UC1, CE	
		8 inputs	8 independent	R, S, K, J, T, L, B	250 ms/8 inputs	Yes	Yes	No	Yes	Yes	Yes	No	1	0.18	0.06	CS1W-PTS55		
		4 inputs	4 independent	B, E, J, K, N, R, S, T, ±80mV	150 ms/4 inputs	Yes	Yes	No	Yes	Yes	Yes	No	1	0.15	0.15	CS1W-PTS01-V1		
	Isolated-type Resistance Thermometer Input Units 	4 inputs	4 independent	Pt100 Ω (JIS, IEC), JPt100 Ω, Pt50 Ω, Ni508.4 Ω	20 ms/4 inputs, 10 ms/2 inputs	Yes	Yes	No	Yes	Yes	Yes	No	1	0.12	0.07	CS1W-PTS12	UC1, N, CE	
		4 inputs	4 independent	Pt100 Ω (JIS, IEC), JPt100 Ω	250 ms/4 inputs	Yes	Yes	No	Yes	Yes	Yes	No	1	0.25	---	CS1W-PTS52	UC1, CE	
		8 inputs	8 independent	Pt100 Ω (JIS, IEC), JPt100 Ω	250 ms/8 inputs	Yes	Yes	No	Yes	Yes	Yes	No	1	0.18	0.06	CS1W-PTS56		
		4 inputs	4 independent	Pt100 Ω (JIS, IEC), JPt100 Ω	100 ms/4 inputs	Yes	Yes	No	Yes	Yes	Yes	No	1	0.15	0.15	CS1W-PTS02		
	Isolated-type Resistance Thermometer Input Unit (Ni508.4 W)	4 inputs	4 independent	Ni508.4 Ω	100 ms/4 inputs	Yes	Yes	No	Yes	Yes	Yes	No	1	0.15	0.15	CS1W-PTS03		

■ Analog Input Units

● Analog Input Units

Unit type	Product name	Specifications						Mountable Racks					No. of unit numbers allocated	Current consumption (A)		Model	Standards		
		I/O points	Signal range selection	Signal range	Resolution	Conversion speed	External connection	CPU Rack		C200HX/HG/HE Expansion I/O Rack	CS1 Expansion Rack			CS1 Long-distance Expansion Rack	SYSMAC BUS Slave Rack			5 V system	26 V system
								CS1W-BC	CS1W-BI		CS1W-BI	CS1W-BI							
CS1 Special I/O Units	Analog Input Units 	4 inputs	4 independent	1 to 5 V, 0 to 5 V, -10 to 10 V, 4 to 20 mA	1/8,000 (Can also be set to 1/4,000.)	250 µs/ input (Can also be set to 1 ms/ input.)	Removable terminal block	Yes	Yes	No	Yes	Yes	Yes	No	1 unit number's words	0.12	0.09	CS1W-AD041-V1	UC1, N, L, CE
		8 inputs	8 independent	1 to 5 V, 0 to 5 V, -10 to 10 V, 4 to 20 mA	1/8,000 (Can also be set to 1/4,000.)	250 µs/ input (Can also be set to 1 ms/ input.)	Removable terminal block	Yes	Yes	No	Yes	Yes	Yes	No		0.12	0.09	CS1W-AD081-V1	
		16 inputs	16 independent	1 to 5 V, 0 to 5 V, -10 to 10 V, 4 to 20 mA	1/8,000 (Can also be set to 1/4,000.)	250 µs/ input (Can also be set to 1 ms/ input.)	MIL connector	Yes	Yes	No	Yes	Yes	Yes	No	2 unit numbers' words	0.15	0.06	CS1W-AD161	UC1, CE
	Connector-Terminal Block Conversion Unit for CS1W-AD161	---						Slim terminal block Terminal: 34, dimension: 128 x 40 x 39 mm					---		XW2D-34G6		---		
							Connection cable Cable length: 2 m					---		XW2Z-200C		---			

● Isolated-type DC Input Units (Process I/O Units)

Unit type	Product name	Specifications				Mountable Racks					No. of unit numbers allocated	Current consumption (A)		Model	Standards		
		I/O points	Signal range	Conversion speed	External connection	CPU Rack		C200HX/HG/HE Expansion I/O Rack	CS1 Expansion Rack			CS1 Long-distance Expansion Rack	SYSMAC BUS Slave Rack			5 V system	26 V system
						CS1W-BC	CS1W-BI		CS1W-BI	CS1W-BI							
CS1 Special I/O Units	Isolated-type DC Input Units 	4 inputs	4 to 20 mA, 0 to 20 mA, 0 to 10 V, ±10 V, 0 to 5 V, ±5 V, 1 to 5 V, 0 to 1.25 V, ±1.25 V	20 ms/ 4 inputs, 10 ms/ 2 inputs	Removable terminal block	Yes	Yes	No	Yes	Yes	Yes	No	1 unit number's words	0.12	0.12	CS1W-PDC11	UC1, N, CE
		8 inputs	4 to 20 mA, 0 to 10 V, 0 to 5 V, 1 to 5 V	250 ms/ 8 inputs		Yes	Yes	No	Yes	Yes	Yes	No		0.18	0.06	CS1W-PDC55	
		4 inputs	4 to 20 mA, 0 to 20 mA, 1 to 5 V, 0 to 5 V, ±5 V, 0 to 10 V, ±10 V	100 ms/ 4 inputs		Yes	Yes	No	Yes	Yes	Yes	No		0.15	0.16	CS1W-PDC01	
	Isolated-type 2-Wire Transmitter Input Unit 	4 inputs	4 to 20 mA, 1 to 5 V	100 ms/ 4 inputs		Yes	Yes	No	Yes	Yes	Yes	No		0.15	0.16	CS1W-PTW01	UC1, CE
		Power Transducer Input Unit	8 inputs	0 to 1 mA, ±1 mA		200 ms/ 8 inputs	Yes	Yes	No	Yes	Yes	Yes		No	0.15	0.08	CS1W-PTR01
			DC Analog Input Unit (100 mV)	8 inputs		0 to 100 mV, ±100 mV	200 ms/ 8 inputs	Yes	Yes	No	Yes	Yes		Yes	No	0.15	0.08

■ Analog Output Units

● Analog Output Units

Unit type	Product name	Specifications						Mountable Racks					No. of unit numbers allocated	Current consumption (A)		Model	Standards		
		I/O points	Signal range selection	Signal range	Resolution	Conversion speed	External connection	CPU Rack		C200HX/HG/HE Expansion I/O Rack	CS1 Expansion Rack			CS1 Long-distance Expansion Rack	SYSMAC BUS Slave Rack			5 V system	26 V system
								CS1W-BC	CS1W-BI		CS1W-BI	CS1W-BI							
CS1 Special I/O Units	Analog Output Units 	4 outputs	4 independent	1 to 5 V, 0 to 5 V, 0 to 10 V, -10 to 10 V, 4 to 20 mA	1/4000	1 ms/output	Removable terminal block	Yes	Yes	No	Yes	Yes	Yes	No	1 unit number's words	0.13	0.18	CS1W-DA041	UC1, N, L, CE
		8 outputs	8 independent	1 to 5 V, 0 to 5 V, 0 to 10 V, -10 to 10 V	1/4000	1 ms/output		Yes	Yes	No	Yes	Yes	Yes	No		0.13	0.18	CS1W-DA08V	U, C, N, L, CE
		8 outputs	8 independent	4 to 20 mA	1/4000	1 ms/output		Yes	Yes	No	Yes	Yes	Yes	No		0.13	0.25	CS1W-DA08C	

● Isolated-type Control Output Units (Process I/O Units)

Unit type	Product name	Specifications						Mountable Racks					No. of unit numbers allocated	Current consumption (A)		Model	Standards	
		I/O points	Signal range selection	Signal range	Conversion speed	External connection	CPU Rack		C200HX/HG/HE Expansion I/O Rack	CS1 Expansion Rack		CS1 Long-distance Expansion Rack		SYSMAC BUS Slave Rack	5 V system			26 V system
							CS1W-BC	CS1W-BI		CS1W-BI	CS1W-BI							
CS1 Special I/O Units	Isolated-type Control Output Units 	4 outputs	4 independent	4 to 20 mA, 1 to 5V	100 ms/outputs	Removable terminal block	Yes	Yes	No	Yes	Yes	Yes	No	1 unit number's words	0.15	0.16	CS1W-PMV01	UC1, CE
		4 outputs	4 independent	0 to 10V, ±10V, 0 to 5V, ±5V, 0 to 1V, ±1V	40 ms/outputs		Yes	Yes	No	Yes	Yes	Yes	No		0.12	0.12	CS1W-PMV02	

■ Analog I/O Units

Unit type	Product name	Specifications						Mountable Racks					No. of unit numbers allocated	Current consumption (A)		Model	Standards		
		I/O points	Signal range selection	Signal range	Resolution	Conversion speed	External connection	CPU Rack		C200HX/HG/HE Expansion I/O Rack	CS1 Expansion Rack			CS1 Long-distance Expansion Rack	SYSMAC BUS Slave Rack			5 V system	26 V system
								CS1W-BC	CS1W-BI		CS1W-BI	CS1W-BI							
CS1 Special I/O Units	Analog I/O Units 	4 inputs	4 independent	1 to 5V, 0 to 5V, 0 to 10V, -10 to 10V, 4 to 20 mA	1/4000	1 ms/output	Removable terminal block	Yes	Yes	No	Yes	Yes	Yes	No	1 unit number's words	0.20	0.20	CS1W-MAD44	U, C, N, L, CE
		4 outputs	4 independent	1 to 5V, 0 to 5V, 0 to 10V, -10 to 10V	1/4000	1 ms/output		Yes	Yes	No	Yes	Yes	Yes	No					

■ Isolated-type Pulse Input Units (Process I/O Units)

Unit type	Product name	Specifications	Mountable Racks					No. of unit numbers allocated	Current consumption (A)		Model	Standards		
			CPU Rack	C200HX/HG/HE Expansion I/O Rack	CS1 Expansion Rack	CS1 Long-distance Expansion Rack	SYSMAC BUS Slave Rack		5 V system	26 V system				
			CS1W-BC □□3 □□2		CS1W-BI □□3 □□2									
CS1 Special I/O Units	Isolated-type Pulse Input Unit 	4 pulse inputs	Yes	Yes	No	Yes	Yes	Yes	No	1 unit number's words	0.20	0.16	CS1W-PPS01	UC1, CE

■ Loop Control Board/Loop Control Unit

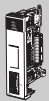
Unit type	Product name	Specifications	Mountable Racks					No. of unit numbers allocated	Current consumption (A)		Model	Standards	
			CPU Rack	C200HX/HG/HE Expansion I/O Rack	CS1 Expansion Rack	CS1 Long-distance Expansion Rack	SYSMAC BUS Slave Rack		5 V system	26 V system			
			CS1W-BC □□3 □□2		CS1W-BI □□3 □□2								
CS1 Inner Board	Loop Control Board 	50 blocks max. (total control blocks and operation blocks)	*1 Yes	*1 Yes	No	No	No	No	---	0.22 ^{*2}	---	CS1W-LCB01	UC1, N, CE
		500 blocks max. (total control blocks and operation blocks)								0.22 ^{*2}	---	CS1W-LCB05	
CX-Process Monitor Plus Ver.2.□		OS: Windows NT4.0, 2000, or XP	Monitoring Software for Loop Controller					1 license			WS02-LCMC1-EV2	---	
								3 licenses			WS02-LCMC1-EV2L03		

*1. Mount a CS1W-LCB01/05 Loop Control Board in a CS1G/H-CPU□□H CPU Unit or a CS1D-CPU□□S CS1D Duplex System CPU Unit.

*2. NT-AL001 Link Adapters consume an additional 0.15 A each when used.

■ High-speed Counter Units

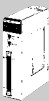
Unit type	Product name	Specifications			Mountable Racks					No. of unit numbers allocated	Current consumption (A)		Model	Standards	
		Number of count channels	Encoder A and B inputs, and Z pulse input signal	Maximum count speed	CPU Rack	C200HX/HG/HE Expansion I/O Rack	CS1 Expansion Rack	CS1 Long-distance Expansion Rack	SYSMAC BUS Slave Rack		5 V system	26 V system			
					CS1W-BC □□3 □□2		CS1W-BI □□3 □□2								
CS1 Special I/O Units	High-speed Counter Units 	2	Input voltage: 5 VDC, 12 VDC, or 24 VDC (only 1 axis for 5 V or 12 V input)	50 kHz	Yes	Yes	No	Yes	Yes	Yes	No	4 unit numbers' words	0.36	---	CS1W-CT021
			RS-422 line driver	500 kHz											
		4	Input voltage: 5 VDC, 12 VDC, or 24 VDC (up to 2 axes for 5 V or 12 V input)	50 kHz	Yes	Yes	No	Yes	Yes	Yes	No		0.45	---	CS1W-CT041
			RS-422 line driver	500 kHz											

■ Customizable Counter Units

Unit type	Product name	Specifications	Mountable Racks						No. of unit numbers allocated	Current consumption (A)		Model	Standards	
			CPU Rack		C200HX/HG/HE Expansion I/O Rack	CS1 Expansion Rack		CS1 Long-distance Expansion Rack		SYSMAC BUS Slave Rack	5 V system			26 V system
			CS1W-BC			CS1W-BI								
CS1 Special I/O Units	 <p>Customizable Counter Units</p>	Two-axis pulse input Two-axis pulse output 12 DC inputs 8 transistor outputs	Yes	Yes	No	Yes	Yes	Yes	No	1	0.80	---	CS1W-HCP22-V1	U, C, CE
		Single-axis pulse input 1 analog input 2 analog outputs 12 DC inputs 8 transistor outputs	Yes	Yes	No	Yes	Yes	Yes	No	1	0.75	0.15	CS1W-HCA12-V1	
		Two-axis pulse input 2 analog outputs 12 DC inputs 8 transistor outputs	Yes	Yes	No	Yes	Yes	Yes	No	1	0.75	0.15	CS1W-HCA22-V1	
		12 DC inputs 8 transistor outputs	Yes	Yes	No	Yes	Yes	Yes	No	1	0.60	---	CS1W-HIO01-V1	



■ Position Control Units

Unit type	Product name	Specifications		Mountable Racks						No. of unit numbers allocated	Current consumption (A)		Model	Standards	
				CPU Rack		C200HX/HG/HE Expansion I/O Rack	CS1 Expansion Rack		CS1 Long-distance Expansion Rack		SYSMAC BUS Slave Rack	5 V system			26 V system
				Control output interface	Number of axes		CS1W-BC								
CS1 Special I/O Units	 <p>Position Control Units</p>	Pulse-train, open-collector outputs	1 axis	Yes	Yes	No	Yes	Yes	Yes	No	1	0.25	---	CS1W-NC113	U, C, N, L, CE
			2 axes	Yes	Yes	No	Yes	Yes	Yes	No	1	0.25	---	CS1W-NC213	
			4 axes	Yes	Yes	No	Yes	Yes	Yes	No	2	0.36	---	CS1W-NC413	
		Pulse-train, line-driver outputs	1 axis	Yes	Yes	No	Yes	Yes	Yes	No	1	0.25	---	CS1W-NC133	
			2 axes	Yes	Yes	No	Yes	Yes	Yes	No	1	0.25	---	CS1W-NC233	
			4 axes	Yes	Yes	No	Yes	Yes	Yes	No	2	0.36	---	CS1W-NC433	
	Relay Unit for Servo	For use with the CS1W-NC1□□3		Number of axes supported: 1									XW2B-20J6-1B	---	
		For use with the CS1W-NC2□□3/NC4□□3		Number of axes supported: 2									XW2B-40J6-2B		
		For use with the CS1W-NC□□□3		Number of axes supported: 2, with communications support									XW2B-40J6-4A		
	Servo Relay Unit Connecting Cable (Position Control Unit end)	Open-collector output	For use with the CS1W-NC113	Connectable Servo Drive: OMNUC G5 Series, G Series, W Series, or SMARTSTEP 2		Number of axes supported: 1		Cable length: 0.5 m		XW2Z-050J-A6	---				
								Cable length: 1 m		XW2Z-100J-A6					
				Connectable Servo Drive: SMARTSTEP Junior or A Series		Cable length: 0.5 m		XW2Z-050J-A8							
Cable length: 1 m						XW2Z-100J-A8									
For use with the CS1W-NC213/NC413			Connectable Servo Drive: OMNUC G5 Series, G Series, W Series, or SMARTSTEP 2		Number of axes supported: 2		Cable length: 0.5 m		XW2Z-050J-A7						
							Cable length: 1 m		XW2Z-100J-A7						
		Connectable Servo Drive: SMARTSTEP Junior or A Series		Cable length: 0.5 m		XW2Z-050J-A9									
				Cable length: 1 m		XW2Z-100J-A9									
Line-driver outputs		For use with the CS1W-NC133	Connectable Servo Drive: OMNUC G5 Series, G Series, W Series, or SMARTSTEP 2		Number of axes supported: 1		Cable length: 0.5 m		XW2Z-050J-A10						
							Cable length: 1 m		XW2Z-100J-A10						
			Connectable Servo Drive: SMARTSTEP Junior or A Series		Cable length: 0.5 m		XW2Z-050J-A12								
		Cable length: 1 m			XW2Z-100J-A12										
	For use with the CS1W-NC233/NC433	Connectable Servo Drive: OMNUC G5 Series, G Series, W Series, or SMARTSTEP 2		Number of axes supported: 2		Cable length: 0.5 m		XW2Z-050J-A11							
						Cable length: 1 m		XW2Z-100J-A11							
Connectable Servo Drive: SMARTSTEP Junior or A Series		Cable length: 0.5 m		XW2Z-050J-A13											
		Cable length: 1 m		XW2Z-100J-A13											

■ Position Control Unit with MECHATROLINK-II interface

Unit type	Product name	Specifications		Mountable Racks						No. of unit numbers allocated	Current consumption (A)		Model	Standards		
				CPU Rack		C200HX/HG/HE Expansion I/O Rack	CS1 Expansion Rack		CS1 Long-distance Expansion Rack		SYSMAC BUS Slave Rack	5 V system			26 V system	
				Control output interface	Number of axes		CS1W-BC	CS1W-BI								
	Position Control Unit with MECHATROLINK-II interface 	Control commands are sent using MECHATROLINK-II communications. Direct operation from ladder program. Control modes: Position control, speed control, and torque control	2 axes								1 unit numbers' words	0.36	---	CS1W-NC271	UC1, CE	
			4 axes	Yes	Yes	No	Yes	Yes	Yes	No				CS1W-NC471		
			16 axes											CS1W-NCF71		
CS1 CPU Bus Unit	MECHATROLINK-II Interface Unit	To connect OMNUC W-series Servo Drive (R88D-WT□) (Made by Yaskawa Corporation) The model number at the right is used to order from OMRON.										FNY-NS115				
	MECHATROLINK-II Cables	To connect MECHATROLINK-II compliant devices (Made by Yaskawa Corporation) The model numbers at the right are used to order from OMRON.										Cable length: 0.5 m	FNY-W6003-A5	---		
												Cable length: 1 m	FNY-W6003-01			
												Cable length: 3 m	FNY-W6003-03			
												Cable length: 5 m	FNY-W6003-05			
												Cable length: 10 m	FNY-W6003-10			
												Cable length: 20 m	FNY-W6003-20			
										Cable length: 30 m	FNY-W6003-30					
	MECHATROLINK-II Terminator	Terminating resistance for MECHATROLINK-II (Made by Yaskawa Corporation) The model number at the right is used to order from OMRON.										FNY-W6022				
	MECHATROLINK-II Repeater	Communications repeater.										FNY-REP2000				

■ Motion Control Units

Unit type	Product name	Specifications		Mountable Racks						No. of unit numbers allocated	Current consumption (A)		Model	Standards	
				CPU Rack		C200HX/HG/HE Expansion I/O Rack	CS1 Expansion Rack		CS1 Long-distance Expansion Rack		SYSMAC BUS Slave Rack	5 V system			26 V system
				Control output interface	Number of axes		CS1W-BC	CS1W-BI							
CS1 Special I/O Units	Motion Control Unit (G-language programming)  	Analog outputs	4 axes	Yes	Yes	No	Yes	Yes	Yes	No	5 unit numbers' words	0.70 (1.00 A when a Teaching Box is connected)	---	CS1W-MC421-V1	U, C, CE
	2 axes		Yes	Yes	No	Yes	Yes	Yes	No	3 unit numbers' words	0.60 (0.80 A when a Teaching Box is connected)	---	CS1W-MC221-V1		
		Teaching Box	---							---	CVM1-PRO01-V1	CE			
		Teaching Box Connecting Cable	---							Cable length: 2 m	CV500-CN224	L, CE			
		ROM Cassette	---							---	CVM1-MP702-V1	CE			
		MC Terminal Block Conversion Unit *	For 2 axes							---	XW2B-20J6-6	---			
			For 4 axes							---	XW2B-40J6-7				
		MC Terminal Block Conversion Unit Cable	---							Cable length: 1 m	XW2Z-100J-F1				

*Simplifies I/O connector wiring.

■ Motion Control Unit with MECHATROLINK-II interface

Unit type	Product name	Specifications	Mountable Racks						No. of unit numbers allocated	Current consumption (A)		Model	Standards	
			CPU Rack		C200HX/HG/HE Expansion I/O Rack	CS1 Expansion Rack		CS1 Long-distance Expansion Rack		SYSMAC BUS Slave Rack	5 V system			26 V system
			CS1W-BC □□3 □□2			CS1W-BI □□3 □□2								
CS1 CPU Bus Unit	Motion Control Unit with MECHATROLINK-II interface 	For position, speed, and torque references via MECHATROLINK-II 32 axes max. (physical axes: 30 axes and virtual axes: 2 axes) Special motion control language	Yes	Yes	No	Yes	Yes	Yes	No	1 unit number's words	0.80	---	CS1W-MCH71	UC1, CE
	MECHATROLINK-II Interface Unit	To connect OMNUC W-series Servo Drive (R88D-WT□) (Made by Yaskawa Corporation) The model number at the right is used to order from OMRON.									FNY-NS115		---	
	MECHATROLINK-II Cables	To connect MECHATROLINK-II compliant devices (Made by Yaskawa Corporation) The model numbers at the right are used to order from OMRON.									Cable length: 0.5 m	FNY-W6003-A5		
											Cable length: 1 m	FNY-W6003-01		
											Cable length: 3 m	FNY-W6003-03		
											Cable length: 5 m	FNY-W6003-05		
											Cable length: 10 m	FNY-W6003-10		
											Cable length: 20 m	FNY-W6003-20		
	Cable length: 30 m	FNY-W6003-30												
	MECHATROLINK-II Terminator	Terminating resistance for MECHATROLINK-II (Made by Yaskawa Corporation) The model number at the right is used to order from OMRON.									FNY-W6022			
MECHATROLINK-II Repeater	Required for more than 15 slave or 30 m.									FNY-REP2000				
24-VDC I/O Module for MECHATROLINK-II	64 inputs/outputs									FNY-IO2310				
MECHATROLINK-II Counter Module	Two reversible counters									FNY-PL2900				
MECHATROLINK-II Pulse Output Module	Pulse-string positioning on two channels									FNY-PL2910				

Serial Communications Boards/Serial Communications Units

Unit type	Product name	Specifications	Mountable Racks					No. of unit numbers allocated	Current consumption (A)		Model	Standards		
			CPU Rack		C200HX/HG/HE Expansion I/O Rack	CS1 Expansion Rack			CS1 Long-distance Expansion Rack	SYSMAC BUS Slave Rack			5 V system	26 V system
			CS1W-BC □□3 □□2	Yes		Yes	CS1W-BI □□3 □□2							
CS1 Inner Board	Serial Communications Board	Two RS-232C ports	*4 Yes	*4 Yes	No	No	No	No	No	---	*5 0.28	---	CS1W-SCB21-V1	U, C, N, L, CE
		One RS-232C port and one RS-422A/485 port									*5 0.36	---		
CS1 CPU Bus Unit	Serial Communications Unit	Two RS-232C ports	Yes	Yes	No	Yes	Yes	Yes	No	1 unit number's words	*5 0.29	---	CS1W-SCU21-V1	UC1, N, L, CE
		Two RS-422A/485 ports	Yes	Yes	No	Yes	Yes	Yes	No		0.40	---	CS1W-SCU31-V1	

- *1. The serial gateway function is supported by Serial Communications Boards and Units with unit version 1.2 or later only.
- *2. The Serial Communications Unit's no-protocol function is supported by Serial Communications Units with unit version 1.2 or later only. In addition the CPU Unit must be unit version 3.0 or later.
- *3. The Modbus-RTU Slave function is supported by Serial Communications Boards and Units with unit version 1.3 or later only.
- *4. One Board can be mounted in the Inner Board slot of the CPU Unit.
- *5. NT-AL001 Link Adapters consume an additional 0.15 A each when used.

EtherNet/IP Unit

Unit type	Product name	Specifications		Mountable Racks					No. of unit numbers allocated	Current consumption (A)		Model	Standards		
		Communications cable	Communications functions	CPU Rack		C200HX/HG/HE Expansion I/O Rack	CS1 Expansion Rack			CS1 Long-distance Expansion Rack	SYSMAC BUS Slave Rack			5 V system	26 V system
				CS1W-BC □□3 □□2	Yes		Yes	CS1W-BI □□3 □□2							
CS1 CPU Bus Unit	EtherNet/IP Unit	STP (shielded twisted-pair) cable of category 5, 5e, or higher.	Tag data link message service	* Yes	* Yes	No	* Yes	* Yes	* Yes	No	1 unit number's words	0.41	---	CS1W-EIP21	UC1, N, L, CE



*Up to eight CS1W-EIP21 EtherNet/IP Units can be mounted to the CS1 CPU Backplane (CS1W-BC□□□) and CS1 Expansion Backplanes (CS1W-BI□□□) of one PLC.

EtherNet Unit





Unit type	Product name	Specifications		Mountable Racks					No. of unit numbers allocated	Current consumption (A)		Model	Standards		
				CPU Rack		C200HX/HG/HE Expansion I/O Rack	CS1 Expansion Rack			CS1 Long-distance Expansion Rack	SYSMAC BUS Slave Rack			5 V system	26 V system
				CS1W-BC □□3 □□2	Yes		Yes	CS1W-BI □□3 □□2							
CS1 CPU Bus Unit	EtherNet Unit	100BASE-TX Cable	FINS communications service (TCP/IP and UDP/IP), FTP server function, socket service, mail send service, mail reception (remote command reception), auto-adjustment of PLC's internal clock, and server host name specification	* Yes	* Yes	No	* Yes	* Yes	* Yes	No	1 unit number's words	0.38	---	CS1W-ETN21	UC1, N, L, CE

*Up to four CS1W-ETN21 Ethernet Units can be mounted to the CS1 CPU Backplane (CS1W-BC□□□) and CS1 Expansion Backplanes (CS1W-BI□□□) of one PLC.

● Industrial Switching Hubs

Product name	Appearance	Specifications			Accessories	Current Consumption (A)	Model	Standards
		Functions	No. of ports	Failure detection				
Industrial Switching Hubs		Quality of Service (QoS): EtherNet/IP control data priority Failure detection: Broadcast storm and LSI error detection 10/100BASE-TX, Auto-Negotiation	3	No	• Power supply connector	0.22	W4S1-03B	UC, CE
	5		No	0.22		W4S1-05B		
			5	Yes	• Power supply connector • Connector for informing error	0.22	W4S1-05C	CE

■ Controller Link Units



Unit type	Product name	Specifications	Mountable Racks							No. of unit numbers allocated	Current consumption (A)		Model	Standards
			CPU Rack		C200HX/HG/HE Expansion I/O Rack	CS1 Expansion Rack		CS1 Long-distance Expansion Rack	SYSMAC BUS Slave Rack		5 V system	26 V system		
			CS1W-BC □□3 □□2	CS1W-BI □□3 □□2										
CS1 CPU Bus Unit	Controller Link Unit	Wired shielded twisted-pair cable *1 	*4 Yes	*4 Yes	No	*4 Yes	*4 Yes	Yes	No	1 unit number's words	0.33	---	CS1W-CLK23	UC1, N, L, CE
		Optical ring H-PCF cable *2 	*4 Yes	*4 Yes	No	*4 Yes	*4 Yes	Yes	No		0.52	---	CS1W-CLK13	
		Optical ring GI cable *3 	*4 Yes	*4 Yes	No	*4 Yes	*4 Yes	Yes	No		0.65	---	CS1W-CLK53	
	Controller Link Support Board 	Wired shielded twisted-pair cable *1	• CD-ROM x 1 *5 • Installation Guide (W467) x 1 • Communications Connector x 1							---	3G8F7-CLK23-E		CE	
H-PCF optical model	• CD-ROM x 1 *5 • Installation Guide (W467) x 1 • Optical Fiber Cable Bracket x 1 • Power Supply Connector x 1							3G8F7-CLK13-E						
GI optical model								3G8F7-CLK53-E						

● Controller Link Options

Product name	Specifications	Model	Standards
Relay Terminal Block for Wired Controller Link Unit	Use for Wired Controller Link Units (set of 5).	CJ1W-TB101	---
Controller Link Repeater Unit 	Wire-to-Wire Model	CS1W-RPT01	UC1, CE
	Wire-to-Optical (H-PCF) Model *2	CS1W-RPT02	
	Wire-to-Optical (GI) Model *3	CS1W-RPT03	

- *1. Use the following special cable for shielded, twisted-pair cable.
 - ESVC0.5 x 2C-13262 (Bando Electric Wire: Japanese Company)
 - ESNCO.5 x 2C-99-087B (Nihon Electric Wire & Cable Corporation: Japanese Company)
 - ESPC 1P x 0.5 mm² (Nagaoka Electric Wire Co., Ltd.: Japanese Company)
 - Li2Y-FCY2 x 0.56qmm (Kromberg & Schubert, Komtec Department: German Company)
 - 1 x 2 x AWG-20PE+Tr.CUSN+PVC (Draka Cables Industrial: Spanish Company)
 - #9207 (Belden: US Company)
- *2. When using wire-to-optical (H-PCF) cable, use a H-PCF cable (for both Controller Link and SYSMAC LINK) or a H-PCF optical fiber cable with connector.
- *3. When using wire-to-optical (GI) cable, use a GI optical cable (for Controller Link).
- *4.
 - Up to four Pre-Ver. 1.2 Controller Link Units (both CS1W-CLK21-V1 Wired Units and CS1W-CLK□2-V1 Optical Units combined) can be mounted to the CS1 CPU Backplane (CS1W-BC□□□) and CS1 Expansion Backplanes (CS1W-BI□□□) of one PLC.
 - Up to eight Controller Link Units with unit version 1.2 or later (both CS1W-CLK21-V1 Wired Units and CS1W-CLK□2-V1 Optical Units combined) can be mounted to the CS1 CPU Backplane (CS1W-BC□□□) and CS1 Expansion Backplanes (CS1W-BI□□□) of one PLC.
- *5. The CD-ROM contains the following software.
 - Controller Link (PCI) Driver
 - FinsGateway Version 2003 (PCI-CLK Edition)
 - FinsGateway Version 3 (PCI-CLK Edition)
 - Setup Diagnostic Utility
 - C Library

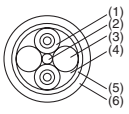
● H-PCF Cables (For Controller Link and SYSMAC LINK)

Product name		Application and construction		Specifications		Model	Standards
Optical Fiber Cable		 <ol style="list-style-type: none"> 1. Optical fiber single-core cord 2. Tension member (plastic-sheathed wire) 3. Filler (plastic) 4. Filler surrounding signal wires (plastic, yarn, or fiber) 5. Holding tape (plastic) 6. Heat-resistant PV sheath 	Two-core optical cable with tension member	Black	10 m	S3200-HCCB101	---
				Black	50 m	S3200-HCCB501	
				Black	100 m	S3200-HCCB102	
				Black	500 m	S3200-HCCB502	
				Black	1,000 m	S3200-HCCB103	
				Orange	10 m	S3200-HCCO101	
				Orange	50 m	S3200-HCCO501	
				Orange	100 m	S3200-HCCO102	
				Orange	500 m	S3200-HCCO502	
				Orange	1,000 m	S3200-HCCO103	
Optical Connectors (Crimp-cut)		Controller Link: CS1W-CLK13 CS1W-CLK12-V1 3G8F7-CLK13-E 3G8F7-CLK12-EV1 CS1W-RPT02 SYSMAC LINK: CS1W-SLK11 3G8F7-SLK11-E C200HW-SLK13/14	Half-lock		S3200-COCF2571	---	
		Controller Link: CS1W-CLK13 CS1W-CLK12-V1 3G8F7-CLK13-E 3G8F7-CLK12-EV1 CS1W-RPT02 SYSMAC LINK: 3G8F7-SLK11-E	Full-lock		S3200-COCF2071*		

*Full-lock Optical Connectors (Crimp-cut) (S3200-COCF2071) cannot be used with the CS1W-SLK11. Use a Half-lock Cable (S3200-COCF2571) or a H-PCF Optical Fiber Cable with Connectors (S3200-CN□□□□-□□-□□).

● **H-PCF Optical Fiber Cables with Connectors (Black Composite Cables with Two-Optical Lines and Two Power Supply Lines)**

Applicable	Appearance	Model	Standards
Controller Link SYSMAC LINK		S3200-CN□□□-20-20	---
		S3200-CN□□□-20-25	
		S3200-CN□□□-25-25	

Note: Optical connectors for H-PCF Optical Cables with Connectors are adhesive polished.

● **Cable Length**

The following cable lengths are available: 2 m, 5 m, 15 m, and 20 m. For lengths of 21 m or more, contact your OMRON sales representative.

● **Model Numbers**

(1) 2 m, 5 m, 10 m, 15 m, 20 m (2) 21 m or longer

(e.g.) S3200-CN□□□-20-25 (e.g.) S3200-CN-20-20

(1) H-PCF Optical Fiber Cable (2) Cable length (3) Specify the cable length in meters

(3) Connectors (both ends)

Length	No.	Connector lock
201	20	Full-lock
501	25	Half-lock
102		
152		
202		

● **Optical Connector Assembly Tool**

Product name	Applicable Units	Model	Maker	Standards
Optical Fiber Assembly Tool *	This tool is used on site for mounting crimp-cut connectors and hard plastic-clad silica optical fiber for optical transmission systems of SYSMAC C-series SYSBUS, SYSMAC LINK, and Controller Link.	CAK-0057	Sumitomo Electric Industries, Ltd.	---

* There is a risk of quality problems when using cables assembled by typical users, so we recommend purchasing cables with pre-attached connectors or having a qualified technician assemble the cables.

● **GI Optical Cables**

A qualified technician must select, assemble, and install GI Optical Fiber Cable, so always let an optical cable specialist handle the GI cable.

Usable Optical Fiber Cables and Optical Connectors

- Optical fiber types: Graded, indexed, multi-mode, all quartz glass, fiber (GI-type AGF cable)
- Optical fiber construction (core diameter/clad diameter): 62.5/125 μm or 50/125 μm
- Optical fiber optical characteristics of optical fiber: Refer to the tables.
- Optical connectors: ST connectors (IEC-874-10)

● **50/125 μm AGF Cables**

Items	Minimum	Typical	Maximum	Remarks
Numerical Aperture (N.A)	---	0.21	---	---
Transmission loss (dB)	---	---	3.0Lf	0.5 km ≤ Lf
			3.0 Lf + 0.2	0.2 km ≤ Lf ≤ 0.5 km
			3.0 Lf + 0.4	Lf ≤ 0.2 km
Connection loss (dB)	---	---	1.0	λ = 0.8 μm, one location
Transmission band width (MHz·km)	500	---	---	λ = 0.85 μm (LD)



Lf is Fiber length in km, Ta is ambient temperature, and λ is the peak wavelength of the test light source.

● **62.5/125 μm AGF Cables**

Items	Minimum	Typical	Maximum	Remarks
Numerical Aperture (N.A)	---	0.28	---	---
Transmission loss (dB)	---	---	3.5Lf	0.5 km ≤ Lf
			3.5Lf + 0.2	0.2 km ≤ Lf ≤ 0.5 km
			3.5Lf + 0.4	Lf ≤ 0.2 km
Connection loss (dB)	---	---	1.0	λ = 0.8 μm, one location
Transmission band width (MHz·km)	200	---	---	λ = 0.85 μm (LD)

Lf is Fiber length in km, Ta is ambient temperature, and λ is the peak wavelength of the test light source.

■ SYSMAC LINK Units

Unit type	Product name	Specifications		Mountable Racks							No. of unit numbers allocated	Current consumption (A)		Model	Standards
				CPU Rack		C200HX/HG/HE Expansion I/O Rack	CS1 Expansion Rack		CS1 Long-distance Expansion Rack	SYSMAC BUS Slave Rack		5 V system	26 V system		
				CS1W-BC □□3 □□2	*1 Yes		*1 Yes	*1 Yes							
CS1 CPU Bus Unit	 SYSMAC LINK Unit	Coaxial (5C-2V cable)	Data link and message communications functions	*1 Yes	*1 Yes	No	*1 Yes	*1 Yes	*1 Yes	No	1 unit number's words	0.48	---	CS1W-SLK21	U, C, CE
		Optical (H-PCF cable) *2		*1 Yes	*1 Yes	No	*1 Yes	*1 Yes	*1 Yes	No		CS1W-SLK11	U, C, N, CE		
	 SYSMAC LINK Support Board	Coaxial	The 3G8F7-SLK□□ SYSMAC LINK Support Board includes the FinsGateway communications middleware version 3.							---	3G8F7-SLK21-E		CE		
		Optical (H-PCF cable) *2									3G8F7-SLK11-E				
	F Adapter	---	One Adapter is included with each Coaxial-cable SYSMAC LINK Unit/Board.							---	C1000H-CE001		N		
	F Adapter Cover	---								---	C1000H-COV01		---		
Terminator	---	A Terminator must be installed at each node on the ends of the network.							---	C1000H-TER01		N			

*1. Up to four CS1W-SLK11/21 SYSMAC LINK Units can be mounted to the CPU Backplane and Expansion Backplanes of one PLC.

*2. When using wired optical (H-PCF) communications, use the H-PCF Cable or H-PCF Cable with pre-attached connectors.

■ FL-net Units

Unit type	Product name	Specifications		Mountable Racks							No. of unit numbers allocated	Current consumption (A)		Model	Standards
				CPU Rack		C200HX/HG/HE Expansion I/O Rack	CS1 Expansion Rack		CS1 Long-distance Expansion Rack	SYSMAC BUS Slave Rack		5 V system	26 V system		
				CS1W-BC □□3 □□2	* Yes		* Yes	* Yes							
CS1 CPU Bus Unit	 FL-net Unit	FL-net (OPCN-2) Ver. 2 specifications 100BASE-TX Cable	* Yes	* Yes	No	* Yes	* Yes	* Yes	No	1 unit number's words	0.38	---	CS1W-FLN22	UC1, CE	

*Up to four CS1W-FLN22 FL-net Units can be mounted to the CS1 CPU Backplane (CS1W-BC□□□) and CS1 Expansion Backplanes (CS1W-BI□□□) of one PLC.

■ DeviceNet Unit

Unit type	Product name	Specifications	Communications functions	Mountable Racks					No. of unit numbers allocated	Current consumption (A)		Model	Standards		
				CPU Rack		C200HX/HG/HE Expansion I/O Rack	CS1 Expansion Rack			CS1 Long-distance Expansion Rack	SYSMAC BUS Slave Rack			5 V system	26 V system
				CS1W-BC □□3 □□2			CS1W-BI □□3 □□2								
CS1 CPU Bus Unit		Functions as master and/or slave; allows control of 32,000 points max. per master.	<ul style="list-style-type: none"> Remote I/O Master communications (Fixed or user-set allocation) Remote I/O Slave communications (Fixed or user-set allocation) Message communications 	Yes	Yes	No	Yes	Yes	Yes	No	1 unit number's words	0.29	---	CS1W-DRM21-V1	UC1, N, L, CE
				Maximum number of Units: 16 if Configurator is used											

■ CompoNet Master Unit

Unit type	Product name	Specifications		Mountable Racks					No. of unit numbers allocated	Current consumption (A)		Model	Standards		
		Communications functions	Maximum number of I/O points per Master	CPU Rack		C200HX/HG/HE Expansion I/O Rack	CS1 Expansion Rack			CS1 Long-distance Expansion Rack	SYSMAC BUS Slave Rack			5 V system	26 V system
				CS1W-BC □□3 □□2			CS1W-BI □□3 □□2								
CS1 Special I/O Unit		<ul style="list-style-type: none"> Remote I/O communications Message communications 	Word Slave Units: 1,024 inputs and 1,024 outputs (2,048 I/O points total) Bit Slave Units: 256 inputs and 256 outputs (512 I/O points total)	Yes	Yes	No	Yes	Yes	Yes	No	1, 2, 4, or 8 unit numbers' words (variable)	0.40	---	CS1W-CRM21	U, U1, L, N, CE

■ CompoBus/S Master Unit

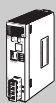
Unit type	Product name	Specifications		Mountable Racks					No. of unit numbers allocated	Current consumption (A)		Model	Standards		
		Communications functions	Maximum number of I/O points per Master	CPU Rack		C200HX/HG/HE Expansion I/O Rack	CS1 Expansion Rack			CS1 Long-distance Expansion Rack	SYSMAC BUS Slave Rack			5 V system	26 V system
				CS1W-BC □□3 □□2			CS1W-BI □□3 □□2								
CS1 Special I/O Unit		Remote I/O communications	256 max. (128 inputs and 128 outputs)	Yes	Yes	No	Yes	Yes	Yes	No	2 unit numbers' words	0.15	---	CS1W-SRM21	UC, CE
			128 max. (64 inputs and 64 outputs)						1 unit number's words						

■ ID Sensor Units

Unit type	Product name	Connecting ID System	Number of RW Heads	External power supply	Mountable Racks					No. of unit numbers allocated	Current consumption (A)		Model	Standards			
					CPU Rack		C200HX/HG/HE Expansion I/O Rack	CS1 Expansion Rack			CS1 Long-distance Expansion Rack	SYSMAC BUS Slave Rack			5 V system	26 V system	
					CS1W-BC □□3 □□2			CS1W-BI □□3 □□2									
CS1 Special I/O Unit		V680-series RFID system	1	Not required	Yes	Yes	No	Yes	Yes	Yes	No	1 unit number's words	0.26	0.13*	CS1W-V680C11	UC, CE	
			2	24 VDC	Yes	Yes	No	Yes	Yes	Yes	Yes	No	2 unit numbers' words	0.32	---		CS1W-V680C12
		V600-series RFID system	1	Not required	Yes	Yes	No	Yes	Yes	Yes	Yes	No	1 unit number's words	0.26	0.12		CS1W-V600C11
			2	24 VDC	Yes	Yes	No	Yes	Yes	Yes	Yes	No	2 unit numbers' words	0.32	---		CS1W-V600C12



* The current consumption is 0.28 A when connected to the V680-H01. For details, refer to the V680 Series RFID System Catalog (Cat. No. Q151).

■ GP-IB Interface Unit

Unit type	Product name	Specifications	Mountable Racks						No. of unit numbers allocated	Current consumption (A)		Model	Standards					
			CPU Rack		C200HX/HG/HE Expansion I/O Rack	CS1 Expansion Rack		CS1 Long-distance Expansion Rack		SYSMAC BUS Slave Rack	5 V system			26 V system				
			CS1W-BC □□3 □□2	Yes		Yes	CS1W-BI □□3 □□2								Yes	Yes		
CS1 Special I/O Unit	GP-IB Interface Unit 	Master or slave mode provided.	Yes	*	Yes	*	No	Yes	*	Yes	*	Yes	No	1 unit number's words	0.33	---	CS1W-GPI01	UC, CE

*Up to four GP-IP Interface Units can be mounted to the CS1 CPU Backplane (CS1W-BC□□□) and CS1 Expansion Backplanes (CS1W-BI□□□) of one PLC.

■ SYSMAC SPU (High-speed Data Storage Unit)

Unit type	Product name	Specifications		Mountable Racks						No. of unit numbers allocated	Current consumption (A)		Model	Standards		
				CPU Rack		C200HX/HG/HE Expansion I/O Rack	CS1 Expansion Rack		CS1 Long-distance Expansion Rack		SYSMAC BUS Slave Rack	5 V system			26 V system	
				PC Card slot	Ethernet LAN port		CS1W-BC □□3 □□2	Yes								Yes
CS1 CPU Bus Unit	SYSMAC SPU (High-speed Data Storage Unit) 	1 PC Card Type II slot Insert an OMRON HMC-EF□□□□ to use the Memory Card.	1 port (10/100 BASE-TX)	Yes	Yes	No	Yes	Yes	Yes	No	1 unit number's words	0.56	---	CS1W-SPU01-V2	UC1, CE	
			2 ports (10/100 BASE-TX)									0.70	---	CS1W-SPU02-V2		
	SPU-Console Support Software *	Functions: Setting the High-speed Data Storage Unit's unit settings, sampling settings, etc. (The software is required to make the High-speed Data Storage Unit's settings.) OS: Windows 2000, XP, or Vista													WS02-SPTC1-V2	---
	SYSMAC SPU Data Management Middleware	Functions: Automatically uploads collected data files from the SYSMAC SPU to the computer, and can also register the data in a database. OS: Windows 2000, XP, or Vista									1 license				WS02-EDMC1-V2	---
											5 licenses				WS02-EDMC1-V2L05	---
	Memory Cards 	Flash memory: 128 MB	Note: A memory Card is required to collect data.												HMC-EF183	---
		Flash memory: 256 MB													HMC-EF283	
	Flash memory: 512 MB													HMC-EF583		
	Memory Card Adapter (for a computer's PCMCIA slot)													HMC-AP001	CE	

*SPU-Console version lower than version 2.0 cannot be connected to SYSMAC SPU Units with unit version 2.0 or later.

C200H Special I/O Units

High-density Input Units (Special I/O Units)

These Units function mainly like I/O Units, but are classified as Special I/O Units.

Unit type	Product name	Specifications	Mountable Racks							No. of unit numbers allocated	Current consumption (A)		Model	Standards
			CPU Rack		C200HX/HG/HE Expansion I/O Rack	CS1 Expansion Rack		CS1 Long-distance Expansion Rack	SYSMAC BUS Slave Rack		5 V system	26 V system		
			CS1W-BC □□3 □□2	Yes No		CS1W-BI □□3 □□2	Yes No							
C200H Special I/O Units 	DC Input Unit	24 VDC 32 inputs	Yes	No	Yes	Yes	No	No	Yes	1 unit number's words	0.13	---	C200H-ID215	U, C, N, L, CE
	TTL Input Unit	5 VDC 32 inputs	Yes	No	Yes	Yes	No	No	Yes		0.13	---	C200H-ID501	
	Transistor Output Units	24 VDC 32 outputs Sinking	Yes	No	Yes	Yes	No	No	Yes		0.22	---	C200H-OD215	
	TTL Output Units	5 VDC 32 inputs Sinking	Yes	No	Yes	Yes	No	No	Yes		0.22	---	C200H-OD501	
	TTL I/O Unit	5 VDC 16 inputs/outputs Sinking	Yes	No	Yes	Yes	No	No	Yes		0.18	---	C200H-MD501	
	DC Input/Transistor Output Units	24 VDC 16 inputs/outputs Sinking	Yes	No	Yes	Yes	No	No	Yes		0.18	---	C200H-MD215	
	DC Input/Transistor Output Units	12 VDC 16 inputs/outputs Sinking	Yes	No	Yes	Yes	No	No	Yes		0.18	---	C200H-MD115	U, C, N, L

Connectors for High-density I/O Units Classified as Special I/O Units

Product name	Connection	Part name	Model	Standards
Applicable Connectors	Soldered	FCN-361J024-AU Connector FCN-360C024-J2 Connector cover	C500-CE241 (Provided with the Unit.)	---
	Crimped	FCN-363J024 Housing FCN-363J-AU Contact FCN-360C024-J2 Connector cover	C500-CE242	
	Pressure welded	FCN-367J024-AU/F	C500-CE243	

Temperature Sensor Units

Unit type	Product name	Specifications					Mountable Racks					No. of unit numbers allocated	Current consumption (A)		Model	Standards		
		I/O points	Signal range selection	Signal range	Conversion speed	External connection	CPU Rack		C200HX/HG/HE Expansion I/O Rack	CS1 Expansion Rack			CS1 Long-distance Expansion Rack	SYSMAC BUS Slave Rack			5 V system	26 V system
							CS1W-BC □□3 □□2	Yes No		CS1W-BI □□3 □□2	Yes No							
C200H Special I/O Unit 	Temperature Sensor Units	4 inputs	4 common	Thermocouple K, J	4.8 s max. (when 4 inputs are used per Unit)	Removable terminal block	Yes	No	Yes	Yes	No	No	Yes	1 unit number's words	0.45	---	C200H-TS001	U, C
		4 inputs	4 common	Thermocouple K, L			Yes	No	Yes	Yes	No	No	Yes		0.45	---	C200H-TS002	
		4 inputs	4 common	Thermometer JPt100			Yes	No	Yes	Yes	No	No	Yes		0.45	---	C200H-TS101	
		4 inputs	4 common	Thermometer Pt100			Yes	No	Yes	Yes	No	No	Yes		0.45	---	C200H-TS102	

■ Analog Input Units

Unit type	Product name	Specifications						Mountable Racks						No. of unit numbers allocated	Current consumption (A)		Model	Standards	
		I/O points	Signal range selection	Signal range	Resolution	Conversion speed	External connection	CPU Rack		C200HX/HG/HE Expansion I/O Rack	CS1 Expansion Rack		CS1 Long-distance Expansion Rack		SYSMAC BUS Slave Rack	5 V system			26 V system
								CS1W-BC	CS1W-BI		CS1W-BC	CS1W-BI							
C200H Special I/O Unit	Analog Input Units	8 inputs	8 common	1 to 5 V, 4 to 20 mA, 0 to 10 V, -10 to 10 V	1/4000	2.5 ms/ input max.	Connector	Yes	No	Yes	Yes	No	No	Yes	1 unit number's words	0.45	---	C200H-AD002	U, C, N, L, CE
		8 inputs	8 common	1 to 5 V, 4 to 20 mA, 0 to 10 V, -10 to 10 V	1/4000	1 ms/ input	Removable terminal block	Yes	No	Yes	Yes	No	No	Yes		0.10	0.10	C200H-AD003	



■ Analog Output Units

Unit type	Product name	Specifications						Mountable Racks						No. of unit numbers allocated	Current consumption (A)		Model	Standards	
		I/O points	Signal range selection	Signal range	Resolution	Conversion speed	External connection	CPU Rack		C200HX/HG/HE Expansion I/O Rack	CS1 Expansion Rack		CS1 Long-distance Expansion Rack		SYSMAC BUS Slave Rack	5 V system			26 V system
								CS1W-BC	CS1W-BI		CS1W-BC	CS1W-BI							
C200H Special I/O Unit	Analog Output Units	4 outputs	4 independent	4 to 20 mA, -10 to 10 V	Voltage 1/8190, Current 1/4095	2.5 ms/ output	Removable terminal block	Yes	No	Yes	Yes	No	No	Yes	1 unit number's words	0.60	---	C200H-DA002	U, C, N, L, CE
		8 outputs	8 independent	1 to 5 V, 0 to 10 V, -10 to 10 V	1/4000	1 ms/ output		Yes	No	Yes	Yes	No	No	Yes		0.10	0.20	C200H-DA003	
		8 outputs	8 independent	4 to 20 mA	1/4000	1 ms/ output		Yes	No	Yes	Yes	No	No	Yes		0.10	0.25	C200H-DA004	



■ Analog I/O Units

Unit type	Product name	Specifications						Mountable Racks						No. of unit numbers allocated	Current consumption (A)		Model	Standards	
		I/O points	Signal range selection	Signal range	Resolution	Conversion speed	External connection	CPU Rack		C200HX/HG/HE Expansion I/O Rack	CS1 Expansion Rack		CS1 Long-distance Expansion Rack		SYSMAC BUS Slave Rack	5 V system			26 V system
								CS1W-BC	CS1W-BI		CS1W-BC	CS1W-BI							
C200H Special I/O Unit	Analog I/O Units	2 inputs	2 independent	1 to 5 V, 0 to 10 V, -10 to 10 V, 4 to 20 mA	1/4000	1 ms/ input	Removable terminal block	Yes	No	Yes	Yes	No	No	Yes	1 unit number's words	0.10	0.20	C200H-MAD01	U, C, N, L, CE
		2 outputs	2 independent	1 to 5 V, 0 to 10 V, -10 to 10 V, 4 to 20 mA	1/4000	1 ms/ output													



■ Temperature Control Units

Unit type	Product name	Specifications			Mountable Racks						No. of unit numbers allocated	Current consumption (A)		Model	Standards	
		No. of loops	Temperature sensor inputs	Control output	CPU Rack		C200HX/HG/HE Expansion I/O Rack	CS1 Expansion Rack		CS1 Long-distance Expansion Rack		SYSMAC BUS Slave Rack	5 V system			26 V system
					CS1W-BC □□3 □□2	□□3 □□2		□□3	□□2							
C200H Special I/O Unit	Temperature Control Units 	2 loops	Thermocouples (R, S, K, J, T, E, B, N, L, or U)	Open-collector NPN outputs (pulses)	Yes	No	Yes	Yes	No	No	Yes	0.33	---	C200H-TC001	U, C, CE	
		2 loops	Thermocouples (R, S, K, J, T, E, B, N, L, or U)	Voltage outputs (pulses)	Yes	No	Yes	Yes	No	No	Yes	0.33	---	C200H-TC002		
		2 loops	Thermocouples (R, S, K, J, T, E, B, N, L, or U)	Current outputs (linear)	Yes	No	Yes	Yes	No	No	Yes	0.33	---	C200H-TC003		
		2 loops	Platinum resistance thermometers (JPT00, Pt100)	ON/OFF transistor outputs (pulses)	Yes	No	Yes	Yes	No	No	Yes	0.33	---	C200H-TC101		
		2 loops	Platinum resistance thermometers (JPT00, Pt100)	ON/OFF voltage outputs (pulses)	Yes	No	Yes	Yes	No	No	Yes	0.33	---	C200H-TC102		
		2 loops	Platinum resistance thermometers (JPT00, Pt100)	ON/OFF current outputs (linear)	Yes	No	Yes	Yes	No	No	Yes	0.33	---	C200H-TC103		
	1 unit number's words															
	Data Setting Console 	Monitoring, setting, and changing present values, set points, alarm values, PID parameters, bank numbers, etc.											C200H-DSC01	U, C		
	Connecting Cables	Cable length: 2 m											C200H-CN225	N		
		Cable length: 4 m											C200H-CN425			

■ Heat/Cool Temperature Control Units

Unit type	Product name	Specifications			Mountable Racks						No. of unit numbers allocated	Current consumption (A)		Model	Standards		
		No. of loops	Temperature sensor inputs	Control output	CPU Rack		C200HX/HG/HE Expansion I/O Rack	CS1 Expansion Rack		CS1 Long-distance Expansion Rack		SYSMAC BUS Slave Rack	5 V system			26 V system	
					CS1W-BC □□3 □□2	CS1W-BI □□3 □□2											
C200H Special I/O Unit	Heat/Cool Temperature Control Units 	2 loops	Thermocouples (R, S, K, J, T, E, B, N, L, or U)	Heating/cooling outputs: Open-collector NPN outputs (pulses)	Yes	No	Yes	Yes	No	No	Yes	1 unit number's words	0.33	---	C200H-TV001	U, C, CE	
		2 loops	Thermocouples (R, S, K, J, T, E, B, N, L, or U)	Heating output: Voltage output (pulses), Cooling output: Open-collector NPN outputs (pulses)	Yes	No	Yes	Yes	No	No	Yes	0.33	---	C200H-TV002			
		2 loops	Thermocouples (R, S, K, J, T, E, B, N, L, or U)	Heating output: Current output (linear), Cooling output: Open-collector NPN outputs (pulses)	Yes	No	Yes	Yes	No	No	Yes	0.33	---	C200H-TV003			
		2 loops	Platinum resistance thermometers (JPt100, Pt100)	Heating/cooling outputs: Open-collector NPN outputs (pulses)	Yes	No	Yes	Yes	No	No	Yes	0.33	---	C200H-TV101			
		2 loops	Platinum resistance thermometers (JPt100, Pt100)	Heating output: Voltage output (pulses), Cooling output: Open-collector NPN outputs (pulses)	Yes	No	Yes	Yes	No	No	Yes	0.33	---	C200H-TV102			
		2 loops	Platinum resistance thermometers (JPt100, Pt100)	Heating output: Current output (linear), Cooling output: Open-collector NPN outputs (pulses)	Yes	No	Yes	Yes	No	No	Yes	0.33	---	C200H-TV103			
	Data Setting Console 	Monitoring, setting, and changing present values, set points, alarm values, PID parameters, bank numbers, etc.														C200H-DSC01	U, C
Connecting Cables	Cable length: 2 m															C200H-CN225	N
	Cable length: 4 m															C200H-CN425	



■ PID Control Units

Unit type	Product name	Specifications			Mountable Racks						No. of unit numbers allocated	Current consumption (A)		Model	Standards	
		No. of loops	Temperature sensor input	Control output	CPU Rack		C200HX/HG/HE Expansion I/O Rack	CS1 Expansion Rack		CS1 Long-distance Expansion Rack		SYSMAC BUS Slave Rack	5 V system			26 V system
					CS1W-BC □□3 □□2	CS1W-BI □□3 □□2										
C200H Special I/O Unit	PID Control Units 	2 loops	Voltage input/current input (any of 4 to 20 mA, 1 to 5 V, 0 to 5 V, or 0 to 10 V)	Open-collector NPN outputs (pulses)	Yes	No	Yes	Yes	No	No	Yes	0.33	---	C200H-PID01	U, C, CE	
		2 loops	Voltage input/current input (4 to 20 mA, 1 to 5 V, 0 to 5 V, or 0 to 10 V)	Voltage outputs (pulses)	Yes	No	Yes	Yes	No	No	Yes	0.33	---	C200H-PID02		
		2 loops	Voltage input/current input (4 to 20 mA, 1 to 5 V, 0 to 5 V, or 0 to 10 V)	Current outputs (linear)	Yes	No	Yes	Yes	No	No	Yes	0.33	---	C200H-PID03		
	Data Setting Console 	Monitoring, setting, and changing present values, set points, alarm values, PID parameters, bank numbers, etc.			---								C200H-DSC01	U, C		
Connecting Cables	Cable length: 2 m			---								C200H-CN225	N			
	Cable length: 4 m			---								C200H-CN425				

■ High-speed Counter Units

Unit type	Product name	Specifications			Mountable Racks						No. of unit numbers allocated	Current consumption (A)		Model	Standards	
		Number of counters	Encoder A and B input, pulse input, Z signal	Maximum counting speed	CPU Rack		C200HX/HG/HE Expansion I/O Rack	CS1 Expansion Rack		CS1 Long-distance Expansion Rack		SYSMAC BUS Slave Rack	5 V system			26 V system
					CS1W-BC □□3 □□2	CS1W-BI □□3 □□2										
C200H Special I/O Unit	High-speed Counter Units 	1	Voltage input: 5, 12, or 24 VDC	50 kHz	Yes	No	Yes	Yes	No	No	Yes	0.30	---	C200H-CT001-V1	U, C, CE	
		1	RS-422 line driver	75 kHz	Yes	No	Yes	Yes	No	No	Yes	0.30	---	C200H-CT002		
		2	Voltage input: 12 or 24 VDC	50 kHz	Yes	No	Yes	Yes	No	No	Yes	0.40	---	C200H-CT021		
RS-422 line driver	75 kHz															

■ Cam Positioner Unit

Unit type	Product name	Specifications	Mountable Racks						No. of unit numbers allocated	Current consumption (A)		Model	Standards	
			CPU Rack		C200HX/HG/HE Expansion I/O Rack	CS1 Expansion Rack		CS1 Long-distance Expansion Rack		SYSMAC BUS Slave Rack	5 V system			26 V system
			CS1W-BC □□3 □□2	CS1W-BI □□3 □□2										
C200H Special I/O Unit	Cam Positioner Unit 	48 cam outputs (external outputs: 16, internal outputs: 32) Control unit: 360 division per rotation Resolver response speed: 800 r/min max. Resolver response time: 200 μs (sampling frequency: 5 KHz)	Yes	No	Yes	Yes	No	No	Yes	1 unit number's words	0.30	---	C200H-CP114	U, C
	Data Setting Console 	Used to set cam data and monitor current cam angles.	---								C200H-DSC01	U, C		
	Connecting Cables	---			---						Cable length: 2 m		C200H-CN225	N
---			---						Cable length: 4 m		C200H-CN425			

■ Position Control Units

Unit type	Product name	Specifications		Mountable Racks							No. of unit numbers allocated	Current consumption (A)		Model	Standards
				CPU Rack		C200HX/HG/HE Expansion I/O Rack	CS1 Expansion Rack		CS1 Long-distance Expansion Rack	SYSMAC BUS Slave Rack		5 V system	26 V system		
				Control output interface	Number of axes		CS1W-BC □□3 □□2	CS1W-BI □□3 □□2							
C200H Special I/O Unit	Position Control Units 	Pulse-train, open-collector outputs	1 axis	Yes	No	Yes	Yes	No	No	Yes	1 unit number's words	0.30	---	C200HW-NC113	U, C, CE
	2 axes		Yes	No	Yes	Yes	No	No	Yes	2 unit numbers' words	0.30	---	C200HW-NC213		
	4 axes		Yes	No	Yes	Yes	No	No	Yes	2 unit numbers' words	0.50	---	C200HW-NC413		
	SYSMAC-NCT Position Control Unit Support Software		Windows 95		---							---		WS01-NCTF1-E	---
	Connecting Cables	Connection to peripheral port on CPU Unit	IBM PC/AT or compatible		---							Cable length: 2 m		CS1W-CN226	
		Connection to RS-232C port on CPU Unit	IBM PC/AT or compatible		---							Cable length: 6 m		CS1W-CN626	
	Relay Unit for Servo	For use with the C200HW-NC1□□3	Number of applicable axes: 1		---							Cable length: 2 m		XW2Z-200S-CV (NCT V1.11 or later)	
			Number of applicable axes: 2		---							Cable length: 5 m		XW2Z-500S-CV (NCT V1.11 or later)	
		For use with the C200HW-NC2□□3/NC4□□3		Number of applicable axes: 2		---							Cable length: 2 m		
	Servo Relay Unit Connecting Cables (to Position Control Unit)	Open-collector output	For use with the C200HW-NC113	Connected Servo Drive: OMNUC G Series, W Series, U Series, or SMARTSTEP 2		Number of applicable axes: 1		---					Cable length: 0.5 m		XW2Z-050J-A6
				Connected Servo Drive: SMARTSTEP Junior or A Series		Number of applicable axes: 1		---					Cable length: 1 m		XW2Z-100J-A6
				Connected Servo Drive: OMNUC G Series, W Series, U Series, or SMARTSTEP 2		Number of applicable axes: 2		---					Cable length: 0.5 m		XW2Z-050J-A8
			Connected Servo Drive: SMARTSTEP Junior or A Series		Number of applicable axes: 2		---					Cable length: 1 m		XW2Z-100J-A8	
			Connected Servo Drive: OMNUC G Series, W Series, U Series, or SMARTSTEP 2		Number of applicable axes: 2		---					Cable length: 0.5 m		XW2Z-050J-A7	
			Connected Servo Drive: SMARTSTEP Junior or A Series		Number of applicable axes: 2		---					Cable length: 1 m		XW2Z-100J-A7	

*If the computer has a D-sub 9-pin RS-232C connector, a commercially available 25 pin-to-9 pin adapter must be prepared separately.
Example: D09-9F25F from Sanwa Supply

■ Motion Control Units

Unit type	Product name	Specifications		Mountable Racks							No. of unit numbers allocated	Current consumption (A)		Model	Standards
				CPU Rack		C200HX/HG/HE Expansion I/O Rack	CS1 Expansion Rack		CS1 Long-distance Expansion Rack	SYSMAC BUS Slave Rack		5 V system	26 V system		
				Control output interface	Number of axes		CS1W-BC □□3 □□2	CS1W-BI □□3 □□2							
C200H Special I/O Unit	Motion Control Units (G-language programming) 	Analog output	2 axes	Yes	No	Yes	Yes	No	No	Yes	1 unit number's words	0.65 (0.85 A when a Teaching Box is connected)	---	C200H-MC221	U, C, CE
	Teaching Box	---		---							---		CVM1-PRO01-V1	CE	
	Teaching Box Connecting Cable	---		---							Cable length: 2 m		CV500-CN224	L, CE	
	ROM Cassette	---		---							---		CVM1-MP702-V1	CE	
	MC Terminal Block Conversion Unit	For 2 axes		---							---		XW2B-20J6-6	---	
	MC Terminal Block Conversion Unit Cable	---		---							Cable length: 1 m		XW2Z-100J-F1		

■ DeviceNet Master Unit

Unit type	Product name	Specifications	Communications functions	Mountable Racks					No. of unit numbers allocated	Current consumption (A)		Model	Standards		
				CPU Rack		C200HX/HG/HE Expansion I/O Rack	CS1 Expansion Rack			CS1 Long-distance Expansion Rack	SYSMAC BUS Slave Rack			5 V system	26 V system
				CS1W-BC □□3 □□2	Yes No		CS1W-BI □□3 □□2	Yes No							
C200H Special I/O Unit	DeviceNet Master Unit 	Functions as; allows control of 4,800 points max. per master.	<ul style="list-style-type: none"> Remote I/O Master communications (Fixed or user-set allocation) Message communications 	Yes	No	Yes	Yes	No	No	No	1 unit number's words	0.25	---	C200HW-DRM21-V1	U, C, N, L, CE

■ CompoBus/S Master Unit

Unit type	Product name	Specifications		Mountable Racks					No. of unit numbers allocated	Current consumption (A)		Model	Standards		
		Communications functions	I/O capacity per Master Unit	CPU Rack		C200HX/HG/HE Expansion I/O Rack	CS1 Expansion Rack			CS1 Long-distance Expansion Rack	SYSMAC BUS Slave Rack			5 V system	26 V system
				CS1W-BC □□3 □□2	Yes No		CS1W-BI □□3 □□2	Yes No							
C200H Special I/O Unit	CompoBus/S Master Unit 	Remote I/O communications	256 max. (128 inputs and 128 outputs) 128 max. (64 inputs and 64 outputs)	Yes	No	Yes	Yes	No	No	No	2 unit numbers' words 1 unit number's words	0.15	---	C200HW-SRM21-V1	U, C, N, L, CE

■ ID Sensor Units

Unit type	Product name	Connected ID Systems	No. of connected R/W heads	External power supply	Mountable Racks					No. of unit numbers allocated	Current consumption (A)		Model	Standards		
					CPU Rack		C200HX/HG/HE Expansion I/O Rack	CS1 Expansion Rack			CS1 Long-distance Expansion Rack	SYSMAC BUS Slave Rack			5 V system	26 V system
					CS1W-BC □□3 □□2	Yes No		CS1W-BI □□3 □□2	Yes No							
C200H Special I/O Unit	ID Sensor Units 	RFID System V600 Series	1	Not required	Yes	No	Yes	Yes	No	No	Yes	1 unit number's words	0.25	0.12	C200H-IDS01-V1	U, C

■ ASCII Units

Unit type	Product name	Specifications	Mountable Racks						No. of unit numbers allocated	Current consumption (A)		Model	Standards	
			CPU Rack		C200HX/HG/HE Expansion I/O Rack	CS1 Expansion Rack		CS1 Long-distance Expansion Rack		SYSMAC BUS Slave Rack	5 V system			26 V system
			CS1W-BC □□3 □□2	Yes		No	CS1W-BI □□3 □□2							
C200H Special I/O Unit	ASCII Units 	User memory area: 200 Kbytes Shared memory: Provided (general-purpose area: 90 words) RS-232C x 2 ports	Yes	No	Yes	Yes	No	No	Yes	1 unit number's words	0.25	---	C200H-ASC11	U, C, CE
		200 Kbytes RAM RS-232C x 1 port + RS-422A/485 x 1 port	Yes	No	Yes	Yes	No	No	Yes		0.30	---	C200H-ASC21	
		200 Kbytes RAM RS-232C x 2 ports + RS-232C x 1 port for Terminal	Yes	No	Yes	Yes	No	No	Yes		0.30	---	C200H-ASC31	
		24 Kbytes RAM RS-232C x 2 ports	Yes	No	Yes	Yes	No	No	Yes	1 unit number's words	0.20	---	C200H-ASC02	N, CE
	RS-422A Adapter	Converts RS-232C to RS-422A/RS-485 format.	---						---	---	CJ1W-CIF11	UC, N, CE		
RS-232C/RS-422A Link Adapter	One RS-232C port One RS-422 terminal block	---						---	---	NT-AL001	---			

■ PC Link Unit

Unit type	Product name	Specifications	Mountable Racks						No. of unit numbers allocated	Current consumption (A)		Model	Standards	
			CPU Rack		C200HX/HG/HE Expansion I/O Rack	CS1 Expansion Rack		CS1 Long-distance Expansion Rack		SYSMAC BUS Slave Rack	5 V system			26 V system
			CS1W-BC □□3 □□2	Yes		No	CS1W-BI □□3 □□2							
C200H Special I/O Unit	PC Link Unit 	Up to 32 PLC Link Units for 1 level, 16 PLC Link Units for multilevel systems	Yes	No	Yes	Yes	No	No	Yes	1 unit number's words	0.35	---	C200H-LK401	N, L, CE

Replacing C200H I/O Units

This section shows the corresponding CS1 I/O models and notes for replacing C200H I/O Units.

16-point DC Input Units

Item	C200H I/O Unit	Corresponding CS1 I/O Unit
Model number	C200H-ID212 →	CS1W-ID211
Description	16-point DC Input Units with terminal blocks	
Notes	The terminal arrangement must be changed.	
	The impedance increases (from 3kΩ to 3.3kΩ). Check that correct operation is possible in cases where increased impedance may influence operation.	
	The internal 5-V current consumption increases (from 10mA to 100mA). Check that the increased current is within the range of the power supply.	

64-point DC Input Units

Item	C200H I/O Unit	Corresponding CS1 I/O Unit
Model number	C200H-ID219 →	CS1W-ID261
Description	64-point DC Input Units with connectors. The connectors, the pin arrangement, and the input specifications are the same.	
Notes	There are 4 commons instead of 2. Connect where necessary.	
	The internal 5-V current consumption increases (from 120mA to 150mA). Check that the increased current is within the range of the power supply.	

32-point DC Input Units

Item	C200H I/O Unit	Corresponding CS1 I/O Unit
Model number	C200H-ID218 →	CS1W-ID231
Description	32-point DC Input Units with connectors. The connectors, the pin arrangement, and the input specifications are the same.	
Notes	There are 2 commons instead of 1. Connect where necessary.	
	The internal 5-V current consumption increases (from 100mA to 150mA). Check that the increased current is within the range of the power supply.	

64-point DC Input Units (cntd.)

Item	C200H I/O Unit	Corresponding CS1 I/O Unit
Model number	C200H-ID217 →	CS1W-ID261
Description	64-point DC Input Units with connectors. The connectors and the pin arrangement are the same. The input current increases, allowing use with a wider range of devices.	
Notes	There are 4 commons instead of 2. Connect where necessary.	
	The input specifications change (e.g., the impedance decreases and the input current increases from 4.1mA to 6mA.) Check that correct operation is possible in cases where changes in input specifications may influence operation.	
	The internal 5-V current consumption increases (from 100mA to 150mA). Check that the increased current is within the range of the power supply.	

32-point DC Input Units (cntd.)

Item	C200H I/O Unit	Corresponding CS1 I/O Unit
Model number	C200H-ID216 →	CS1W-ID231
Description	32-point DC Input Units with connectors. The connectors and the pin arrangement are the same. The input current increases, allowing use with a wider range of devices.	
Notes	There are 2 commons instead of 1. Connect where necessary.	
	The input specifications change (e.g., the impedance decreases and the input current increases from 4.1mA to 6mA.) Check that correct operation is possible in cases where changes in input specifications may influence operation.	
	The internal 5-V current consumption increases (from 100mA to 150mA). Check that the increased current is within the range of the power supply.	

16-point Sinking Transistor Output Units

Item	C200H I/O Unit	Corresponding CS1 I/O Unit
Model number	C200H-OD212 →	CS1W-OD211
Description	16-point Transistor Output (sinking) Units with terminal blocks. The output current capacity increases (from 0.3A per point and 4.8A per Unit to 0.5A per point and 8A per Unit). The rated voltage range also increases (from 24V to any voltage in the range 12 to 24V.)	
Notes	The terminal arrangement must be changed.	
	The output specifications change. Check that correct operation is possible in cases where changes in output specifications may influence operation. (Residual voltage increases from 0.8V to 1.5V, ON response time increases from 0.1ms to 0.5ms, OFF response time increases from 0.3ms to 1ms.)	

16-point Sourcing Transistor Output Units

Item	C200H I/O Unit	Corresponding CS1 I/O Unit
Model number	C200H-OD21A →	CS1W-OD212
Description	16-point Transistor Output (sourcing) Units with terminal blocks.	
Notes	The terminal arrangement must be changed.	
	The output capacity changes (from 1A per point and 4A per Unit to 0.5A per point and 5A per Unit). Check that correct operation is possible in cases where changes in output capacity may influence operation.	
	The output specifications change. Check that correct operation is possible in cases where changes in output specifications may influence operation. (Residual voltage increases from 0.8V to 1.5V, ON response time increases from 0.1ms to 0.5ms, OFF response time increases from 0.3ms to 1ms.)	
	The internal 5-V current consumption increases (from 160mA to 170mA). The external 24-V power supply current also increases (from 35mA to 40mA). Check that the increased current is within the range of the power supply.	
	There are no alarm output contacts. Use the alarm bits in the Auxiliary Area.	

32-point Sinking Transistor Output Units

Item	C200H I/O Unit	Corresponding CS1 I/O Unit
Model number	C200H-OD218 →	CS1W-OD231
Description	32-point Transistor Output (sinking) Units with connectors. The connectors and the pin arrangement are the same. The output current capacity increases (from 100mA to 0.5A per point, 2.5A per common, and 5A per Unit). The load voltage range changes from 4.5 to 26.4V to 10.2 to 26.4V.	
Notes	There are 2 commons instead of 1. Connect where necessary.	
	The output specifications change. Check that correct operation is possible in cases where changes in output specifications may influence operation. (Residual voltage increases from 0.8V to 1.5V, ON response time increases from 0.1ms to 0.5ms, OFF response time increases from 0.4ms to 1ms.)	
	Replacement is not possible for applications with an output load range of 4.5 to 10.2V.	
	The internal 5-V current consumption increases (from 180mA to 270mA). Check that the increased current is within the range of the power supply.	

32-point Sourcing Transistor Output Units

Item	C200H I/O Unit	Corresponding CS1 I/O Unit
Model number	C200H-OD21B →	CS1W-OD232
Description	32-point Transistor Output (sourcing) Units with connectors. The connectors and the pin arrangement are the same.	
Notes	There are 2 commons instead of 1. Connect where necessary.	
	The output specifications change. Check that correct operation is possible in cases where changes in output specifications may influence operation. (Residual voltage increases from 0.8V to 1.5V, ON response time increases from 0.1ms to 0.5ms, OFF response time increases from 0.3ms to 1ms.)	
	The internal 5-V current consumption increases (from 180mA to 270mA). Check that the increased current is within the range of the power supply.	

64-point Sinking Transistor Output Units

Item	C200H I/O Unit	Corresponding CS1 I/O Unit
Model number	C200H-OD219 →	CS1W-OD261
Description	64-point Transistor Output (sinking) Units with connectors. The connectors and the pin arrangement are the same. The output current capacity increases (from 100mA to 0.3A per point, 1.6A per common, and 6.4A per Unit). The load voltage range changes from 4.5 to 26.4V to 10.2 to 26.4V.	
Notes	There are 4 commons instead of 2. Connect where necessary.	
	The output specifications change. Check that correct operation is possible in cases where changes in output specifications may influence operation. (Residual voltage increases from 0.8V to 1.5V, ON response time increases from 0.1ms to 0.5ms, OFF response time increases from 0.4ms to 1ms.)	
	Replacement is not possible for applications with an output load range of 4.5 to 10.2V.	
	The internal 5-V current consumption increases (from 270mA to 390mA). Check that the increased current is within the range of the power supply.	

16-point 100-VAC Input Units

Item	C200H I/O Unit	Corresponding CS1 I/O Unit
Model number	C200H-IA122/122V →	CS1W-IA111
Description	16-point 100-VAC Input Units with terminal blocks. 100-VDC input also possible.	
Notes	The terminal arrangement must be changed.	
	The input specifications change. Check that correct operation is possible in cases where changes in input specifications may influence operation. (ON voltage increases from 60VAC min. to 65VAC min. and the input impedance (50Hz) increases from 9.7kΩ to 10kΩ.)	
	The internal 5-V current consumption increases (from 10mA to 110mA). Check that the increased current is within the range of the power supply.	

MEMO

A large grid of dashed lines forming a grid of approximately 20 columns and 30 rows, intended for taking notes or memos.

Read and Understand this Catalog

Please read and understand this catalog before purchasing the product. Please consult your OMRON representative if you have any questions or comments.

Warranty and Limitations of Liability

WARRANTY

OMRON's exclusive warranty is that the products are free from defects in materials and workmanship for a period of one year (or other period if specified) from date of sale by OMRON.

OMRON MAKES NO WARRANTY OR REPRESENTATION, EXPRESS OR IMPLIED, REGARDING NON-INFRINGEMENT, MERCHANTABILITY, OR FITNESS FOR PARTICULAR PURPOSE OF THE PRODUCTS. ANY BUYER OR USER ACKNOWLEDGES THAT THE BUYER OR USER ALONE HAS DETERMINED THAT THE PRODUCTS WILL SUITABLY MEET THE REQUIREMENTS OF THEIR INTENDED USE. OMRON DISCLAIMS ALL OTHER WARRANTIES, EXPRESS OR IMPLIED.

LIMITATIONS OF LIABILITY

OMRON SHALL NOT BE RESPONSIBLE FOR SPECIAL, INDIRECT, OR CONSEQUENTIAL DAMAGES, LOSS OF PROFITS OR COMMERCIAL LOSS IN ANY WAY CONNECTED WITH THE PRODUCTS, WHETHER SUCH CLAIM IS BASED ON CONTRACT, WARRANTY, NEGLIGENCE, OR STRICT LIABILITY.

In no event shall the responsibility of OMRON for any act exceed the individual price of the product on which liability is asserted.

IN NO EVENT SHALL OMRON BE RESPONSIBLE FOR WARRANTY, REPAIR, OR OTHER CLAIMS REGARDING THE PRODUCTS UNLESS OMRON'S ANALYSIS CONFIRMS THAT THE PRODUCTS WERE PROPERLY HANDLED, STORED, INSTALLED, AND MAINTAINED AND NOT SUBJECT TO CONTAMINATION, ABUSE, MISUSE, OR INAPPROPRIATE MODIFICATION OR REPAIR.

Application Considerations

SUITABILITY FOR USE

OMRON shall not be responsible for conformity with any standards, codes, or regulations that apply to the combination of the product in the customer's application or use of the product.

Take all necessary steps to determine the suitability of the product for the systems, machines, and equipment with which it will be used.

Know and observe all prohibitions of use applicable to this product.

NEVER USE THE PRODUCT FOR AN APPLICATION INVOLVING SERIOUS RISK TO LIFE OR PROPERTY WITHOUT ENSURING THAT THE SYSTEM AS A WHOLE HAS BEEN DESIGNED TO ADDRESS THE RISKS, AND THAT THE OMRON PRODUCT IS PROPERLY RATED AND INSTALLED FOR THE INTENDED USE WITHIN THE OVERALL EQUIPMENT OR SYSTEM.

PROGRAMMABLE PRODUCTS

OMRON shall not be responsible for the user's programming of a programmable product, or any consequence thereof.

Disclaimers

CHANGE IN SPECIFICATIONS

Product specifications and accessories may be changed at any time based on improvements and other reasons. Consult with your OMRON representative at any time to confirm actual specifications of purchased product.

DIMENSIONS AND WEIGHTS

Dimensions and weights are nominal and are not to be used for manufacturing purposes, even when tolerances are shown.

PERFORMANCE DATA

Performance data given in this catalog is provided as a guide for the user in determining suitability and does not constitute a warranty. It may represent the result of OMRON's test conditions, and the users must correlate it to actual application requirements. Actual performance is subject to the OMRON Warranty and Limitations of Liability.

OMRON Corporation Industrial Automation Company
Tokyo, JAPAN

Contact: www.ia.omron.com

Regional Headquarters

OMRON EUROPE B.V.

Wegalaan 67-69-2132 JD Hoofddorp
The Netherlands
Tel: (31)2356-81-300/Fax: (31)2356-81-388

OMRON ELECTRONICS LLC

One Commerce Drive Schaumburg,
IL 60173-5302 U.S.A.
Tel: (1) 847-843-7900/Fax: (1) 847-843-7787

OMRON ASIA PACIFIC PTE. LTD.

No. 438A Alexandra Road # 05-05/08 (Lobby 2),
Alexandra Technopark,
Singapore 119967
Tel: (65) 6835-3011/Fax: (65) 6835-2711

OMRON (CHINA) CO., LTD.

Room 2211, Bank of China Tower,
200 Yin Cheng Zhong Road,
PuDong New Area, Shanghai, 200120, China
Tel: (86) 21-5037-2222/Fax: (86) 21-5037-2200

Authorized Distributor:

© OMRON Corporation 2001-2010 All Rights Reserved.
In the interest of product improvement,
specifications are subject to change without notice.

CSM_1_1_0412
Cat. No. P047-E1-11

Printed in Japan
0910-1101

Компания «Океан Электроники» предлагает заключение долгосрочных отношений при поставках импортных электронных компонентов на взаимовыгодных условиях!

Наши преимущества:

- Поставка оригинальных импортных электронных компонентов напрямую с производств Америки, Европы и Азии, а так же с крупнейших складов мира;
- Широкая линейка поставок активных и пассивных импортных электронных компонентов (более 30 млн. наименований);
- Поставка сложных, дефицитных, либо снятых с производства позиций;
- Оперативные сроки поставки под заказ (от 5 рабочих дней);
- Экспресс доставка в любую точку России;
- Помощь Конструкторского Отдела и консультации квалифицированных инженеров;
- Техническая поддержка проекта, помощь в подборе аналогов, поставка прототипов;
- Поставка электронных компонентов под контролем ВП;
- Система менеджмента качества сертифицирована по Международному стандарту ISO 9001;
- При необходимости вся продукция военного и аэрокосмического назначения проходит испытания и сертификацию в лаборатории (по согласованию с заказчиком);
- Поставка специализированных компонентов военного и аэрокосмического уровня качества (Xilinx, Altera, Analog Devices, Intersil, Interpoint, Microsemi, Actel, Aeroflex, Peregrine, VPT, Syfer, Eurofarad, Texas Instruments, MS Kennedy, Miteq, Cobham, E2V, MA-COM, Hittite, Mini-Circuits, General Dynamics и др.);

Компания «Океан Электроники» является официальным дистрибьютором и эксклюзивным представителем в России одного из крупнейших производителей разъемов военного и аэрокосмического назначения «JONHON», а так же официальным дистрибьютором и эксклюзивным представителем в России производителя высокотехнологичных и надежных решений для передачи СВЧ сигналов «FORSTAR».



JONHON

«JONHON» (основан в 1970 г.)

Разъемы специального, военного и аэрокосмического назначения:

(Применяются в военной, авиационной, аэрокосмической, морской, железнодорожной, горно- и нефтедобывающей отраслях промышленности)

«FORSTAR» (основан в 1998 г.)

ВЧ соединители, коаксиальные кабели, кабельные сборки и микроволновые компоненты:

(Применяются в телекоммуникациях гражданского и специального назначения, в средствах связи, РЛС, а так же военной, авиационной и аэрокосмической отраслях промышленности).



Телефон: 8 (812) 309-75-97 (многоканальный)

Факс: 8 (812) 320-03-32

Электронная почта: ocean@oceanchips.ru

Web: <http://oceanchips.ru/>

Адрес: 198099, г. Санкт-Петербург, ул. Калинина, д. 2, корп. 4, лит. А