

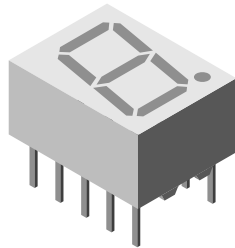

Standard 7-Segment Display 10 mm



19236

DESCRIPTION

The TDS.31.. series are 10 mm character seven segment LED displays in a very compact package.

The displays are designed for a viewing distance up to 6 m and available in four bright colors. The grey package surface and the evenly lighted untinted segments provide an optimum on-off contrast.

All displays are categorized in luminous intensity groups. That allows users to assemble displays with uniform appearance. Typical applications include instruments, panel meters, point-of-sale terminals and household equipment.

FEATURES

- Evenly lighted segments
- Grey package surface
- Untinted segments
- Luminous intensity categorized
- Yellow and green categorized for color
- Wide viewing angle
- Suitable for DC and high peak current
- Material categorization: For definitions of compliance please see www.vishay.com/doc?99912



RoHS
COMPLIANT

APPLICATIONS

- Panel meters
- Test- and measure-equipment
- Point-of-sale terminals
- Control units

PRODUCT GROUP AND PACKAGE DATA

- Product group: Display
- Package: 10 mm
- Product series: Standard
- Angle of half intensity: $\pm 50^\circ$

| PARTS TABLE | | | | | | | | | | | | | | |
|-------------|------------|---------------------------------------|------|--------|---------------|-----------------|------|------|---------------|---------------------|------|------|---------------|----------------|
| PART | COLOR | LUMINOUS INTENSITY (μcd) | | | at I_F (mA) | WAVELENGTH (nm) | | | at I_F (mA) | FORWARD VOLTAGE (V) | | | at I_F (mA) | CIRCUITRY |
| | | MIN. | TYP. | MAX. | | MIN. | TYP. | MAX. | | MIN. | TYP. | MAX. | | |
| TDSO3150 | Orange red | 450 | 4500 | - | 10 | 612 | - | 625 | 10 | - | 2 | 3 | 20 | Common anode |
| TDSO3150-KL | Orange red | 1800 | - | 5600 | 10 | 612 | - | 625 | 10 | - | 2 | 3 | 20 | Common anode |
| TDSO3150-L | Orange red | 2800 | - | 5600 | 10 | 612 | - | 625 | 10 | - | 2 | 3 | 20 | Common anode |
| TDSO3155 | Orange red | 1100 | - | 9000 | 10 | 612 | - | 625 | 10 | - | 2 | 3 | 20 | Common anode |
| TDSO3160 | Orange red | 450 | 4500 | - | 10 | 612 | - | 625 | 10 | - | 2 | 3 | 20 | Common cathode |
| TDSO3160-KL | Orange red | 1800 | - | 5600 | 10 | 612 | - | 625 | 10 | - | 2 | 3 | 20 | Common cathode |
| TDSO3160-L | Orange red | 2800 | - | 5600 | 10 | 612 | - | 625 | 10 | - | 2 | 3 | 20 | Common cathode |
| TDSY3150 | Yellow | 450 | 3000 | - | 10 | 581 | - | 594 | 10 | - | 2.4 | 3 | 20 | Common anode |
| TDSY3150-K | Yellow | 1800 | - | 3600 | 10 | 581 | - | 594 | 10 | - | 2.4 | 3 | 20 | Common anode |
| TDSY3160 | Yellow | 450 | 3000 | - | 10 | 581 | - | 594 | 10 | - | 2.4 | 3 | 20 | Common cathode |
| TDSG3150 | Green | 450 | 6800 | - | 10 | 562 | - | 575 | 10 | - | 2.4 | 3 | 20 | Common anode |
| TDSG3150-M | Green | 4500 | - | 9000 | 10 | 562 | - | 575 | 10 | - | 2.4 | 3 | 20 | Common anode |
| TDSG3150-MN | Green | 4500 | - | 14 000 | 10 | 562 | - | 575 | 10 | - | 2.4 | 3 | 20 | Common anode |
| TDSG3151 | Green | 1800 | - | 9000 | 10 | 562 | - | 575 | 10 | - | 2.4 | 3 | 20 | Common anode |
| TDSG3160 | Green | 450 | 6800 | - | 10 | 562 | - | 575 | 10 | - | 2.4 | 3 | 20 | Common cathode |
| TDSG3160-M | Green | 4500 | - | 9000 | 10 | 562 | - | 575 | 10 | - | 2.4 | 3 | 20 | Common cathode |



| ABSOLUTE MAXIMUM RATINGS ($T_{amb} = 25\text{ }^{\circ}\text{C}$, unless otherwise specified) TDSO315., TDSO316., TDSY315., TDSY316., TDSG315., TDSG316. | | | | |
|---|---|------------|------------|--------------------|
| PARAMETER | TEST CONDITION | SYMBOL | VALUE | UNIT |
| Reverse voltage per segment or DP | | V_R | 6 | V |
| DC forward current per segment or DP | | I_F | 20 | mA |
| DC forward current per segment or DP | $t_p \leq 10\text{ }\mu\text{s}$ (non repetitive) | I_{FSM} | 0.15 | A |
| Power dissipation | $T_{amb} \leq 45\text{ }^{\circ}\text{C}$ | P_V | 480 | mW |
| Junction temperature | | T_j | 100 | $^{\circ}\text{C}$ |
| Operating temperature range | | T_{amb} | -40 to +85 | $^{\circ}\text{C}$ |
| Storage temperature range | | T_{stg} | -40 to +85 | $^{\circ}\text{C}$ |
| Soldering temperature | $t \leq 3\text{ s}$, 2 mm below seating plane | T_{sd} | 260 | $^{\circ}\text{C}$ |
| Thermal resistance LED junction/ambient | | R_{thJA} | 120 | K/W |

| OPTICAL AND ELECTRICAL CHARACTERISTICS ($T_{amb} = 25\text{ }^{\circ}\text{C}$, unless otherwise specified) TDSO3150, TDSO3150-KL, TDSO3150-L, TDSO3155, TDSO3160, TDSO3160-KL, TDSO3160-L, ORANGE RED | | | | | | | |
|---|-------------------------------|--|-------------|------|----------|------|----------------|
| PARAMETER | TEST CONDITION | PART | SYMBOL | MIN. | TYP. | MAX. | UNIT |
| Luminous intensity per segment (digit average) ⁽¹⁾ | $I_F = 10\text{ mA}$ | TDSO3150 | I_V | 450 | 4500 | - | μcd |
| | | TDSO3150-KL | | 1800 | - | 5600 | |
| | | TDSO3150-L | | 2800 | - | 5600 | |
| | | TDSO3155 | | 1100 | - | 9000 | |
| | | TDSO3160 | | 450 | 4500 | - | |
| | | TDSO3160-KL | | 1800 | - | 5600 | |
| | | TDSO3160-L | | 2800 | - | 5600 | |
| Dominant wavelength | $I_F = 10\text{ mA}$ | TDSO3150, TDSO3150-KL, TDSO3150-L, | λ_d | 612 | - | 625 | nm |
| Peak wavelength | $I_F = 10\text{ mA}$ | TDSO3150-KL, TDSO3150-L, | λ_p | - | 630 | - | nm |
| Angle of half intensity | $I_F = 10\text{ mA}$ | TDSO3155, TDSO3160, TDSO3160-KL, TDSO3160-L | j | - | ± 50 | - | deg |
| Forward voltage per segment or DP | $I_F = 20\text{ mA}$ | | V_F | - | 2 | 3 | V |
| Reverse voltage per segment or DP | $I_R = 10\text{ }\mu\text{A}$ | | V_R | 6 | 15 | - | V |

Note

⁽¹⁾ $I_{Vmin.}$ and I_V groups are mean values of all segments (a to g, D1 to D4), matching factor within segments is ≥ 0.5 , excluding decimal points and colon.

| OPTICAL AND ELECTRICAL CHARACTERISTICS ($T_{amb} = 25\text{ }^{\circ}\text{C}$, unless otherwise specified) TDSY3150, TDSY3150-K, TDSY3160, YELLOW | | | | | | | |
|---|-------------------------------|--------------------------------------|-------------|------|----------|------|----------------|
| PARAMETER | TEST CONDITION | PART | SYMBOL | MIN. | TYP. | MAX. | UNIT |
| Luminous intensity per segment (digit average) ⁽¹⁾ | $I_F = 10\text{ mA}$ | TDSY3150 | I_V | 450 | 3000 | - | μcd |
| | | TDSY3150-K | | 1800 | - | 3600 | |
| | | TDSY3160 | | 450 | 3000 | - | |
| Dominant wavelength | $I_F = 10\text{ mA}$ | TDSY3150, TDSY3150-K, TDSY3160 | λ_d | 581 | - | 594 | nm |
| Peak wavelength | $I_F = 10\text{ mA}$ | | λ_p | - | 585 | - | nm |
| Angle of half intensity | $I_F = 10\text{ mA}$ | | j | - | ± 50 | - | deg |
| Forward voltage per segment or DP | $I_F = 20\text{ mA}$ | | V_F | - | 2.4 | 3 | V |
| Reverse voltage per segment or DP | $I_R = 10\text{ }\mu\text{A}$ | | V_R | 6 | 15 | - | V |

Note

⁽¹⁾ $I_{Vmin.}$ and I_V groups are mean values of all segments (a to g, D1 to D4), matching factor within segments is ≥ 0.5 , excluding decimal points and colon.



| OPTICAL AND ELECTRICAL CHARACTERISTICS (T _{amb} = 25 °C, unless otherwise specified) | | | | | | | |
|---|------------------------|--|----------------|------|------|--------|------|
| TDSG315., TDSG316., GREEN | | | | | | | |
| PARAMETER | TEST CONDITION | PART | SYMBOL | MIN. | TYP. | MAX. | UNIT |
| Luminous intensity per segment (digit average) ⁽¹⁾ | I _F = 10 mA | TDSG3150 | I _V | 450 | 6800 | - | μcd |
| | | TDSG3150-M | | 4500 | - | 9000 | |
| | | TDSG3150-MN | | 4500 | - | 14 000 | |
| | | TDSG3151 | | 1800 | - | 9000 | |
| | | TDSG3160 | | 450 | 6800 | - | |
| | | TDSG3160-M | | 4500 | - | 9000 | |
| Dominant wavelength | I _F = 10 mA | TDSG3150, TDSG3150-M, TDSG3150-MN, TDSG3151, TDSG3160, TDSG3160-M | λ _d | 562 | - | 575 | nm |
| Peak wavelength | I _F = 10 mA | | λ _p | - | 565 | - | nm |
| Angle of half intensity | I _F = 10 mA | | j | - | ± 50 | - | deg |
| Forward voltage per segment or DP | I _F = 20 mA | | V _F | - | 2.4 | 3 | V |
| Reverse voltage per segment or DP | I _R = 10 μA | | V _R | 6 | 15 | - | V |

Note

⁽¹⁾ I_{Vmin.} and I_V groups are mean values of all segments (a to g, D1 to D4), matching factor within segments is ≥ 0.5, excluding decimal points and colon.

| LUMINOUS INTENSITY CLASSIFICATION | | |
|-----------------------------------|-----------------------|--------|
| GROUP | LIGHT INTENSITY (μcd) | |
| | MIN. | MAX. |
| STANDARD | | |
| E | 180 | 360 |
| F | 280 | 560 |
| G | 450 | 900 |
| H | 700 | 1400 |
| I | 1100 | 2200 |
| K | 1800 | 3600 |
| L | 2800 | 5600 |
| M | 4500 | 9000 |
| N | 7000 | 14 000 |

Note

- The above type numbers represent the order groups which include only a few brightness groups. Only one group will be shipped in one tube (there will be no mixing of two groups in one tube). In order to ensure availability, single brightness groups will not be orderable.

| COLOR CLASSIFICATION | | | | | | |
|----------------------|------------|------|--------|------|-------|------|
| GROUP | ORANGE RED | | YELLOW | | GREEN | |
| | MIN. | MAX. | MIN. | MAX. | MIN. | MAX. |
| 1 | 612 | 617 | 581 | 584 | | |
| 2 | 616 | 621 | 583 | 586 | | |
| 3 | 620 | 625 | 585 | 588 | 562 | 565 |
| 4 | | | 587 | 590 | 564 | 567 |
| 5 | | | 589 | 592 | 566 | 569 |
| 6 | | | 591 | 594 | 568 | 571 |
| 7 | | | | | 570 | 573 |
| 8 | | | | | 572 | 575 |

Note

- Wavelengths are tested at a current pulse duration of 25 ms and an accuracy of ± 1 nm.



TYPICAL CHARACTERISTICS (T_{amb} = 25 °C, unless otherwise specified)

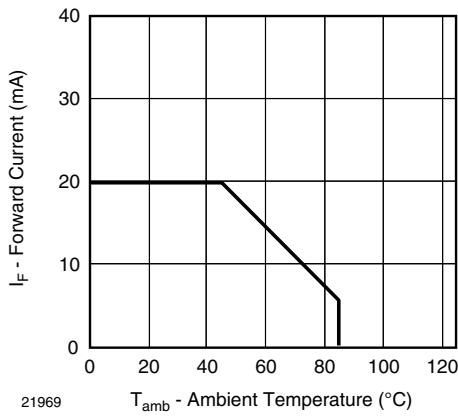

Fig. 1 - Forward Current vs. Ambient Temperature

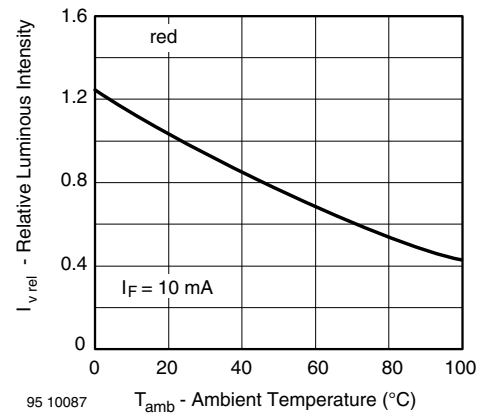

Fig. 4 - Relative Luminous Intensity vs. Ambient Temperature

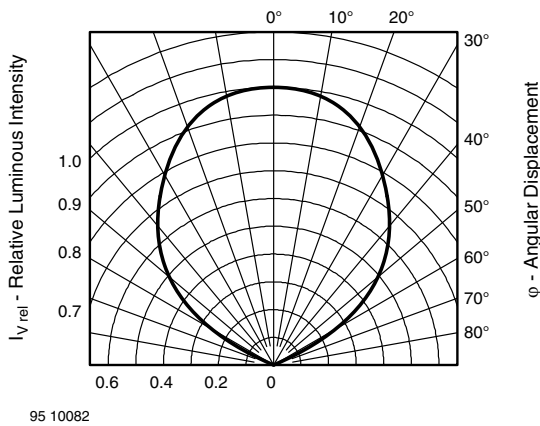

Fig. 2 - Relative Luminous Intensity vs. Angular Displacement

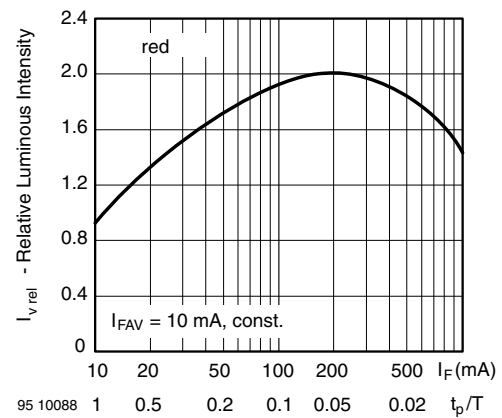

Fig. 5 - Relative Luminous Intensity vs. Forward Current/Duty Cycle

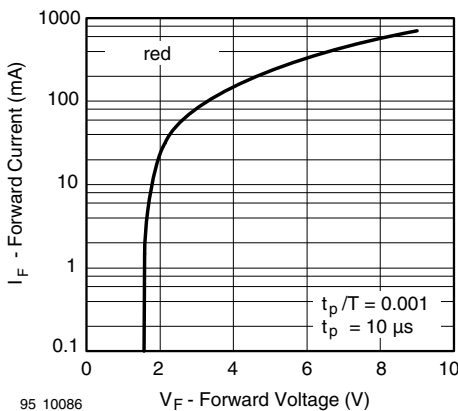

Fig. 3 - Forward Current vs. Forward Voltage

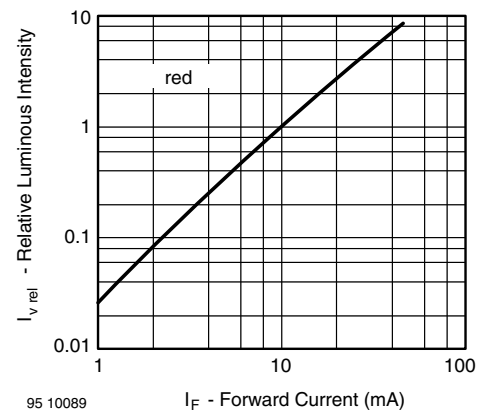

Fig. 6 - Relative Luminous Intensity vs. Forward Current

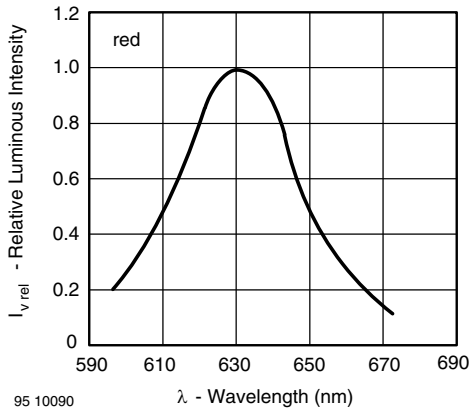

Fig. 7 - Relative Intensity vs. Wavelength

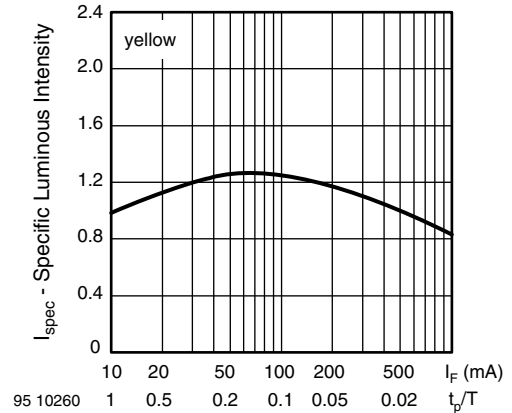

Fig. 10 - Relative Luminous Intensity vs. Forward Current/Duty Cycle

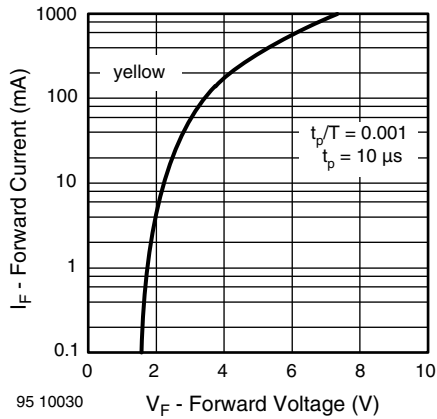

Fig. 8 - Forward Current vs. Forward Voltage

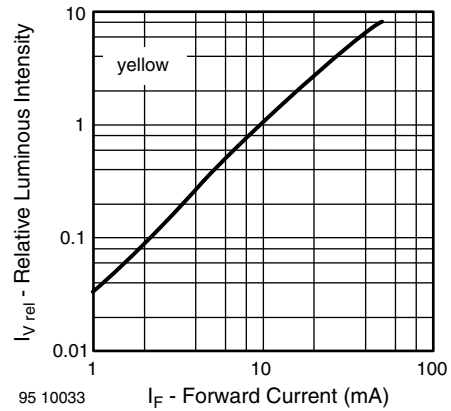

Fig. 11 - Relative Luminous Intensity vs. Forward Current

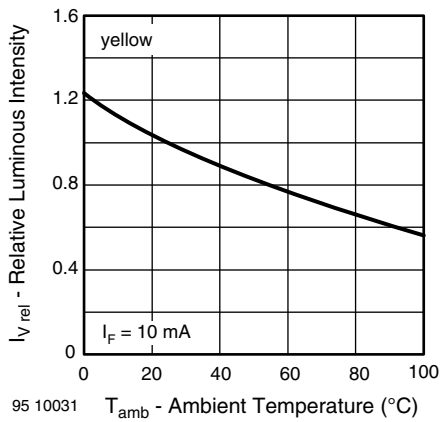

Fig. 9 - Relative Luminous Intensity vs. Ambient Temperature

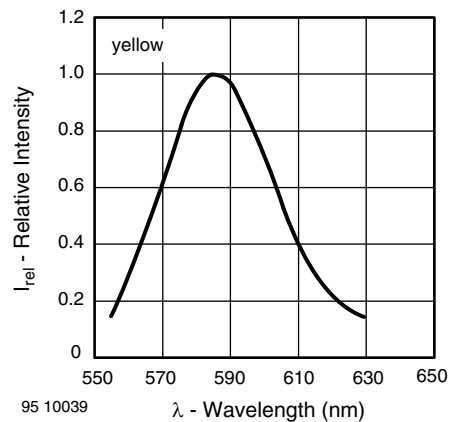

Fig. 12 - Relative Intensity vs. Wavelength

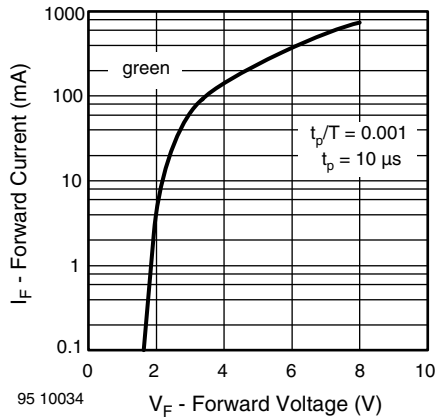

Fig. 13 - Forward Current vs. Forward Voltage

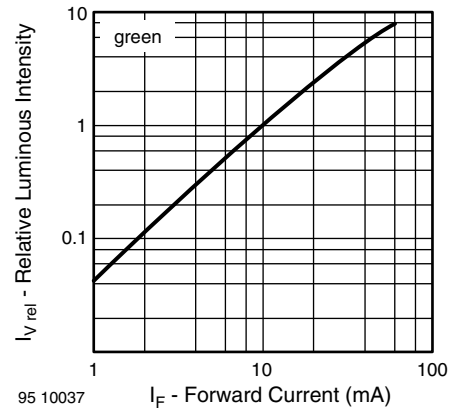

Fig. 16 - Relative Luminous Intensity vs. Forward Current

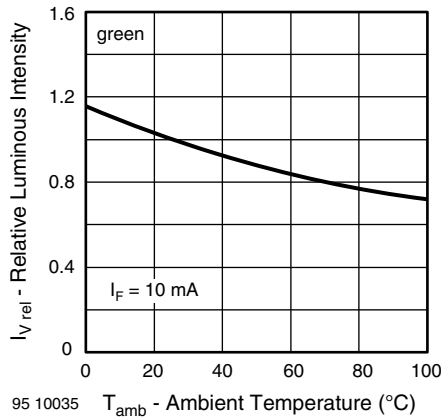

Fig. 14 - Relative Luminous Intensity vs. Ambient Temperature

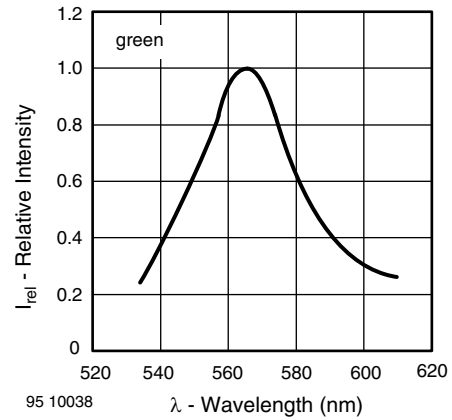

Fig. 17 - Relative Intensity vs. Wavelength

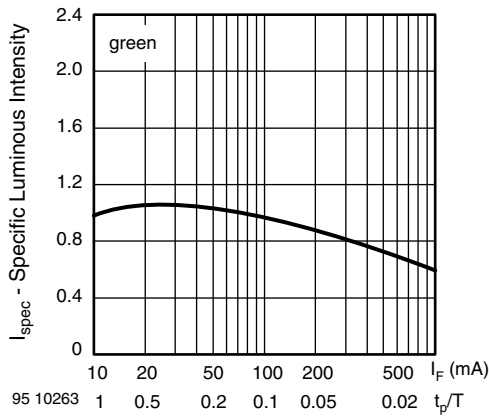
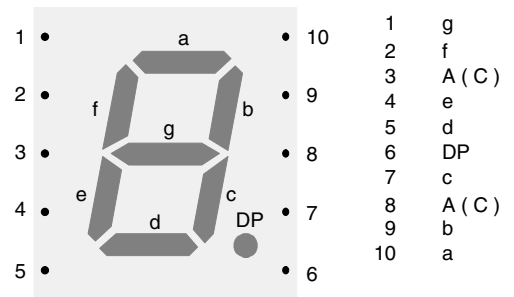

Fig. 15 - Specific Luminous Intensity vs. Forward Current



96 11678

Fig. 18 - TDS.31..



PACKAGE DIMENSIONS FOR TDS.31.. in millimeters

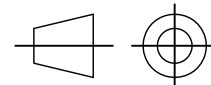
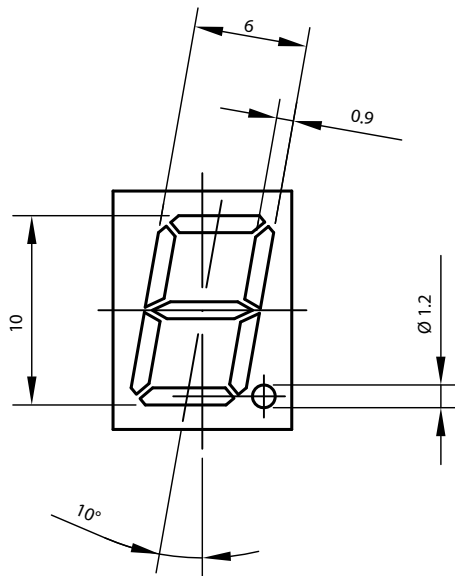
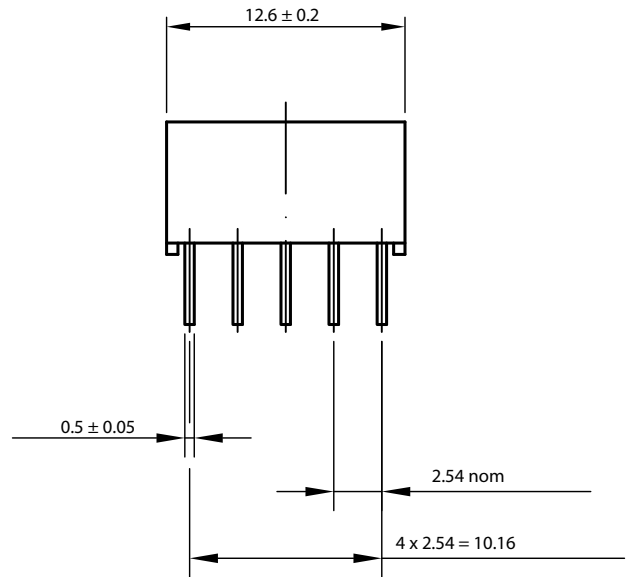
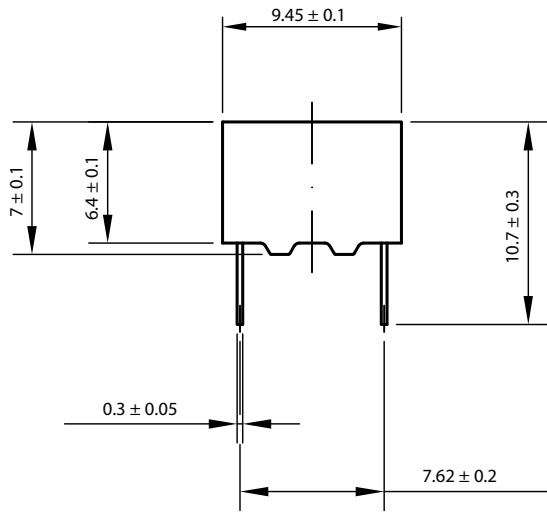

technical drawings
according to DIN
specifications

Drawing-No.: 6.544-5093.01-4
Issue: 2; 23.03.2012



Pin Connections 10 mm

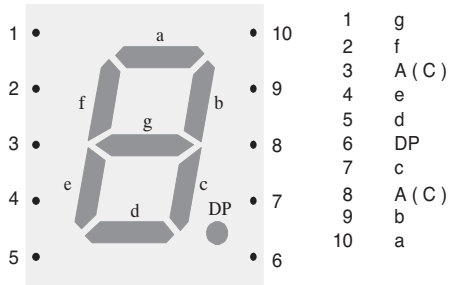

9611678

Ozone Depleting Substances Policy Statement

It is the policy of **Vishay Semiconductor GmbH** to

1. Meet all present and future national and international statutory requirements.
2. Regularly and continuously improve the performance of our products, processes, distribution and operating systems with respect to their impact on the health and safety of our employees and the public, as well as their impact on the environment.

It is particular concern to control or eliminate releases of those substances into the atmosphere which are known as ozone depleting substances (ODSs).

The Montreal Protocol (1987) and its London Amendments (1990) intend to severely restrict the use of ODSs and forbid their use within the next ten years. Various national and international initiatives are pressing for an earlier ban on these substances.

Vishay Semiconductor GmbH has been able to use its policy of continuous improvements to eliminate the use of ODSs listed in the following documents.

1. Annex A, B and list of transitional substances of the Montreal Protocol and the London Amendments respectively
2. Class I and II ozone depleting substances in the Clean Air Act Amendments of 1990 by the Environmental Protection Agency (EPA) in the USA
3. Council Decision 88/540/EEC and 91/690/EEC Annex A, B and C (transitional substances) respectively.

Vishay Semiconductor GmbH can certify that our semiconductors are not manufactured with ozone depleting substances and do not contain such substances.

**We reserve the right to make changes to improve technical design
and may do so without further notice.**

Parameters can vary in different applications. All operating parameters must be validated for each customer application by the customer. Should the buyer use Vishay Semiconductors products for any unintended or unauthorized application, the buyer shall indemnify Vishay Semiconductors against all claims, costs, damages, and expenses, arising out of, directly or indirectly, any claim of personal damage, injury or death associated with such unintended or unauthorized use.

Vishay Semiconductor GmbH, P.O.B. 3535, D-74025 Heilbronn, Germany
Telephone: 49 (0)7131 67 2831, Fax number: 49 (0)7131 67 2423



Disclaimer

ALL PRODUCT, PRODUCT SPECIFICATIONS AND DATA ARE SUBJECT TO CHANGE WITHOUT NOTICE TO IMPROVE RELIABILITY, FUNCTION OR DESIGN OR OTHERWISE.

Vishay Intertechnology, Inc., its affiliates, agents, and employees, and all persons acting on its or their behalf (collectively, "Vishay"), disclaim any and all liability for any errors, inaccuracies or incompleteness contained in any datasheet or in any other disclosure relating to any product.

Vishay makes no warranty, representation or guarantee regarding the suitability of the products for any particular purpose or the continuing production of any product. To the maximum extent permitted by applicable law, Vishay disclaims (i) any and all liability arising out of the application or use of any product, (ii) any and all liability, including without limitation special, consequential or incidental damages, and (iii) any and all implied warranties, including warranties of fitness for particular purpose, non-infringement and merchantability.

Statements regarding the suitability of products for certain types of applications are based on Vishay's knowledge of typical requirements that are often placed on Vishay products in generic applications. Such statements are not binding statements about the suitability of products for a particular application. It is the customer's responsibility to validate that a particular product with the properties described in the product specification is suitable for use in a particular application. Parameters provided in datasheets and/or specifications may vary in different applications and performance may vary over time. All operating parameters, including typical parameters, must be validated for each customer application by the customer's technical experts. Product specifications do not expand or otherwise modify Vishay's terms and conditions of purchase, including but not limited to the warranty expressed therein.

Except as expressly indicated in writing, Vishay products are not designed for use in medical, life-saving, or life-sustaining applications or for any other application in which the failure of the Vishay product could result in personal injury or death. Customers using or selling Vishay products not expressly indicated for use in such applications do so at their own risk. Please contact authorized Vishay personnel to obtain written terms and conditions regarding products designed for such applications.

No license, express or implied, by estoppel or otherwise, to any intellectual property rights is granted by this document or by any conduct of Vishay. Product names and markings noted herein may be trademarks of their respective owners.

Material Category Policy

Vishay Intertechnology, Inc. hereby certifies that all its products that are identified as RoHS-Compliant fulfill the definitions and restrictions defined under Directive 2011/65/EU of The European Parliament and of the Council of June 8, 2011 on the restriction of the use of certain hazardous substances in electrical and electronic equipment (EEE) - recast, unless otherwise specified as non-compliant.

Please note that some Vishay documentation may still make reference to RoHS Directive 2002/95/EC. We confirm that all the products identified as being compliant to Directive 2002/95/EC conform to Directive 2011/65/EU.

Vishay Intertechnology, Inc. hereby certifies that all its products that are identified as Halogen-Free follow Halogen-Free requirements as per JEDEC JS709A standards. Please note that some Vishay documentation may still make reference to the IEC 61249-2-21 definition. We confirm that all the products identified as being compliant to IEC 61249-2-21 conform to JEDEC JS709A standards.

Компания «Океан Электроники» предлагает заключение долгосрочных отношений при поставках импортных электронных компонентов на взаимовыгодных условиях!

Наши преимущества:

- Поставка оригинальных импортных электронных компонентов напрямую с производств Америки, Европы и Азии, а так же с крупнейших складов мира;
- Широкая линейка поставок активных и пассивных импортных электронных компонентов (более 30 млн. наименований);
- Поставка сложных, дефицитных, либо снятых с производства позиций;
- Оперативные сроки поставки под заказ (от 5 рабочих дней);
- Экспресс доставка в любую точку России;
- Помощь Конструкторского Отдела и консультации квалифицированных инженеров;
- Техническая поддержка проекта, помощь в подборе аналогов, поставка прототипов;
- Поставка электронных компонентов под контролем ВП;
- Система менеджмента качества сертифицирована по Международному стандарту ISO 9001;
- При необходимости вся продукция военного и аэрокосмического назначения проходит испытания и сертификацию в лаборатории (по согласованию с заказчиком);
- Поставка специализированных компонентов военного и аэрокосмического уровня качества (Xilinx, Altera, Analog Devices, Intersil, Interpoint, Microsemi, Actel, Aeroflex, Peregrine, VPT, Syfer, Eurofarad, Texas Instruments, MS Kennedy, Miteq, Cobham, E2V, MA-COM, Hittite, Mini-Circuits, General Dynamics и др.);

Компания «Океан Электроники» является официальным дистрибьютором и эксклюзивным представителем в России одного из крупнейших производителей разъемов военного и аэрокосмического назначения «JONHON», а так же официальным дистрибьютором и эксклюзивным представителем в России производителя высокотехнологичных и надежных решений для передачи СВЧ сигналов «FORSTAR».



JONHON

«JONHON» (основан в 1970 г.)

Разъемы специального, военного и аэрокосмического назначения:

(Применяются в военной, авиационной, аэрокосмической, морской, железнодорожной, горно- и нефтедобывающей отраслях промышленности)

«FORSTAR» (основан в 1998 г.)

ВЧ соединители, коаксиальные кабели, кабельные сборки и микроволновые компоненты:

(Применяются в телекоммуникациях гражданского и специального назначения, в средствах связи, РЛС, а так же военной, авиационной и аэрокосмической отраслях промышленности).



Телефон: 8 (812) 309-75-97 (многоканальный)

Факс: 8 (812) 320-03-32

Электронная почта: ocean@oceanchips.ru

Web: <http://oceanchips.ru/>

Адрес: 198099, г. Санкт-Петербург, ул. Калинина, д. 2, корп. 4, лит. А