

R-Rated

Medium voltage fuses for motor circuit protection



Features and benefits:

- Current-limiting R-Rated fuses will safely interrupt all currents between their minimum and maximum interrupting ratings and will melt in a range of 15 to 35 seconds at a value of 100 times the “R” number per ANSI C37.46.
- R-Rated fuses are physically dimensioned for easy installation in existing hardware.
- Available in standard, AMPGARD™ Hookeye and hermetically sealed, and bolt-on mounting styles to meet application needs.
- 2.4kV and 4.8kV AMPGARD hermetically sealed constructions are suitable for Class I, Group D, Div. 2 hazardous locations.
- Open fuse indicator on all mounting styles speeds troubleshooting.
- Classified as backup fuses for current-limiting protection of medium voltage motor controllers (short-circuit performance only).
- These fuses are in a self-contained, non-venting package for installation indoors or outdoors in an enclosure.

Description:

- Indoor/enclosure, R-Rated medium voltage, current-limiting fuses for motor circuit protection.

Typical applications:

- Medium voltage motors and controllers

Contents

Description	Page	Description	Page
2.4kV R-Rated fuses.....	2-7	7.2kV R-Rated fuses	17-21
Introduction	2	Introduction	17
Catalog numbers.....	3	Catalog numbers.....	18
Curves	4-7	Curves	19-21
4.8kV R-Rated fuses.....	8-16		
Introduction	8		
Catalog numbers.....	9		
Curves	10-16		

2.4kV R-Rated fuses

Catalog symbols:

Code-(amps)R	Construction
2CLS-25	Standard (25A only)
2ACLS-25	AMPGARD hookeye (25A only)
JCK-_R	Standard (2R-24R)
JCK-A-_R	AMPGARD hookeye* (2R-24R)
2HCLS-_R	Hermetically sealed AMPGARD hookeye* (25A/2R-24R)
2BCLS-_R	Bolt-on (25A/2R-24R)

* For use in 400 amp AMPGARD motor starters.

Ratings:

- Volts
 - 2.4kV (nominal)
 - 2.54kV (max design)
- Amps 25-450A
- Interrupting ratings
 - 50kA Sym
 - 80kA Asym

Agency information:

- UL® Recognized: Guide #MSSS2, File #E96676

Recommended fuse holders for standard constructions:

Amp range	Description	Cat. No.
Fuseclips		
25-230A	3" enclosed fuseclip*	A3354730
25-450A	3" open fuseclip	1A0065
	3" spring loaded open fuseclip	9078A67G04
Fuse holders		
25-230A Single barrel	Non-disconnect holder, porcelain	2CLE-PNM-D
	Non-disconnect holder, glass polyester	2CLE-GNM-D
	Disconnect holder, porcelain	2CLE-PDM-D
	Disconnect holder, glass polyester	2CLE-GDM-E
390-450A Double barrel	Non-disconnect holder, porcelain	2CLE-PNM-E
	Non-disconnect holder, glass polyester	2CLE-GNM-E
	Disconnect holder, glass polyester	2CLE-GDM-E

* Single barrel only, not sold in pairs.

Dimensions - in [mm]

Construction	Amp range	Dimension			
		A	B	C	D
Standard - short	25-230A	10.8 (274)	3 (76)	3 (76)	—
	390-450A	10.8 (274)	3 (76)	3 (76)	3.3 (84)
AMPGARD Hookeye*	70-230A	10.8 (274)	3 (76)	3 (76)	—
	390-450A	10.8 (274)	3 (76)	3 (76)	3.3 (84)
Bolt-on	25-230A	19.2 (488)	17.9 (455)	3 (76)	—
	390-450A	19.2 (488)	17.9 (455)	3 (76)	3.3 (84)

* Includes hermetically sealed versions.

Standard and AMPGARD hookeye



Bolt-on

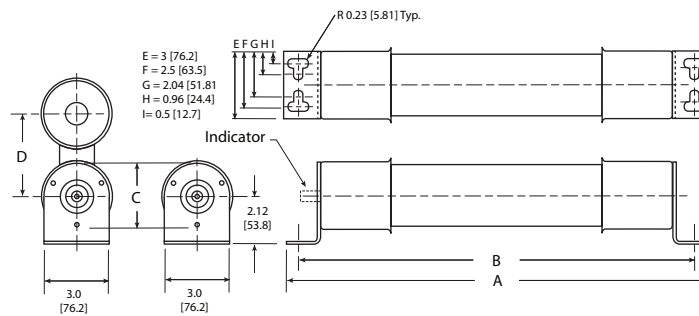

2.4kV R-Rated fuse catalog numbers

Amp rating	"R" Designation	Mounting style (minimum interrupting rating in amps)				Number of barrels
		Standard	AMPGARD Hookeye		Bolt-on	
			Regular	Hermetically sealed		
25	—	2CLS-25* (90)	2ACLS-25* (90)	2HCLS-25* (90)	2BCLS-25* (90)	1
70	2R	JCK-2R (165)	JCK-A-2R (165)	2HCLS-2R (170)	2BCLS-2R (170)	1
100	3R	JCK-3R (220)	JCK-A-3R (220)	2HCLS-3R (245)	2BCLS-3R (245)	1
130	4R	JCK-4R (320)	JCK-A-4R (320)	2HCLS-4R (340)	2BCLS-4R (340)	1
150	5R	JCK-5R (410)	JCK-A-5R (410)	2HCLS-5R (430)	2BCLS-5R (430)	1
170	6R	JCK-6R (480)	JCK-A-6R (480)	2HCLS-6R (500)	2BCLS-6R (500)	1
200	9R	JCK-9R (720)	JCK-A-9R (720)	2HCLS-200* (1000)	2BCLS-9R (1000)	1
230	12R	JCK-12R (970)	JCK-A-12R (970)	2HCLS-230* (1250)	2BCLS-12R (1250)	1
390	18R	JCK-18R (1430)	JCK-A-18R (1430)	2HCLS-390* (1700)	2BCLS-18R (1700)	2
450	24R	JCK-24R (1880)	JCK-A-24R (1880)	2HCLS-24R (2100)	2BCLS-24R (2100)	2

* Does not comply with ANSI C37.46 for "R" rating.

JCK and 2HCLS Type mountings -in (mm)

Catalog number	Hole centers		Overall length	Hole Inset	Hole centers	Contact height	Overall height	BIL rating (kV)
	A	B	C	D	E	F	G	
Disconnect single barrel†								
2CLE-GDM-D	8.24 (209.3)	6 (152.4)	18 (457.2)	0.62 (15.7)	1.75 (44.4)	4.5 (114.3)	11.72 (297.7)	60
2CLE-PDM-D	8.24 (209.3)	6 (152.4)	18 (457.2)	0.62 (15.7)	1.75 (44.4)	4.5 (114.3)	11.72 (297.7)	60
Disconnect double barrel†								
2CLE-GDM-E	8.24 (209.3)	6 (152.4)	18 (457.2)	0.62 (15.7)	1.75 (44.4)	4.5 (114.3)	15.28 (388.1)	60
2CLE-PDM-E	8.24 (209.3)	6 (152.4)	18 (457.2)	0.62 (15.7)	1.75 (44.4)	4.5 (114.3)	15.28 (388.1)	60
Non-disconnect single barrel								
2CLE-GNM-D	8.24 (209.3)	6 (152.4)	18 (457.2)	0.62 (15.7)	1.75 (44.4)	4.5 (114.3)	8.79 (223.3)	60
2CLE-PNM-D	8.24 (209.3)	6 (152.4)	18 (457.2)	0.62 (15.7)	1.75 (44.4)	4.5 (114.3)	8.79 (223.3)	60
Non-disconnect double barrel								
2CLE-GNM-E	8.24 (209.3)	6 (152.4)	18 (457.2)	0.62 (15.7)	1.75 (44.4)	4.5 (114.3)	12.48 (317.0)	60
2CLE-PNM-E	8.24 (209.3)	6 (152.4)	18 (457.2)	0.62 (15.7)	1.75 (44.4)	4.5 (114.3)	12.48 (317.0)	60

2.4kV disconnect mounting†



2.4kV non-disconnect mounting



† Disconnect mountings provide a means for fuse extraction only. Do not use a disconnect mounting for load switching or fuse removal while energized.

2.4kV time-current curves — minimum melting for 2HCLS-_R and 2BCLS-_R (25A, 2R-24R @25°C)

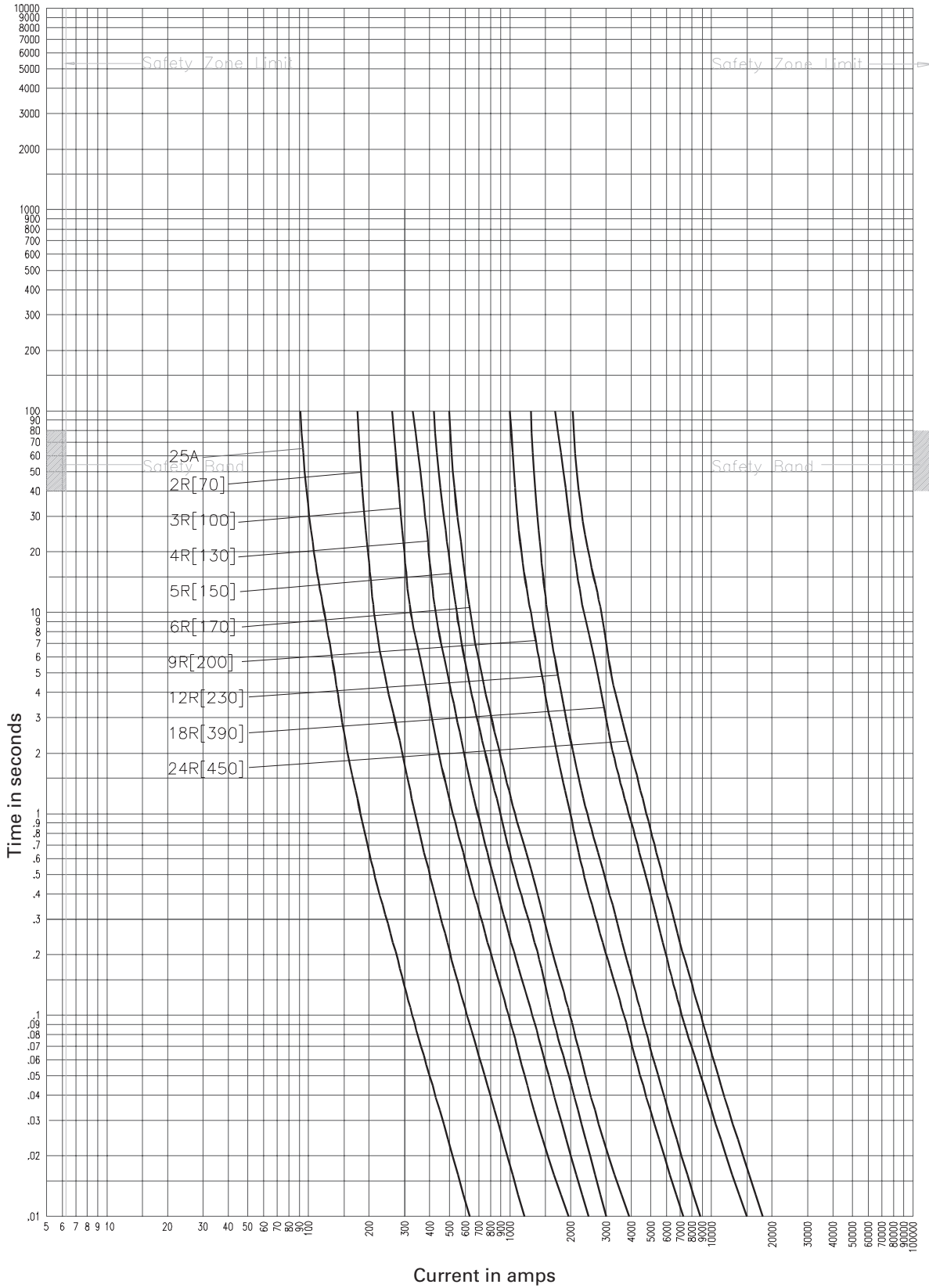

2HCLS-_R and 2BCLS-_R

CURVE 66664702
January 2001
Reference # 666647,
512853, 639405

2.4kV time-current curves — total clearing for 2HCLS-_R and 2BCLS-_R (25A, 2R-24R @25°C)



2HCLS-_R and 2BCLS-_R

CURVE 66664704
January 2000
Reference # 666647,
512854, 639406

2.4kV peak let-through curves for 2HCLS-_R and 2BCLS-_R (25A, 2R-24R @25°C)

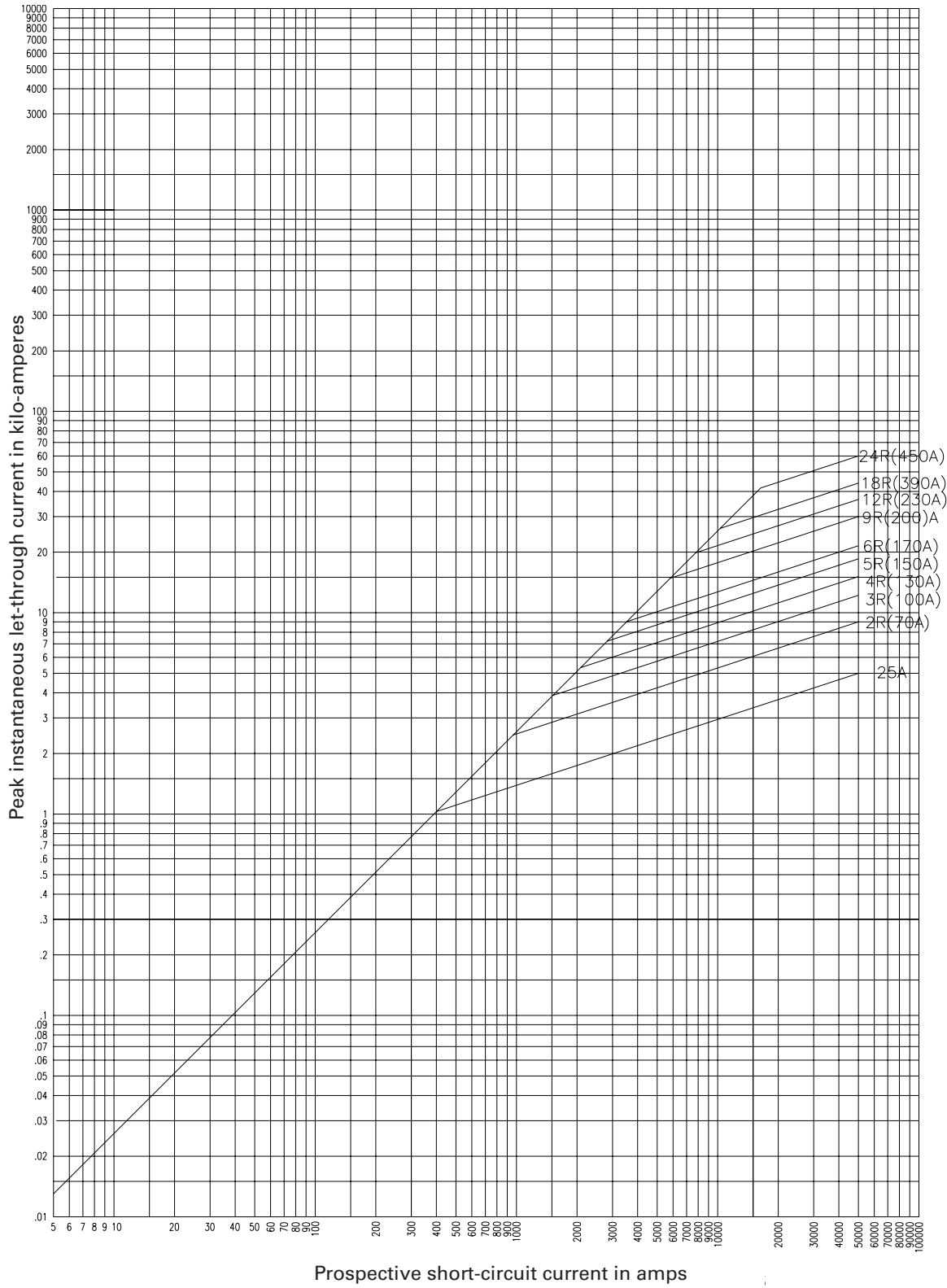

2HCLS-_R and 2BCLS-_R

CURVE 66700202
 January 2001
 Reference # 639315

2.4kV time-current curves – minimum melting for JCK-_R and JCK-A-_R (2R-24R @25°C)



2.4kV time-current curves – total clearing for JCK-_R and JCK-A-_R (2R-24R @25°C)



2.4kV peak let-through curves for JCK-_R and JCK-A-_R (2R-24R @25°C)



4.8kV R-Rated fuses

Catalog symbols:

Code-(amps)	Construction
5CLS-30	Standard - short (30A)
JCL_R	Standard - short (2R - 24R)
5LCLS_R	Standard - long (2R - 24R)
JCL-A_R	AMPGARD hookeye* (2R - 24R)
5ACLS-30	AMPGARD hookeye* (30A)
5HCLS-30	Hermetically sealed AMPGARD hookeye* (30A)
5HCLS_R	Hermetically sealed AMPGARD hookeye* (2R-24R)
5BCLS-30	Bolt-on (30A)
5BCLS_R	Bolt-on (2R - 44R)

* For use in 400 amp AMPGARD motor starters.

Ratings:

- Volts
 - 4.8kV (nominal)
 - 5.08kV (max design)
- Amps
 - 30-450A
- Interrupting ratings
 - 50kA Sym
 - 80kA Asym

Agency information:

- UL Recognized: Guide #MSSS2, File #E96676 (JCL_R [2R-24R] and JCL-A_R [2R-24R])

Recommended fuse holders for standard constructions:

Amp range	Description	BIL (kV)	Cat. No.
Fuseclips			
30-230A	3" enclosed fuseclip*	—	A3354730
30-450A	3" open fuseclip	—	1A0065
	3" spring loaded open fuseclip	—	9078A67G04
Fuse holders for CLS / JCL / 5HCLS			
30-230A Single barrel	Non-disconnect holder, porcelain	60	5HLE-PNM-D
	Non-disconnect holder, glass polyester	60	5HLE-GNM-D
	Disconnect holder, porcelain	60	5HLE-PDM-D
	Disconnect holder, glass polyester	60	5HLE-GDM-D
390-450A Double barrel	Non-disconnect holder, porcelain	60	5HLE-PNM-E
	Non-disconnect holder, glass polyester	60	5HLE-GNM-E
	Disconnect holder, glass polyester	60	5HLE-GDM-E
Fuse holders for 5LCLS†			
	Non-disconnect holder, porcelain	60	5CLE-PNM-D
	Non-disconnect holder, glass polyester	60	5CLE-GNM-D
70-230A Single barrel	Disconnect holder, porcelain	60	5CLE-PDM-D
	Disconnect holder, glass polyester	60	5CLE-GDM-D
	Disconnect holder, porcelain	75	8CLE-PDM-D
	Disconnect holder, glass polyester	75	8CLE-GDM-D
390-450A Double Barrel	Disconnect holder, porcelain	60	5CLE-PDM-E
	Disconnect holder, glass polyester	60	5CLE-GDM-E

* Single barrel only, not sold in pairs.

** Not available for standard - long constructions

† Not available for 390 to 450 amp ratings.

Dimensions - in [mm]

Construction	Amp range	Dimension			
		A	B	C	D
Standard - short	30-230A	15.6 (396)	3 (76)	3 (76)	—
	390-450A	15.6 (396)	3 (76)	3 (76)	3.3 (84)
Standard - long	70-230A	17.9 (455)	3 (76)	3 (76)	—
	390-450A	17.9 (455)	3 (76)	3 (76)	3.3 (84)
AMPGARD hookeye*	30-230A	15.9 (404)	3 (76)	3 (76)	—
	390-450A	15.9 (404)	3 (76)	3 (76)	3.3 (84)
Bolt-on	30-230A	19.2 (488)	17.9 (455)	3 (76)	—
	390-450A	19.2 (488)	17.9 (455)	3 (76)	3.3 (84)

* Includes hermetically sealed versions.

Standard (short and long) and AMPGARD Hookeye



Bolt-on



4.8kV R-Rated fuse catalog numbers

Amp Rating	"R" Designation	Mounting style (minimum interrupting rating in amps)					Number of barrels
		"R"		AMPGARD Hookeye			
		Standard - short	Standard - long	Regular	Hermetically sealed	Bolt-on	
30	—	5CLS-30* (95)	—	5ACLS-30* (95)	5HCLS-30* (95)	5BCLS-30* (95)	1
70	2R	JCL-2R (165)	5LCLS-2R (165)	JCL-A-2R	5HCLS-2R (180)	5BCLS-2R (180)	1
100	3R	JCL-3R (220)	5LCLS-3R (220)	JCL-A-3R	5HCLS-3R (270)	5BCLS-3R (270)	1
130	4R	JCL-4R (320)	5LCLS-4R (320)	JCL-A-4R	5HCLS-4R (350)	5BCLS-4R (350)	1
150	5R	JCL-5R (410)	5LCLS-5R (410)	JCL-A-5R	5HCLS-5R (450)	5BCLS-5R (450)	1
170	6R	JCL-6R (480)	5LCLS-6R (480)	JCL-A-6R	5HCLS-6R (540)	5BCLS-6R (540)	1
200	9R	JCL-9R (720)	5LCLS-9R (720)	JCL-A-9R	5HCLS-9R (700)	5BCLS-9R (700)	1
230	12R	JCL-12R (970)	5LCLS-12R (970)	JCL-A-12R	5HCLS-12R (1000)	5BCLS-12R (1000)	1
390	18R	JCL-18R (1430)	5LCLS-18R (1430)	JCL-A-18R	5HCLS-18R (1450)	5BCLS-18R (1450)	2
450	24R	JCL-24R (1880)	5LCLS-24R (1880)	JCL-A-24R	5HCLS-24R (2000)	5BCLS-24R (2000)	2
600	32R	—	—	—	—	5BCLS-32R (2600)	2
650	36R	—	—	—	—	5BCLS-36R (3000)	2
800	44R	—	—	—	—	5BCLS-44R (3250)	2

* Does not comply with ANSI C37.46 for "R" rating.

5CLS, JCL, JCL-A, 5ACLS, 5HCLS and 5LCLS Type mountings - in (mm)

	Hole centers A	Overall length B	Hole insert C	Hole centers D	Contact height E	Overall height F	
Disconnect single barrel†							
5CLE-GDM-D	15.24 (387.1)	6 (152.4)	25 (647.7)	0.62 (15.7)	1.75 (44.4)	4.5 (114.3)	11.72 (297.7)
5CLE-PDM-D	15.24 (387.1)	6 (152.4)	25 (647.7)	0.62 (15.7)	1.75 (44.4)	4.5 (114.3)	11.72 (297.7)
5HLE-PDM-D	16.25 (412.8)	6 (152.4)	23 (584.2)	0.62 (15.7)	1.75 (44.4)	4.5 (114.3)	11.72 (297.7)
5HLE-GDM-D	16.25 (412.8)	6 (152.4)	23 (584.2)	0.62 (15.7)	1.75 (44.4)	4.5 (114.3)	11.72 (297.7)
Disconnect double barrel†							
5CLE-GDM-E	15.24 (387.1)	6 (152.4)	25 (647.7)	0.62 (15.7)	1.75 (44.4)	4.5 (114.3)	15.28 (388.1)
5CLE-PDM-E	15.24 (387.1)	6 (152.4)	25 (647.7)	0.62 (15.7)	1.75 (44.4)	4.5 (114.3)	15.28 (388.1)
5HLE-GDM-E	16.25 (412.8)	6 (152.4)	23 (584.2)	0.62 (15.7)	1.75 (44.4)	4.5 (114.3)	15.28 (388.1)
5HLE-PDM-E	16.25 (412.8)	6 (152.4)	23 (584.2)	0.62 (15.7)	1.75 (44.4)	4.5 (114.3)	15.28 (388.1)
Non-disconnect single barrel							
5CLE-GNM-D	15.24 (387.1)	6 (152.4)	25 (635.0)	0.62 (15.7)	1.75 (44.4)	4.5 (114.3)	8.79 (223.3)
5CLE-PNM-D	15.24 (387.1)	6 (152.4)	25 (635.0)	0.62 (15.7)	1.75 (44.4)	4.5 (114.3)	8.79 (223.3)
5HLE-GNM-D	16.25 (412.7)	6 (152.4)	23 (584.2)	0.62 (15.7)	1.75 (44.4)	4.5 (114.3)	8.79 (223.3)
5HLE-PNM-D	16.25 (412.7)	6 (152.4)	23 (584.2)	0.62 (15.7)	1.75 (44.4)	4.5 (114.3)	8.79 (223.3)
Non-disconnect double barrel							
5HLE-PNM-E	16.25 (412.7)	6 (152.4)	25 (635.0)	0.62 (15.7)	1.75 (44.4)	4.5 (114.3)	12.48 (317.0)
5HLE-GNM-E	16.25 (412.7)	6 (152.4)	25 (635.0)	0.62 (15.7)	1.75 (44.4)	4.5 (114.3)	12.48 (317.0)

4.8kV disconnect mounting†

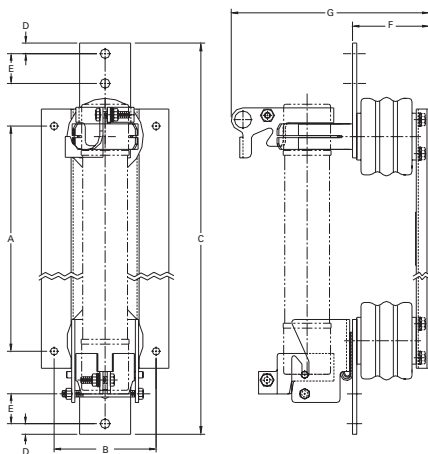

4.8kV non-disconnect mounting



† Disconnect mountings provide a means for fuse extraction only. Do not use a disconnect mounting for load switching or fuse removal while energized.

4.8kV time-current curves – minimum melting for 5ACLS-30, 5CLS-30, 5HCLS-_R, 5BCLS-30 and 5BCLS-_R (30A, 2R-24R @ 25°C)

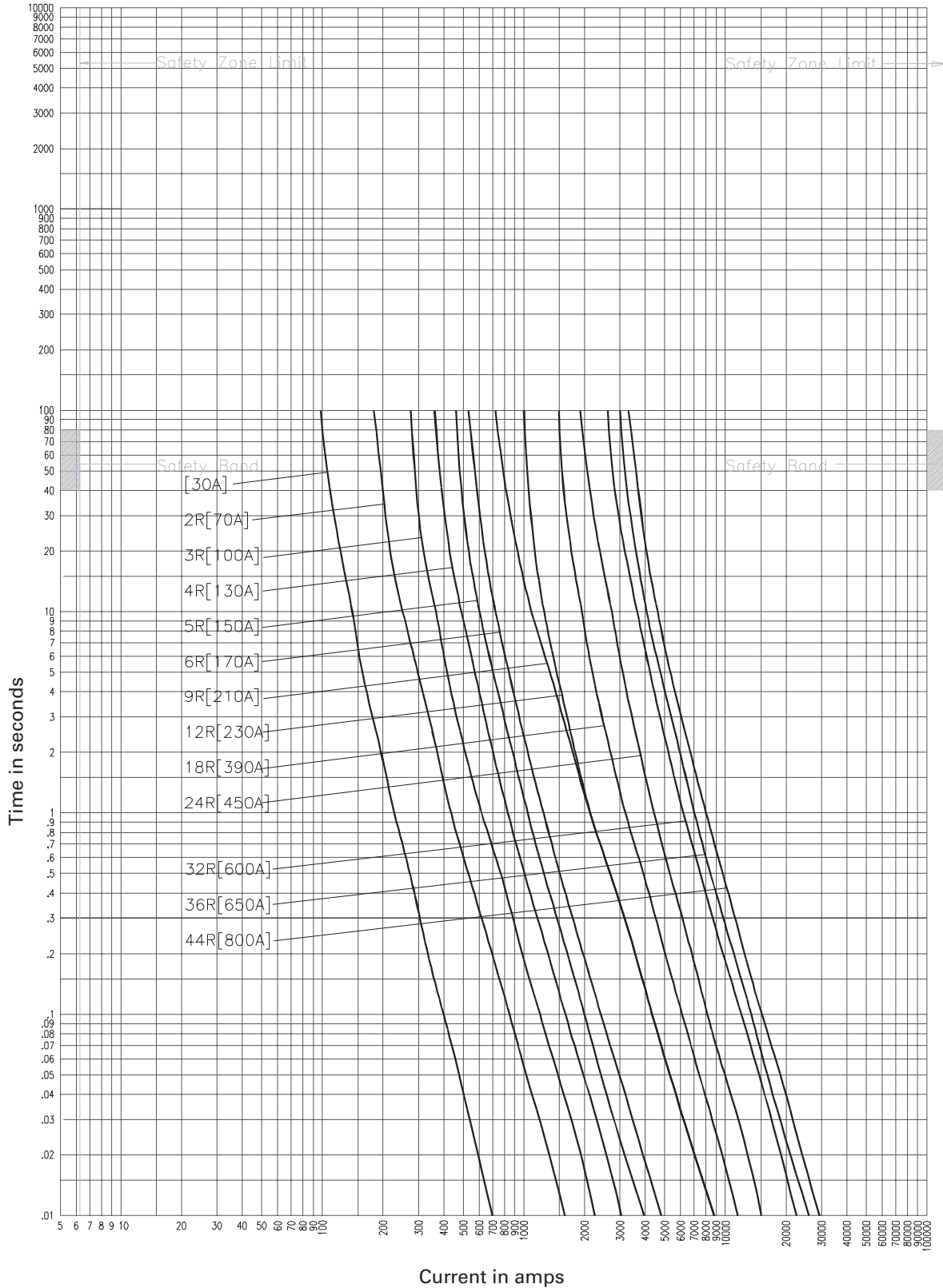

5ACLS-30, 5CLS-30, 5HCLS-_R, 5BCLS-30, 5BCLS-_R,
5MCLS-_R-A, 5MCLS-_R-B

CURVE 66690602
January 2001
Reference # 666907,
666703, 666910,
667000, 639472.

4.8kV time-current curves — total clearing for 5ACLS-30, 5CLS-30, 5HCLS-_R, 5BCLS-30 and 5BCLS-_R (30A, 2R-24R @ 25°C)



5ACLS-30, 5CLS-30, 5HCLS-_R, 5BCLS-30, 5BCLS-_R,
5MCLS-_R-A, 5MCLS-_R-B

CURVE 66690702
January 2001
Reference # 666907
666704, 666910,
6670001, 639472.

4.8kV peak let-through curves for 5ACLS-30, 5CLS-30, 5HCLS-_R, 5BCLS-30 and 5BCLS-_R (30A, 2R-24R @ 25°C)

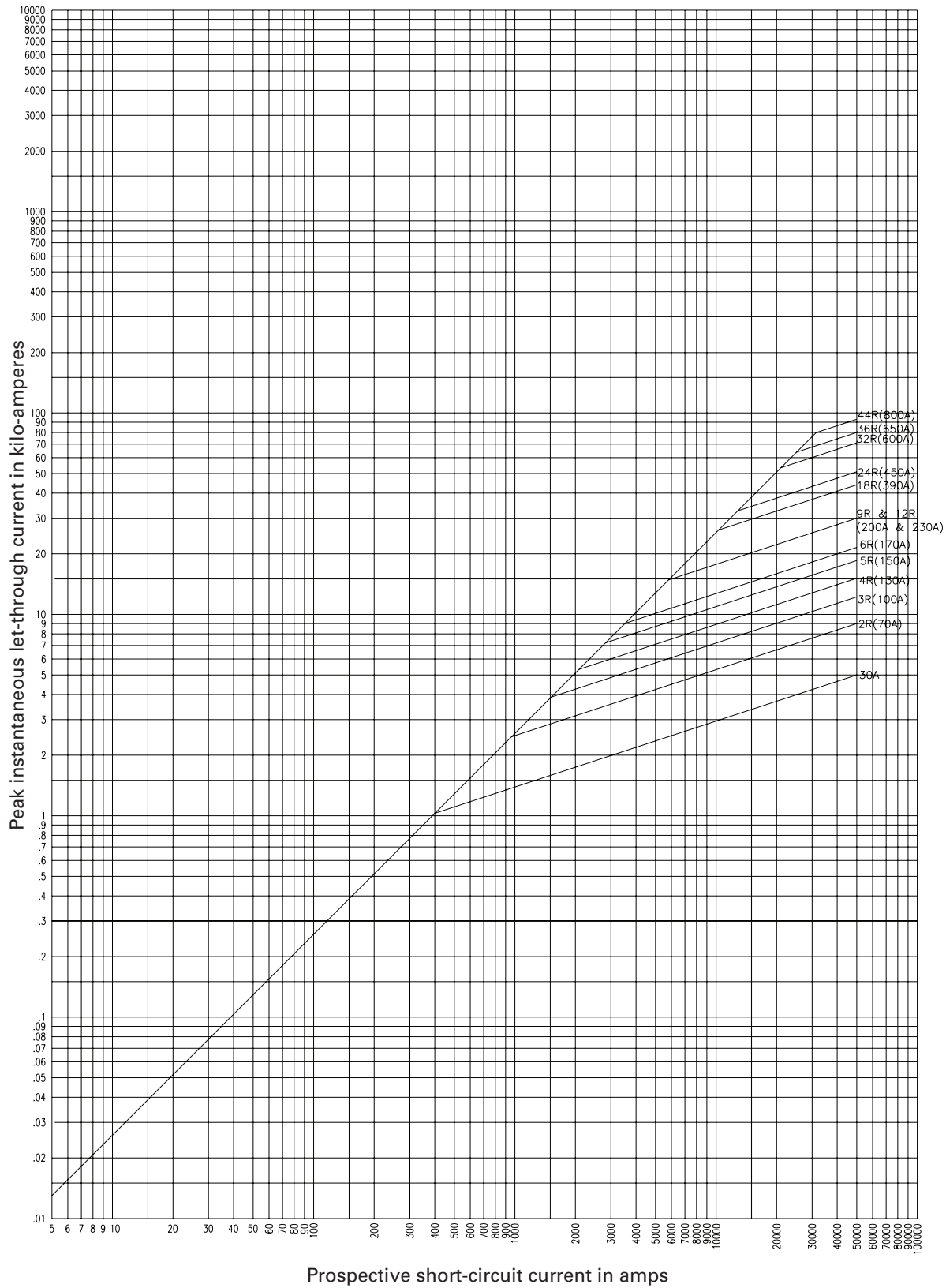

5ACLS-30, 5CLS-30, 5HCLS-_R, 5BCLS-30, 5BCLS-_R,
 5MCLS-_R-A, 5MCLS-_R-B

CURVE 66700203
 January 2001
 Reference # 639315
 667002, 667008

4.8kV time-current curves – minimum melting for JCL-R and JCL-A-R (2R-24R @25°C)



4.8kV time-current curves – total clearing for JCL-R and JCL-A-R (2R-24R @25°C)



4.8kV peak let-through curves for JCL-R and JCL-A-R (2R-24R @25°C)

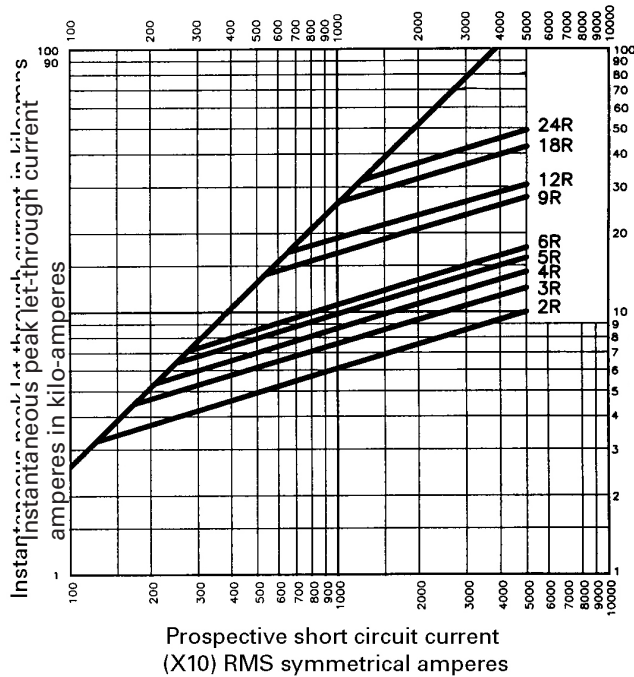

4.8kV time-current curves — minimum melting for 5LCLS-_R (2R-24R @ 25°C)



5LCLS-_R

CURVE 51285302
January 2001
Reference # 512853,
563863.

4.8kV time-current curves — total clearing for 5LCLS-R (2R-24R @ 25°C)

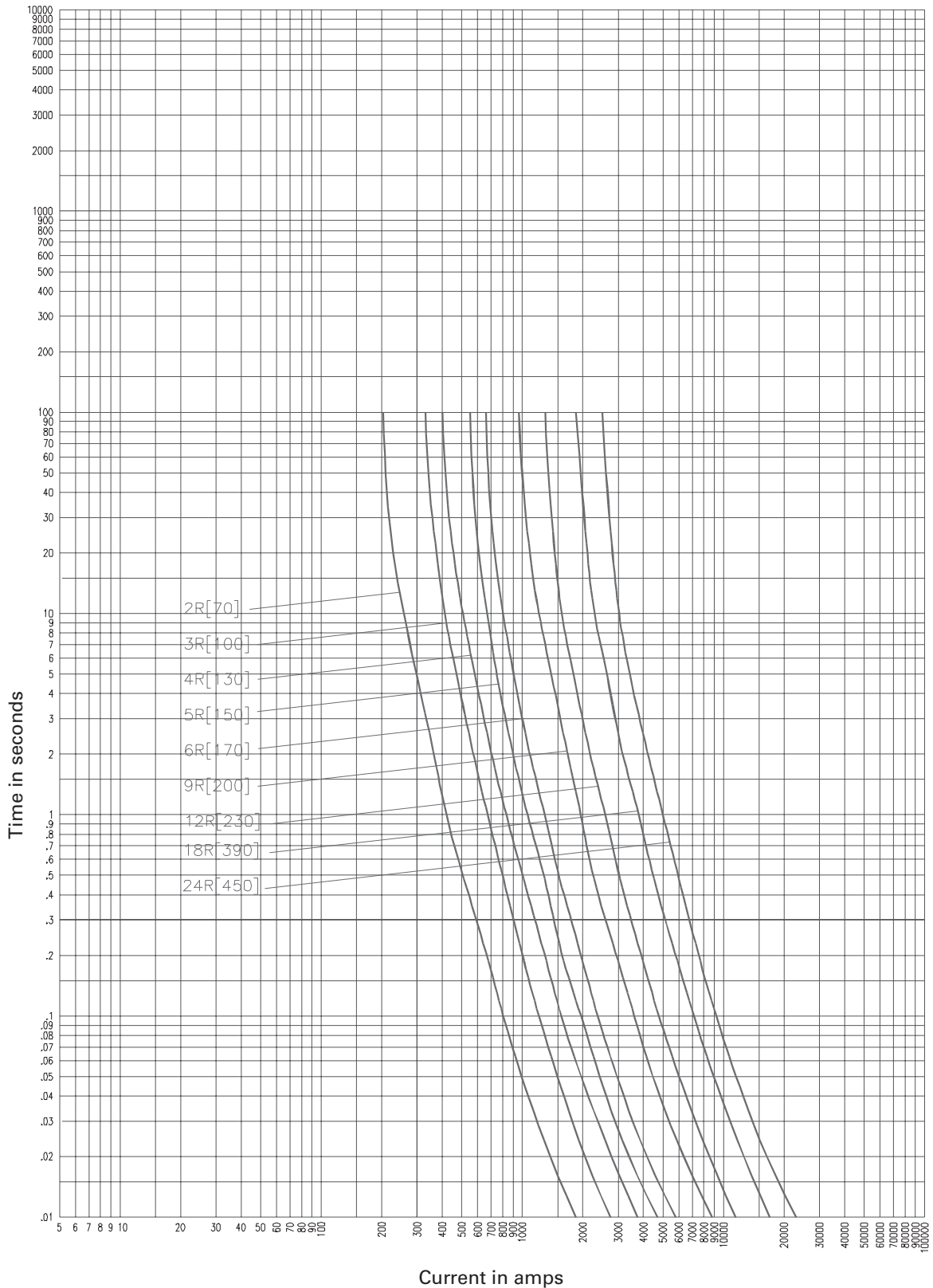

5LCLS-R

CURVE 51285402
January 2001
Reference # 512854,
563864.

4.8kV peak let-through curves for 5LCLS_R (2R-24R @ 25°C)



5LCLS_R

CURVE 66700204
 January 2001
 Reference # 639315

7.2kV R-Rated fuses

Catalog symbols:

Code-(amps)R	Construction
8CLS-_R	Standard (2R - 6R)
7CLS-_R	Standard (9R - 24R)
8ACLS-_R	AMPGARD hookeye* (2R - 6R)
7ACLS-_R	AMPGARD hookeye* (9R - 24R)
7BCLS-_R	Bolt-on (2R - 44R)

* For use in 400 amp AMPGARD motor starters.

Ratings:

- Volts
 - 7.2kV (nominal)
 - 8.3kV (max design 70-170A standard and AMPGARD Hookeye)
 - 7.2kV (max design 200-450A standard and AMPGARD Hookeye)
 - 7.2kV (max design 70-800 bolt-on)
- Amps 25-450A
- Interrupting ratings
 - 50kA Sym
 - 80kA Asym

Recommended fuse holders for standard constructions:

Amp range	Description	BIL (kV)	Cat. No.
Fuseclips			
70-230A	3" Enclosed fuseclip*	—	A3354730
70-450A	3" Open fuseclip	—	1A0065
	3" Spring loaded open fuseclip	—	9078A67G04
Fuse holders for 7CLS and 8CLS			
70-230A Single barrel	Non-disconnect holder, porcelain	75	8HLE-PNM-D
	Non-disconnect holder, glass polyester	75	8HLE-GNM-D
	Disconnect holder, porcelain	75	8HLE-PDM-D
	Disconnect holder, glass polyester	75	8HLE-GDM-D
390-450A Double barrel	Non-disconnect holder, porcelain	75	8HLE-PNM-E
	Non-disconnect holder, glass polyester	75	8HLE-GNM-E
	Disconnect holder, porcelain	75	8HLE-PDM-E
	Disconnect holder, glass polyester	75	8HLE-GDM-E

* Single barrel only, not sold in pairs.

Dimensions - in [mm]

Construction	Amp range	Dimension			
		A	B	C	D
Standard	70-230A	15.8 (401)	3 (76)	3 (76)	—
	390-450A	15.8 (401)	3 (76)	3 (76)	3.3 (84)
AMPGARD hookeye	70-230A	15.8 (401)	3 (76)	3 (76)	—
	390-450A	15.8 (401)	3 (76)	3 (76)	3.3 (84)
Bolt-on	70-230A	19.2 (488)	17.9 (455)	3 (76)	—
	390-650A	19.2 (488)	17.9 (455)	3 (76)	3.3 (84)
	800A	19.2 (488)	17.9 (455)	4 (102)	3.3 (84)

Standard and AMPGARD hookeye



Bolt-on



72kV R-Rated fuse catalog numbers

Amp rating	"R" Designation		Mounting style (minimum interrupting rating in amps)			Number of barrels
			Standard	AMPGARD Hookeye	Bolt-on	
70	2R	8CLS-2R (160)	8ACLS-2R (160)	7BCLS-2R (160)	1	
100	3R	8CLS-3R (250)	8ACLS-3R (250)	7BCLS-3R (250)	1	
130	4R	8CLS-4R (325)	8ACLS-4R (325)	7BCLS-4R (325)	1	
150	5R	8CLS-5R (390)	8ACLS-5R (390)	7BCLS-5R (390)	1	
170	6R	8CLS-6R (500)	8ACLS-6R (500)	7BCLS-6R (500)	1	
200	9R	7CLS-9R (750)	7ACLS-9R (750)	7BCLS-9R (750)	1	
230	12R	7CLS-12R (1000)	7ACLS-12R (1000)	7BCLS-12R (1000)	1	
390	18R	7CLS-18R (1450)	7ACLS-18R (1450)	7BCLS-18R (1450)	2	
450	24R	7CLS-24R (2500)	7ACLS-24R (2500)	7BCLS-24R (2500)	2	
650	36R	—	—	7BCLS-36R (3000)	2	
800	44R	—	—	7BCLS-44R (3250)	2	

8CLS, 8ACLS, 7CLS, 7ACLS Type mountings - in (mm)

Catalog number	Hole centers		Overall length C	Hole inset D	Hole centers		Contact height F	Overall height G	BIL rating (kV)
	A	B			E				
Disconnect single barrel†									
8HLE-GDM-D	16.25 (412.8)	6 (152.4)	23 (584.2)	0.62 (15.7)	1.75 (44.4)	7 (177.8)	11.72 (297.7)	75	
8HLE-PDM-D	16.25 (412.8)	6 (152.4)	23 (584.2)	0.62 (15.7)	1.75 (44.4)	7 (177.8)	11.72 (297.7)	75	
Disconnect double barrel†									
8HLE-GDM-E	16.25 (412.8)	6 (152.4)	23 (584.2)	0.62 (15.7)	1.75 (44.4)	7 (177.8)	17.78 (451.6)	75	
8HLE-PDM-E	16.25 (412.8)	6 (152.4)	23 (584.2)	0.62 (15.7)	1.75 (44.4)	7 (177.8)	17.78 (451.6)	75	
Non-disconnect single barrel									
8HLE-GNM-D	16.25 (412.7)	6 (152.4)	23 (584.2)	0.62 (15.7)	1.75 (44.4)	7 (177.8)	11.29 (286.7)	75	
8HLE-PNM-D	16.25 (412.7)	6 (152.4)	23 (584.2)	0.62 (15.7)	1.75 (44.4)	7 (177.8)	11.29 (286.7)	75	
Non-disconnect double barrel									
8HLE-GNM-E	16.25 (412.7)	6 (152.4)	23 (584.2)	0.62 (15.7)	1.75 (44.4)	7 (177.8)	14.98 (380.5)	75	
8HLE-PNM-E	16.25 (412.7)	6 (152.4)	23 (584.2)	0.62 (15.7)	1.75 (44.4)	7 (177.8)	14.98 (380.5)	75	

72kV disconnect mounting†



72kV non-disconnect mounting



† Disconnect mountings provide a means for fuse extraction only. Do not use a disconnect mounting for load switching or fuse removal while energized.

7.2kV time-current curves — minimum melting for 8CLS- R, 7CLS- R, 8ACLS- R, 7ACLS- R and 7BCLS- R (2R-44R @ 25C)



8CLS- R, 7CLS- R, 8ACLS- R, 7ACLS- R and 7BCLS- R

CURVE TC66700602
December 2008

7.2kV time-current curves — total clearing for 8CLS-_R, 7CLS-_R, 8ACLS-_R, 7ACLS-_R and 7BCLS-_R (2R-44R @ 25C)



8CLS-_R, 7CLS-_R, 8ACLS-_R, 7ACLS-_R and 7BCLS-_R

CURVE TC66700702
December 2008

7.2kV peak let-through curves for 8CLS-_R, 7CLS-_R, 8ACLS-_R, 7ACLS-_R and 7BCLS-_R (2R-44R @ 25C)



8CLS-_R, 7CLS-_R, 8ACLS-_R, 7ACLS-_R and 7BCLS-_R

CURVE 66700205
January 2001
Reference # 639315
667002, 667008

The only controlled copy of this data sheet is the electronic read-only version located on the Eaton network drive. All other copies of this document are by definition uncontrolled. This bulletin is intended to clearly present comprehensive product data and provide technical information that will help the end user with design applications. Eaton reserves the right, without notice, to change design or construction of any products and to discontinue or limit distribution of any products. Eaton also reserves the right to change or update, without notice, any technical information contained in this bulletin. Once a product has been selected, it should be tested by the user in all possible applications.

Eaton
1000 Eaton Boulevard
Cleveland, OH 44122
United States
Eaton.com

Bussmann Division
114 Old State Road
Ellisville, MO 63021
United States
Eaton.com/bussmannseries

© 2015 Eaton
All Rights Reserved
Printed in USA
Publication No. 6001 - BU-SB15148
December 2015

Eaton, Bussmann, AMPGARD and Low-Peak are valuable trademarks of Eaton in the US and other countries. You are not permitted to use the Eaton trademarks without prior written consent of Eaton.

CSA is a registered trademark of the Canadian Standards Group.
UL is a registered trademark of the Underwriters Laboratories, Inc.

For Eaton's Bussmann series
product information,
call **1-855-287-7626** or visit:
Eaton.com/bussmannseries

Follow us on social media to get the latest product and support information.



Компания «Океан Электроники» предлагает заключение долгосрочных отношений при поставках импортных электронных компонентов на взаимовыгодных условиях!

Наши преимущества:

- Поставка оригинальных импортных электронных компонентов напрямую с производств Америки, Европы и Азии, а так же с крупнейших складов мира;
- Широкая линейка поставок активных и пассивных импортных электронных компонентов (более 30 млн. наименований);
- Поставка сложных, дефицитных, либо снятых с производства позиций;
- Оперативные сроки поставки под заказ (от 5 рабочих дней);
- Экспресс доставка в любую точку России;
- Помощь Конструкторского Отдела и консультации квалифицированных инженеров;
- Техническая поддержка проекта, помощь в подборе аналогов, поставка прототипов;
- Поставка электронных компонентов под контролем ВП;
- Система менеджмента качества сертифицирована по Международному стандарту ISO 9001;
- При необходимости вся продукция военного и аэрокосмического назначения проходит испытания и сертификацию в лаборатории (по согласованию с заказчиком);
- Поставка специализированных компонентов военного и аэрокосмического уровня качества (Xilinx, Altera, Analog Devices, Intersil, Interpoint, Microsemi, Actel, Aeroflex, Peregrine, VPT, Syfer, Eurofarad, Texas Instruments, MS Kennedy, Miteq, Cobham, E2V, MA-COM, Hittite, Mini-Circuits, General Dynamics и др.);

Компания «Океан Электроники» является официальным дистрибьютором и эксклюзивным представителем в России одного из крупнейших производителей разъемов военного и аэрокосмического назначения «JONHON», а так же официальным дистрибьютором и эксклюзивным представителем в России производителя высокотехнологичных и надежных решений для передачи СВЧ сигналов «FORSTAR».



JONHON

«JONHON» (основан в 1970 г.)

Разъемы специального, военного и аэрокосмического назначения:

(Применяются в военной, авиационной, аэрокосмической, морской, железнодорожной, горно- и нефтедобывающей отраслях промышленности)

«FORSTAR» (основан в 1998 г.)

ВЧ соединители, коаксиальные кабели, кабельные сборки и микроволновые компоненты:

(Применяются в телекоммуникациях гражданского и специального назначения, в средствах связи, РЛС, а так же военной, авиационной и аэрокосмической отраслях промышленности).



Телефон: 8 (812) 309-75-97 (многоканальный)

Факс: 8 (812) 320-03-32

Электронная почта: ocean@oceanchips.ru

Web: <http://oceanchips.ru/>

Адрес: 198099, г. Санкт-Петербург, ул. Калинина, д. 2, корп. 4, лит. А