

# DATA SHEET

## Liquid Level Switches

### Optomax Digital Series



#### FEATURES

- Liquid level switches that can detect almost any liquid type; oil or water based
- Choice of material; Polysulfone (standard) or Trogamid®
- Choice of threads



#### Housing/ Mounting

- M10x1
- M12x1
- 1/4" NPT
- 1/2"-20 UNF

#### Output Type / Logic

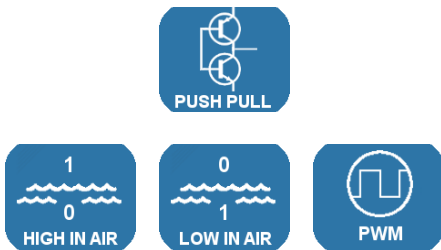

#### Supply Voltage

4.5 - 15.4 V  
VOLTAGE

#### Output Current

UP TO 100mA  
CURRENT

#### Temp

-25°C to +80°C  
TEMPERATURE

-40°C to +125°C  
TEMPERATURE

#### BENEFITS

- Low power
- Low cost
- Compact design

#### OUTPUT VALUES

**Output Voltage<sup>c</sup> (Vout):** **I<sub>out</sub> = 100mA**  
Output High Vout = Vs - 1.5V max  
Output Low Vout = 0V + 0.5V max

**PWM**  
Duty cycle in air 25% ± 10%  
Duty cycle in liquid 75% ± 10%  
Frequency 2kHz ± 10%

Other sensor options available on request, email:  
[technical@sstsensing.com](mailto:technical@sstsensing.com)

#### TECHNICAL SPECIFICATIONS

Supply voltage (Vs)	4.5V <sub>DC</sub> to 15.4V <sub>DC</sub> or 4.5V <sub>DC</sub> to 5.5V <sub>DC</sub> (PWM output)
Supply current (Is)	2.5mA max. (Vs = 15.4V <sub>DC</sub> )
Output sink and source current (Iout)	100mA
Operating temperatures	Standard: -25°C to +80°C Extended: -40°C to +125°C
Storage temperatures	Standard: -30°C to +85°C Extended: -40°C to +125°C
Housing material <sup>a, b</sup>	Polysulfone or Trogamid®
Sensor termination	24AWG, 250mm PTFE wires, 8mm tinned

**Need help? Ask the expert**  
**Tel: + 44 (0)1236 459 020**  
**and ask for "Technical"**



#### NOTES

- Above +85°C, Trogamid is suitable for use in water based liquids. Oil based liquids can cause deformation of the sensing tip and must be tested for compatibility.
- Before use check that the fluid in which you wish to use these devices is compatible either with Polysulfone or Trogamid®.
- Voltages applicable to output value stated.

## OUTLINE DRAWING

All dimensions shown in mm. Tolerances =  $\pm 1$ mm.

**Type 1**

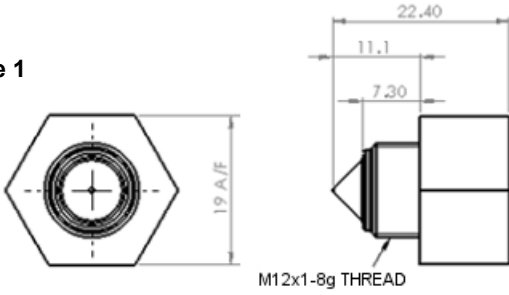

**Type 2**

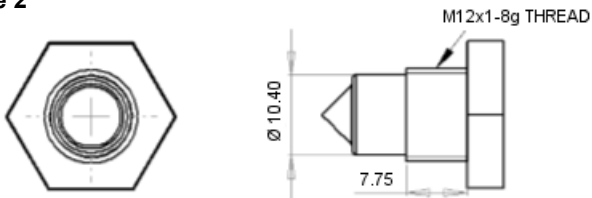

**Type 3**

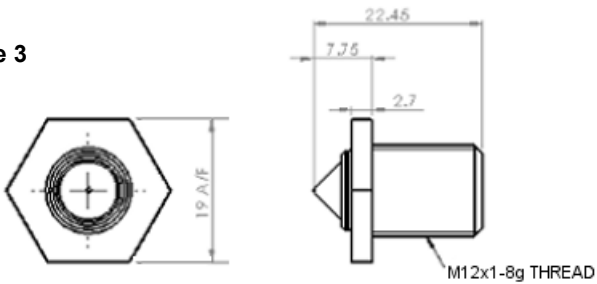

**Type 5**

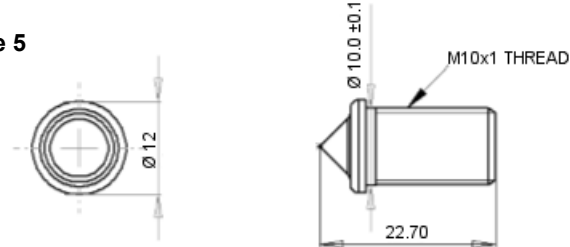

**Type 6**

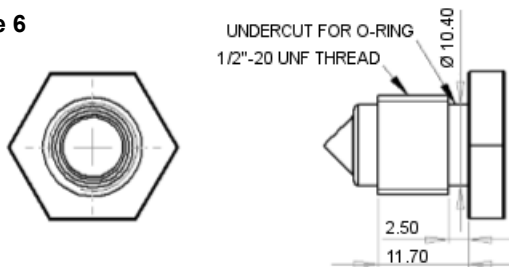

**Type 7**

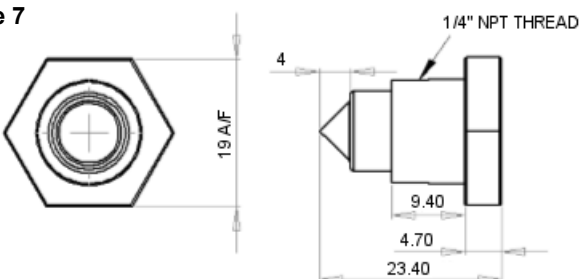

## HOUSING SPECIFICATIONS

	Housing Series		
	Type 1	Type 2	Type 3
Thread	M12x1-8g <sup>d</sup>		
Pressure <sup>g</sup>	7 bar / 101 psi maximum		
Tightening Torque	1.5 Nm / 13.26 in-lbs maximum		

	Housing Series		
	Type 5	Type 6	Type 7
Thread	M10x1	1/2"-20 UNF <sup>e</sup>	1/4" NPT <sup>f</sup>
Pressure <sup>g</sup>	20 bar / 209 psi max.	7 bar / 101 psi maximum	
Tightening Torque	1.5 Nm / 13.26 in-lbs maximum		

## ELECTRICAL INTERFACE

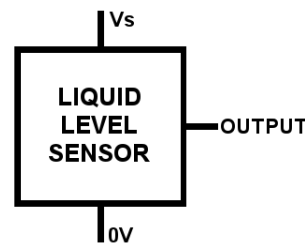

Wire	Designation
Red	Vs
Green	Output
Blue	0V



- d) Types 1, 2 and 3 can be sealed with washers and locknuts.  
 e) Type 6 should be sealed with Parker 3-905 type o-ring.  
 f) Type 7 should be sealed with PTFE tape.  
 g) When correctly sealed.

In order to suit any application, these sensors have been designed with various output circuit configurations.

**Digital Output High in Air**



**Digital Output Low in Air**

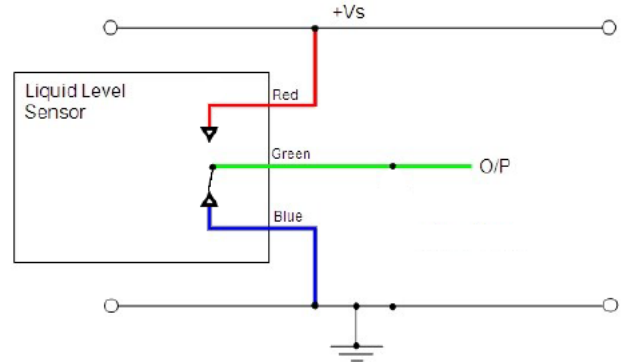

**CAUTION:** Take care when connecting loads.

The minimum load impedance should not exceed  $V_s/\text{max output current}$ .

**Note:** Shorting the output to  $V_s$  or  $0V$  will result in irreparable damage to the sensor.

 **ORDER INFORMATION**

Generate your specific part number using the convention shown opposite. Use only those letters and numbers that correspond to the sensor and output options you require — omit those you do not.

**Sensor mounted from inside vessel**

L L X X X 0 D 3 X

Housing Material	Housing Type	Operating Temp.	Output Logic
<b>C</b> Polysulfone	<b>3</b> Type 3 M12x1-8g	<b>0</b> -25 °C to +80°C	<b>Blank</b> Output High in air
<b>T</b> Trogamid®	<b>5</b> Type 5 M10x1	<b>1</b> -40 °C to +125°C	<b>L</b> Output Low in air
			<b>P</b> PWM output

**Sensor mounted from outside vessel**

L L X X X 0 D 3 X S H

Housing Material	Housing Type	Operating Temp.	Output Logic
<b>C</b> Polysulfone	<b>1</b> Type 1 M12x1-8g	<b>0</b> -25 °C to +80°C	<b>Blank</b> Output High in air
<b>T</b> Trogamid®	<b>2</b> Type 2 M12x1-8g	<b>1</b> -40 °C to +125°C	<b>L</b> Output Low in air
	<b>6</b> Type 6 1/2"-20 UNF		<b>P</b> PWM output
	<b>7</b> Type 7 1/4" NPT		

**Notes:**

- Type 3 and Type 5 sensors are mounted internally.
- Types 1, 2, 6 & 7 sensors are mounted externally.
- SH suffix applicable to Types 1, 2, 6 & 7 sensors only; omit from Type 3 and Type 5 sensor part numbers.

Please contact SST Sensing for details; email: [technical@sstsensing.com](mailto:technical@sstsensing.com)

**! CAUTION**

Do not exceed maximum ratings and ensure sensor(s) are operated in accordance with their requirements.

Carefully follow all wiring instructions. Incorrect wiring can cause permanent damage to the device.

SST Sensing Ltd recommend using alcohol based cleaning agents. Do NOT use chlorinated solvents such as trichloroethane as these are likely to attack the sensor material.

**Failure to comply with these instructions may result in product damage.**

**i INFORMATION**

As customer applications are outside of SST Sensing Ltd.'s control, the information provided is given without legal responsibility. Customers should test under their own conditions to ensure that the equipment is suitable for their intended application. Before use, check that the fluid in which you wish to use these devices is compatible with Polysulfone or Trogamid®.

**For technical assistance or advice, please email:**  
[technical@sstsensing.com](mailto:technical@sstsensing.com)

**General Note:** SST Sensing Ltd. reserves the right to make changes to product specifications without notice or liability. All information is subject to SST Sensing Ltd.'s own data and considered accurate at time of going to print.

Компания «Океан Электроники» предлагает заключение долгосрочных отношений при поставках импортных электронных компонентов на взаимовыгодных условиях!

Наши преимущества:

- Поставка оригинальных импортных электронных компонентов напрямую с производств Америки, Европы и Азии, а так же с крупнейших складов мира;
- Широкая линейка поставок активных и пассивных импортных электронных компонентов (более 30 млн. наименований);
- Поставка сложных, дефицитных, либо снятых с производства позиций;
- Оперативные сроки поставки под заказ (от 5 рабочих дней);
- Экспресс доставка в любую точку России;
- Помощь Конструкторского Отдела и консультации квалифицированных инженеров;
- Техническая поддержка проекта, помощь в подборе аналогов, поставка прототипов;
- Поставка электронных компонентов под контролем ВП;
- Система менеджмента качества сертифицирована по Международному стандарту ISO 9001;
- При необходимости вся продукция военного и аэрокосмического назначения проходит испытания и сертификацию в лаборатории (по согласованию с заказчиком);
- Поставка специализированных компонентов военного и аэрокосмического уровня качества (Xilinx, Altera, Analog Devices, Intersil, Interpoint, Microsemi, Actel, Aeroflex, Peregrine, VPT, Syfer, Eurofarad, Texas Instruments, MS Kennedy, Miteq, Cobham, E2V, MA-COM, Hittite, Mini-Circuits, General Dynamics и др.);

Компания «Океан Электроники» является официальным дистрибьютором и эксклюзивным представителем в России одного из крупнейших производителей разъемов военного и аэрокосмического назначения «JONHON», а так же официальным дистрибьютором и эксклюзивным представителем в России производителя высокотехнологичных и надежных решений для передачи СВЧ сигналов «FORSTAR».



## JONHON

«JONHON» (основан в 1970 г.)

Разъемы специального, военного и аэрокосмического назначения:

(Применяются в военной, авиационной, аэрокосмической, морской, железнодорожной, горно- и нефтедобывающей отраслях промышленности)

«FORSTAR» (основан в 1998 г.)

ВЧ соединители, коаксиальные кабели, кабельные сборки и микроволновые компоненты:

(Применяются в телекоммуникациях гражданского и специального назначения, в средствах связи, РЛС, а так же военной, авиационной и аэрокосмической отраслях промышленности).



Телефон: 8 (812) 309-75-97 (многоканальный)

Факс: 8 (812) 320-03-32

Электронная почта: [ocean@oceanchips.ru](mailto:ocean@oceanchips.ru)

Web: <http://oceanchips.ru/>

Адрес: 198099, г. Санкт-Петербург, ул. Калинина, д. 2, корп. 4, лит. А