

EAO – Your Expert Partner for
Human Machine Interfaces

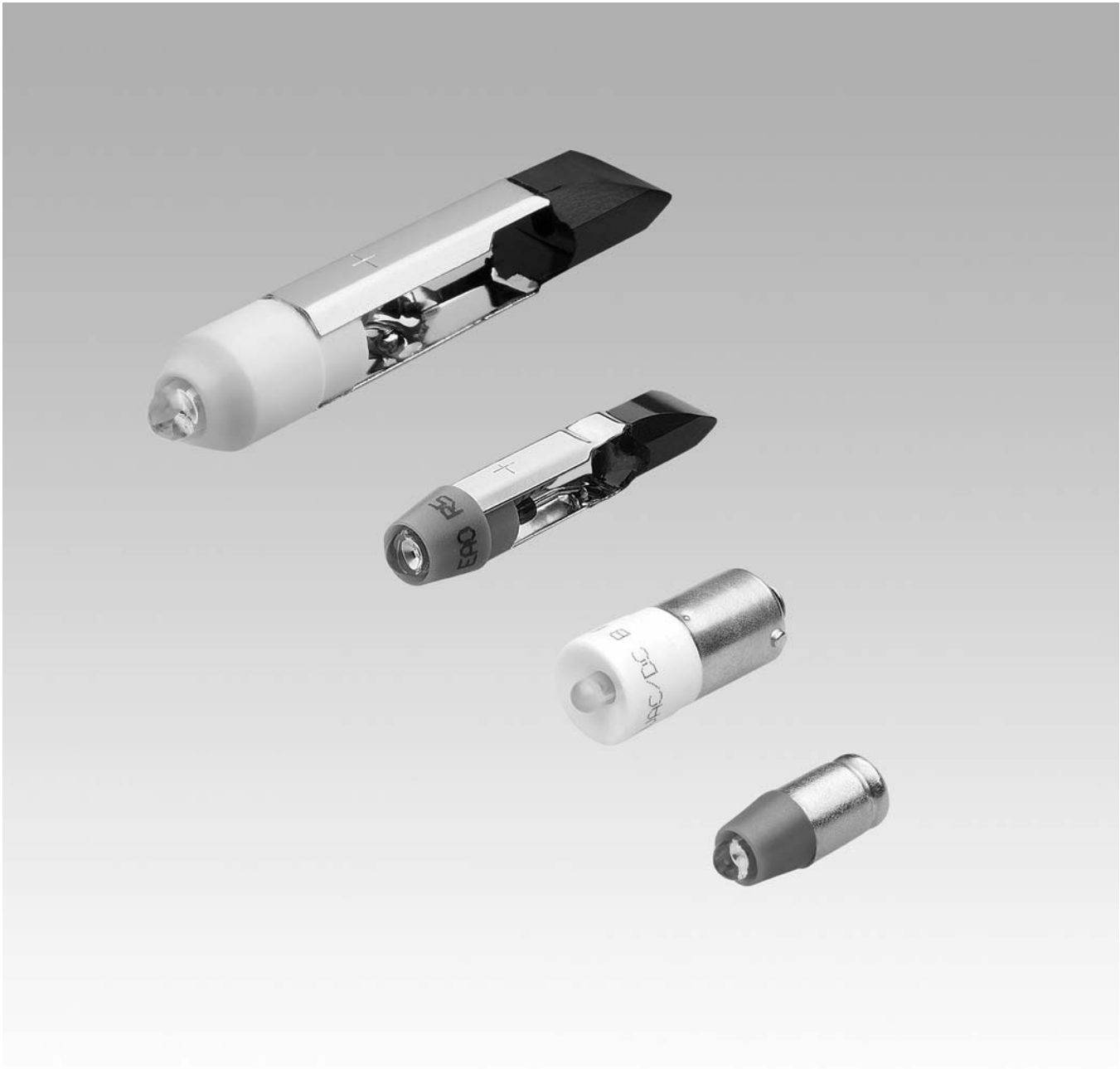

EAO Product Information

Series 10 LED



Description	3
Illumination.....	4
Accessories.....	8
Technical Data.....	9
Drawings.....	10
Index.....	11

Product Information**General notes**

The LEDs have decisive advantages:

1. Optimum of illumination
2. Low power consumption
3. Used on DC voltage and AC voltage
4. Low heat generation
5. Extrem long lifetime
6. Shock and vibration proof

Design

The LEDs are built with an integrated resistor and they are available in three versions:

Without rectifier

Only for use on DC voltage. Please be aware of the polarity!

With half-wave rectifier

These LEDs are built with a protection diode in series with the resistor and the LED. They can be used without any problems on DC voltage and AC voltage. The typical light reduction on AC voltage against DC voltage operation is round 25%.

With bridge rectifier

Can be used without any problems on a DC voltage and AC voltage with the same light output. Bipolarity on DC voltage!

Illumination

Single-Chip LEDs in red, blue, green, yellow and white gives superb illumination and can be supplied in 6 VDC, 12, 24, 28, 48 VAC/DC, 130 VDC, 130 VAC and 230 VAC.

Due to production tolerances, colour temperature variations may be detected within individual consignments.

Lamp remover

for T1 3/4 MG LED

Typ-Nr. 61-9740.0 (series 22, 31, 41, 51, 61, 71)

Typ-Nr. 300-0002-00 (series Swisstac)

for T5.5 LED

Typ-Nr. 02-906 (series 01, 14)

Typ-Nr. 300-0002-00 (series Swisstac)

for T6.8 LED

Typ-Nr. 03-996 (series 02, 03)

for T3 1/4 BA9s LED

Typ-Nr. 700.006.0 (series 04)

Typ-Nr. 44-935 (series 44)

Used in series

T1 3/4 MG: 22, 31, 41, 51, 61, 71, Swisstac

T5.5: 01, 14, Swisstac

T6.8: 02, 03

T3 1/4 BA9s: 04, 44

We reserve the right to modify technical data

All dimensions in mm

Single-LED T1 3/4 (6mm) MG



	Light colour	Operating voltage/-current	Lumi. Intensity	Dom. Wavelength	Version	Typ-Nr.	Component layout	Technical drawing	
Single-LED T1 3/4 (6mm) MG	blue	12 VAC/DC, 7/14 mA	650 mcd	470 nm	HR	10-2J09.1066	1	0.002	
		24 VAC/DC, 7/14 mA	650 mcd	470 nm	HR	10-2J12.1066	1	0.002	
		28 VAC/DC, 7/14 mA	650 mcd	470 nm	HR	10-2J13.1066	1	0.002	
		48 VAC/DC, 4/8 mA	400 mcd	470 nm	HR	10-2J19.1046	1	0.002	
		6 VDC, 15 mA	680 mcd	470 nm	WR	10-2J06.3146	1	0.002	
	green	12 VAC/DC, 4/7 mA	1050 mcd	525 nm	HR	10-2J09.1065	1	0.002	
		24 VAC/DC, 4/7 mA	1050 mcd	525 nm	HR	10-2J12.1065	1	0.002	
		28 VAC/DC, 4/7 mA	1050 mcd	525 nm	HR	10-2J13.1065	1	0.002	
		48 VAC/DC, 2/4 mA	600 mcd	525 nm	HR	10-2J19.1045	1	0.002	
		6 VDC, 7 mA	1050 mcd	525 nm	WR	10-2J06.3145	1	0.002	
	red	12 VAC/DC, 7/14 mA	330 mcd	630 nm	HR	10-2J09.1062	1	0.002	
		24 VAC/DC, 7/14 mA	330 mcd	630 nm	HR	10-2J12.1062	1	0.002	
		28 VAC/DC, 7/14 mA	330 mcd	630 nm	HR	10-2J13.1062	1	0.002	
		48 VAC/DC, 4/8 mA	200 mcd	630 nm	HR	10-2J19.1042	1	0.002	
		6 VDC, 15 mA	350 mcd	630 nm	WR	10-2J06.3142	1	0.002	
	white diffuse	12 VAC/DC, 7/14 mA	700 mcd	x=0.31 / y=0.32	HR	10-2J09.1069	1	1	0.002
		24 VAC/DC, 7/14 mA	700 mcd	x=0.31 / y=0.32	HR	10-2J12.1069	1	1	0.002
		28 VAC/DC, 7/14 mA	700 mcd	x=0.31 / y=0.32 nm	HR	10-2J13.1069	1	1	0.002
		48 VAC/DC, 4/8 mA	400 mcd	x=0.31 / y=0.32	HR	10-2J19.1049	1	1	0.002
		6 VDC, 15 mA	750 mcd	x=0.31 / y=0.32	WR	10-2J06.3149	1	1	0.002
yellow	12 VAC/DC, 7/14 mA	280 mcd	587 nm	HR	10-2J09.1064	1	0.002		
	24 VAC/DC, 7/14 mA	280 mcd	587 nm	HR	10-2J12.1064	1	0.002		
	28 VAC/DC, 7/14 mA	280 mcd	587 nm	HR	10-2J13.1064	1	0.002		
	48 VAC/DC, 4/8 mA	180 mcd	587 nm	HR	10-2J19.1044	1	0.002		
	6 VDC, 15 mA	300 mcd	587 nm	WR	10-2J06.3144	1	0.002		

Electrical and optical data are measured at 25°C.

Luminous intensity data of the LEDs on direct voltage.

The specified versions are built with a protection diode in series and the LED.

A suitable lamp remover Part No. 61-9740.0 (Series Swisstac Part No. 300-0002-00).

Version: HR = With half-wave rectifier, WR = Without rectifier

Component layout from page 10, Technical drawing from page 10

Single-LED T5.5



	Light colour	Operating voltage/-current	Lumi. Intensity	Dom. Wavelength	Version	Typ-Nr.	Component layout	Technical drawing	3D
Single-LED T5.5	blue	12 VAC/DC, 7/14 mA	650 mcd	470 nm	HR	10-2109.1066	2	2	0.001
		24 VAC/DC, 7/14 mA	650 mcd	470 nm	HR	10-2112.1066	2	2	0.001
		28 VAC/DC, 7/14 mA	650 mcd	470 nm	HR	10-2113.1066	2	2	0.001
		48 VAC/DC, 4/8 mA	400 mcd	470 nm	HR	10-2119.1046	2	2	0.001
		6 VDC, 15 mA	680 mcd	470 nm	WR	10-2106.3146	2	2	0.001
	green	12 VAC/DC, 4/7 mA	1050 mcd	525 nm	HR	10-2109.1065	2	2	0.001
		24 VAC/DC, 4/7 mA	1050 mcd	525 nm	HR	10-2112.1065	2	2	0.001
		28 VAC/DC, 4/7 mA	1050 mcd	525 nm	HR	10-2113.1065	2	2	0.001
		48 VAC/DC, 2/4 mA	600 mcd	525 nm	HR	10-2119.1045	2	2	0.001
		6 VDC, 7 mA	1050 mcd	525 nm	WR	10-2106.3145	2	2	0.001
	red	12 VAC/DC, 7/14 mA	330 mcd	630 nm	HR	10-2109.1062	2	2	0.001
		24 VAC/DC, 7/14 mA	330 mcd	630 nm	HR	10-2112.1062	2	2	0.001
		28 VAC/DC, 7/14 mA	330 mcd	630 nm	HR	10-2113.1062	2	2	0.001
		48 VAC/DC, 4/8 mA	200 mcd	630 nm	HR	10-2119.1042	2	2	0.001
		6 VDC, 15 mA	350 mcd	630 nm	WR	10-2106.3142	2	2	0.001
	white diffuse	12 VAC/DC, 7/14 mA	700 mcd	x=0.31 / y=0.32	HR	10-2109.1069	1	2	0.001
		24 VAC/DC, 7/14 mA	700 mcd	x=0.31 / y=0.32	HR	10-2112.1069	1	2	0.001
		28 VAC/DC, 7/14 mA	700 mcd	x=0.31 / y=0.32	HR	10-2113.1069	1	2	0.001
		48 VAC/DC, 4/8 mA	400 mcd	x=0.31 / y=0.32	HR	10-2119.1049	1	2	0.001
		6 VDC, 15 mA	750 mcd	x=0.31 / y=0.32	WR	10-2106.3149	1	2	0.001
	yellow	12 VAC/DC, 7/14 mA	280 mcd	587 nm	HR	10-2109.1064	2	2	0.001
		24 VAC/DC, 7/14 mA	280 mcd	587 nm	HR	10-2112.1064	2	2	0.001
		28 VAC/DC, 7/14 mA	280 mcd	587 nm	HR	10-2113.1064	2	2	0.001
		48 VAC/DC, 4/8 mA	180 mcd	587 nm	HR	10-2119.1044	2	2	0.001
		6 VDC, 15 mA	300 mcd	587 nm	WR	10-2106.3144	2	2	0.001

Electrical and optical data are measured at 25°C.

Luminous intensity data of the LEDs on direct voltage.

The specified versions are built with a protection diode in series and the LED.

A suitable lamp remover Part No. 02-906 (Series Swisstac Part No. 300-0002-00).

Version: HR = With half-wave rectifier, WR = Without rectifier

Component layout from page 10, Technical drawing from page 10

Single-LED T6.8



	Light colour	Operating voltage/-current	Lumi. Intensity	Dom. Wavelength	Version	Typ-Nr.	Component layout	Technical drawing	
Single-LED T6.8	blue	12 VAC/DC, 9/17 mA	780 mcd	470 nm	HR	10-2K09.1076	3	0.002	
		24 VAC/DC, 9/17 mA	780 mcd	470 nm	HR	10-2K12.1076	3	0.002	
		28 VAC/DC, 9/17 mA	780 mcd	470 nm	HR	10-2K13.1076	3	0.002	
		48 VAC/DC, 4/8 mA	400 mcd	470 nm	HR	10-2K19.1056	3	0.002	
		6 VDC, 17 mA	780 mcd	470 nm	WR	10-2K06.3156	3	0.002	
	green	12 VAC/DC, 4/7 mA	1050 mcd	525 nm	HR	10-2K09.1075	3	0.002	
		24 VAC/DC, 4/7 mA	1050 mcd	525 nm	HR	10-2K12.1075	3	0.002	
		28 VAC/DC, 4/7 mA	1050 mcd	525 nm	HR	10-2K13.1075	3	0.002	
		48 VAC/DC, 2/4 mA	600 mcd	525 nm	HR	10-2K19.1055	3	0.002	
		6 VDC, 7 mA	1050 mcd	525 nm	WR	10-2K06.3155	3	0.002	
	red	12 VAC/DC, 9/17 mA	400 mcd	630 nm	HR	10-2K09.1072	3	0.002	
		24 VAC/DC, 9/17 mA	400 mcd	630 nm	HR	10-2K12.1072	3	0.002	
		28 VAC/DC, 9/17 mA	400 mcd	630 nm	HR	10-2K13.1072	3	0.002	
		48 VAC/DC, 4/8 mA	200 mcd	630 nm	HR	10-2K19.1052	3	0.002	
		6 VDC, 17 mA	400 mcd	630 nm	WR	10-2K06.3152	3	0.002	
	white diffuse	12 VAC/DC, 9/17 mA	850 mcd	x=0.31 / y=0.32	HR	10-2K09.1079	1	3	0.002
		24 VAC/DC, 9/17 mA	850 mcd	x=0.31 / y=0.32	HR	10-2K12.1079	1	3	0.002
		28 VAC/DC, 9/17 mA	850 mcd	x=0.31 / y=0.32	HR	10-2K13.1079	1	3	0.002
		48 VAC/DC, 4/8 mA	400 mcd	x=0.31 / y=0.32	HR	10-2K19.1059	1	3	0.002
		6 VDC, 17 mA	850 mcd	x=0.31 / y=0.32	WR	10-2K06.3159	1	3	0.002
yellow	12 VAC/DC, 9/17 mA	340 mcd	340 nm	HR	10-2K09.1074	3	0.002		
	24 VAC/DC, 9/17 mA	340 mcd	340 nm	HR	10-2K12.1074	3	0.002		
	28 VAC/DC, 9/17 mA	340 mcd	340 nm	HR	10-2K13.1074	3	0.002		
	48 VAC/DC, 4/8 mA	180 mcd	340 nm	HR	10-2K19.1054	3	0.002		
	6 VDC, 17 mA	340 mcd	340 nm	WR	10-2K06.3154	3	0.002		

Electrical and optical data are measured at 25°C.

Luminous intensity data of the LEDs on direct voltage.

The specified versions are built with a protection diode in series and the LED.

A suitable lamp remover Part No. 03-996.

Version: HR = With half-wave rectifier, WR = Without rectifier

Component layout from page 10, Technical drawing from page 10

Single-LED T3 1/4 (10x25mm) BA9s



	Light colour	Operating voltage/-current	Lumi. Intensity	Dom. Wavelength	Version	Typ-Nr.	Comp. layout	Techn. drawing	Fig.
Single-LED T3 1/4 (10x25mm) BA9s	blue	12 VAC/DC, 16 mA	720 mcd	470 nm	BR	10-2509.1146	4	0.002	
		130 VAC, 5 mA	230 mcd	470 nm	BR	10-2H24.2056	4	0.002	
		130 VDC, 3 mA	200 mcd	470 nm	BR	10-2524.3046	4	0.002	
		230 VAC, 3 mA	200 mcd	470 nm	BR	10-2H25.2046	4	0.002	
		24 VAC/DC, 15 mA	680 mcd	470 nm	BR	10-2512.1146	4	0.002	
		28 VAC/DC, 13 mA	590 mcd	470 nm	BR	10-2513.1146	4	0.002	
		48 VAC/DC, 8 mA	400 mcd	470 nm	BR	10-2519.1056	4	0.002	
		6 VDC, 17 mA	780 mcd	470 nm	WR	10-2506.1086	4	0.002	
	green	12 VAC/DC, 7 mA	1050 mcd	525 nm	BR	10-2509.1145	4	0.002	
		130 VAC, 3 mA	450 mcd	525 nm	BR	10-2H24.2055	4	0.002	
		130 VDC, 2 mA	300 mcd	525 nm	BR	10-2524.3045	4	0.002	
		230 VAC, 2 mA	300 mcd	525 nm	BR	10-2H25.2045	4	0.002	
		24 VAC/DC, 7 mA	1050 mcd	525 nm	BR	10-2512.1145	4	0.002	
		28 VAC/DC, 7 mA	1050 mcd	525 nm	BR	10-2513.1145	4	0.002	
		48 VAC/DC, 4 mA	600 mcd	525 nm	BR	10-2519.1055	4	0.002	
		6 VDC, 7 mA	1050 mcd	525 nm	WR	10-2506.1085	4	0.002	
	red	12 VAC/DC, 16 mA	390 mcd	630 nm	BR	10-2509.1142	4	0.002	
		130 VAC, 5 mA	180 mcd	630 nm	BR	10-2H24.2052	4	0.002	
		130 VDC, 3 mA	120 mcd	630 nm	BR	10-2524.3042	4	0.002	
		230 VAC, 3 mA	120 mcd	630 nm	BR	10-2H25.2042	4	0.002	
		24 VAC/DC, 15 mA	350 mcd	630 nm	BR	10-2512.1142	4	0.002	
		28 VAC/DC, 13 mA	300 mcd	630 nm	BR	10-2513.1142	4	0.002	
		48 VAC/DC, 8 mA	200 mcd	630 nm	BR	10-2519.1052	4	0.002	
		6 VDC, 17 mA	400 mcd	630 nm	WR	10-2506.1082	4	0.002	
	white diffuse	12 VAC/DC, 16 mA	800 mcd	x=0.31 / y=0.32	BR	10-2509.1149	1	4	0.002
		130 VAC, 5 mA	250 mcd	x=0.31 / y=0.32	BR	10-2H24.2059	1	4	0.002
		130 VDC, 3 mA	150 mcd	x=0.31 / y=0.32	BR	10-2524.3049	1	4	0.002
		230 VAC, 3 mA	150 mcd	x=0.31 / y=0.32	BR	10-2H25.2049	1	4	0.002
24 VAC/DC, 15 mA		750 mcd	x=0.31 / y=0.32	BR	10-2512.1149	1	4	0.002	
28 VAC/DC, 13 mA		650 mcd	x=0.31 / y=0.32	BR	10-2513.1149	1	4	0.002	
48 VAC/DC, 8 mA		400 mcd	x=0.31 / y=0.32	BR	10-2519.1059	1	4	0.002	
6 VDC, 17 mA		850 mcd	x=0.31 / y=0.32	WR	10-2506.1089	1	4	0.002	
yellow	12 VAC/DC, 16 mA	340 mcd	587 nm	BR	10-2509.1144	4	0.002		
	130 VAC, 5 mA	160 mcd	587 nm	BR	10-2H24.2054	4	0.002		
	130 VDC, 3 mA	110 mcd	587 nm	BR	10-2524.3044	4	0.002		
	230 VAC, 3 mA	110 mcd	587 nm	BR	10-2H25.2044	4	0.002		
	24 VAC/DC, 15 mA	300 mcd	587 nm	BR	10-2512.1144	4	0.002		
	28 VAC/DC, 13 mA	270 mcd	587 nm	BR	10-2513.1144	4	0.002		
	48 VAC/DC, 8 mA	180 mcd	587 nm	BR	10-2519.1054	4	0.002		
	6 VDC, 17 mA	340 mcd	587 nm	WR	10-2506.1084	4	0.002		

Electrical and optical data are measured at 25°C.

Luminous intensity data of the LEDs on direct voltage.

The specified 6 VDC, 130 VAC, 130 DC und 230 VAC versions are built with a protection diode.

The specified 12, 24, 28, 48 VAC/DC versions are built with a bridge rectifier.

The specified 130 VAC types are developed to run on a supply voltage of 130 VAC only. An operation at a higher supply voltage using commercial lampholders with integrated resistors, is not approved.

A suitable lamp remover Part No. 700.006.0 (Series 44 Part No. 44-935).

Version: BR = With bridge rectifier, WR = Without rectifier

Component layout from page 10, Technical drawing from page 10

Illumination

Lamp remover for T1 3/4 MG LED

	For series	Typ-Nr.	 kg
Lamp remover for T1 3/4 MG LED	22, 31, 41, 51, 61, 71	61-9740.0	0.003
	Swisstac	300-0002-00	0.003



CAUTION

A switching process might be released when replacing the LED!

Lamp remover for T5.5 LED

	For series	Typ-Nr.	 kg
Lamp remover for T5.5 LED	01, 14	02-906	0.002



CAUTION

A switching process might be released when replacing the LED!

Lamp remover for T6.8 LED

	For series	Typ-Nr.	 kg
Lamp remover for T6.8 LED	02, 03	03-996	0.027



CAUTION

A switching process might be released when replacing the LED!

Lamp remover for T3 1/4 BA9s LED

	For series	Typ-Nr.	 kg
Lamp remover for T3 1/4 BA9s LED	04	700.006.0	0.003
	44	44-935	0.037



CAUTION

A switching process might be released when replacing the LED!

Technical Data

Electrical characteristics

Voltage tolerance
+10 %

Mechanical characteristics

Standards

Lamp base

Base	Standard
T1 3/4 MG	DIN EN 60061-1: S5,7s
T5.5	DIN 49601
T6.8	DIN 49601
BA9s	DIN EN 60061-1: BA9s

Environmental conditions

Storage temperature
-25 °C ... +80 °C

Service temperature
-20 °C ... +60 °C

Component layout

1 Single-LED T1 3/4 (6mm) MG page 4 | Single-LED T5.5 page 5 | Single-LED T6.8 page 6 | Single-LED T3 1/4 (10x25mm) BA9s page 7

Typical luminous spectrum
for white LED

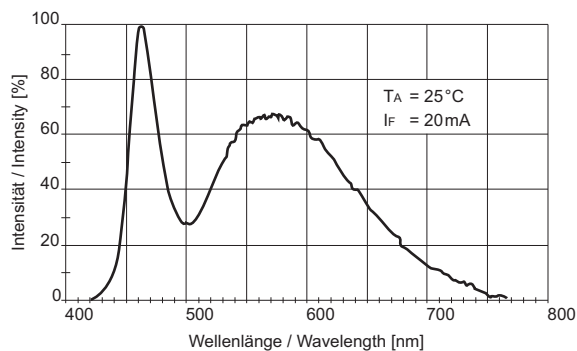

Colour coordinates $I_F = 20\text{mA}$; $T_A = 25^\circ\text{C}$
 $x = 0.31 \pm 0.06$ $y = 0.32 \pm 0.08$

Technical drawing

1 Single-LED T1 3/4 (6mm) MG page 4

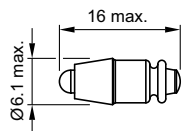

2 Single-LED T5.5 page 5

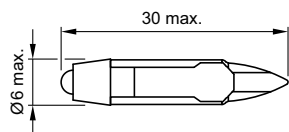

3 Single-LED T6.8 page 6

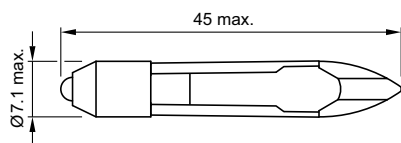

4 Single-LED T3 1/4 (10x25mm) BA9s page 7

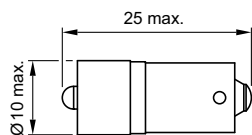

Index from Typ-Nr.

Typ-Nr.	Page	Typ-Nr.	Page	Typ-Nr.	Page
02-906	8	10-2H25.2044	7		
03-996	8	10-2H25.2045	7		
10-2106.3142	5	10-2H25.2046	7		
10-2106.3144	5	10-2H25.2049	7		
10-2106.3145	5	10-2J06.3142	4		
10-2106.3146	5	10-2J06.3144	4		
10-2106.3149	5	10-2J06.3145	4		
10-2109.1062	5	10-2J06.3146	4		
10-2109.1064	5	10-2J06.3149	4		
10-2109.1065	5	10-2J09.1062	4		
10-2109.1066	5	10-2J09.1064	4		
10-2109.1069	5	10-2J09.1065	4		
10-2112.1062	5	10-2J09.1066	4		
10-2112.1064	5	10-2J09.1069	4		
10-2112.1065	5	10-2J12.1062	4		
10-2112.1066	5	10-2J12.1064	4		
10-2112.1069	5	10-2J12.1065	4		
10-2113.1062	5	10-2J12.1066	4		
10-2113.1064	5	10-2J12.1069	4		
10-2113.1065	5	10-2J13.1062	4		
10-2113.1066	5	10-2J13.1064	4		
10-2113.1069	5	10-2J13.1065	4		
10-2119.1042	5	10-2J13.1066	4		
10-2119.1044	5	10-2J13.1069	4		
10-2119.1045	5	10-2J19.1042	4		
10-2119.1046	5	10-2J19.1044	4		
10-2119.1049	5	10-2J19.1045	4		
10-2506.1082	7	10-2J19.1046	4		
10-2506.1084	7	10-2J19.1049	4		
10-2506.1085	7	10-2K06.3152	6		
10-2506.1086	7	10-2K06.3154	6		
10-2506.1089	7	10-2K06.3155	6		
10-2509.1142	7	10-2K06.3156	6		
10-2509.1144	7	10-2K06.3159	6		
10-2509.1145	7	10-2K09.1072	6		
10-2509.1146	7	10-2K09.1074	6		
10-2509.1149	7	10-2K09.1075	6		
10-2512.1142	7	10-2K09.1076	6		
10-2512.1144	7	10-2K09.1079	6		
10-2512.1145	7	10-2K12.1072	6		
10-2512.1146	7	10-2K12.1074	6		
10-2512.1149	7	10-2K12.1075	6		
10-2513.1142	7	10-2K12.1076	6		
10-2513.1144	7	10-2K12.1079	6		
10-2513.1145	7	10-2K13.1072	6		
10-2513.1146	7	10-2K13.1074	6		
10-2513.1149	7	10-2K13.1075	6		
10-2519.1052	7	10-2K13.1076	6		
10-2519.1054	7	10-2K13.1079	6		
10-2519.1055	7	10-2K19.1052	6		
10-2519.1056	7	10-2K19.1054	6		
10-2519.1059	7	10-2K19.1055	6		
10-2524.3042	7	10-2K19.1056	6		
10-2524.3044	7	10-2K19.1059	6		
10-2524.3045	7	300-0002-00	8		
10-2524.3046	7	44-935	8		
10-2524.3049	7	61-9740.0	8		
10-2H24.2052	7	700.006.0	8		
10-2H24.2054	7				
10-2H24.2055	7				
10-2H24.2056	7				
10-2H24.2059	7				
10-2H25.2042	7				

	EAO AG
	Tannwaldstrasse 88 4601 Olten, Switzerland
E-mail	info@eao.com
Website	www.eao.com
	Austria
Phone	+49 201 85 87 0
Fax	+49 201 85 87 210
E-mail	sales.ede@eao.com
	Belgium
Phone	+32 3 777 82 36
Fax	+32 3 777 84 19
E-mail	sales.ebl@eao.com
	China
Phone	+852 27 86 91 41
Fax	+852 27 86 95 61
E-mail	sales.ehk@eao.com
	France
Phone	+33 1 64 43 37 37
Fax	+33 1 64 43 37 49
E-mail	sales.esa@eao.com
	Germany
Phone	+49 201 85 87 0
Fax	+49 201 85 87 210
E-mail	sales.ede@eao.com
	Italy
Phone	+39 035 481 0189
Fax	+39 035 481 3786
E-mail	sales.eit@eao.com
	Japan
Phone	+81 3 5444 5411
Fax	+81 3 5444 0345
E-mail	sales.esj@eao.com
	Netherlands
Phone	+31 78 653 17 00
Fax	+31 78 653 17 99
E-mail	sales.enl@eao.com
	Sweden
Phone	+46 8 683 86 60
Fax	+46 8 724 29 12
E-mail	sales.esw@eao.com
	Switzerland
Phone	+41 62 388 95 00
Fax	+41 62 388 95 55
E-mail	sales.ech@eao.com
	United Kingdom
Phone	+44 1444 236 000
Fax	+44 1444 236 641
E-mail	sales.euk@eao.com
	USA
Phone	+1 203 877 4577
Fax	+1 203 877 3694
E-mail	sales.eus@eao.com
	Other Countries
Phone	+41 62 286 92 10
Fax	+41 62 296 21 62
E-mail	info@eao.com

Компания «Океан Электроники» предлагает заключение долгосрочных отношений при поставках импортных электронных компонентов на взаимовыгодных условиях!

Наши преимущества:

- Поставка оригинальных импортных электронных компонентов напрямую с производств Америки, Европы и Азии, а так же с крупнейших складов мира;
- Широкая линейка поставок активных и пассивных импортных электронных компонентов (более 30 млн. наименований);
- Поставка сложных, дефицитных, либо снятых с производства позиций;
- Оперативные сроки поставки под заказ (от 5 рабочих дней);
- Экспресс доставка в любую точку России;
- Помощь Конструкторского Отдела и консультации квалифицированных инженеров;
- Техническая поддержка проекта, помощь в подборе аналогов, поставка прототипов;
- Поставка электронных компонентов под контролем ВП;
- Система менеджмента качества сертифицирована по Международному стандарту ISO 9001;
- При необходимости вся продукция военного и аэрокосмического назначения проходит испытания и сертификацию в лаборатории (по согласованию с заказчиком);
- Поставка специализированных компонентов военного и аэрокосмического уровня качества (Xilinx, Altera, Analog Devices, Intersil, Interpoint, Microsemi, Actel, Aeroflex, Peregrine, VPT, Syfer, Eurofarad, Texas Instruments, MS Kennedy, Miteq, Cobham, E2V, MA-COM, Hittite, Mini-Circuits, General Dynamics и др.);

Компания «Океан Электроники» является официальным дистрибьютором и эксклюзивным представителем в России одного из крупнейших производителей разъемов военного и аэрокосмического назначения «JONHON», а так же официальным дистрибьютором и эксклюзивным представителем в России производителя высокотехнологичных и надежных решений для передачи СВЧ сигналов «FORSTAR».



JONHON

«JONHON» (основан в 1970 г.)

Разъемы специального, военного и аэрокосмического назначения:

(Применяются в военной, авиационной, аэрокосмической, морской, железнодорожной, горно- и нефтедобывающей отраслях промышленности)

«FORSTAR» (основан в 1998 г.)

ВЧ соединители, коаксиальные кабели, кабельные сборки и микроволновые компоненты:

(Применяются в телекоммуникациях гражданского и специального назначения, в средствах связи, РЛС, а так же военной, авиационной и аэрокосмической отраслях промышленности).



Телефон: 8 (812) 309-75-97 (многоканальный)

Факс: 8 (812) 320-03-32

Электронная почта: ocean@oceanchips.ru

Web: <http://oceanchips.ru/>

Адрес: 198099, г. Санкт-Петербург, ул. Калинина, д. 2, корп. 4, лит. А