

A DIN 72 x 72 mm Best-selling Counter

- Easy setting with thumbwheel switches.
- A draw-out construction enables maintenance without rewiring.
- Models with 2-, 4-, 6-, or 8-digit displays are also available.
- Total Counter models are also Available.
- Complies with UL and CSA Marking.



Refer to *Safety Precautions for All Counters and Safety Precautions* on page 17.

This product was upgraded in January 2006. Refer to *Changes in Specifications* on page 18 for details.



Ordering Information

Each model is sold together with a mounting bracket.

Preset Counter

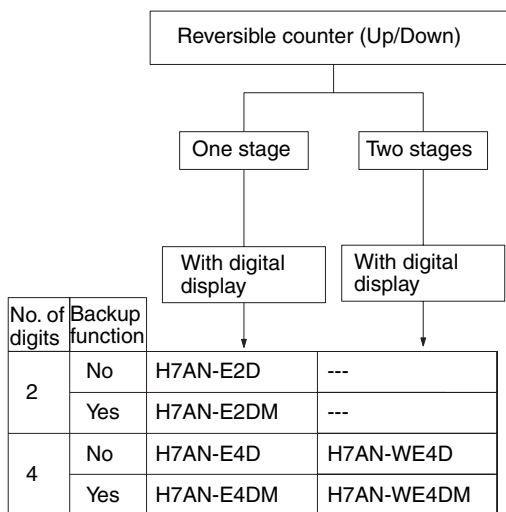
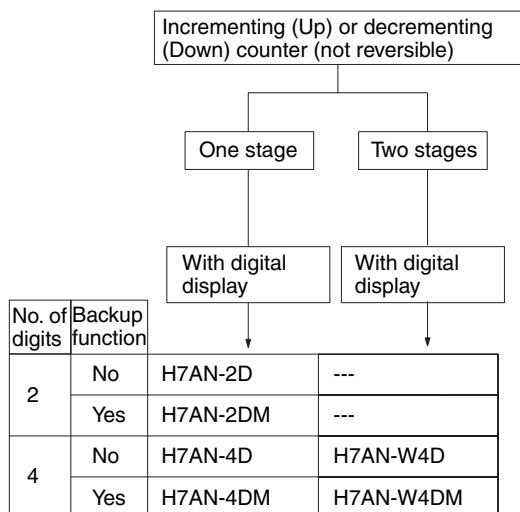

Totalizing Counter



Note: Specify the power supply voltage when ordering.

Specifications

Preset Counters

Incrementing/Decrementing Counters

Operating method			Incrementing and decrementing (selectable with DIP switch)		
Mounting method			Flush mounting		
Operation modes			N, F, C, R, K, P, Q (selectable with rotary DIP switch)		
Input signal method (Count and reset inputs)			Contact and solid-state input voltage (H and L)		
Control output			1-stage counters: Contact (SPDT) and solid-state output (H and L output switchable) 2-stage counters: Contact (SPST-NO) and solid-state output (H and L output switchable)		
Set value read			Continuous mode		
Memory backup			No	Yes/No (Selectable using DIP switch)	
Display			Yes (10-mm high 7-segment LED, Up indicator)		Yes (10-mm high 7-segment LED, Up indicator)
Models	2 digits	1 stage	H7AN-2D	H7AN-2DM	
	4 digits	1 stage	H7AN-4D	H7AN-4DM	
		2 stages	H7AN-W4D	H7AN-W4DM	

Reversible Counters

Operating method			Reversible (selectable with rotary DIP switch) between 0 and the set value Incrementing/decrementing A/D (command inputs) Incrementing/decrementing B/E (individual inputs) Incrementing/decrementing C/F (phase difference inputs)		
Mounting method			Flush mounting		
Operation modes			N, F, C, R, K, P, Q (selectable with rotary DIP switch)		
Input signal method (Count, reset input)			Contact and solid-state input voltage (H and L)		
Control output			1-stage counters: Contact (SPDT) and solid-state output (H and L output switchable) 2-stage counters: Contact (SPST-NO) and solid-state output (H and L output switchable)		
Set value read			Continuous mode		
Memory backup			No	Yes/No (Selectable using DIP switch)	
Display			Yes (10-mm high 7-segment LED)		
Models	2 digits	1 stage	H7AN-E2D	H7AN-E2DM	
	4 digits	1 stage	H7AN-E4D	H7AN-E4DM	
		2 stages	H7AN-WE4D	H7AN-WE4DM	

Incrementing, Decrementing, and Reversible Counters

Operating method			Incrementing, decrementing, and reversible (UP/DOWN A to F) (selectable with rotary DIP switch)		
Mounting method			Flush mounting		
Operation modes			N, F, C, R, K, P, Q (selectable with rotary DIP switch)		
Input signal method (Count, reset input)			Contact and solid-state input voltage (H and L)		
Control output			1-stage counters: Contact (SPDT) and solid-state output (H and L output switchable) 2-stage counters: Contact (SPST-NO) and solid-state output (H and L output switchable)		
Set value read			Continuous mode, Reset mode (selectable)		
Memory backup			No	Yes/No (Selectable using DIP switch)	
Display			Yes (8-mm high 7-segment LED, Up indicator)		
Models	6 digits	1 stage	H7AN-R6D	H7AN-R6DM	
		2 stage	H7AN-RW6D	H7AN-RW6DM	
	8 digits	1 stages	H7AN-R8D	H7AN-R8DM	

Totalizing Counters

Incrementing/Decrementing Counters

Operating method		Incrementing and decrementing (selectable with DIP switch)	
Mounting method		Flush mounting	
Input signal method (Count, reset input)		Contact and solid-state input voltage (H and L)	
Memory backup		No	Yes/No (Selectable using DIP switch)
Display		Yes (10-mm high 7-segment LED)	
Models	4 digits	H7AN-T4	H7AN-T4M

Reversible Counters

Operating method		Reversible (selectable with rotary DIP switch) between 0 and the full scale Incrementing/decrementing A/D (command inputs) Incrementing/decrementing B/E (individual inputs) Incrementing/decrementing C/F (phase difference inputs)	
Mounting method		Flush mounting	
Input signal method (Count, reset input)		Contact and solid-state input voltage (H and L)	
Memory backup		No	Yes/No (Selectable using DIP switch)
Display		Yes (10-mm high 7-segment LED)	
Models	4 digits	H7AN-ET4	H7AN-ET4M

Incrementing, Decrementing, and Reversible Counters

Operating method		Incrementing, decrementing, and reversible (UP/DOWN A to F)	
Mounting method		Flush mounting	
Input signal method (Count, reset input)		Contact and solid-state input voltage (H and L)	
Memory backup		No	Yes/No (Selectable using DIP switch)
Display		Yes (8-mm high 7-segment LED)	
Models	6 digits	H7AN-RT6	H7AN-RT6M
	8 digits	H7AN-RT8	H7AN-RT8M

■ Ratings

Rated supply voltage	100 to 240 VAC, 50/60 Hz (common use); 12 to 24, 48, 100 VDC*
Operating voltage range	85% to 110% of rated voltage
Power consumption	Approx. 10 VA (240 VAC at 50 Hz); Approx. 5 W (at 24 VDC)**
Max. counting speed of CP1 and CP2	2-digit counters: 30 Hz 4-digit counters: 30 Hz or 5 kHz 6- or 8-digit counters: 30 Hz or 5 kHz Minimum signal width (with ON/OFF ratio of 1:1): 30 Hz: 16.7 ms, 5 kHz: 0.1 ms H: 4.5 to 30 VDC, L: 0 to 2 VDC
Reset	Power supply reset (except for H7AN Counter with suffix "-M"): Minimum power-OFF time: 0.5 s with a reset time of 0.05 s after power-ON. External, manual, reset signal time: 0.02 s Reset time after completion of reset signal: 0.05 s Automatic reset***
Control output	Contacts: 3 A at 250 VAC, resistive load ($\cos\phi = 1$) No-contacts: 100 mA max. at 30 VDC max., open collector
Min. applicable load	10 mA at 5 VDC (p level reference value)
External power supply	80 mA, 12 VDC $\pm 10\%$ (contains 5% ripple max.)
Ambient temperature	Operating: -10°C to 55°C (with no icing) Storage: -25°C to 65°C (with no icing)
Ambient humidity	35% to 85%
Case	Light gray (Munsell 5Y7/1)

*The ripple is 20% max.

**There is an inrush current of 14 A at 240 VAC for approximately 0.6 ms, 15 A at 12 to 24 VDC for 2 ms, 5 A at 48 VDC for 3 ms, or 8 A at 100 VDC for 2 ms immediately after power-ON.

***Only preset counters can be automatically reset.

■ Characteristics

Insulation resistance	100 MW min. (at 500 VDC) (between current-carrying terminal and exposed non-current-carrying metal parts, and between non-continuous contacts)
Dielectric strength	2,000 VAC, 50/60 Hz for 1 min (between current-carrying terminal and exposed non-current carrying metal parts) 750 VAC, 50/60 Hz for 1 min (between non-continuous contacts)
Impulse withstand voltage	6 kV (between power terminals), 6 kV (between current-carrying terminal and exposed non-current-carrying metal parts)
Noise immunity	±2 kV (between power terminals) and ±500 V (between input terminals), square-wave noise by noise simulator
Vibration resistance	Destruction: 10 to 55 Hz, 0.75-mm double amplitude Malfunction: 10 to 55 Hz, 0.5-mm double amplitude
Shock resistance	Destruction: 300 m/s ² Malfunction: 100 m/s ²
Life expectancy	Mechanical: 10,000,000 operations min. Electrical: 100,000 operations min. (3 A at 250 VAC, resistive load)
Approved standards	UL508, CSA C22.2 No.14
Weight	Approx. 360 g

Engineering Data

Life of Contacts

**Electric Life Expectancy
(Resistive load)**

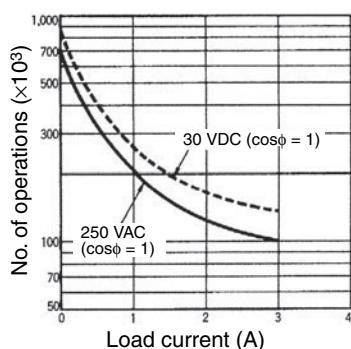

**Electric Life Expectancy
(Inductive load)**

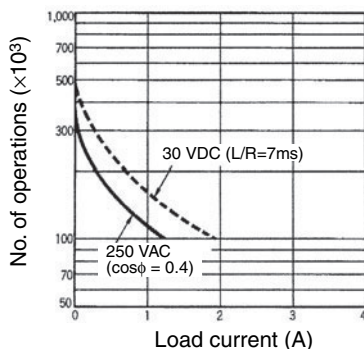

Reference: 0.15 A max. can be switched 100,000 times at 125 VDC (cosφ = 1).
0.1 A max. can be switched 100,000 times when L/R = 7 ms.

Operation

Count Operation

Preset Counters

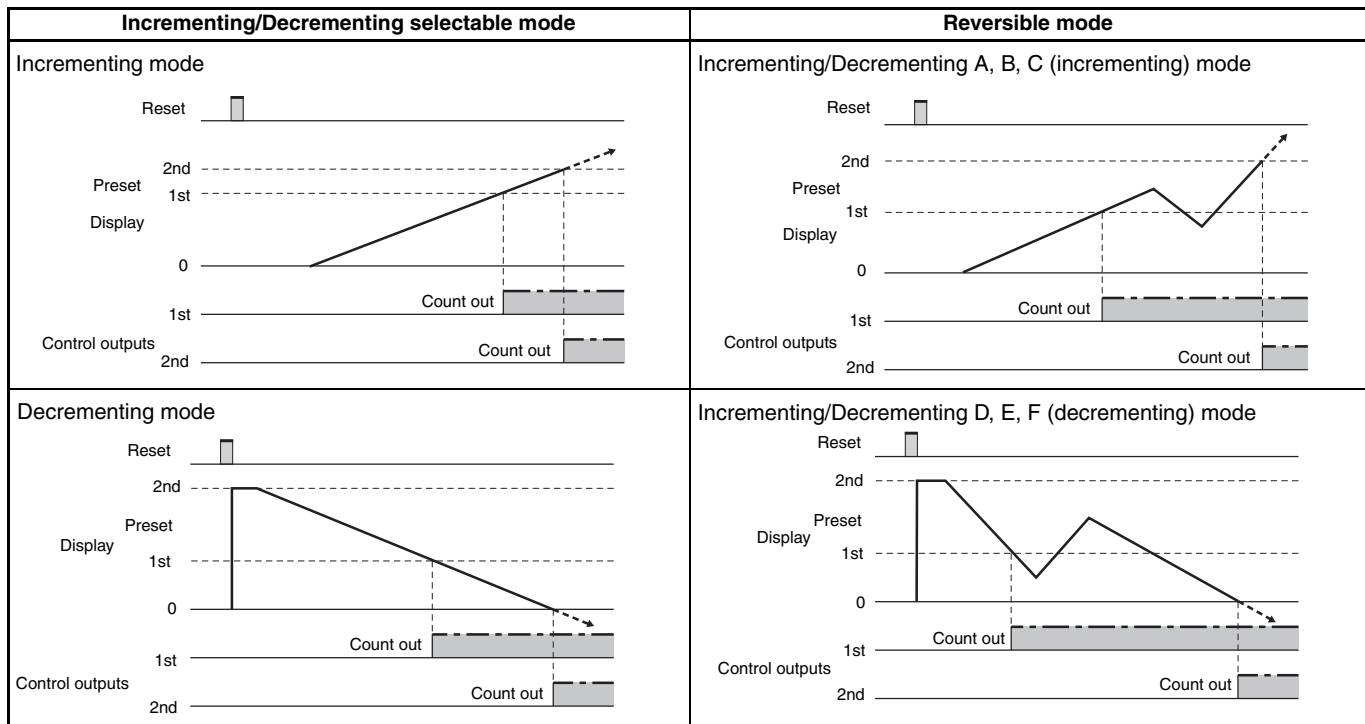

Note: Two-stage counters, set the counters so that the interval between 1st and 2nd count out will be more than 5 ms. For Incrementing/Decrementing switchable counters, only the 2nd value will be effective if the 1st value is larger than the 2nd value. The Incrementing/Decrementing Counters give outputs in the following order; 1st to 2nd to 1st to 2nd.

Totalizing Counters

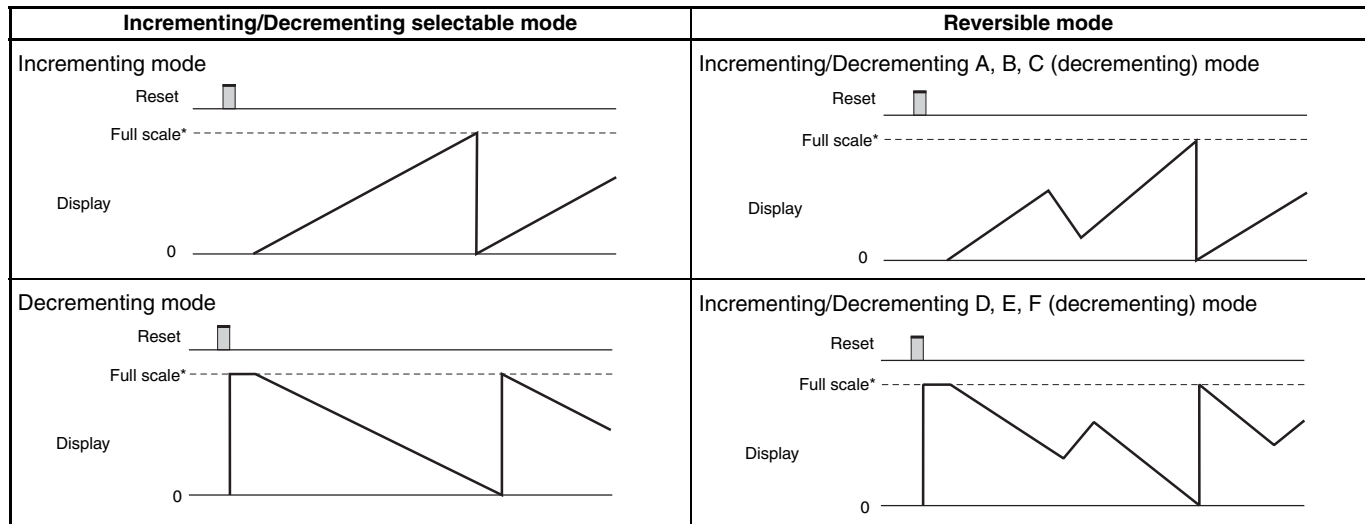

Note: The count value will return to "0" when it reaches the full scale limit.

* The full scale value is 9999 for the 4-digit counters, 999999 for the 6-digit counters, and 99999999 for the 8-digit counters.

*Output Timing Charts

1-stage Counters

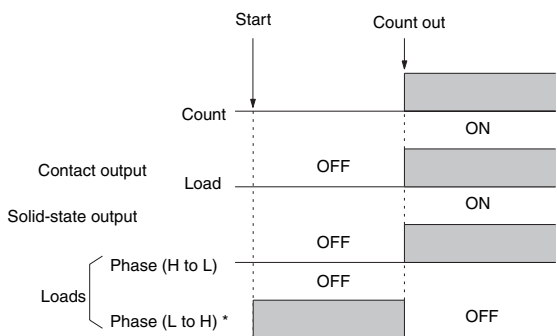

* The operation of the load when the phase has been reversed.

2-stage Counters



* The operation of the load when the phase has been reversed.

Output Delays

Control output	Max. counting speed	Output delay	
		2-, 4-digit counters	6-, 8-digit counters
Contact output	30 Hz	14.0 to 16.0 ms	14.0 to 18.0 ms
	5 kHz	6.0 to 8.0 ms	6.0 to 8.0 ms
Solid-state output	30 Hz	8.0 to 10.0 ms	9.5 to 12.0 ms
	5 kHz	0.4 to 0.6 ms	0.3 to 0.5 ms

Input Mode Setting

Incrementing/Decrementing Selectable Mode

Note: The width of (A) must be the same as or larger than the minimum signal width, because an error of ± 1 count may occur if the width of (A) is smaller than the minimum signal width.

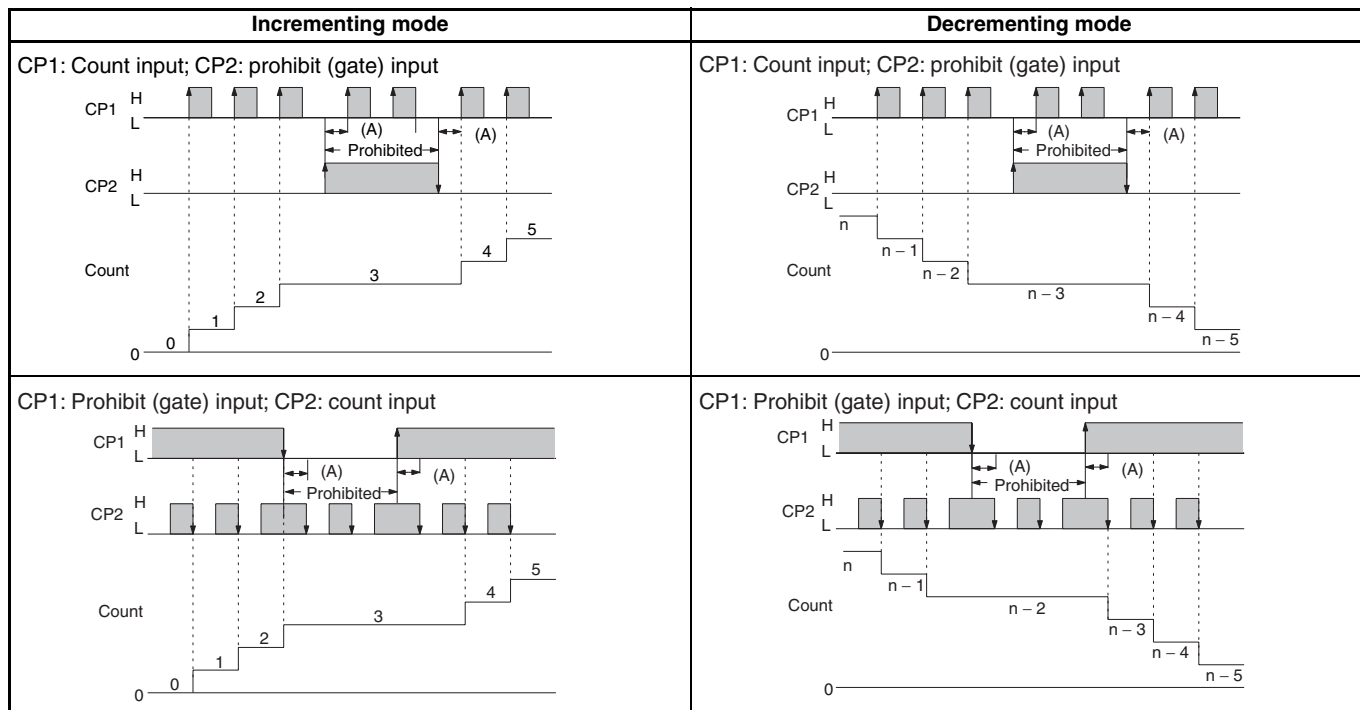

Reversible Mode

- Note: 1.** A: Minimum signal width; B: Must be at least 1/2 of minimum signal width. An error of ±1 count may occur if the width of (A) and (B) are smaller than the minimum signal width.
- 2.** Set the same counting speed for CP1 and CP2 when in Up/Down C, or F mode.

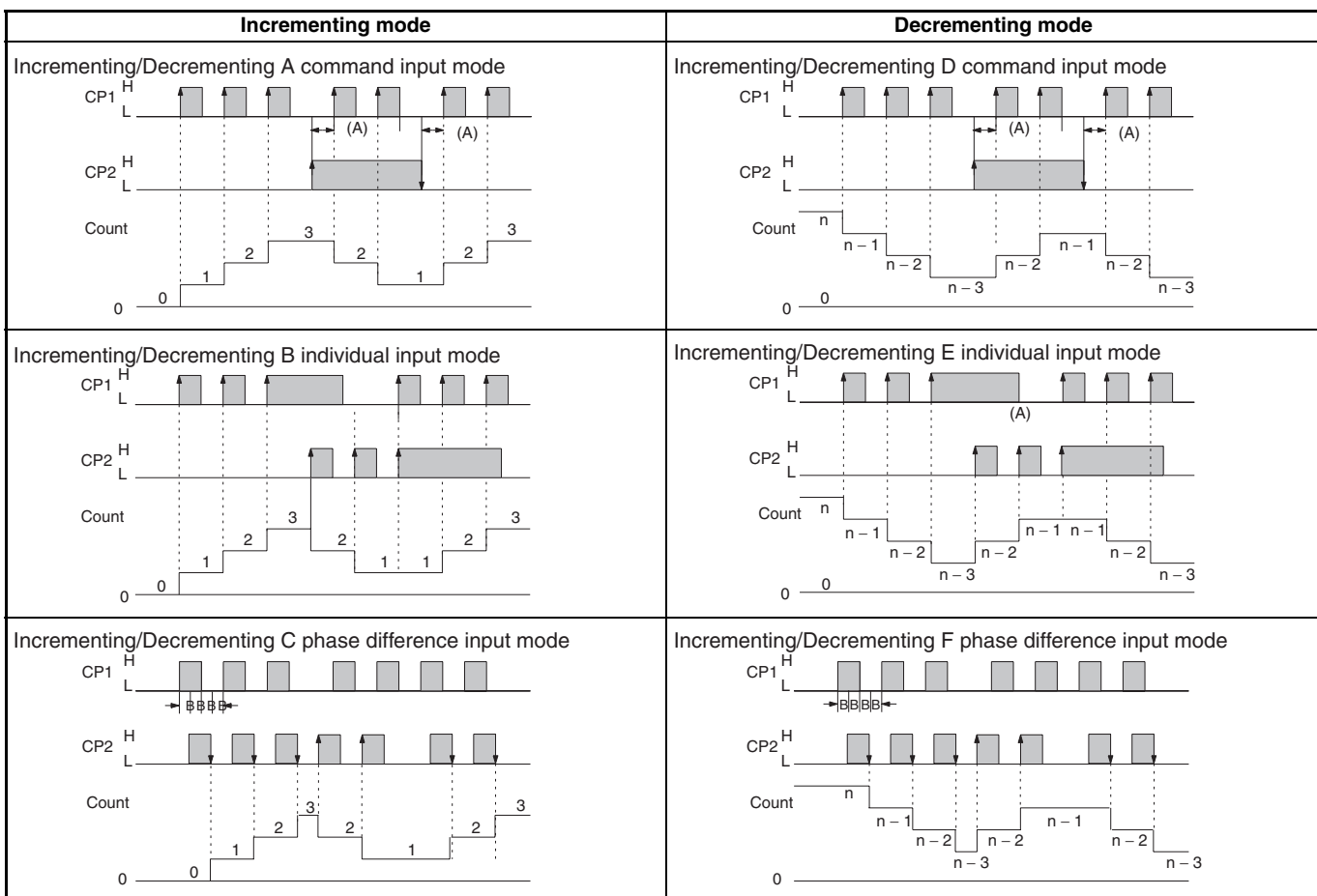

Output Modes

Incrementing, decrementing, or reversible

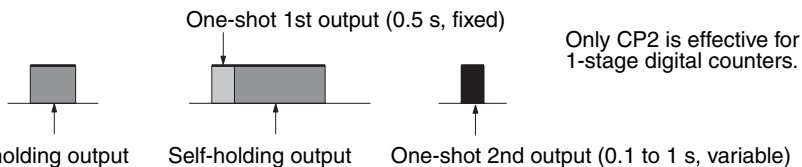

- Note: 1.** In the C, K, P, and Q modes, the counters must not count out again while the one-shot timer is working.
- 2.** In the C mode, the present value is placed in reset start status as soon as the preset count is reached and the count-out status is not displayed.

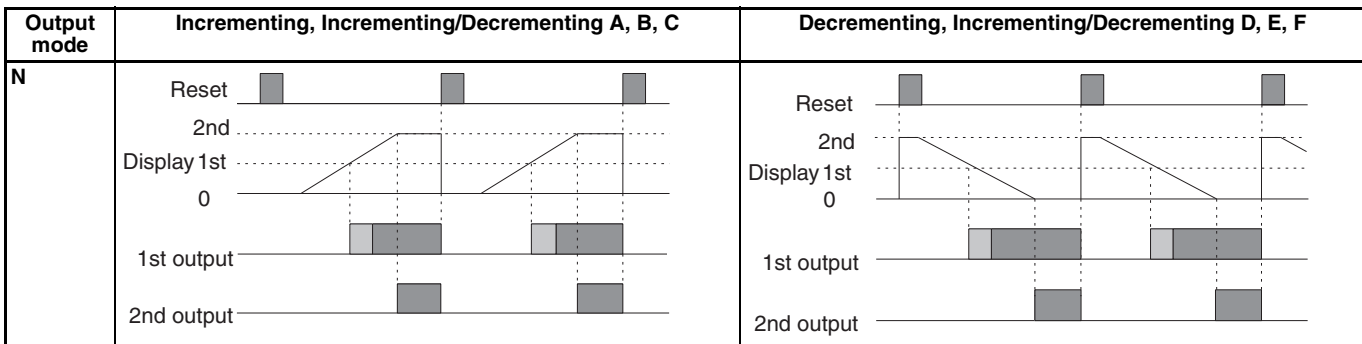

Output mode	Incrementing, Incrementing/Decrementing A, B, C	Decrementing, Incrementing/Decrementing D, E, F
F		
C		
R		
K		
P		
Q		

Nomenclature

■ Nomenclature

Preset Counter

H7AN-2D, -2DM
H7AN-E2D, -E2DM



H7AN-4D, -4DM
H7AN-E4D, -E4DM



Arrangement and Functions of Specification Selection Switches

H7AN-2D (Counting speed: 30 Hz only)

SW2: (A) Operating mode selector
SW4-1: Output phase selector for transistor output section
 ↑ L→H (at count-out) (See note.)
 ↓ H→L (at count-out) (See note.)
 SW4-2: Manual reset selector
 ↑ Manual reset possible (See note.)
 ↓ Manual reset not possible
 SW4-3: UP/DOWN selector
 ↑ Up counting (incrementing) (See note.)
 ↓ Down counting (decrementing)

H7AN-E2D (Counting speed: 30 Hz only)

SW1: (A) Counting function selector
SW2: (A) Operating mode selector
SW4-1: Output phase selector for transistor output section
 ↑ L→H (at count-out) (See note.)
 ↓ H→L (at count-out) (See note.)
 SW4-2: Manual reset selector
 ↑ Manual reset possible (See note.)
 ↓ Manual reset not possible

Arrangement and Functions of Specification Selection Switches

H7AN-4D

SW2: (A) Operating mode selector
SW3-1: CP1 maximum counting speed selector
 ↑ 30 Hz (See note.)
 ↓ 5 kHz
 SW3-2: CP2 maximum counting speed selector
 ↑ 30 Hz (See note.)
 ↓ 5 kHz
 SW4-1: Output phase selector for transistor output section
 ↑ L→H (at count-out) (See note.)
 ↓ H→L (at count-out) (See note.)
 SW4-2: Manual reset selector
 ↑ Manual reset possible (See note.)
 ↓ Manual reset not possible
 SW4-3: UP/DOWN selector
 ↑ Up counting (incrementing) (See note.)
 ↓ Down counting (decrementing)

H7AN-E4D

SW1: (A) Counting function selector
SW2: (A) Operating mode selector
SW3-1: CP1 maximum counting speed selector
 ↑ 30 Hz (See note.)
 ↓ 5 kHz
 SW3-2: CP2 maximum counting speed selector
 ↑ 30 Hz (See note.)
 ↓ 5 kHz
 SW4-1: Output phase selector for transistor output section
 ↑ L→H (at count-out) (See note.)
 ↓ H→L (at count-out) (See note.)
 SW4-2: Manual reset selector
 ↑ Manual reset possible (See note.)
 ↓ Manual reset not possible

H7AN-2DM (Counting speed: 30 Hz only)

SW2: (A) Operating mode selector
SW3: Power failure memory backup
 ↑ Memory backup (See note.)
 ↓ No memory backup
 SW4-1: Output phase selector for transistor output section
 ↑ L→H (at count-out) (See note.)
 ↓ H→L (at count-out) (See note.)
 SW4-2: Manual reset selector
 ↑ Manual reset possible (See note.)
 ↓ Manual reset not possible
 SW4-3: UP/DOWN selector
 ↑ Up counting (incrementing) (See note.)
 ↓ Down counting (decrementing)

H7AN-E2DM (Counting speed: 30 Hz only)

SW1: (A) Counting function selector
SW2: (A) Operating mode selector
SW3: Power failure memory backup
 ↑ Memory backup (See note.)
 ↓ No memory backup
 SW4-1: Output phase selector for transistor output section
 ↑ L→H (at count-out) (See note.)
 ↓ H→L (at count-out) (See note.)
 SW4-2: Manual reset selector
 ↑ Manual reset possible (See note.)
 ↓ Manual reset not possible

H7AN-4DM

SW2: (A) Operating mode selector
SW3-1: CP1 maximum counting speed selector
 ↑ 30 Hz (See note.)
 ↓ 5 kHz
 SW3-2: CP2 maximum counting speed selector
 ↑ 30 Hz (See note.)
 ↓ 5 kHz
 SW3-3: SW3-3: Power failure memory backup
 ↑ Memory backup (See note.)
 ↓ No memory backup
 SW4-1: Output phase selector for transistor output section
 ↑ L→H (at count-out) (See note.)
 ↓ H→L (at count-out) (See note.)
 SW4-2: Manual reset selector
 ↑ Manual reset possible (See note.)
 ↓ Manual reset not possible
 SW4-3: UP/DOWN selector
 ↑ Up counting (incrementing) (See note.)
 ↓ Down counting (decrementing)

H7AN-E4DM

SW1: (A) Counting function selector
SW2: (A) Operating mode selector
SW3-1: CP1 maximum counting speed selector
 ↑ 30 Hz (See note.)
 ↓ 5 kHz
 SW3-2: CP2 maximum counting speed selector
 ↑ 30 Hz (See note.)
 ↓ 5 kHz
 SW3-3: Power failure memory backup
 ↑ Memory backup (See note.)
 ↓ No memory backup
 SW4-1: Output phase selector for transistor output section
 ↑ L→H (at count-out) (See note.)
 ↓ H→L (at count-out) (See note.)
 SW4-2: Manual reset selector
 ↑ Manual reset possible (See note.)
 ↓ Manual reset not possible

Note: These settings are the defaults for the specification selection switches.

H7AN-W4D, -W4DM H7AN-WE4D, -WE4DM

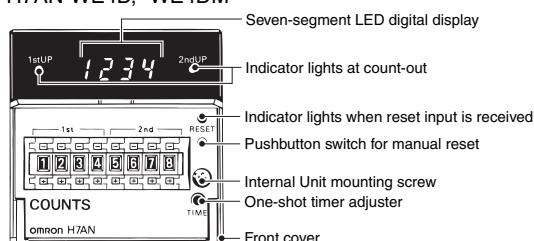

H7AN-R6D, -R6DM H7AN-R8D, -R8DM

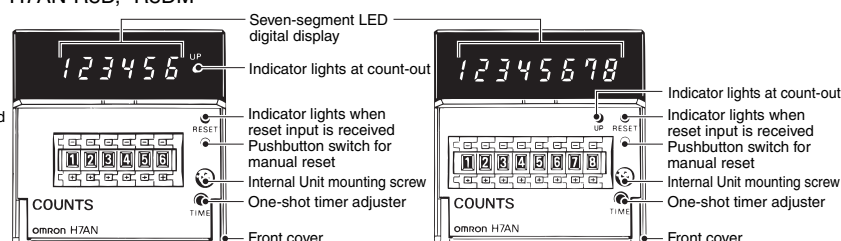

Arrangement and Functions of Specification Selection Switches

H7AN-W4D

SW2: (B) Operating mode selector
 SW3-1: CP1 maximum counting speed selector
 ↑ 30 Hz (See note.)
 ↓ 5 kHz
 SW3-2: CP2 maximum counting speed selector
 ↑ 30 Hz (See note.)
 ↓ 5 kHz
 SW4-1: Output phase selector for first transistor output section
 ↑ L→H (at count-out)
 ↓ H→L (at count-out) (See note.)
 SW4-2: Output phase selector for second transistor output section
 ↑ L→H (at count-out)
 ↓ H→L (at count-out) (See note.)
 SW4-3: Manual reset selector
 ↑ Manual reset possible
 ↓ Manual reset not possible (See note.)
 SW4-4: UP/DOWN selector
 ↑ Up counting (incrementing)
 ↓ Down counting (decrementing)

H7AN-WE4D

SW1: (A) Counting function selector
 SW2: (B) Operating mode selector
 SW3-1: CP1 maximum counting speed selector
 ↑ 30 Hz (See note.)
 ↓ 5 kHz
 SW3-2: CP2 maximum counting speed selector
 ↑ 30 Hz (See note.)
 ↓ 5 kHz
 SW4-1: Output phase selector for first transistor output section
 ↑ L→H (at count-out)
 ↓ H→L (at count-out) (See note.)
 SW4-2: Output phase selector for second transistor output section
 ↑ L→H (at count-out)
 ↓ H→L (at count-out) (See note.)
 SW4-3: Manual reset selector
 ↑ Manual reset possible
 ↓ Manual reset not possible (See note.)

Arrangement and Functions of Specification Selection Switches

H7AN-R6D, -R8D

SW1: (B) Counting function selector
 SW2: (A) Operating mode selector
 SW3-1: CP1 maximum counting speed selector
 ↑ 30 Hz (See note.)
 ↓ 5 kHz
 SW3-2: CP2 maximum counting speed selector
 ↑ 30 Hz (See note.)
 ↓ 5 kHz
 SW4-1: Output phase selector for transistor output section
 ↑ L→H (at count-out)
 ↓ H→L (at count-out) (See note.)
 SW4-2: Set value read selector
 ↑ Always read (See note.)
 ↓ Read only at reset
 SW4-3: Manual reset selector
 ↑ Manual reset possible
 ↓ Manual reset not possible (See note.)

H7AN-W4DM

SW2: (B) Operating mode selector
 SW3-1: CP1 maximum counting speed selector
 ↑ 30 Hz (See note.)
 ↓ 5 kHz
 SW3-2: CP2 maximum counting speed selector
 ↑ 30 Hz (See note.)
 ↓ 5 kHz
 SW3-3: Power failure memory backup
 ↑ Memory backup (See note.)
 ↓ No memory backup
 SW4-1: Output phase selector for first transistor output section
 ↑ L→H (at count-out)
 ↓ H→L (at count-out) (See note.)
 SW4-2: Output phase selector for second transistor output section
 ↑ L→H (at count-out)
 ↓ H→L (at count-out) (See note.)
 SW4-3: Manual reset selector
 ↑ Manual reset possible
 ↓ Manual reset not possible (See note.)
 SW4-4: UP/DOWN selector
 ↑ Up counting (incrementing)
 ↓ Down counting (decrementing)

H7AN-WE4DM

SW1: (A) Counting function selector
 SW2: (B) Operating mode selector
 SW3-1: CP1 maximum counting speed selector
 ↑ 30 Hz (See note.)
 ↓ 5 kHz
 SW3-2: CP2 maximum counting speed selector
 ↑ 30 Hz (See note.)
 ↓ 5 kHz
 SW3-3: Power failure memory backup
 ↑ Memory backup
 ↓ No memory backup (See note.)
 SW4-1: Output phase selector for first transistor output section
 ↑ L→H (at count-out)
 ↓ H→L (at count-out) (See note.)
 SW4-2: Output phase selector for second transistor output section
 ↑ L→H (at count-out)
 ↓ H→L (at count-out) (See note.)
 SW4-3: Manual reset selector
 ↑ Manual reset possible
 ↓ Manual reset not possible (See note.)

H7AN-R6DM, -R8DM

SW1: (B) Counting function selector
 SW2: (A) Operating mode selector
 SW3-1: CP1 maximum counting speed selector
 ↑ 30 Hz (See note.)
 ↓ 5 kHz
 SW3-2: CP2 maximum counting speed selector
 ↑ 30 Hz (See note.)
 ↓ 5 kHz
 SW3-3: Power failure memory backup
 ↑ Memory backup
 ↓ No memory backup (See note.)
 SW4-1: Output phase selector for transistor output section
 ↑ L→H (at count-out)
 ↓ H→L (at count-out) (See note.)
 SW4-2: Set value read selector
 ↑ Always read (See note.)
 ↓ Read only at reset
 SW4-3: Manual reset selector
 ↑ Manual reset possible
 ↓ Manual reset not possible (See note.)

Note: These settings are the defaults for the specification selection switches.

Totalizing Counter

H7AN-RW6D, -RW6DM

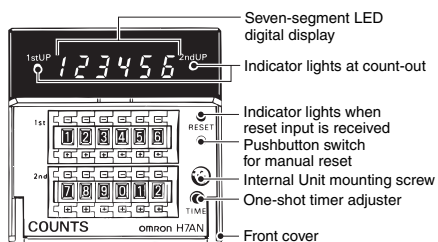

H7AN-T4, -T4M, -ET4, -ET4M
H7AN-RT6, -RT6M, -RT8, -RT8M



Arrangement and Functions of Specification Selection Switches

H7AN-RW6D

SW1: (B) Counting function selector
SW2: (B) Operating mode selector
SW3-1: CP1 maximum counting speed selector
 30 Hz (See note 1.)
 5 kHz
SW3-2: SW3-2: CP2 maximum counting speed selector
 30 Hz (See note 1.)
 5 kHz
SW4-1: Output phase selector for first transistor output section
 L→H (at count-out)
 H→L (at count-out) (See note 1.)
SW4-2: Output phase selector for second transistor output section
 L→H (at count-out)
 H→L (at count-out) (See note 1.)
SW4-3: Set value read selector
 Always read (See note 1.)
 Read only at reset
SW4-4: Manual reset selector
 Manual reset possible (See note 1.)
 Manual reset not possible

H7AN-RW6DM

SW1: (B) Counting function selector
SW2: (B) Operating mode selector
SW3-1: CP1 maximum counting speed selector
 30 Hz (See note 1.)
 5 kHz
SW3-2: CP2 maximum counting speed selector
 30 Hz (See note 1.)
 5 kHz
SW3-3: Power failure memory backup
 Memory backup (See note 1.)
 No memory backup
SW4-1: Manual reset selector
 Manual reset possible (See note 1.)
 Manual reset not possible
SW4-2: UP/DOWN selector
 Up counting (incrementing) (See note 1.)
 Down counting (decrementing)

Arrangement and Functions of Specification Selection Switches

H7AN-T4

SW3-1: CP1 maximum counting speed selector
 30 Hz (See note 1.)
 5 kHz
SW3-2: CP2 maximum counting speed selector
 30 Hz (See note 1.)
 5 kHz
SW4-1: Manual reset selector
 Manual reset possible (See note 1.)
 Manual reset not possible
SW4-2: UP/DOWN selector
 Up counting (incrementing) (See note 1.)
 Down counting (decrementing)

H7AN-T4M

SW3-1: CP1 maximum counting speed selector
 30 Hz (See note 1.)
 5 kHz
SW3-2: CP2 maximum counting speed selector
 30 Hz (See note 1.)
 5 kHz
SW3-3: Power failure memory backup
 Memory backup (See note 1.)
 No memory backup
SW4-1: Manual reset selector
 Manual reset possible (See note 1.)
 Manual reset not possible
SW4-2: UP/DOWN selector
 Up counting (incrementing) (See note 1.)
 Down counting (decrementing)

H7AN-ET4

SW1: (A) Counting function selector
SW3-1: CP1 maximum counting speed selector
 30 Hz (See note 1.)
 5 kHz
SW3-2: CP2 maximum counting speed selector
 30 Hz (See note 1.)
 5 kHz
SW4: Manual reset selector
 Manual reset possible (See note 1.)
 Manual reset not possible

H7AN-ET4M

SW1: (A) Counting function selector
SW3-1: CP1 maximum counting speed selector
 30 Hz (See note 1.)
 5 kHz
SW3-2: CP2 maximum counting speed selector
 30 Hz (See note 1.)
 5 kHz
SW3-3: Power failure memory backup
 Memory backup (See note 1.)
 No memory backup
SW4: Manual reset selector
 Manual reset possible (See note 1.)
 Manual reset not possible

H7AN-RT6, -RT8

SW1: (B) Counting function selector
SW3-1: CP1 maximum counting speed selector
 30 Hz (See note 1.)
 5 kHz
SW3-2: CP2 maximum counting speed selector
 30 Hz (See note 1.)
 5 kHz
SW4: Manual reset selector
 Manual reset possible (See note 1.)
 Manual reset not possible

H7AN-RT6M, -RT8M

SW1: (B) Counting function selector
SW3-1: CP1 maximum counting speed selector
 30 Hz (See note 1.)
 5 kHz
SW3-2: CP2 maximum counting speed selector
 30 Hz (See note 1.)
 5 kHz
SW3-3: Power failure memory backup
 Memory backup (See note 1.)
 No memory backup
SW4: Manual reset selector
 Manual reset possible (See note 1.)
 Manual reset not possible

Note: 1. These settings are the defaults for the specification selection switches.

2. Specifications selected using the internal specification selection switches become after switching once a reset has been performed (e.g., power supply reset, external reset, or manual reset, but not automatic reset). If a reset is not performed, operation will continue with the specifications before switching.

SW1 (A) Counting function selector

Switch position	Function
0, 1, 8, 9 (See note.)	Up/Down A (command inputs)
2	Up/Down B (individual inputs)
3	Up/Down C (differential phase inputs)
4, 5	Up/Down D (command inputs)
6	Up/Down E (individual inputs)
7	Up/Down F (differential phase inputs)

Note: These settings are the defaults.

SW1 (B) Counting function selector

Switch position	Function
0, 1	Up/Down A (command inputs)
2	Up/Down B (individual inputs)
3	Up/Down C (differential phase inputs)
4, 5	Up/Down D (command inputs)
6	Up/Down E (individual inputs)
7	Up/Down F (differential phase inputs)
8	DOWN
9 (See note.)	UP

Note: These settings are the defaults.

SW2 (A) Operating mode selector (1-stage preset models)

Switch position	Function
0, 7, 8, F (See note.)	N (count stop, output hold)
1, 9	F (overcount, output hold)
2, A	C (automatic reset, one-shot output)
3, B	R (automatic reset, one-shot output 1)
4, C	K (overcount reset, one-shot output)
5, D	P (automatic reset, one-shot output 2)
6, E	Q (automatic reset, one-shot output 3)

Note: These settings are the defaults.

SW2 (B) Operating mode selector (2-stage preset models)

Switch position	Second-stage function	
0, 7 (See note.)	First-stage output hold	N (count stop, output hold)
		F (overcount, output hold)
		C (automatic reset, one-shot output)
		R (automatic reset, one-shot output 1)
		K (overcount reset, one-shot output)
		P (automatic reset, one-shot output 2)
		Q (automatic reset, one-shot output 3)
8, F 9 A B C D E	First-stage one-shot output	N (count stop, output hold)
		F (overcount, output hold)
		C (automatic reset, one-shot output)
		R (automatic reset, one-shot output 1)
		K (overcount reset, one-shot output)
		P (automatic reset, one-shot output 2)
		Q (automatic reset, one-shot output 3)

Note: These settings are the defaults.

Dimensions

Note: All units are in millimeters unless otherwise indicated.

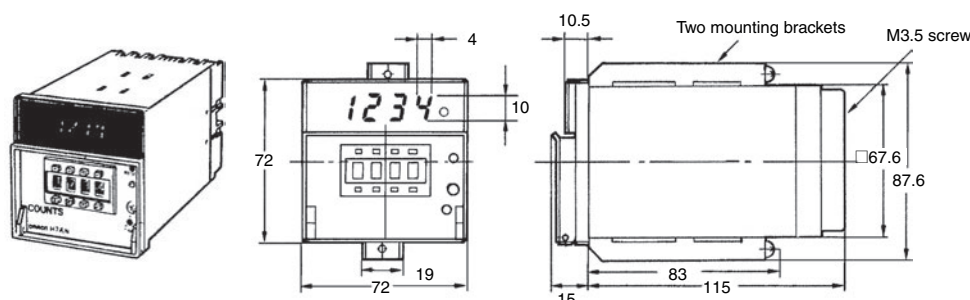

- Note:**
1. The panel cutouts for the H7AN are as shown (according to DIN437000).
 2. The recommended mounting panel thickness is from 1 to 5 mm.
 3. Use the mounting bracket (sold together) to mount the digital counter.

Panel Cutouts

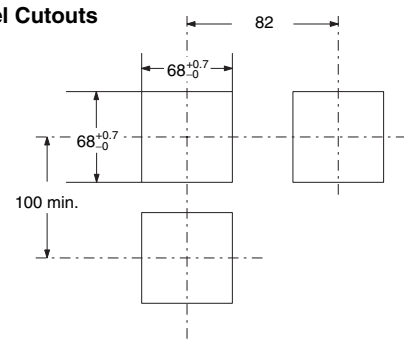

(When N units are flush-mounted horizontally.)



$(n-1) \times 72 + 70$ min.
(including a tolerance of 2 mm)

Mounting

Mounting brackets are included with the H7AN. Use these brackets to mount the H7AN securely so that there is no play.



Turn the screws on the mounting brackets counterclockwise to loosen them sufficiently. Attach the bottom mounting bracket first.

After attaching the mounting brackets, turn the screws clockwise to tighten them sufficiently. When the screws are completely tightened, you will hear the threads disengage.

Installation

Terminal Arrangement

1-stage Preset Counters



2-stage Preset Counters



Total Counters



- Note:**
1. The polarities of the DC power supply terminals are as follows:
Terminal 1: negative; terminal 2: positive
 2. If there is excessive external noise, terminal 3 must be grounded to an appropriate place where the grounding resistance is 100 Ω max. There will be a current leakage of 0.2 mA each from terminals 1 and 2 to terminal 3.
 3. The open terminals cannot be used as relay terminals.
 4. Insert surge absorbers between each of the power supply terminals and the ground terminal. If the ground terminal is not used, insert the surge absorbers between terminal 1 and terminal 2.

Connections

Solid-state Inputs (NPN Transistors)

The CP1, CP2, and reset inputs of the H7AN must be voltage inputs.

Solid-state Contact Input Signal Levels

- High level: 4.5 V min.
 $4.7 \text{ k}\Omega \times E / (4.7 \text{ k}\Omega + R_1 \text{ or } R_2)$ must satisfy the above level. E: 30 VDC max.
 (12 VDC if power is supplied from the external power supply.)
- Low level: 2 V max.



Contact Inputs

For contact inputs, the contact must have a switching capacity of 2.5 mA min. at 12 V. If a 680-W resistor (1/2 W) is used for R4, reliability will be improved.

Input Conditions of the H7AN

- H: 5 to 30 V
- L: 0 to 2 V

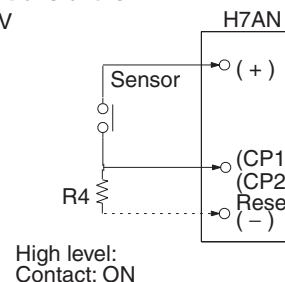

Connections of Single Solid-state Inputs

The following illustrations show how to connect a single solid-state input to digital counters connected in parallel. The H7AN has an input resistance of 4.7 kΩ. If the number of counters is N, the total input resistance will be 4.7/N kΩ. In this case, the high level input signal voltage can be calculated as follows:

$$(4.7/N) \times E / (4.7/N + R)$$

Determine the value of E (V) and R (kΩ) so that the high level input signal voltage will be 5 to 30 VDC.

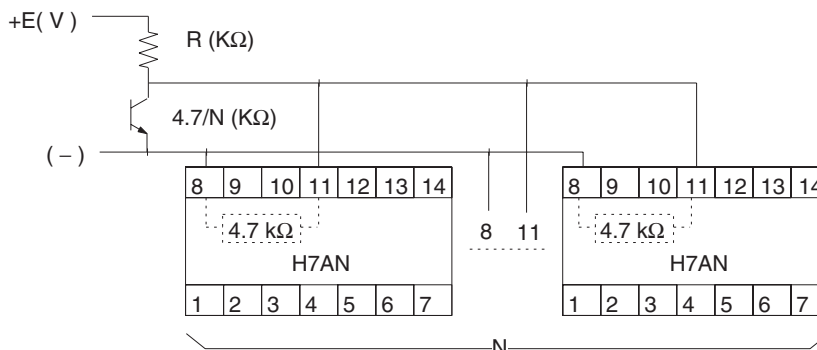

Connections of Single Contact Inputs

The following illustrations show how to connect a single contact input to digital counters connected in parallel. If the number of digital counters is N, the total contact input current will be 2.5 x N (mA) at 12 VDC.

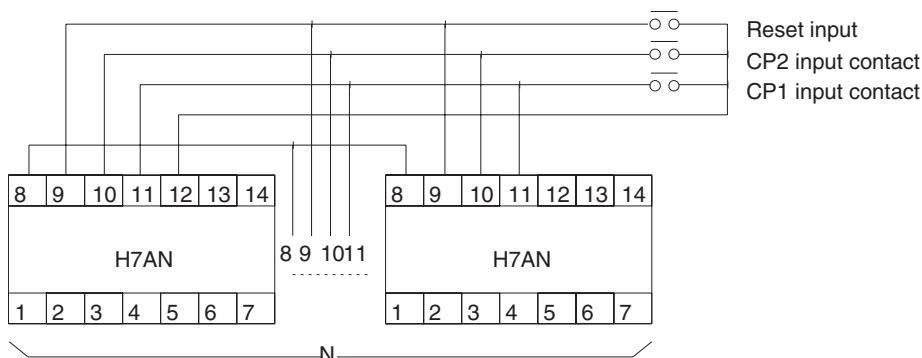

Solid-state Outputs (One-stage Counters)

Load Operation when Transistor is ON

External power supply for Load



Load Operation when Transistor is OFF

The output voltage (V_{out}) is calculated as follows:

$$V_{out} = \frac{12 R_L}{1.5 (k\Omega) + R_L} (V)$$

Connected to the input terminals of other equipment

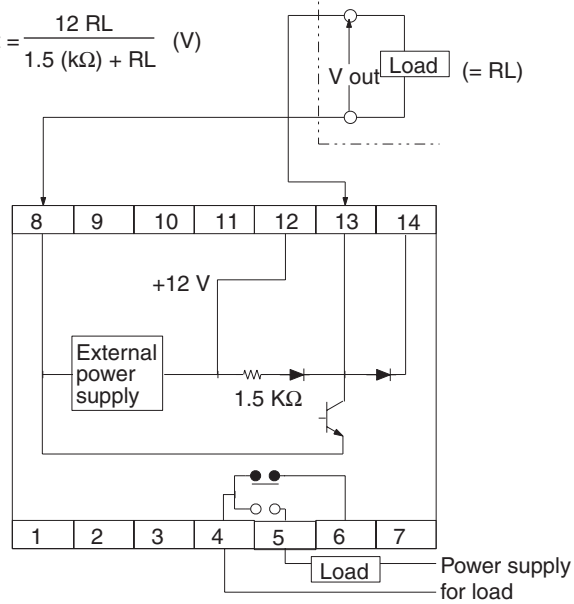

External power supply for load



*This diode is necessary if the supply voltage is below 12 V.

- Note:**
1. The total current consumption of the sensor and load must not exceed the capacity of the external power supply (80 mA).
 2. The capacity of the load must not exceed the switching capacity of the transistor (100 mA).
 3. The polarities of the power supply terminals are not reversible. Check connections before applying voltage to the power supply terminals to avoid damaging the Counter.

Safety Precautions

Refer to *Safety Precautions for All Counters*.

CAUTION

Minor injury due to electric shock may occasionally occur. Do not touch any of the terminals while power is being supplied.



Minor injury due to electric shock may occasionally occur. Do not touch the terminals for at least 1 minute after turning OFF the power supply.



Minor injury due to explosion may occasionally occur. Do not use the H7AN where subject to flammable or explosive gas.



Minor electric shock, fire, or malfunction may occasionally occur. Never attempt to disassemble, modify, or repair the H7AN or touch any of the internal parts.



If the output relay is used beyond its life expectancy, its contacts may become fused or there may be a risk of fire.



Use the output relay within its rated load and electrical life expectancy. The life expectancy of the output relay varies considerably according to its usage.

Fire may occasionally occur. Tighten the terminal screws to a torque of 0.74 to 0.90 N·m.



Do not allow metal fragments, lead wire scraps, or chips from processing during installation to fall inside the H7AN. Otherwise, minor electric shock, fire or malfunction may occasionally occur.



Precautions for Safe Use

- The H7AN is not waterproof or oil resistant. Do not use it in locations subject to water or oil.
- The load current must be within the rated current.
- Pay careful attention to polarity to avoid wrong connections when wiring the counter input terminals and reset input terminal.

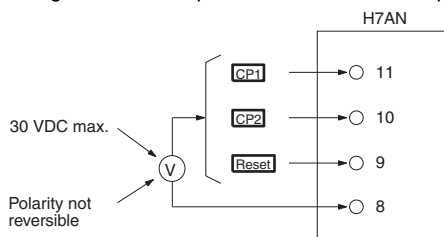

- Do not apply directly apply an external voltage to either the transistor output terminals or external power supply terminals.



- When using heaters, be sure to use a thermal switch for the load circuit.

- Use a switch, relay, or other contact device so that the power is turned ON or OFF quickly. If the power supply voltage is not reached quickly enough, the H7AN may malfunction.
- Use the specified wires for wiring.
Applicable Wires:
AWG24 to AWG18 (cross-sectional area of 0.205 to 0.823 mm²)
- Do not connect more than two crimp terminals to the same terminal.
- Do not connect anything to unused terminals.
- Leaving the H7AN with outputs ON at a high temperature for a long time may hasten the degradation of internal parts (such as electrolytic capacitors). Therefore, use the product in combination with relays and avoid leaving the product with the output turned ON for a long period of time (e.g., a month or more).
- The set value of the Preset Counter can be changed at any time during operation and the new set value will be used immediately. The output will turn ON whenever the set value equals the current count, so change the set value with care. (If a setting switch is accidentally touched during operation, the set value will be changed and the new set value will be used for operation. Always leave the front panel cover closed unless you are changing a setting.)
- When removing the Counter body from the case, never touch the terminals or electronic components with your hands or subject them to shock. When inserting the body, do not allow electronic components to come in contact with the case.
- Static electricity may destroy internal components. When removing the Counter body from the case, do not touch an electronic components other than the setting switches with your hands.
- When changing the set value during operation, do not leave a switch set so that two numbers are visible at the same time. The set value will not be accurate. Push the buttons on the thumbwheel switches firmly.

Precautions for Correct Use

- Inrush current of approximately 23 A will flow for a short period of time when the power supply is turned ON. If the capacity of the power supply is insufficient, the H7AN may not start. Use a power supply, breakers, an contacts with sufficient capacity.
- After turning ON the power supply, 50 ms is required for the internal circuits to reach the operating voltage. Operation for input signals may not be correctly during this time.
- After turning OFF the power supply, 50 ms is required for voltage in the internal circuits to drop. Operation may be performed for input signals during this time.

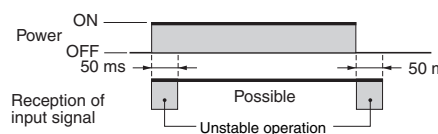

- Operation after the power supply is interrupted with be as shown below for models without data backup and for models that back up data for power interruptions (models with model numbers ending in "-M").



0.5 s or more	All reset
0.01 s or less	The counter continues normal operation same as before the power failure.
More than 0.01 and less than 0.5 s	The counter may reset or continue operating.

Note: Use a model with a backup function (models ending in "-M") to maintain the settings even for power interruptions. Be sure to enable the backup function.

- The following timing chart shows how the H7AN indicates when there is an external or manual reset input.

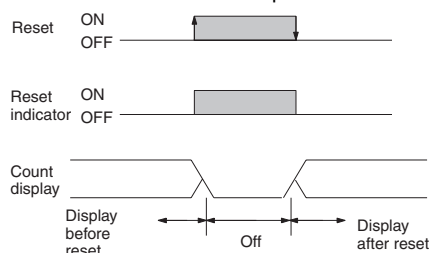

- To mount the casing on the digital counter, insert the digital counter body into the casing by hand as far as possible and then tighten the mounting screw. Press by the hand the front panel as indicated by the arrow so that the screw will tighten securely.

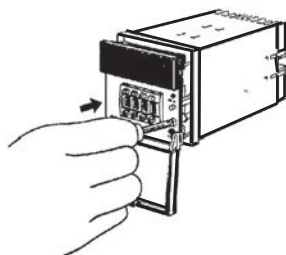

Retaining Data during Power Interruptions

Data is written to EEPROM when the power is turned OFF. The write life is 1,000,000 writes min.

Self-diagnosis

The following indications will be made when an error occurs.

7-segment display	Reset indicator	Count-out indicator	Error	Output status
E1	OFF	OFF	CPU error	OFF
E2	OFF	OFF	RAM memory error	OFF
E3	OFF	OFF	EEPROM memory error	OFF

Try correcting the error by cycling the power supply. If the indications do not change, try inputting the reset signal. If that does not work, the Counter will need to be repaired. If normal operation is recovered, it might have been caused by noise. Check for noise generation.

Changes in Specifications

This product was upgraded in January 2006. The main changes are described below.

1. Maximum Counting Speeds

A DIP switch on models with 4, 6, or 8 digits could be used to set the maximum counting speed to 3 kHz, 5 kHz, or 30 kHz. The upgraded models have been changed so the maximum counting speed can be set to 5 kHz or 30 kHz.

2. Addition of Setting to Enable/Disable Data Backup for Power Interruptions

On models that back up data when power is turned OFF (models with model numbers ending in "-M"), a DIP switch setting has been provided to enable or disable backup.

3. Changes in Functions Allocated to Function Setting Switches

Some of the functions allocated to the DIP switches have been changed to allow for the changes described in 1 and 2, above.

ALL DIMENSIONS SHOWN ARE IN MILLIMETERS.
To convert millimeters into inches, multiply by 0.03937. To convert grams into ounces, multiply by 0.03527.

In the interest of product improvement, specifications are subject to change without notice.

Read and Understand This Catalog

Please read and understand this catalog before purchasing the products. Please consult your OMRON representative if you have any questions or comments.

Warranty and Limitations of Liability

WARRANTY

OMRON's exclusive warranty is that the products are free from defects in materials and workmanship for a period of one year (or other period if specified) from date of sale by OMRON.

OMRON MAKES NO WARRANTY OR REPRESENTATION, EXPRESS OR IMPLIED, REGARDING NON-INFRINGEMENT, MERCHANTABILITY, OR FITNESS FOR PARTICULAR PURPOSE OF THE PRODUCTS. ANY BUYER OR USER ACKNOWLEDGES THAT THE BUYER OR USER ALONE HAS DETERMINED THAT THE PRODUCTS WILL SUITABLY MEET THE REQUIREMENTS OF THEIR INTENDED USE. OMRON DISCLAIMS ALL OTHER WARRANTIES, EXPRESS OR IMPLIED.

LIMITATIONS OF LIABILITY

OMRON SHALL NOT BE RESPONSIBLE FOR SPECIAL, INDIRECT, OR CONSEQUENTIAL DAMAGES, LOSS OF PROFITS OR COMMERCIAL LOSS IN ANY WAY CONNECTED WITH THE PRODUCTS, WHETHER SUCH CLAIM IS BASED ON CONTRACT, WARRANTY, NEGLIGENCE, OR STRICT LIABILITY.

In no event shall the responsibility of OMRON for any act exceed the individual price of the product on which liability is asserted.

IN NO EVENT SHALL OMRON BE RESPONSIBLE FOR WARRANTY, REPAIR, OR OTHER CLAIMS REGARDING THE PRODUCTS UNLESS OMRON'S ANALYSIS CONFIRMS THAT THE PRODUCTS WERE PROPERLY HANDLED, STORED, INSTALLED, AND MAINTAINED AND NOT SUBJECT TO CONTAMINATION, ABUSE, MISUSE, OR INAPPROPRIATE MODIFICATION OR REPAIR.

Application Considerations

SUITABILITY FOR USE

OMRON shall not be responsible for conformity with any standards, codes, or regulations that apply to the combination of products in the customer's application or use of the products.

At the customer's request, OMRON will provide applicable third party certification documents identifying ratings and limitations of use that apply to the products. This information by itself is not sufficient for a complete determination of the suitability of the products in combination with the end product, machine, system, or other application or use.

The following are some examples of applications for which particular attention must be given. This is not intended to be an exhaustive list of all possible uses of the products, nor is it intended to imply that the uses listed may be suitable for the products:

- Outdoor use, uses involving potential chemical contamination or electrical interference, or conditions or uses not described in this catalog.
- Nuclear energy control systems, combustion systems, railroad systems, aviation systems, medical equipment, amusement machines, vehicles, safety equipment, and installations subject to separate industry or government regulations.
- Systems, machines, and equipment that could present a risk to life or property.

Please know and observe all prohibitions of use applicable to the products.

NEVER USE THE PRODUCTS FOR AN APPLICATION INVOLVING SERIOUS RISK TO LIFE OR PROPERTY WITHOUT ENSURING THAT THE SYSTEM AS A WHOLE HAS BEEN DESIGNED TO ADDRESS THE RISKS, AND THAT THE OMRON PRODUCTS ARE PROPERLY RATED AND INSTALLED FOR THE INTENDED USE WITHIN THE OVERALL EQUIPMENT OR SYSTEM.

PROGRAMMABLE PRODUCTS

OMRON shall not be responsible for the user's programming of a programmable product, or any consequence thereof.

Disclaimers

CHANGE IN SPECIFICATIONS

Product specifications and accessories may be changed at any time based on improvements and other reasons.

It is our practice to change model numbers when published ratings or features are changed, or when significant construction changes are made. However, some specifications of the products may be changed without any notice. When in doubt, special model numbers may be assigned to fix or establish key specifications for your application on your request. Please consult with your OMRON representative at any time to confirm actual specifications of purchased products.

DIMENSIONS AND WEIGHTS

Dimensions and weights are nominal and are not to be used for manufacturing purposes, even when tolerances are shown.

PERFORMANCE DATA

Performance data given in this catalog is provided as a guide for the user in determining suitability and does not constitute a warranty. It may represent the result of OMRON's test conditions, and the users must correlate it to actual application requirements. Actual performance is subject to the OMRON Warranty and Limitations of Liability.

ERRORS AND OMISSIONS

The information in this document has been carefully checked and is believed to be accurate; however, no responsibility is assumed for clerical, typographical, or proofreading errors, or omissions.

2010.8

In the interest of product improvement, specifications are subject to change without notice.

OMRON Corporation
Industrial Automation Company

<http://www.ia.omron.com/>

(c)Copyright OMRON Corporation 2010 All Right Reserved.

Mouser Electronics

Authorized Distributor

Click to View Pricing, Inventory, Delivery & Lifecycle Information:

[Omron:](#)

[H7AN-R6DM-AC100-240](#) [H7AN-WE4DM-AC100-240](#) [H7AN-4D-AC100-240](#) [H7AN-2D-AC100-240](#) [H7AN-RW6DM-AC100-240](#) [H7AN-4DM-AC100-240](#) [H7AN-RT8-AC100-240](#)

Компания «Океан Электроники» предлагает заключение долгосрочных отношений при поставках импортных электронных компонентов на взаимовыгодных условиях!

Наши преимущества:

- Поставка оригинальных импортных электронных компонентов напрямую с производств Америки, Европы и Азии, а так же с крупнейших складов мира;
- Широкая линейка поставок активных и пассивных импортных электронных компонентов (более 30 млн. наименований);
- Поставка сложных, дефицитных, либо снятых с производства позиций;
- Оперативные сроки поставки под заказ (от 5 рабочих дней);
- Экспресс доставка в любую точку России;
- Помощь Конструкторского Отдела и консультации квалифицированных инженеров;
- Техническая поддержка проекта, помощь в подборе аналогов, поставка прототипов;
- Поставка электронных компонентов под контролем ВП;
- Система менеджмента качества сертифицирована по Международному стандарту ISO 9001;
- При необходимости вся продукция военного и аэрокосмического назначения проходит испытания и сертификацию в лаборатории (по согласованию с заказчиком);
- Поставка специализированных компонентов военного и аэрокосмического уровня качества (Xilinx, Altera, Analog Devices, Intersil, Interpoint, Microsemi, Actel, Aeroflex, Peregrine, VPT, Syfer, Eurofarad, Texas Instruments, MS Kennedy, Miteq, Cobham, E2V, MA-COM, Hittite, Mini-Circuits, General Dynamics и др.);

Компания «Океан Электроники» является официальным дистрибьютором и эксклюзивным представителем в России одного из крупнейших производителей разъемов военного и аэрокосмического назначения «JONHON», а так же официальным дистрибьютором и эксклюзивным представителем в России производителя высокотехнологичных и надежных решений для передачи СВЧ сигналов «FORSTAR».



JONHON

«JONHON» (основан в 1970 г.)

Разъемы специального, военного и аэрокосмического назначения:

(Применяются в военной, авиационной, аэрокосмической, морской, железнодорожной, горно- и нефтедобывающей отраслях промышленности)

«FORSTAR» (основан в 1998 г.)

ВЧ соединители, коаксиальные кабели, кабельные сборки и микроволновые компоненты:

(Применяются в телекоммуникациях гражданского и специального назначения, в средствах связи, РЛС, а так же военной, авиационной и аэрокосмической отраслях промышленности).



Телефон: 8 (812) 309-75-97 (многоканальный)

Факс: 8 (812) 320-03-32

Электронная почта: ocean@oceanchips.ru

Web: <http://oceanchips.ru/>

Адрес: 198099, г. Санкт-Петербург, ул. Калинина, д. 2, корп. 4, лит. А