



Features

- Lead free
- RoHS compliant*
- Surface Mount SMA package
- Standoff Voltage: 5.0 to 170 volts
- Power Dissipation: 400 watts



Model CD214A is currently available, although not recommended for new designs. **Model SMAJ** is preferred.

CD214A Transient Voltage Suppressor Diode Series

General Information

The markets of portable communications, computing and video equipment are challenging the semiconductor industry to develop increasingly smaller electronic components.

Bourns offers Transient Voltage Suppressor Diodes for surge and ESD protection applications, in compact chip package DO-214AC (SMA) size format. The Transient Voltage Suppressor series offers a choice of Working Peak Reverse Voltage from 5 V up to 170 V and Breakdown Voltage up to 200 V. Typical fast response times are less than 1.0 ns for unidirectional devices and less than 5.0 ns for bidirectional devices from 0 V to Minimum Breakdown Voltage.

Bourns® Chip Diodes conform to JEDEC standards, are easy to handle with standard pick and place equipment and the flat configuration minimizes roll away.

Electrical Characteristics (@ T_A = 25 °C Unless Otherwise Noted)

Parameter	Symbol	Value	Unit
Minimum Peak Pulse Power Dissipation (T _P = 1 ms) <small>(Note 1,2)</small>	P _{PK}	400	Watts
Peak Forward Surge Current 8.3ms Single Half Sine Wave Superimposed on Rated Load (JEDEC Method) <small>(Note 3)</small>	I _{FSM}	40	Amps
Steady State Power Dissipation @ T _L = 75 °C	P _{M(AV)}	1.0	Watts
Maximum Instantaneous Forward Voltage @ I _{PP} = 35 A (For Unidirectional Units Only)	V _F	3.5	Volts
Operating Temperature Range	T _J	-55 to +150	°C
Storage Temperature Range	T _{STG}	-55 to +175	°C

1. Non-repetitive current pulse, per Pulse Waveform graph and derated above T_A = 25 °C per Pulse Derating Curve.
2. Thermal Resistance Junction to Lead.
3. 8.3 ms Single Half-Sine Wave duty cycle = 4 pulses maximum per minute (unidirectional units only).
4. Single Phase, Half Wave, 60 Hz, resistive or inductive load. For capacitive load, derate current by 20 %.



Asia-Pacific:
Tel: +886-2 2562-4117 • Fax: +886-2 2562-4116

Europe:
Tel: +41-41 768 5555 • Fax: +41-41 768 5510

The Americas:
Tel: +1-951 781-5500 • Fax: +1-951 781-5700

www.bourns.com

How To Order

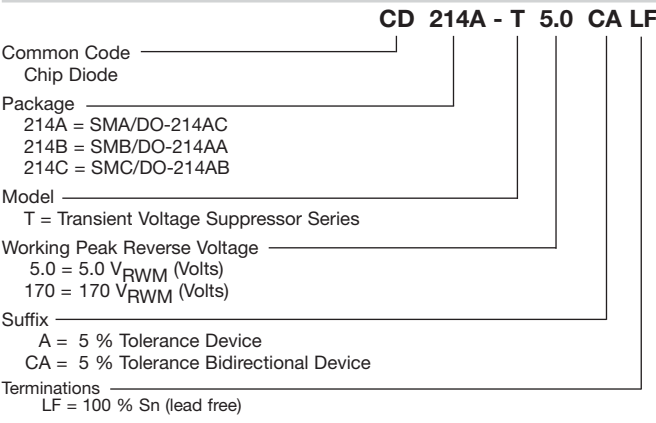

*RoHS Directive 2002/95/EC Jan 27 2003 including Annex
 Specifications are subject to change without notice.
 Customers should verify actual device performance in their specific applications.

Compliance

- IEC 61000-4-2 ESD (Min. Level 4)
- IEC 61000-4-4 EFT
- IEC 61000-4-5 Surge

CD214A Transient Voltage Suppressor Diode Series

BOURNS®

Electrical Characteristics (@T_A = 25 °C unless otherwise noted)

Unidirectional Device		Bidirectional Device		Breakdown Voltage V _{BR} (Volts)			Working Peak Reverse Voltage	Maximum Reverse Leakage @ V _{RWM}	Maximum Reverse Voltage @ I _{RSM}	Maximum Reverse Surge Current
Part Number	Part Marking	Part Number	Part Marking	Min.	Max.	@ I _T (mA)	V _{RWM} (Volts)	I _R (µA)	V _{RSM} (Volts)	I _{RSM} (Amps)
CD214A-T5.0A	HE	CD214A-T5.0CA	TE	6.40	7.00	10	5.0	800 / 1600	9.2	43.5
CD214A-T6.0A	HG	CD214A-T6.0CA	TG	6.67	7.37	10	6.0	800 / 1600	10.3	38.8
CD214A-T6.5A	HK	CD214A-T6.5CA	TK	7.22	7.98	10	6.5	500 / 1000	11.2	35.7
CD214A-T7.0A	HM	CD214A-T7.0CA	TM	7.78	8.60	10	7.0	200 / 400	12.0	33.3
CD214A-T7.5A	HP	CD214A-T7.5CA	TP	8.33	9.21	1.0	7.5	100 / 200	12.9	31.0
CD214A-T8.0A	HR	CD214A-T8.0CA	TR	8.89	9.83	1.0	8.0	50 / 100	13.6	29.4
CD214A-T8.5A	HT	CD214A-T8.5CA	TT	9.44	10.4	1.0	8.5	10 / 20	14.4	27.7
CD214A-T9.0A	HV	CD214A-T9.0CA	TV	10.0	11.1	1.0	9.0	5 / 10	15.4	26.0
CD214A-T10A	HX	CD214A-T10CA	TX	11.1	12.3	1.0	10	5 / 10	17.0	23.5
CD214A-T11A	HZ	CD214A-T11CA	TZ	12.2	13.2	1.0	11	5.0	18.2	22.0
CD214A-T12A	IE	CD214A-T12CA	UE	13.3	14.7	1.0	12	5.0	19.9	20.1
CD214A-T13A	IG	CD214A-T13CA	UG	14.4	15.9	1.0	13	5.0	21.5	18.6
CD214A-T14A	IK	CD214A-T14CA	UK	15.6	17.2	1.0	14	5.0	23.2	17.2
CD214A-T15A	IM	CD214A-T15CA	UM	16.7	18.5	1.0	15	5.0	24.4	16.4
CD214A-T16A	IP	CD214A-T16CA	UP	17.8	19.7	1.0	16	5.0	26.0	15.3
CD214A-T17A	IR	CD214A-T17CA	UR	18.9	20.9	1.0	17	5.0	27.6	14.5
CD214A-T18A	IT	CD214A-T18CA	UT	20.0	22.1	1.0	18	5.0	29.2	13.7
CD214A-T20A	IV	CD214A-T20CA	UV	22.2	24.5	1.0	20	5.0	32.4	12.3
CD214A-T22A	IX	CD214A-T22CA	UX	24.4	26.9	1.0	22	5.0	35.5	11.2
CD214A-T24A	IZ	CD214A-T24CA	UZ	26.7	29.5	1.0	24	5.0	38.9	10.3
CD214A-T26A	JE	CD214A-T26CA	VE	28.9	31.9	1.0	26	5.0	42.1	9.5
CD214A-T28A	JG	CD214A-T28CA	VG	31.1	34.4	1.0	28	5.0	45.4	8.8
CD214A-T30A	JK	CD214A-T30CA	VK	33.3	36.8	1.0	30	5.0	48.4	8.3
CD214A-T33A	JM	CD214A-T33CA	VM	36.7	40.6	1.0	33	5.0	53.3	7.5
CD214A-T36A	JP	CD214A-T36CA	VP	40	44.2	1.0	36	5.0	58.1	6.9
CD214A-T40A	JR	CD214A-T40CA	VR	44.4	49.1	1.0	40	5.0	64.5	6.2
CD214A-T43A	JT	CD214A-T43CA	VT	47.8	52.8	1.0	43	5.0	69.4	5.7
CD214A-T45A	JV	CD214A-T45CA	VV	50	55.3	1.0	45	5.0	72.7	5.5
CD214A-T48A	JX	CD214A-T48CA	VX	53.3	58.9	1.0	48	5.0	77.4	5.2
CD214A-T51A	JZ	CD214A-T51CA	VZ	56.7	62.7	1.0	51	5.0	82.4	4.9
CD214A-T54A	RE	CD214A-T54CA	WE	60	66.3	1.0	54	5.0	87.1	4.6
CD214A-T58A	RG	CD214A-T58CA	WG	64.4	71.2	1.0	58	5.0	93.6	4.3
CD214A-T60A	RK	CD214A-T60CA	WK	66.7	73.7	1.0	60	5.0	96.8	4.1
CD214A-T64A	RM	CD214A-T64CA	WM	71.1	78.6	1.0	64	5.0	103	3.9
CD214A-T70A	RP	CD214A-T70CA	WP	77.8	86.0	1.0	70	5.0	113	3.5
CD214A-T75A	RR	CD214A-T75CA	WR	83.3	92.1	1.0	75	5.0	121	3.3
CD214A-T78A	RT	CD214A-T78CA	WT	86.7	95.8	1.0	78	5.0	126	3.2
CD214A-T85A	RV	CD214A-T85CA	WV	94.4	104	1.0	85	5.0	137	2.9
CD214A-T90A	RX	CD214A-T90CA	WX	100	111	1.0	90	5.0	146	2.7
CD214A-T100A	RZ	CD214A-T100CA	WZ	111	123	1.0	100	5.0	162	2.5
CD214A-T110A	SE	CD214A-T110CA	XE	122	135	1.0	110	5.0	177	2.3
CD214A-T120A	SG	CD214A-T120CA	XG	133	147	1.0	120	5.0	193	2.0
CD214A-T130A	SK	CD214A-T130CA	XK	144	159	1.0	130	5.0	209	1.9
CD214A-T150A	SM	CD214A-T150CA	XM	167	185	1.0	150	5.0	243	1.6
CD214A-T160A	SP	CD214A-T160CA	XP	178	197	1.0	160	5.0	259	1.5
CD214A-T170A	SR	CD214A-T170CA	XR	189	209	1.0	170	5.0	275	1.4

Notes:

1. Suffix 'A' denotes a 5 % tolerance device.
2. Suffix 'CA' denotes a 5 % tolerance bidirectional device.
3. For bidirectional devices with a V_R of 10 volts or less, the I_R limit is double.
4. For unidirectional devices with a V_F max. of 3.5 V at an I_F of 35 A, 0.5 Sine Wave of 8.3 ms Pulse Width.

Specifications are subject to change without notice.
Customers should verify actual device performance in their specific applications.

CD214A Transient Voltage Suppressor Diode Series

BOURNS®

Product Dimensions

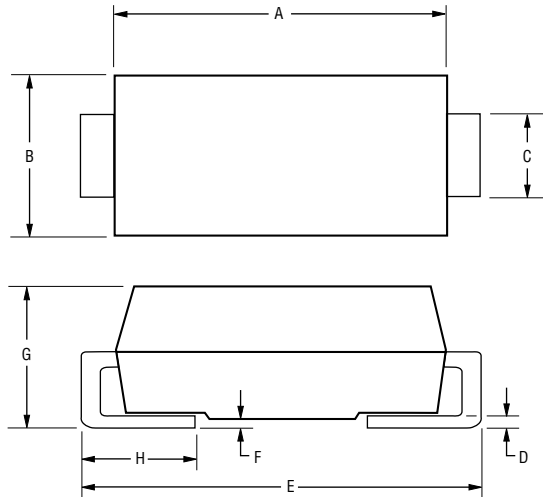

Dimension	SMA (DO-214AC)
A	$\frac{4.06 - 4.57}{(0.160 - 0.180)}$
B	$\frac{2.29 - 2.92}{(0.090 - 0.115)}$
C	$\frac{1.27 - 1.63}{(0.050 - 0.064)}$
D	$\frac{0.15 - 0.31}{(0.006 - 0.112)}$
E	$\frac{4.83 - 5.59}{(0.190 - 0.220)}$
F	$\frac{0.05 - 0.20}{(0.002 - 0.008)}$
G	$\frac{2.01 - 2.62}{(0.080 - 0.103)}$
H	$\frac{0.76 - 1.52}{(0.030 - 0.060)}$

DIMENSIONS: $\frac{\text{MM}}{\text{(INCHES)}}$

Recommended Pad Layout

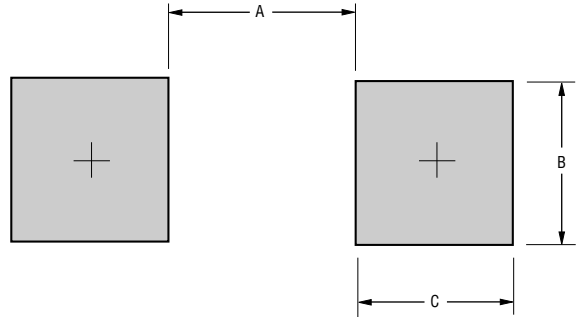

Dimension	SMA (DO-214AC)
A (Max.)	$\frac{2.70}{(0.106)}$
B (Min.)	$\frac{2.10}{(0.083)}$
C (Min.)	$\frac{1.27}{(0.050)}$

DIMENSIONS: $\frac{\text{MM}}{\text{(INCHES)}}$

Physical Specifications

CaseMolded plastic per UL Class 94V-0
 Polarity.....Cathode band indicates unidirectional device
 No cathode band indicates bidirectional device
 Weight0.002 ounces / 0.064 grams

CD214A Transient Voltage Suppressor Diode Series



Rating and Characteristic Curves

Pulse Derating Curve



Maximum Non-Repetitive Surge Current

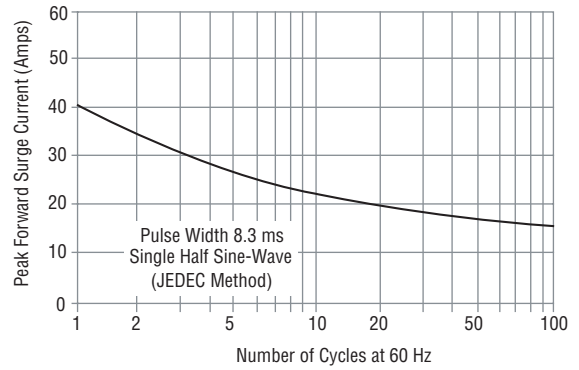

Pulse Waveform

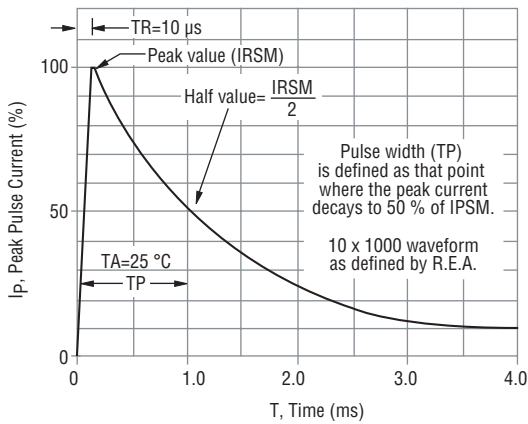

Typical Junction Capacitance

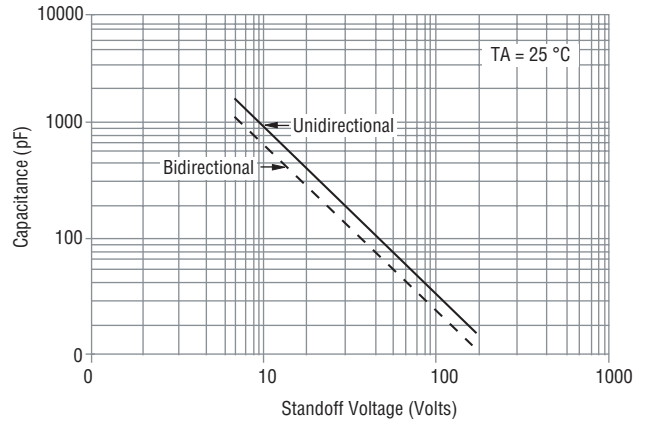

Pulse Rating Curve

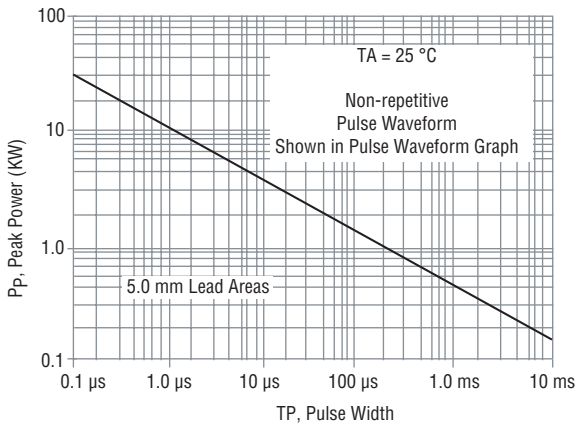

Steady State Power Derating Curve

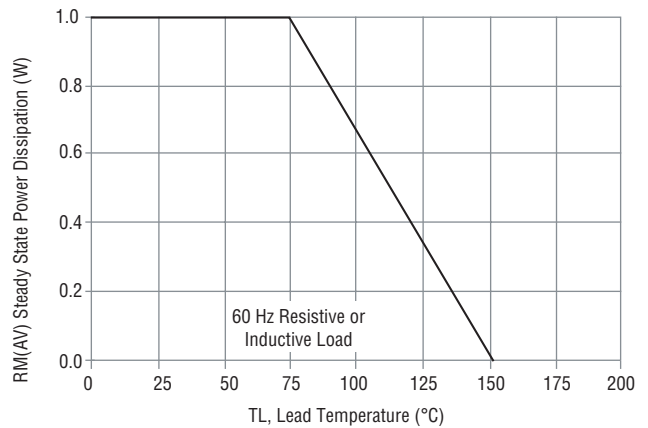

Specifications are subject to change without notice. Customers should verify actual device performance in their specific applications.

CD214A Transient Voltage Suppressor Diode Series

BOURNS®

Packaging Information

The product will be dispensed in Tape and Reel format (see diagram below).



Item	Symbol	SMA (DO-214AC)
Carrier Width	A	$\frac{2.90 \pm 0.10}{(0.114 - 0.004)}$
Carrier Length	B	$\frac{5.59 \pm 0.10}{(0.220 - 0.004)}$
Carrier Depth	C	$\frac{2.36 \pm 0.10}{(0.093 - 0.004)}$
Sprocket Hole	d	$\frac{1.55 \pm 0.05}{(0.061 - 0.002)}$
Reel Outside Diameter	D	$\frac{330}{(12.992)}$
Reel Inner Diameter	D ₁	$\frac{50.0}{(1.969)}$ MIN.
Feed Hole Diameter	D ₂	$\frac{13.0 \pm 0.20}{(0.512 - 0.008)}$
Sprocket Hole Position	E	$\frac{1.75 \pm 0.10}{(0.069 - 0.004)}$
Punch Hole Position	F	$\frac{5.50 \pm 0.05}{(0.217 - 0.002)}$
Punch Hole Pitch	P	$\frac{4.00 \pm 0.10}{(0.157 - 0.004)}$
Sprocket Hole Pitch	P ₀	$\frac{4.00 \pm 0.10}{(0.157 - 0.004)}$
Embossment Center	P ₁	$\frac{2.00 \pm 0.05}{(0.079 - 0.002)}$
Overall Tape Thickness	T	$\frac{0.30 \pm 0.10}{(0.012 - 0.004)}$
Tape Width	W	$\frac{12.00 \pm 0.20}{(0.472 - 0.008)}$
Reel Width	W ₁	$\frac{18.4}{(0.724)}$ MAX.
Quantity per Reel	--	5,000

Компания «Океан Электроники» предлагает заключение долгосрочных отношений при поставках импортных электронных компонентов на взаимовыгодных условиях!

Наши преимущества:

- Поставка оригинальных импортных электронных компонентов напрямую с производств Америки, Европы и Азии, а так же с крупнейших складов мира;
- Широкая линейка поставок активных и пассивных импортных электронных компонентов (более 30 млн. наименований);
- Поставка сложных, дефицитных, либо снятых с производства позиций;
- Оперативные сроки поставки под заказ (от 5 рабочих дней);
- Экспресс доставка в любую точку России;
- Помощь Конструкторского Отдела и консультации квалифицированных инженеров;
- Техническая поддержка проекта, помощь в подборе аналогов, поставка прототипов;
- Поставка электронных компонентов под контролем ВП;
- Система менеджмента качества сертифицирована по Международному стандарту ISO 9001;
- При необходимости вся продукция военного и аэрокосмического назначения проходит испытания и сертификацию в лаборатории (по согласованию с заказчиком);
- Поставка специализированных компонентов военного и аэрокосмического уровня качества (Xilinx, Altera, Analog Devices, Intersil, Interpoint, Microsemi, Actel, Aeroflex, Peregrine, VPT, Syfer, Eurofarad, Texas Instruments, MS Kennedy, Miteq, Cobham, E2V, MA-COM, Hittite, Mini-Circuits, General Dynamics и др.);

Компания «Океан Электроники» является официальным дистрибьютором и эксклюзивным представителем в России одного из крупнейших производителей разъемов военного и аэрокосмического назначения «JONHON», а так же официальным дистрибьютором и эксклюзивным представителем в России производителя высокотехнологичных и надежных решений для передачи СВЧ сигналов «FORSTAR».



JONHON

«JONHON» (основан в 1970 г.)

Разъемы специального, военного и аэрокосмического назначения:

(Применяются в военной, авиационной, аэрокосмической, морской, железнодорожной, горно- и нефтедобывающей отраслях промышленности)

«FORSTAR» (основан в 1998 г.)

ВЧ соединители, коаксиальные кабели, кабельные сборки и микроволновые компоненты:

(Применяются в телекоммуникациях гражданского и специального назначения, в средствах связи, РЛС, а так же военной, авиационной и аэрокосмической отраслях промышленности).



Телефон: 8 (812) 309-75-97 (многоканальный)

Факс: 8 (812) 320-03-32

Электронная почта: ocean@oceanchips.ru

Web: <http://oceanchips.ru/>

Адрес: 198099, г. Санкт-Петербург, ул. Калинина, д. 2, корп. 4, лит. А