



## Device Overview

The 89HPES24NT24G2 is a member of the IDT family of PCI Express® switching solutions. The PES24NT24G2 is a 24-lane, 24-port system interconnect switch optimized for PCI Express Gen2 packet switching in high-performance applications, supporting multiple simultaneous peer-to-peer traffic flows. Target applications include multi-host or intelligent I/O based systems where inter-domain communication is required, such as servers, storage, communications, and embedded systems.

## Features

### ◆ High Performance Non-Blocking Switch Architecture

- 24-lane, 24-port PCIe switch with flexible port configuration
- Integrated SerDes supports 5.0 GT/s Gen2 and 2.5 GT/s Gen1 operation
- Delivers up to 24 GBps (192 Gbps) of switching capacity
- Supports 128 Bytes to 2 KB maximum payload size
- Low latency cut-through architecture
- Supports one virtual channel and eight traffic classes

### ◆ Port Configurability

- Twenty-four x1 ports configurable as follows:
  - One x8 stack
    - Eight x1 ports (ports 0 through 7 are not capable of merging with an adjacent port)
  - Two x8 stacks configurable as:
    - Two x8 ports
    - Four x4 ports
    - Eight x2 ports
    - Sixteen x1 ports
- Automatic per port link width negotiation (x8 → x4 → x2 → x1)
- Crosslink support
- Automatic lane reversal
- Per lane SerDes configuration
  - De-emphasis
  - Receive equalization
  - Drive strength

### ◆ Innovative Switch Partitioning Feature

- Supports up to 8 fully independent switch partitions
- Logically independent switches in the same device
- Configurable downstream port device numbering
- Supports dynamic reconfiguration of switch partitions
  - Dynamic port reconfiguration — downstream, upstream, non-transparent bridge
  - Dynamic migration of ports between partitions

- Movable upstream port within and between switch partitions
- ◆ **Non-Transparent Bridging (NTB) Support**
  - Supports up to 8 NT endpoints per switch, each endpoint can communicate with other switch partitions or external PCIe domains or CPUs
  - 6 BARs per NT Endpoint
    - Bar address translation
    - All BARs support 32/64-bit base and limit address translation
    - Two BARs (BAR2 and BAR4) support look-up table based address translation
  - 32 inbound and outbound doorbell registers
  - 4 inbound and outbound message registers
  - Supports up to 64 masters
  - Unlimited number of outstanding transactions
- ◆ **Multicast**
  - Compliant with the PCI-SIG multicast
  - Supports 64 multicast groups
  - Supports multicast across non-transparent port
  - Multicast overlay mechanism support
  - ECRC regeneration support
- ◆ **Integrated Direct Memory Access (DMA) Controllers**
  - Supports up to 2 DMA upstream ports, each with 2 DMA channels
  - Supports 32-bit and 64-bit memory-to-memory transfers
    - Fly-by translation provides reduced latency and increased performance over buffered approach
    - Supports arbitrary source and destination address alignment
    - Supports intra- as well as inter-partition data transfers using the non-transparent endpoint
  - Supports DMA transfers to multicast groups
  - Linked list descriptor-based operation
  - Flexible addressing modes
    - Linear addressing
    - Constant addressing
- ◆ **Quality of Service (QoS)**
  - Port arbitration
    - Round robin
  - Request metering
    - IDT proprietary feature that balances bandwidth among switch ports for maximum system throughput
  - High performance switch core architecture
    - Combined Input Output Queued (CIOQ) switch architecture with large buffers

IDT and the IDT logo are registered trademarks of Integrated Device Technology, Inc.

#### ◆ Clocking

- Supports 100 MHz and 125 MHz reference clock frequencies
- Flexible port clocking modes
  - Common clock
  - Non-common clock
  - Local port clock with SSC (spread spectrum setting) and port reference clock input

#### ◆ Hot-Plug and Hot Swap

- Hot-plug controller on all ports
  - Hot-plug supported on all downstream switch ports
- All ports support hot-plug using low-cost external I<sup>2</sup>C I/O expanders
- Configurable presence-detect supports card and cable applications
- GPE output pin for hot-plug event notification
  - Enables SCI/SMI generation for legacy operating system support
- Hot-swap capable I/O

#### ◆ Power Management

- Supports D0, D3hot and D3 power management states
- Active State Power Management (ASPM)
  - Supports L0, L0s, L1, L2/L3 Ready, and L3 link states
  - Configurable L0s and L1 entry timers allow performance/power-savings tuning
- SerDes power savings
  - Supports low swing / half-swing SerDes operation
  - SerDes associated with unused ports are turned off
  - SerDes associated with unused lanes are placed in a low power state

#### ◆ Reliability, Availability, and Serviceability (RAS)

- ECRC support
- AER on all ports
- SECDED ECC protection on all internal RAMs
- End-to-end data path parity protection
- Checksum Serial EEPROM content protected
- Ability to generate an interrupt (INTx or MSI) on link up/down transitions

#### ◆ Initialization / Configuration

- Supports Root (BIOS, OS, or driver), Serial EEPROM, or SMBus switch initialization
- Common switch configurations are supported with pin strapping (no external components)
- Supports in-system Serial EEPROM initialization/programming

#### ◆ On-Die Temperature Sensor

- Range of 0 to 127.5 degrees Celsius
- Three programmable temperature thresholds with over and under temperature threshold alarms
- Automatic recording of maximum high or minimum low temperature

#### ◆ 9 General Purpose I/O

##### ◆ Test and Debug

- Ability to inject AER errors simplifies in system error handling software validation
- On-chip link activity and status outputs available for several ports
- Per port link activity and status outputs available using external I<sup>2</sup>C I/O expander for all remaining ports
- Supports IEEE 1149.6 AC JTAG and IEEE 1149.1 JTAG

##### ◆ Standards and Compatibility

- PCI Express Base Specification 2.1 compliant
- Implements the following optional PCI Express features
  - Advanced Error Reporting (AER) on all ports
  - End-to-End CRC (ECRC)
  - Access Control Services (ACS)
  - Device Serial Number Enhanced Capability
  - Sub-System ID and Sub-System Vendor ID Capability
  - Internal Error Reporting
  - Multicast
  - VGA and ISA enable
  - L0s and L1 ASPM
  - ARI

##### ◆ Power Supplies

- Requires three power supply voltages (1.0V, 2.5V, and 3.3V)

##### ◆ Packaged in a 19mm x 19mm 324-ball Flip Chip BGA with 1mm ball spacing

## Product Description

With Non-Transparent Bridging functionality and innovative Switch Partitioning feature, the PES24NT24G2 allows true multi-host or multi-processor communications in a single device. Integrated DMA controllers enable high-performance system design by off-loading data transfer operations across memories from the processors. Each lane is capable of 5 GT/s link speed in both directions and is fully compliant with PCI Express Base Specification 2.1.

A non-transparent bridge (NTB) is required when two PCI Express domains need to communicate to each other. The main function of the NTB block is to initialize and translate addresses and device IDs to allow data exchange across PCI Express domains. The major functionalities of the NTB block are summarized in [Table 1](#).

## Block Diagram

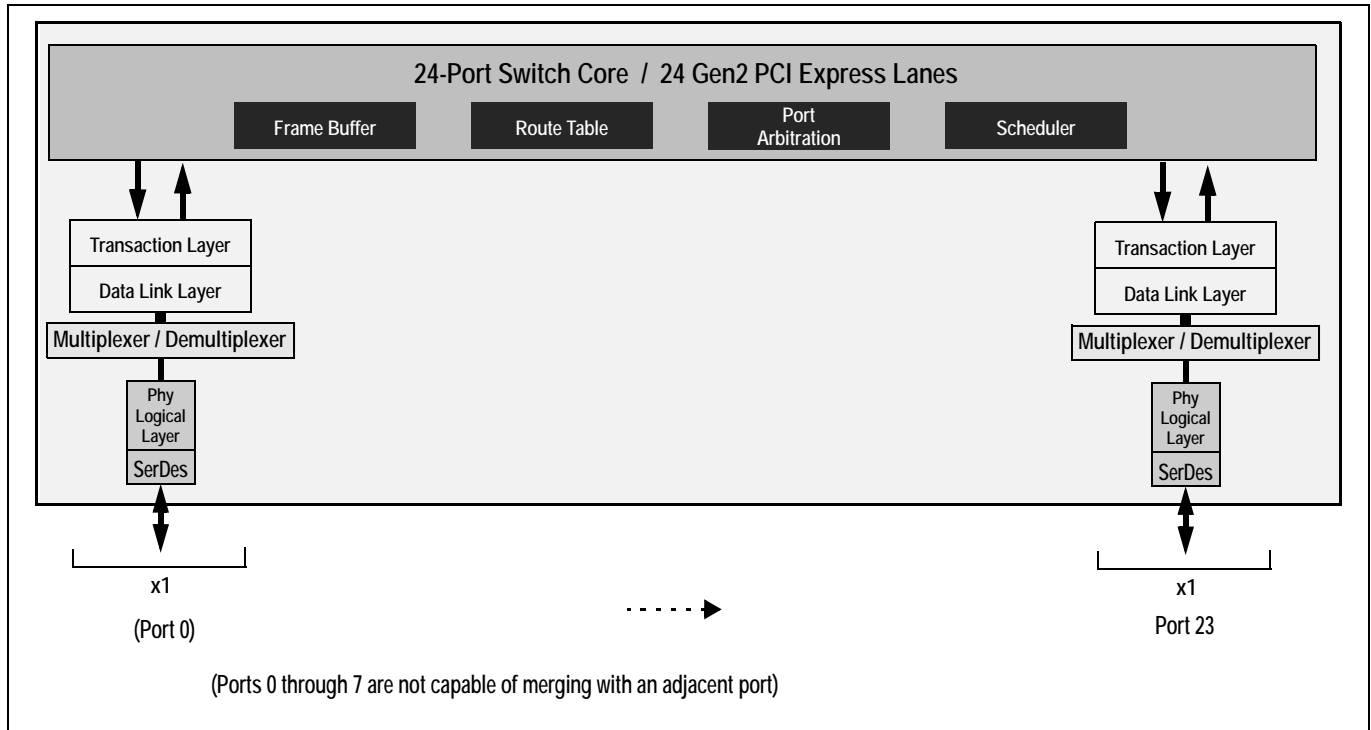

Figure 1 PES24NT24G2 Block Diagram

Function	Number	Description
NTB ports	Up to 8	Each device can be configured to have up to 8 NTB functions and can support up to 8 CPUs/roots.
Mapping table entries	Up to 64 for entire device	Each device can have up to 64 masters ID for address and ID translations.
Mapping windows	Six 32-bits or three 64-bits	Each NT port has six BARs, where each BAR opening an NT window to another domain.
Address translation	Direct-address and lookup table translations	Lookup-table translation divides the BAR aperture into up to 24 segments, where each segment has independent translation programming and is associated with an entry in a look-up table.
Doorbell registers	32 bits	Doorbell register is used for event signaling between domains, where an outbound doorbell bit sets a corresponding bit at the inbound doorbell in the other domain.
Message registers	4 inbound and outbound registers of 32-bits	Message registers allow mailbox message passing between domains -- message placed in the inbound register will be seen at the outbound register at the other domain.

Table 1 Non-Transparent Bridge Function Summary

## SMBus Interface

The PES24NT24G2 contains two SMBus interfaces. The slave interface provides full access to the configuration registers in the PES24NT24G2, allowing every configuration register in the device to be read or written by an external agent. The master interface allows the default configuration register values of the PES24NT24G2 to be overridden following a reset with values programmed in an external serial EEPROM. The master interface is also used by an external Hot-Plug I/O expander.

Each of the two SMBus interfaces contain an SMBus clock pin and an SMBus data pin. In addition, the slave SMBus has SSMBADDR1 and SSMBADDR2 pins. As shown in Figure 2, the master and slave SMBuses may only be used in a split configuration. In the split configuration, the master and slave SMBuses operate as two independent buses; thus, multi-master arbitration is not required. The SMBus master interface does not support SMBus arbitration. As a result, the switch's SMBus master must be the only master in the SMBus lines that connect to the serial EEPROM and I/O expander slaves.

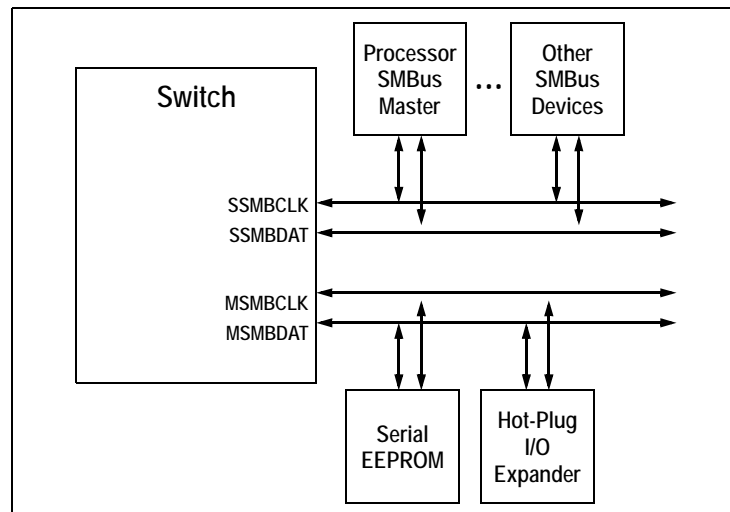

Figure 2 Split SMBus Interface Configuration

## Hot-Plug Interface

The PES24NT24G2 supports PCI Express Hot-Plug on each downstream port (ports 1 through 23). To reduce the number of pins required on the device, the PES24NT24G2 utilizes an external I/O expander, such as that used on PC motherboards, connected to the SMBus master interface. Following reset and configuration, whenever the state of a Hot-Plug output needs to be modified, the PES24NT24G2 generates an SMBus transaction to the I/O expander with the new value of all of the outputs. Whenever a Hot-Plug input changes, the I/O expander generates an interrupt which is received on the IOEXPINTN input pin (alternate function of GPIO) of the PES24NT24G2. In response to an I/O expander interrupt, the PES24NT24G2 generates an SMBus transaction to read the state of all of the Hot-Plug inputs from the I/O expander.

## General Purpose Input/Output

The PES24NT24G2 provides 9 General Purpose I/O (GPIO) pins that may be individually configured as general purpose inputs, general purpose outputs, or alternate functions. All GPIO pins are shared with other on-chip functions. These alternate functions may be enabled via software, SMBus slave interface, or serial configuration EEPROM.

## Pin Description

The following tables list the functions of the pins provided on the PES24NT24G2. Some of the functions listed may be multiplexed onto the same pin. The active polarity of a signal is defined using a suffix. Signals ending with an "N" are defined as being active, or asserted, when at a logic zero (low) level. All other signals (including clocks, buses, and select lines) will be interpreted as being active, or asserted, when at a logic one (high) level. Differential signals end with a suffix "N" or "P." The differential signal ending in "P" is the positive portion of the differential pair and the differential signal ending in "N" is the negative portion of the differential pair.

**Note:** Pin [x] of a port refers to a lane. For port 0, PE00RN[0] refers to lane 0, PE00RN[1] refers to lane 1, etc.

Signal	Type	Name/Description
PE00RN[0] PE00RP[0]	I	PCI Express Port 0 Serial Data Receive. Differential PCI Express receive pair for port 0.
PE00TN[0] PE00TP[0]	O	PCI Express Port 0 Serial Data Transmit. Differential PCI Express transmit pair for port 0.
PE01RN[0] PE01RP[0]	I	PCI Express Port 1 Serial Data Receive. Differential PCI Express receive pair for port 1.
PE01TN[0] PE01TP[0]	O	PCI Express Port 1 Serial Data Transmit. Differential PCI Express transmit pair for port 1.
PE02RN[0] PE02RP[0]	I	PCI Express Port 2 Serial Data Receive. Differential PCI Express receive pair for port 2.
PE02TN[0] PE02TP[0]	O	PCI Express Port 2 Serial Data Transmit. Differential PCI Express transmit pair for port 2.
PE03RN[0] PE03RP[0]	I	PCI Express Port 3 Serial Data Receive. Differential PCI Express receive pair for port 3.
PE03TN[0] PE03TP[0]	O	PCI Express Port 3 Serial Data Transmit. Differential PCI Express transmit pair for port 3.
PE04RN[0] PE04RP[0]	I	PCI Express Port 4 Serial Data Receive. Differential PCI Express receive pair for port 4.
PE04TN[0] PE04TP[0]	O	PCI Express Port 4 Serial Data Transmit. Differential PCI Express transmit pair for port 4.
PE05RN[0] PE05RP[0]	I	PCI Express Port 5 Serial Data Receive. Differential PCI Express receive pair for port 5.
PE05TN[0] PE05TP[0]	O	PCI Express Port 5 Serial Data Transmit. Differential PCI Express transmit pair for port 5.
PE06RN[0] PE06RP[0]	I	PCI Express Port 6 Serial Data Receive. Differential PCI Express receive pair for port 6.
PE06TN[0] PE06TP[0]	O	PCI Express Port 6 Serial Data Transmit. Differential PCI Express transmit pair for port 6.
PE07RN[0] PE07RP[0]	I	PCI Express Port 7 Serial Data Receive. Differential PCI Express receive pair for port 7.
PE07TN[0] PE07TP[0]	O	PCI Express Port 7 Serial Data Transmit. Differential PCI Express transmit pair for port 7.
PE08RN[0] PE08RP[0]	I	PCI Express Port 8 Serial Data Receive. Differential PCI Express receive pair for port 8.
PE08TN[0] PE08TP[0]	O	PCI Express Port 8 Serial Data Transmit. Differential PCI Express transmit pair for port 8.
PE09RN[0] PE09RP[0]	I	PCI Express Port 9 Serial Data Receive. Differential PCI Express receive pair for port 9.
PE09TN[0] PE09TP[0]	O	PCI Express Port 9 Serial Data Transmit. Differential PCI Express transmit pair for port 9.
PE10RN[0] PE10RP[0]	I	PCI Express Port 10 Serial Data Receive. Differential PCI Express receive pair for port 10.

Table 2 PCI Express Interface Pins (Part 1 of 3)

Signal	Type	Name/Description
PE10TN[0] PE10TP[0]	O	PCI Express Port 10 Serial Data Transmit. Differential PCI Express transmit pair for port 10.
PE11RN[0] PE11RP[0]	I	PCI Express Port 11 Serial Data Receive. Differential PCI Express receive pair for port 11.
PE11TN[0] PE11TP[0]	O	PCI Express Port 11 Serial Data Transmit. Differential PCI Express transmit pair for port 11.
PE12RN[0] PE12RP[0]	I	PCI Express Port 12 Serial Data Receive. Differential PCI Express receive pair for port 12.
PE12TN[0] PE12TP[0]	O	PCI Express Port 12 Serial Data Transmit. Differential PCI Express transmit pair for port 12.
PE13RN[0] PE13RP[0]	I	PCI Express Port 13 Serial Data Receive. Differential PCI Express receive pair for port 13.
PE13TN[0] PE13TP[0]	O	PCI Express Port 13 Serial Data Transmit. Differential PCI Express transmit pair for port 13. W
PE14RN[0] PE14RP[0]	I	PCI Express Port 14 Serial Data Receive. Differential PCI Express receive pair for port 14.
PE14TN[0] PE14TP[0]	O	PCI Express Port 14 Serial Data Transmit. Differential PCI Express transmit pair for port 14.
PE15RN[0] PE15RP[0]	I	PCI Express Port 15 Serial Data Receive. Differential PCI Express receive pair for port 15.
PE15TN[0] PE15TP[0]	O	PCI Express Port 15 Serial Data Transmit. Differential PCI Express transmit pair for port 15.
PE16RN[0] PE16RP[0]	I	PCI Express Port 16 Serial Data Receive. Differential PCI Express receive pair for port 16.
PE16TN[0] PE16TP[0]	O	PCI Express Port 16 Serial Data Transmit. Differential PCI Express transmit pair for port 16.
PE17RN[0] PE17RP[0]	I	PCI Express Port 17 Serial Data Receive. Differential PCI Express receive pair for port 17.
PE17TN[0] PE17TP[0]	O	PCI Express Port 17 Serial Data Transmit. Differential PCI Express transmit pair for port 17.
PE18RN[0] PE18RP[0]	I	PCI Express Port 18 Serial Data Receive. Differential PCI Express receive pair for port 18.
PE18TN[0] PE18TP[0]	O	PCI Express Port 18 Serial Data Transmit. Differential PCI Express transmit pair for port 18.
PE19RN[0] PE19RP[0]	I	PCI Express Port 19 Serial Data Receive. Differential PCI Express receive pair for port 19.
PE19TN[0] PE19TP[0]	O	PCI Express Port 19 Serial Data Transmit. Differential PCI Express transmit pair for port 19.
PE20RN[0] PE20RP[0]	I	PCI Express Port 20 Serial Data Receive. Differential PCI Express receive pair for port 20.
PE20TN[0] PE20TP[0]	O	PCI Express Port 20 Serial Data Transmit. Differential PCI Express transmit pair for port 20.
PE21RN[0] PE21RP[0]	I	PCI Express Port 21 Serial Data Receive. Differential PCI Express receive pair for port 21.

Table 2 PCI Express Interface Pins (Part 2 of 3)

Signal	Type	Name/Description
PE21TN[0] PE21TP[0]	O	<b>PCI Express Port 21 Serial Data Transmit.</b> Differential PCI Express transmit pair for port 21.
PE22RN[0] PE22RP[0]	I	<b>PCI Express Port 22 Serial Data Receive.</b> Differential PCI Express receive pair for port 22.
PE22TN[0] PE22TP[0]	O	<b>PCI Express Port 22 Serial Data Transmit.</b> Differential PCI Express transmit pair for port 22.
PE23RN[0] PE23RP[0]	I	<b>PCI Express Port 23 Serial Data Receive.</b> Differential PCI Express receive pair for port 23.
PE23TN[0] PE23TP[0]	O	<b>PCI Express Port 23 Serial Data Transmit.</b> Differential PCI Express transmit pair for port 23.

Table 2 PCI Express Interface Pins (Part 3 of 3)

Signal	Type	Name/Description
GCLKN[1:0] GCLKP[1:0]	I	<b>Global Reference Clock.</b> Differential reference clock input pairs. This clock is used as the reference clock by on-chip PLLs to generate the clocks required for the system logic. The frequency of the differential reference clock is determined by the GCLKFSEL signal. Note: Both pairs of the Global Reference Clocks must be connected to and derived from the same clock source. Refer to the Overview section of Chapter 2 in the PES24NT24G2 User Manual for additional details.
P08CLKN P08CLKP	I	<b>Port Reference Clock.</b> Differential reference clock pair associated with port 8.
P16CLKN P16CLKP	I	<b>Port Reference Clock.</b> Differential reference clock pair associated with port 16.

Table 3 Reference Clock Pins

Signal	Type	Name/Description
MSMBCLK	I/O	<b>Master SMBus Clock.</b> This bidirectional signal is used to synchronize transfers on the master SMBus. It is active and generating the clock only when the EEPROM or I/O Expanders are being accessed.
MSMBDAT	I/O	<b>Master SMBus Data.</b> This bidirectional signal is used for data on the master SMBus.
SSMBADDR[2,1]	I	<b>Slave SMBus Address.</b> These pins determine the SMBus address to which the slave SMBus interface responds.
SSMBCLK	I/O	<b>Slave SMBus Clock.</b> This bidirectional signal is used to synchronize transfers on the slave SMBus.
SSMBDAT	I/O	<b>Slave SMBus Data.</b> This bidirectional signal is used for data on the slave SMBus.

Table 4 SMBus Interface Pins

Signal	Type	Name/Description
GPIO[0]	I/O	General Purpose I/O. This pin can be configured as a general purpose I/O pin. 1st Alternate function pin name: PART0PERSTN 1st Alternate function pin type: Input/Output 1st Alternate function: Assertion of this signal initiated a partition fundamental reset in the corresponding partition. 2nd Alternate function pin name: P16LINKUPN 2nd Alternate function pin type: Output 2nd Alternate function: Port 16 Link Up Status output.
GPIO[1]	I/O	General Purpose I/O. This pin can be configured as a general purpose I/O pin. 1st Alternate function pin name: PART1PERSTN 1st Alternate function pin type: Input/Output 1st Alternate function: Assertion of this signal initiated a partition fundamental reset in the corresponding partition. 2nd Alternate function pin name: P16ACTIVEN 2nd Alternate function pin type: Output 2nd Alternate function: Port 16 Link Active Status Output.
GPIO[2]	I/O	General Purpose I/O. This pin can be configured as a general purpose I/O pin. 1st Alternate function pin name: PART2PERSTN 1st Alternate function pin type: Input/Output 1st Alternate function: Assertion of this signal initiated a partition fundamental reset in the corresponding partition. 2nd Alternate function pin name: P4LINKUPN 2nd Alternate function pin type: Output 2nd Alternate function: Port 4 Link Up Status output.
GPIO[3]	I/O	General Purpose I/O. This pin can be configured as a general purpose I/O pin. 1st Alternate function pin name: PART3PERSTN 1st Alternate function pin type: Input/Output 1st Alternate function: Assertion of this signal initiated a partition fundamental reset in the corresponding partition. 2nd Alternate function pin name: P4ACTIVEN 2nd Alternate function pin type: Output 2nd Alternate function: Port 4 Link Active Status Output.
GPIO[4]	I/O	General Purpose I/O. This pin can be configured as a general purpose I/O pin. 1st Alternate function pin name: FAILOVER0 1st Alternate function pin type: Input 1st Alternate function: When this signal changes state and the corresponding failover capability is enabled, a failover event is signaled. 2nd Alternate function pin name: POLINKUPN 2nd Alternate function pin type: Output 2nd Alternate function: Port 0 Link Up Status output.
GPIO[5]	I/O	General Purpose I/O. This pin can be configured as a general purpose I/O pin. 1st Alternate function pin name: GPEN 1st Alternate function pin type: Output 1st Alternate function: Hot-plug general purpose even output. 2nd Alternate function pin name: POACTIVEN 2nd Alternate function pin type: Output 2nd Alternate function: Port 0 Link Active Status Output.

Table 5 General Purpose I/O Pins (Part 1 of 2)



Signal	Type	Name/Description
GPIO[6]	I/O	General Purpose I/O. This pin can be configured as a general purpose I/O pin. 1st Alternate function pin name: FAILOVER1 1st Alternate function pin type: Input 1st Alternate function: When this signal changes state and the corresponding failover capability is enabled, a failover event is signaled. 2nd Alternate function pin name: FAILOVER3 2nd Alternate function pin type: Input 2nd Alternate function: When this signal changes state and the corresponding failover capability is enabled, a failover event is signaled.
GPIO[7]	I/O	General Purpose I/O. This pin can be configured as a general purpose I/O pin. 1st Alternate function pin name: FAILOVER2 1st Alternate function pin type: Input 1st Alternate function: When this signal changes state and the corresponding failover capability is enabled, a failover event is signaled. 2nd Alternate function pin name: P8LINKUPN 2nd Alternate function pin type: Output 2nd Alternate function: Port 8 Link Up Status output.
GPIO[8]	I/O	General Purpose I/O. This pin can be configured as a general purpose I/O pin. 1st Alternate function pin name: IOEXPINTN 1st Alternate function pin type: Input 1st Alternate function: IO expander interrupt. 2nd Alternate function pin name: P8ACTIVEN 2nd Alternate function pin type: Output 2nd Alternate function: Port 8 Link Active Status Output.

Table 5 General Purpose I/O Pins (Part 2 of 2)

Signal	Type	Name/Description
STK2CFG[4:0]	I	<b>Stack 2 Configuration.</b> These pins select the configuration of stack 2.
STK3CFG[4:0]	I	<b>Stack 3 Configuration.</b> These pins select the configuration of stack 3.

Table 6 Stack Configuration Pins

Signal	Type	Name/Description
CLKMODE[1:0]	I	<b>Clock Mode.</b> These signals determine the port clocking mode used by ports of the device.
GCLKFSEL	I	<b>Global Clock Frequency Select.</b> These signals select the frequency of the GCLKP and GCLKN signals. 0x0 100 MHz 0x1 125 MHz

Table 7 System Pins (Part 1 of 2)

Signal	Type	Name/Description
PERSTN	I	<b>Fundamental Reset.</b> Assertion of this signal resets all logic inside the device.
RSTHALT	I	<b>Reset Halt.</b> When this signal is asserted during a switch fundamental reset sequence, the switch remains in a quasi-reset state with the Master and Slave SMBuses active. This allows software to read and write registers internal to the device before normal device operation begins. The device exits the quasi-reset state when the RSTHALT bit is cleared in the SWCTL register by an SMBus master.
SWMODE[3:0]	I	<b>Switch Mode.</b> These configuration pins determine the switch operating mode. These pins should be static and not change following the negation of PERSTN. 0x0 - Single partition 0x1 - Single partition with Serial EEPROM initialization 0x2 - Single partition with Serial EEPROM Jump 0 initialization 0x3 - Single partition with Serial EEPROM Jump 1 initialization 0x4 through 0x7 - Reserved 0x8 - Single partition with reduced latency 0x9 - Single partition with Serial EEPROM initialization and reduced latency 0xA - Multi-partition with Unattached ports 0xB - Multi-partition with Unattached ports and I <sup>2</sup> C Reset 0xC - Multi-partition with Unattached ports and Serial EEPROM initialization 0xD - Multi-partition with Unattached ports with I <sup>2</sup> C Reset and Serial EEPROM initialization 0xE - Multi-partition with Disabled ports 0xF - Multi-partition with Disabled ports and Serial EEPROM initialization

Table 7 System Pins (Part 2 of 2)

Signal	Type	Name/Description
JTAG_TCK	I	<b>JTAG Clock.</b> This is an input test clock used to clock the shifting of data into or out of the boundary scan logic or JTAG Controller. JTAG_TCK is independent of the system clock with a nominal 50% duty cycle.
JTAG_TDI	I	<b>JTAG Data Input.</b> This is the serial data input to the boundary scan logic or JTAG Controller.
JTAG_TDO	O	<b>JTAG Data Output.</b> This is the serial data shifted out from the boundary scan logic or JTAG Controller. When no data is being shifted out, this signal is tri-stated.
JTAG_TMS	I	<b>JTAG Mode.</b> The value on this signal controls the test mode select of the boundary scan logic or JTAG Controller.
JTAG_TRST_N	I	<b>JTAG Reset.</b> This active low signal asynchronously resets the boundary scan logic and JTAG TAP Controller. An external pull-up on the board is recommended to meet the JTAG specification in cases where the tester can access this signal. However, for systems running in functional mode, one of the following should occur: 1) actively drive this signal low with control logic 2) statically drive this signal low with an external pull-down on the board

Table 8 Test Pins

Signal	Type	Name/Description
REFRES[7:0]	—	<b>External Reference Resistor.</b> Reference for the corresponding SerDes bias currents and PLL calibration circuitry. A 3K Ohm +/- 1% resistor should be connected from this pin to ground and isolated from any source of noise injection. Each bit of this signal corresponds to a SerDes quad, e.g., REFRES[5] is the reference resistor for SerDes quad 5.
REFRESPLL	—	<b>PLL External Reference Resistor.</b> Provides a reference for the PLL bias currents and PLL calibration circuitry. A 3K Ohm +/- 1% resistor should be connected from this pin to ground and isolated from any source of noise injection.
V <sub>DD</sub> CORE	—	<b>Core V<sub>DD</sub>.</b> Power supply for core logic (1.0V).
V <sub>DD</sub> I/O	—	<b>I/O V<sub>DD</sub>.</b> LVTTTL I/O buffer power supply (3.3V).
V <sub>DD</sub> PEA	—	<b>PCI Express Analog Power.</b> Serdes analog power supply (1.0V).
V <sub>DD</sub> PEHA	—	<b>PCI Express Analog High Power.</b> Serdes analog power supply (2.5V).
V <sub>DD</sub> PETA	—	<b>PCI Express Transmitter Analog Voltage.</b> Serdes transmitter analog power supply (1.0V).
V <sub>SS</sub>	—	<b>Ground.</b>

Table 9 Power, Ground, and SerDes Resistor Pins

## Pin Characteristics

**Note:** Some input pads of the switch do not contain internal pull-ups or pull-downs. Unused SMBus and System inputs should be tied off to appropriate levels. This is especially critical for unused control signal inputs which, if left floating, could adversely affect operation. Also, floating pins can cause a slight increase in power consumption. Unused Serdes (Rx and Tx) pins should be left floating. Finally, No Connection pins should not be connected.

Function	Pin Name	Type	Buffer	I/O Type	Internal Resistor <sup>1</sup>	Notes
PCI Express Interface	PE00RN[0]	I	PCIe differential <sup>2</sup>	Serial Link		Note: Unused SerDes pins can be left floating
	PE00RP[0]	I				
	PE00TN[0]	O				
	PE00TP[0]	O				
	PE01RN[0]	I				
	PE01RP[0]	I				
	PE01TN[0]	O				
	PE01TP[0]	O				
	PE02RN[0]	I				
	PE02RP[0]	I				
	PE02TN[0]	O				
	PE02TP[0]	O				
	PE03RN[0]	I				

Table 10 Pin Characteristics (Part 1 of 5)

Function	Pin Name	Type	Buffer	I/O Type	Internal Resistor <sup>1</sup>	Notes
PCI Express Interface (cont.)	PE03RP[0]	I	PCIe differential	Serial Link		
	PE03TN[0]	O				
	PE03TP[0]	O				
	PE04RN[0]	I				
	PE04RP[0]	I				
	PE04TN[0]	O				
	PE04TP[0]	O				
	PE05RN[0]	I				
	PE05RP[0]	I				
	PE05TN[0]	O				
	PE05TP[0]	O				
	PE06RN[0]	I				
	PE06RP[0]	I				
	PE06TN[0]	O				
	PE06TP[0]	O				
	PE07RN[0]	I				
	PE07RP[0]	I				
	PE07TN[0]	O				
	PE07TP[0]	O				
	PE08RN[0]	I				
	PE08RP[0]	I				
	PE08TN[0]	O				
	PE08TP[0]	O				
	PE09RN[0]	I				
	PE09RP[0]	I				
	PE09TN[0]	O				
	PE09TP[0]	O				
	PE10RN[0]	I				
	PE10RP[0]	I				
	PE10TN[0]	O				
	PE10TP[0]	O				
	PE11RN[0]	I				
PE11RP[0]	I					
PE11TN[0]	O					
PE11TP[0]	O					
PE12RN[0]	I					
PE12RP[0]	I					

Table 10 Pin Characteristics (Part 2 of 5)

Function	Pin Name	Type	Buffer	I/O Type	Internal Resistor <sup>1</sup>	Notes
PCI Express Interface (cont.)	PE12TN[0]	0	PCIe differential	Serial Link		
	PE12TP[0]	0				
	PE13RN[0]	1				
	PE13RP[0]	1				
	PE13TN[0]	0				
	PE13TP[0]	0				
	PE14RN[0]	1				
	PE14RP[0]	1				
	PE14TN[0]	0				
	PE14TP[0]	0				
	PE15RN[0]	1				
	PE15RP[0]	1				
	PE15TN[0]	0				
	PE15TP[0]	0				
	PE16RN[0]	1				
	PE16RP[0]	1				
	PE16TN[0]	0				
	PE16TP[0]	0				
	PE17RN[0]	1				
	PE17RP[0]	1				
	PE17TN[0]	0				
	PE17TP[0]	0				
	PE18RN[0]	1				
	PE18RP[0]	1				
	PE18TN[0]	0				
	PE18TP[0]	0				
	PE19RN[0]	1				
	PE19RP[0]	1				
	PE19TN[0]	0				
	PE19TP[0]	0				
	PE20RN[0]	1				
	PE20RP[0]	1				
PE20TN[0]	0					
PE20TP[0]	0					
PE21RN[0]	1					
PE21RP[0]	1					

Table 10 Pin Characteristics (Part 3 of 5)

Function	Pin Name	Type	Buffer	I/O Type	Internal Resistor <sup>1</sup>	Notes
PCI Express Interface (cont.)	PE21TN[0]	O	PCIe differential	Serial Link		
	PE21TP[0]	O				
	PE22RN[0]	I				
	PE22RP[0]	I				
	PE22TN[0]	O				
	PE22TP[0]	O				
	PE23RN[0]	I				
	PE23RP[0]	I				
	PE23TN[0]	O				
	PE23TP[0]	O				
Reference Clocks	GCLKN[1:0]	I	HCSL	Diff. Clock Input		Refer to <a href="#">Table 11</a>  Note: Unused port clock pins should be connected to Vss on the board.
	GCLKP[1:0]	I				
	P08CLKN	I				
	P08CLKP	I				
	P16CLKN	I				
	P16CLKP	I				
SMBus	MSMBCLK	I/O	LVTTTL	STI <sup>3</sup>	pull-up	Note: When unused, these signals must be pulled up on the board using an external resistor or current source in accordance with the SMBus specification.  Note: When unused, these signals must be pulled up on the board using an external resistor or current source in accordance with the SMBus specification.
	MSMBDAT	I/O		STI		
	SSMBADDR[2,1]	I				
	SSMBCLK	I/O		STI		
	SSMBDAT	I/O		STI		
General Purpose I/O	GPIO[8:0]	I/O	LVTTTL	STI, High Drive	pull-up	Unused pins can be left floating.
Stack Configuration	STK2CFG[4:0]	I	LVTTTL	Input	pull-down	Unused pins can be left floating.
	STK3CFG[4:0]	I			pull-down	
System Pins	CLKMODE[1:0]	I	LVTTTL	Input	pull-up	Unused pins can be left floating.
	GCLKFSEL	I			pull-down	
	PERSTN	I				Schmitt trigger
	RSTHALT	I			pull-down	Unused pins can be left floating.
	SWMODE[3:0]	I			pull-down	

Table 10 Pin Characteristics (Part 4 of 5)

Function	Pin Name	Type	Buffer	I/O Type	Internal Resistor <sup>1</sup>	Notes
EJTAG / JTAG	JTAG_TCK	I	LVTTTL	STI	pull-up	Unused pins can be left floating.
	JTAG_TDI	I		STI	pull-up	
	JTAG_TDO	O				
	JTAG_TMS	I		STI	pull-up	
	JTAG_TRST_N	I		STI	pull-up	
SerDes Reference Resistors	REFRES[7:0]	—	Analog			Unused pins should be connected to Vss on the board.
	REFRESPLL	—				

Table 10 Pin Characteristics (Part 5 of 5)

<sup>1</sup> Internal resistor values under typical operating conditions are 92K  $\Omega$  for pull-up and 91K  $\Omega$  for pull-down.

<sup>2</sup> All receiver pins set the DC common mode voltage to ground. All transmitters must be AC coupled to the media.

<sup>3</sup> Schmitt Trigger Input (STI).

# Logic Diagram — PES24NT24G2

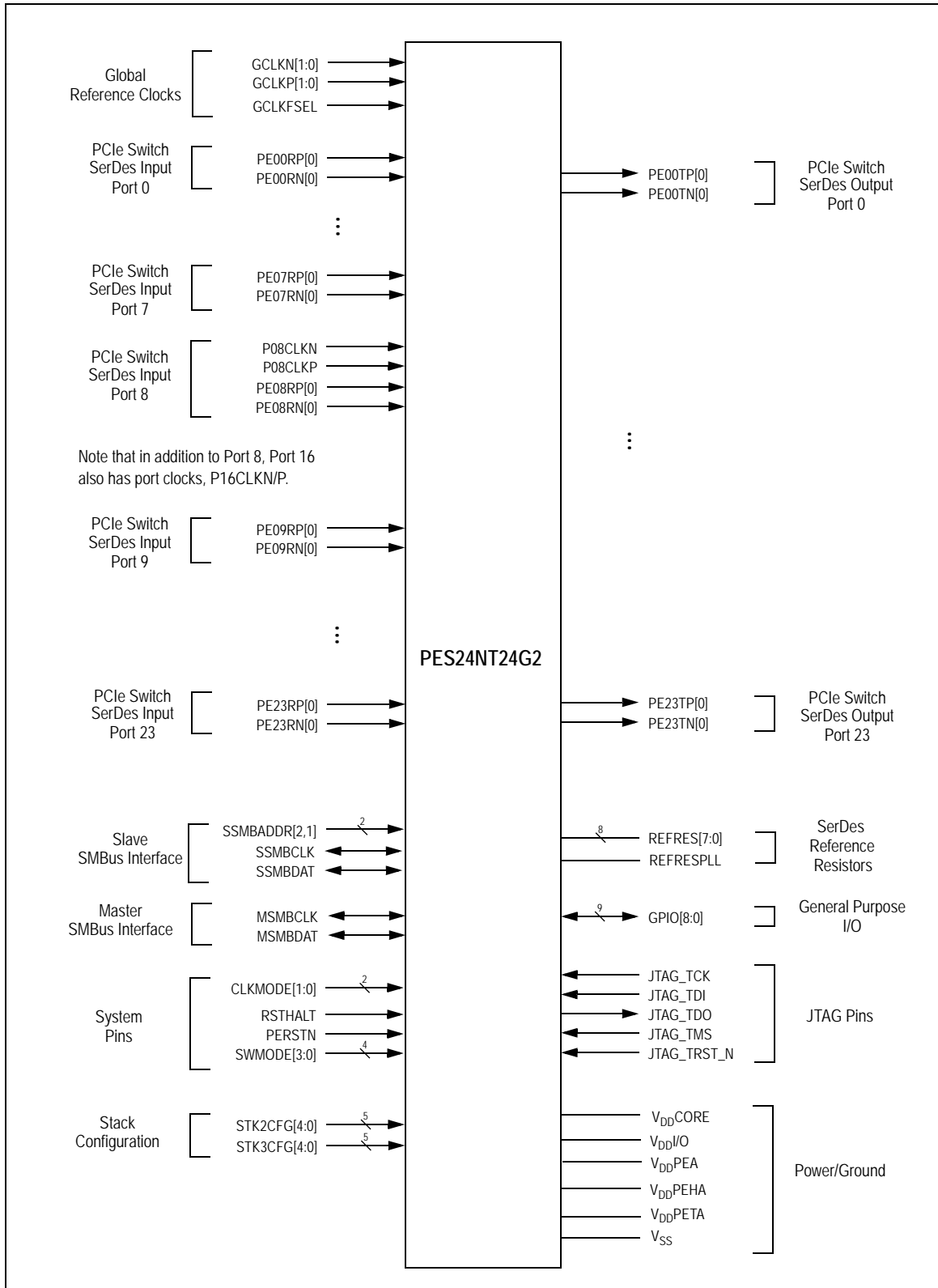

Figure 3 PES24NT24G2 Logic Diagram



## System Clock Parameters

Values based on systems running at recommended supply voltages and operating temperatures, as shown in Tables 16 and 15.

Parameter	Description	Condition	Min	Typical	Max	Unit
Refclk <sub>FREQ</sub>	Input reference clock frequency range		100		125 <sup>1</sup>	MHz
T <sub>C-RISE</sub>	Rising edge rate	Differential	0.6		4	V/ns
T <sub>C-FALL</sub>	Falling edge rate	Differential	0.6		4	V/ns
V <sub>IH</sub>	Differential input high voltage	Differential	+150			mV
V <sub>IL</sub>	Differential input low voltage	Differential			-150	mV
V <sub>CROSS</sub>	Absolute single-ended crossing point voltage	Single-ended	+250		+550	mV
V <sub>CROSS-DELTA</sub>	Variation of V <sub>CROSS</sub> over all rising clock edges	Single-ended			+140	mV
V <sub>RB</sub>	Ring back voltage margin	Differential	-100		+100	mV
T <sub>STABLE</sub>	Time before V <sub>RB</sub> is allowed	Differential	500			ps
T <sub>PERIOD-AVG</sub>	Average clock period accuracy		-300		2800	ppm
T <sub>PERIOD-ABS</sub>	Absolute period, including spread-spectrum and jitter		9.847		10.203	ns
T <sub>CC-JITTER</sub>	Cycle to cycle jitter				150	ps
V <sub>MAX</sub>	Absolute maximum input voltage				+1.15	V
V <sub>MIN</sub>	Absolute minimum input voltage		-0.3			V
Duty Cycle	Duty cycle		40		60	%
Rise/Fall Matching	Single ended rising Refclk edge rate versus falling Refclk edge rate			20		%
Z <sub>C-DC</sub>	Clock source output DC impedance		40		60	Ω

Table 11 Input Clock Requirements

<sup>1</sup> The input clock frequency will be either 100 or 125 MHz depending on signal GCLKFSEL.

**Note:** Refclk jitter compliant to PCIe Gen2 Common Clock architecture is adequate for the GCLKN/P[x] and PE[x]CLKN/P pins of this IDT PCIe switch. This same jitter specification is applicable when interfacing the switch to another IDT switch in a Separate (Non-Common) Clock architecture.

## AC Timing Characteristics

Parameter	Description	Gen 1			Gen 2			Units
		Min <sup>1</sup>	Typ <sup>1</sup>	Max <sup>1</sup>	Min <sup>1</sup>	Typ <sup>1</sup>	Max <sup>1</sup>	
PCIe Transmit								
UI	Unit Interval	399.88	400	400.12	199.94	200	200.06	ps
T <sub>TX-EYE</sub>	Minimum Tx Eye Width	0.75			0.75			UI
T <sub>TX-EYE-MEDIAN-to-MAX-JITTER</sub>	Maximum time between the jitter median and maximum deviation from the median			0.125				UI

Table 12 PCIe AC Timing Characteristics (Part 1 of 2)

Parameter	Description	Gen 1			Gen 2			Units
		Min <sup>1</sup>	Typ <sup>1</sup>	Max <sup>1</sup>	Min <sup>1</sup>	Typ <sup>1</sup>	Max <sup>1</sup>	
T <sub>TX-RISE</sub> , T <sub>TX-FALL</sub>	TX Rise/Fall Time: 20% - 80%	0.125			0.15			UI
T <sub>TX-IDLE-MIN</sub>	Minimum time in idle	20			20			UI
T <sub>TX-IDLE-SET-TO-IDLE</sub>	Maximum time to transition to a valid Idle after sending an Idle ordered set			8			8	ns
T <sub>TX-IDLE-TO-DIFF-DATA</sub>	Maximum time to transition from valid idle to diff data			8			8	ns
T <sub>TX-SKEW</sub>	Transmitter data skew between any 2 lanes			1.3			1.3	ns
T <sub>MIN-PULSED</sub>	Minimum Instantaneous Lone Pulse Width	NA			0.9			UI
T <sub>TX-HF-DJ-DD</sub>	Transmitter Deterministic Jitter > 1.5MHz Bandwidth	NA					0.15	UI
T <sub>RF-MISMATCH</sub>	Rise/Fall Time Differential Mismatch	NA					0.1	UI
PCIe Receive								
UI	Unit Interval	399.88	400	400.12	199.94		200.06	ps
T <sub>RX-EYE (with jitter)</sub>	Minimum Receiver Eye Width (jitter tolerance)	0.4			0.4			UI
T <sub>RX-EYE-MEDIUM TO MAX JITTER</sub>	Max time between jitter median & max deviation			0.3				UI
T <sub>RX-SKEW</sub>	Lane to lane input skew			20			8	ns
T <sub>RX-HF-RMS</sub>	1.5 — 100 MHz RMS jitter (common clock)	NA					3.4	ps
T <sub>RX-HF-DJ-DD</sub>	Maximum tolerable DJ by the receiver (common clock)	NA					88	ps
T <sub>RX-LF-RMS</sub>	10 KHz to 1.5 MHz RMS jitter (common clock)	NA					4.2	ps
T <sub>RX-MIN-PULSE</sub>	Minimum receiver instantaneous eye width	NA			0.6			UI

Table 12 PCIe AC Timing Characteristics (Part 2 of 2)

<sup>1</sup> Minimum, Typical, and Maximum values meet the requirements under PCI Express Base Specification 2.1.

Signal	Symbol	Reference Edge	Min	Max	Unit	Timing Diagram Reference
GPIO						
GPIO[8:0] <sup>1</sup>	Tpw_13b <sup>2</sup>	None	50	—	ns	See Figure 4.

Table 13 GPIO AC Timing Characteristics

<sup>1</sup> GPIO signals must meet the setup and hold times if they are synchronous or the minimum pulse width if they are asynchronous.

<sup>2</sup> The values for this symbol were determined by calculation, not by testing.

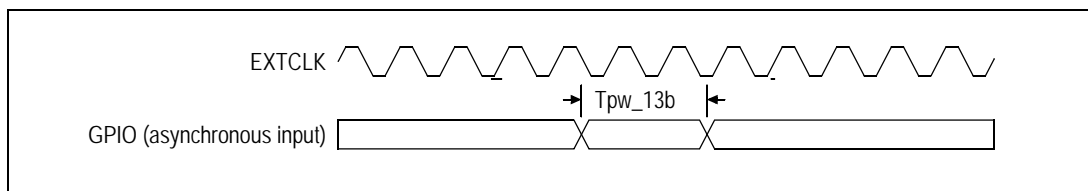

Figure 4 GPIO AC Timing Waveform

Signal	Symbol	Reference Edge	Min	Max	Unit	Timing Diagram Reference
<b>JTAG</b>						
JTAG_TCK	Tper_16a	none	50.0	—	ns	See <a href="#">Figure 5</a> .
	Thigh_16a, Tlow_16a		10.0	25.0	ns	
JTAG_TMS <sup>1</sup> , JTAG_TDI	Tsu_16b	JTAG_TCK rising	2.4	—	ns	
	Thld_16b		1.0	—	ns	
JTAG_TDO	Tdo_16c	JTAG_TCK falling	—	20	ns	
	Tdz_16c <sup>2</sup>		—	20	ns	
JTAG_TRST_N	Tpw_16d <sup>2</sup>	none	25.0	—	ns	

Table 14 JTAG AC Timing Characteristics

<sup>1</sup> The JTAG specification, IEEE 1149.1, recommends that JTAG\_TMS should be held at 1 while the signal applied at JTAG\_TRST\_N changes from 0 to 1. Otherwise, a race may occur if JTAG\_TRST\_N is deasserted (going from low to high) on a rising edge of JTAG\_TCK when JTAG\_TMS is low, because the TAP controller might go to either the Run-Test/Idle state or stay in the Test-Logic-Reset state.

<sup>2</sup> The values for this symbol were determined by calculation, not by testing.

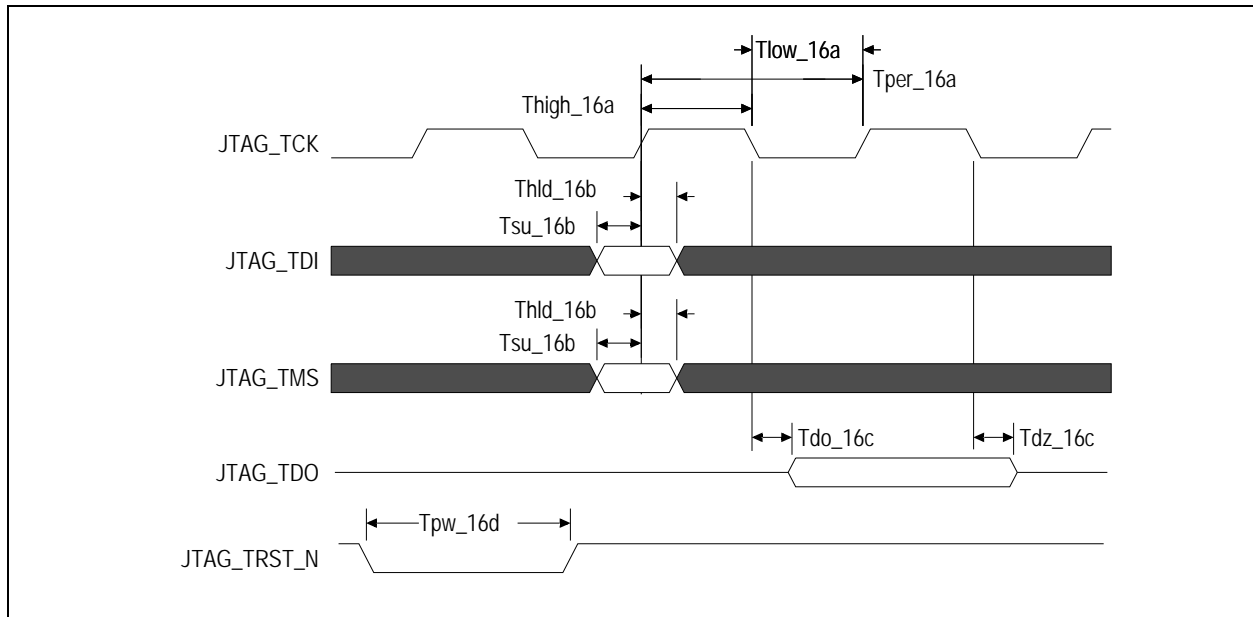

Figure 5 JTAG AC Timing Waveform

### Recommended Operating Temperature

Grade	Temperature
Commercial	0°C to +70°C Ambient
Industrial	-40°C to +85°C Ambient

Table 15 PES24NT24G2 Operating Temperatures

### Recommended Operating Supply Voltages — Commercial Temperature

Symbol	Parameter	Minimum	Typical	Maximum	Unit
V <sub>DD</sub> CORE	Internal logic supply	0.9	1.0	1.1	V
V <sub>DD</sub> I/O	I/O supply except for SerDes	3.125	3.3	3.465	V
V <sub>DD</sub> PEA <sup>1</sup>	PCI Express Analog Power	0.95	1.0	1.1	V
V <sub>DD</sub> PEHA <sup>2</sup>	PCI Express Analog High Power	2.25	2.5	2.75	V
V <sub>DD</sub> PETA <sup>1</sup>	PCI Express Transmitter Analog Voltage	0.95	1.0	1.1	V
V <sub>SS</sub>	Common ground	0	0	0	V

Table 16 PES24NT24G2 Operating Voltages — Commercial Temperature

<sup>1</sup>: V<sub>DD</sub>PEA and V<sub>DD</sub>PETA should have no more than 25mV<sub>peak-peak</sub> AC power supply noise superimposed on the 1.0V nominal DC value.

<sup>2</sup>: V<sub>DD</sub>PEHA should have no more than 50mV<sub>peak-peak</sub> AC power supply noise superimposed on the 2.5V nominal DC value.

## Recommended Operating Supply Voltages — Industrial Temperature

Symbol	Parameter	Minimum	Typical	Maximum	Unit
V <sub>DD</sub> CORE	Internal logic supply	0.9	1.0	1.1	V
V <sub>DD</sub> I/O	I/O supply except for SerDes	3.125	3.3	3.465	V
V <sub>DD</sub> PEA <sup>1</sup>	PCI Express Analog Power	0.95	1.0	1.05	V
V <sub>DD</sub> PEHA <sup>2</sup>	PCI Express Analog High Power	2.25	2.5	2.75	V
V <sub>DD</sub> PETA <sup>1</sup>	PCI Express Transmitter Analog Voltage	0.95	1.0	1.1	V
V <sub>SS</sub>	Common ground	0	0	0	V

Table 17 PES24NT24G2 Operating Voltages — Industrial Temperature

<sup>1</sup> V<sub>DD</sub>PEA and V<sub>DD</sub>PETA should have no more than 25mV<sub>peak-peak</sub> AC power supply noise superimposed on the 1.0V nominal DC value.

<sup>2</sup> V<sub>DD</sub>PEHA should have no more than 50mV<sub>peak-peak</sub> AC power supply noise superimposed on the 2.5V nominal DC value.

## Power-Up/Power-Down Sequence

During power supply ramp-up, V<sub>DD</sub>CORE must remain at least 1.0V below V<sub>DD</sub>I/O at all times. There are no other power-up sequence requirements for the various operating supply voltages.

The power-down sequence can occur in any order.

## Power Consumption

Typical power is measured under the following conditions: 25°C Ambient, 35% total link usage on all ports, typical voltages defined in Table 16 (and also listed below).

Maximum power is measured under the following conditions: 70°C Ambient, 85% total link usage on all ports, maximum voltages defined in Table 16 (and also listed below).

Number of Active Lanes per Port		Core Supply		PCIe Analog Supply		PCIe Analog High Supply		PCIe Transmitter Supply		I/O Supply		Total	
		Typ 1.0V	Max 1.1V	Typ 1.0V	Max 1.1V	Typ 2.5V	Max 2.75V	Typ 1.0V	Max 1.1V	Typ 3.3V	Max 3.465	Typ Power	Max Power
x8/x8/x1/x1/x1/x1/x1/x1/x1/x1/x1/x1/ (Full Swing)	mA	2540	3400	1384	1570	184	205	578	699	3	5		
	Watts	2.54	3.74	1.38	1.73	0.46	0.56	0.58	0.77	0.01	0.02	4.97	6.82
x8/x8/x1/x1/x1/x1/x1/x1/x1/x1/x1/x1/ (Half Swing)	mA	2540	3400	1190	1350	184	205	301	364	3	5		
	Watts	2.54	3.74	1.19	1.49	0.46	0.56	0.30	0.40	0.01	.02	4.50	6.21

Table 18 PES24NT24G2 Power Consumption

**Note 1:** The above power consumption assumes that all ports are functioning at Gen2 (5.0 GT/S) speeds. Power consumption can be reduced by turning off unused ports through software or through boot EEPROM. Power savings will occur in V<sub>DD</sub>PEA, V<sub>DD</sub>PEHA, and V<sub>DD</sub>PETA. Power savings can be estimated as directly proportional to the number of unused ports, since the power consumption of a turned-off port is close to zero. For example, if 3 ports out of 16 are turned off, then the power savings for each of the above three power rails can be calculated quite simply as 3/16 multiplied by the power consumption indicated in the above table.

**Note 2:** Using a port in Gen1 mode (2.5GT/S) results in approximately 18% power savings for each power rail: V<sub>DD</sub>PEA, V<sub>DD</sub>PEHA, and V<sub>DD</sub>PETA.

## Thermal Considerations

This section describes thermal considerations for the PES24NT24G2 (19mm<sup>2</sup> FCBGA324 package). The data in [Table 19](#) below contains information that is relevant to the thermal performance of the PES24NT24G2 switch.

Symbol	Parameter	Value	Units	Conditions
$T_{J(max)}$	Junction Temperature	125	°C	Maximum
$T_{A(max)}$	Ambient Temperature	70	°C	Maximum for commercial-rated products
		85	°C	Maximum for industrial-rated products
$\theta_{JA(effective)}$	Effective Thermal Resistance, Junction-to-Ambient	16.8	°C/W	Zero air flow
		10.1	°C/W	1 m/S air flow
		9.2	°C/W	2 m/S air flow
$\theta_{JB}$	Thermal Resistance, Junction-to-Board	4.1	°C/W	
$\theta_{JC}$	Thermal Resistance, Junction-to-Case	0.3	°C/W	
P	Power Dissipation of the Device	6.82	Watts	Maximum

**Table 19 Thermal Specifications for PES24NT24G2, 19x19 mm FCBGA324 Package**

**Note:** It is important for the reliability of this device in any user environment that the junction temperature not exceed the  $T_{J(max)}$  value specified in [Table 19](#). Consequently, the effective junction to ambient thermal resistance ( $\theta_{JA}$ ) for the worst case scenario must be maintained below the value determined by the formula:

$$\theta_{JA} = (T_{J(max)} - T_{A(max)})/P$$

Given that the values of  $T_{J(max)}$ ,  $T_{A(max)}$ , and P are known, the value of desired  $\theta_{JA}$  becomes a known entity to the system designer. How to achieve the desired  $\theta_{JA}$  is left up to the board or system designer, but in general, it can be achieved by adding the effects of  $\theta_{JC}$  (value provided in [Table 19](#)), thermal resistance of the chosen adhesive ( $\theta_{CS}$ ), that of the heat sink ( $\theta_{SA}$ ), amount of airflow, and properties of the circuit board (number of layers and size of the board). It is strongly recommended that users perform their own thermal analysis for their own board and system design scenarios.

## DC Electrical Characteristics

Values based on systems running at recommended supply voltages, as shown in [Table 16](#).

**Note:** See [Table 10](#), Pin Characteristics, for a complete I/O listing.

I/O Type	Parameter	Description	Gen1			Gen2			Unit	Condi- tions
			Min <sup>1</sup>	Typ <sup>1</sup>	Max <sup>1</sup>	Min <sup>1</sup>	Typ <sup>1</sup>	Max <sup>1</sup>		
Serial Link	PCIe Transmit									
	$V_{TX-DIFFp-p}$	Differential peak-to-peak output voltage	800		1200	800		1200	mV	
	$V_{TX-DIFFp-p-LOW}$	Low-Drive Differential Peak to Peak Output Voltage	400		1200	400		1200	mV	
	$V_{TX-DE-RATIO-3.5dB}$	De-emphasized differential output voltage	-3		-4	-3.0	-3.5	-4.0	dB	
	$V_{TX-DE-RATIO-6.0dB}$	De-emphasized differential output voltage	NA			-5.5	-6.0	-6.5	dB	
	$V_{TX-DC-CM}$	DC Common mode voltage	0		3.6	0		3.6	V	
	$V_{TX-CM-ACP}$	RMS AC peak common mode output voltage			20				mV	
	$V_{TX-CM-DC-active-idle-delta}$	Abs delta of DC common mode voltage between L0 and idle			100			100	mV	
	$V_{TX-CM-DC-line-delta}$	Abs delta of DC common mode voltage between D+ and D-			25			25	mV	
	$V_{TX-Idle-DiffP}$	Electrical idle diff peak output			20			20	mV	
	$RL_{TX-DIFF}$	Transmitter Differential Return loss	10					10	dB	0.05 - 1.25GHz
									8	dB
	$RL_{TX-CM}$	Transmitter Common Mode Return loss	6					6	dB	
	$Z_{TX-DIFF-DC}$	DC Differential TX impedance	80	100	120			120	$\Omega$	
	$V_{TX-CM-ACpp}$	Peak-Peak AC Common	NA					100	mV	
	$V_{TX-DC-CM}$	Transmit Driver DC Common Mode Voltage	0		3.6	0		3.6	V	
$V_{TX-RCV-DETECT}$	The amount of voltage change allowed during Receiver Detection			600			600	mV		
$I_{TX-SHORT}$	Transmitter Short Circuit Current Limit	0		90				90	mA	

Table 20 DC Electrical Characteristics (Part 1 of 3)

I/O Type	Parameter	Description	Gen1			Gen2			Unit	Condi- tions
			Min <sup>1</sup>	Typ <sup>1</sup>	Max <sup>1</sup>	Min <sup>1</sup>	Typ <sup>1</sup>	Max <sup>1</sup>		
Serial Link (cont.)	PCIe Receive									
	$V_{RX-DIFFp-p}$	Differential input voltage (peak-to-peak)	175		1200	120		1200	mV	
	$RL_{RX-DIFF}$	Receiver Differential Return Loss	10					10	dB	0.05 - 1.25GHz
								8		1.25 - 2.5GHz
	$RL_{RX-CM}$	Receiver Common Mode Return Loss	6					6	dB	
	$Z_{RX-DIFF-DC}$	Differential input impedance (DC)	80	100	120	Refer to return loss spec			$\Omega$	
	$Z_{RX-DC}$	DC common mode impedance	40	50	60	40		60	$\Omega$	
	$Z_{RX-COMM-DC}$	Powered down input common mode impedance (DC)	200k	350k				50k	$\Omega$	
	$Z_{RX-HIGH-IMP-DC-POS}$	DC input CM input impedance for $V > 0$ during reset or power down			50k			50k	$\Omega$	
	$Z_{RX-HIGH-IMP-DC-NEG}$	DC input CM input impedance for $V < 0$ during reset or power down			1.0k			1.0k	$\Omega$	
$V_{RX-IDLE-DET-DIFFp-p}$	Electrical idle detect threshold	65		175	65		175	mV		
$V_{RX-CM-ACp}$	Receiver AC common-mode peak voltage			150			150	mV	$V_{RX-CM-ACp}$	
PCIe REFCLK										
	$C_{IN}$	Input Capacitance	1.5	—		1.5	—		pF	
Other I/Os										
LOW Drive Output	$I_{OL}$		—	2.5	—	—	2.5	—	mA	$V_{OL} = 0.4v$
	$I_{OH}$		—	-5.5	—	—	-5.5	—	mA	$V_{OH} = 1.5V$
High Drive Output	$I_{OL}$		—	12.0	—	—	12.0	—	mA	$V_{OL} = 0.4v$
	$I_{OH}$		—	-20.0	—	—	-20.0	—	mA	$V_{OH} = 1.5V$
Schmitt Trigger Input (STI)	$V_{IL}$		-0.3	—	0.8	-0.3	—	0.8	V	—
	$V_{IH}$		2.0	—	$V_{DD}/O + 0.5$	2.0	—	$V_{DD}/O + 0.5$	V	—
Input	$V_{IL}$		-0.3	—	0.8	-0.3	—	0.8	V	—
	$V_{IH}$		2.0	—	$V_{DD}/O + 0.5$	2.0	—	$V_{DD}/O + 0.5$	V	—
3.3V Output Low Voltage	$V_{OL}$		—	—	0.4	—	—	0.4	V	$I_{OL} = 8mA$ for JTAG_TDO and GPIO pins
3.3V Output High Voltage	$V_{OH}$		2.4	—	—	2.4	—	—	V	$I_{OH} = 8mA$ for JTAG_TDO and GPIO pins

Table 20 DC Electrical Characteristics (Part 2 of 3)



I/O Type	Parameter	Description	Gen1			Gen2			Unit	Condi- tions
			Min <sup>1</sup>	Typ <sup>1</sup>	Max <sup>1</sup>	Min <sup>1</sup>	Typ <sup>1</sup>	Max <sup>1</sup>		
Capacitance	C <sub>IN</sub>		—	—	8.5	—	—	8.5	pF	—
Leakage	Inputs		—	—	± 10	—	—	± 10	μA	V <sub>DD</sub> /I/O (max)
	I/O <sub>LEAK</sub> w/o Pull-ups/downs		—	—	± 10	—	—	± 10	μA	V <sub>DD</sub> /I/O (max)
	I/O <sub>LEAK</sub> WITH Pull-ups/downs		—	—	± 80	—	—	± 80	μA	V <sub>DD</sub> /I/O (max)

Table 20 DC Electrical Characteristics (Part 3 of 3)

<sup>1</sup> Minimum, Typical, and Maximum values meet the requirements under PCI Express Base Specification 2.1.

### Absolute Maximum Voltage Rating

Core Supply	PCIe Analog Supply	PCIe Analog High Supply	PCIe Transmitter Supply	I/O Supply
1.5V	1.5V	4.6V	1.5V	4.6V

Table 21 PES24NT24G2 Absolute Maximum Voltage Rating

**Warning:** For proper and reliable operation in adherence with this data sheet, the device should not exceed the recommended operating voltages in Table 16. The absolute maximum operating voltages in Table 21 are offered to provide guidelines for voltage excursions outside the recommended voltage ranges. Device functionality is not guaranteed at these conditions and sustained operation at these values or any exposure to voltages outside the maximum range may adversely affect device functionality and reliability.

### SMBus Characterization

Symbol	Parameter	SMBus 2.0 Char. Data <sup>1</sup>			Unit
		3V	3.3V	3.6V	
DC Parameter for SDA Pin					
V <sub>IL</sub>	Input Low	1.16	1.26	1.35	V
V <sub>IH</sub>	Input High	1.56	1.67	1.78	V
V <sub>OL@350uA</sub>	Output Low	15	15	15	mV
I <sub>OL@0.4V</sub>		23	24	25	mA
I <sub>Pullup</sub>	Current Source	—	—	—	μA
I <sub>IL_Leak</sub>	Input Low Leakage	0	0	0	μA
I <sub>IH_Leak</sub>	Input High Leakage	0	0	0	μA

Table 22 SMBus DC Characterization Data (Part 1 of 2)

Symbol	Parameter	SMBus 2.0 Char. Data <sup>1</sup>			Unit
		3V	3.3V	3.6V	
<b>DC Parameter for SCL Pin</b>					
$V_{IL}$ (V)	Input Low	1.11	1.2	1.31	V
$V_{IH}$ (V)	Input High	1.54	1.65	1.76	V
$I_{IL\_Leak}$	Input Low Leakage	0	0	0	$\mu$ A
$I_{IH\_Leak}$	Input High Leakage	0	0	0	$\mu$ A

Table 22 SMBus DC Characterization Data (Part 2 of 2)

<sup>1</sup>: Data at room and hot temperature.

Symbol	Parameter	SMBus @3.3V $\pm$ 10% <sup>1</sup>		Unit
		Min	Max	
$F_{SCL}$	Clock frequency	5	600	KHz
$T_{BUF}$	Bus free time between Stop and Start	3.5	—	$\mu$ s
$T_{HD:STA}$	Start condition hold time	1	—	$\mu$ s
$T_{SU:STA}$	Start condition setup time	1	—	$\mu$ s
$T_{SU:STO}$	Stop condition setup time	1	—	$\mu$ s
$T_{HD:DAT}$	Data hold time	1	—	ns
$T_{SU:DAT}$	Data setup time	1	—	ns
$T_{TIMEOUT}$	Detect clock low time out	—	74.7	ms
$T_{LOW}^2$	Clock low period	3.7	—	$\mu$ s
$T_{HIGH}^2$	Clock high period	3.7	—	$\mu$ s
$T_F$	Clock/Data fall time	—	72.2	ns
$T_R$	Clock/Data rise time	—	68.3	ns
$T_{POR@10kHz}$	Time which a device must be operational after power-on reset	20	—	ms

Table 23 SMBus AC Timing Data

<sup>1</sup>: Data at room and hot temperature.

<sup>2</sup>:  $T_{LOW}$  and  $T_{HIGH}$  are measured at  $F_{SCL} = 135$  kHz.

## Package Pinout — 324-BGA Signal Pinout for the PES24NT24G2

The following table lists the pin numbers and signal names for the PES24NT24G2 device. Note: Pins labeled NC are No Connection.

Pin	Function	Alt.	Pin	Function	Alt.	Pin	Function	Alt.
A1	V <sub>SS</sub>		B9	PE07TN0		C17	SSMBDAT	
A2	PE08TP0		B10	PE06TN0		C18	SSMBCLK	
A3	PE08TN0		B11	V <sub>SS</sub>		D1	P08CLKP	
A4	V <sub>DD</sub> I/O		B12	GCLKN0		D2	P08CLKN	
A5	STK3CFG3		B13	V <sub>SS</sub>		D3	V <sub>SS</sub>	
A6	V <sub>DD</sub> I/O		B14	NC		D4	V <sub>SS</sub>	
A7	V <sub>DD</sub> I/O		B15	PE05TN0		D5	STK2CFG4	
A8	V <sub>SS</sub>		B16	PE04TN0		D6	STK2CFG3	
A9	PE07TP0		B17	JTAG_TDO		D7	PE07RP0	
A10	PE06TP0		B18	MSMBCLK		D8	PE06RP0	
A11	V <sub>SS</sub>		C1	V <sub>SS</sub>		D9	V <sub>SS</sub>	
A12	GCLKP0		C2	V <sub>SS</sub>		D10	V <sub>SS</sub>	
A13	V <sub>SS</sub>		C3	PE09RN0		D11	V <sub>DD</sub> PEHA	
A14	V <sub>SS</sub>		C4	PE09RP0		D12	V <sub>DD</sub> PEHA	
A15	PE05TP0		C5	STK2CFG1		D13	PE05RP0	
A16	PE04TP0		C6	STK3CFG1		D14	PE04RP0	
A17	V <sub>DD</sub> I/O		C7	PE07RN0		D15	JTAG_TMS	
A18	V <sub>DD</sub> I/O		C8	PE06RN0		D16	MSMBDAT	
B1	PE09TP0		C9	REFRES03		D17	JTAG_TCK	
B2	PE09TN0		C10	REFRESPLL		D18	V <sub>SS</sub>	
B3	V <sub>SS</sub>		C11	V <sub>DD</sub> PEHA		E1	V <sub>SS</sub>	
B4	PE08RN0		C12	REFRES02		E2	V <sub>SS</sub>	
B5	PE08RP0		C13	PE05RN0		E3	PE10RN0	
B6	STK2CFG2		C14	PE04RN0		E4	PE10RP0	
B7	STK3CFG2		C15	CLKMODE1		E5	STK3CFG4	
B8	V <sub>DD</sub> I/O		C16	JTAG_TRST_N		E6	V <sub>DD</sub> PEA	

Table 24 PES24NT24G2 324-Pin Signal Pin-Out (Part 1 of 5)

Pin	Function	Alt.	Pin	Function	Alt.	Pin	Function	Alt.
E7	V <sub>DD</sub> PEA		F15	SSMBADDR2		H5	V <sub>DD</sub> PEHA	
E8	V <sub>DD</sub> PEA		F16	V <sub>SS</sub>		H6	V <sub>SS</sub>	
E9	V <sub>DD</sub> PETA		F17	PE02TN0		H7	V <sub>DD</sub> CORE	
E10	V <sub>DD</sub> PETA		F18	PE02TP0		H8	V <sub>SS</sub>	
E11	V <sub>DD</sub> PEA		G1	PE10TP0		H9	V <sub>DD</sub> CORE	
E12	V <sub>DD</sub> PEA		G2	PE10TN0		H10	V <sub>SS</sub>	
E13	V <sub>DD</sub> PEA		G3	V <sub>SS</sub>		H11	V <sub>DD</sub> CORE	
E14	PERSTN		G4	V <sub>SS</sub>		H12	V <sub>DD</sub> CORE	
E15	JTAG_TDI		G5	V <sub>DD</sub> PEHA		H13	V <sub>SS</sub>	
E16	V <sub>SS</sub>		G6	V <sub>DD</sub> PEA		H14	V <sub>DD</sub> PETA	
E17	PE03TN0		G7	V <sub>DD</sub> CORE		H15	PE02RP0	
E18	PE03TP0		G8	V <sub>SS</sub>		H16	PE02RN0	
F1	V <sub>SS</sub>		G9	V <sub>DD</sub> CORE		H17	V <sub>SS</sub>	
F2	V <sub>SS</sub>		G10	V <sub>SS</sub>		H18	V <sub>SS</sub>	
F3	PE11RN0		G11	V <sub>DD</sub> CORE		J1	V <sub>SS</sub>	
F4	PE11RP0		G12	V <sub>SS</sub>		J2	V <sub>SS</sub>	
F5	V <sub>DD</sub> PEHA		G13	V <sub>DD</sub> PEA		J3	PE12RN0	
F6	V <sub>DD</sub> PEA		G14	V <sub>SS</sub>		J4	PE12RP0	
F7	V <sub>DD</sub> CORE		G15	PE03RP0		J5	V <sub>DD</sub> PETA	
F8	V <sub>SS</sub>		G16	PE03RN0		J6	V <sub>SS</sub>	
F9	V <sub>DD</sub> CORE		G17	REFRES01		J7	V <sub>DD</sub> CORE	
F10	V <sub>DD</sub> PETA		G18	V <sub>SS</sub>		J8	V <sub>SS</sub>	
F11	V <sub>DD</sub> CORE		H1	PE11TP0		J9	V <sub>DD</sub> CORE	
F12	V <sub>SS</sub>		H2	PE11TN0		J10	V <sub>SS</sub>	
F13	V <sub>DD</sub> PEA		H3	V <sub>SS</sub>		J11	V <sub>DD</sub> CORE	
F14	V <sub>SS</sub>		H4	REFRES04		J12	V <sub>DD</sub> CORE	

Table 24 PES24NT24G2 324-Pin Signal Pin-Out (Part 2 of 5)

Pin	Function	Alt.	Pin	Function	Alt.	Pin	Function	Alt.
J13	V <sub>SS</sub>		L3	V <sub>SS</sub>		M11	V <sub>DD</sub> CORE	
J14	V <sub>DD</sub> PETA		L4	REFRES05		M12	V <sub>SS</sub>	
J15	V <sub>SS</sub>		L5	V <sub>DD</sub> PETA		M13	V <sub>DD</sub> PEA	
J16	V <sub>SS</sub>		L6	V <sub>DD</sub> PETA		M14	V <sub>DD</sub> PEHA	
J17	PE01TN0		L7	V <sub>DD</sub> CORE		M15	PE00RP0	
J18	PE01TP0		L8	V <sub>SS</sub>		M16	PE00RN0	
K1	V <sub>SS</sub>		L9	V <sub>DD</sub> CORE		M17	NC	
K2	V <sub>SS</sub>		L10	V <sub>SS</sub>		M18	REFRES00	
K3	PE13RN0		L11	V <sub>DD</sub> CORE		N1	SWMODE0	
K4	PE13RP0		L12	V <sub>SS</sub>		N2	GCLKFSEL	
K5	V <sub>DD</sub> PETA		L13	V <sub>DD</sub> PEHA		N3	PE14RN0	
K6	V <sub>SS</sub>		L14	V <sub>DD</sub> PEHA		N4	PE14RP0	
K7	V <sub>DD</sub> CORE		L15	PE01RP0		N5	V <sub>DD</sub> PEA	
K8	V <sub>SS</sub>		L16	PE01RN0		N6	V <sub>DD</sub> PEA	
K9	V <sub>DD</sub> CORE		L17	V <sub>SS</sub>		N7	V <sub>DD</sub> CORE	
K10	V <sub>SS</sub>		L18	V <sub>SS</sub>		N8	V <sub>SS</sub>	
K11	V <sub>DD</sub> CORE		M1	PE13TP0		N9	V <sub>DD</sub> CORE	
K12	V <sub>DD</sub> CORE		M2	PE13TN0		N10	V <sub>DD</sub> PETA	
K13	V <sub>SS</sub>		M3	V <sub>SS</sub>		N11	V <sub>DD</sub> CORE	
K14	V <sub>DD</sub> PETA		M4	V <sub>SS</sub>		N12	V <sub>SS</sub>	
K15	V <sub>SS</sub>		M5	V <sub>SS</sub>		N13	V <sub>DD</sub> PEA	
K16	V <sub>SS</sub>		M6	V <sub>DD</sub> PEA		N14	GPIO_07	2
K17	PE00TN0		M7	V <sub>DD</sub> CORE		N15	GPIO_06	2
K18	PE00TP0		M8	V <sub>SS</sub>		N16	GPIO_04	2
L1	PE12TP0		M9	V <sub>DD</sub> CORE		N17	GPIO_08	2
L2	PE12TN0		M10	V <sub>SS</sub>		N18	PE23RP0	

Table 24 PES24NT24G2 324-Pin Signal Pin-Out (Part 3 of 5)

Pin	Function	Alt.	Pin	Function	Alt.	Pin	Function	Alt.
P1	V <sub>SS</sub>		R9	PE18RP0		T17	V <sub>SS</sub>	
P2	V <sub>SS</sub>		R10	PE19RP0		T18	PE23TN0	
P3	PE15RN0		R11	V <sub>DD</sub> PEHA		U1	CLKMODE0	
P4	PE15RP0		R12	V <sub>SS</sub>		U2	STK3CFG0	
P5	SWMODE2		R13	PE20RP0		U3	PE16TN0	
P6	V <sub>DD</sub> PEA		R14	GPIO_01	2	U4	PE17TN0	
P7	V <sub>DD</sub> PEA		R15	GPIO_03	2	U5	V <sub>SS</sub>	
P8	V <sub>DD</sub> PETA		R16	PE21RP0		U6	REFRES06	
P9	V <sub>DD</sub> PETA		R17	PE22RN0		U7	PE18TN0	
P10	V <sub>DD</sub> PETA		R18	SSMBADDR1		U8	PE19TN0	
P11	V <sub>DD</sub> PEA		T1	PE15TP0		U9	V <sub>SS</sub>	
P12	V <sub>DD</sub> PEA		T2	PE15TN0		U10	V <sub>SS</sub>	
P13	V <sub>DD</sub> PEA		T3	RSTHALT		U11	P16CLKN	
P14	V <sub>DD</sub> I/O		T4	SWMODE3		U12	GCLKN1	
P15	V <sub>DD</sub> I/O		T5	PE16RN0		U13	V <sub>SS</sub>	
P16	GPIO_05	2	T6	PE17RN0		U14	PE20TN0	
P17	PE22RP0		T7	V <sub>SS</sub>		U15	PE21TN0	
P18	PE23RN0		T8	V <sub>SS</sub>		U16	REFRES07	
R1	PE14TP0		T9	PE18RN0		U17	PE22TN0	
R2	PE14TN0		T10	PE19RN0		U18	PE23TP0	
R3	SWMODE1		T11	V <sub>DD</sub> PEHA		V1	V <sub>DD</sub> I/O	
R4	STK2CFG0		T12	V <sub>DD</sub> PEHA		V2	V <sub>DD</sub> I/O	
R5	PE16RP0		T13	PE20RN0		V3	PE16TP0	
R6	PE17RP0		T14	GPIO_00	2	V4	PE17TP0	
R7	V <sub>SS</sub>		T15	GPIO_02	2	V5	V <sub>SS</sub>	
R8	V <sub>SS</sub>		T16	PE21RN0		V6	V <sub>SS</sub>	

Table 24 PES24NT24G2 324-Pin Signal Pin-Out (Part 4 of 5)

Pin	Function	Alt.	Pin	Function	Alt.	Pin	Function	Alt.
V7	PE18TP0		V11	P16CLKP		V15	PE21TP0	
V8	PE19TP0		V12	GCLKP1		V16	V <sub>SS</sub>	
V9	V <sub>SS</sub>		V13	V <sub>SS</sub>		V17	PE22TP0	
V10	V <sub>SS</sub>		V14	PE20TP0		V18	V <sub>SS</sub>	

Table 24 PES24NT24G2 324-Pin Signal Pin-Out (Part 5 of 5)

# PES24NT24G2 Package Drawing — 324-Pin HL/HLG324

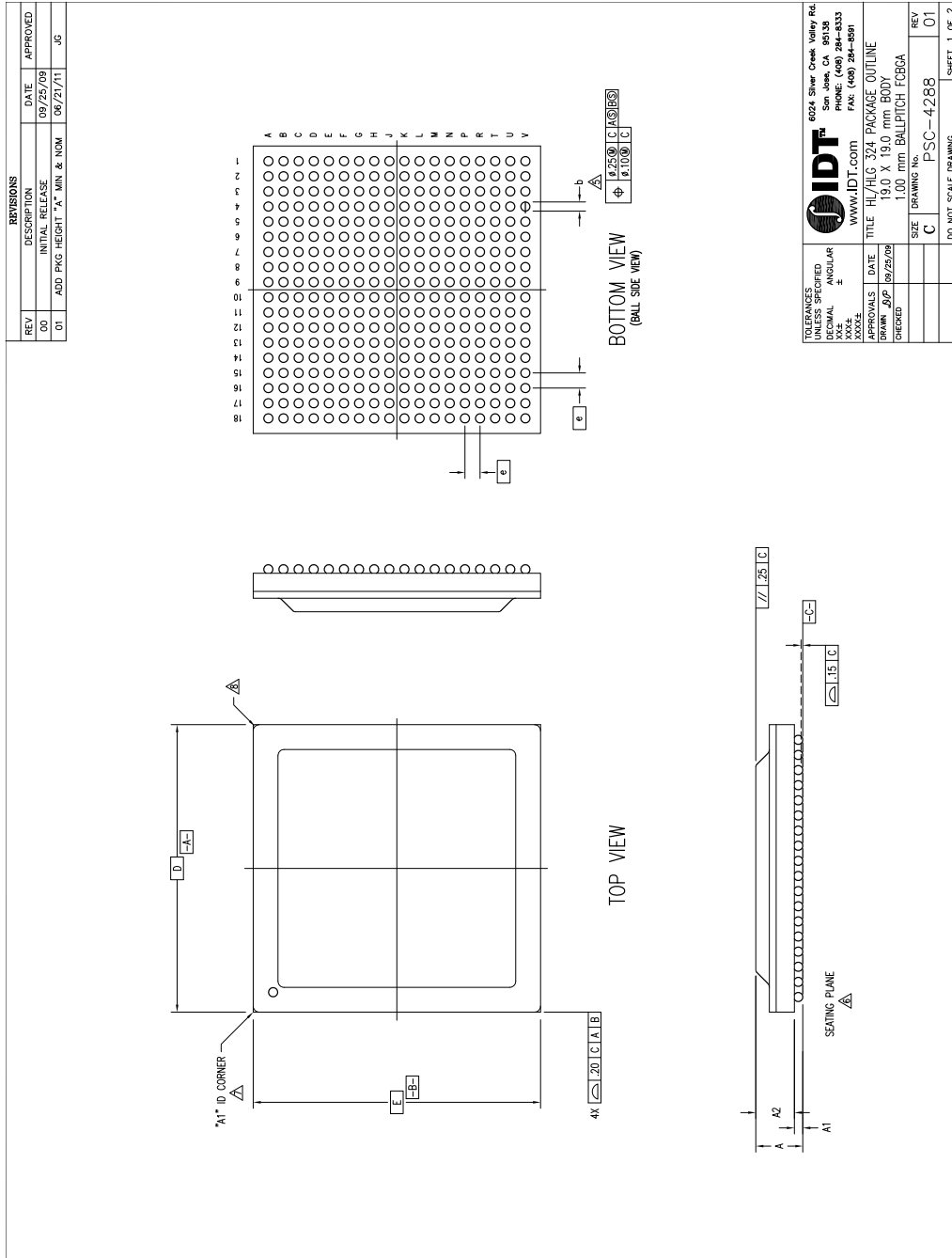

UNLESS OTHERWISE SPECIFIED	8024 Silver Creek Valley Rd. San Jose, CA 95138 PHONE: (408) 244-8333 FAX: (408) 244-6801
DECIMAL	ANGULAR
XXX ±	XXX ±
XXXX	XXXX
APPROVALS	DATE
DRAWN: JGP	09/25/09
CHECKED:	
TITLE	HL/HLG 324 PACKAGE OUTLINE
SIZE	19.0 X 19.0 mm BODY 1.00 mm BALLPITCH FBGA
DRAWING No.	PSC-4288
REV	01
DO NOT SCALE DRAWING	
SHEET 1 OF 2	



PES24NT24G2 Package Drawing — Page Two

REVISIONS			
REV	DESCRIPTION	DATE	APPROVED
00	INITIAL RELEASE	09/25/09	
01	ADD PKG HEIGHT "A" MIN & NOM	06/21/11	JG

**NOTES:**

- ALL DIMENSIONING AND TOLERANCING CONFORM TO ANSI Y14.5M-1982
- "e" REPRESENTS THE BASIC SOLDER BALL GRID PITCH
- "M" REPRESENTS THE MAXIMUM SOLDER BALL MATRIX SIZE
- "N" REPRESENTS THE BALLCOUNT NUMBER

$\triangle$  DIMENSION "b" IS MEASURED AT THE MAXIMUM SOLDER BALL DIAMETER, PARALLEL TO PRIMARY DATUM  $\text{---C---}$   
 $\triangle$  SEATING PLANE AND PRIMARY DATUM  $\text{---C---}$  ARE DEFINED BY THE SPHERICAL CROWNS OF THE SOLDER BALLS  
 $\triangle$  "A1" ID CORNER MUST BE IDENTIFIED BY CHAMFER, INK MARK, METALLIZED MARKING, INDENTATION OR OTHER FEATURE ON PACKAGE BODY  
 $\triangle$  EXACT SHAPE OF EACH CORNER IS OPTIONAL

9 ALL DIMENSIONS ARE IN MILLIMETERS

**BOTTOM VIEW**  
(BALL SIDE VIEW)

	JEDEC VARIATION			N O T E
	MIN	NOM	MAX	
A	2.38	2.63	2.88	
A1	0.30	—	—	
A2	1.76	—	2.42	
D	19.00 BSC			
E	19.00 BSC			
M	18			3
N	324			4
e	1.00 BSC			
b	0.50	0.60	0.70	5
CENTER BALL MATRIX	N/A			

TOLERANCES UNLESS SPECIFIED		6024 Silver Creek Valley Rd San Jose, CA 95138 PHONE: (408) 284-8333 FAX: (408) 284-8591 WWW.IDT.COM
ANGULAR		
APPROVALS DATE	TITLE	HL/HLS324 PACKAGE OUTLINE
09/25/09	19.0 X 19.0 mm BODY	
CHECKED	1.00 mm BALLPITCH FCBCA	
	SIZE	DRAWING No.
	C	PSC-4288
	REV	01
	DO NOT SCALE DRAWING	
	SHEET 2 OF 2	

## Revision History

**October 27, 2010:** Initial publication of final data sheet.

**November 11, 2010:** Added ZB silicon on Ordering page.

**January 26, 2011:** In [Table 18](#), Power Consumption, revised IO (and Total) power numbers in Full Swing section and added Half Swing section. Adjusted P value in [Table 19](#).

**March 9, 2011:** In [Table 10](#), deleted "External pull-down" from the Notes column for JTAG\_TRST\_N.

**March 28, 2011:** In Tables 16 and 17, added  $V_{DD}PETA$  to footnote #1.

**May 13, 2011:** Added ZB to Ordering codes on page 34.

**May 20, 2011:** Removed ZA silicon and added ZC to Order page and codes.

**June 22, 2011:** Added package height data to package drawings.

**November 7, 2011:** Revised values in [Table 18](#), Power Consumption, and updated power dissipation value in [Table 19](#).

**November 29, 2011:** Added new Tables 22 and 23, SMBus Characterization and Timing.

**March 14, 2012:** In [Table 3](#), revised description for GCLKN/P signals.

**April 16, 2013:** In [Table 20](#), added 3.3V output voltage parameters under Other I/Os category.

**May 16, 2013:** Added Note after Table 11. In [Table 20](#), added information in the Conditions column for the 3.3V parameters.

**December 17, 2013:** Added footnote 2 to [Table 23](#).



Компания «Океан Электроники» предлагает заключение долгосрочных отношений при поставках импортных электронных компонентов на взаимовыгодных условиях!

Наши преимущества:

- Поставка оригинальных импортных электронных компонентов напрямую с производств Америки, Европы и Азии, а так же с крупнейших складов мира;
- Широкая линейка поставок активных и пассивных импортных электронных компонентов (более 30 млн. наименований);
- Поставка сложных, дефицитных, либо снятых с производства позиций;
- Оперативные сроки поставки под заказ (от 5 рабочих дней);
- Экспресс доставка в любую точку России;
- Помощь Конструкторского Отдела и консультации квалифицированных инженеров;
- Техническая поддержка проекта, помощь в подборе аналогов, поставка прототипов;
- Поставка электронных компонентов под контролем ВП;
- Система менеджмента качества сертифицирована по Международному стандарту ISO 9001;
- При необходимости вся продукция военного и аэрокосмического назначения проходит испытания и сертификацию в лаборатории (по согласованию с заказчиком);
- Поставка специализированных компонентов военного и аэрокосмического уровня качества (Xilinx, Altera, Analog Devices, Intersil, Interpoint, Microsemi, Actel, Aeroflex, Peregrine, VPT, Syfer, Eurofarad, Texas Instruments, MS Kennedy, Miteq, Cobham, E2V, MA-COM, Hittite, Mini-Circuits, General Dynamics и др.);

Компания «Океан Электроники» является официальным дистрибьютором и эксклюзивным представителем в России одного из крупнейших производителей разъемов военного и аэрокосмического назначения «JONHON», а так же официальным дистрибьютором и эксклюзивным представителем в России производителя высокотехнологичных и надежных решений для передачи СВЧ сигналов «FORSTAR».



## JONHON

«JONHON» (основан в 1970 г.)

Разъемы специального, военного и аэрокосмического назначения:

(Применяются в военной, авиационной, аэрокосмической, морской, железнодорожной, горно- и нефтедобывающей отраслях промышленности)

«FORSTAR» (основан в 1998 г.)

ВЧ соединители, коаксиальные кабели, кабельные сборки и микроволновые компоненты:

(Применяются в телекоммуникациях гражданского и специального назначения, в средствах связи, РЛС, а так же военной, авиационной и аэрокосмической отраслях промышленности).



Телефон: 8 (812) 309-75-97 (многоканальный)

Факс: 8 (812) 320-03-32

Электронная почта: [ocean@oceanchips.ru](mailto:ocean@oceanchips.ru)

Web: <http://oceanchips.ru/>

Адрес: 198099, г. Санкт-Петербург, ул. Калинина, д. 2, корп. 4, лит. А