

## LED Drivers for LCD Backlights

# Multifunction Backlight LED Drivers for Small LCD Panels (Charge Pump Type)



BD6081GU, BD6081GVW

No.11040EAT27

## ●Description

BD6081GU / BD6081GVW is compound LED Driver which is the most suitable for the cellular phone.

Main LCD Back Light LED Driver (Max 4 Light), Sub LCD Back Light LED Driver (Max 2 Light), 2 system RGB LED Drivers, 2Ch LDO (2.8V/1.8V) included. This is PMIC (Power Management IC) that is the most suitable for "the indication part" of the cellular phone. A charge pump form is adopted, and a coil is never used for the part DC/DC. This IC achieves compact size with the chip size package (VCSP85H3). [BD6081GU] This IC solves a mounting problem by BGA package (SBGA063W060). [BD6081GVW]

## ●Features

- 1) Main LCD Back Light LED Driver (Max 4 Light)  
4 Lighting / 3 Lighting can be chosen (register setting)
- 2) Sub LCD Back Light LED Driver (Max 2 Light)  
2 Lighting / 1 Lighting can be chosen (register setting)
- 3) RGB LED Driver (2 System)  
Slope control is built in. (2 system independence can be controlled.)  
LED connection (for G1LED, G2LED, B1LED, B2LED) can be set up in the battery or the DC/DC output. (register setting)  
LED connection (for R1LED, R2LED) can be set up in the battery only.
- 4) 2ch Series Regulator  
2.8V output I<sub>max</sub>=150mA  
1.8V output I<sub>max</sub>=150mA (normal mode)  
1.8V output low current consumption mode / normal mode Switching is possible. (The outside pin control / register setting)
- 5) Charge Pump DC/DC  
Soft start Functions  
Over voltage protection (Auto-return type)  
Over current protection (Auto-return type)
- 6) Thermal shutdown (Auto-return type)
- 7) I<sup>2</sup>C BUS Fast-mode (max 400kHz) Writing

\*This chip is not designed to protect itself against radioactive rays.

\*This material may be changed on its way to designing.

\*This material is not the specification.

## ●Absolute Maximum Ratings (Ta=25 °C)

Parameter	Symbol	Ratings	Unit
Maximum Applied voltage	V <sub>MAX</sub>	7	V
Power Dissipation	BD6081GU	P <sub>d</sub> 1725 note1)	mW
	BD6081GVW	P <sub>d</sub> 1060 note2)	mW
Operating Temperature Range	T <sub>opr</sub>	-25 ~ +85	°C
Storage Temperature Range	T <sub>stg</sub>	-55 ~ +150	°C

cote1) Power dissipation deleting is 13.8mW/ °C, when it's used in over 25 °C.  
(It's deleting is on the board that is ROHM's standard))

Note2) Power dissipation deleting is 8.48mW/ °C, when it's used in over 25 °C.  
(It's deleting is on the board that is ROHM's standard))

## ●Operating conditions (V<sub>BAT</sub> ≥ V<sub>IO</sub>, Ta = -25 ~ 85 °C)

Parameter	Symbol	Ratings	Unit
V <sub>BAT</sub> input voltage	V <sub>BAT</sub>	2.7 ~ 5.5	V
V <sub>IO</sub> pin voltage	V <sub>IO</sub>	1.65 ~ 3.3	V

● **Electrical Characteristics** (Unless otherwise specified, Ta=25°C, VBAT=3.6V, VIO=1.8V)

Parameter	Symbol	Limits			Unit	Condition
		Min.	Typ.	Max.		
<b>【Circuit Current】</b>						
VBAT Circuit current 1	IBAT1	-	0.1	3.0	μA	RESET=0V, VIO=0V
VBAT Circuit current 2	IBAT2	-	0.5	3.0	μA	RESET=0V, VIO=1.8V
VBAT Circuit current 3	IBAT3	-	6.2	9.5	μA	REG2 low current consumption mode, Io=0mA
VBAT Circuit current 4	IBAT4	-	100	150	μA	REG2 normal mode, Io=0mA
VBAT Circuit current 5	IBAT5	-	140	210	μA	REG1, REG2 normal mode, Io=0mA
VBAT Circuit current 6	IBAT6	-	63	95	mA	DC/DC x1 mode, Io=60mA, VBAT=4.0V
VBAT Circuit current 7	IBAT7	-	95	143	mA	DC/DC x1.5 mode, Io=60mA, VBAT=3.6V
VBAT Circuit current 8	IBAT8	-	125	188	mA	DC/DC x2 mode, Io=60mA, VBAT=2.7V
<b>【LED Driver】</b>						
LED current Step1	ILEDSTP1	32			Step	MLED1~4, SLED1~2
LED current Step2	ILEDSTP2	64			Step	R1LED, G1LED, B1LED, R2LED, G2LED, B2LED (with 0mA setting)
LED Maximum setup current 1	IMAX1	-	-	32	mA	MLED1~4, SLED1~2, ISET=120kΩ
LED Maximum setup current 2	IMAX2	-	-	31.5	mA	R1LED, G1LED, B1LED, R2LED, G2LED, B2LED, ISET=120kΩ
LED current accurate	ILED	18	20	22	mA	ILED=20mA, ISET=120kΩ
LED current Matching	ILEDMT	-	5	10	%	Between MLED1~4 Between SLED1~2 Between R1LED, G1LED and B1LED Between R2LED, G2LED and B2LED
LED OFF Leak current	ILKLED	-	-	1.0	μA	
<b>【DC/DC(Charge Pump)】</b>						
Output voltage	V <sup>CP</sup>	Vf+0.15	Vf+0.2	-	V	Vf is LED forward voltage
Current Load	IOUT	-	-	255	mA	VBAT≥3.2V, VOUT=4V
Oscillator frequency	fosc	0.8	1.0	1.2	MHz	
Over voltage protection detect voltage	OVP	-	6.0	6.5	V	
Over current protection detect current	OCP	-	250	375	mA	VOUT=0V
<b>【REG1】</b>						
Output voltage	Vo1	2.716	2.80	2.884	V	Io=150mA, VBAT≥3.1V
I/O voltage difference	Vsat1	-	0.2	0.3	V	VBAT=2.5V, Io=150mA
Load stability	ΔVo11	-	10	60	mV	Io=1~150mA
Input stability	ΔVo12	-	10	60	mV	VBAT=3.2~5.5V, Io=150mA
Ripple Rejection Ratio	RR1	30	40	-	dB	f=100Hz, Vin=200mVp-p
Short circuit current limit	Ilim01	-	225	450	mA	Vo=0V
Discharge resister at OFF	ROFF1	-	1.0	1.5	kΩ	
<b>【REG2】</b>						
Output voltage 1	Vo21	1.74	1.8	1.86	V	Io=150mA (normal mode)
Output voltage 2	Vo22	1.71	1.8	1.89	V	Io=100μA (low current consumption mode)
Load stability	ΔVo21	-	10	60	mV	Io=1~150mA
Input stability	ΔVo22	-	10	60	mV	VBAT=3.2~5.5V, Io=150mA
Ripple Rejection Ratio	RR2	30	40	-	dB	f=100Hz, Vin=200mVp-p
Short circuit current limit	Ilim02	-	225	450	mA	Vo=0V
Discharge resister at OFF	ROFF2	-	1.0	1.5	kΩ	

● **Electrical Characteristics** (Unless otherwise specified, Ta=25°C, VBAT=3.6V, VIO=1.8V)

Parameter	Symbol	Limits			Unit	Condition
		Min.	Typ.	Max.		
<b>【I<sup>2</sup>C Input (SDA, SCL)】</b>						
LOW level input voltage	VIL	-0.3	-	0.25 xVIO	V	
HIGH level input voltage	VIH	0.75 xVIO	-	VBAT+0.3	V	
Hysteresis of Schmitt trigger input	Vhys	0.05 xVIO	-	-	V	
LOW level output voltage (SDA) at 3mA sink current	VOL	0	-	0.3	V	
Input current each I/O pin	lin	-10	-	10	μA	Input voltage = 0.1xVIO~0.9xVIO
<b>【RESET, RGB1CNT, RGB2CNT】</b>						
LOW level input voltage	VIL	-0.3	-	0.25 xVIO	V	
HIGH level input voltage1	VIH1	0.75 xVIO	-	VBAT+0.3	V	RESET Pin
HIGH level input voltage2	VIH2	0.75 xVIO	-	VIO+0.3	V	RGB1CNT, RGB2CNT Pin
Input current each I/O pin1	lin	-10	-	10	μA	Input voltage = 0.1xVIO~0.9xVIO, RESET Pin
Input current each I/O pin2	lin	-	6	15	μA	Input voltage = .9xVIO, RGB1CNT, RGB2CNT Pin
<b>【REG2EN, REG2MD】</b>						
LOW level input voltage	VIL	-0.3	-	0.3	V	
HIGH level input voltage	VIH	1.4	-	VBAT,+0.3	V	
Input current each I/O pin	lin	-	6	15	μA	Vin=1.8V

● **Power dissipation (On the ROHM's standard board)**

BD6081GU

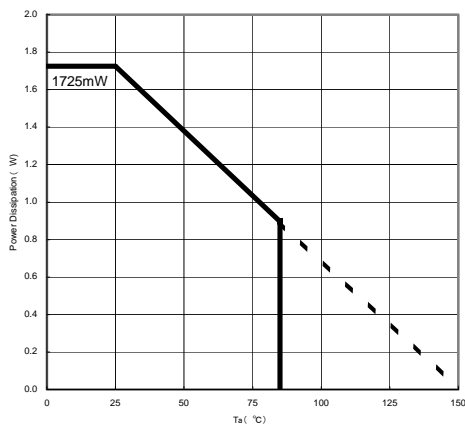

Fig.1

Information of the ROHM's standard board

Material: glass-epoxy  
Size: 50mmx58mmx1.75mm (8 Layer)

BD6081GVW

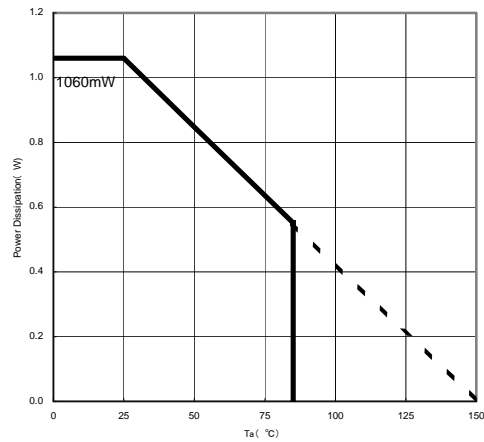

Fig.2

Information of the ROHM's standard board

Material: glass-epoxy  
Size: 114.3mmx76.2mmx1.6mm

Pattern of the board: Refer to it that goes later.

●Block Diagram / Application Circuit example

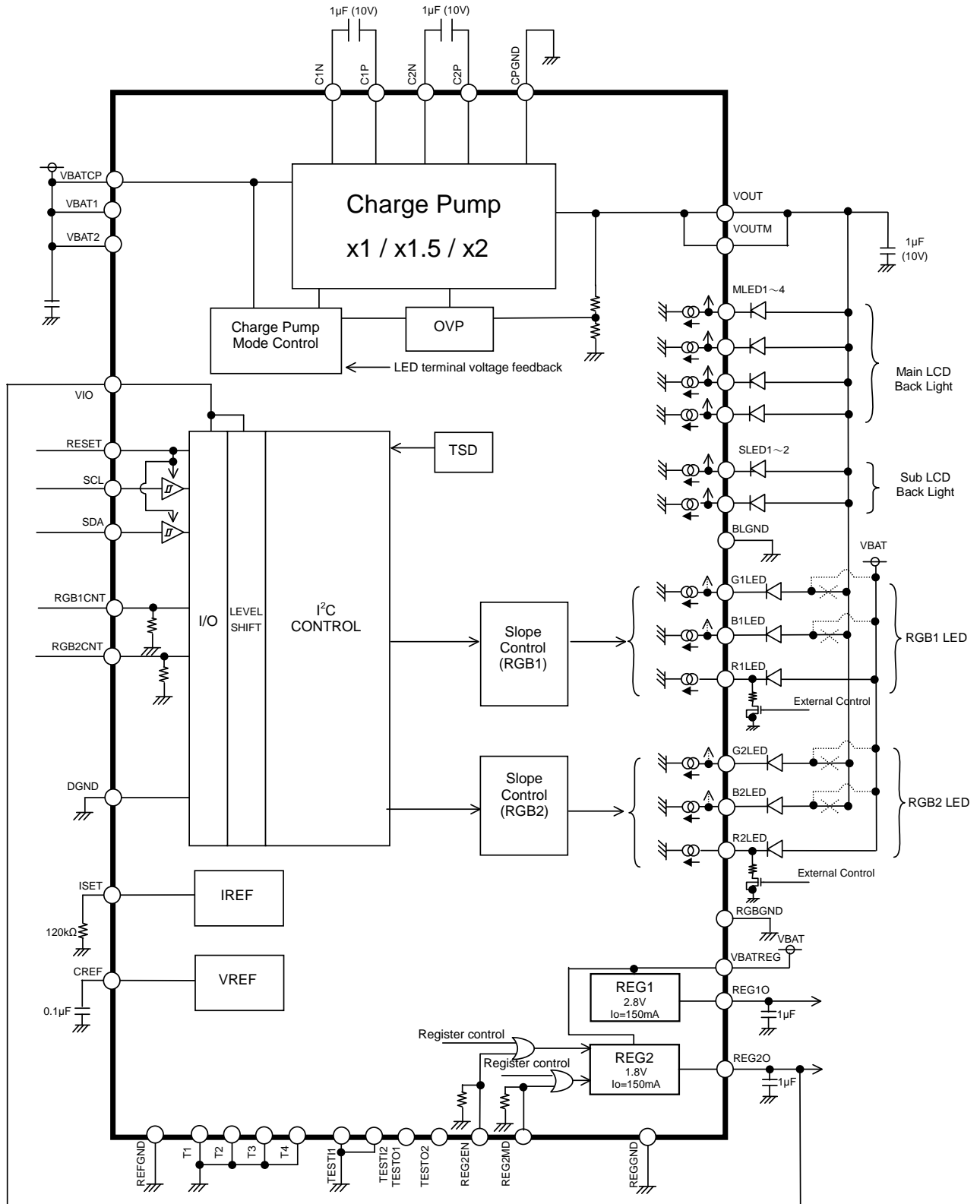



Fig.3 Block Diagram / Application Circuit example

## ● Pin Arrangement [Bottom View]

BD6081GU

G	T4	VBAT1	REG2O	VBATREG	REGGND	VIO	T3
F	REFGND	R1LED	CREF	REG1O	REG2MD	RGB1CNT	RESET
E	G1LED	B1LED	ISET	REG2EN	RGB2CNT	SDA	DGND
D	RGBGND	R2LED	TEST1	TEST2	SCL	VOUTM	VOUT
C	G2LED	B2LED		TESTO2	TESTO1	C1P	C2P
B	SLED1	BLGND	MLED2	MLED4	CPGND	C1N	VBATCP
A	T1	SLED2	MLED1	MLED3	VBAT2	C2N	T2
	1	2	3	4	5	6	7

Total: 48ball

There is no Ball only in C3 for index.

BD6081GVW

H	T2	C1P	C2P	-	-	SDA	RESET	T3
G	C1N	-	-	VOUTM	TESTO1	SCL	RGB2CNT	VIO
F	CPGND	C2N	TEST1	VOUT	DGND	RGB1CNT	TESTO2	REG2MD
E	MLED3	MLED4	VBAT2	VBATCP	-	REG2EN	REGGND	-
D	MLED2	-	MLED1	-	-	REG1O	VBATREG	-
C		BLGND	B2LED	-	-	TEST2	CREF	REG2O
B	SLED2	SLED1	R2LED	-	-	REFGND	-	VBAT1
A	T1	G2LED	RGBGND	B1LED	G1LED	R1LED	ISET	T4
	1	2	3	4	5	6	7	8

Total: 63ball

There is no Ball only in C1 for index.

“-“ means NC pin (Non connect to internal circuit)

● Package

BD6081GU

VCSP85H3 CSP small Package

SIZE : 3.90mm×3.90mm (A difference in public: X and Y, together, ± 0.1mm) height 1.0mm max

A ball pitch : 0.5mm

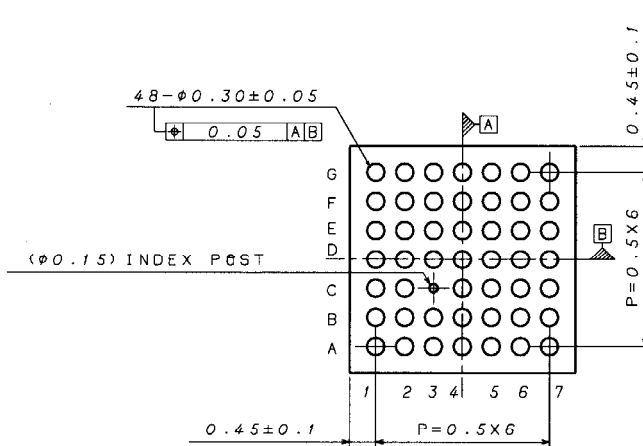
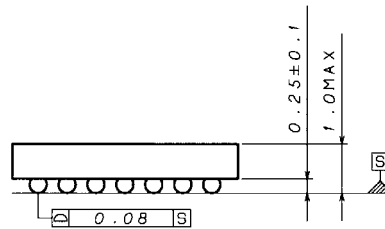
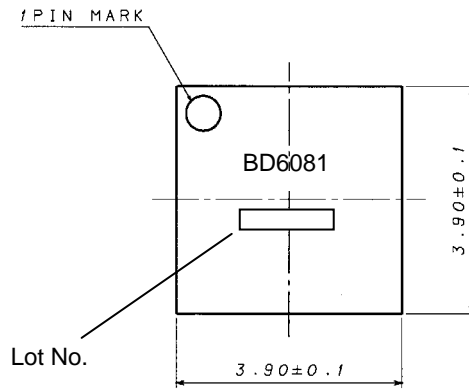

(UNIT : mm)

● Package

BD6081GVW

SBGA063W060

SIZE : 6.0mm×6.0mm(A difference in public: X and Y, together, ± 0.1mm) height 0.9mm max

A ball pitch : 0.65mm

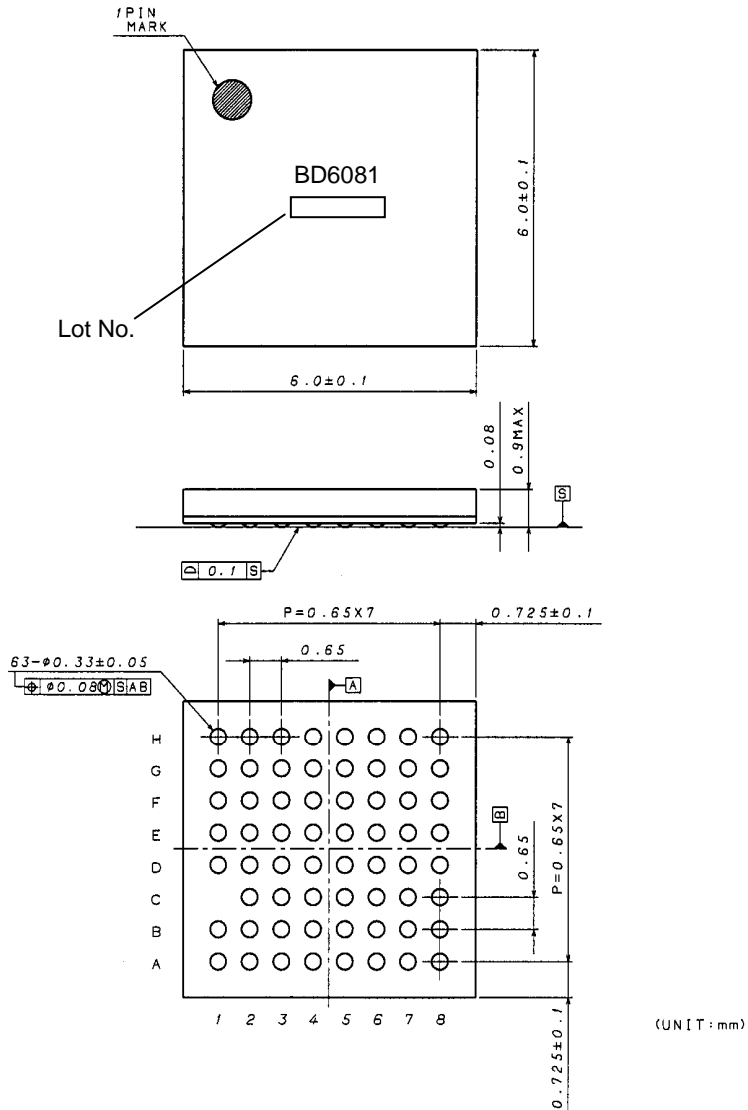

## ● Pin Functions

No	Pin No.		Pin Name	I/O	Input Level	ESD Diode		Functions	Equivalent circuit diagram
	BD6081GU	BD6081GVW				For Power	For Ground		
1	B7	E4	VBATCP	-	-	-	GND	Battery is connected	A
2	G2	B8	VBAT1	-	-	-	GND	Battery is connected	A
3	A5	E3	VBAT2	-	-	-	GND	Battery is connected	A
4	G4	D7	VBATREG	-	-	-	GND	Battery is connected	A
5	A1	A1	T1	-	-	-	GND	Test Pin (short to GND)	A
6	A7	H1	T2	-	-	-	GND	Test Pin (short to GND)	A
7	G7	H8	T3	-	-	VBAT	GND	Test Pin (short to GND)	J
8	G1	A8	T4	-	-	VBAT	GND	Test Pin (short to GND)	J
9	F3	C7	CREF	O	-	VBAT	GND	Reference voltage output	P
10	G6	G8	VIO	-	-	VBAT	GND	I/O voltage source is connected	C
11	F7	H7	RESET	I	VIO	VBAT	GND	Reset input (L: RESET, H: RESET cancel)	H
12	E6	H6	SDA	I	VIO	VBAT	GND	I <sup>2</sup> C data input	I
13	D5	G6	SCL	I	VIO	VBAT	GND	I <sup>2</sup> C clock input	H
14	B5	F1	CPGND	-	-	VBAT	-	Ground	B
15	F1	B6	REFGND	-	-	VBAT	-	Ground	B
16	G5	E7	REGGND	-	-	VBAT	-	Ground	B
17	B2	C2	BLGND	-	-	VBAT	-	Ground	B
18	D1	A3	RGBGND	-	-	VBAT	-	Ground	B
19	E7	F5	DGND	-	-	VBAT	-	Ground	B
20	B6	G1	C1N	I/O	-	VBAT	GND	Charge Pump capacitor is connected	F
21	C6	H2	C1P	I/O	-	-	GND	Charge Pump capacitor is connected	G
22	A6	F2	C2N	I/O	-	VBAT	GND	Charge Pump capacitor is connected	F
23	C7	H3	C2P	I/O	-	-	GND	Charge Pump capacitor is connected	G
24	D7	F4	VOUT	O	-	-	GND	Charge Pump output pin	A
25	D6	G4	VOUTM	O	-	-	GND	Charge Pump output pin output pin	A
26	E3	A7	ISET	I	-	VBAT	GND	LED standard current	O
27	F4	D6	REG1O	O	-	VBAT	GND	REG1 output pin	Q
28	G3	C8	REG2O	O	-	VBAT	GND	REG2 output pin	Q
29	A3	D3	MLED1	I	-	VBAT	GND	Main LCD Back Light LED is connected 1	D
30	B3	D1	MLED2	I	-	VBAT	GND	Main LCD Back Light LED is connected 2	D
31	A4	E1	MLED3	I	-	VBAT	GND	Main LCD Back Light LED is connected 3	D
32	B4	E2	MLED4	I	-	VBAT	GND	Main LCD Back Light LED is connected 4	D
33	B1	B2	SLED1	I	-	VBAT	GND	Sub LCD Back Light LED is connected 1	D
34	A2	B1	SLED2	I	-	VBAT	GND	Sub LCD Back Light LED is connected 2	D
35	F2	A6	R1LED	I	-	VBAT	GND	Red LED1 is connected	D
36	E1	A5	G1LED	I	-	VBAT	GND	Green LED1 is connected	D
37	E2	A4	B1LED	I	-	VBAT	GND	Blue LED1 is connected	D
38	D2	B3	R2LED	I	-	VBAT	GND	Red LED2 is connected	D
39	C1	A2	G2LED	I	-	VBAT	GND	Green LED2 is connected	D
40	C2	C3	B2LED	I	-	VBAT	GND	Blue LED2 is connected	D
41	F6	F6	RGB1CNT	I	VIO	VIO	GND	RGB1 LED external ON/OFF Synchronism Pin	K
42	E5	G7	RGB2CNT	I	VIO	VIO	GND	RGB2 LED external ON/OFF Synchronism Pin	K
43	E4	E6	REG2EN	I	(VBAT)	VBAT	GND	REG2 ON/OFF control Pin (L: OFF, H: ON)	L
44	F5	F8	REG2MD	I	(VBAT)	VBAT	GND	REG2 Mode control Pin (L: low current consumption, H: normal)	L
45	D3	F3	TESTI1	I	-	VBAT	GND	Test input pin 1 (short to GND)	H
46	D4	C6	TESTI2	I	-	VBAT	GND	Test input pin 2 (short to GND)	H
47	C5	G5	TESTO1	O	-	VBAT	GND	Test output pin 1 (OPEN)	M
48	C4	F7	TESTO2	O	-	VBAT	GND	Test output pin 2 (OPEN)	N
49 - 63	-	(Other)	NC	-	-	-	-	Non connect pin	-

※ The LED pin which isn't used is to short-circuit to the ground. But, the setup of a register concerned with LED that isn't used is prohibited.

Total: Functional 48Pin

48 balls (BD6081GU)

63 balls (BD6081GVW)



●Equivalent circuit diagram

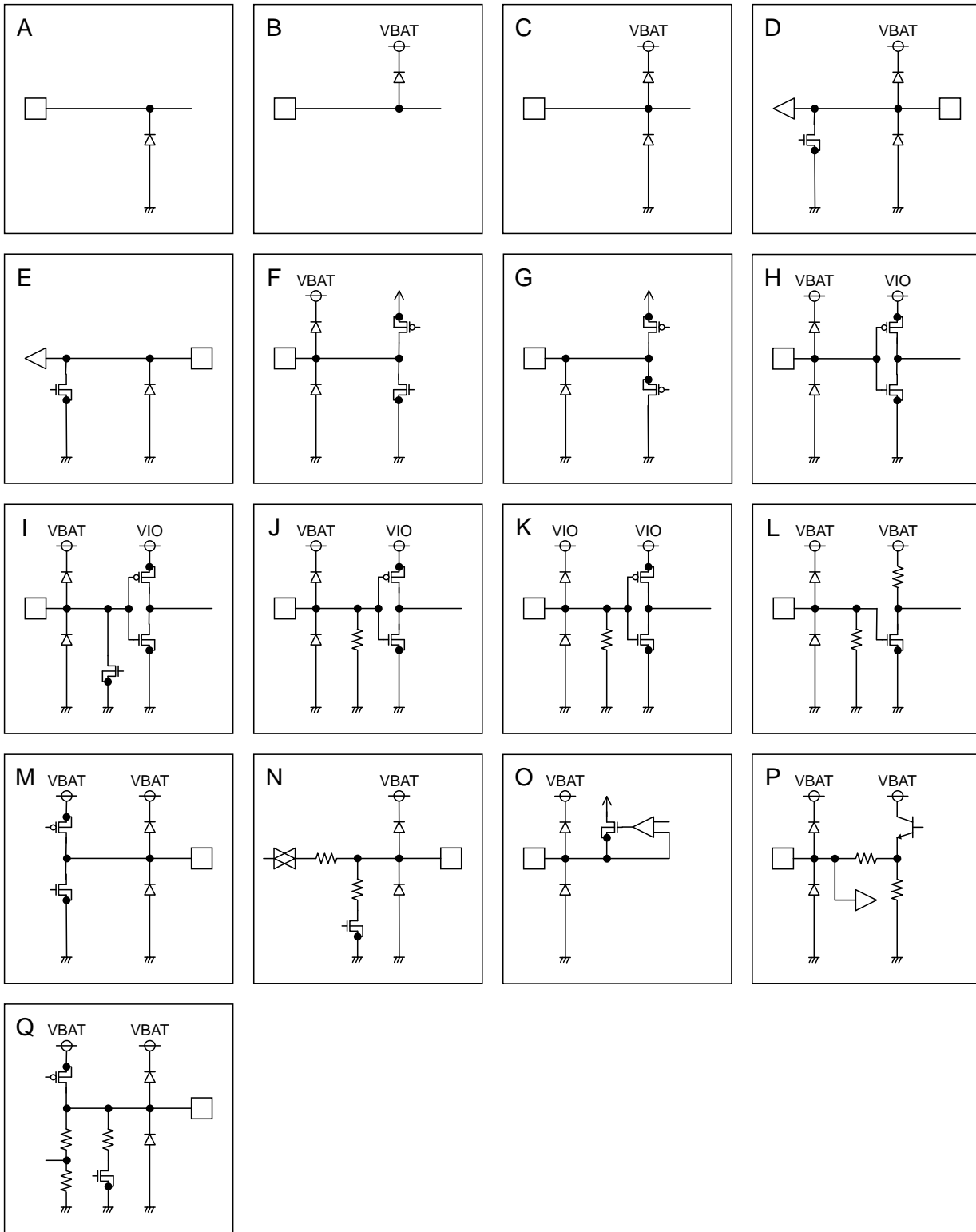

● I<sup>2</sup>C BUS format

The writing/reading operation is based on the I<sup>2</sup>C slave standard.

- Slave address

A7	A6	A5	A4	A3	A2	A1	W
1	1	1	0	1	1	0	0

- Bit Transfer

SCL transfers 1-bit data during H. SCL cannot change signal of SDA during H at the time of bit transfer. If SDA changes while SCL is H, START conditions or STOP conditions will occur and it will be interpreted as a control signal.

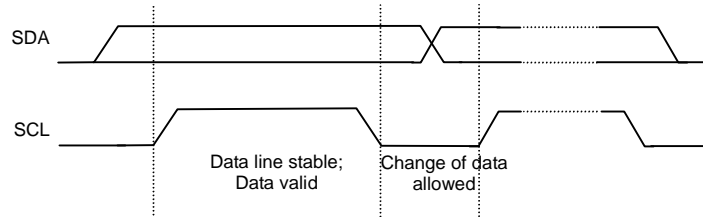

- START and STOP condition

When SDA and SCL are H, data is not transferred on the I<sup>2</sup>C-bus. This condition indicates, if SDA changes from H to L while SCL has been H, it will become START (S) conditions, and an access start, if SDA changes from L to H while SCL has been H, it will become STOP (P) conditions and an access end.

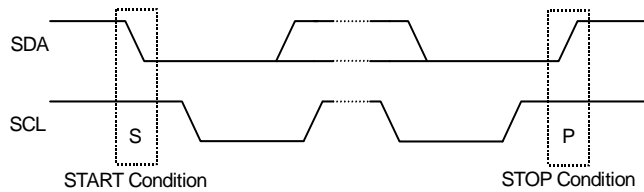

- Acknowledge

It transfers data 8 bits each after the occurrence of START condition. A transmitter opens SDA after transfer 8bits data, and a receiver returns the acknowledge signal by setting SDA to L.

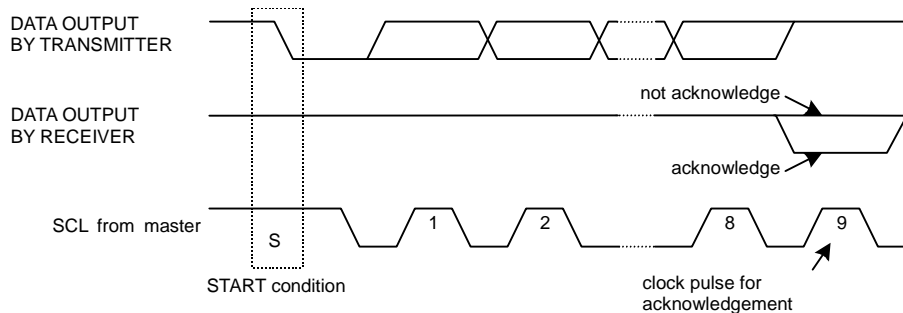

• Writing protocol

A register address is transferred by the next 1 byte that transferred the slave address and the write-in command. The 3rd byte writes data in the internal register written in by the 2nd byte, and after 4th byte or, the increment of register address is carried out automatically. However, when a register address turns into the last address (1Ah), it is set to 00h by the next transmission. After the transmission end, the increment of the address is carried out.

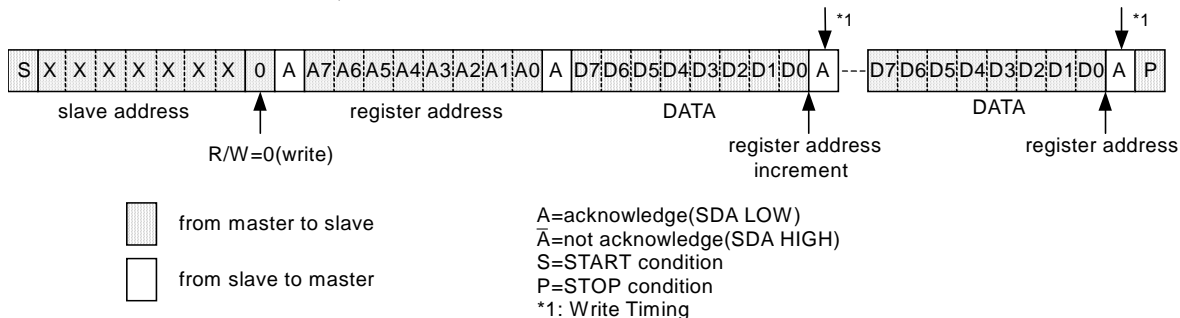

●Timing diagram

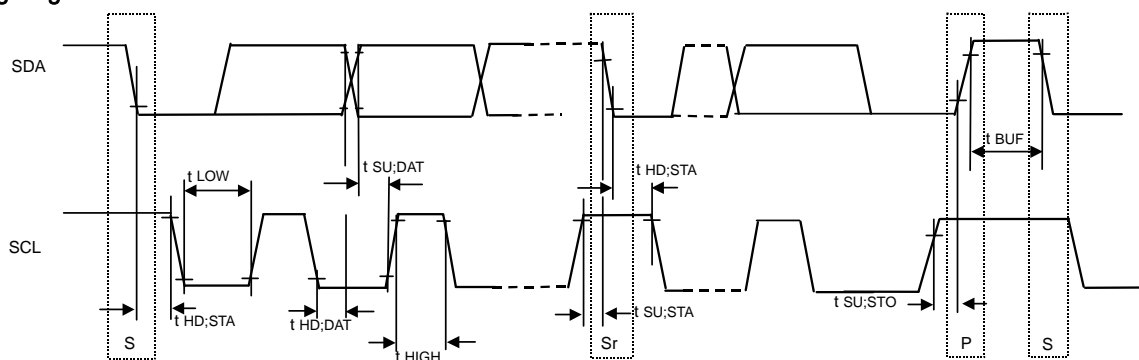

●Electrical Characteristics(Unless otherwise specified, Ta=25 °C, VBAT=3.6V, VIO=1.8V)

Parameter	Symbol	Standard-mode			Fast-mode			Unit
		Min.	Typ.	Max.	Min.	Typ.	Max.	
<b>[I<sup>2</sup>C BUS format]</b>								
SCL clock frequency	fSCL	0	-	100	0	-	400	kHz
LOW period of the SCL clock	tLOW	4.7	-	-	1.3	-	-	µs
HIGH period of the SCL clock	tHIGH	4.0	-	-	0.6	-	-	µs
Hold time (repeated) START condition After this period, the first clock is generated	tHD:STA	4.0	-	-	0.6	-	-	µs
Set-up time for a repeated START condition	tSU:STA	4.7	-	-	0.6	-	-	µs
Data hold time	tHD:DAT	0	-	3.45	0	-	0.9	µs
Data set-up time	tSU:DAT	250	-	-	100	-	-	ns
Set-up time for STOP condition	tSU:STO	4.0	-	-	0.6	-	-	µs
Bus free time between a STOP and START condition	tBUF	4.7	-	-	1.3	-	-	µs

## ● Register List

Address	Register data								Function
	D7	D6	D5	D4	D3	D2	D1	D0	
00h	-	-	-	-	-	-	-	SFTRST	Software reset
01h	-	-	REG2NML	REG2PD	-	-	-	REG1PD	Control LDO
02h	-	-	SLEDSSEL	SLEDEN	-	-	MLEDSEL	MLEDEN	Control Back Light
03h	-	-	-	IMLED4	IMLED3	IMLED2	IMLED1	IMLED0	Main Back Light current value
04h	-	-	-	ISLED4	ISLED3	ISLED2	ISLED1	ISLED0	Sub Back Light current value
05h	-	B2LEDMD	G2LEDMD	RGB2STA	-	B1LEDMD	G1LEDMD	RGB1STA	Control RGB1, RGB2 LED Setting GB LED connection
06h	RGB1MD1	RGB1MD0	B1LEDPL	G1LEDPL	R1LEDPL	B1LEDEN	G1LEDEN	R1LEDEN	Control RGB1 LED
07h	RGB1WT1TM3	RGB1WT1TM2	RGB1WT1TM1	RGB1WT1TM0	RGB1WT2TM3	RGB1WT2TM2	RGB1WT2TM1	RGB1WT2TM0	RGB1 ON time setting
08h	RGB1SL1 STEP3	RGB1SL1 STEP2	RGB1SL1 STEP1	RGB1SL1 STEP0	RGB1SL2 STEP3	RGB1SL2 STEP2	RGB1SL2 STEP1	RGB1SL2 STEP0	RGB1 slope 1step time setting
09h	-	-	-	-	-	RGB1SLNUM2	RGB1SLNUM1	RGB1SLNUM0	RGB1 slope step number setting
0Ah	-	-	I1R1LED5	I1R1LED4	I1R1LED3	I1R1LED2	I1R1LED1	I1R1LED0	R1 LED current value1
0Bh	-	-	IDLTR1LED5	IDLTR1LED4	IDLTR1LED3	IDLTR1LED2	IDLTR1LED1	IDLTR1LED0	Δ current value for R1 LED current step
0Ch	-	-	I1G1LED5	I1G1LED4	I1G1LED3	I1G1LED2	I1G1LED1	I1G1LED0	G1 LED current value1
0Dh	-	-	IDLTG1LED5	IDLTG1LED4	IDLTG1LED3	IDLTG1LED2	IDLTG1LED1	IDLTG1LED0	Δ current value for G1 LED current step
0Eh	-	-	I1B1LED5	I1B1LED4	I1B1LED3	I1B1LED2	I1B1LED1	I1B1LED0	B1 LED current value1
0Fh	-	-	IDLTB1LED5	IDLTB1LED4	IDLTB1LED3	IDLTB1LED2	IDLTB1LED1	IDLTB1LED0	Δ current value for B1 LED current step
10h	RGB2MD1	RGB2MD0	B2LEDPL	G2LEDPL	R2LEDPL	B2LEDEN	G2LEDEN	R2LEDEN	Control RGB2 LED
11h	RGB2WT1TM3	RGB2WT1TM2	RGB2WT1TM1	RGB2WT1TM0	RGB2WT2TM3	RGB2WT2TM2	RGB2WT2TM1	RGB2WT2TM0	RGB2 ON time setting
12h	RGB2SL1 STEP3	RGB2SL1 STEP2	RGB2SL1 STEP1	RGB2SL1 STEP0	RGB2SL2 STEP3	RGB2SL2 STEP2	RGB2SL2 STEP1	RGB2SL2 STEP0	RGB2 slope 1step time setting
13h	-	-	-	-	-	RGB2SLNUM2	RGB2SLNUM1	RGB2SLNUM0	RGB2 slope step number setting
14h	-	-	I1R2LED5	I1R2LED4	I1R2LED3	I1R2LED2	I1R2LED1	I1R2LED0	R2 LED current value1
15h	-	-	IDLTR2LED5	IDLTR2LED4	IDLTR2LED3	IDLTR2LED2	IDLTR2LED1	IDLTR2LED0	Δ current value for R2 LED current step
16h	-	-	I1G2LED5	I1G2LED4	I1G2LED3	I1G2LED2	I1G2LED1	I1G2LED0	G2 LED current value1
17h	-	-	IDLTG2LED5	IDLTG2LED4	IDLTG2LED3	IDLTG2LED2	IDLTG2LED1	IDLTG2LED0	Δ current value for G2 LED current step
18h	-	-	I1B2LED5	I1B2LED4	I1B2LED3	I1B2LED2	I1B2LED1	I1B2LED0	B2 LED current value1
19h	-	-	IDLTB2LED5	IDLTB2LED4	IDLTB2LED3	IDLTB2LED2	IDLTB2LED1	IDLTB2LED0	Δ current value for B2 LED current step
1Ah	-	-	-	-	-	-	RGB2MEL	RGB1MEL	RGB1, RGB2 LED external ON/OFF control
1Dh	Reserved								For test
1Eh	Reserved								For test
1Fh	Reserved								For test

Input "0" for "-".

Prohibit to accessing the address that isn't mentioned and the register for test.

## ● Register Map

Address 00h &lt;Software reset&gt;

BIT	Name	Initial	Function	
			0	1
D7	-	-	-	-
D6	-	-	-	-
D5	-	-	-	-
D4	-	-	-	-
D3	-	-	-	-
D2	-	-	-	-
D1	-	-	-	-
D0	SFTRST	0	Reset cancel	Reset

Address 01h &lt;Control LDO&gt;

BIT	Name	Initial	Function	
			0	1
D7	-	-	-	-
D6	-	-	-	-
D5	REG2NML	0	REG2 low current consumption mode	REG2 normal mode
D4	REG2PD	0	REG2 power OFF	REG2 power ON
D3	-	-	-	-
D2	-	-	-	-
D1	-	-	-	-
D0	REG1PD	0	REG1 power OFF	REG1 power ON

Address 02h &lt;Control Back Light&gt;

BIT	Name	Initial	Function	
			0	1
D7	-	-	-	-
D6	-	-	-	-
D5	SLEDSEL	0	2 lights ON (SLED1~2)	1 lights ON (SLED1)
D4	SLEDEN	0	Sub Back Light OFF	Sub Back Light ON
D3	-	-	-	-
D2	-	-	-	-
D1	MLEDSEL	0	4 lights ON (MLED1~4)	3 lights ON (MLED1~3)
D0	MLEDEN	0	Main Back Light OFF	Main Back Light ON

Address 03h <Main Back Light current value>

BIT	Name	Initial	Function																																																												
			0	1																																																											
D7	-	-	-	-																																																											
D6	-	-	-	-																																																											
D5	-	-	-	-																																																											
D4	IMLED4	0	<table border="1"> <thead> <tr> <th>IMLED4</th> <th>IMLED3</th> <th>IMLED2</th> <th>IMLED1</th> <th>IMLED0</th> <th>Current value</th> </tr> </thead> <tbody> <tr> <td>0</td> <td>0</td> <td>0</td> <td>0</td> <td>0</td> <td>1mA</td> </tr> <tr> <td>0</td> <td>0</td> <td>0</td> <td>0</td> <td>1</td> <td>2mA</td> </tr> <tr> <td>0</td> <td>0</td> <td>0</td> <td>1</td> <td>0</td> <td>3mA</td> </tr> <tr> <td>.</td> <td>.</td> <td>.</td> <td>.</td> <td>.</td> <td rowspan="3">1mA Step</td> </tr> <tr> <td>.</td> <td>.</td> <td>.</td> <td>.</td> <td>.</td> </tr> <tr> <td>.</td> <td>.</td> <td>.</td> <td>.</td> <td>.</td> </tr> <tr> <td>1</td> <td>1</td> <td>1</td> <td>0</td> <td>1</td> <td>30mA</td> </tr> <tr> <td>1</td> <td>1</td> <td>1</td> <td>1</td> <td>0</td> <td>31mA</td> </tr> <tr> <td>1</td> <td>1</td> <td>1</td> <td>1</td> <td>1</td> <td>32mA</td> </tr> </tbody> </table> <p>When 120kΩ is connected to ISET pin.</p>			IMLED4	IMLED3	IMLED2	IMLED1	IMLED0	Current value	0	0	0	0	0	1mA	0	0	0	0	1	2mA	0	0	0	1	0	3mA	.	.	.	.	.	1mA Step	.	.	.	.	.	.	.	.	.	.	1	1	1	0	1	30mA	1	1	1	1	0	31mA	1	1	1	1	1	32mA
IMLED4	IMLED3	IMLED2				IMLED1	IMLED0	Current value																																																							
0	0	0				0	0	1mA																																																							
0	0	0				0	1	2mA																																																							
0	0	0				1	0	3mA																																																							
.	.	.				.	.	1mA Step																																																							
.	.	.				.	.																																																								
.	.	.				.	.																																																								
1	1	1	0	1	30mA																																																										
1	1	1	1	0	31mA																																																										
1	1	1	1	1	32mA																																																										
D3	IMLED3	0																																																													
D2	IMLED2	0																																																													
D1	IMLED1	0																																																													
D0	IMLED0	0																																																													

Address 04h <Sub Back Light current value>

BIT	Name	Initial	Function																																																												
			0	1																																																											
D7	-	-	-	-																																																											
D6	-	-	-	-																																																											
D5	-	-	-	-																																																											
D4	ISLED4	0	<table border="1"> <thead> <tr> <th>ISLED4</th> <th>ISLED3</th> <th>ISLED2</th> <th>ISLED1</th> <th>ISLED0</th> <th>Current value</th> </tr> </thead> <tbody> <tr> <td>0</td> <td>0</td> <td>0</td> <td>0</td> <td>0</td> <td>1mA</td> </tr> <tr> <td>0</td> <td>0</td> <td>0</td> <td>0</td> <td>1</td> <td>2mA</td> </tr> <tr> <td>0</td> <td>0</td> <td>0</td> <td>1</td> <td>0</td> <td>3mA</td> </tr> <tr> <td>.</td> <td>.</td> <td>.</td> <td>.</td> <td>.</td> <td rowspan="3">1mA Step</td> </tr> <tr> <td>.</td> <td>.</td> <td>.</td> <td>.</td> <td>.</td> </tr> <tr> <td>.</td> <td>.</td> <td>.</td> <td>.</td> <td>.</td> </tr> <tr> <td>1</td> <td>1</td> <td>1</td> <td>0</td> <td>1</td> <td>30mA</td> </tr> <tr> <td>1</td> <td>1</td> <td>1</td> <td>1</td> <td>0</td> <td>31mA</td> </tr> <tr> <td>1</td> <td>1</td> <td>1</td> <td>1</td> <td>1</td> <td>32mA</td> </tr> </tbody> </table> <p>When 120kΩ is connected to ISET pin.</p>			ISLED4	ISLED3	ISLED2	ISLED1	ISLED0	Current value	0	0	0	0	0	1mA	0	0	0	0	1	2mA	0	0	0	1	0	3mA	.	.	.	.	.	1mA Step	.	.	.	.	.	.	.	.	.	.	1	1	1	0	1	30mA	1	1	1	1	0	31mA	1	1	1	1	1	32mA
ISLED4	ISLED3	ISLED2				ISLED1	ISLED0	Current value																																																							
0	0	0				0	0	1mA																																																							
0	0	0				0	1	2mA																																																							
0	0	0				1	0	3mA																																																							
.	.	.				.	.	1mA Step																																																							
.	.	.				.	.																																																								
.	.	.				.	.																																																								
1	1	1	0	1	30mA																																																										
1	1	1	1	0	31mA																																																										
1	1	1	1	1	32mA																																																										
D3	ISLED3	0																																																													
D2	ISLED2	0																																																													
D1	ISLED1	0																																																													
D0	ISLED0	0																																																													

Address 05h <Control RGB1, RGB2 LED, Setting GB LED connection>

BIT	Name	Initial	Function	
			0	1
D7	-	-	-	-
D6	B2LEDMD	0	B2LED connection =VBAT	B2LED connection =VOUT
D5	G2LEDMD	0	G2LED connection =VBAT	G2LED connection =VOUT
D4	RGB2STA	0	RGB2 LED Lighting stop	RGB2 LED Lighting start
D3	-	-	-	-
D2	B1LEDMD	0	B1LED connection =VBAT	B1LED connection =VOUT
D1	G1LEDMD	0	G1LED connection =VBAT	G1LED connection =VOUT
D0	RGB1STA	0	RGB1 LED Lighting stop	RGB1 LED Lighting start

Address 06h <Control RGB1 LED>

BIT	Name	Initial	Function	
			0	1
D7	RGB1MD1	0	Refer to the following	Refer to the following
D6	RGB1MD0	0	Refer to the following	Refer to the following
D5	B1LEDPL	0	Refer to the following	Refer to the following
D4	G1LEDPL	0	Refer to the following	Refer to the following
D3	R1LEDPL	0	Refer to the following	Refer to the following
D2	B1LEDEN	0	B1 LED OFF	B1 LED ON
D1	G1LEDEN	0	G1 LED OFF	G1 LED ON
D0	R1LEDEN	0	R1 LED OFF	R1 LED ON

RGB1MD1	RGB1MD0	*1LEDPL	Mode
0	0	0 / 1	Normal 1
0	1	0 / 1	Normal 2
1	0	0	Blink 1
		1	Blink 2
1	1	0	Slope 1
		1	Slope 2

\*1LEDPL : R1LEDPL, G1LEDPL, B1LEDPL is shown.

Address 07h <RGB1 ON time setting>

BIT	Name	Initial	Function																																											
D7	RGB1WT1TM3	0	<table border="1"> <thead> <tr> <th>RGB1WT1TM3</th> <th>RGB1WT1TM2</th> <th>RGB1WT1TM1</th> <th>RGB1WT1TM0</th> <th>Current light time</th> </tr> </thead> <tbody> <tr> <td>0</td> <td>0</td> <td>0</td> <td>0</td> <td>0.256s</td> </tr> <tr> <td>0</td> <td>0</td> <td>0</td> <td>1</td> <td>0.512s</td> </tr> <tr> <td>.</td> <td>.</td> <td>.</td> <td>.</td> <td rowspan="3">0.256s Step</td> </tr> <tr> <td>.</td> <td>.</td> <td>.</td> <td>.</td> </tr> <tr> <td>.</td> <td>.</td> <td>.</td> <td>.</td> </tr> <tr> <td>1</td> <td>1</td> <td>0</td> <td>1</td> <td>3.584s</td> </tr> <tr> <td>1</td> <td>1</td> <td>1</td> <td>0</td> <td>3.84s</td> </tr> <tr> <td>1</td> <td>1</td> <td>1</td> <td>1</td> <td>4.096s</td> </tr> </tbody> </table> <p>Lighting time depends on internal OSC frequency.</p>	RGB1WT1TM3	RGB1WT1TM2	RGB1WT1TM1	RGB1WT1TM0	Current light time	0	0	0	0	0.256s	0	0	0	1	0.512s	.	.	.	.	0.256s Step	.	.	.	.	.	.	.	.	1	1	0	1	3.584s	1	1	1	0	3.84s	1	1	1	1	4.096s
RGB1WT1TM3	RGB1WT1TM2	RGB1WT1TM1		RGB1WT1TM0	Current light time																																									
0	0	0		0	0.256s																																									
0	0	0		1	0.512s																																									
.	.	.		.	0.256s Step																																									
.	.	.		.																																										
.	.	.		.																																										
1	1	0		1	3.584s																																									
1	1	1		0	3.84s																																									
1	1	1		1	4.096s																																									
D6	RGB1WT1TM2	0																																												
D5	RGB1WT1TM1	0																																												
D4	RGB1WT1TM0	0																																												
D3	RGB1WT2TM3	0	<table border="1"> <thead> <tr> <th>RGB1WT2TM3</th> <th>RGB1WT2TM2</th> <th>RGB1WT2TM1</th> <th>RGB1WT2TM0</th> <th>Current light time</th> </tr> </thead> <tbody> <tr> <td>0</td> <td>0</td> <td>0</td> <td>0</td> <td>0.256s</td> </tr> <tr> <td>0</td> <td>0</td> <td>0</td> <td>1</td> <td>0.512s</td> </tr> <tr> <td>.</td> <td>.</td> <td>.</td> <td>.</td> <td rowspan="3">0.256s Step</td> </tr> <tr> <td>.</td> <td>.</td> <td>.</td> <td>.</td> </tr> <tr> <td>.</td> <td>.</td> <td>.</td> <td>.</td> </tr> <tr> <td>1</td> <td>1</td> <td>0</td> <td>1</td> <td>3.584s</td> </tr> <tr> <td>1</td> <td>1</td> <td>1</td> <td>0</td> <td>3.84s</td> </tr> <tr> <td>1</td> <td>1</td> <td>1</td> <td>1</td> <td>4.096s</td> </tr> </tbody> </table> <p>Lighting time depends on internal OSC frequency.</p>	RGB1WT2TM3	RGB1WT2TM2	RGB1WT2TM1	RGB1WT2TM0	Current light time	0	0	0	0	0.256s	0	0	0	1	0.512s	.	.	.	.	0.256s Step	.	.	.	.	.	.	.	.	1	1	0	1	3.584s	1	1	1	0	3.84s	1	1	1	1	4.096s
RGB1WT2TM3	RGB1WT2TM2	RGB1WT2TM1		RGB1WT2TM0	Current light time																																									
0	0	0		0	0.256s																																									
0	0	0		1	0.512s																																									
.	.	.		.	0.256s Step																																									
.	.	.		.																																										
.	.	.		.																																										
1	1	0		1	3.584s																																									
1	1	1	0	3.84s																																										
1	1	1	1	4.096s																																										
D2	RGB1WT2TM2	0																																												
D1	RGB1WT2TM1	0																																												
D0	RGB1WT2TM0	0																																												

Address 08h <RGB1 slope 1step time setting>

BIT	Name	Initial	Function																																			
			RGB1SL1 STEP3	RGB1SL1 STEP2	RGB1SL1 STEP1	RGB1SL1 STEP0	Current light time																															
D7	RGB1SL1STEP3	0	<table border="1"> <tr><td>0</td><td>0</td><td>0</td><td>0</td><td>4ms</td></tr> <tr><td>0</td><td>0</td><td>0</td><td>1</td><td>8ms</td></tr> <tr><td>.</td><td>.</td><td>.</td><td>.</td><td>4ms Step</td></tr> <tr><td>.</td><td>.</td><td>.</td><td>.</td><td></td></tr> <tr><td>1</td><td>1</td><td>0</td><td>1</td><td>56ms</td></tr> <tr><td>1</td><td>1</td><td>1</td><td>0</td><td>60ms</td></tr> <tr><td>1</td><td>1</td><td>1</td><td>1</td><td>64ms</td></tr> </table> <p>Lighting time depends on internal OSC frequency.</p>	0	0	0	0	4ms	0	0	0	1	8ms	.	.	.	.	4ms Step	.	.	.	.		1	1	0	1	56ms	1	1	1	0	60ms	1	1	1	1	64ms
0	0	0		0	4ms																																	
0	0	0		1	8ms																																	
.	.	.		.	4ms Step																																	
.	.	.		.																																		
1	1	0		1	56ms																																	
1	1	1		0	60ms																																	
1	1	1		1	64ms																																	
D6	RGB1SL1STEP2	0																																				
D5	RGB1SL1STEP1	0																																				
D4	RGB1SL1STEP0	0																																				
D3	RGB1SL2STEP3	0	<table border="1"> <tr><td>0</td><td>0</td><td>0</td><td>0</td><td>4ms</td></tr> <tr><td>0</td><td>0</td><td>0</td><td>1</td><td>8ms</td></tr> <tr><td>.</td><td>.</td><td>.</td><td>.</td><td>4ms Step</td></tr> <tr><td>.</td><td>.</td><td>.</td><td>.</td><td></td></tr> <tr><td>1</td><td>1</td><td>0</td><td>1</td><td>56ms</td></tr> <tr><td>1</td><td>1</td><td>1</td><td>0</td><td>60ms</td></tr> <tr><td>1</td><td>1</td><td>1</td><td>1</td><td>64ms</td></tr> </table> <p>Lighting time depends on internal OSC frequency.</p>	0	0	0	0	4ms	0	0	0	1	8ms	.	.	.	.	4ms Step	.	.	.	.		1	1	0	1	56ms	1	1	1	0	60ms	1	1	1	1	64ms
0	0	0		0	4ms																																	
0	0	0		1	8ms																																	
.	.	.		.	4ms Step																																	
.	.	.		.																																		
1	1	0		1	56ms																																	
1	1	1		0	60ms																																	
1	1	1		1	64ms																																	
D2	RGB1SL2STEP2	0																																				
D1	RGB1SL2STEP1	0																																				
D0	RGB1SL2STEP0	0																																				

Address 09h <RGB1 slope step number setting>

BIT	Name	Initial	Function																																
			0		1																														
D7	-	-	-	-	-	-																													
D6	-	-	-	-	-	-																													
D5	-	-	-	-	-	-																													
D4	-	-	-	-	-	-																													
D3	-	-																																	
D2	RGB1SLNUM2	0	<table border="1"> <tr><td>0</td><td>0</td><td>0</td><td>1 Step</td></tr> <tr><td>0</td><td>0</td><td>1</td><td>2 Step</td></tr> <tr><td>0</td><td>1</td><td>0</td><td>4 Step</td></tr> <tr><td>0</td><td>1</td><td>1</td><td>8 Step</td></tr> <tr><td>1</td><td>0</td><td>0</td><td>16 Step</td></tr> <tr><td>1</td><td>0</td><td>1</td><td>32 Step</td></tr> <tr><td>1</td><td>1</td><td>0</td><td>64 Step</td></tr> <tr><td>1</td><td>1</td><td>1</td><td>(Prohibited)</td></tr> </table>	0	0	0	1 Step	0	0	1	2 Step	0	1	0	4 Step	0	1	1	8 Step	1	0	0	16 Step	1	0	1	32 Step	1	1	0	64 Step	1	1	1	(Prohibited)
0	0	0		1 Step																															
0	0	1		2 Step																															
0	1	0		4 Step																															
0	1	1		8 Step																															
1	0	0		16 Step																															
1	0	1		32 Step																															
1	1	0		64 Step																															
1	1	1		(Prohibited)																															
D1	RGB1SLNUM1	0																																	
D0	RGB1SLNUM0	0																																	



Address 0Ah &lt;R1 LED current value 1&gt;

BIT	Name	Initial	Function						
			0		1				
D7	-	-	-		-				
D6	-	-	-		-				
D5	I1R1LED5	0							
D4	I1R1LED4	0	I1R1 LED5	I1R1 LED4	I1R1 LED3	I1R1 LED2	I1R1 LED1	I1R1 LED0	Current value
D3	I1R1LED3	0	0	0	0	0	0	0	0mA
D2	I1R1LED2	0	0	0	0	0	0	1	0.5mA
D1	I1R1LED1	0	0	0	0	0	1	0	1mA
D0	I1R1LED0	0	.	.	.	.	.	.	0.5mA Step
			.	.	.	.	.	.	
			.	.	.	.	.	.	
			.	.	.	.	.	.	
			1	1	1	1	0	1	30.5mA
			1	1	1	1	1	0	31mA
			1	1	1	1	1	1	31.5mA

When 120kΩ is connected to ISET pin.

Address 0Bh &lt;Δ current value for R1 LED current step&gt;

BIT	Name	Initial	Function						
			0		1				
D7	-	-	-		-				
D6	-	-	-		-				
D5	IDLTR1LED5	0							
D4	IDLTR1LED4	0	IDLTR1 LED5	IDLTR1 LED4	IDLTR1 LED3	IDLTR1 LED2	IDLTR1 LED1	IDLTR1 LED0	Current value
D3	IDLTR1LED3	0	0	0	0	0	0	0	0mA
D2	IDLTR1LED2	0	0	0	0	0	0	1	0.5mA
D1	IDLTR1LED1	0	0	0	0	0	1	0	1mA
D0	IDLTR1LED0	0	.	.	.	.	.	.	0.5mA Step
			.	.	.	.	.	.	
			.	.	.	.	.	.	
			.	.	.	.	.	.	
			1	1	1	1	0	1	30.5mA
			1	1	1	1	1	0	31mA
			1	1	1	1	1	1	31.5mA

When 120kΩ is connected to ISET pin.

Address 0Ch &lt;G1 LED current value1&gt;

BIT	Name	Initial	Function																																																																							
			0		1																																																																					
D7	-	-	-		-																																																																					
D6	-	-	-		-																																																																					
D5	I1G1LED5	0	<table border="1"> <thead> <tr> <th>I1G1 LED5</th> <th>I1G1 LED4</th> <th>I1G1 LED3</th> <th>I1G1 LED2</th> <th>I1G1 LED1</th> <th>I1G1 LED0</th> <th>Current value</th> </tr> </thead> <tbody> <tr> <td>0</td> <td>0</td> <td>0</td> <td>0</td> <td>0</td> <td>0</td> <td>0mA</td> </tr> <tr> <td>0</td> <td>0</td> <td>0</td> <td>0</td> <td>0</td> <td>1</td> <td>0.5mA</td> </tr> <tr> <td>0</td> <td>0</td> <td>0</td> <td>0</td> <td>1</td> <td>0</td> <td>1mA</td> </tr> <tr> <td>.</td> <td>.</td> <td>.</td> <td>.</td> <td>.</td> <td>.</td> <td rowspan="3">0.5mA Step</td> </tr> <tr> <td>.</td> <td>.</td> <td>.</td> <td>.</td> <td>.</td> <td>.</td> </tr> <tr> <td>.</td> <td>.</td> <td>.</td> <td>.</td> <td>.</td> <td>.</td> </tr> <tr> <td>1</td> <td>1</td> <td>1</td> <td>1</td> <td>0</td> <td>1</td> <td>30.5mA</td> </tr> <tr> <td>1</td> <td>1</td> <td>1</td> <td>1</td> <td>1</td> <td>0</td> <td>31mA</td> </tr> <tr> <td>1</td> <td>1</td> <td>1</td> <td>1</td> <td>1</td> <td>1</td> <td>31.5mA</td> </tr> </tbody> </table>				I1G1 LED5	I1G1 LED4	I1G1 LED3	I1G1 LED2	I1G1 LED1	I1G1 LED0	Current value	0	0	0	0	0	0	0mA	0	0	0	0	0	1	0.5mA	0	0	0	0	1	0	1mA	.	.	.	.	.	.	0.5mA Step	.	.	.	.	.	.	.	.	.	.	.	.	1	1	1	1	0	1	30.5mA	1	1	1	1	1	0	31mA	1	1	1	1	1	1	31.5mA
I1G1 LED5	I1G1 LED4	I1G1 LED3					I1G1 LED2	I1G1 LED1	I1G1 LED0	Current value																																																																
0	0	0					0	0	0	0mA																																																																
0	0	0					0	0	1	0.5mA																																																																
0	0	0					0	1	0	1mA																																																																
.	.	.					.	.	.	0.5mA Step																																																																
.	.	.					.	.	.																																																																	
.	.	.					.	.	.																																																																	
1	1	1					1	0	1	30.5mA																																																																
1	1	1					1	1	0	31mA																																																																
1	1	1	1	1	1	31.5mA																																																																				
D4	I1G1LED4	0																																																																								
D3	I1G1LED3	0																																																																								
D2	I1G1LED2	0																																																																								
D1	I1G1LED1	0																																																																								
D0	I1G1LED0	0																																																																								

When 120kΩ is connected to ISET pin.

Address 0Dh &lt;Δ current value for G1 LED current step &gt;

BIT	Name	Initial	Function																																																																							
			0		1																																																																					
D7	-	-	-		-																																																																					
D6	-	-	-		-																																																																					
D5	IDLTG1LED5	0	<table border="1"> <thead> <tr> <th>IDLTG1 LED5</th> <th>IDLTG1 LED4</th> <th>IDLTG1 LED3</th> <th>IDLTG1 LED2</th> <th>IDLTG1 LED1</th> <th>IDLTG1 LED0</th> <th>Current value</th> </tr> </thead> <tbody> <tr> <td>0</td> <td>0</td> <td>0</td> <td>0</td> <td>0</td> <td>0</td> <td>0mA</td> </tr> <tr> <td>0</td> <td>0</td> <td>0</td> <td>0</td> <td>0</td> <td>1</td> <td>0.5mA</td> </tr> <tr> <td>0</td> <td>0</td> <td>0</td> <td>0</td> <td>1</td> <td>0</td> <td>1mA</td> </tr> <tr> <td>.</td> <td>.</td> <td>.</td> <td>.</td> <td>.</td> <td>.</td> <td rowspan="3">0.5mA Step</td> </tr> <tr> <td>.</td> <td>.</td> <td>.</td> <td>.</td> <td>.</td> <td>.</td> </tr> <tr> <td>.</td> <td>.</td> <td>.</td> <td>.</td> <td>.</td> <td>.</td> </tr> <tr> <td>1</td> <td>1</td> <td>1</td> <td>1</td> <td>0</td> <td>1</td> <td>30.5mA</td> </tr> <tr> <td>1</td> <td>1</td> <td>1</td> <td>1</td> <td>1</td> <td>0</td> <td>31mA</td> </tr> <tr> <td>1</td> <td>1</td> <td>1</td> <td>1</td> <td>1</td> <td>1</td> <td>31.5mA</td> </tr> </tbody> </table>				IDLTG1 LED5	IDLTG1 LED4	IDLTG1 LED3	IDLTG1 LED2	IDLTG1 LED1	IDLTG1 LED0	Current value	0	0	0	0	0	0	0mA	0	0	0	0	0	1	0.5mA	0	0	0	0	1	0	1mA	.	.	.	.	.	.	0.5mA Step	.	.	.	.	.	.	.	.	.	.	.	.	1	1	1	1	0	1	30.5mA	1	1	1	1	1	0	31mA	1	1	1	1	1	1	31.5mA
IDLTG1 LED5	IDLTG1 LED4	IDLTG1 LED3					IDLTG1 LED2	IDLTG1 LED1	IDLTG1 LED0	Current value																																																																
0	0	0					0	0	0	0mA																																																																
0	0	0					0	0	1	0.5mA																																																																
0	0	0					0	1	0	1mA																																																																
.	.	.					.	.	.	0.5mA Step																																																																
.	.	.					.	.	.																																																																	
.	.	.					.	.	.																																																																	
1	1	1					1	0	1	30.5mA																																																																
1	1	1					1	1	0	31mA																																																																
1	1	1	1	1	1	31.5mA																																																																				
D4	IDLTG1LED4	0																																																																								
D3	IDLTG1LED3	0																																																																								
D2	IDLTG1LED2	0																																																																								
D1	IDLTG1LED1	0																																																																								
D0	IDLTG1LED0	0																																																																								

When 120kΩ is connected to ISET pin.

Address 0Eh <B1 LED Current value1>

BIT	Name	Initial	Function																																																																																
			0		1																																																																														
D7	-	-	-		-																																																																														
D6	-	-	-		-																																																																														
D5	I1B1LED5	0	<table border="1"> <thead> <tr> <th>I1B1 LED5</th> <th>I1B1 LED4</th> <th>I1B1 LED3</th> <th>I1B1 LED2</th> <th>I1B1 LED1</th> <th>I1B1 LED0</th> <th>Current value</th> </tr> </thead> <tbody> <tr> <td>0</td> <td>0</td> <td>0</td> <td>0</td> <td>0</td> <td>0</td> <td>0mA</td> </tr> <tr> <td>0</td> <td>0</td> <td>0</td> <td>0</td> <td>0</td> <td>1</td> <td>0.5mA</td> </tr> <tr> <td>0</td> <td>0</td> <td>0</td> <td>0</td> <td>1</td> <td>0</td> <td>1mA</td> </tr> <tr> <td>.</td> <td>.</td> <td>.</td> <td>.</td> <td>.</td> <td>.</td> <td rowspan="4">0.5mA Step</td> </tr> <tr> <td>.</td> <td>.</td> <td>.</td> <td>.</td> <td>.</td> <td>.</td> </tr> <tr> <td>.</td> <td>.</td> <td>.</td> <td>.</td> <td>.</td> <td>.</td> </tr> <tr> <td>.</td> <td>.</td> <td>.</td> <td>.</td> <td>.</td> <td>.</td> </tr> <tr> <td></td> <td></td> <td></td> <td>1</td> <td>1</td> <td>0</td> <td>1</td> <td>30.5mA</td> </tr> <tr> <td></td> <td></td> <td></td> <td>1</td> <td>1</td> <td>1</td> <td>0</td> <td>31mA</td> </tr> <tr> <td></td> <td></td> <td></td> <td>1</td> <td>1</td> <td>1</td> <td>1</td> <td>31.5mA</td> </tr> </tbody> </table>				I1B1 LED5	I1B1 LED4	I1B1 LED3	I1B1 LED2	I1B1 LED1	I1B1 LED0	Current value	0	0	0	0	0	0	0mA	0	0	0	0	0	1	0.5mA	0	0	0	0	1	0	1mA	.	.	.	.	.	.	0.5mA Step	.	.	.	.	.	.	.	.	.	.	.	.	.	.	.	.	.	.				1	1	0	1	30.5mA				1	1	1	0	31mA				1	1	1	1	31.5mA
I1B1 LED5	I1B1 LED4	I1B1 LED3					I1B1 LED2	I1B1 LED1	I1B1 LED0	Current value																																																																									
0	0	0					0	0	0	0mA																																																																									
0	0	0					0	0	1	0.5mA																																																																									
0	0	0					0	1	0	1mA																																																																									
.	.	.					.	.	.	0.5mA Step																																																																									
.	.	.					.	.	.																																																																										
.	.	.					.	.	.																																																																										
.	.	.					.	.	.																																																																										
							1	1	0	1	30.5mA																																																																								
			1	1	1	0	31mA																																																																												
			1	1	1	1	31.5mA																																																																												
D4	I1B1LED4	0																																																																																	
D3	I1B1LED3	0																																																																																	
D2	I1B1LED2	0																																																																																	
D1	I1B1LED1	0																																																																																	
D0	I1B1LED0	0																																																																																	

When 120kΩ is connected to ISET pin.

Address 0Fh <Δ current value for B1 LED current step >

BIT	Name	Initial	Function																																																																																
			0		1																																																																														
D7	-	-	-		-																																																																														
D6	-	-	-		-																																																																														
D5	IDLTB1LED5	0	<table border="1"> <thead> <tr> <th>IDLTB1 LED5</th> <th>IDLTB1 LED4</th> <th>IDLTB1 LED3</th> <th>IDLTB1 LED2</th> <th>IDLTB1 LED1</th> <th>IDLTB1 LED0</th> <th>Current value</th> </tr> </thead> <tbody> <tr> <td>0</td> <td>0</td> <td>0</td> <td>0</td> <td>0</td> <td>0</td> <td>0mA</td> </tr> <tr> <td>0</td> <td>0</td> <td>0</td> <td>0</td> <td>0</td> <td>1</td> <td>0.5mA</td> </tr> <tr> <td>0</td> <td>0</td> <td>0</td> <td>0</td> <td>1</td> <td>0</td> <td>1mA</td> </tr> <tr> <td>.</td> <td>.</td> <td>.</td> <td>.</td> <td>.</td> <td>.</td> <td rowspan="4">0.5mA Step</td> </tr> <tr> <td>.</td> <td>.</td> <td>.</td> <td>.</td> <td>.</td> <td>.</td> </tr> <tr> <td>.</td> <td>.</td> <td>.</td> <td>.</td> <td>.</td> <td>.</td> </tr> <tr> <td>.</td> <td>.</td> <td>.</td> <td>.</td> <td>.</td> <td>.</td> </tr> <tr> <td></td> <td></td> <td></td> <td>1</td> <td>1</td> <td>0</td> <td>1</td> <td>30.5mA</td> </tr> <tr> <td></td> <td></td> <td></td> <td>1</td> <td>1</td> <td>1</td> <td>0</td> <td>31mA</td> </tr> <tr> <td></td> <td></td> <td></td> <td>1</td> <td>1</td> <td>1</td> <td>1</td> <td>31.5mA</td> </tr> </tbody> </table>				IDLTB1 LED5	IDLTB1 LED4	IDLTB1 LED3	IDLTB1 LED2	IDLTB1 LED1	IDLTB1 LED0	Current value	0	0	0	0	0	0	0mA	0	0	0	0	0	1	0.5mA	0	0	0	0	1	0	1mA	.	.	.	.	.	.	0.5mA Step	.	.	.	.	.	.	.	.	.	.	.	.	.	.	.	.	.	.				1	1	0	1	30.5mA				1	1	1	0	31mA				1	1	1	1	31.5mA
IDLTB1 LED5	IDLTB1 LED4	IDLTB1 LED3					IDLTB1 LED2	IDLTB1 LED1	IDLTB1 LED0	Current value																																																																									
0	0	0					0	0	0	0mA																																																																									
0	0	0					0	0	1	0.5mA																																																																									
0	0	0					0	1	0	1mA																																																																									
.	.	.					.	.	.	0.5mA Step																																																																									
.	.	.					.	.	.																																																																										
.	.	.					.	.	.																																																																										
.	.	.					.	.	.																																																																										
							1	1	0	1	30.5mA																																																																								
			1	1	1	0	31mA																																																																												
			1	1	1	1	31.5mA																																																																												
D4	IDLTB1LED4	0																																																																																	
D3	IDLTB1LED3	0																																																																																	
D2	IDLTB1LED2	0																																																																																	
D1	IDLTB1LED1	0																																																																																	
D0	IDLTB1LED0	0																																																																																	

When 120kΩ is connected to ISET pin.

Address 10h <Control RGB2 LED>

BIT	Name	Initial	Function	
			0	1
D7	RGB2MD1	0	Refer to following	Refer to following
D6	RGB2MD0	0	Refer to following	Refer to following
D5	B2LEDPL	0	Refer to following	Refer to following
D4	G2LEDPL	0	Refer to following	Refer to following
D3	R2LEDPL	0	Refer to following	Refer to following
D2	B2LEDEN	0	B2 LED OFF	B2 LED ON
D1	G2LEDEN	0	G2 LED OFF	G2 LED ON
D0	R2LEDEN	0	R2 LED OFF	R2 LED ON

RGB2MD1	RGB2MD0	*2LEDPL	Mode
0	0	0 / 1	Normal 1
0	1	0 / 1	Normal 2
1	0	0	Blink 1
		1	Blink 2
1	1	0	Slope 1
		1	Slope 2

\*2LEDPL : R2LEDPL, G2LEDPL, B2LEDPL is shown.

Address 11h <RGB2 ON time setting>

BIT	Name	Initial	Function																																			
D7	RGB2WT1TM3	0	<table border="1"> <thead> <tr> <th>RGB2WT1 TM3</th> <th>RGB2WT1 TM2</th> <th>RGB2WT1 TM1</th> <th>RGB2WT1 TM0</th> <th>Current ON time setting</th> </tr> </thead> <tbody> <tr> <td>0</td> <td>0</td> <td>0</td> <td>0</td> <td>0.256s</td> </tr> <tr> <td>0</td> <td>0</td> <td>0</td> <td>1</td> <td>0.512s</td> </tr> <tr> <td>.</td> <td>.</td> <td>.</td> <td>.</td> <td>0.256s Step</td> </tr> <tr> <td>1</td> <td>1</td> <td>0</td> <td>1</td> <td>3.584s</td> </tr> <tr> <td>1</td> <td>1</td> <td>1</td> <td>0</td> <td>3.845s</td> </tr> <tr> <td>1</td> <td>1</td> <td>1</td> <td>1</td> <td>4.096s</td> </tr> </tbody> </table> <p>Lighting time depends on internal OSC frequency.</p>	RGB2WT1 TM3	RGB2WT1 TM2	RGB2WT1 TM1	RGB2WT1 TM0	Current ON time setting	0	0	0	0	0.256s	0	0	0	1	0.512s	.	.	.	.	0.256s Step	1	1	0	1	3.584s	1	1	1	0	3.845s	1	1	1	1	4.096s
RGB2WT1 TM3	RGB2WT1 TM2	RGB2WT1 TM1		RGB2WT1 TM0	Current ON time setting																																	
0	0	0		0	0.256s																																	
0	0	0		1	0.512s																																	
.	.	.		.	0.256s Step																																	
1	1	0		1	3.584s																																	
1	1	1		0	3.845s																																	
1	1	1		1	4.096s																																	
D6	RGB2WT1TM2	0																																				
D5	RGB2WT1TM1	0																																				
D4	RGB2WT1TM0	0																																				
D3	RGB2WT2TM3	0	<table border="1"> <thead> <tr> <th>RGB2WT2 TM3</th> <th>RGB2WT2 TM2</th> <th>RGB2WT2 TM1</th> <th>RGB2WT2 TM0</th> <th>Current ON time setting</th> </tr> </thead> <tbody> <tr> <td>0</td> <td>0</td> <td>0</td> <td>0</td> <td>0.256s</td> </tr> <tr> <td>0</td> <td>0</td> <td>0</td> <td>1</td> <td>0.512s</td> </tr> <tr> <td>.</td> <td>.</td> <td>.</td> <td>.</td> <td>0.256s Step</td> </tr> <tr> <td>1</td> <td>1</td> <td>0</td> <td>1</td> <td>3.584s</td> </tr> <tr> <td>1</td> <td>1</td> <td>1</td> <td>0</td> <td>3.845s</td> </tr> <tr> <td>1</td> <td>1</td> <td>1</td> <td>1</td> <td>4.096s</td> </tr> </tbody> </table> <p>Lighting time depends on internal OSC frequency.</p>	RGB2WT2 TM3	RGB2WT2 TM2	RGB2WT2 TM1	RGB2WT2 TM0	Current ON time setting	0	0	0	0	0.256s	0	0	0	1	0.512s	.	.	.	.	0.256s Step	1	1	0	1	3.584s	1	1	1	0	3.845s	1	1	1	1	4.096s
RGB2WT2 TM3	RGB2WT2 TM2	RGB2WT2 TM1		RGB2WT2 TM0	Current ON time setting																																	
0	0	0		0	0.256s																																	
0	0	0		1	0.512s																																	
.	.	.		.	0.256s Step																																	
1	1	0		1	3.584s																																	
1	1	1		0	3.845s																																	
1	1	1	1	4.096s																																		
D2	RGB2WT2TM2	0																																				
D1	RGB2WT2TM1	0																																				
D0	RGB2WT2TM0	0																																				

Address 12h <RGB2 slope 1step time setting>

BIT	Name	Initial	Function																																												
D7	RGB2SL1STEP3	0	<table border="1"> <thead> <tr> <th>RGB2SL1STEP3</th> <th>RGB2SL1STEP2</th> <th>RGB2SL1STEP1</th> <th>RGB2SL1STEP0</th> <th>Current ON time setting</th> </tr> </thead> <tbody> <tr> <td>0</td> <td>0</td> <td>0</td> <td>0</td> <td>4ms</td> </tr> <tr> <td>0</td> <td>0</td> <td>0</td> <td>1</td> <td>8ms</td> </tr> <tr> <td>.</td> <td>.</td> <td>.</td> <td>.</td> <td>4ms</td> </tr> <tr> <td>.</td> <td>.</td> <td>.</td> <td>.</td> <td>Step</td> </tr> <tr> <td>1</td> <td>1</td> <td>0</td> <td>1</td> <td>56ms</td> </tr> <tr> <td>1</td> <td>1</td> <td>1</td> <td>0</td> <td>60ms</td> </tr> <tr> <td>1</td> <td>1</td> <td>1</td> <td>1</td> <td>64ms</td> </tr> </tbody> </table> <p>Lighting time depends on internal OSC frequency.</p>					RGB2SL1STEP3	RGB2SL1STEP2	RGB2SL1STEP1	RGB2SL1STEP0	Current ON time setting	0	0	0	0	4ms	0	0	0	1	8ms	.	.	.	.	4ms	.	.	.	.	Step	1	1	0	1	56ms	1	1	1	0	60ms	1	1	1	1	64ms
RGB2SL1STEP3	RGB2SL1STEP2	RGB2SL1STEP1						RGB2SL1STEP0	Current ON time setting																																						
0	0	0						0	4ms																																						
0	0	0						1	8ms																																						
.	.	.						.	4ms																																						
.	.	.						.	Step																																						
1	1	0						1	56ms																																						
1	1	1	0	60ms																																											
1	1	1	1	64ms																																											
D6	RGB2SL1STEP2	0																																													
D5	RGB2SL1STEP1	0																																													
D4	RGB2SL1STEP0	0																																													
D3	RGB2SL2STEP3	0	<table border="1"> <thead> <tr> <th>RGB2SL2STEP3</th> <th>RGB2SL2STEP2</th> <th>RGB2SL2STEP1</th> <th>RGB2SL2STEP0</th> <th>Current ON time setting</th> </tr> </thead> <tbody> <tr> <td>0</td> <td>0</td> <td>0</td> <td>0</td> <td>4ms</td> </tr> <tr> <td>0</td> <td>0</td> <td>0</td> <td>1</td> <td>8ms</td> </tr> <tr> <td>.</td> <td>.</td> <td>.</td> <td>.</td> <td>4ms</td> </tr> <tr> <td>.</td> <td>.</td> <td>.</td> <td>.</td> <td>Step</td> </tr> <tr> <td>1</td> <td>1</td> <td>0</td> <td>1</td> <td>56ms</td> </tr> <tr> <td>1</td> <td>1</td> <td>1</td> <td>0</td> <td>60ms</td> </tr> <tr> <td>1</td> <td>1</td> <td>1</td> <td>1</td> <td>64ms</td> </tr> </tbody> </table> <p>Lighting time depends on internal OSC frequency.</p>					RGB2SL2STEP3	RGB2SL2STEP2	RGB2SL2STEP1	RGB2SL2STEP0	Current ON time setting	0	0	0	0	4ms	0	0	0	1	8ms	.	.	.	.	4ms	.	.	.	.	Step	1	1	0	1	56ms	1	1	1	0	60ms	1	1	1	1	64ms
RGB2SL2STEP3	RGB2SL2STEP2	RGB2SL2STEP1						RGB2SL2STEP0	Current ON time setting																																						
0	0	0						0	4ms																																						
0	0	0						1	8ms																																						
.	.	.						.	4ms																																						
.	.	.						.	Step																																						
1	1	0						1	56ms																																						
1	1	1	0	60ms																																											
1	1	1	1	64ms																																											
D2	RGB2SL2STEP2	0																																													
D1	RGB2SL2STEP1	0																																													
D0	RGB2SL2STEP0	0																																													

Address 13h <RGB2 slope step number setting>

BIT	Name	Initial	Function																																					
			0	1																																				
D7	-	-	-	-																																				
D6	-	-	-	-																																				
D5	-	-	-	-																																				
D4	-	-	-	-																																				
D3	-	-																																						
D2	RGB2SLNUM2	0	<table border="1"> <thead> <tr> <th>RGB2SLNUM2</th> <th>RGB2SLNUM1</th> <th>RGB2SLNUM0</th> <th>Step</th> </tr> </thead> <tbody> <tr> <td>0</td> <td>0</td> <td>0</td> <td>1 Step</td> </tr> <tr> <td>0</td> <td>0</td> <td>1</td> <td>2 Step</td> </tr> <tr> <td>0</td> <td>1</td> <td>0</td> <td>4 Step</td> </tr> <tr> <td>0</td> <td>1</td> <td>1</td> <td>8 Step</td> </tr> <tr> <td>1</td> <td>0</td> <td>0</td> <td>16 Step</td> </tr> <tr> <td>1</td> <td>0</td> <td>1</td> <td>32 Step</td> </tr> <tr> <td>1</td> <td>1</td> <td>0</td> <td>64 Step</td> </tr> <tr> <td>1</td> <td>1</td> <td>1</td> <td>(Prohibited)</td> </tr> </tbody> </table>		RGB2SLNUM2	RGB2SLNUM1	RGB2SLNUM0	Step	0	0	0	1 Step	0	0	1	2 Step	0	1	0	4 Step	0	1	1	8 Step	1	0	0	16 Step	1	0	1	32 Step	1	1	0	64 Step	1	1	1	(Prohibited)
RGB2SLNUM2	RGB2SLNUM1	RGB2SLNUM0			Step																																			
0	0	0			1 Step																																			
0	0	1			2 Step																																			
0	1	0			4 Step																																			
0	1	1			8 Step																																			
1	0	0			16 Step																																			
1	0	1			32 Step																																			
1	1	0	64 Step																																					
1	1	1	(Prohibited)																																					
D1	RGB2SLNUM1	0																																						
D0	RGB2SLNUM0	0																																						

## Address 14h &lt;R2 LED current value1&gt;

BIT	Name	Initial	Function																																																																																
			0	1																																																																															
D7	-	-	-	-																																																																															
D6	-	-	-	-																																																																															
D5	I1R2LED5	0	<table border="1"> <thead> <tr> <th>I1R2LED5</th> <th>I1R2LED4</th> <th>I1R2LED3</th> <th>I1R2LED2</th> <th>I1R2LED1</th> <th>I1R2LED0</th> <th>Current value</th> </tr> </thead> <tbody> <tr> <td>0</td> <td>0</td> <td>0</td> <td>0</td> <td>0</td> <td>0</td> <td>0mA</td> </tr> <tr> <td>0</td> <td>0</td> <td>0</td> <td>0</td> <td>0</td> <td>1</td> <td>0.5mA</td> </tr> <tr> <td>0</td> <td>0</td> <td>0</td> <td>0</td> <td>1</td> <td>0</td> <td>1mA</td> </tr> <tr> <td>.</td> <td>.</td> <td>.</td> <td>.</td> <td>.</td> <td>.</td> <td rowspan="4">0.5mA Step</td> </tr> <tr> <td>.</td> <td>.</td> <td>.</td> <td>.</td> <td>.</td> <td>.</td> </tr> <tr> <td>.</td> <td>.</td> <td>.</td> <td>.</td> <td>.</td> <td>.</td> </tr> <tr> <td>.</td> <td>.</td> <td>.</td> <td>.</td> <td>.</td> <td>.</td> </tr> <tr> <td></td> <td></td> <td></td> <td>1</td> <td>1</td> <td>0</td> <td>1</td> <td>30.5mA</td> </tr> <tr> <td></td> <td></td> <td></td> <td>1</td> <td>1</td> <td>1</td> <td>0</td> <td>31mA</td> </tr> <tr> <td></td> <td></td> <td></td> <td>1</td> <td>1</td> <td>1</td> <td>1</td> <td>31.5mA</td> </tr> </tbody> </table> <p>When 120kΩ is connected to ISET pin.</p>				I1R2LED5	I1R2LED4	I1R2LED3	I1R2LED2	I1R2LED1	I1R2LED0	Current value	0	0	0	0	0	0	0mA	0	0	0	0	0	1	0.5mA	0	0	0	0	1	0	1mA	.	.	.	.	.	.	0.5mA Step	.	.	.	.	.	.	.	.	.	.	.	.	.	.	.	.	.	.				1	1	0	1	30.5mA				1	1	1	0	31mA				1	1	1	1	31.5mA
I1R2LED5	I1R2LED4	I1R2LED3					I1R2LED2	I1R2LED1	I1R2LED0	Current value																																																																									
0	0	0					0	0	0	0mA																																																																									
0	0	0					0	0	1	0.5mA																																																																									
0	0	0					0	1	0	1mA																																																																									
.	.	.					.	.	.	0.5mA Step																																																																									
.	.	.					.	.	.																																																																										
.	.	.					.	.	.																																																																										
.	.	.					.	.	.																																																																										
							1	1	0	1	30.5mA																																																																								
			1	1	1	0	31mA																																																																												
			1	1	1	1	31.5mA																																																																												
D4	I1R2LED4	0																																																																																	
D3	I1R2LED3	0																																																																																	
D2	I1R2LED2	0																																																																																	
D1	I1R2LED1	0																																																																																	
D0	I1R2LED0	0																																																																																	

## Address 15h &lt;Δ current value for R2 LED current step &gt;

BIT	Name	Initial	Function																																																																																
			0	1																																																																															
D7	-	-	-	-																																																																															
D6	-	-	-	-																																																																															
D5	IDLTR2LED5	0	<table border="1"> <thead> <tr> <th>IDLTR2 LED5</th> <th>IDLTR2 LED4</th> <th>IDLTR2 LED3</th> <th>IDLTR2 LED2</th> <th>IDLTR2 LED1</th> <th>IDLTR2 LED0</th> <th>Current value</th> </tr> </thead> <tbody> <tr> <td>0</td> <td>0</td> <td>0</td> <td>0</td> <td>0</td> <td>0</td> <td>0mA</td> </tr> <tr> <td>0</td> <td>0</td> <td>0</td> <td>0</td> <td>0</td> <td>1</td> <td>0.5mA</td> </tr> <tr> <td>0</td> <td>0</td> <td>0</td> <td>0</td> <td>1</td> <td>0</td> <td>1mA</td> </tr> <tr> <td>.</td> <td>.</td> <td>.</td> <td>.</td> <td>.</td> <td>.</td> <td rowspan="4">0.5mA Step</td> </tr> <tr> <td>.</td> <td>.</td> <td>.</td> <td>.</td> <td>.</td> <td>.</td> </tr> <tr> <td>.</td> <td>.</td> <td>.</td> <td>.</td> <td>.</td> <td>.</td> </tr> <tr> <td>.</td> <td>.</td> <td>.</td> <td>.</td> <td>.</td> <td>.</td> </tr> <tr> <td></td> <td></td> <td></td> <td>1</td> <td>1</td> <td>0</td> <td>1</td> <td>30.5mA</td> </tr> <tr> <td></td> <td></td> <td></td> <td>1</td> <td>1</td> <td>1</td> <td>0</td> <td>31mA</td> </tr> <tr> <td></td> <td></td> <td></td> <td>1</td> <td>1</td> <td>1</td> <td>1</td> <td>31.5mA</td> </tr> </tbody> </table> <p>When 120kΩ is connected to ISET pin.</p>				IDLTR2 LED5	IDLTR2 LED4	IDLTR2 LED3	IDLTR2 LED2	IDLTR2 LED1	IDLTR2 LED0	Current value	0	0	0	0	0	0	0mA	0	0	0	0	0	1	0.5mA	0	0	0	0	1	0	1mA	.	.	.	.	.	.	0.5mA Step	.	.	.	.	.	.	.	.	.	.	.	.	.	.	.	.	.	.				1	1	0	1	30.5mA				1	1	1	0	31mA				1	1	1	1	31.5mA
IDLTR2 LED5	IDLTR2 LED4	IDLTR2 LED3					IDLTR2 LED2	IDLTR2 LED1	IDLTR2 LED0	Current value																																																																									
0	0	0					0	0	0	0mA																																																																									
0	0	0					0	0	1	0.5mA																																																																									
0	0	0					0	1	0	1mA																																																																									
.	.	.					.	.	.	0.5mA Step																																																																									
.	.	.					.	.	.																																																																										
.	.	.					.	.	.																																																																										
.	.	.					.	.	.																																																																										
							1	1	0	1	30.5mA																																																																								
			1	1	1	0	31mA																																																																												
			1	1	1	1	31.5mA																																																																												
D4	IDLTR2LED4	0																																																																																	
D3	IDLTR2LED3	0																																																																																	
D2	IDLTR2LED2	0																																																																																	
D1	IDLTR2LED1	0																																																																																	
D0	IDLTR2LED0	0																																																																																	

Address 16h <G2 LED current value1>

BIT	Name	Initial	Function						
			0		1				
D7	-	-	-		-				
D6	-	-	-		-				
D5	I1G2LED5	0							
D4	I1G2LED4	0	I1G2LED5	I1G2LED4	I1G2LED3	I1G2LED2	I1G2LED1	I1G2LED0	Current value
D3	I1G2LED3	0	5	4	3	2	1	0	0mA
D2	I1G2LED2	0	0	0	0	0	0	1	0.5mA
D1	I1G2LED1	0	0	0	0	0	1	0	1mA
D0	I1G2LED0	0	.	.	.	.	.	.	0.5mA Step
			.	.	.	.	.	.	
			.	.	.	.	.	.	
			.	.	.	.	.	.	
			1	1	1	1	0	1	30.5mA
			1	1	1	1	1	0	31mA
			1	1	1	1	1	1	31.5mA

When 120kΩ is connected to ISET pin.

Address 17h <Δ current value for G2 LED current step >

BIT	Name	Initial	Function						
			0		1				
D7	-	-	-		-				
D6	-	-	-		-				
D5	IDLTG2LED5	0							
D4	IDLTG2LED4	0	IDLTG2 LED5	IDLTG2 LED4	IDLTG2 LED3	IDLTG2 LED2	IDLTG2 LED1	IDLTG2 LED0	Current value
D3	IDLTG2LED3	0	0	0	0	0	0	0	0mA
D2	IDLTG2LED2	0	0	0	0	0	0	1	0.5mA
D1	IDLTG2LED1	0	0	0	0	0	1	0	1mA
D0	IDLTG2LED0	0	.	.	.	.	.	.	0.5mA Step
			.	.	.	.	.	.	
			.	.	.	.	.	.	
			.	.	.	.	.	.	
			1	1	1	1	0	1	30.5mA
			1	1	1	1	1	0	31mA
			1	1	1	1	1	1	31.5mA

When 120kΩ is connected to ISET pin.

Address 18h &lt;B2 LED current value1&gt;

BIT	Name	Initial	Function																																																																							
			0	1																																																																						
D7	-	-	-	-																																																																						
D6	-	-	-	-																																																																						
D5	I1B2LED5	0	<table border="1"> <thead> <tr> <th>I1B2LED5</th> <th>I1B2LED4</th> <th>I1B2LED3</th> <th>I1B2LED2</th> <th>I1B2LED1</th> <th>I1B2LED0</th> <th>Current value</th> </tr> </thead> <tbody> <tr> <td>0</td> <td>0</td> <td>0</td> <td>0</td> <td>0</td> <td>0</td> <td>0mA</td> </tr> <tr> <td>0</td> <td>0</td> <td>0</td> <td>0</td> <td>0</td> <td>1</td> <td>0.5mA</td> </tr> <tr> <td>0</td> <td>0</td> <td>0</td> <td>0</td> <td>1</td> <td>0</td> <td>1mA</td> </tr> <tr> <td>.</td> <td>.</td> <td>.</td> <td>.</td> <td>.</td> <td>.</td> <td rowspan="3">0.5mA Step</td> </tr> <tr> <td>.</td> <td>.</td> <td>.</td> <td>.</td> <td>.</td> <td>.</td> </tr> <tr> <td>.</td> <td>.</td> <td>.</td> <td>.</td> <td>.</td> <td>.</td> </tr> <tr> <td>1</td> <td>1</td> <td>1</td> <td>1</td> <td>0</td> <td>1</td> <td>30.5mA</td> </tr> <tr> <td>1</td> <td>1</td> <td>1</td> <td>1</td> <td>1</td> <td>0</td> <td>31mA</td> </tr> <tr> <td>1</td> <td>1</td> <td>1</td> <td>1</td> <td>1</td> <td>1</td> <td>31.5mA</td> </tr> </tbody> </table> <p>When 120kΩ is connected to ISET pin.</p>				I1B2LED5	I1B2LED4	I1B2LED3	I1B2LED2	I1B2LED1	I1B2LED0	Current value	0	0	0	0	0	0	0mA	0	0	0	0	0	1	0.5mA	0	0	0	0	1	0	1mA	.	.	.	.	.	.	0.5mA Step	.	.	.	.	.	.	.	.	.	.	.	.	1	1	1	1	0	1	30.5mA	1	1	1	1	1	0	31mA	1	1	1	1	1	1	31.5mA
I1B2LED5	I1B2LED4	I1B2LED3					I1B2LED2	I1B2LED1	I1B2LED0	Current value																																																																
0	0	0					0	0	0	0mA																																																																
0	0	0					0	0	1	0.5mA																																																																
0	0	0					0	1	0	1mA																																																																
.	.	.					.	.	.	0.5mA Step																																																																
.	.	.					.	.	.																																																																	
.	.	.					.	.	.																																																																	
1	1	1					1	0	1	30.5mA																																																																
1	1	1					1	1	0	31mA																																																																
1	1	1	1	1	1	31.5mA																																																																				
D4	I1B2LED4	0																																																																								
D3	I1B2LED3	0																																																																								
D2	I1B2LED2	0																																																																								
D1	I1B2LED1	0																																																																								
D0	I1B2LED0	0																																																																								

Address 19h &lt;Δ current value for B2 LED current step &gt;

BIT	Name	Initial	Function																																																																							
			0	1																																																																						
D7	-	-	-	-																																																																						
D6	-	-	-	-																																																																						
D5	IDLTB2LED5	0	<table border="1"> <thead> <tr> <th>IDLTB2 LED5</th> <th>IDLTB2 LED4</th> <th>IDLTB2 LED3</th> <th>IDLTB2 LED2</th> <th>IDLTB2 LED1</th> <th>IDLTB2 LED0</th> <th>Current value</th> </tr> </thead> <tbody> <tr> <td>0</td> <td>0</td> <td>0</td> <td>0</td> <td>0</td> <td>0</td> <td>0mA</td> </tr> <tr> <td>0</td> <td>0</td> <td>0</td> <td>0</td> <td>0</td> <td>1</td> <td>0.5mA</td> </tr> <tr> <td>0</td> <td>0</td> <td>0</td> <td>0</td> <td>1</td> <td>0</td> <td>1mA</td> </tr> <tr> <td>.</td> <td>.</td> <td>.</td> <td>.</td> <td>.</td> <td>.</td> <td rowspan="3">0.5mA Step</td> </tr> <tr> <td>.</td> <td>.</td> <td>.</td> <td>.</td> <td>.</td> <td>.</td> </tr> <tr> <td>.</td> <td>.</td> <td>.</td> <td>.</td> <td>.</td> <td>.</td> </tr> <tr> <td>1</td> <td>1</td> <td>1</td> <td>1</td> <td>0</td> <td>1</td> <td>30.5mA</td> </tr> <tr> <td>1</td> <td>1</td> <td>1</td> <td>1</td> <td>1</td> <td>0</td> <td>31mA</td> </tr> <tr> <td>1</td> <td>1</td> <td>1</td> <td>1</td> <td>1</td> <td>1</td> <td>31.5mA</td> </tr> </tbody> </table> <p>When 120kΩ is connected to ISET pin.</p>				IDLTB2 LED5	IDLTB2 LED4	IDLTB2 LED3	IDLTB2 LED2	IDLTB2 LED1	IDLTB2 LED0	Current value	0	0	0	0	0	0	0mA	0	0	0	0	0	1	0.5mA	0	0	0	0	1	0	1mA	.	.	.	.	.	.	0.5mA Step	.	.	.	.	.	.	.	.	.	.	.	.	1	1	1	1	0	1	30.5mA	1	1	1	1	1	0	31mA	1	1	1	1	1	1	31.5mA
IDLTB2 LED5	IDLTB2 LED4	IDLTB2 LED3					IDLTB2 LED2	IDLTB2 LED1	IDLTB2 LED0	Current value																																																																
0	0	0					0	0	0	0mA																																																																
0	0	0					0	0	1	0.5mA																																																																
0	0	0					0	1	0	1mA																																																																
.	.	.					.	.	.	0.5mA Step																																																																
.	.	.					.	.	.																																																																	
.	.	.					.	.	.																																																																	
1	1	1					1	0	1	30.5mA																																																																
1	1	1					1	1	0	31mA																																																																
1	1	1	1	1	1	31.5mA																																																																				
D4	IDLTB2LED4	0																																																																								
D3	IDLTB2LED3	0																																																																								
D2	IDLTB2LED2	0																																																																								
D1	IDLTB2LED1	0																																																																								
D0	IDLTB2LED0	0																																																																								

Address 1Ah &lt;RGB1, RGB2 LED external ON/OFF control&gt;

BIT	Name	Initial	Function																
			0	1															
D7	-	-	-	-															
D6	-	-	-	-															
D5	-	-	-	-															
D4	-	-	-	-															
D3	-	-	-	-															
D2	-	-	-	-															
D1	RGB2MEL	0	<table border="1"> <thead> <tr> <th>RGB*MEL</th> <th>RGB*CNT (external pin)</th> <th>RGB* LED Lighting</th> </tr> </thead> <tbody> <tr> <td>0</td> <td>L</td> <td>ON</td> </tr> <tr> <td>0</td> <td>H</td> <td>ON</td> </tr> <tr> <td>1</td> <td>L</td> <td>OFF</td> </tr> <tr> <td>1</td> <td>H</td> <td>ON</td> </tr> </tbody> </table> <p>But, a state of lighting depends on the setup of other registers.</p>		RGB*MEL	RGB*CNT (external pin)	RGB* LED Lighting	0	L	ON	0	H	ON	1	L	OFF	1	H	ON
RGB*MEL	RGB*CNT (external pin)	RGB* LED Lighting																	
0	L	ON																	
0	H	ON																	
1	L	OFF																	
1	H	ON																	
D0	RGB1MEL	0																	



## ●RGB LED operating

### 1. Operating mode

RGB LED can set up the following operating mode by the setup of the register.

<Setup register>

$I1^{**LED}$  : (register) Initial electric current value [mA]

$IDLT^{**LED}$  : (register) The electric current  $\Delta$  value of around 1Step [mA]

$RGB^{*SLNUM}$  : (register) slope step number (1,2,4,8,16,32,64 Step)

$RGB^{*SL1STEP}$  : (register) The first half slope 1Step time [ms]

$RGB^{*SL2STEP}$  : (register) The latter half slope 1Step time [ms]

$RGB^{*WT1TM}$  : (register) The first half lighting time [ms]

$RGB^{*WT2TM}$  : (register) The latter half lighting time [ms]

As for the following setup, calculate it from the above setup.

$I2^{**LED}$  : At the time of middle lighting current value [mA] =  $I1^{**LED} + IDLT^{**LED} \times RGB^{*SLNUM}$

(In case of the value that a calculation exceeds maximum value, the current value is at the limit with maximum.)

$RGB^{*SL1TM}$  : The first half slope time [ms] =  $RGB^{*SL1STEP} \times RGB^{*SLNUM}$

$RGB^{*SL2TM}$  : The latter half slope time [ms] =  $RGB^{*SL2STEP} \times RGB^{*SLNUM}$

Each setup is necessary for DC current (at Normal mode or Blink mode).

(\* : 1/2 channels is shown. \*\* : R1/G1/B1/R2/G2/B2 is shown.)

Note) The current value in the table, it is value when 120k $\Omega$  is connected to ISET pin.

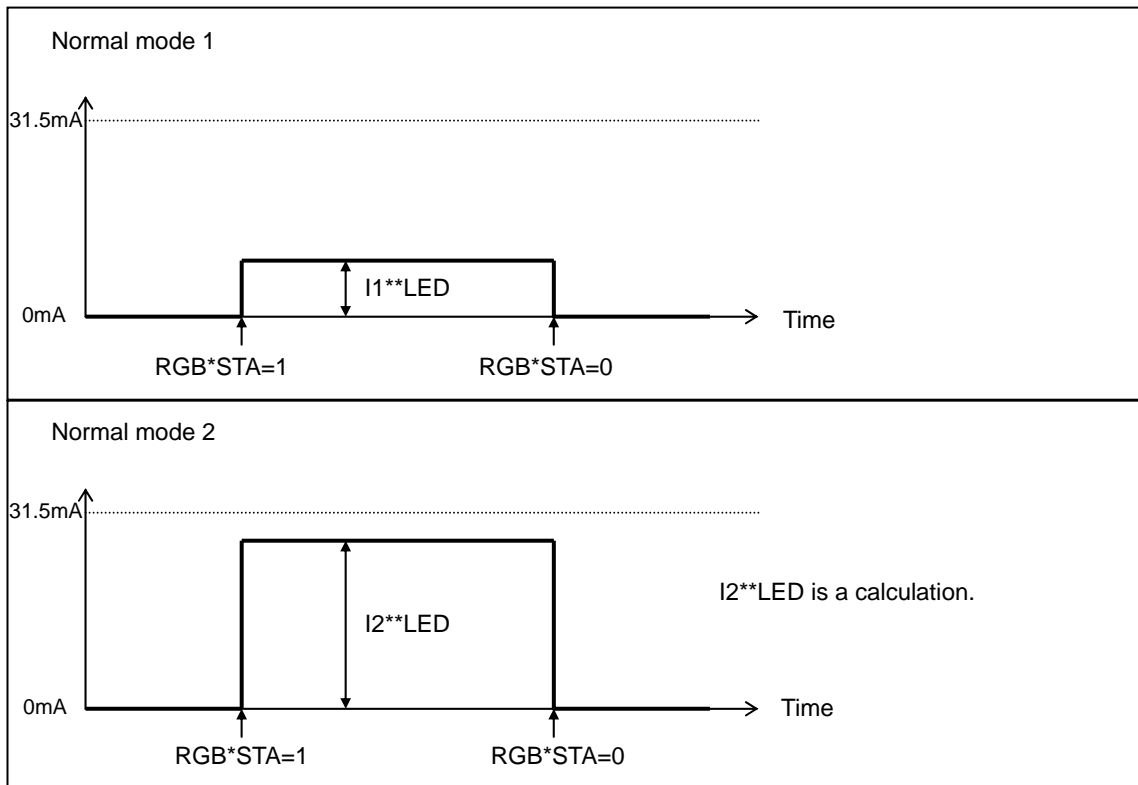

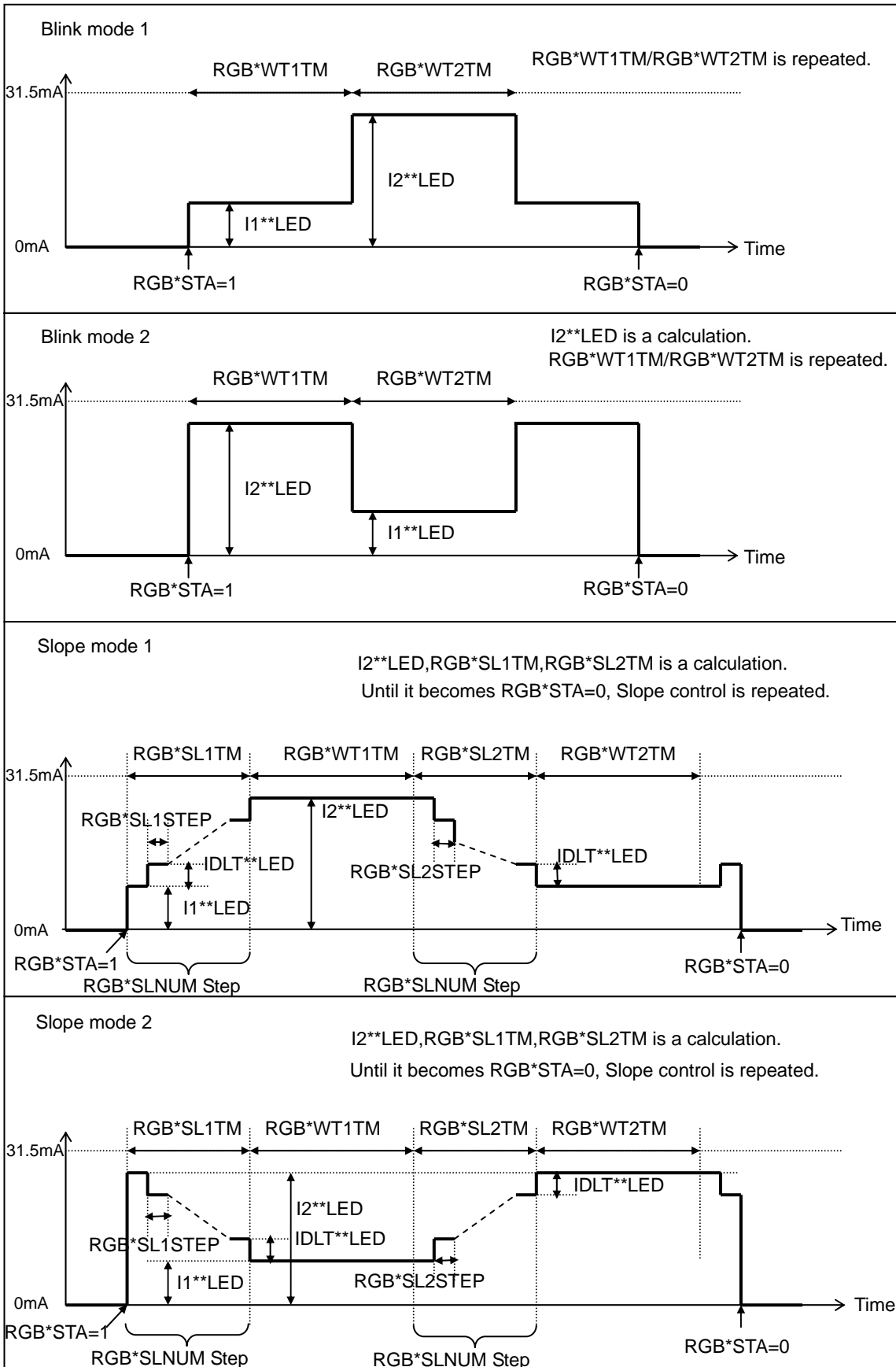

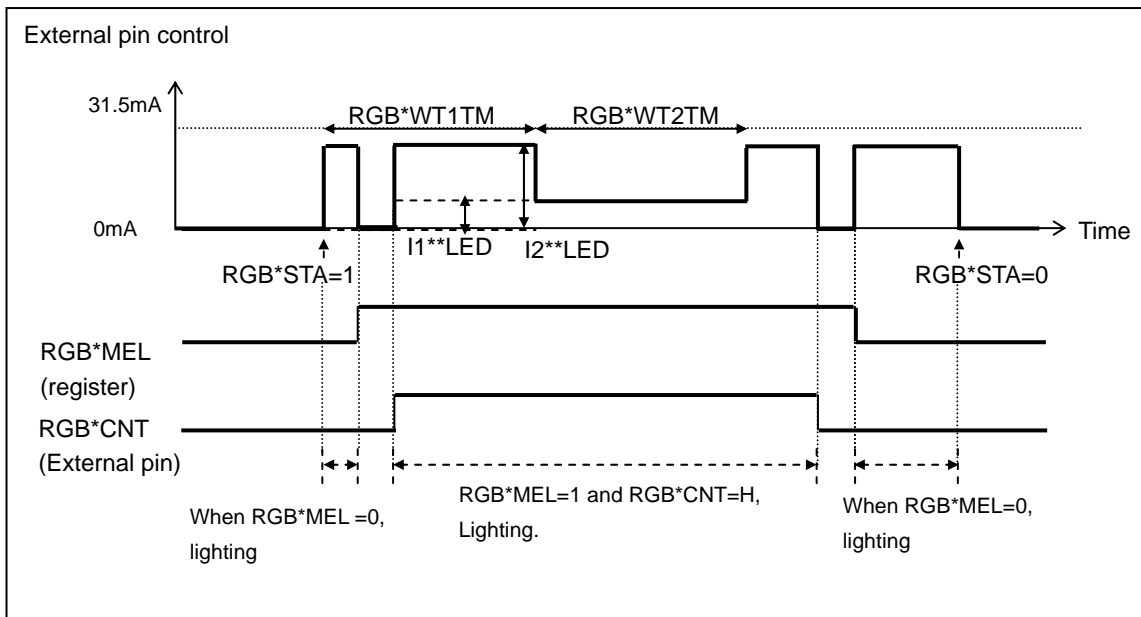

2. Slope control

The slope control that this LSI is equipped processes step time inside as follows. It is made to have electric current by the log curve that is a simple target as to the slope.

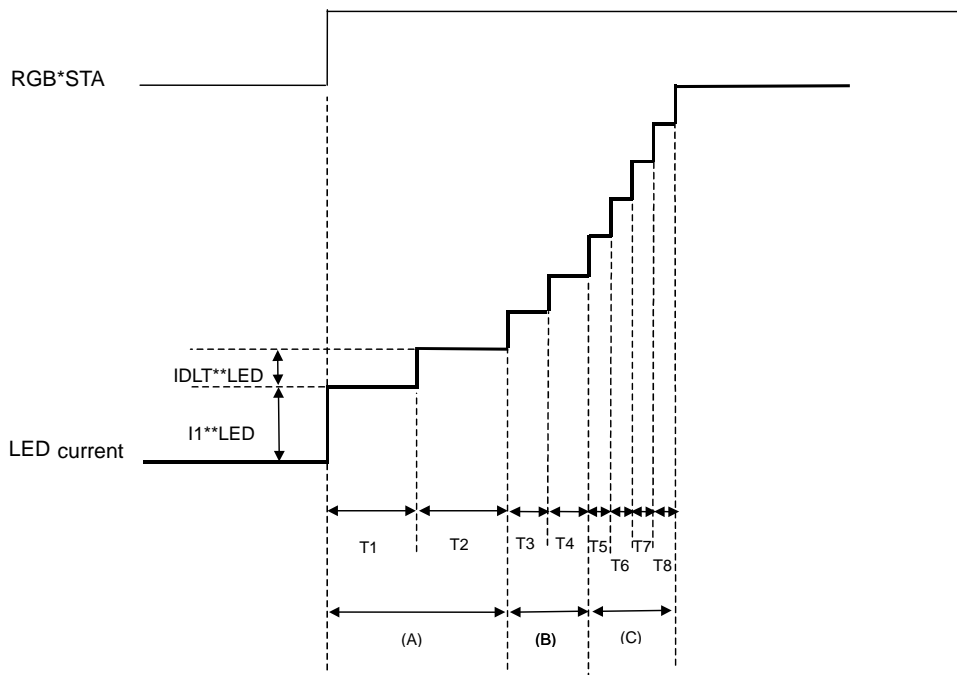

- (A)Section : It transits at the step time of two times when it was set up with  $RGB*SL1STEP$
- (B)Section : It transits at the step time when it was set up with  $RGB*SL1STEP$ .
- (C)Section : It transits at the step time of a half times when it was set up with  $RGB*SL1STEP$ .

The time of the total ( $RGB*SL1TM$ ) is calculated with  $RGB*SL1STEP \times RGB*SLNUM$ .

A similar movement is done on the descent ( $RGB*SL2TM$ ) side as well.

The acceptance of the setup of a register concerned with LED working during the slope movement stops. But, a  $RGB*STA$  signal interrupts even during the slope movement, and it is possible that LED is turned off.

**●Explanation for operate**

## 1. Reset

There are two kinds of reset, software reset and hardware reset.

## (1) Software reset

- All the registers are initialized more than making a register (SFTRST) setup "1".
- The register of software resetting is an automatic return (Auto Return 0).

## (2) Hardware reset

- It shifts to hardware reset by changing RESET pin "H" → "L".
- The condition of all the registers under hardware reset pin is returned to the initial value, and it stops accepting all address.
- It's possible to release from a state of hardware reset by setting register "L" → "H".
- RESET pin has delay circuit. It doesn't recognize as hardware reset in "L" period under 5μs.

## (3) Reset Sequence

- When hardware reset was done during software reset, software reset is canceled when hardware reset is canceled. (Because the initial value of software reset is "0")

## 2. Thermal shutdown

The blocks which thermal shutdown function is effective in the following.

Charge pump

LED Driver

REG1

REG2 is not shut down by thermal shutdown function, because REG2 can be used for I/O voltage.

A thermal shutdown function works in about 195 °C.

Detection temperature has a hysteresis, and detection release temperature is about 175 °C.

(Design reference value)

3. DC/DC

Start up

DC/DC circuit operates when either LED turns ON.  
 (But, when LED connection is set to DC/DC output (VOUT) only.)  
 DC/DC circuit has soft start function to prevent a rush current.  
 VBAT and VIO sequence is as follow.

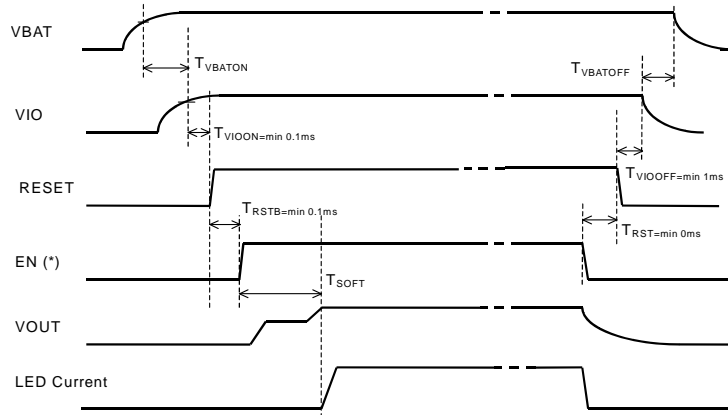

(\*) An EN signal means the following in the upper figure.

EN = "MLEDEN" or "SLEDEN" or "RGB1STA" or "RGB2STA"  
 (= LED The LED lighting control of a setup of connection VOUT)

But, as for  $V_{BAT} < 2.2V$  (typ) or  $T_a > T_{TSD}$  (typ : 195° C), a protection function functions, and an EN signal doesn't become effective.

Mode transition

The transition of boosts multiple transits automatically by the VBAT voltage and the voltage of the LED electric current inflow pin.

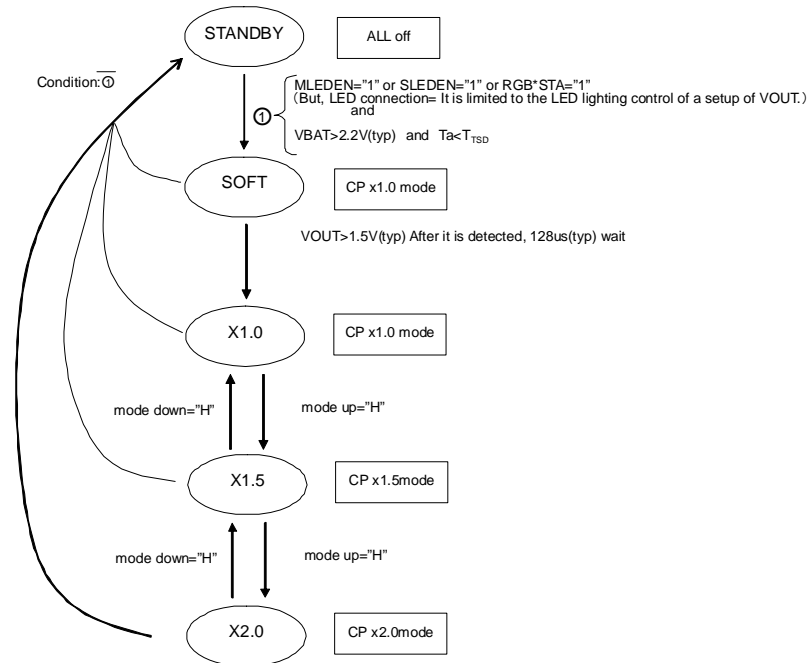

Over voltage protection / Over current protection

DC/DC circuit output (VOUT) is equipped with the over-voltage protection and the over current protection function.  
 A VOUT over-voltage detection voltage is about 6.0V. (VOUT at the time of rise in a voltage)  
 A detection voltage has a hysteresis, and a detection release voltage is about 5.75V. (Design reference value)  
 And, when VOUT output short-circuits in GND, drain electric current is controlled by an over current protection function.

4. LED Driver

LED current value setting

LED maximum current value (White LED driver and RGB LED Driver common) can be established in the resistance value R<sub>ISET</sub> that it is connected to the ISET Pin.

A setting is shown in the following.

$$I_{LEDmax} = 6.4 \times 0.6 [V] / R_{ISET} [k\Omega] [A] \text{ (Typ)} \quad \text{MLED1to4, SLED1to2}$$

$$I_{LEDmax} = 6.3 \times 0.6 [V] / R_{ISET} [k\Omega] [A] \text{ (Typ)} \quad \text{All RGB LED}$$

The maximum setting of LED current is 32mA (MLED and SLED), 31.5mA (RGB) on the D range of the internal circuit.

LED current overload protection

ISET Pin is mount with the GND short detection function. LED current value prevents excessive LED current from flowing when ISET Pin becomes low impedance because it is shown with a formula of the former extension.

White LED Driver

The number of lighting of white LED can be set up by the register MLEDSEL and SLEDSEL (address02h).

The settlement of the number of lighting can be setup with follow.

Main LCD Back light    · · · 3 Light (MLED1 ~ 3) or 4 Light (MLED1 ~ 4)

Sub LCD Back light    · · · 1 Light (SLED1) or 2 Light (SLED1 ~ 2)

Connect the LED pin that isn't used to the ground.

RGB LED Driver

By register B\*LEDMD and G\*LEDMD (address05h), a place of connection of Green LED and Blue LED It can be set up in VBAT or VOUT. When V<sub>f</sub> is low, it is connected to VBAT, and it is possible that efficiency is raised.

When a VBAT connection is chosen, a feedback route to the DC/DC circuit is interrupted, and it works as a simple constant current driver.

A write protect is given in the following address when "1" is written in the RGB\*STA register.

Register	A protected address
RGB1STA	06h ~ 0Fh
RGB2STA	10h ~ 19h

VBAT connection a start in the setup Sequence

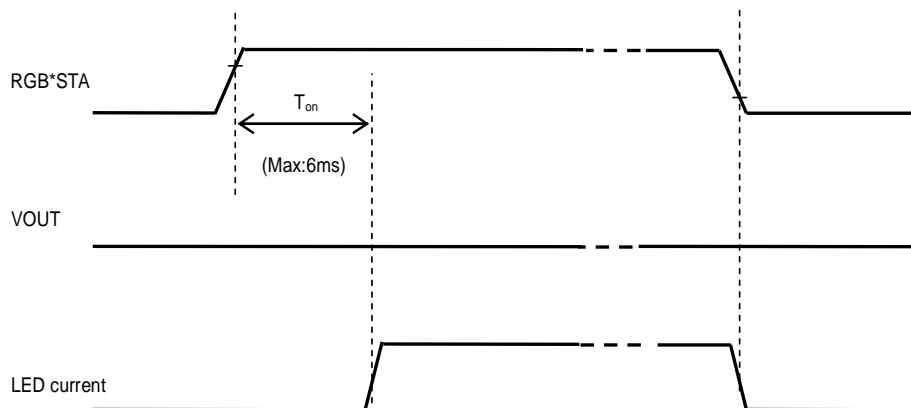

When the connection of LED is VBAT, only a LED driver turns it on, and a DC/DC circuit is turned off.

The LED pin which isn't used is to short to the ground.

But, the setup of a register concerned with LED that isn't used is prohibited.

## 5. I/O

CPU interface control input is possible low voltage interface. Interface peripheral block diagram is as follows.

VIO voltage or interface voltage is possible the setting range of 1.65~3.3V. (But, VBAT voltage  $\geq$  VIO voltage)

Also, I/O of with enable is being used for SCL, SDA input as a prevention of clock propagation to the inside when other LSI shared the SCL, SDA line.

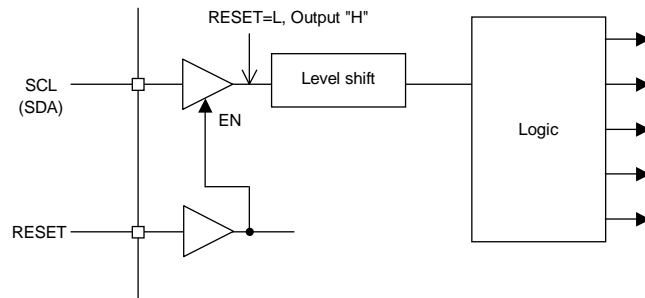

An equivalent circuit around the part I/O becomes p.8. By rising turn of the I/O power supply and the input level be careful enough because an electric current route may occur through the protection Diode of the pin.

6. About the start of REG2 (the voltage for I/O)

It must start as follows when REG2 output is used as VIO voltage.

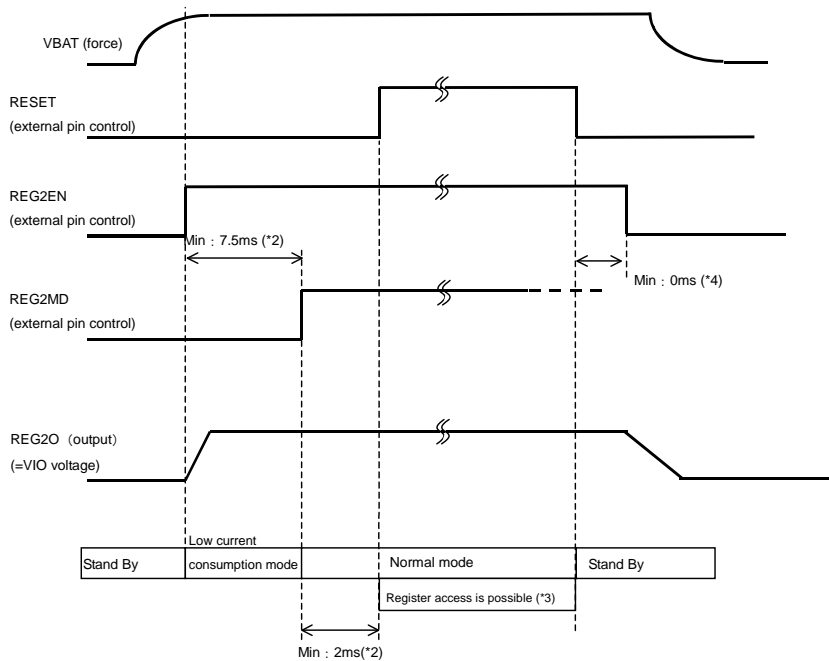

- (\*1) This sequence is when REG2O is used as an I/O voltage.  
Take the specifications of the outside power supply into consideration when the I/O voltage is applied from outside.
- (\*2) When the low consumption mode is unnecessary, REG2EN=REG2MD (simultaneous control) is possible.  
But, at that case as well, REG2 rising time in the normal mode Take a (Min : 2ms) into consideration.
- (\*3) REG2 should go for a release of RESET at the time of the normal mode.
- (\*4) REG2EN= Though "L" and RESET= "L" don't care even about the simultaneous timing,  
It is prohibition to take REG2EN= "L" in front of RESET= "L".

It must start as follows when external power supply is used as VIO voltage.

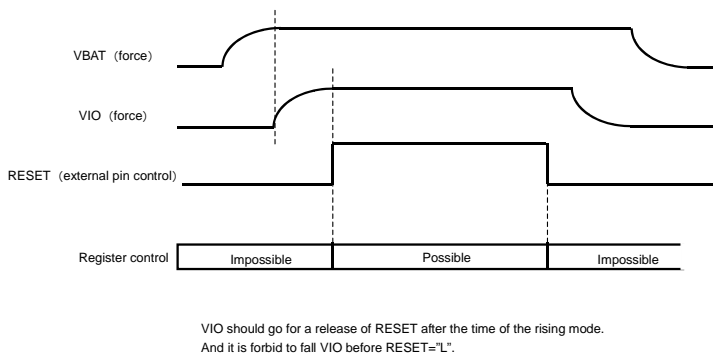

7. About the pin management of the function that isn't used and test pins

Please connect the pin that isn't used and test pin referred to equivalent circuit (P.8).

- TESTI1, TESTI2 ..... Short to GND (Must) because input pin for test
- TESTO1, TESTO2 ..... Be OPEN because output for test
- T1~T4 ..... Short to GND (Must) because input pin for test
- Non-used LED Pin ..... Short to GND

But, the setup of a register concerned with LED that isn't used is prohibited.

- REG2EN, REG2MD, RGB1CNT, RGB2CNT ..... Pull-Down resistance is built in.  
Short to GND



10. BD6081GU PCB pattern of the Power dissipation measuring board

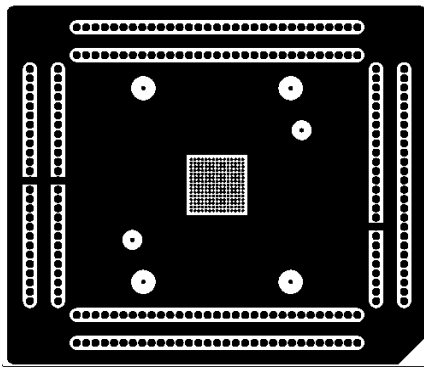

1<sup>st</sup> layer(component)

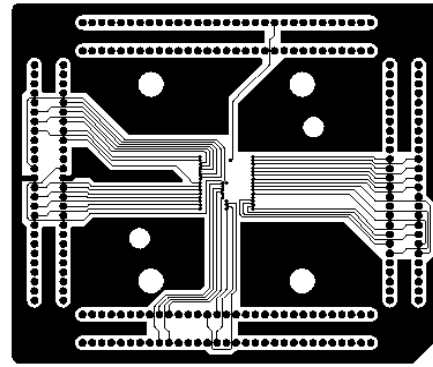

2<sup>nd</sup> layer

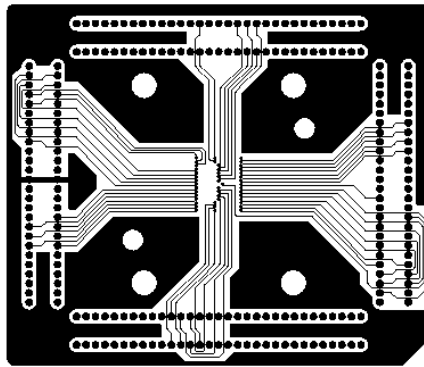

3<sup>rd</sup> layer

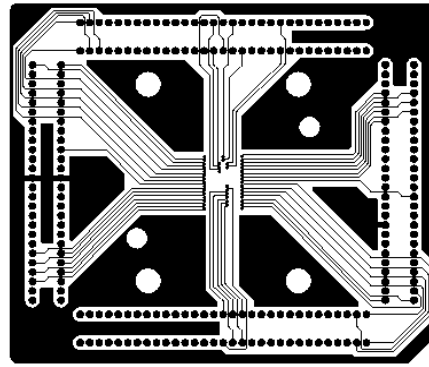

4<sup>th</sup> layer

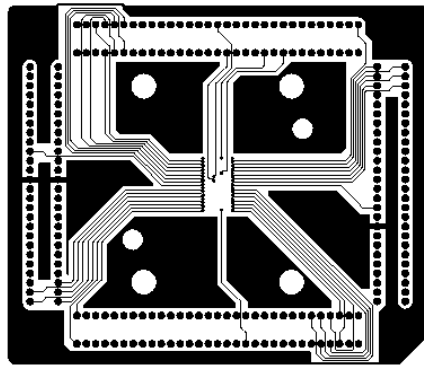

5<sup>th</sup> layer

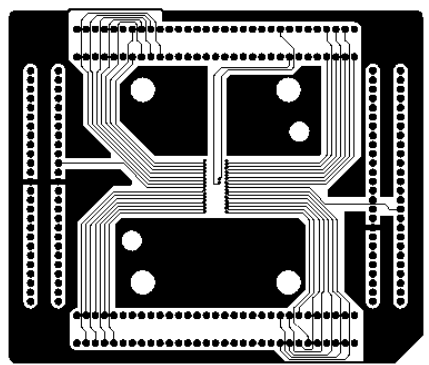

6<sup>th</sup> layer

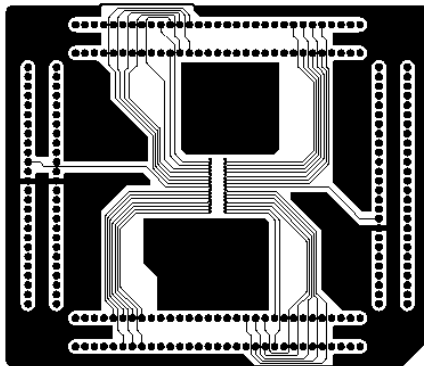

7<sup>th</sup> layer

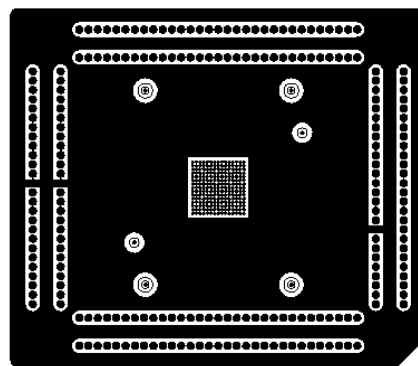

8<sup>th</sup> layer(solder)

**●Notes for use****(1) Absolute Maximum Ratings**

An excess in the absolute maximum ratings, such as supply voltage, temperature range of operating conditions, etc., can break down devices, thus making impossible to identify breaking mode such as a short circuit or an open circuit. If any special mode exceeding the absolute maximum ratings is assumed, consideration should be given to take physical safety measures including the use of fuses, etc.

**(2) Power supply and ground line**

Design PCB pattern to provide low impedance for the wiring between the power supply and the ground lines. Pay attention to the interference by common impedance of layout pattern when there are plural power supplies and ground lines. Especially, when there are ground pattern for small signal and ground pattern for large current included the external circuits, please separate each ground pattern. Furthermore, for all power supply pins to ICs, mount a capacitor between the power supply and the ground pin. At the same time, in order to use a capacitor, thoroughly check to be sure the characteristics of the capacitor to be used present no problem including the occurrence of capacity dropout at a low temperature, thus determining the constant.

**(3) Ground voltage**

Make setting of the potential of the ground pin so that it will be maintained at the minimum in any operating state. Furthermore, check to be sure no pins are at a potential lower than the ground voltage including an actual electric transient.

**(4) Short circuit between pins and erroneous mounting**

In order to mount ICs on a set PCB, pay thorough attention to the direction and offset of the ICs. Erroneous mounting can break down the ICs. Furthermore, if a short circuit occurs due to foreign matters entering between pins or between the pin and the power supply or the ground pin, the ICs can break down.

**(5) Operation in strong electromagnetic field**

Be noted that using ICs in the strong electromagnetic field can malfunction them.

**(6) Input pins**

In terms of the construction of IC, parasitic elements are inevitably formed in relation to potential. The operation of the parasitic element can cause interference with circuit operation, thus resulting in a malfunction and then breakdown of the input pin. Therefore, pay thorough attention not to handle the input pins, such as to apply to the input pins a voltage lower than the ground respectively, so that any parasitic element will operate. Furthermore, do not apply a voltage to the input pins when no power supply voltage is applied to the IC. In addition, even if the power supply voltage is applied, apply to the input pins a voltage lower than the power supply voltage or within the guaranteed value of electrical characteristics.

**(7) External capacitor**

In order to use a ceramic capacitor as the external capacitor, determine the constant with consideration given to a degradation in the nominal capacitance due to DC bias and changes in the capacitance due to temperature, etc.

**(8) Thermal shutdown circuit (TSD)**

This LSI builds in a thermal shutdown (TSD) circuit. When junction temperatures become detection temperature or higher, the thermal shutdown circuit operates and turns a switch OFF. The thermal shutdown circuit, which is aimed at isolating the LSI from thermal runaway as much as possible, is not aimed at the protection or guarantee of the LSI. Therefore, do not continuously use the LSI with this circuit operating or use the LSI assuming its operation.

**(9) Thermal design**

Perform thermal design in which there are adequate margins by taking into account the permissible dissipation (Pd) in actual states of use.

**(10) LDO**

Use each output of LDO by the independence. Don't use under the condition that each output is short-circuited because it has the possibility that an operation becomes unstable.

**(11) About the pin for the test, the un-use pin**

Prevent a problem from being in the pin for the test and the un-use pin under the state of actual use. Please refer to a function manual and an application notebook. And, as for the pin that doesn't specially have an explanation, ask our company person in charge.

**(12) About the function description or application note or more.**

The function manual and the application notebook are the design materials to design a set. So, the contents of the materials aren't always guaranteed. Please design application by having fully examination and evaluation include the external elements.

● Ordering part number

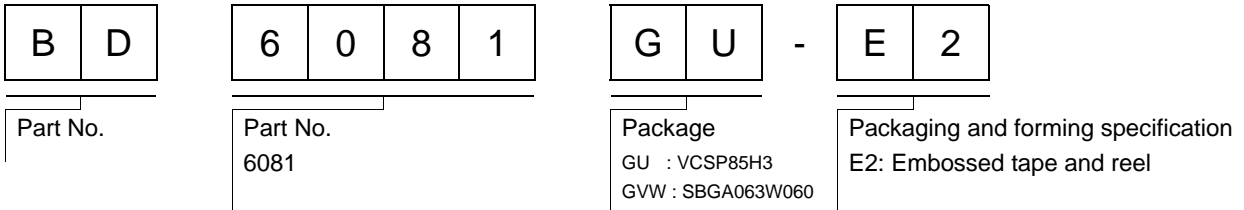

**VCSP85H3 (BD6081GU)**

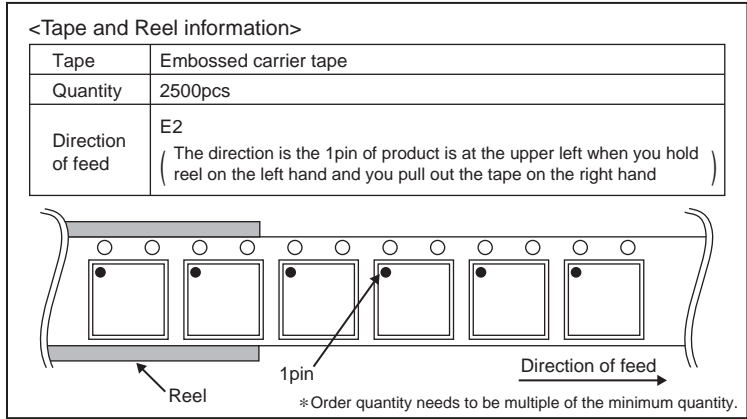
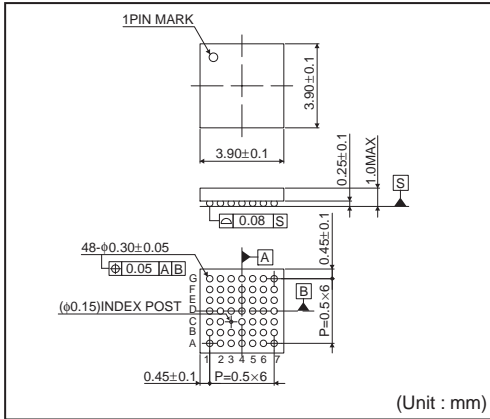

**SBGA063W060**

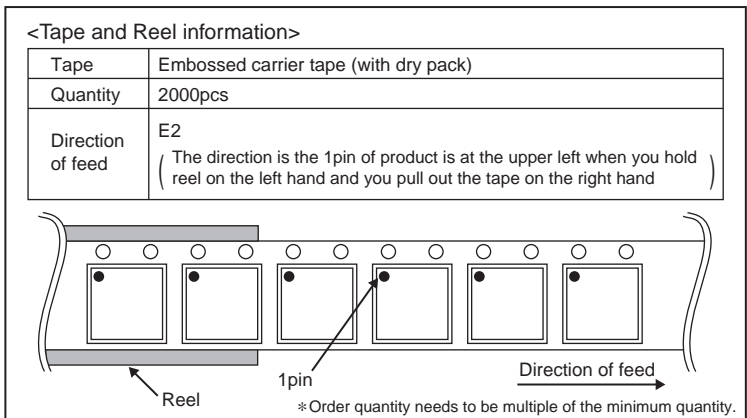
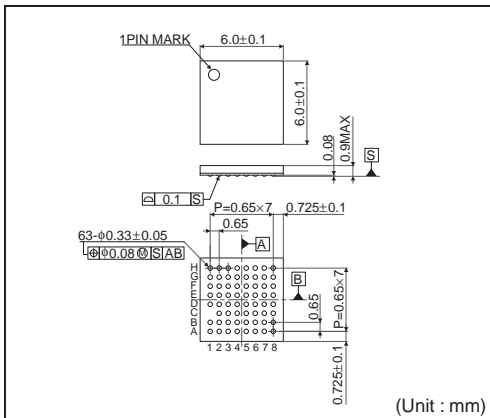

# Notice

## Precaution on using ROHM Products

- Our Products are designed and manufactured for application in ordinary electronic equipments (such as AV equipment, OA equipment, telecommunication equipment, home electronic appliances, amusement equipment, etc.). If you intend to use our Products in devices requiring extremely high reliability (such as medical equipment <sup>(Note 1)</sup>, transport equipment, traffic equipment, aircraft/spacecraft, nuclear power controllers, fuel controllers, car equipment including car accessories, safety devices, etc.) and whose malfunction or failure may cause loss of human life, bodily injury or serious damage to property ("Specific Applications"), please consult with the ROHM sales representative in advance. Unless otherwise agreed in writing by ROHM in advance, ROHM shall not be in any way responsible or liable for any damages, expenses or losses incurred by you or third parties arising from the use of any ROHM's Products for Specific Applications.

(Note1) Medical Equipment Classification of the Specific Applications

JAPAN	USA	EU	CHINA
CLASS III	CLASS III	CLASS II b	CLASS III
CLASS IV		CLASS III	

- ROHM designs and manufactures its Products subject to strict quality control system. However, semiconductor products can fail or malfunction at a certain rate. Please be sure to implement, at your own responsibilities, adequate safety measures including but not limited to fail-safe design against the physical injury, damage to any property, which a failure or malfunction of our Products may cause. The following are examples of safety measures:
  - Installation of protection circuits or other protective devices to improve system safety
  - Installation of redundant circuits to reduce the impact of single or multiple circuit failure
- Our Products are designed and manufactured for use under standard conditions and not under any special or extraordinary environments or conditions, as exemplified below. Accordingly, ROHM shall not be in any way responsible or liable for any damages, expenses or losses arising from the use of any ROHM's Products under any special or extraordinary environments or conditions. If you intend to use our Products under any special or extraordinary environments or conditions (as exemplified below), your independent verification and confirmation of product performance, reliability, etc. prior to use, must be necessary:
  - Use of our Products in any types of liquid, including water, oils, chemicals, and organic solvents
  - Use of our Products outdoors or in places where the Products are exposed to direct sunlight or dust
  - Use of our Products in places where the Products are exposed to sea wind or corrosive gases, including Cl<sub>2</sub>, H<sub>2</sub>S, NH<sub>3</sub>, SO<sub>2</sub>, and NO<sub>2</sub>
  - Use of our Products in places where the Products are exposed to static electricity or electromagnetic waves
  - Use of our Products in proximity to heat-producing components, plastic cords, or other flammable items
  - Sealing or coating our Products with resin or other coating materials
  - Use of our Products without cleaning residue of flux (even if you use no-clean type fluxes, cleaning residue of flux is recommended); or Washing our Products by using water or water-soluble cleaning agents for cleaning residue after soldering
  - Use of the Products in places subject to dew condensation
- The Products are not subject to radiation-proof design.
- Please verify and confirm characteristics of the final or mounted products in using the Products.
- In particular, if a transient load (a large amount of load applied in a short period of time, such as pulse. is applied, confirmation of performance characteristics after on-board mounting is strongly recommended. Avoid applying power exceeding normal rated power; exceeding the power rating under steady-state loading condition may negatively affect product performance and reliability.
- De-rate Power Dissipation (Pd) depending on Ambient temperature (Ta). When used in sealed area, confirm the actual ambient temperature.
- Confirm that operation temperature is within the specified range described in the product specification.
- ROHM shall not be in any way responsible or liable for failure induced under deviant condition from what is defined in this document.

## Precaution for Mounting / Circuit board design

- When a highly active halogenous (chlorine, bromine, etc.) flux is used, the residue of flux may negatively affect product performance and reliability.
- In principle, the reflow soldering method must be used; if flow soldering method is preferred, please consult with the ROHM representative in advance.

For details, please refer to ROHM Mounting specification

### Precautions Regarding Application Examples and External Circuits

1. If change is made to the constant of an external circuit, please allow a sufficient margin considering variations of the characteristics of the Products and external components, including transient characteristics, as well as static characteristics.
2. You agree that application notes, reference designs, and associated data and information contained in this document are presented only as guidance for Products use. Therefore, in case you use such information, you are solely responsible for it and you must exercise your own independent verification and judgment in the use of such information contained in this document. ROHM shall not be in any way responsible or liable for any damages, expenses or losses incurred by you or third parties arising from the use of such information.

### Precaution for Electrostatic

This Product is electrostatic sensitive product, which may be damaged due to electrostatic discharge. Please take proper caution in your manufacturing process and storage so that voltage exceeding the Products maximum rating will not be applied to Products. Please take special care under dry condition (e.g. Grounding of human body / equipment / solder iron, isolation from charged objects, setting of Ionizer, friction prevention and temperature / humidity control).

### Precaution for Storage / Transportation

1. Product performance and soldered connections may deteriorate if the Products are stored in the places where:
  - [a] the Products are exposed to sea winds or corrosive gases, including Cl<sub>2</sub>, H<sub>2</sub>S, NH<sub>3</sub>, SO<sub>2</sub>, and NO<sub>2</sub>
  - [b] the temperature or humidity exceeds those recommended by ROHM
  - [c] the Products are exposed to direct sunshine or condensation
  - [d] the Products are exposed to high Electrostatic
2. Even under ROHM recommended storage condition, solderability of products out of recommended storage time period may be degraded. It is strongly recommended to confirm solderability before using Products of which storage time is exceeding the recommended storage time period.
3. Store / transport cartons in the correct direction, which is indicated on a carton with a symbol. Otherwise bent leads may occur due to excessive stress applied when dropping of a carton.
4. Use Products within the specified time after opening a humidity barrier bag. Baking is required before using Products of which storage time is exceeding the recommended storage time period.

### Precaution for Product Label

QR code printed on ROHM Products label is for ROHM's internal use only.

### Precaution for Disposition

When disposing Products please dispose them properly using an authorized industry waste company.

### Precaution for Foreign Exchange and Foreign Trade act

Since our Products might fall under controlled goods prescribed by the applicable foreign exchange and foreign trade act, please consult with ROHM representative in case of export.

### Precaution Regarding Intellectual Property Rights

1. All information and data including but not limited to application example contained in this document is for reference only. ROHM does not warrant that foregoing information or data will not infringe any intellectual property rights or any other rights of any third party regarding such information or data. ROHM shall not be in any way responsible or liable for infringement of any intellectual property rights or other damages arising from use of such information or data.:
2. No license, expressly or implied, is granted hereby under any intellectual property rights or other rights of ROHM or any third parties with respect to the information contained in this document.

### Other Precaution

1. This document may not be reprinted or reproduced, in whole or in part, without prior written consent of ROHM.
2. The Products may not be disassembled, converted, modified, reproduced or otherwise changed without prior written consent of ROHM.
3. In no event shall you use in any way whatsoever the Products and the related technical information contained in the Products or this document for any military purposes, including but not limited to, the development of mass-destruction weapons.
4. The proper names of companies or products described in this document are trademarks or registered trademarks of ROHM, its affiliated companies or third parties.

**General Precaution**

1. Before you use our Products, you are requested to carefully read this document and fully understand its contents. ROHM shall not be in any way responsible or liable for failure, malfunction or accident arising from the use of any ROHM's Products against warning, caution or note contained in this document.
2. All information contained in this document is current as of the issuing date and subject to change without any prior notice. Before purchasing or using ROHM's Products, please confirm the latest information with a ROHM sales representative.
3. The information contained in this document is provided on an "as is" basis and ROHM does not warrant that all information contained in this document is accurate and/or error-free. ROHM shall not be in any way responsible or liable for any damages, expenses or losses incurred by you or third parties resulting from inaccuracy or errors of or concerning such information.

# Mouser Electronics

Authorized Distributor

Click to View Pricing, Inventory, Delivery & Lifecycle Information:

[ROHM Semiconductor:](#)

[BD6081GU-E2](#) [BD6081GVW-E2](#)

Компания «Океан Электроники» предлагает заключение долгосрочных отношений при поставках импортных электронных компонентов на взаимовыгодных условиях!

Наши преимущества:

- Поставка оригинальных импортных электронных компонентов напрямую с производств Америки, Европы и Азии, а так же с крупнейших складов мира;
- Широкая линейка поставок активных и пассивных импортных электронных компонентов (более 30 млн. наименований);
- Поставка сложных, дефицитных, либо снятых с производства позиций;
- Оперативные сроки поставки под заказ (от 5 рабочих дней);
- Экспресс доставка в любую точку России;
- Помощь Конструкторского Отдела и консультации квалифицированных инженеров;
- Техническая поддержка проекта, помощь в подборе аналогов, поставка прототипов;
- Поставка электронных компонентов под контролем ВП;
- Система менеджмента качества сертифицирована по Международному стандарту ISO 9001;
- При необходимости вся продукция военного и аэрокосмического назначения проходит испытания и сертификацию в лаборатории (по согласованию с заказчиком);
- Поставка специализированных компонентов военного и аэрокосмического уровня качества (Xilinx, Altera, Analog Devices, Intersil, Interpoint, Microsemi, Actel, Aeroflex, Peregrine, VPT, Syfer, Eurofarad, Texas Instruments, MS Kennedy, Miteq, Cobham, E2V, MA-COM, Hittite, Mini-Circuits, General Dynamics и др.);

Компания «Океан Электроники» является официальным дистрибьютором и эксклюзивным представителем в России одного из крупнейших производителей разъемов военного и аэрокосмического назначения «JONHON», а так же официальным дистрибьютором и эксклюзивным представителем в России производителя высокотехнологичных и надежных решений для передачи СВЧ сигналов «FORSTAR».



## JONHON

«JONHON» (основан в 1970 г.)

Разъемы специального, военного и аэрокосмического назначения:

(Применяются в военной, авиационной, аэрокосмической, морской, железнодорожной, горно- и нефтедобывающей отраслях промышленности)

«FORSTAR» (основан в 1998 г.)

ВЧ соединители, коаксиальные кабели, кабельные сборки и микроволновые компоненты:

(Применяются в телекоммуникациях гражданского и специального назначения, в средствах связи, РЛС, а так же военной, авиационной и аэрокосмической отраслях промышленности).



Телефон: 8 (812) 309-75-97 (многоканальный)

Факс: 8 (812) 320-03-32

Электронная почта: [ocean@oceanchips.ru](mailto:ocean@oceanchips.ru)

Web: <http://oceanchips.ru/>

Адрес: 198099, г. Санкт-Петербург, ул. Калинина, д. 2, корп. 4, лит. А