



Tyco Electronics - Schrack has a reputation for sound technical experience and provides engineering and sales support in local markets which in turn leads to total customer satisfaction.

World-wide we build lasting relationships with our customers through the innovative combination of:

- high quality products
- individual application support and
- complete service.

As a specialist and innovator for relays we offer technically superior and environmentally friendly solutions for reliable electrical switching.

Our extensive knowledge of markets and technology ensure that our products and systems provide optimal solutions for our customers and their applications.

Contents

| | | |
|-------------|------|---|
| Relay Range | page | 4 |
|-------------|------|---|

PCB & Power Relays

| | | | |
|----------------|--|------|-----|
| PE | Miniature PCB Relay PE | page | 22 |
| PE | Miniature PCB Relay PE bistable | page | 24 |
| RE | Miniature PCB Relay RE | page | 26 |
| PCN | Slim PCB Relay PCN | page | 28 |
| V23092 | Slim PCB Relay SNR | page | 30 |
| RYII | Miniature Power PCB Relay RY II | page | 33 |
| V23061 | Miniature Power PCB Relay MSR | page | 36 |
| RT1 | Power PCB Relay RT1 DC and AC | page | 39 |
| RT1 | Power PCB Relay RT1 bistable | page | 42 |
| RT1 | Power PCB Relay RT1 sensitive | page | 44 |
| RT1 | Power PCB Relay RT1 Inrush | page | 46 |
| 429 03 | Power PCB Relay 429 03 Inrush | page | 48 |
| RTH | Power PCB Relay RTH 105°C sensitive | page | 50 |
| RTH | Power PCB Relay RTH 105°C 16 A | page | 52 |
| RP11/1 | Power PCB Relay RP II/1 | page | 54 |
| RP3SL | Special Load PCB Relay RP 3 SL | page | 57 |
| 409 47, 409 67 | Special Load PCB Relay 409 47, 409 67 | page | 60 |
| V23077 | Faston Power Relay IF 125°C | page | 63 |
| 410 63 | Faston Power Relay 410 63, 125°C | page | 65 |
| 410 83 | Faston Power Relay 410 83, 3 mm | page | 67 |
| RT2 | Power PCB Relay RT2 DC and AC | page | 69 |
| RT2 | Power PCB Relay RT2 bistable | page | 72 |
| RP11/2 | Power PCB Relay RP II/2 | page | 74 |
| V23057 | Power PCB Relay Card E | page | 76 |
| V23148 | Power PCB Relay U/UB | page | 79 |
| PCD | Low Profile PCB Relay PCD | page | 82 |
| PB | Miniature Power PCB Relay PB | page | 84 |
| PBH | Miniature Power PCB Relay PBH 105°C | page | 86 |
| T7N/T7N-WG | Miniature Power PCB Relay T7N / T7N-WG | page | 88 |
| T9A | Power Relay T9A | page | 91 |
| T92 | Power Relay T92 | page | 94 |
| 430 | Power Relay 430 3 mm | page | 97 |
| 430 | Power Relay 430 1- and 2-pole | page | 100 |
| 419 01 | Rast 5 Power Relay 419 01 | page | 103 |

Safety Relays

| | | | |
|---------|----------------------------|------|-----|
| V23047 | Safety Relay SR2M | page | 106 |
| SR4 D/M | Safety Relay SR4 D/M | page | 109 |
| SR6 D/M | Safety Relay SR6 D/M | page | 112 |
| V23050 | Safety Relay SR6 | page | 114 |
| SR6 | Safety Relay SR6 sensitive | page | 117 |
| SR6Z | Safety Relay Module SR6 | page | 120 |

Contents

Industrial Relays

| | | |
|---------|------------------------------|----------|
| ST | ..Slim Interface Relay SNR | page 122 |
| RT | ..Interface Power Relay RT | page 124 |
| PT | ..Miniature Relay PT | page 127 |
| TM | ..Miniature Power Relay PCLH | page 131 |
| MT | ..Multimode Relay MT | page 133 |
| RM2/3/7 | ..Power Relay RM2/3/7 | page 136 |
| RM5/6 | ..Power Relay RM5/6 | page 140 |
| RM8 | ..Power Relay RM8 | page 144 |
| RMC/RMD | ..Power Relay RMC/RMD | page 147 |

Accessories

| | | |
|---------|--|----------|
| V23092 | ..Accessories - Slim Interface Relay SNR | page 151 |
| RYII | ..Accessories - Miniature PCB Relay RY II | page 152 |
| V23057 | ..Accessories - Card Relay E | page 153 |
| RT1 | ..Accessories - Power PCB Relay RT1 | page 154 |
| RP1I/1 | ..Accessories - PCB Relay RP II/1 | page 154 |
| RT2 | ..Accessories - Power PCB Relay RT2 | page 154 |
| RP1I/2 | ..Accessories - PCB Relay RP II/2 | page 154 |
| V23047 | ..Accessories - Safety Relay SR2M | page 154 |
| PT | ..Accessories - Miniature Relay PT | page 158 |
| MT | ..Accessories - Multimode Relay MT | page 162 |
| PCLH | ..Accessories - Miniature Power Relay PCLH | page 165 |
| RM2/3/7 | ..Accessories - Power Relay RM2/3/7 | page 166 |
| RM5/6 | ..Accessories - Power Relay RM5/6 | page 166 |

Packages

| | | |
|----|---------------------|----------|
| ST | ..Relay Package SNR | page 168 |
| RT | ..Relay Package RT | page 169 |
| PT | ..Relay Package PT | page 170 |

Circuit Breakers

| | | |
|-------|-------------------------|----------|
| W28 | ..Circuit Breaker W28 | page 171 |
| W58 | ..Circuit Breaker W58 | page 173 |
| W6/W9 | ..Circuit Breaker W6/W9 | page 175 |

| | |
|-----------------------------|----------|
| Safety Relays / Definitions | page 180 |
| Relay Definitions | page 182 |

| | |
|---|----------|
| Conversion table Part Numbers - Product Key | page 190 |
|---|----------|

PCB Power Relays

Miniature PCB Relay PE

1 pole 5 A

- 1 C/O
- Cadmium-free contacts
- Sensitive coil 200 mW
- 4 kV coil-contact
- Low height 10.0 mm

Miniature PCB Relay PE bistable

1 pole 5 A
polarized bistable version

- 1 C/O
- Bistable with 1 coil
- 4 kV coil-contact
- Low height 10.0 mm



Contacts

| | |
|-------------------|---------|
| Configuration | 1 C/O |
| Rated current | 5 A |
| Rated voltage | 250 Vac |
| Breaking capacity | 1250 VA |

| | |
|-------------------|---------|
| Configuration | 1 C/O |
| Rated current | 5 A |
| Rated voltage | 250 Vac |
| Breaking capacity | 1250 VA |

| | |
|-------------------|---------|
| Configuration | 1 C/O |
| Rated current | 5 A |
| Rated voltage | 250 Vac |
| Breaking capacity | 1250 VA |

Coil

| | |
|---------------------|------------|
| Nominal voltage | 5...48 Vdc |
| Nominal coil power | 200 mW |
| Other coil versions | - |

| | |
|---------------------|------------|
| Nominal voltage | 5...48 Vdc |
| Nominal coil power | 200 mW |
| Other coil versions | - |

| | |
|---------------------|------------|
| Nominal voltage | 3...24 Vdc |
| Nominal coil power | 360 mW |
| Other coil versions | - |

Insulation

| | |
|----------------------|-----------------------|
| Dielectric strength | 4000 V _{rms} |
| Clearance / creepage | 3.2 / 4 mm |

| | |
|----------------------|-----------------------|
| Dielectric strength | 4000 V _{rms} |
| Clearance / creepage | 3.2 / 4 mm |

| | |
|----------------------|-----------------------|
| Dielectric strength | 4000 V _{rms} |
| Clearance / creepage | 3.2 / 4 mm |

General data

| | |
|--------------------------|------------------------|
| Ambient temperature max. | +85 °C |
| Standard versions | flux proof, wash tight |
| Terminals | PCB |
| Dimensions l x w x h | 20 x 10 x 10 mm |

| | |
|--------------------------|------------------------|
| Ambient temperature max. | +85 °C |
| Standard versions | flux proof, wash tight |
| Terminals | PCB |
| Dimensions l x w x h | 20 x 10 x 10 mm |

| | |
|--------------------------|------------------------|
| Ambient temperature max. | +70 °C |
| Standard versions | flux proof, wash tight |
| Terminals | PCB |
| Dimensions l x w x h | 20 x 10 x 10 mm |

Databook

page 22

page 24

Accessories

-

-

Miniature PCB Relay RE

1 pole 6 A

- 1 N/O
- Sensitive coil 200 mW
- 4 kV coil-contact
- Optimized height 10.6 mm
- PCB area 200 mm²
- Wash tight



| |
|-----------------------|
| 1 N/O |
| 6 A |
| 250 Vac |
| 1500 VA |
| 5...48 Vdc |
| 200 mW |
| - |
| 4000 V _{rms} |
| 4 / 4 mm |
| +70 °C |
| wash tight |
| PCB |
| 20 x 10 x 10.6 mm |
| page 26 |
| - |

Slim PCB Relay SNR

1 pole 6 A

- 1 C/O or 1 N/O
- Only 5 mm wide
- Cadmium-free contacts
- Sensitive coil 170 mW
- 4 kV coil-contact
- 6/8 mm creepage/clearance
- Protection class II



| |
|-----------------------|
| 1 C/O or 1 N/O |
| 6 A |
| 250 Vac |
| 1500 VA |
| 5...48 Vdc |
| 170 mW |
| - |
| 4000 V _{rms} |
| 6 / 8 mm |
| +85 °C |
| wash tight |
| PCB |
| 28 x 5 x 15 mm |
| page 28 |
| page 146 |

Miniature Power PCB Relay RY II

1 pole 8 A

- 1 C/O or 1 N/O or 1 N/C
- 5 kV / 8 mm coil-contact
- Protection class II (VDE 0700)
- Low height 12.3 mm
- Pinnings: 3.2 and 5 mm
- Sockets with PCB-type or screw-type terminals



| |
|-------------------------|
| 1 C/O or 1 N/O or 1 N/C |
| 8 A |
| 250 Vac |
| 2000 VA |
| 5...48 Vdc |
| 220 mW |
| - |
| 5000 V _{rms} |
| 8 / 8 mm |
| +85 °C |
| flux proof, wash tight |
| PCB |
| 28.5 x 10.1 x 12.3 mm |
| page 31 |
| page 147 |

Miniature Power PCB Relay MSR

1 pole 8 A

- 1 C/O or 1 N/O
- High inrush currents (TV4 = 65 A) with AgSnO contacts
- 4 kV / 8 mm coil-contact
- Protection class II
- Ambient temperature up to 85°C at 8 A



| |
|-----------------------|
| 1 C/O or 1 N/O |
| 8 A |
| 250 Vac |
| 2000 VA |
| 3...60 Vdc |
| 220 mW |
| - |
| 4000 V _{rms} |
| 8 / 8 mm |
| +85 °C |
| wash tight |
| PCB |
| 28.6 x 10 x 15 mm |
| page 34 |
| - |

PCB Power Relays

Power PCB Relay RT1

1 pole 12 / 16 A,
DC- or AC-coil

- 1 C/O or 1 N/O
- Sensitive coil 400 mW, 0.75 VA
- 5 kV / 10 mm coil-contact
- Protection class II
- Ambient temperature 85°C (DC-coil)
- Height 15.7 mm



Power PCB Relay RT1 bistable

1 pole 16A,
polarized bistable version

- 1 C/O
- Bistable with 1 or 2 coils
- 5 kV/10 mm coil-contact
- Height 15.7 mm
- Cadmium-free contacts
- Protection class II (VDE 0700)



Power PCB Relay RT1 sensitive

1 pole 10 A,
highly sensitive version

- 1 C/O or 1 N/O
- Sensitive coil 250 mW
- 5 kV/10 mm coil-contact
- Protection class II (VDE 0700)
- Ambient temperature 85°C at rated load
- Height 15.7 mm



Contacts

| | | | | |
|-------------------|----------------|---------|---------|----------------|
| Configuration | 1 C/O or 1 N/O | | 1 C/O | 1 C/O or 1 N/O |
| Rated current | 12 A | 16 A | 16 A | 10 A |
| Rated voltage | 250 Vac | | 250 Vac | 250 Vac |
| Breaking capacity | 3000 VA | 4000 VA | 4000 VA | 2500 VA |

Coil

| | | | | |
|---------------------|-------------|--------------|--------------|------------|
| Nominal voltage | 5...110 Vdc | 24...230 Vac | 5...24 Vdc | 5...60 Vdc |
| Nominal coil power | 400 mW | 0.75 VA | 400 / 600 mW | 250 mW |
| Other coil versions | - | | - | - |

Insulation

| | | | | |
|----------------------|-----------------------|--|-----------------------|-----------------------|
| Dielectric strength | 5000 V _{rms} | | 5000 V _{rms} | 5000 V _{rms} |
| Clearance / creepage | 10 / 10 mm | | 10 / 10 mm | 10 / 10 mm |

General data

| | | | | |
|--------------------------|------------------------|------------|---------------------|------------------------|
| Ambient temperature max. | DC: +85 °C | AC: +70 °C | +85 °C | +85 °C |
| Standard versions | flux proof, wash tight | | flux proof | flux proof, wash tight |
| Terminals | PCB | | PCB | PCB |
| Dimensions l x w x h | 29 x 12.7 x 15.7 mm | | 29 x 12.7 x 15.7 mm | 29 x 12.7 x 15.7 mm |

Databook

page 37

page 40

page 42

Accessories

page 149

page 149

page 149

Power PCB Relay RT1 Inrush

1 pole 16 A, for inrush peak currents up to 80 A

- 1 N/O
- Sensitive coil 400 mW
- 5 kV / 10 mm coil-contact
- Protection class II (VDE 0700)
- Ambient temperature 85°C
- Height 15.7 mm



| |
|-----------------------|
| 1 N/O |
| 16 A |
| 250 Vac |
| 4000 VA |
| 5...110 Vdc |
| 400 mW |
| - |
| 5000 V _{rms} |
| 10 / 10 mm |
| +85 °C |
| flux proof |
| PCB |
| 29 x 12.7 x 15.7 mm |
| page 44 |
| page 149 |

Power PCB Relay 429 03 Inrush

1 pole 10 A, for inrush peak currents up to 80 A

- 1 N/O
- Tungsten prerun contact
- Sensitive coil 480 mW
- 4 kV / 8 mm coil-contact
- Height 15.0 mm



| |
|-----------------------|
| 1 N/O |
| 10 A |
| 250 Vac |
| 2500 VA |
| 6...60 Vdc |
| 480 mW |
| - |
| 4000 V _{rms} |
| 8 / 8 mm |
| +70 °C |
| flux proof |
| PCB |
| 28.5 x 12.5 x 15.0 mm |
| page 46 |
| - |

Power PCB Relay RTH 105°C sensitive

1 pole 10 A, high-temperature version

- 1 N/O
- Sensitive coil 250 mW
- 5 kV / 10 mm coil-contact
- Protection class II (VDE 0700)
- Ambient temperature 105°C at rated load
- Height 15.7 mm



| |
|-----------------------|
| 1 N/O |
| 10 A |
| 250 Vac |
| 2500 VA |
| 5...60 Vdc |
| 250 mW |
| - |
| 5000 V _{rms} |
| 10 / 10 mm |
| +105 °C |
| flux proof |
| PCB |
| 29 x 12.7 x 15.7 mm |
| page 48 |
| - |

Power PCB Relay RTH 105°C 16 A

1 pole 16 A, high-temperature version

- 1 C/O or 1 N/O
- 16 A rated current
- 5 kV / 10 mm coil-contact
- Protection class II (VDE 0700)
- Ambient temperature 105°C at rated load
- Height 15.7 mm



| |
|-----------------------|
| 1 C/O or 1 N/O |
| 16 A |
| 250 Vac |
| 4000 VA |
| 5...60 Vdc |
| 400 mW |
| - |
| 5000 V _{rms} |
| 10 / 10 mm |
| +105 °C |
| flux proof |
| PCB |
| 29 x 12.7 x 15.7 mm |
| page 50 |
| - |

PCB Power Relays

Power PCB Relay RP II/1

1 pole 8 / 12 / 16 A

- 1 C/O or 1 N/O
- 4 kV / 8 mm coil-contact
- Pinning 3.5 or 5 mm (8 / 12 A) and 5 mm (16 A)
- PCB-sockets



Special Load PCB Relay RP 3 SL

1 pole 16 A, for high inrush currents, mono- or bistable

- 1 N/O
- 120 A / 20 ms inrush peak current
- 4 kV / 8 mm coil-contact



Special Load PCB Relay 409

1 pole 10 A, for high inrush currents, mono- or bistable

- 1 N/O
- 500 A / 10 μ s inrush peak current
- Tungsten prerun contact
- 4 kV / 8 mm coil-contact



Contacts

| | | | |
|-------------------|-------------------------------|---------|---------|
| Configuration | 1 C/O or 1 N/O | 1 N/O | 1 N/O |
| Rated current | 8 A 12 A 16 A | 16 A | 10 A |
| Rated voltage | 250 Vac | 250 Vac | 250 Vac |
| Breaking capacity | 2000 VA 3000 VA 4000 VA | 4000 VA | 2500 VA |

Coil

| | | | |
|---------------------|-------------|-------------|-------------|
| Nominal voltage | 6...110 Vdc | 5...110 Vdc | 5...110 Vdc |
| Nominal coil power | 500 mW | 500 mW | 820 mW |
| Other coil versions | - | bistable | bistable |

Insulation

| | | | |
|----------------------|-----------------------|-----------------------|-----------------------|
| Dielectric strength | 4000 V _{rms} | 4000 V _{rms} | 4000 V _{rms} |
| Clearance / creepage | 8 / 8 mm | 8 / 8 mm | 8 / 8 mm |

General data

| | | | |
|--------------------------|------------------------|------------------------|-----------------------|
| Ambient temperature max. | +70 °C | +70 °C | +70 °C |
| Standard versions | flux proof, wash tight | flux proof, wash tight | flux proof |
| Terminals | PCB | PCB | PCB |
| Dimensions l x w x h | 29 x 12.6 x 25.5 mm | 29 x 12.6 x 25.5 mm | 28.5 x 12.2 x 25.3 mm |

Databook

page 52

page 55

page 58

Accessories

page 149

page 149

-

Faston Power Relay IF 125°C

1 pole 16 A

- 1 N/O or 1 N/C
- Insulation to VDE 0631 and VDE 0700
- Ambient temperature up to 125°C
- Faston-terminals



| |
|-----------------------|
| 1 N/O or 1 N/C |
| 16 A |
| 250 Vac |
| 4000 VA |
| 6...48 Vdc |
| 360 mW |
| - |
| 4000 V _{rms} |
| 8 / 8 mm |
| +125 °C |
| flux proof |
| PCB |
| 29 x 13.2 x 29 mm |
| page 61 |
| - |

Faston Power Relay 410 63 125°C

1 pole 16 A

- 1 N/O or 1 N/C
- Insulation to VDE 0631 and VDE 0700
- Ambient temperature up to 125°C
- Faston-terminals



| |
|-----------------------|
| 1 N/O or 1 N/C |
| 16 A |
| 250 Vac |
| 4000 VA |
| 6...60 Vdc |
| 360 mW |
| - |
| 4000 V _{rms} |
| 8 / 8 mm |
| +125 °C |
| flux proof |
| PCB |
| 29 x 12.5 x 28.5 mm |
| page 63 |
| - |

Faston Power Relay 410 83 3 mm

1 pole 16 A

- 1 N/O
- Insulation to VDE 0631 and VDE 0700
- Faston-terminals
- Contact gap > 3 mm



| |
|-----------------------|
| 1 N/O |
| 16 A |
| 250 Vac |
| 4000 VA |
| 6...60 Vdc |
| 360 mW |
| - |
| 4000 V _{rms} |
| 8 / 8 mm |
| +85°C |
| flux proof |
| PCB |
| 29 x 12,5 x 28,5 mm |
| page 65 |
| - |

Power PCB Relay Card E

1 pole 8 A

- 1 C/O or 1 N/O
- 4 kV coil-contact
- Vertical and horizontal version
- Version with twin contacts
- Wash tight



| |
|-----------------------|
| 1 C/O or 1 N/O |
| 8 A |
| 250 Vac |
| 2000 VA |
| 6...60 Vdc |
| 450...500 mW |
| - |
| 4000 V _{rms} |
| 4 / 4 mm |
| +70 °C |
| wash tight |
| PCB |
| 28 x 10.4 x 25.1 mm |
| page 74 |
| page 148 |

PCB Power Relays

Power PCB Relay RT2

2 pole 8 A,
DC and AC-coil

- 2 C/O or 2 N/O
- Sensitive coil 400 mW
- DC- or AC-coil
- 5 kV / 10 mm coil-contact
- Protection class II (VDE 0700)
- Height 15.7 mm



Power PCB Relay RT2 bistable

2 pole 8 A,
polarized bistable version

- 2 C/O
- Bistable with 1 or 2 coils
- 5 kV / 10 mm coil-contact
- Height 15.7 mm
- Cadmium-free contacts
- Protection class II (VDE 0700)



Power PCB Relay RP II/2

2 pole 8 A

- 2 C/O or 2 N/O
- 4 kV / 8 mm coil-contact
- Twin contacts available
- PCB-sockets



Contacts

| | | | |
|-------------------|----------------|---------|----------------|
| Configuration | 2 C/O or 2 N/O | 2 C/O | 2 C/O or 2 N/O |
| Rated current | 8 A | 8 A | 8 A |
| Rated voltage | 250 Vac | 250 Vac | 250 Vac |
| Breaking capacity | 2000 VA | 2000 VA | 2000 VA |

Coil

| | | | |
|---------------------|-----------------------------|--------------|------------|
| Nominal voltage | 5...110 Vdc 24...230 Vac | 5...24 Vdc | 5..110 Vdc |
| Nominal coil power | 400 mW 0.75 VA | 400 / 600 mW | 500 mW |
| Other coil versions | - | - | - |

Insulation

| | | | |
|----------------------|-----------------------|-----------------------|-----------------------|
| Dielectric strength | 5000 V _{rms} | 5000 V _{rms} | 4000 V _{rms} |
| Clearance / creepage | 10 / 10 mm | 10 / 10 mm | 8 / 8 mm |

General data

| | | | |
|--------------------------|------------------------|---------------------|------------------------|
| Ambient temperature max. | +70 °C | +85 °C (UL: 70 °C) | +70 °C |
| Standard versions | flux proof, wash tight | flux proof | flux proof, wash tight |
| Terminals | PCB | PCB | PCB |
| Dimensions l x w x h | 29 x 12.7 x 15.7 mm | 29 x 12.7 x 15.7 mm | 29 x 12.6 x 25.5 mm |

Databook

page 67

page 70

page 72

Accessories

page 149

page 149

page 149

Power PCB Relay U/UB

1 pole 7 A, mono or bistable

- 1 C/O or 1 N/O or 1 N/C
- Bistable and DC-version
- Versions with 230 mW or 180 mW pull-in power



| |
|-------------------------|
| 1 C/O or 1 N/O or 1 N/C |
| 7 A |
| 250 Vac |
| 1750 VA |

| |
|------------------|
| 6...48 Vdc |
| 450 mW 330 mW |
| sensitive |

| | |
|-----------------------|-----------------------|
| 2000 V _{rms} | 4000 V _{rms} |
| 2.5 mm | 3.5 mm |

| |
|-----------------------|
| +70 °C |
| wash tight |
| PCB |
| 21.2 x 16.2 x 14.9 mm |

page 77

Low Profile PCB Relay PCD

1 pole 10 A

- 1 N/O
- Low coil power 200 mW
- Height 10.2 mm
- Wash tight



| |
|---------|
| 1 N/O |
| 10 A |
| 250 Vac |
| 2500 VA |

| |
|------------|
| 6...24 Vdc |
| 200 mW |
| - |

| |
|-----------------------|
| 2500 V _{rms} |
| 4 mm |

| |
|------------------------|
| +70 °C |
| flux proof, wash tight |
| PCB |
| 23 x 15.9 x 10.2 mm |

page 80

Miniature Power PCB Relay PB

1 pole 10 A

- 1 C/O or 1 N/O contact
- Environmentally-friendly cadmium-free contacts
- Creepage/clearance to VDE 0435 and VDE 0700
- Class F coil available



| |
|----------------|
| 1 C/O or 1 N/O |
| 10 A |
| 250 Vac |
| 2500 VA |

| |
|----------------|
| 5, 6,12,24 Vdc |
| 360 mW |
| - |

| |
|-----------------------|
| 2500 V _{rms} |
| 3 / 4 mm |

| |
|-----------------|
| +85 °C |
| flux proof |
| PCB |
| 15 x 15 x 20 mm |

page 82

Miniature Power Relay T7N / T7N-WG

1 pole 10 A

- 1 C/O or 1 N/O
- Coil version 360 mW or 450 mW
- Ambient temperature up to 85°C
- Creepage- and clearance of base insulation according to VDE 0435 (T7N-WG: VDE 0700)



| |
|----------------|
| 1 C/O or 1 N/O |
| 10 A |
| 250 Vac |
| 2500 VA |

| | |
|------------|------------|
| 6...48 Vdc | 6...36 Vdc |
| 360 mW | 450 mW |
| - | - |

| |
|-----------------------|
| 2000 V _{rms} |
| 2 / 3 mm 3 / 4 mm |

| |
|-----------------------|
| +85 °C |
| wash tight |
| PCB |
| 22.5 x 16.5 x 16.9 mm |

page 84

PCB & Power Relays

Power Relay T9A

1 pole 25 A

- 1 N/O or 1 C/O
- High breaking capacity
- PCB- and Faston connections and chassis mount version
- UL-class F as standard
- Ambient temperature 85°C
- Open version available



Power Relay T92

2 pole 30 A, DC- and AC-coil

- 2 C/O or 2 N/O
- Switching capacity 7500 VA
- DC- or AC coil
- 4 kV / 8 mm coil-contact
- Insulation to VDE 0631 and VDE 0700
- PCB- or Faston connections or chassis mount



Contacts

| | | | |
|-------------------|-------------------|---------|--------------------|
| Configuration | 1 C/O | 1 N/O | 2 C/O or 2 N/O |
| Rated current | 20(N/O)/10(N/C) A | 25 A | 30(N/O) / 3(N/C) A |
| Rated voltage | 250 Vac | | 250 Vac |
| Breaking capacity | 4800 VA | 7200 VA | 7500 VA |

Coil

| | | | |
|---------------------|------------|------------|--------------|
| Nominal voltage | 6...48 Vdc | 6...48 Vdc | 24...240 Vac |
| Nominal coil power | 1 W | 1.7 W | 4.0 VA |
| Other coil versions | - | - | - |

Insulation

| | | |
|----------------------|-----------------------|-----------------------|
| Dielectric strength | 2500 V _{rms} | 4000 V _{rms} |
| Clearance / creepage | 3.1 / 6.3 mm | 8 / 9.5 mm |

General data

| | | | |
|--------------------------|-----------------------|------------------------|------------|
| Ambient temperature max. | +85 °C | DC: +85 °C | AC: +65 °C |
| Standard versions | wash tight | dust-proof, wash tight | |
| Terminals | PCB, Faston | PCB, Faston | |
| Dimensions l x w x h | 32.3 x 27.4 x 20.4 mm | 52.3 x 34.6 x 30.8 mm | |

Databook

page 87

page 90

Accessories

-

-

Power Relay 430 3 mm

1 pole 16 A, DC- and AC-coil

- 1 N/O
- Safety mains insulation
- Contact gap > 3 mm
- Switching capacity 4000 VA
- DC- or AC coil
- 4 kV / 8 mm coil-contact
- PCB mounting or Faston connectors
- Mounting brackets or snap mounting



| |
|---------|
| 1 N/O |
| 16 A |
| 250 Vac |
| 4000 VA |

| | |
|-------------|-------------|
| 6...110 Vdc | 6...240 Vac |
| 1 W | 1.8 VA |
| - | - |

| |
|-----------------------|
| 4000 V _{rms} |
| 8 / 8 mm |

| |
|-----------------------|
| +70°C |
| dust protected |
| PCB, Faston |
| 35.5 x 16.4 x 28.5 mm |

page 93

Power Relay 430

1 pole 16 A, DC- and AC-coil,
2 pole 10 A, DC- and AC-coil

- 1 or 2 pole, N/O, C/O and N/C
- 4 kV / 8 mm coil-contact
- DC- or AC coil
- PCB mounting or Faston connectors
- Mounting brackets or snap mounting



| | |
|-----------------|-----------------|
| 1 N/O, C/O, N/C | 2 N/O, C/O, N/C |
| 16 A | 10 A |
| 250 Vac | |
| 4000 VA | 2500 VA |

| | |
|-------------|-------------|
| 6...110 Vdc | 6...240 Vac |
| 1 W | 1.8 VA |
| - | - |

| |
|-----------------------|
| 4000 V _{rms} |
| 8 / 8 mm |

| |
|-----------------------|
| +70°C |
| dust protected |
| PCB, Faston |
| 35.5 x 16.4 x 30.5 mm |

page 96

Rast 5 Power Relay 419 01

2 pole 16 A, DC- and AC-coil

- 2 N/O
- Contact gap > 3 mm
- Switching capacity 4000 VA
- DC- or AC coil
- Safety mains insulation
- 4 kV / 8 mm coil-contact
- Faston connectors
- Snap or screw mount



| |
|---------|
| 2 N/O |
| 16 A |
| 250 Vac |
| 4000 VA |

| | |
|------------|---------------|
| 6...24 Vdc | 120...400 Vac |
| 1.3 W | 2.0...2.5 VA |
| - | - |

| |
|-----------------------|
| 4000 V _{rms} |
| 8 / 8 mm |

| |
|-----------------|
| +90°C |
| dust protected |
| Faston |
| 47 x 24 x 47 mm |

page 99

Safety Relays

Safety Relay SR2M

2 pole 6 A

- Relay with forcibly guided contacts according to EN 50205
- 1 N/O + 1 N/C or 2 C/O
- 6 kV surge resistance between poles



Safety Relay SR4 D/M

4 pole 8 A

- Relay with forcibly guided contacts according to EN 50205
- 2 N/O + 2 N/C or 3 N/O + 1 N/C
- Small size



Safety Relay SR6 D/M

4 pole 8 A

- Relay with forcibly guided contacts according to EN 50205
- 2 N/O + 2 N/C or 3 N/O + 1 N/C
- High insulation distances for safe separation of electrical circuits



Contacts

| | | | |
|-------------------|------------------------|------------------------|------------------------|
| Configuration | 1 N/O + 1 N/C or 2 C/O | 2N/O+2N/C or 3N/O+1N/C | 2N/O+2N/C or 3N/O+1N/C |
| Rated current | 6 A | 8 A | 8 A |
| Rated voltage | 250 Vac | 250 Vac | 250 Vac |
| Breaking capacity | 1500 VA | 2000 VA | 2000 VA |

Coil

| | | | |
|---------------------|-------------|-------------|-------------|
| Nominal voltage | 5...110 Vdc | 5...110 Vdc | 5...110 Vdc |
| Nominal coil power | 700 mW | 800 mW | 1200 mW |
| Other coil versions | - | - | - |

Insulation

| | | | |
|-----------------------------------|--------------|------------|----------------------------|
| Clearance / creepage coil-contact | 8 / 8 mm | 8 / 8 mm | 5.5 / 5.5 mm |
| Clearance / creepage cont.-cont. | 5.5 / 5.5 mm | 3 / 3.5 mm | 5.5 / 5.5 mm or 12 / 12 mm |

General data

| | | | |
|--------------------------|---------------------|-----------------|-------------------|
| Ambient temperature max. | +70 °C | +70 °C | +70 °C |
| Standard versions | wash tight | wash tight | wash tight |
| Terminals | PCB | PCB | PCB |
| Dimensions l x w x h | 29 x 12.6 x 25.5 mm | 40 x 13 x 16 mm | 55 x 16.5 x 16 mm |

Databook

page 102

page 105

page 108

Accessories

page 150

-

-

Safety Relay SR6

6 pole 8 A

- Relay with forcibly guided contacts according to EN 50205
- Small size
- 4 N/O + 2 N/C,
3 N/O + 3 N/C,
5 N/O + 1 N/C



Safety Relay SR6 sensitive

6 pole 8 A

- Relay with forcibly guided contacts according to EN 50205
- polarized with 800 mW power consumption
- 4 N/O + 2 N/C,
3 N/O + 3 N/C,
5 N/O + 1 N/C



Safety Relay SR6Z

6 pole 8 A

- SR6 on printed circuit board
- 4 N/O + 2 N/C,
3 N/O + 3 N/C,
5 N/O + 1 N/C
- AC/DC input
- Spring connectors
- Module width 46 mm

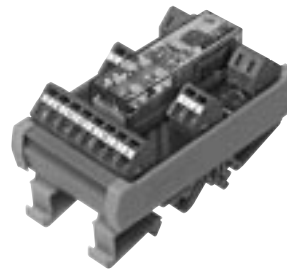

| |
|---------------------------------|
| 4N/O+2N/C, 3N/O+3N/C, 5N/O+1N/C |
| 8 A |
| 250 Vac |
| 2000 VA |

| |
|-------------|
| 5...110 Vdc |
| 1200 mW |
| - |

| |
|--------------|
| 5.5 / 5.5 mm |
| 5.5 / 5.5 mm |

| |
|-------------------|
| +70 °C |
| wash tight |
| PCB |
| 55 x 16.5 x 16 mm |

page 110

| |
|---------------------------------|
| 4N/O+2N/C, 3N/O+3N/C, 5N/O+1N/C |
| 8 A |
| 250 Vac |
| 2000 VA |

| |
|------------|
| 5...48 Vdc |
| 800 mW |
| - |

| |
|--------------|
| 5.5 / 5.5 mm |
| 5.5 / 5.5 mm |

| |
|-------------------|
| +70 °C |
| wash tight |
| PCB |
| 55 x 16.5 x 16 mm |

page 113

| |
|---------------------------------|
| 4N/O+2N/C, 3N/O+3N/C, 5N/O+1N/C |
| 8 A |
| 250 Vac |
| 2000 VA |

| |
|--------------------------|
| 12..115 Vdc/Vac, 230 Vac |
| 1200 mW |
| - |

| |
|--------------|
| 5.5 / 5.5 mm |
| 3 / 3 mm |

| |
|----------------------------|
| +50 °C |
| - |
| spring connector terminals |
| 87 x 46 mm |

page 116

Industrial Relays

Slim Interface Relais SNR

1 pole 6 A

- 1 C/O 6 A
- Module width 5,08 mm
- Cadmium-free contacts
- Sensitive coil 170 mW
- 4 kV coil-contact
- 6/8 mm clearance/creepage
- Protection class II (VDE 0700)
- Safe separation to VDE0106



Interface Power Relay RT

1 pole 12 / 16 A, 2 pole 8 A, DC- or AC coil

- 1 C/O 12 or 16 A or 2 C/O 8 A
- Sensitive coil 400 mW
- Cadmium-free contacts
- Protection class II (VDE 0700)
- Safe separation to VDE0106
- 5 kV / 10 mm coil-contact



Miniature Relay PT

2 / 3 / 4 pole 12 / 10 / 6 A, DC- or AC-coil

- 2, 3 or 4 C/O
- Sensitive coil
- Low height 29 mm
- Cadmium-free contacts
- Mechanical indicator
- Manual test tab, optionally lockable
- C250 in 3 pole version



Contacts

| | | | | | | |
|-------------------|---------|----------------|---------|---------|---------|---------|
| Configuration | 1 C/O | 1 C/O | 2 C/O | 2 C/O | 3 C/O | 4 C/O |
| Rated current | 6 A | 12 / 16 A | 8 A | 12 A | 10 A | 6 A |
| Rated voltage | 250 Vac | 250 Vac | | 250 Vac | | |
| Breaking capacity | 1500 VA | 3000 / 4000 VA | 2000 VA | 3000 VA | 2500 VA | 1500 VA |

Coil

| | | | | | | |
|---------------------|------------|-------------|-------------|-------------|-------------|--|
| Nominal voltage | 5...48 Vdc | 6...110 Vdc | 24...230Vac | 6...220 Vdc | 6...230 Vac | |
| Nominal coil power | 170 mW | 400 mW | 0.75 VA | 0.75 W | 1.0 VA | |
| Other coil versions | - | see RT | | - | | |

Insulation

| | | | | | | |
|----------------------|-----------------------|-----------------------|--|-----------------------|---------|---------|
| Dielectric strength | 4000 V _{rms} | 5000 V _{rms} | | 2500 V _{rms} | | |
| Clearance / creepage | 6 / 8 mm | 10 / 10 mm | | 3/4mm | 2.6/4mm | 1.8/3mm |

General data

| | | | | | | |
|--------------------------|----------------|---------------------|--|------------------------|--|--|
| Ambient temperature max. | +85 °C | +70°C | | +70°C | | |
| Standard versions | flux proof | flux proof | | dust-proof, flux proof | | |
| Terminals | plug-in | plug-in | | plug-in, PCB | | |
| Dimensions l x w x h | 28 x 5 x 15 mm | 29 x 12.7 x 15.7 mm | | 28 x 22.5 x 29 mm | | |

Databook

page 118

page 120

page 123

Accessories

page 147

page 150

page 154

Multimode Relay MT

2 / 3 pole 10 A,
DC- or AC-coil

- 2 C/O or 3 C/O
- Cadmium-free contacts
- Mechanical indicator as standard and electrical indicator
- New front operated test system



| |
|----------------|
| 2 C/O or 3 C/O |
| 10 A |
| 250 Vac |
| 2500 VA |

| | |
|------------|-------------|
| 6...220Vdc | 6...230 Vac |
| 1.2 W | 2.3 VA |
| - | - |

| |
|-----------------------|
| 2500 V _{rms} |
| 2.8 / 4 mm |

| | |
|---------------------|------------|
| DC: +60 °C | AC: +50 °C |
| dust-proof | |
| plug-in | |
| 35.5 x 35.5 x 57 mm | |

page 129

page 158

Power Relay RM 2/3/7

2 / 3 pole 10 / 16 A,
DC- or AC-coil

- 2 C/O or 3 C/O
- Switching capacity up to 6000VA
- Mechanical indicator
- Push-to-test-button
- Plug-in version, PCB terminals, chassis- or DIN-rail mount



| | | |
|---------|---------|---------|
| 2 C/O | 3 C/O | 3 C/O |
| 16 A | 10 A | 16 A |
| 380 Vac | | |
| 6000 VA | 3800 VA | 6000 VA |

| | |
|-------------|--------------|
| 6...220 Vdc | 6...400 Vac |
| 1.2...1.6 W | 2.3...2.8 VA |
| - | - |

| |
|-----------------------|
| 2500 V _{rms} |
| 3.5 / 6 mm |

| | |
|-----------------------|---------------|
| DC: +60/70 °C | AC: +50/55 °C |
| dust-proof | |
| plug-in, PCB | |
| 38.5 x 35.5 x 48.5 mm | |

page 132

page 162

Power Relay RM 5/6

2 / 3 pole 10 / 16 A,
DC- or AC-coil

- 2 N/O or 3 N/O
- 3 mm contact gap
- Push-to-test-button
- Plug-in version, PCB terminals, chassis- or DIN-rail mount



| | |
|---------|---------|
| 2 N/O | 3 N/O |
| 16 A | 10 A |
| 380 Vac | |
| 6000 VA | 3800 VA |

| | |
|-------------|-------------|
| 6...220 Vdc | 6...400 Vac |
| 1.6 W | 2.8 VA |
| - | - |

| |
|-----------------------|
| 2500 V _{rms} |
| 3.5 / 6 mm |

| | |
|-----------------------|------------|
| DC: +60 °C | AC: +50 °C |
| dust-proof | |
| plug-in, PCB | |
| 38.5 x 35.5 x 48.5 mm | |

page 136

page 162

Power Relay RM 8

2 pole 25 A, DC- or AC-coil

- 2 C/O
- Mechanical indicator
- Push-to-test-button
- Chassis- or DIN-rail mount



| |
|---------|
| 2 C/O |
| 25 A |
| 250 Vac |
| 6000 VA |

| | |
|-------------|-------------|
| 6...220 Vdc | 6...400 Vac |
| 1.2 W | 2.8 VA |
| - | - |

| |
|-----------------------|
| 2500 V _{rms} |
| 2.8 / 4 mm |

| | |
|-----------------------|------------|
| DC: +65 °C | AC: +40 °C |
| dust-proof | |
| Faston | |
| 38.5 x 35.5 x 48.5 mm | |

page 140

-

Industrial Relays

Power Relay RMC/RMD

1 pole 30 A, DC- or AC-coil

- 1 N/O or 1 N/O + 1 N/C
- Switching capacity up to 7200 VA
- Push-to-test-button
- Chassis mount



Miniature Power Relay PCLH

2 pole 10 A, DC- or AC-coil

- 2 C/O
- Plug-in version, PCB or chassis mount version



Contacts

| | | | |
|-------------------|---------------|-------|---------|
| Configuration | 1 N/O + 1 N/C | 1 N/O | 2 C/O |
| Rated current | 30 A | | 10 A |
| Rated voltage | 250 Vac | | 250 Vac |
| Breaking capacity | 7500 VA | | 2500 VA |

Coil

| | | | | |
|---------------------|-------------|-------------|-------------|-------------|
| Nominal voltage | 6...220 Vdc | 6...400 Vac | 12...48 Vdc | 12...230Vac |
| Nominal coil power | 1.2 W | 2.8 VA | 900 mW | 1.2 VA |
| Other coil versions | - | | - | |

Insulation

| | | | | |
|----------------------|-----------------------|--|-----------------------|--|
| Dielectric strength | 2500 V _{rms} | | 1500 V _{rms} | |
| Clearance / creepage | 2.8 / 4 mm | | 1.2 / 1.2 mm | |

General data

| | | | | |
|--------------------------|-----------------------|------------|-----------------------|--|
| Ambient temperature max. | DC: +60 °C | AC: +40 °C | +55 °C | |
| Standard versions | dust-proof | | dust-proof | |
| Terminals | Faston | | plug-in, PCB | |
| Dimensions l x w x h | 38.5 x 35.5 x 48.5 mm | | 27.5 x 21.2 x 34.5 mm | |

Databook

page 143

page 127

Accessories

-

page 161

Circuit Breakers

Circuit Breaker W28

1 pole 0.25...16 A

- Approved to international standards (push to reset type)
- Labor-saving snap-in mounting
- Button extends for visible trip indication



Circuit Breaker W58

1 pole 0.5...25 A

- 0.5...25 A ratings
- Cannot be manually tripped
- Push button to reset breaker
- Button extends for visible trip indication



Circuit Breaker W6 / W9 series

1...4 pole 0.2...50 A

- UL, CSA and VDE approved
- Ratings to 50 A
- Heavy duty stud connections
- Several delay curve options
- Trip free operation



| Series | W28 | W58 | W6 / W9 |
|--------------------------|--------------------------------|--|--|
| Type | thermal | thermal | magnetic |
| Electrical data | | | |
| Number of poles | 1 | 1 | 1...4 |
| Current rating | 0.25...16 A | 0.5...25 A | 0.2...50 A |
| Max. operating voltage | 32 Vdc, 250 Vac | 50 Vdc, 250 Vac | 65 Vdc, 415 Vac |
| Interrupt capacity | 1000 A at 32 Vdc or 250 Vac | 2000 A at 50 Vdc 1000 A at 250 Vac | 2000 A at 65 Vdc up to 5000 A at 250 Vac |
| General data | | | |
| Ambient temperature max. | +60 °C | +60 °C | +85 °C |
| Terminals | 6.35 mm Quick Connect | 6.35 mm Quick Connect screw terminals | 6.35 mm Quick Connect stud terminal |
| Dimensions l x w x h | 13.7 x 15.9 x 40 mm | 16.8 x 34.9 x 34.9 mm | W6: 19.1 x 50.8 x 41.1 mm W9: 19.1 x 63.5 x 53 mm |
| Databook | page 167 | page 169 | page 171 |

Relay Range

The ordering code structure does allow a large number of possible variations, but not all possible variations are defined as standard types (ordering codes) and thus not included in the product range.

Special versions to customer specifications can be supplied. Please contact your local sales organisation.

Technical data in this catalog are guidelines for appropriate use under standard conditions. For additional information please contact our technical support.

Data subject to change without prior notice.

Relay Range

| Terminals | | | Coil | | | Relay type | Page | Contacts | | Switching current [A] |
|-----------|---------|---------------|------|----|----------|---------------|------|--------------|--------------|-----------------------|
| PCB | Plug-in | Solder/Faston | DC | AC | Bistable | | | C/O contacts | N/O contacts | |
| | | | | | | PE | 22 | | | 5 |
| | | | | | | PE bistable | 24 | | | 5 |
| | | | | | | SNR | 28 | | | 5 |
| | | | | | | U/UB | 77 | | | 5 |
| | | | | | | RY II | 31 | | | 5 |
| | | | | | | MSR | 34 | | | 5 |
| | | | | | | Card E | 74 | | | 5 |
| | | | | | | RP II/1 | 52 | | | 5 |
| | | | | | | RT1 sensitive | 42 | | | 5 |
| | | | | | | RTH sensitive | 48 | | | 5 |
| | | | | | | PB | 82 | | | 5 |
| | | | | | | T7N / T7N-WG | 84 | | | 5 |
| | | | | | | RT1 | 37 | | | 5 |
| | | | | | | RP II/1 | 52 | | | 5 |
| | | | | | | RT1 | 37 | | | 5 |
| | | | | | | RT1 Inrush | 44 | | | 5 |
| | | | | | | RTH | 50 | | | 5 |
| | | | | | | RP II/1 | 52 | | | 5 |
| | | | | | | 430 | 96 | | | 5 |
| | | | | | | T9A | 87 | | | 5 |
| | | | | | | RE | 26 | | | 5 |
| | | | | | | PCD | 80 | | | 5 |
| | | | | | | 409 47 | 58 | | | 5 |
| | | | | | | 429 03 | 46 | | | 5 |
| | | | | | | RP 3SL | 55 | | | 5 |
| | | | | | | IF | 61 | | | 5 |
| | | | | | | 410 63 | 63 | | | 5 |
| | | | | | | 410 83 | 65 | | | 5 |
| | | | | | | 430 3mm | 93 | | | 5 |
| | | | | | | T9A | 87 | | | 5 |
| | | | | | | RMC/RMD | 143 | | | 5 |
| | | | | | | RT 2 | 67 | | | 5 |
| | | | | | | RP II/2 | 72 | | | 5 |
| | | | | | | 430 | 96 | | | 5 |
| | | | | | | MT | 129 | | | 5 |
| | | | | | | PCLH | 127 | | | 5 |
| | | | | | | PT | 123 | | | 5 |
| | | | | | | RM 2 | 132 | | | 5 |
| | | | | | | RM 8 | 140 | | | 5 |
| | | | | | | RM 5 | 136 | | | 5 |
| | | | | | | 419 01 | 99 | | | 5 |
| | | | | | | T92 | 90 | | | 5 |
| | | | | | | PT | 123 | | | 5 |
| | | | | | | MT | 129 | | | 5 |
| | | | | | | RM 3 | 132 | | | 5 |
| | | | | | | RM 7 | 132 | | | 5 |
| | | | | | | RM 6 | 136 | | | 5 |
| | | | | | | PT | 123 | | | 5 |
| | | | | | | Safety Relays | | | | 5 |
| | | | | | | SR2M | 102 | | | 5 |
| | | | | | | SR4M | 105 | | | 5 |
| | | | | | | SR6 DM | 108 | | | 5 |
| | | | | | | SR6 | 110 | | | 5 |
| | | | | | | SR6 sensitive | 113 | | | 5 |

S0345-G

Miniature PCB Relay PE

1 pole 5 A



Features

- 1 C/O contact
- Cadmium-free contacts
- Sensitive coil 200 mW
- 4 kV coil-contact
- Insulation according to IEC 255
- Ambient temperature 85°C
- Low height 10.0 mm

Applications

Industrial electronics, white goods, measurement and control

F0169-B



Technical data of approved types on request

Contact data

| | |
|---|-------------------|
| Configuration | 1 C/O contact |
| Type of contact | single contact |
| Rated current | 5 A |
| Rated voltage / max.breaking voltage AC | 250 Vac / 440 Vac |
| Maximum breaking capacity AC | 1250 VA |
| Contact material | AgNi 90/10 |

Contact ratings

| Type | Load | Operations | Standard |
|--------|---|---------------------|----------|
| PE 014 | 5A, 250 Vac, on the C/O contact | 10 ⁵ | VDE 0435 |
| PE 014 | 20/2A, 250Vac, cosφ=0.3, on the N/O contact | 1.2x10 ⁵ | AC 15 |
| PE 014 | 5 A, 250 Vac, on the C/O contact | 1.5x10 ⁵ | |

Coil data

| | |
|--------------------|-------------|
| Nominal voltage | 5...48 Vdc |
| Nominal coil power | typ. 200 mW |
| Operate category | 2 / b |

Coil versions, DC-coil

| Coil code | Nominal voltage Vdc | Pull-in voltage Vdc | Release voltage Vdc | Maximum voltage Vdc | Coil resistance Ω | Coil current mA |
|-----------|---------------------|---------------------|---------------------|---------------------|-------------------|-----------------|
| 005 | 5 | 3.8 | 0.5 | 13.2 | 125±10% | 40.0 |
| 006 | 6 | 4.5 | 0.6 | 15.9 | 172±10% | 34.9 |
| 012 | 12 | 9.0 | 1.2 | 31.8 | 685±10% | 17.5 |
| 024 | 24 | 18.0 | 2.4 | 63.6 | 2725±10% | 8.8 |
| 048 | 48 | 36.0 | 4.8 | 127.2 | 10970±10% | 4.4 |

All figures are given for coil without preenergization, at ambient temperature +20°C

Other coil voltages on request

Max. DC load breaking capacity

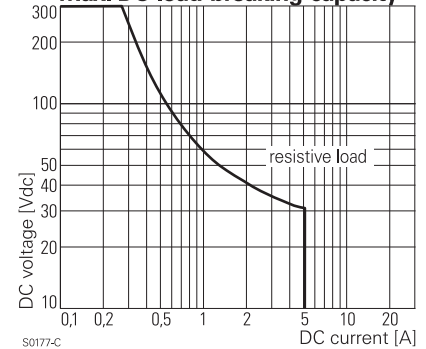

Electrical endurance

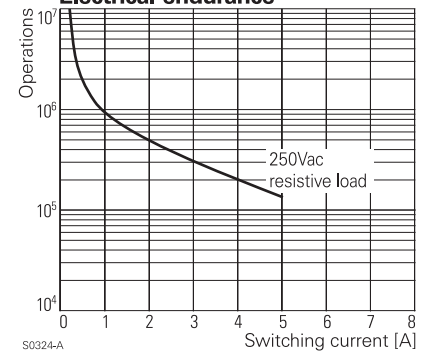

Coil operating range DC

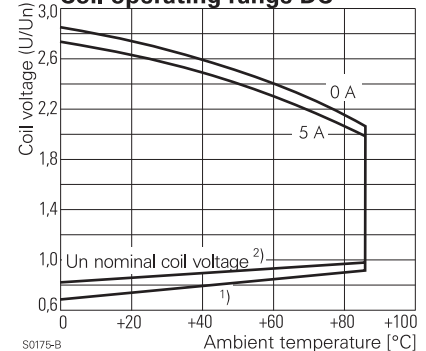

Miniature PCB Relay PE

1 pole 5 A

Insulation

| | | |
|-----------------------------------|----------------------|-----------------------|
| Dielectric strength | coil-contacts | 4000 V _{rms} |
| | open contact circuit | 1000 V _{rms} |
| Clearance / creepage | | ≥3.2 / 4 mm |
| Insulation to IEC 60664 | | |
| Voltage rating | | 250 V |
| Pollution degree | | 3 |
| Overtoltage category | | III |
| Tracking resistance of relay base | | CTI 250 |

Other data

| | |
|--|--|
| Flammability class according to UL 94 | V-0 |
| Ambient temperature | -40...+85 °C |
| Mechanical life | 15x10 ⁶ operations |
| Max. switching rate at rated- / minimum load | 6 min ⁻¹ / 1200 min ⁻¹ |
| Operate- / release time | typ. 5 / 2 ms |
| Bounce time N/O contact/N/C contact | typ. 1 / 5 ms |
| Vibration resistance N/O contact/N/C contact | >15 / 5 g |
| Shock resistance (destruction) | >100 g |
| Category of protection (IEC 61810) | RT II - flux proof (RT III - wash tight on request) |
| Relay weight | 5 g |
| Packaging unit | 25 / 500 pcs. |

PCB layout / terminal assignment

View on solder pins
Dimensions in mm

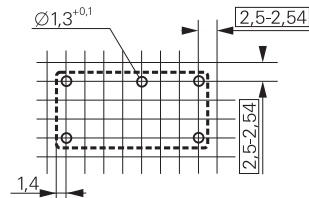

S0176-BA

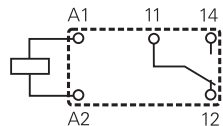

S0176-BB

Dimensions

Dimensions in mm

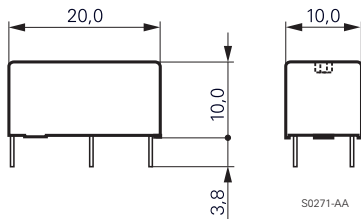

S0271-AA

Product key

Type

Version

0 flux proof *)

Contacts

1 1 C/O contact

Contact material

4 AgNi 90/10

Coil

Coil code: please refer to coil versions table



*) washable version on request

| Product key | Version | Contacts | Contact material | Coil | Part number |
|-------------|------------|---------------|------------------|--------|-------------|
| PE014005 | flux proof | 1 C/O contact | AgNi 90/10 | 5 Vdc | 0-1393219-3 |
| PE014006 | | | | 6 Vdc | 0-1393219-4 |
| PE014012 | | | | 12Vdc | 0-1393219-6 |
| PE014024 | | | | 24 Vdc | 1-1393219-0 |
| PE014048 | | | | 48 Vdc | 1-1393219-3 |

Miniature PCB Relay PE bistable

1pole 5 A, polarized bistable version



Features

- 1 C/O contact
- Cadmium-free contacts
- 4 kV coil-contact
- Insulation according to IEC 255
- Ambient temperature 70 °C
- Low height 10.0 mm

Applications

Room thermostats, electricity meters, domotic devices and white goods

F0221-A



Technical data of approved types on request

Contact data

| | |
|---|-------------------|
| Configuration | 1 C/O contact |
| Type of contact | single contact |
| Rated current | 5 A |
| Rated voltage / max.breaking voltage AC | 250 Vac / 440 Vac |
| Maximum breaking capacity AC | 1250 VA |
| Contact material | AgNi 90/10 |

Contact ratings

| Type | Load | Operations | Standard |
|--------|---------------------------------|-----------------|----------|
| PE 014 | 5A, 250 Vac, on the C/O contact | 10 ⁵ | VDE 0435 |

Coil data

| | |
|---|----------------------------------|
| Nominal voltage | 3...48 Vdc |
| Nominal coil power | typ. 360 mW |
| Minimum energization time | 20 ms |
| Information on reduced pulse duration with higher energization voltages on demand | |
| Max. energization time | 1 min at <10% duty cycle |
| Reset voltage max. | 120 % U _{nom} at -40 °C |

Coil versions, bistable, 1 coil

| Coil code* | Nominal voltage Vdc | Pull-in voltage Vdc | Reset voltage Vdc | Coil resistance Ω | Coil current mA | |
|------------|---------------------|---------------------|-------------------|-------------------|-----------------|-------|
| A02 | C02 | 2.2 | 1.65 | 1.65 | 13±10% | 163.0 |
| A03 | C03 | 3 | 2.25 | 2.25 | 25±10% | 120.0 |
| A05 | C05 | 5 | 3.75 | 3.75 | 69±10% | 72.0 |
| A06 | C06 | 6 | 4.5 | 4.5 | 100±10% | 60.0 |
| A12 | C12 | 12 | 9.0 | 9.0 | 400±10% | 30.0 |
| A24 | C24 | 24 | 18.0 | 18.0 | 1600±10% | 15.0 |

All figures are given for coil without preenergization, at ambient temperature +20°C

* Coil codes A.. and C.. have opposite polarity; refer to coil operation table

Other coil voltages on request

Coils - operation

| version | A.. | | C.. | |
|--|-----|----|-----|----|
| coil terminals | A1 | A2 | A1 | A2 |
| pull-in | + | - | - | + |
| reset | - | + | + | - |
| Contact position not defined at delivery | | | | |

Max. DC load breaking capacity

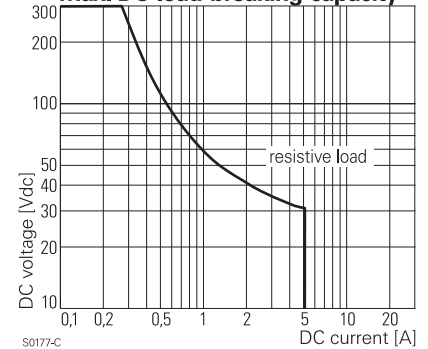

Electrical endurance

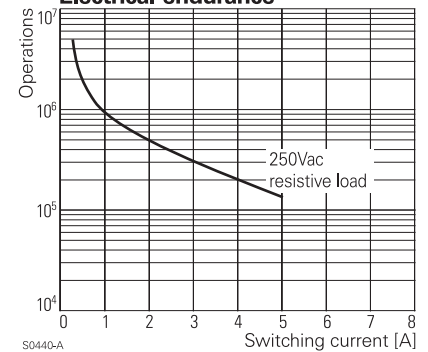

Coil operating range

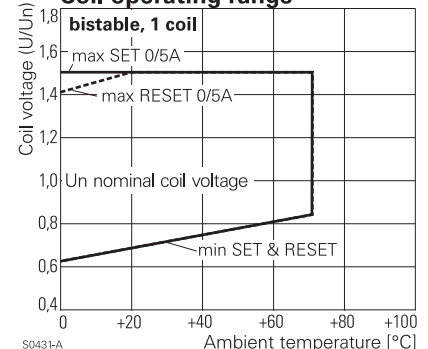

Miniature PCB Relay PE bistable

1pole 5 A, polarized bistable version

| Insulation | | |
|-----------------------------------|----------------------|-----------------------|
| Dielectric strength | coil-contacts | 4000 V _{rms} |
| | open contact circuit | 1000 V _{rms} |
| Clearance / creepage | | ≥3.2 / 4 mm |
| Insulation to IEC 60664 | | |
| Voltage rating | | 250 V |
| Pollution degree | | 3 |
| Overtoltage category | | III |
| Tracking resistance of relay base | | CTI 250 |

| Other data | |
|--|---|
| Flammability class according to UL 94 | V-0 |
| Ambient temperature | -40...+70 °C |
| Mechanical life | 5x10 ⁶ operations |
| Max. switching rate at rated- / minimum load | 6 min ⁻¹ / 1200 min ⁻¹ |
| Shock resistance (destruction) | >100 g |
| Category of protection (IEC 61810) | RT II - flux proof (RT III - wash tight, on request) |
| Relay weight | 5 g |
| Packaging unit | 25 / 500 pcs. |

PCB layout / terminal assignment

View on solder pins
Dimensions in mm

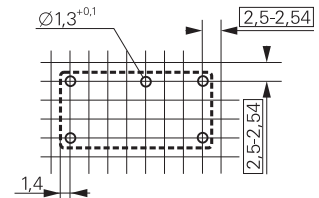

S0176-BA

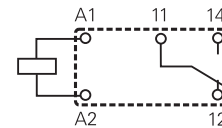

S0176-BB

Dimensions

Dimensions in mm

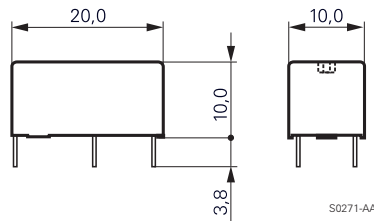

S0271-AA

Product key

Type

Version

0 flux proof *)

Contacts

1 1 C/O contact

Contact material

4 AgNi 90/10

Coil

Coil code: please refer to coil versions table



*) washable version on request

| Product key | Version | Contacts | Cont. material | Coil | Coil | Part number |
|-------------|------------|---------------|----------------|------------|--------|-------------|
| PE014A03 | flux proof | 1 C/O contact | AgNi 90/10 | bistable | 3 Vdc | 4-1415064-1 |
| PE014A05 | | | | 1-coil | 5 Vdc | 7-1415063-1 |
| PE014A06 | | | | polarity A | 6 Vdc | 3-1415053-1 |
| PE014A12 | | | | | 12 Vdc | 8-1415063-1 |
| PE014A24 | | | | | 24 Vdc | 9-1415063-1 |
| PE014C03 | | | | bistable | 3 Vdc | 5-1415064-1 |
| PE014C05 | | | | 1-coil | 5 Vdc | 3-1415064-1 |
| PE014C06 | | | | polarity C | 6 Vdc | 2-1415064-1 |
| PE014C12 | | | | | 12 Vdc | 1-1415064-1 |
| PE014C24 | | | | | 24 Vdc | 0-1415064-1 |

Miniature PCB Relay RE

1 pole 6 A



Features

- 1N/O contact
- Sensitive coil 200 mW
- 4 kV coil-contact
- Optimized height 10,6 mm
- PCB area 200 mm²
- Wash tight

Applications

PLC's, timers, temperature control, I / O cards



Technical data of approved types on request

F0141-A

Contact data

| | |
|---|------------------------------|
| Configuration | 1 N/O contact |
| Type of contact | single contact |
| Rated current | 6 A |
| Rated voltage / max.breaking voltage AC | 250 Vac / 440 Vac |
| Maximum breaking capacity AC | 1500 VA |
| Make current (max. 4 s at duty cycle 10%) | 15 A |
| Contact material | AgCdO, AgNi 0.15 gold plated |

Contact ratings

| Type | Load | Operations | Standard |
|--------|--------------------------|-------------------|----------|
| RE 030 | 2 A, 400 Vac, AC 11 | 2x10 ⁵ | VDE 0660 |
| RE 030 | 2 A, 250 Vac, AC 11 | 4x10 ⁵ | VDE 0660 |
| RE 030 | 0.33 A, 250 Vac, AC 11 | 5x10 ⁶ | VDE 0660 |
| RE 030 | 1/8hp, 120 Vac | 3x10 ⁴ | UL 508 |
| RE 030 | 1/4hp, 240 Vac | 3x10 ⁴ | UL 508 |
| RE 030 | B 300 | | UL 508 |
| RE 030 | 6 A, 30 Vdc, resistive | 5x10 ⁵ | |
| RE 030 | 0.3 A, 50 Vdc, L/R=40 ms | 3x10 ⁶ | |
| RE 030 | 6 (3) A, 250 Vac | 1x10 ⁵ | VDE 0631 |

Coil data

| | |
|--------------------|------------|
| Nominal voltage | 5...48 Vdc |
| Nominal coil power | 200 mW |
| Operate category | 2 / b |

Coil versions, DC-coil

| Coil code | Nominal voltage Vdc | Pull-in voltage Vdc | Release voltage Vdc | Maximum voltage Vdc | Coil resistance Ω | Coil current mA |
|-----------|---------------------|---------------------|---------------------|---------------------|-------------------|-----------------|
| 005 | 5 | 3.5 | 0.5 | 13.5 | 125±10% | 40.0 |
| 006 | 6 | 4.2 | 0.6 | 16.2 | 180±10% | 33.3 |
| 012 | 12 | 8.4 | 1.2 | 32.4 | 720±10% | 16.7 |
| 024 | 24 | 16.8 | 2.4 | 64.8 | 2880±15% | 8.3 |
| 048 | 48 | 33.6 | 4.8 | 129.6 | 11520±15% | 4.2 |

All figures are given for coil without preenergization, at ambient temperature +20°C, single mounting

Other coil voltages on request

Max. DC load breaking capacity

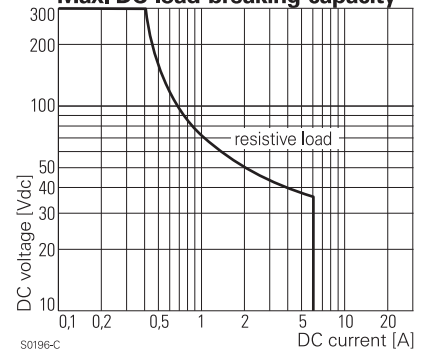

Electrical endurance

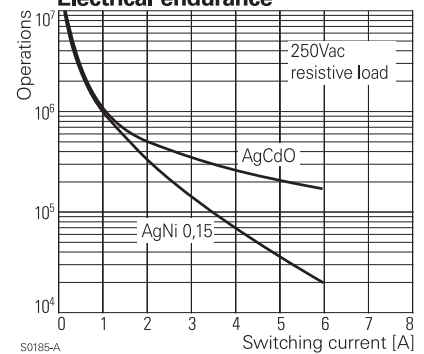

Coil operating range DC

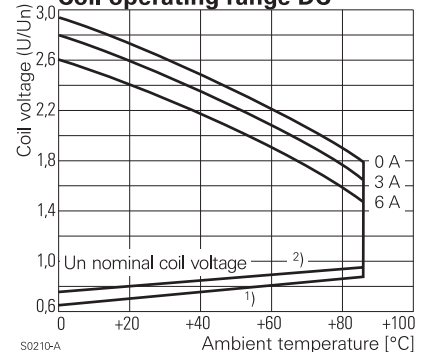

Miniature PCB Relay RE

1 pole 6 A

| Insulation | | |
|---|----------------------|-----------------------|
| Dielectric strength | coil-contacts | 4000 V _{rms} |
| | open contact circuit | 1000 V _{rms} |
| Clearance / creepage | | ≥ 4 / 4 mm |
| Insulation to IEC 60664 | | |
| Voltage rating | | 250 V |
| Pollution degree | | 3 |
| Overvoltage category | | III |
| Insulation to VDE 0110b (2/79) | | |
| Insulation category / reference voltage | | C / 250, B / 400 |

| Other data | | |
|--|-----------------|--|
| Flammability class according to UL 94 | | V-0 |
| Ambient temperature | | -40...+70 °C, -40...+85 °C at 4 A |
| Mechanical life | | > 30x10 ⁶ operations |
| Max. switching rate at rated- / minimum load | | 6 min ⁻¹ / 1200 min ⁻¹ |
| Operate- / release time | | typ. 5 / 1 ms |
| Bounce time | | typ. 1 ms |
| Vibration resistance | open contact: | 10 g |
| | closed contact: | 20 g |
| Shock resistance (destruction) | | 100 g |
| Category of protection (IEC 61810) | | RT III - wash tight |
| Relay weight | | 5 g |
| Packaging unit | | 25 / 500 pcs. |

PCB layout / terminal assignment

View on solder pins
Dimensions in mm

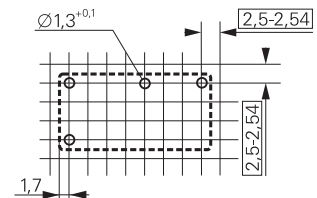

S0176-BH

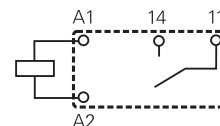

S0176-BJ

Dimensions

Dimensions in mm

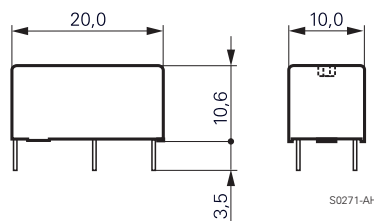

Product key

Type

Version

0 wash tight

Contacts

3 1 N/O contact

Contact material

0 AgCdO

2 AgNi 0,15 gold plated

Coil

Coil code: please refer to coil versions table



| Product key | Version | Contacts | Contact material | Coil | Part number |
|-------------|------------|---------------|--------------------------|-------------|-------------|
| RE030005 | wash tight | 1 N/O contact | AgCdO | 5 Vdc | 0-1393217-1 |
| RE030006 | | | | 6 Vdc | 0-1393217-2 |
| RE030012 | | | | 12 Vdc | 0-1393217-4 |
| RE030024 | | | | 24 Vdc | 0-1393217-8 |
| RE030048 | | | 48 Vdc | 1-1393217-1 | |
| RE032005 | | | AgNi 0,15 gold plated | 5 Vdc | 1-1393217-9 |
| RE032006 | | | | 6 Vdc | 2-1393217-0 |
| RE032012 | | | | 12 Vdc | 2-1393217-2 |
| RE032024 | | | | 24 Vdc | 2-1393217-4 |
| RE032048 | | | | 48 Vdc | 2-1393217-5 |

Slim PCB Relay PCN

1 pole 3 A



PCN-02b-c

Features

- 1 N/O contact
- Only 5 mm slim
- 3 A switching current
- Load range 1 mA up to 3 A
- Sensitive coil 120 mW
- Allows high function-/packing density
- Cadmium-free contacts
- Z type with reinforced insulation

Applications

Centralized and decentralized heating control, extremely narrow interface elements, interface technology, timers, PLC's, I/O modules, I/O-ports



Technical data of approved types on request

Contact data

| | |
|---|--------------------|
| Configuration | 1 N/O contact |
| Type of contact | bifurcated contact |
| Rated current | 3 A |
| Rated voltage / max.breaking voltage AC | 250 Vac / 277 Vac |
| Maximum breaking capacity AC | 1250 VA |
| Contact material | AgNi |
| Minimum contact load | 5 Vdc / 1 mA |

Contact ratings

| Type | Load | Operations |
|------|--------------------------|-------------------|
| | 3 A / 250 Vac, resistive | 1x10 ⁵ |
| | 3 A / 30 Vdc, resistive | 1x10 ⁵ |

Coil data

| | |
|--------------------|------------|
| Nominal voltage | 5...24 Vdc |
| Nominal coil power | 120 mW |
| Operate power | 58.8 mW |
| Operate category | 1 |

Coil versions

| Coil code | Nominal voltage Vdc | Pull-in voltage Vdc | Release voltage Vdc | Maximum voltage Vdc | Coil resistance Ω | Coil current mA |
|-----------|---------------------|---------------------|---------------------|---------------------|-------------------|-----------------|
| 05 | 5 | 3.5 | 0.5 | 6.5 | 208 ±10% | 24.0 |
| 06 | 6 | 4.2 | 0.6 | 7.8 | 300 ±10% | 20.0 |
| 09 | 9 | 6.3 | 0.9 | 11.7 | 675 ±10% | 13.3 |
| 12 | 12 | 8.4 | 1.2 | 15.6 | 1200 ±10% | 10.0 |
| 24 | 24 | 16.8 | 2.4 | 31.2 | 4800 ±10% | 5.0 |

All figures are given for coil without preenergization, at ambient temperature +20°C
Other coil voltages on request

Max. DC load breaking capacity

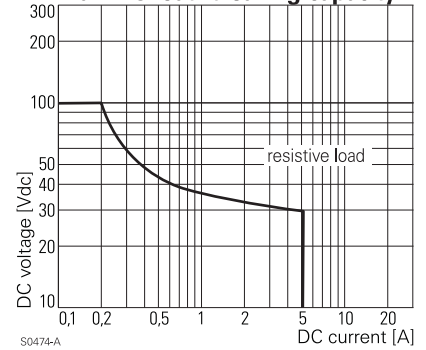

S0474-A

Electrical endurance

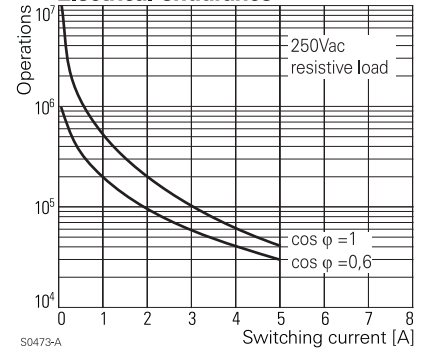

S0473-A

Coil operating range DC

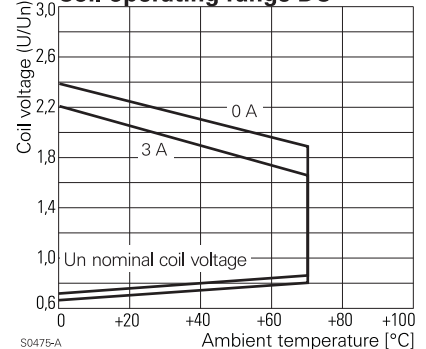

S0475-A

Slim PCB Relay PCN

1 pole 3 A

| Insulation | | |
|-----------------------------------|----------------------|-----------------------|
| Dielectric strength | coil-contacts | 3000 V _{rms} |
| | open contact circuit | 750 V _{rms} |
| Surge voltage resistance | coil-contacts | 5000 V (1.2 / 50 μs) |
| Clearance / creepage | | 3.5 mm |
| Insulation to IEC 664/VDE 0110 | | |
| | Voltage rating | 277 Vac |
| | Pollution degree | 2 |
| | Overvoltage category | II |
| Tracking resistance of relay base | | PTI 600 |

| Other data | |
|--|---|
| Flammability class according to UL 94 | V-0 |
| Ambient temperature | -30...+70 °C |
| Mechanical life | 20x10 ⁶ operations |
| Max. switching rate at rated- / minimum load | 10 min ⁻¹ / 1200 min ⁻¹ |
| Operate- / release time typ. | 5 / 2 ms |
| Bounce time N/O contact typ. | < 1 ms |
| Category of protection (IEC 61810) | RT III - wash tight |
| Relay weight | 3 g |
| Packaging unit | 25 / 2000 |

PCB layout / terminal assignment

View on solder pins
Dimensions in mm

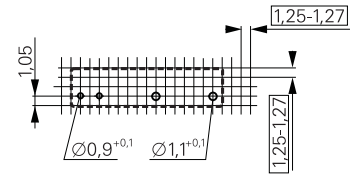

S0471-AA

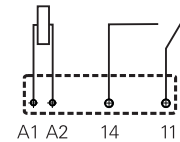

S0471-AB

Dimensions

Dimensions in mm

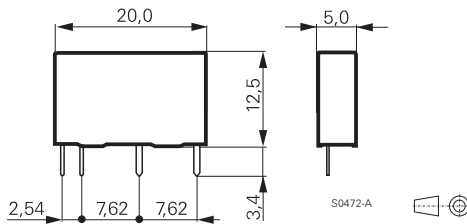

Product key



Type

Number of contacts

1 1 pole

Coil

coil code: please refer to coil versions table

Coil version

D standard 120 mW

Contact material

3 AgNi

Contact configuration

M 1 N/O contact

Version

H wash tight

Insulation

Z high insulation

Other types on request

| Product key | Contacts | Coil | Coil | Contacts | Version | Part number |
|--------------|----------|--------|----------|----------|-----------------|-------------|
| PCN-105D3MHZ | 1-pole | 5 Vdc | standard | 1 N/O | wash tight | 3-1461491-0 |
| PCN-106D3MHZ | | 6 Vdc | 120 mW | AgNi | high insulation | 3-1461491-1 |
| PCN-112D3MHZ | | 12 Vdc | | | | 3-1461491-3 |
| PCN-124D3MHZ | | 24 Vdc | | | | 3-1461491-6 |

Slim PCB Relay SNR

1 pole 6 A



F0140-C

Features

- 1 C/O or 1 N/O contact
- Only 5 mm wide
- 6 A switching current
- Sensitive coil 170 mW
- 4 kV coil-contact, 6 / 8 mm clearance/creepage
- N/O version with 8 / 8 mm clearance/creepage on request
- Protection class II
- Allows high function-/packing density
- Cadmium-free contacts, AgNi 90/10 for AC-loads

Applications

Centralized and decentralized heating control, extremely narrow interface elements, interface technology, timers, PLC's, I/O modules, I/O-ports



Technical data of approved types on request

Contact data

| | | | |
|---|-----------------------------------|--------------------|-----------------|
| Configuration | 1 C/O contact or 1 N/O contact | | |
| Type of contact | single contact | | |
| Rated current | 6 A | | |
| Rated voltage / max.breaking voltage AC | 250 Vac / 440 Vac | | |
| Maximum breaking capacity AC | 1500 VA | | |
| Contact material | AgSnO ₂ gold plated | AgSnO ₂ | AgNi90/10 |
| Minimum contact load | ≥10 mA 5 V | ≥100 mA 12 V | ≥100 mA 12 V |

Contact ratings

| Type | Load | Operations |
|-------|--------------------------|-------------------|
| -A302 | 5 A, 250 Vac, resistive | 1x10 ⁵ |
| -A302 | 2 A, 250 Vac, cosφ0.4 | 2x10 ⁵ |
| -A302 | 1 A, 24 Vdc, L / R=48 ms | 2x10 ⁵ |

Coil data

| | |
|--------------------|---------------|
| Nominal voltage | 5...48 Vdc |
| Nominal coil power | 170 mW |
| Operate power | 75 mW...95 mW |
| Operate category | 2 / b |

Coil versions

| Coil code | Nominal voltage Vdc | Pull-in voltage Vdc | Release voltage Vdc | Maximum voltage Vdc | Coil resistance Ω | Coil current mA |
|-----------|---------------------|---------------------|---------------------|---------------------|-------------------|-----------------|
| 005 | 5 | 3.5 | 0.25 | 11.2 | 147±10% | 34.0 |
| 012 | 12 | 8.4 | 0.6 | 26.8 | 848±10% | 14.2 |
| 024 | 24 | 16.8 | 1.2 | 53.7 | 3390±10% | 7.1 |
| 048 | 48 | 33.6 | 2.4 | 100.0 | 10600±15% | 4.5 |

All figures are given for coil without preenergization, at ambient temperature +20°C
Other coil voltages on request

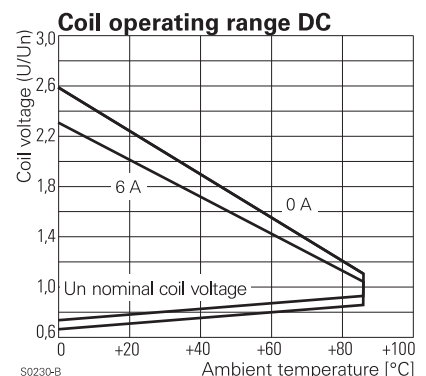
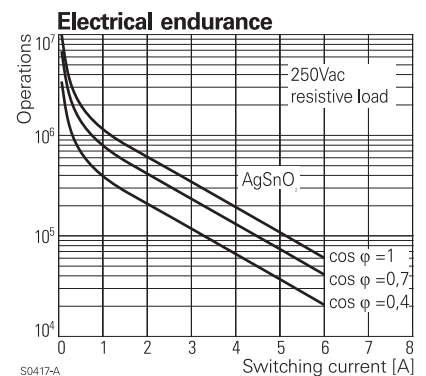
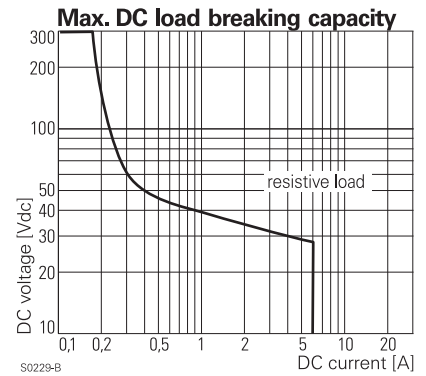

Slim PCB Relay SNR

1 pole 6 A

| Insulation | | |
|--|---|-----------------------|
| Dielectric strength | coil-contacts | 4000 V _{rms} |
| | open contact circuit | 1000 V _{rms} |
| Surge voltage resistance | coil-contacts | 6000 V (1.2 / 50 μs) |
| Clearance / creepage (standard) | | 6 / 8 mm |
| Insulation to IEC 664/VDE 0110 (04 / 97) | | |
| | Voltage rating | 250 V |
| | Pollution degree | 3 |
| | Overvoltage category | III |
| Insulation to VDE 0110b (2/79) | | |
| | Insulation category / reference voltage | C / 250 |
| Tracking resistance of relay base | | CTI 250 |

PCB layout / terminal assignment

View on solder pins
Dimensions in mm

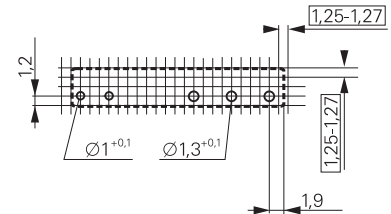

S0258-AA

| Other data | |
|--|--|
| Flammability class according to UL 94 | V-0 |
| Ambient temperature | -40...+85 °C |
| Mechanical life | 10x10 ⁶ operations |
| Max. switching rate at rated- / minimum load | 6 min ⁻¹ / 20 s ⁻¹ |
| Operate- / release time | 5 / 2.5 ms |
| Bounce time N/O contact/N/C contact | 1.5 / 5 ms |
| Category of protection (IEC 61810) | RT III - wash tight |
| Relay weight | 6 g |
| Packaging unit | 20 / 1000 pcs. |
| Accessories | see accessories SNR |

1 C/O contact

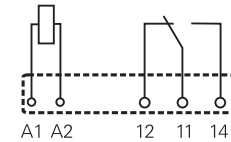

S0258-AB

1 N/O contact

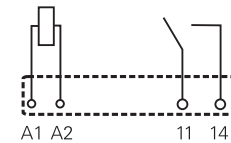

S0258-AC

Dimensions

Dimensions in mm

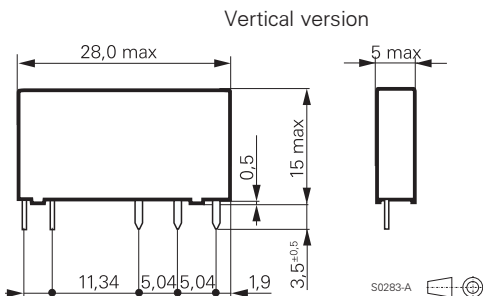

Flat pack version

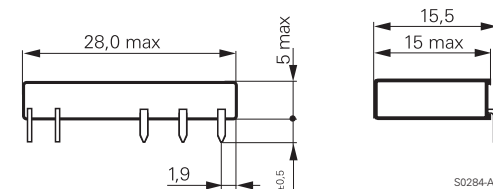

Product key

V 2 3 0 9 2 - 1 - A

Type

Version

A PCB vertical version

B PCB flat pack version

Version

1 wash tight

Coil

Coil code: please refer to coil versions table

Contact system

A standard

Contact material

2 AgSnO₂, gold plated

3 AgSnO₂

8 AgNi 90/10

Contact configuration

01 1 C/O contact

02 1 N/O contact

N/O version with 8/8mm clearance and creepage and other types on request

Slim PCB Relay SNR

1 pole 6 A

| Product key | Version | Contacts | Contact material | Coil | Part number |
|-------------------|------------------|---------------|------------------|--------|-------------|
| V23092-A1005-A201 | PCB | 1 C/O contact | AgSnO, gold pl. | 5 Vdc | 0-1393236-1 |
| V23092-A1005-A202 | vertical version | 1 N/O contact | | | 8-1415067-1 |
| V23092-A1005-A301 | wash tight | 1 C/O contact | AgSnO | | 0-1393236-2 |
| V23092-A1005-A302 | | 1 N/O contact | | | 9-1415067-1 |
| V23092-A1005-A801 | | 1 C/O contact | AgNi 90/10 | | 1-1415068-1 |
| V23092-A1005-A802 | | 1 N/O contact | | | 0-1415068-1 |
| V23092-A1012-A201 | | 1 C/O contact | AgSnO, gold pl. | 12 Vdc | 0-1393236-4 |
| V23092-A1012-A202 | | 1 N/O contact | | | 0-1393236-5 |
| V23092-A1012-A301 | | 1 C/O contact | AgSnO | | 0-1393236-7 |
| V23092-A1012-A302 | | 1 N/O contact | | | 0-1393236-8 |
| V23092-A1012-A801 | | 1 C/O contact | AgNi 90/10 | | 1-1393236-3 |
| V23092-A1012-A802 | | 1 N/O contact | | | 2-1415068-1 |
| V23092-A1024-A201 | | 1 C/O contact | AgSnO, gold pl. | 24 Vdc | 2-1393236-1 |
| V23092-A1024-A202 | | 1 N/O contact | | | 2-1393236-2 |
| V23092-A1024-A301 | | 1 C/O contact | AgSnO | | 2-1393236-4 |
| V23092-A1024-A302 | | 1 N/O contact | | | 2-1393236-5 |
| V23092-A1024-A801 | | 1 C/O contact | AgNi 90/10 | | 3-1393236-0 |
| V23092-A1024-A802 | | 1 N/O contact | | | 5-1415063-1 |
| V23092-A1048-A201 | | 1 C/O contact | AgSnO, gold pl. | 48 Vdc | 3-1393236-5 |
| V23092-A1048-A202 | | 1 N/O contact | | | 3-1393236-6 |
| V23092-A1048-A301 | | 1 C/O contact | AgSnO | | 3-1393236-7 |
| V23092-A1048-A302 | | 1 N/O contact | | | 3-1393236-8 |
| V23092-A1048-A801 | | 1 C/O contact | AgNi 90/10 | | 3-1393236-9 |
| V23092-A1048-A802 | | 1 N/O contact | | | 3-1415068-1 |

Miniature Power PCB Relay RY II

1 pole 8 A



F0142-C

Features

- Low component height 12.3 mm
- 1 C/O or 1 N/O or 1 N/C contact
- 5 kV / 8 mm coil-contact
- Protection class II (VDE 0700)
- Pinnings: 3.2 and 5 mm
- Sockets with PCB-type or screw-type terminals
- Especially suitable for resistive and inductive loads on N/O and N/C contacts

Applications

Heating control, interface technology, domestic appliances, timers, temperature control



Technical data of approved types on request

Contact data

| | |
|---|---|
| Configuration | 1 C/O contact, 1 N/O contact, 1 N/C contact |
| Type of contact | single contact |
| Rated current | 8 A |
| Rated voltage / max.breaking voltage AC | 250 Vac / 440 Vac |
| Maximum breaking capacity AC | 2000 VA |
| Make current (max. 4 s at duty cycle 10%) | 30 A |
| Contact material | AgCdO, AgNi 0.15, AgSnO ₂ |

Contact ratings

| Type | Load | Operations | Standard |
|-------|--------------------------|--------------------|----------|
| RY610 | B 300, 120 Vac, 70 °C | | UL 508 |
| RY610 | B 300, 240 Vac, 70 °C | | UL 508 |
| RY610 | 1 / 4 hp, 120 Vac, 70 °C | | UL 508 |
| RY610 | 1 / 2 hp, 240 Vac, 70 °C | | UL 508 |
| RY610 | 8 A, 28 Vdc, 70 °C | >3x10 ⁴ | UL 508 |
| RY610 | 0.28 A, 250 Vdc, 70 °C | >3x10 ⁴ | UL 508 |
| RY531 | 6 (4) A, 250 Vac, 85 °C | 1x10 ⁵ | VDE 0631 |

Coil data

| | |
|--------------------|----------------|
| Nominal voltage | 5...48 Vdc |
| Nominal coil power | approx. 220 mW |
| Operate category | 2 / b |

Coil versions

| Coil code | Nominal voltage Vdc | Pull-in voltage Vdc | Release voltage Vdc | Maximum voltage Vdc | Coil resistance Ω | Coil current mA |
|-----------|---------------------|---------------------|---------------------|---------------------|-------------------|-----------------|
| 005 | 5 | 3.5 | 0.5 | 11.8 | 113±10% | 44.0 |
| 006 | 6 | 4.2 | 0.6 | 14.1 | 164±10% | 36.7 |
| 012 | 12 | 8.4 | 1.2 | 28.2 | 620±10% | 19.3 |
| 024 | 24 | 16.8 | 2.4 | 56.4 | 2350±10% | 10.2 |
| 048 | 48 | 33.6 | 4.8 | 112.8 | 9600±10% | 5.0 |

All figures are given for coil without preenergization, at ambient temperature +20°C

Other coil voltages on request

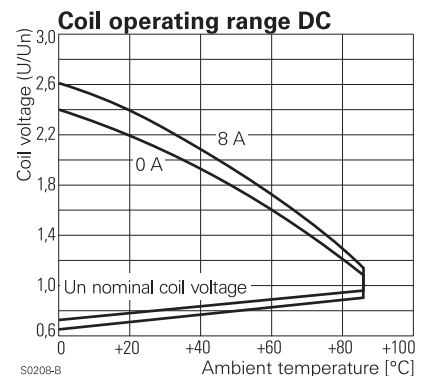
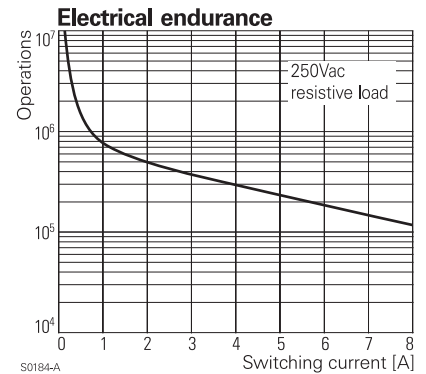
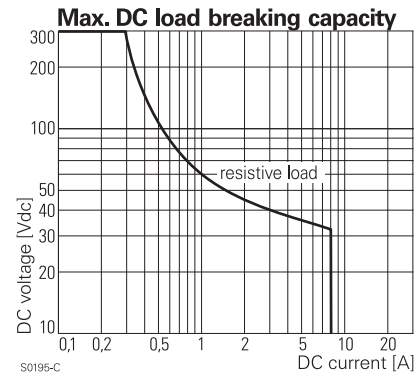

Miniature Power PCB Relay RY II

1 pole 8 A

| Insulation | | |
|---|----------------------|-----------------------|
| Dielectric strength | coil-contacts | 5000 V _{rms} |
| | open contact circuit | 1000 V _{rms} |
| Clearance / creepage | | 8 / 8 mm |
| Insulation to IEC 60664 | | |
| Voltage rating | | 250 V |
| Pollution degree | | 3 |
| Overvoltage category | | III |
| Insulation to VDE 0110b (2/79) | | |
| Insulation category / reference voltage | | C / 250 |
| Tracking resistance of relay base | | CTI 250 |

| Other data | |
|--|--|
| Ambient temperature | -40...+85 °C |
| Mechanical life | 30x10 ⁶ operations |
| Max. switching rate at rated- / minimum load | 6 min ⁻¹ / 20 s ⁻¹ |
| Operate- / release time | 7 / 3 ms |
| Bounce time N/O contact | 1 ms |
| Vibration resistance N/O / N/C contact | 20 / 5 g, 10...500 Hz |
| Shock resistance (destruction) | 100 g |
| Category of protection (IEC 61810) | RT II - flux proof, RT III - wash tight |
| Relay weight | 8 g |
| Packaging unit | 20 / 500 pcs. |
| Accessories | see accessories RY |

Dimensions

Dimensions in mm

Pinning 3.2 mm

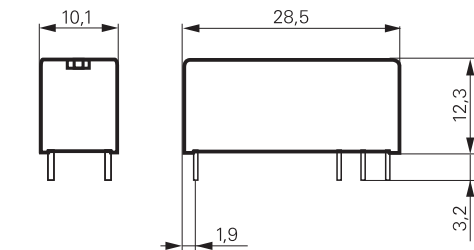

S0274-AA

Pinning 5 mm

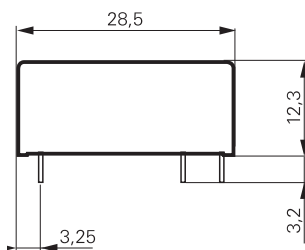

S0274-AB

PCB layout / terminal assignment

1 C/O contact, 3.2 mm

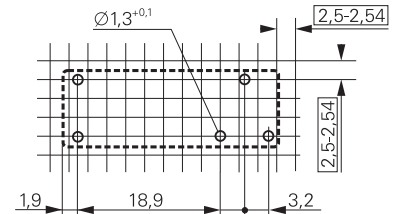

S0254-AA

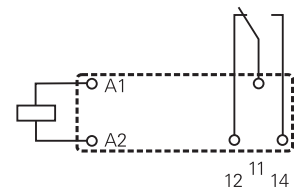

S0254-AB

1 N/O contact, 5 mm

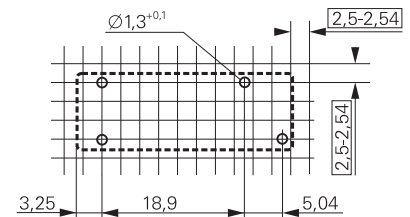

S0254-AC

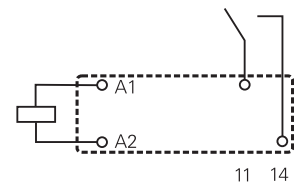

S0254-AD

View on solder pins
Dimensions in mm

Product key

Type

Version

2 pinning 3.2 mm, flux proof
5 pinning 5 mm, flux proof

6 pinning 3.2 mm, wash tight
A pinning 5 mm, wash tight

Contacts

1 1 C/O contact, pinning 3.2 mm

3 1 N/O contact, pinning 5 mm

Contact material

0 AgCdO

2 AgNi0.15 gold plated

1 AgNi0.15

3 AgSnO₂

Coil

Coil code: please refer to coil versions table

Other types on request

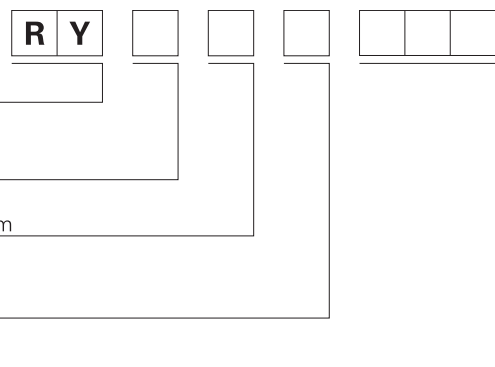

Miniature Power PCB Relay RY II

1 pole 8 A

| Product key | Version | Contacts | Contact material | Coil | Part number | | |
|-------------|------------------------------|---------------|--------------------------|------------------------------|---------------|-------------|-------------|
| RY210005 | pinning 3.2 mm flux proof | 1 C/O contact | AgCdO | 5 Vdc | 3-1393224-1 | | |
| RY210012 | | | | 12 Vdc | 3-1393224-5 | | |
| RY210024 | | | | 24 Vdc | 3-1393224-8 | | |
| RY210048 | | | | 48 Vdc | 4-1393224-1 | | |
| RY211005 | | | AgNi 0.15 | 5 Vdc | 4-1393224-2 | | |
| RY211012 | | | | 12 Vdc | 4-1393224-6 | | |
| RY211024 | | | | 24 Vdc | 4-1393224-9 | | |
| RY211048 | | | | 48 Vdc | 5-1393224-1 | | |
| RY212005 | | | AgNi 0.15 gold plated | 5 Vdc | 5-1393224-2 | | |
| RY212012 | | | | 12 Vdc | 5-1393224-5 | | |
| RY212024 | | | | 24 Vdc | 5-1393224-8 | | |
| RY212048 | | | | 48 Vdc | 5-1393224-9 | | |
| RY213005 | | | AgSnO | 5 Vdc | 6-1393224-0 | | |
| RY213012 | | | | 12 Vdc | 6-1393224-1 | | |
| RY213024 | | | | 24 Vdc | 6-1393224-2 | | |
| RY213048 | | | | 48 Vdc | 6-1393224-3 | | |
| RY530005 | pinning 5 mm flux proof | 1 N/O contact | AgCdO | 5 Vdc | 6-1393224-6 | | |
| RY530012 | | | | 12 Vdc | 6-1393224-9 | | |
| RY530024 | | | | 24 Vdc | 7-1393224-2 | | |
| RY530048 | | | | 48 Vdc | 7-1393224-4 | | |
| RY531005 | | | AgNi 0.15 | 5 Vdc | 7-1393224-6 | | |
| RY531012 | | | | 12 Vdc | 7-1393224-9 | | |
| RY531024 | | | | 24 Vdc | 8-1393224-2 | | |
| RY531048 | | | | 48 Vdc | 8-1393224-3 | | |
| RY532012 | | | AgNi 0.15 gold plated | 12 Vdc | 8-1393224-4 | | |
| RY532024 | | | | 24 Vdc | 8-1393224-5 | | |
| RY533012 | | | AgSnO | 12 Vdc | 8-1393224-8 | | |
| RY533024 | | | | 24 Vdc | 8-1393224-9 | | |
| RY533048 | | | | 48 Vdc | 9-1393224-0 | | |
| RY610005 | | | | pinning 3.2 mm wash tight | 1 C/O contact | AgCdO | 5 Vdc |
| RY610012 | | | 12 Vdc | | | | 1-1393225-0 |
| RY610024 | | | 24 Vdc | | | | 1-1393225-4 |
| RY610048 | 48 Vdc | 1-1393225-5 | | | | | |
| RY611005 | AgNi 0.15 | 5 Vdc | 1-1393225-7 | | | | |
| RY611012 | | 12 Vdc | 1-1393225-9 | | | | |
| RY611024 | | 24 Vdc | 2-1393225-1 | | | | |
| RY611048 | | 48 Vdc | 2-1393225-2 | | | | |
| RY612005 | AgNi 0.15 gold plated | 5 Vdc | 2-1393225-3 | | | | |
| RY612012 | | 12 Vdc | 2-1393225-6 | | | | |
| RY612024 | | 24 Vdc | 2-1393225-9 | | | | |
| RY612048 | | 48 Vdc | 3-1393225-0 | | | | |
| RY613005 | AgSnO | 5 Vdc | 5-1419136-2 | | | | |
| RY613012 | | 12 Vdc | 3-1393225-1 | | | | |
| RY613024 | | 24 Vdc | 3-1393225-3 | | | | |
| RY613048 | | 48 Vdc | 3-1393225-4 | | | | |
| RYA30005 | pinning 5 mm wash tight | 1 N/O contact | AgCdO | 5 Vdc | 0-1393224-1 | | |
| RYA30012 | | | | 12 Vdc | 0-1393224-4 | | |
| RYA30024 | | | | 24 Vdc | 0-1393224-6 | | |
| RYA30048 | | | | 48 Vdc | 7-1393225-7 | | |
| RYA31005 | | | AgNi 0.15 | 5 Vdc | 0-1393224-7 | | |
| RYA31012 | | | | 12 Vdc | 0-1393224-9 | | |
| RYA31024 | | | | 24 Vdc | 1-1393224-2 | | |
| RYA31048 | | | | 48 Vdc | 1-1393224-3 | | |
| RYA32005 | | | AgNi 0.15 gold plated | 5 Vdc | 1-1393224-4 | | |
| RYA32012 | | | | 12 Vdc | 1-1393224-6 | | |
| RYA32024 | | | | 24 Vdc | 1-1393224-8 | | |
| RYA33005 | | | | AgSnO | 5 Vdc | 1-1393224-9 | |
| RYA33024 | | | 24 Vdc | | 2-1393224-1 | | |

Miniature Power PCB Relay MSR

1 pole 8 A



Features

- 1C/O or 1N/O contact
- High inrush currents with AgSnO contacts (TV4 = 65 A)
- 4 kV/8 mm coil-contact
- Protection class II
- Ambient temperature up to 85°C at 8 A

Applications

HVAC, interface technology, power supplies, TV-/Monitor control, computer-/communication technology, domestic appliances, Hi-Fi products, timers

F0143-C



Technical data of approved types on request

Contact data

| | |
|---|---------------------------------------|
| Configuration | 1 C/O contact or 1 N/O contact |
| Type of contact | single contact |
| Rated current | 8 A |
| Rated voltage / max.breaking voltage AC | 250 Vac / 440 Vac |
| Maximum breaking capacity AC | 2000 VA |
| Make current (max. 4 s at duty cycle 10%) | 15 A |
| Contact material | AgSnO ₂ , AgCdO, AgNi 0.15 |

Contact ratings

| Type | Load | Operations | Standard |
|-------|-------------------------|--------------------|----------|
| -A402 | 8 A, 240 Vac, resistive | 1x10 ⁵ | UL 508 |
| -A302 | 30 / 3 A, 230 Vac, AC15 | 3x10 ⁵ | VDE 0660 |
| -A302 | 65 / 4 A, 120 Vac, TV4 | 25x10 ³ | UL 508 |

Coil data

| | |
|--------------------|----------------|
| Nominal voltage | 3...60 Vdc |
| Nominal coil power | approx. 220 mW |
| Operate category | 2 / b |

Coil versions

| Coil code | Nominal voltage Vdc | Pull-in voltage Vdc | Release voltage Vdc | Maximum voltage Vdc | Coil resistance Ω | Coil current mA |
|-----------|---------------------|---------------------|---------------------|---------------------|-------------------|-----------------|
| 002 | 5 | 3.4 | 0.5 | 12.5 | 118±10% | 42.4 |
| 003 | 6 | 4.1 | 0.6 | 15.0 | 165±10% | 36.4 |
| 005 | 12 | 8.2 | 1.2 | 30.0 | 650±10% | 18.5 |
| 007 | 24 | 16.3 | 2.4 | 56.0 | 2270±10% | 10.6 |
| 009 | 48 | 32.6 | 4.8 | 110.0 | 8790±10% | 5.5 |
| 010 | 60 | 40.8 | 6.0 | 142.0 | 15265±15% | 4.0 |

All figures are given for coil without preenergization, at ambient temperature +20°C

Other coil voltages on request

Max. DC load breaking capacity

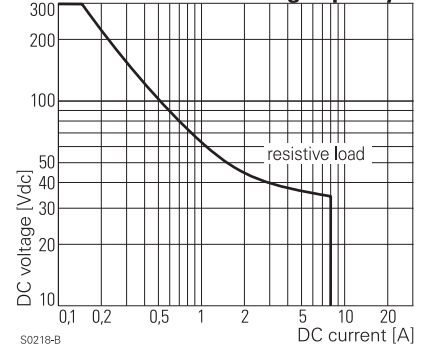

S0218-B

Electrical endurance

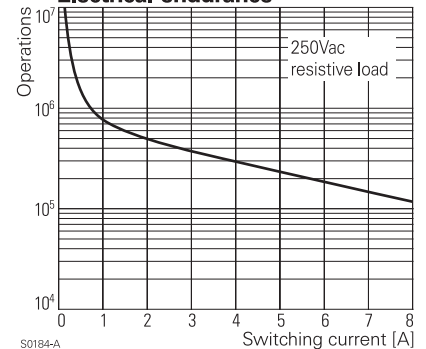

S0184-A

Coil operating range DC

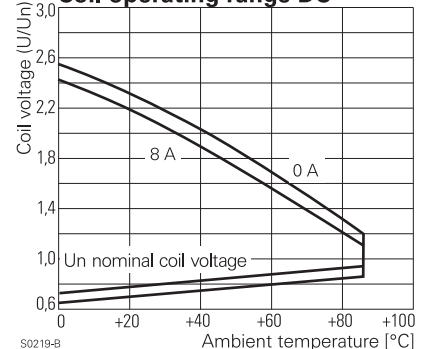

S0219-B

Miniature Power PCB Relay MSR

1 pole 8 A

| Insulation | | |
|---|----------------------|-----------------------|
| Dielectric strength | coil-contacts | 4000 V _{rms} |
| | open contact circuit | 1000 V _{rms} |
| Clearance / creepage (standard) | | 8 / 8 mm |
| Insulation to IEC 60664 | | |
| Voltage rating | | 250 V |
| Pollution degree | | 3 |
| Overvoltage category | | III |
| Insulation to VDE 0110b (2/79) | | |
| Insulation category / reference voltage | | C / 250 |
| Tracking resistance of relay base | | CTI 250 |

| Other data | |
|--|--|
| Flammability class according to UL 94 | V-0 |
| Ambient temperature | -40...+85 °C |
| Mechanical life | 10x10 ⁶ operations |
| Max. switching rate at rated- / minimum load | 6 min ⁻¹ / 20 s ⁻¹ |
| Operate- / release time | 6 / 2.5 ms |
| Category of protection (IEC 61810) | RT III - wash tight |
| Relay weight | 11 g |
| Packaging unit | 20 / 1000 pcs. |

PCB layout / terminal assignment

View on solder pins
Dimensions in mm

1 C/O contact, 3.2 mm

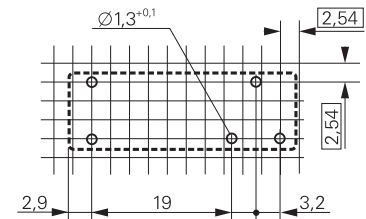

S0255-AA

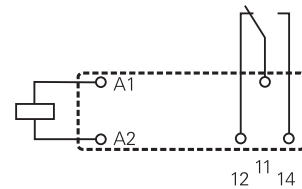

S0255-AB

1 N/O contact, 5 mm

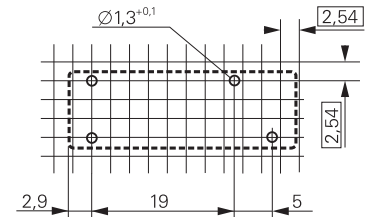

S0255-AH

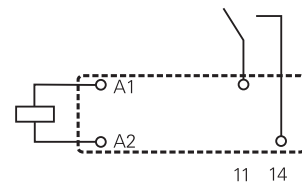

S0255-AI

Dimensions

Dimensions in mm

1 C/O contact, 3.2 mm

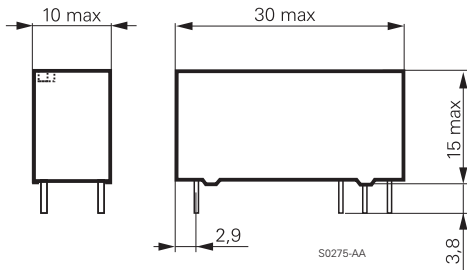

S0275-AA

1 N/O contact, 5 mm

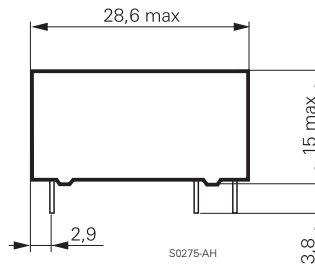

S0275-AH

Product key

V 2 3 0 6 1 - 1 - A

Type

Version

A 1 N/O contact **B** 1 C/O contact

Version

1 standard, wash tight

Coil

Coil code: please refer to coil versions table

Contact version

A standard

Contact material

3 AgSnO₂ **5** AgNi 0,15, gold flashed
4 AgCdO **6** AgCdO, gold plated

Contact configuration

01 1 C/O contact **02** 1 N/O contact

Other types on request

Miniature Power PCB Relay MSR

1 pole 8 A

| Product key | Version | Contacts | Contact material | Coil | Part number |
|-------------------|------------|---------------|--------------------|--------|-------------|
| V23061-A1002-A302 | standard | 1 N/O contact | AgSnO | 5 Vdc | 0-1393222-4 |
| V23061-A1002-A402 | wash tight | | AgCdO | | 0-1393222-5 |
| V23061-A1002-A502 | | | AgNi 0.15 gold fl. | | 0-1393222-6 |
| V23061-A1003-A302 | | | AgSnO | 6 Vdc | 0-1393222-9 |
| V23061-A1003-A402 | | | AgCdO | | 1-1393222-2 |
| V23061-A1003-A502 | | | AgNi 0.15 gold fl. | | 1-1393222-3 |
| V23061-A1005-A302 | | | AgSnO | 12 Vdc | 2-1393222-0 |
| V23061-A1005-A402 | | | AgCdO | | 2-1393222-3 |
| V23061-A1005-A502 | | | AgNi 0.15 gold fl. | | 2-1393222-7 |
| V23061-A1005-A602 | | | AgCdO gold pl. | | 2-1393222-8 |
| V23061-A1007-A302 | | | AgSnO | 24Vdc | 3-1393222-9 |
| V23061-A1007-A402 | | | AgCdO | | 4-1393222-2 |
| V23061-A1007-A502 | | | AgNi 0.15 gold fl. | | 4-1393222-6 |
| V23061-A1007-A602 | | | AgCdO gold pl. | | 4-1393222-7 |
| V23061-A1009-A402 | | | AgCdO | 48 Vdc | 5-1393222-6 |
| V23061-A1009-A502 | | | AgNi 0.15 gold fl. | | 5-1393222-7 |
| V23061-A1009-A602 | | | AgCdO gold pl. | | 5-1393222-8 |
| V23061-A1010-A402 | | | AgCdO | 60 Vdc | 6-1393222-1 |
| V23061-A1010-A502 | | | AgNi 0.15 gold fl. | | 6-1393222-2 |
| V23061-A1010-A602 | | | AgCdO gold pl. | | 6-1393222-3 |
| V23061-B1002-A301 | | 1 C/O contact | AgSnO | 5 Vdc | 7-1393222-2 |
| V23061-B1002-A401 | | | AgCdO | | 7-1393222-3 |
| V23061-B1002-A501 | | | AgNi 0.15 gold fl. | | 7-1393222-4 |
| V23061-B1002-A601 | | | AgCdO gold pl. | | 7-1393222-5 |
| V23061-B1003-A401 | | | AgCdO | 6 Vdc | 7-1393222-9 |
| V23061-B1003-A501 | | | AgNi 0.15 gold fl. | | 8-1393222-1 |
| V23061-B1003-A601 | | | AgCdO gold pl. | | 8-1393222-2 |
| V23061-B1005-A301 | | | AgSnO | 12Vdc | 9-1393222-1 |
| V23061-B1005-A401 | | | AgCdO | | 9-1393222-4 |
| V23061-B1005-A501 | | | AgNi 0.15 gold fl. | | 9-1393222-7 |
| V23061-B1005-A601 | | | AgCdO gold pl. | | 9-1393222-9 |
| V23061-B1007-A301 | | | AgSnO | 24Vdc | 1-1393223-7 |
| V23061-B1007-A401 | | | AgCdO | | 2-1393223-1 |
| V23061-B1007-A501 | | | AgNi 0.15 gold fl. | | 2-1393223-5 |
| V23061-B1007-A601 | | | AgCdO gold pl. | | 2-1393223-6 |
| V23061-B1009-A301 | | | AgSnO | 48 Vdc | 3-1393223-7 |
| V23061-B1009-A401 | | | AgCdO | | 3-1393223-8 |
| V23061-B1009-A501 | | | AgNi 0.15 gold fl. | | 3-1393223-9 |
| V23061-B1009-A601 | | | AgCdO gold pl. | | 4-1393223-0 |
| V23061-B1010-A401 | | | AgCdO | 60 Vdc | 4-1393223-2 |
| V23061-B1010-A501 | | | AgNi 0.15 gold fl. | | 4-1393223-3 |
| V23061-B1010-A601 | | | AgCdO gold pl. | | 4-1393223-4 |

Power PCB Relay RT1

1 pole 12 / 16 A, DC- or AC-coil



F0144-B

Features

- 1 C/O or 1 N/O contact
- Sensitive coil 400 mW
- 5 kV / 10 mm coil-contact, Protection class II (VDE 0700)
- Ambient temperature 85°C (DC-coil)
- Height 15.7 mm
- Sockets with PCB-type or screw-type terminals
- Gold plated contacts available

Applications

Boiler control, timers, garage door control, POS automation, interface modules



Technical data of approved types on request

Contact data

| | | |
|---|------------------------------------|---------|
| Configuration | 1 C/O contact or 1 N/O contact | |
| Type of contact | single contact | |
| Rated current | 12 A | 16 A |
| Rated voltage / max.breaking voltage AC | 250 Vac / 440 Vac | |
| Maximum breaking capacity AC | 3000 VA | 4000 VA |
| Make current (max. 4 s at duty cycle 10%) | 25 A | 30 A |
| Contact material | AgNi 90/10, AgNi 90/10 gold plated | |

Contact ratings

| Type | Load | Operations |
|-------|--|---------------------|
| RT314 | 1000 W, 250 Vac, incandescent lamps | 1.2x10 ³ |
| RT314 | 16 A, 250 Vac, cosφ=1, N/C contact | 53x10 ³ |
| RT314 | 10 A, 250 Vac, cosφ=0.6, C/O contact | 2x10 ⁵ |
| RT314 | 5 A / 2 A, 250 Vac, cosφ=1, tumble-drier motor, N/O contact | 1.1x10 ⁶ |
| RT314 | 0.26A _{peak} / 0.01 A, 230 Vac, cosφ=0.38, valve, N/O contact | 7.6x10 ⁶ |

Coil data

| | | |
|--------------------|---------|--------------|
| Nominal voltage | DC coil | 5...110 Vdc |
| | AC coil | 24...230 Vac |
| Nominal coil power | DC coil | 400 mW |
| | AC coil | 0.75 VA |
| Operate category | 2 / b | |

Coil versions, DC-coil

| Coil code | Nominal voltage Vdc | Pull-in voltage Vdc | Release voltage Vdc | Maximum voltage Vdc | Coil resistance Ω | Coil current mA |
|-----------|---------------------|---------------------|---------------------|---------------------|-------------------|-----------------|
| 005 | 5 | 3.5 | 0.5 | 12.7 | 62±10% | 80.0 |
| 006 | 6 | 4.2 | 0.6 | 15.3 | 90±10% | 66.7 |
| 012 | 12 | 8.4 | 1.2 | 30.6 | 360±10% | 33.3 |
| 024 | 24 | 16.8 | 2.4 | 61.2 | 1440±10% | 16.7 |
| 048 | 48 | 33.6 | 4.8 | 122.4 | 5520±10% | 8.7 |
| 060 | 60 | 42.0 | 6.0 | 153.0 | 7340±12% | 8.1 |
| 110 | 110 | 77.0 | 11.0 | 280.5 | 26600±12% | 4.1 |

All figures are given for coil without preenergization, at ambient temperature +20°C
Other coil voltages on request

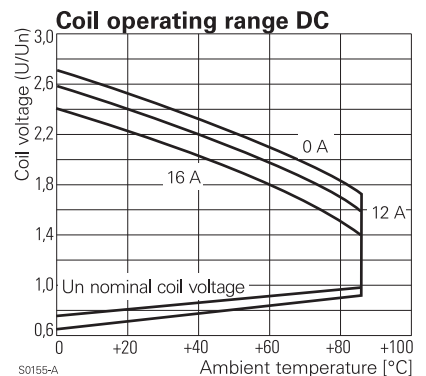
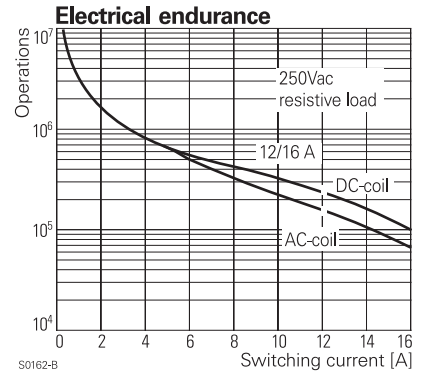
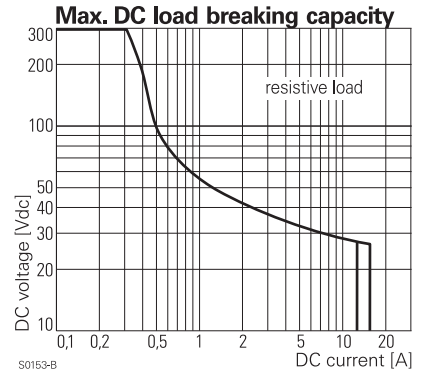

Power PCB Relay RT1

1 pole 12 / 16 A, DC- or AC-coil

Coil versions, AC-coil

| Coil code | Nominal voltage Vac | Pull-in voltage Vac | Release voltage Vac | Maximum voltage Vac | Coil resistance Ω | Coil current mA |
|-----------|---------------------|---------------------|---------------------|---------------------|--------------------------|-----------------|
| 524 | 24 | 18.0 | 3.6 | 36.0 | 350 ± 10% | 31.6 |
| 615 | 115 | 86.3 | 17.3 | 172.5 | 8100 ± 15% | 6.6 |
| 730 | 230 | 172.5 | 34.5 | 345.0 | 32500 ± 15% | 3.2 |

All figures are given for coil without preenergization, at ambient temperature +20°C

Insulation

| | | |
|---|----------------------|-----------------------|
| Dielectric strength | coil-contacts | 5000 V _{rms} |
| | open contact circuit | 1000 V _{rms} |
| Clearance / creepage | | 10 / 10 mm |
| Insulation to IEC 60664 | | |
| Voltage rating | | 250 V |
| Pollution degree | | 3 |
| Overvoltage category | | III |
| Insulation to VDE 0110b (2/79) | | |
| Insulation category / reference voltage | | C / 250 |
| Tracking resistance of relay base | | CTI 250 |

Other data

| | |
|--|--|
| Flammability class according to UL 94 | V-0 |
| Coil insulation system according to UL 1446 | Class F |
| Ambient temperature | DC-coil -40...+85 °C AC-coil -40...+70 °C |
| Mechanical life | DC-coil >30x10 ⁶ operations AC-coil >10x10 ⁶ operations |
| Max. switching rate at rated- / minimum load | 6 min ⁻¹ / 1200 min ⁻¹ |
| Operate- / release time DC-coil | typ. 7 / 3 ms |
| Bounce time N/O contact/N/C contact | typ. 1 / 3 ms |
| Vibration resistance N/O / N/C contact | 20 / 5 g, 30...500 Hz |
| Shock resistance (destruction) | 100 g |
| Category of protection (IEC 61810) | RT II, RT III |
| Relay weight | 14 g |
| Packaging unit | 20 / 500 pcs. |
| Accessories | see accessories RT |

Coil operating range AC

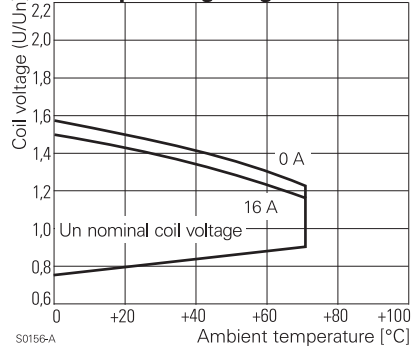

S0156-A

Dimensions

Dimensions in mm

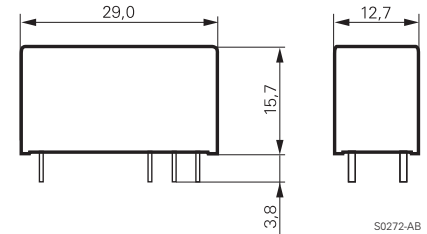

S0272-AB

PCB layout / terminal assignent

View on solder pins
Dimensions in mm

12 A, pinning 3.5 mm

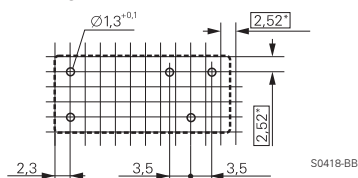

S0418-BB

12 A, pinning 5 mm

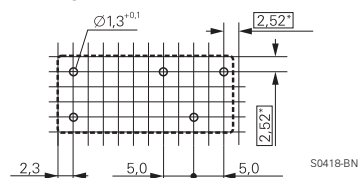

S0418-BN

16 A, pinning 5 mm

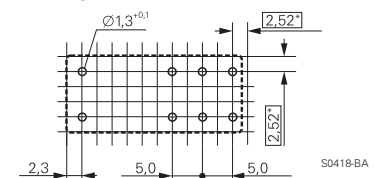

S0418-BA

1 C/O contact

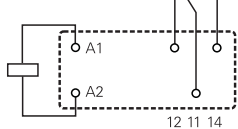

S0163-BG

1 C/O contact

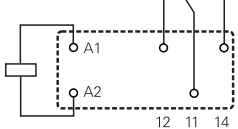

S0163-BC

1 C/O contact

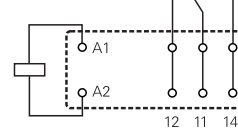

S0163-BE

1 N/O contact

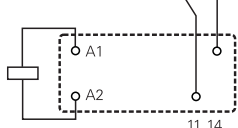

S0163-BH

1 N/O contact

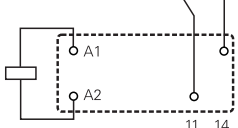

S0163-BD

1 N/O contact

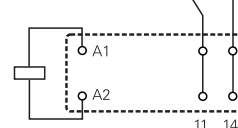

S0163-BF

*) With the recommended PCB hole sizes a grid pattern from 2.5 mm to 2.54 mm can be used.

Power PCB Relay RT1

1 pole 12 / 16 A, DC- or AC-coil

Product key

| | | | | | | | |
|----------|----------|--|--|--|--|--|--|
| R | T | | | | | | |
|----------|----------|--|--|--|--|--|--|

Type

Version

- | | | | |
|----------|---|----------|----------------------------------|
| 1 | 12 A, pinning 3.5 mm, flux proof | B | 12 A, pinning 3.5 mm, wash tight |
| 2 | 12 A, pinning 5 mm, flux proof *) | | |
| 3 | 16 A, pinning 5 mm, flux proof | D | 16 A, pinning 5 mm, wash tight |

Contacts

- | | | | |
|----------|---------------|----------|---------------|
| 1 | 1 C/O contact | 3 | 1 N/O contact |
|----------|---------------|----------|---------------|

Contact material

- | | | | |
|----------|------------|----------|---|
| 4 | AgNi 90/10 | 5 | AgNi 90/10 gold plated (for type RT31.) |
|----------|------------|----------|---|

Coil

Coil code: please refer to coil versions table

Preferred types in bold print

*) Washable version on request

| Product key | Version | Contacts | Cont. material | Coil | Coil | Part number |
|-------------|-------------------|---------------|----------------|---------|---------|-------------|
| RT114005 | 12 A | 1 C/O contact | AgNi 90/10 | DC-coil | 5 Vdc | 0-1393239-7 |
| RT114006 | pinning 3.5 mm | | | | 6 Vdc | 0-1393239-8 |
| RT114012 | flux proof | | | | 12 Vdc | 0-1419108-1 |
| RT114024 | | | | | 24 Vdc | 1-1393239-3 |
| RT114048 | | | | | 48 Vdc | 1-1393239-4 |
| RT114110 | | | | | 110 Vdc | 1-1393239-6 |
| RT114524 | | | | AC-coil | 24 Vac | 1-1393239-7 |
| RT114615 | | | | | 115 Vac | 1-1393239-8 |
| RT114730 | | | | | 230 Vac | 1-1393239-9 |
| RT134012 | | 1 N/O contact | | DC-coil | 12 Vdc | 2-1393239-6 |
| RT134024 | | | | | 24 Vdc | 3-1393239-0 |
| RT214012 | 12 A, pinning 5mm | 1 C/O contact | | | 12 Vdc | 5-1393239-4 |
| RT214024 | flux proof | | | | 24 Vdc | 5-1393239-5 |
| RT314005 | 16 A | | | | 5 Vdc | 9-1393239-1 |
| RT314006 | pinning 5 mm | | | | 6 Vdc | 9-1393239-3 |
| RT314012 | flux proof | | | | 12 Vdc | 9-1393239-5 |
| RT314024 | | | | | 24 Vdc | 9-1393239-8 |
| RT314048 | | | | | 48 Vdc | 0-1393240-1 |
| RT314060 | | | | | 60 Vdc | 0-1393240-2 |
| RT314110 | | | | | 110 Vdc | 0-1393240-3 |
| RT314524 | | | | AC-coil | 24 Vac | 0-1393240-4 |
| RT314615 | | | | | 115 Vac | 0-1393240-6 |
| RT314730 | | | | | 230 Vac | 0-1393240-7 |
| RT315012 | | | AgNi 90/10 | DC-coil | 12 Vdc | 1-1393240-1 |
| RT315024 | | | gold plated | | 24 Vdc | 1-1393240-4 |
| RT315730 | | | | AC-coil | 230 Vac | 1-1419108-1 |
| RT334012 | | 1 N/O contact | AgNi 90/10 | DC-coil | 12 Vdc | 4-1393240-5 |
| RT334024 | | | | | 24 Vdc | 4-1393240-8 |
| RT334048 | | | | | 48 Vdc | 5-1393240-0 |
| RTB14005 | 12 A | 1 C/O contact | | | 5 Vdc | 1-1393238-2 |
| RTB14012 | pinning 3.5 mm | | | | 12 Vdc | 1-1393238-5 |
| RTB14024 | wash tight | | | | 24 Vdc | 1-1393238-9 |
| RTB14048 | | | | | 48 Vdc | 2-1393238-1 |
| RTD14005 | 16 A | | | | 5 Vdc | 5-1393238-9 |
| RTD14006 | pinning 5 mm | | | | 6 Vdc | 6-1393238-0 |
| RTD14012 | wash tight | | | | 12 Vdc | 6-1393238-2 |
| RTD14015 | | | | | 15 Vdc | 6-1393238-4 |
| RTD14024 | | | | | 24 Vdc | 6-1393238-8 |
| RTD14048 | | | | | 48 Vdc | 6-1393238-9 |
| RTD34005 | | 1 N/O contact | | | 5 Vdc | 8-1393238-3 |
| RTD34012 | | | | | 12 Vdc | 3-1419108-5 |
| RTD34024 | | | | | 24 Vdc | 3-1419108-8 |

Power PCB Relay RT1 bistable

1 pole 16 A, polarized bistable version



Features

- 1 C/O contact
- Bistable with 1 or 2 coils
- 5 kV / 10 mm coil-contact
- Height 15.7 mm
- Cadmium-free contacts
- Protection class II (VDE 0700)

Applications

Battery powered equipment or applications with "memory function"

F0176-B



Technical data of approved types on request

Contact data

| | |
|---|-------------------|
| Configuration | 1 C/O contact |
| Type of contact | single contact |
| Rated current | 16 A |
| Rated voltage / max. breaking voltage | 250 Vac / 440 Vac |
| Rated breaking capacity | 4000 VA |
| Make current (max. 4 s at duty cycle 10%) | 30 A |
| Contact material | AgNi 90/10 |

Coil data

| | 1 coil | 2 coils |
|---|--------------------------|-----------------|
| Nominal voltage | 5...24 Vdc | |
| Nominal coil power | typ. 400 mW | typ. 600 mW |
| Minimum energization time | 30 ms | |
| Information on reduced pulse duration with higher energization voltages on demand | | |
| Max. energization for version with 2 coils | 1 min at <10% duty cycle | |
| Reset voltage max. | 120 % U_{nom} | 150 % U_{nom} |

Coil versions, bistable

| Coil code | Nominal voltage Vdc | Pull-in voltage Vdc | Reset voltage Vdc | Coil resistance Ω | Coil current mA |
|--------------------------|---------------------|---------------------|-------------------|-----------------------------------|-----------------|
| bistable, 1 coil | | | | | |
| A05 | 5 | 3.5 | 3.5 | $62 \pm 10\%$ | 80.0 |
| A06 | 6 | 4.2 | 4.2 | $90 \pm 10\%$ | 66.7 |
| A12 | 12 | 8.4 | 8.4 | $360 \pm 10\%$ | 33.3 |
| A24 | 24 | 16.8 | 16.8 | $1440 \pm 10\%$ | 16.7 |
| bistable, 2 coils | | | | | |
| F05 | 5 | 3.5 | 3.5 | $42 \pm 10\%$ | 120.0 |
| F06 | 6 | 4.2 | 4.2 | $55 \pm 10\%$ | 110.0 |
| F12 | 12 | 8.4 | 8.4 | $240 \pm 10\%$ | 50.0 |
| F24 | 24 | 16.8 | 16.8 | $886 \pm 10\%$ | 27.0 |

All figures are given for coil without preenergization, at ambient temperature +20°C

Other coil voltages on request

Coils - operation

| Version | 1 coil | | 2 coils | | |
|----------------|--------|----|---------|----|----|
| Coil terminals | A1 | A2 | A1 | A3 | A2 |
| Pull-in | + | - | | + | - |
| Reset | - | + | - | + | |

Contact position not defined at delivery

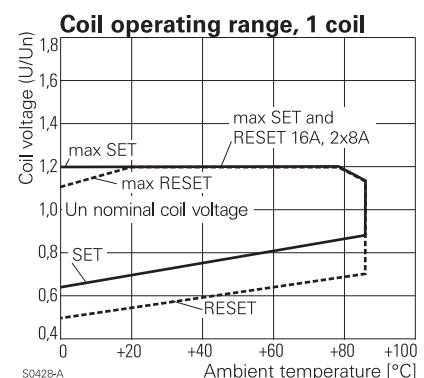
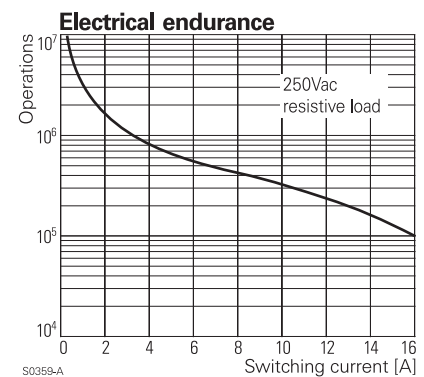
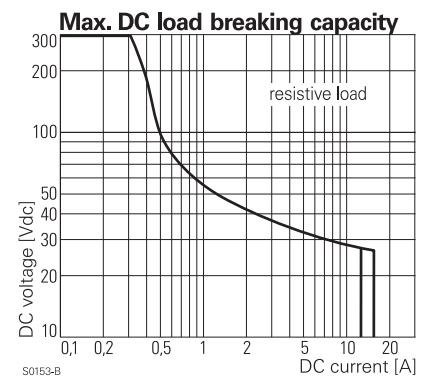

Power PCB Relay RT1 bistable

1 pole 16 A, polarized bistable version

| Insulation | | |
|-----------------------------------|---|-----------------------|
| Dielectric strength | coil-contacts | 5000 V _{rms} |
| | open contact circuit | 1000 V _{rms} |
| Clearance / creepage | | 10 / 10 mm |
| Insulation to IEC 60664 | | |
| | Voltage rating | 250 V |
| | Pollution degree | 3 |
| | Overvoltage category | III |
| Insulation to VDE 0110b (2/79) | | |
| | Insulation category / reference voltage | C / 250 |
| Tracking resistance of relay base | | CTI 250 |

| Other data | | |
|--|-------------------------|---|
| Flammability class according to UL 94 | | V-0 |
| Coil insulation system according to UL 1446 | | Class F |
| Ambient temperature | | -40...+85 °C |
| Mechanical life | | 5x10 ⁶ operations |
| Max. switching rate at rated- / minimum load | | 6 min ⁻¹ / 600 min ⁻¹ |
| Operate- / release time | | typ. 5 / 4 ms |
| Bounce time N/O contact/N/C contact | | typ. 1 / 3 ms |
| Vibration resistance / shock resistance | | |
| | opening N/C contact | 3 / 5 g |
| | closing the N/O contact | 6 / 15 g |
| Shock resistance (destruction) | | 100 g |
| Category of protection (IEC 61810) | | RT II - flux proof |
| Relay weight | | 13 g |
| Packaging unit | 1 coil | 20 / 500 pcs. |
| | 2 coils | 25 / 100 pcs. |
| Accessories | see accessories RT | |

Dimensions

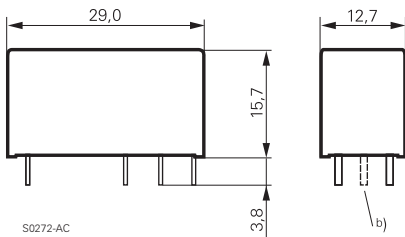

- a) Indicated contact position during or after coil energization with reset voltage.
 b) for 2 coil version only

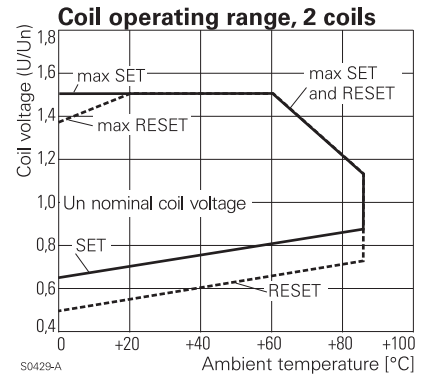

PCB layout / terminal assignment

View on solder pins
 Dimensions in mm

16 A, pinning 5 mm

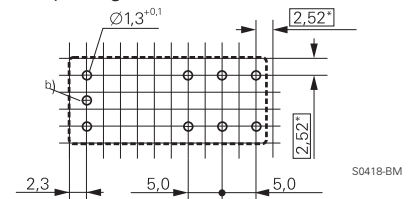

*) With the recommended PCB hole sizes a grid pattern from 2.5 mm to 2.54 mm can be used.

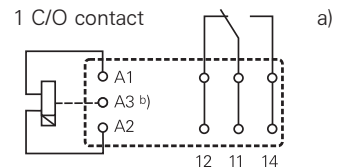

Product key

Type

Version

3 16 A, pinning 5 mm, flux proof

Contacts

1 1 C/O contact

Contact material

4 AgNi 90/10

Coil

Coil code: please refer to coil versions table, preferred types in bold print



| Product key | Version | Contacts | Cont. material | Coil | Coil | Part number |
|-------------|--------------|---------------|----------------|----------|--------|-------------|
| RT314A12 | 16 A | 1 C/O contact | AgNi 90/10 | bistable | 12 Vdc | 8-1393239-0 |
| RT314A24 | pinning 5 mm | | | 1 coil | 24 Vdc | 8-1393239-1 |
| RT314F12 | flux proof | | | bistable | 12 Vdc | 8-1393239-7 |
| RT314F24 | | | | 2 coils | 24 Vdc | 8-1393239-8 |

Power PCB Relay RT1 sensitive

1 pole 10 A, highly sensitive version



F0145-B

Features

- 1 C/O or 1 N/O contact
- Sensitive coil 250 mW
- 5 kV / 10 mm coil-contact
- Protection class II (VDE 0700)
- Ambient temperature 85°C at rated load
- Height 15.7 mm
- Sockets with PCB-type or screw-type terminals

Applications

Domestic appliances, heating control



Technical data of approved types on request

Contact data

| | |
|---|--------------------------------|
| Configuration | 1 C/O contact or 1 N/O contact |
| Type of contact | single contact |
| Rated current | 10 A |
| Rated voltage / max.breaking voltage AC | 250 Vac / 440 Vac |
| Maximum breaking capacity AC | 2500 VA |
| Make current (max. 4 s at duty cycle 10%) | 15 A |
| Contact material | AgNi 90/10 |

Contact ratings

| Type | Load | Operations |
|-------|---|----------------------|
| RT174 | 8 A, 250 Vac | 4.3x10 ⁵ |
| RT174 | 370 W, 230 Vac, compressor, N/O contact | >3.3x10 ⁵ |
| RT174 | 550 W, 250 Vac, incandescent lamps, N/O contact | 1.9x10 ⁵ |
| RT174 | 0.8A _{peak} / 0.08 A, 230 Vac, cosφ=0.23, contactor 190 / 90 VA, N/O contact | >8.8x10 ⁶ |

Coil data

| | |
|--------------------|------------|
| Nominal voltage | 5...60 Vdc |
| Nominal coil power | 250 mW |
| Operate category | 2 / b |

Coil versions, sensitive DC-coil

| Coil code | Nominal voltage Vdc | Pull-in voltage Vdc | Release voltage Vdc | Maximum voltage Vdc | Coil resistance Ω | Coil current mA |
|------------|---------------------|---------------------|---------------------|---------------------|-------------------|-----------------|
| 005 | 5 | 3.7 | 0.5 | 15.0 | 100±10% | 50.0 |
| 006 | 6 | 4.5 | 0.6 | 18.0 | 144±10% | 41.7 |
| 012 | 12 | 9.0 | 1.2 | 36.0 | 576±10% | 20.8 |
| 024 | 24 | 18.0 | 2.4 | 72.0 | 2304±10% | 10.4 |
| 048 | 48 | 36.0 | 4.8 | 144.0 | 9216±10% | 5.4 |
| 060 | 60 | 45.0 | 6.0 | 180.0 | 12857±12% | 4.7 |

All figures are given for coil without preenergization, at ambient temperature +20°C

Other coil voltages on request

Max. DC load breaking capacity

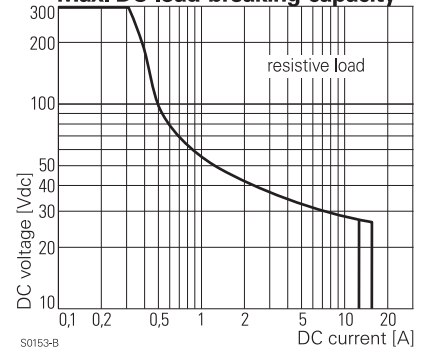

S0153-B

Electrical endurance

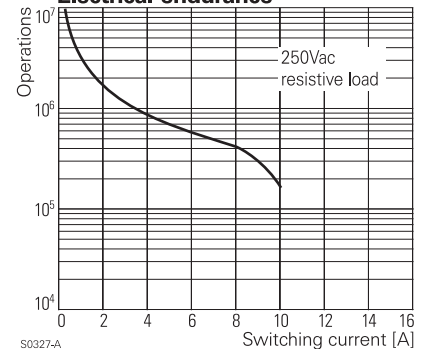

S0327-A

Coil operating range DC

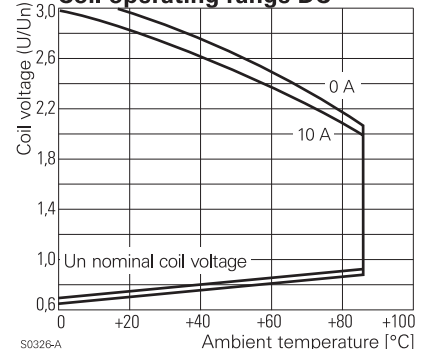

S0326-A

Power PCB Relay RT1 sensitive

1 pole 10 A, highly sensitive version

| Insulation | | |
|--------------------------------|---|-----------------------|
| Dielectric strength | coil-contacts | 5000 V _{rms} |
| | open contact circuit | 1000 V _{rms} |
| Clearance / creepage | | 10 / 10 mm |
| Insulation to IEC 60664 | | |
| | Voltage rating | 250 V |
| | Pollution degree | 3 |
| | Overvoltage category | III |
| Insulation to VDE 0110b (2/79) | | |
| | Insulation category / reference voltage | C / 250 |

| Other data | |
|--|---|
| Flammability class according to UL 94 | V-0 |
| Coil insulation system according to UL 1446 | Class F |
| Ambient temperature | -40...+85 °C |
| Mechanical life | 30x10 ⁶ operations |
| Max. switching rate at rated- / minimum load | 50 min ⁻¹ / 1200 min ⁻¹ |
| Operate- / release time | typ. 7 / 3 ms |
| Bounce time N/O contact/N/C contact | typ. 2 / 4 ms |
| Vibration resistance | 5 g, 30...150 Hz |
| Shock resistance (destruction) | 100 g |
| Category of protection (IEC 61810) | RT II - flux proof, RT III - wash tight |
| Relay weight | 14 g |
| Packaging unit | 20 / 500 pcs. |
| Accessories | see accessories RT |

PCB layout / terminal assignment

View on solder pins
Dimensions in mm

10 A, pinning 3.5 mm

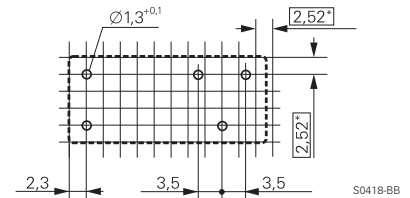

*) With the recommended PCB hole sizes a grid pattern from 2.5 mm to 2.54 mm can be used.

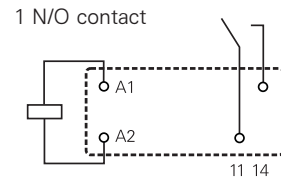
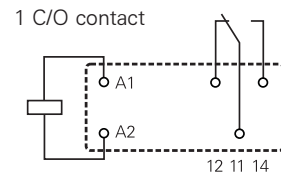

Dimensions

Dimensions in mm

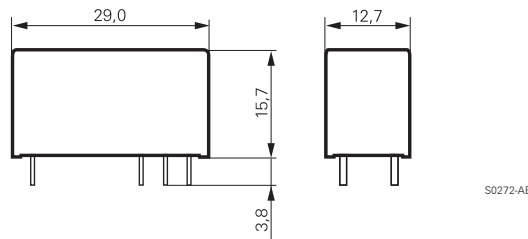

Product key

Type

Version

1 10 A, pinning 3.5 mm, flux proof

B 10 A, pinning 3.5 mm, wash tight

Contacts

7 1 C/O contact

8 1 N/O contact

Contact material

4 AgNi 90/10

Coil

Coil code: please refer to coil versions table

Preferred types in bold print

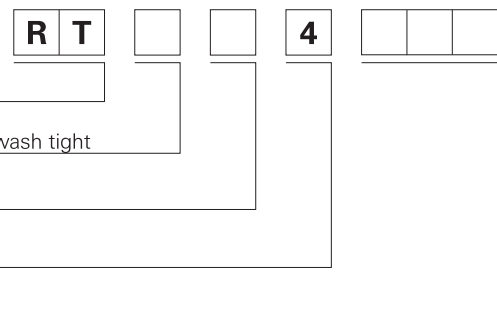

| Product key | Version | Contacts | Contact material | Coil | Part number |
|-------------|----------------|---------------|------------------|--------|-------------|
| RT174005 | 10 A | 1 C/O contact | AgNi 90/10 | 5 Vdc | 3-1393239-6 |
| RT174006 | pinning 3.5 mm | | | 6 Vdc | 3-1393239-7 |
| RT174012 | flux proof | | | 12 Vdc | 3-1393239-8 |
| RT174024 | | | | 24 Vdc | 3-1393239-9 |
| RTB74012 | 10 A, 3.5mm | | | 12 Vdc | 4-1393238-4 |
| RTB74024 | wash tight | | | 24 Vdc | 4-1393238-6 |

Power PCB Relay RT1 Inrush

1 pole 16 A, for inrush peak currents up to 80 A



Features

- 1 N/O contact
- Sensitive coil 400 mW
- 5 kV / 10 mm coil-contact
- Protection class II (VDE 0700)
- Ambient temperature 85°C
- Height 15.7 mm
- Sockets with PCB-type or screw-type terminals

Applications

Domestic appliances, heating control, lighting control

F0177-B



Technical data of approved types on request

Contact data

| | |
|---|--------------------------------|
| Configuration | 1 N/O contact |
| Type of contact | single contact |
| Rated current | 16 A |
| Rated voltage / max.breaking voltage AC | 250 Vac / 440 Vac |
| Maximum breaking capacity AC | 4000 VA |
| Make current (max. 4 s at duty cycle 10%) | 30 A |
| peak inrush current (20 ms) | 80 A |
| Contact material | AgNi 90/10, AgSnO ₂ |

Contact ratings

| Type | Load | Operations |
|-------|---|--------------------------|
| RT33K | 1000 W, 250 Vac, incandescent lamps | typ. 9x10 ⁴ |
| RT33L | 1000 W, 250 Vac, incandescent lamps | typ. 8x10 ⁴ |
| RT33L | compressor, 230 Vac, I _{in} ≤21A _{peak} , I _{off} =3.5 A, cosφ=0.5 | typ. 2.3x10 ⁵ |

Coil data

| | |
|--------------------|-------------|
| Nominal voltage | 5...110 Vdc |
| Nominal coil power | 400 mW |
| Operate category | 2 / b |

Coil versions, DC-coil

| Coil code | Nominal voltage Vdc | Pull-in voltage Vdc | Release voltage Vdc | Maximum voltage Vdc | Coil resistance Ω | Coil current mA |
|------------|---------------------|---------------------|---------------------|---------------------|-------------------|-----------------|
| 012 | 12 | 8.4 | 1.2 | 30.6 | 360±10% | 33.3 |
| 024 | 24 | 16.8 | 2.4 | 61.2 | 1440±10% | 16.7 |
| 048 | 48 | 33.6 | 4.8 | 122.4 | 5520±10% | 8.7 |
| 060 | 60 | 42.0 | 6.0 | 153.0 | 7340±12% | 8.1 |

All figures are given for coil without preenergization, at ambient temperature +20°C
Other coil voltages on request

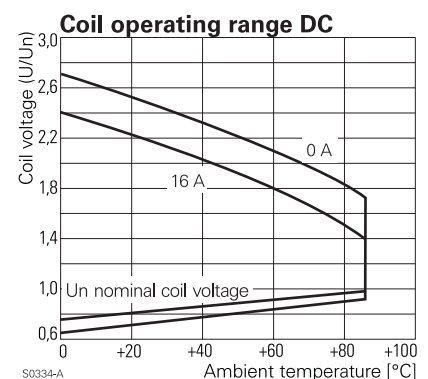
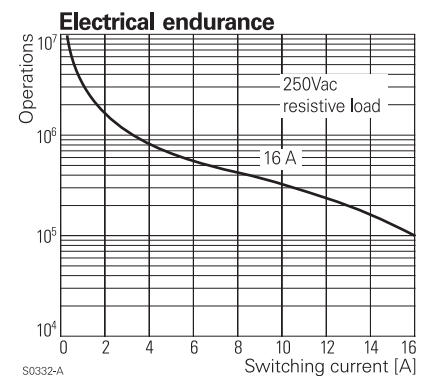
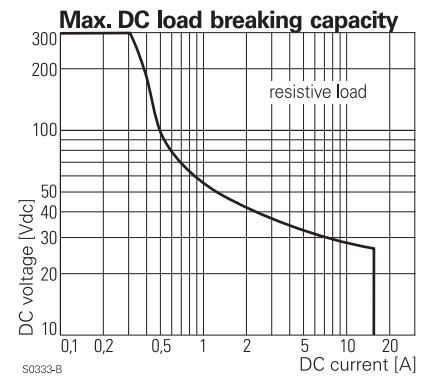

Power PCB Relay RT1 Inrush

1 pole 16 A, for inrush peak currents up to 80 A

| Insulation | | |
|---|----------------------|-----------------------|
| Dielectric strength | coil-contacts | 5000 V _{rms} |
| | open contact circuit | 1000 V _{rms} |
| Clearance / creepage | | 10 / 10 mm |
| Insulation to IEC 60664 | | |
| Voltage rating | | 250 V |
| Pollution degree | | 3 |
| Overvoltage category | | III |
| Insulation to VDE 0110b (2/79) | | |
| Insulation category / reference voltage | | C / 250 |

| Other data | |
|--|--|
| Flammability class according to UL 94 | V-0 |
| Coil insulation system according to UL 1446 | Class F |
| Ambient temperature | -40...+85 °C |
| Mechanical life | 30x10 ⁶ operations |
| Max. switching rate at rated- / minimum load | 6 min ⁻¹ / 1200 min ⁻¹ |
| Operate- / release time | typ. 8 / 3 ms |
| Bounce time | typ. 2 ms |
| Vibration resistance | 20 g, 30...500 Hz |
| Shock resistance (destruction) | 100 g |
| Category of protection (IEC 61810) | RT II - flux proof |
| Relay weight | 14 g |
| Packaging unit | 20 / 500 pcs. |
| Accessories | see accessories RT |

PCB layout / terminal assignment

View on solder pins
Dimensions in mm

16 A, pinning 5 mm

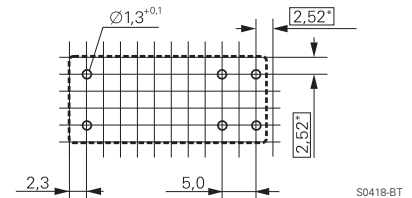

*) With the recommended PCB hole sizes a grid pattern from 2.5 mm to 2.54 mm can be used.

1 N/O contact

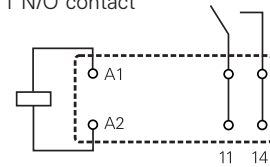

Dimensions

Dimensions in mm

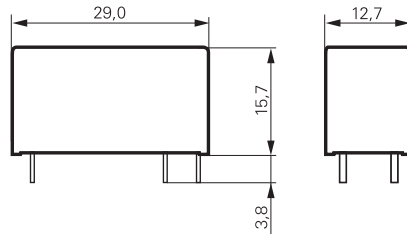

S0272-AE

Product key

Type

Version

3 16 A, pinning 5 mm, flux proof

Contacts

3 1 N/O contact

Contact material

K AgNi 90/10

L AgSnO₂

Coil

Coil code: please refer to coil versions table, preferred types in bold print

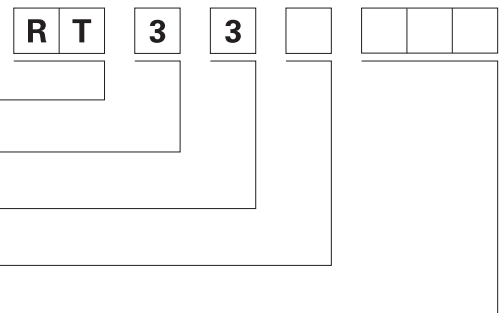

| Product key | Version | Contacts | Contact material | Coil | Part number |
|-------------|--------------|---------------|------------------|--------|-------------|
| RT33K012 | 16 A | 1 N/O contact | AgNi 90/10 | 12 Vdc | 2-1393240-3 |
| RT33K024 | pinning 5 mm | | | 24 Vdc | 2-1393240-4 |
| RT33K048 | flux proof | | | 48 Vdc | 2-1393240-5 |
| RT33L012 | | | AgSnO | 12 Vdc | 3-1393240-3 |
| RT33L024 | | | | 24 Vdc | 3-1393240-5 |
| RT33L048 | | | | 48 Vdc | 3-1393240-6 |

Power PCB Relay 429 03 Inrush

1 pole 10 A, for inrush peak currents up to 80 A



F0247-A

Features

- 1 N/O contact (W prerun contact + AgSnO₂)
- 80 A / 20 ms inrush peak current
- 4 kV / 8 mm coil-contact, protection class II (VDE 0700)
- Sensitive coil 480mW
- Height 15,0 mm

Applications

Lighting systems, movement sensors, filament lamp loads, halogen bulbs and motors



Technical data of approved types on request

Contact data

| | |
|---|---|
| Configuration | 1 N/O contact |
| Type of contact | single contact |
| Rated current | 10 A |
| Rated voltage / max.breaking voltage AC | 250 Vac / 400 Vac |
| Make current (max. 4 s at duty cycle 10%) | 16 A |
| peak inrush current (20 ms) | 80 A |
| Contact material | W (prerun contact) + AgSnO ₂ |

Contact ratings

| Type | Load | Operations | Standard |
|--------|-----------------------------------|-------------------|----------|
| 429 03 | 10 A, 250 Vac, resistive | 5x10 ⁴ | Standard |
| 429 03 | 2500 W, incandescent lamps | 3x10 ⁴ | |
| 429 03 | 1300 W, fluorescent lamps, 140 µF | 3x10 ⁴ | |
| 429 03 | 1000 W, Dulux lamps, 140 µF | 3x10 ⁴ | |

Coil data

| | |
|--------------------|------------|
| Nominal voltage | 6...60 Vdc |
| Nominal coil power | 480 mW |
| Operate category | 1 / b |

Coil versions

| Coil code | Nominal voltage Vdc | Pull-in voltage Vdc | Release voltage Vdc | Maximum voltage Vdc | Coil resistance Ω | Coil current mA |
|-----------|---------------------|---------------------|---------------------|---------------------|-------------------|-----------------|
| 16 | 6 | 4.2 | 0.4 | 12.0 | 80±10% | 75.0 |
| 13 | 12 | 8.4 | 0.9 | 24.0 | 300±10% | 40.0 |
| 08 | 24 | 16.8 | 1.8 | 48.0 | 1200±10% | 20.0 |
| 05 | 48 | 33.6 | 3.6 | 96.0 | 4825±10% | 10.0 |
| 03 | 60 | 42.0 | 4.5 | 120.0 | 7500±10% | 8.0 |

All figures are given for coil without preenergization, at ambient temperature +20°C

Other coil voltages on request

Coil operating range DC

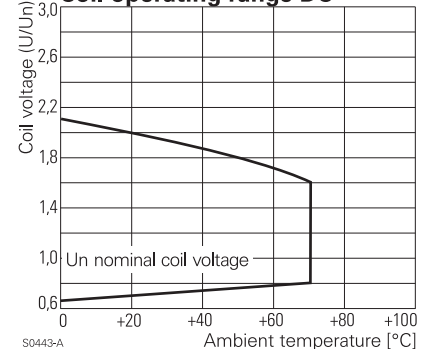

S0443-A

Power PCB Relay 429 03 Inrush

1 pole 10 A, for inrush peak currents up to 80 A

Insulation

| | | |
|-----------------------------------|---|-----------------------|
| Dielectric strength | coil-contacts | 4000 V _{rms} |
| | open contact circuit | 1000 V _{rms} |
| Clearance / creepage | | 8 / 8 mm |
| Insulation to IEC 60664 | | |
| | Voltage rating | 250 V |
| | Pollution degree | 3 |
| | Overvoltage category | III |
| Insulation to VDE 0110b (2/79) | | |
| | Insulation category / reference voltage | C / 250 |
| Tracking resistance of relay base | | PTI 250 |

Dimensions

Dimensions in mm

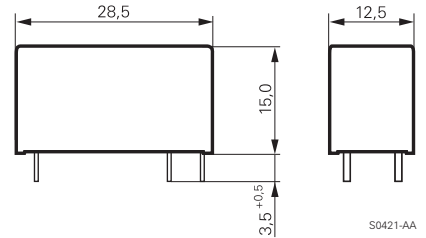

S0421-AA

Other data

| | |
|--|--|
| Flammability class according to UL 94 | V-0 |
| Ambient temperature | -40...+70 °C |
| Mechanical life | >5x10 ⁶ operations |
| Max. switching rate at rated- / minimum load | 10 min ⁻¹ / 300 min ⁻¹ |
| Operate- / release time | typ. 6 / 4 ms |
| Bounce time N/O contact | typ. 3 ms |
| Shock resistance (destruction) | 100 g |
| Category of protection (IEC 61810) | RT II - flux proof |
| Relay weight | 10 g |
| Packaging unit | 50 / 400 pcs. |

PCB layout / terminal assignment

View on solder pins

Dimensions in mm

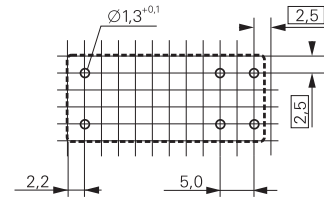

S0420-AA

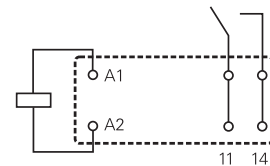

S0420-AA

Product key



Type

Coil

Coil code: Please refer to coil versions table, preferred types in bold print

Contacts

12 W (prerun contact) + AgSnO₂

Version

00 Standard

Other types on request

| Product key | Version | Contacts | Contact material | Coil | Part number |
|-----------------|------------|---------------|------------------|-------|-------------|
| 0429 03 1312 00 | 10A | 1 N/O contact | W prerun | 12Vdc | 7-1415429-4 |
| 0429 03 0812 00 | flux proof | | AgSnO | 24Vdc | 7-1415429-0 |
| 0429 03 0512 00 | | | | 48Vdc | 6-1415429-7 |

Power PCB Relay RTH 105°C sensitive

1 pole 10 A, high-temperature version



Features

- 1 N/O contact
- Sensitive coil 250 mW
- 5 kV / 10 mm coil-contact
- Protection class II (VDE 0700)
- Ambient temperature 105°C at rated load
- Height 15.7 mm

Applications

Domestic appliances, heating control

F0178-C



Technical data of approved types on request

Contact data

| | |
|---|-------------------|
| Configuration | 1 N/O contact |
| Type of contact | single contact |
| Rated current | 10 A |
| Rated voltage / max.breaking voltage AC | 250 Vac / 440 Vac |
| Maximum breaking capacity AC | 2500 VA |
| Make current (max. 4 s at duty cycle 10%) | 15 A |
| Contact material | AgNi 90/10 |

Contact ratings

| Type | Load | Operations |
|-------|--|---------------------|
| RTH84 | 12 A, 250 Vac, 105 °C, dry switching | >5x10 ⁵ |
| RTH84 | 10 A, 250 Vac, cyclical heat 105/40 °C | 2x10 ⁵ |
| RTH84 | 10 A, 250 Vac, 105 °C | 1.5x10 ⁵ |

Coil data

| | |
|--------------------|------------|
| Nominal voltage | 5...60 Vdc |
| Nominal coil power | 250 mW |
| Operate category | 2 / b |

Coil versions, sensitive DC-coil

| Coil code | Nominal voltage Vdc | Pull-in voltage Vdc | Release voltage Vdc | Maximum voltage Vdc | Coil resistance Ω | Coil current mA |
|-----------|---------------------|---------------------|---------------------|---------------------|-------------------|-----------------|
| 012 | 12 | 9.0 | 1.2 | 36.0 | 576±10% | 20.8 |
| 024 | 24 | 18.0 | 2.4 | 72.0 | 2304±10% | 10.4 |

All figures are given for coil without preenergization, at ambient temperature +20°C
Other coil voltages on request

Max. DC load breaking capacity

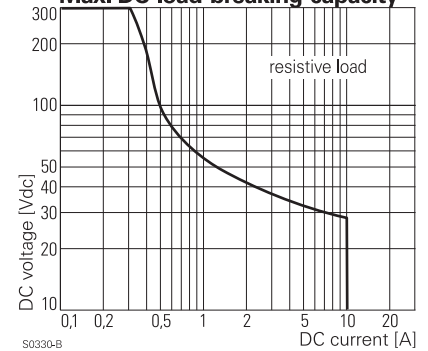

Electrical endurance

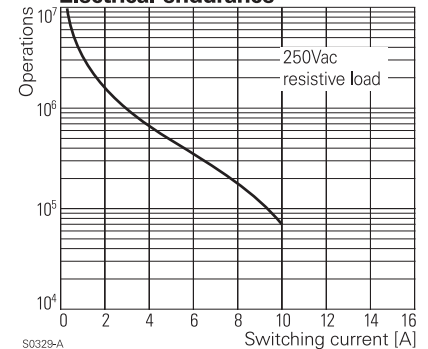

Coil operating range DC

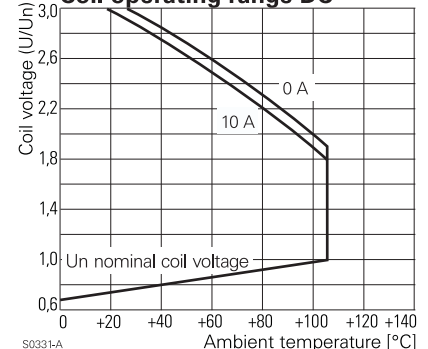

Power PCB Relay RTH 105°C sensitive

1 pole 10 A, high-temperature version

Insulation

| | | |
|---|----------------------|-----------------------|
| Dielectric strength | coil-contacts | 5000 V _{rms} |
| | open contact circuit | 1000 V _{rms} |
| Clearance / creepage | | 10 / 10 mm |
| Insulation to IEC 60664 | | |
| Voltage rating | | 250 V |
| Pollution degree | | 3 |
| Overvoltage category | | III |
| Insulation to VDE 0110b (2/79) | | |
| Insulation category / reference voltage | | C / 250 |

Other data

| | |
|--|--|
| Flammability class according to UL 94 | V-0 |
| Coil insulation system according to UL 1446 | Class F |
| Ambient temperature | -40...+105 °C |
| Mechanical life | 10x10 ⁶ operations |
| Max. switching rate at rated- / minimum load | 6 min ⁻¹ / 1200 min ⁻¹ |
| Operate- / release time | typ. 8 / 3 ms |
| Bounce time | typ. 2 ms |
| Vibration resistance | 5 g, 30...150 Hz |
| Shock resistance (destruction) | 100 g |
| Category of protection (IEC 61810) | RT II - flux proof |
| Relay weight | 14 g |
| Packaging unit | 20 / 500 pcs. |

Dimensions

Dimensions in mm

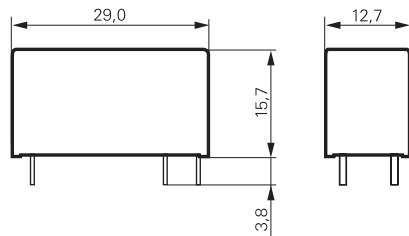

S0272-AE

PCB layout / terminal assignment

View on solder pins
Dimensions in mm

10 A, pinning 5 mm

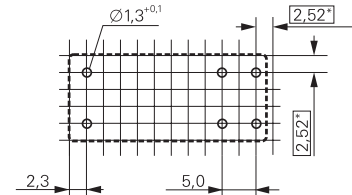

S0418-BT

*) With the recommended PCB hole sizes a grid pattern from 2.5 mm to 2.54 mm can be used.

1 N/O contact

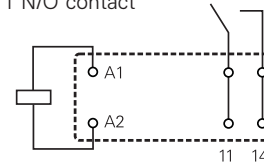

S0163-BF

Product key

Type

Version

H 10 A, pinning 5 mm, 105°C

Contacts

8 1 N/O contact

Contact material

4 AgNi 90/10

Coil

Coil code: please refer to coil versions table



| Product key | Version | Contacts | Contact material | Coil | Part number |
|-------------|-------------------|---------------|------------------|--------|-------------|
| RTH84012 | 10 A, 5 mm | 1 N/O contact | AgNi 90/10 | 12 Vdc | 9-1393238-2 |
| RTH84024 | 105°C, flux proof | | | 24 Vdc | 9-1393238-3 |

Power PCB Relay RTH 105°C 16A

1 pole 16 A, high-temperature version



Features

- 1 C/O or 1 N/O contact
- Sensitive coil 400 mW
- 5 kV / 10 mm coil-contact
- Protection class II (VDE 0700)
- Ambient temperature 105°C at rated load
- Height 15.7 mm

Applications

Oven control, cooking plate control

F0220-C



Technical data of approved types on request

Contact data

| | |
|---|--------------------------------|
| Configuration | 1 C/O contact or 1 N/O contact |
| Type of contact | single contact |
| Rated current | 16 A ¹⁾ |
| Rated voltage / max.breaking voltage AC | 250 Vac / 440 Vac |
| Maximum breaking capacity AC | 4000 VA |
| Make current (max. 4 s at duty cycle 10%) | 30 A |
| Contact material | AgNi 90/10 |

Contact ratings

| Type | Load | Operations | standard |
|-------|------------------------------------|--------------------------|-------------|
| RTH34 | 10 A, 250 Vac, 105 °C | 1.5x10 ⁵ | EN 61810/T1 |
| RTH34 | 16 A, 250 Vac, 105 °C | 2x10 ⁴ | |
| RTHH4 | 10 A, 250 Vac, 105 °C | typ. 3x10 ⁵ | |
| RTHH4 | 16 A ON / 8 A OFF, 250 Vac, 105 °C | typ. 2.5x10 ⁵ | |

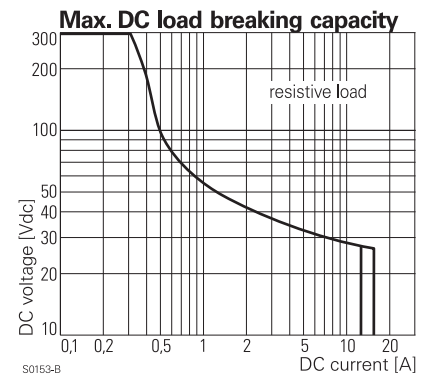

Coil data

| | |
|--------------------|-----------------------------|
| Nominal voltage | 5...60 Vdc |
| Nominal coil power | 400 mW ¹⁾ |
| Operate category | 90 - 110 % U _{nom} |

Coil versions, DC-coil

| Coil code | Nominal voltage Vdc | Pull-in voltage Vdc | Release voltage Vdc | Maximum voltage Vdc | Coil resistance Ω | Coil current mA |
|-----------|---------------------|---------------------|---------------------|---------------------|-------------------|-----------------|
| 009 | 9 | 6.3 | 0.9 | 22.9 | 203±10% | 44.3 |
| 012 | 12 | 8.4 | 1.2 | 30.6 | 360±10% | 33.3 |
| 024 | 24 | 16.8 | 2.4 | 61.2 | 1440±10% | 16.7 |

All figures are given for coil without preenergization, at ambient temperature +20°C
Other coil voltages on request

¹⁾ Continuous thermal load > 10 A at 105°C requires reduction of coil power to 64% of nominal power after 100 ms

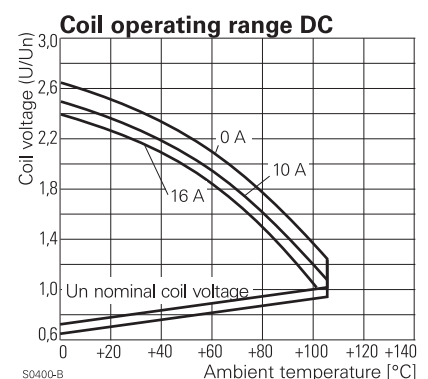

Power PCB Relay RTH 105°C 16A

1 pole 16 A, high-temperature version

Insulation

| | | |
|---|----------------------|-----------------------|
| Dielectric strength | coil-contacts | 5000 V _{rms} |
| | open contact circuit | 1000 V _{rms} |
| Clearance / creepage | | 10 / 10 mm |
| Insulation to IEC 60664 | | |
| Voltage rating | | 250 V |
| Pollution degree | | 3 |
| Overvoltage category | | III |
| Insulation to VDE 0110b (2/79) | | |
| Insulation category / reference voltage | | C / 250 |

Other data

| | |
|--|--|
| Flammability class according to UL 94 | V-0 |
| Coil insulation system according to UL 1446 | Class F |
| Ambient temperature | -40...+105 °C |
| Mechanical life | 10x10 ⁶ operations |
| Max. switching rate at rated- / minimum load | 6 min ⁻¹ / 1200 min ⁻¹ |
| Operate- / release time | typ. 7 / 3 ms |
| Bounce time N/O contact / N/C contact | typ. 1 / 3 ms |
| Vibration resistance N/O / N/C contact | 20 / 5 g, 30...150 Hz |
| Shock resistance (destruction) | 100 g |
| Category of protection (IEC 61810) | RT II - flux proof |
| Relay weight | 14 g |

PCB layout / terminal assignment

View on solder pins
Dimensions in mm

16 A, pinning 5 mm

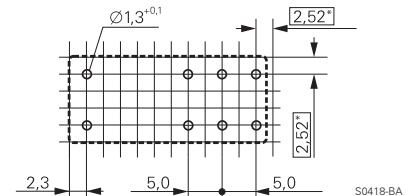

*) With the recommended PCB hole sizes a grid pattern from 2.5 mm to 2.54 mm can be used.

1 C/O contact

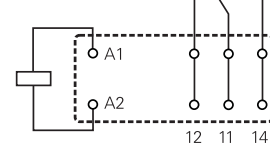

1 1 N/O contact

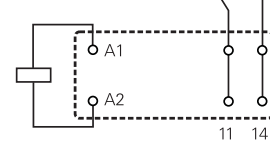

Dimensions

Dimensions in mm

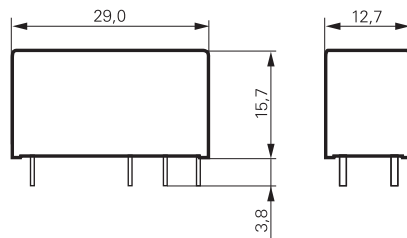

Product key

Type

Version

H 16 A, pinning 5 mm, 105°C

Contacts

1 1 C/O contact

3 1 N/O contact

H 1 N/O contact "High Performance"

Contact material

4 AgNi 90/10

Coil

Coil code: please refer to coil versions table

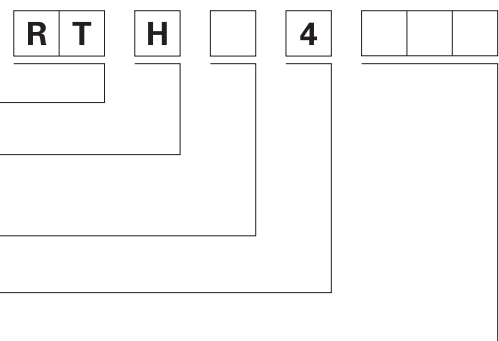

| Product key | Version | Contacts | Contact material | Coil | Part number |
|-------------|-------------|------------------------|------------------|--------|-------------|
| RTH14012 | 16 A | 1 C/O contact | AgNi 90/10 | 12 Vdc | 8-1415006-1 |
| RTH34012 | pinning 5mm | 1 N/O contact | | 12 Vdc | 9-1415006-1 |
| RTHH4009 | flux proof | 1 N/O high performance | | 9 Vdc | 7-1415077-1 |
| RTHH4012 | 105°C | | | 12 Vdc | 8-1415047-1 |

Power PCB Relay RP II/1

1 pole 8 / 12 / 16 A



F0146-B

Features

- 1 C/O or 1 N/O contact
- 4 kV / 8 mm coil-contact
- Pinning 3.5 or 5 mm (8 / 12 A) and 5 mm (16 A)
- PCB-sockets

Applications

Power supplies, domestic appliances, heating control, installation

8 A version:
 12 A version:
 16 A version:
 Technical data of approved types on request

| Contact data | | | |
|---|--------------------------------|---------|---------|
| Configuration | 1 C/O contact or 1 N/O contact | | |
| Type of contact | single contact | | |
| Rated current | 8 A | 12 A | 16 A |
| Rated voltage / max.breaking voltage AC | 250 Vac / 440 Vac | | |
| Maximum breaking capacity AC | 2000 VA | 3000 VA | 4000 VA |
| Make current | 16 A | 20 A | 25 A |
| Contact material | AgNi 0.15 | AgCdO | AgCdO |

| Contact ratings | | | |
|-----------------|---|---------------------|----------|
| Type | Load | Operations | Standard |
| RP410 | 12 A, 250 Vac, $\cos\phi=1$, 1200/h, 40% duty cycle | 1.1×10^5 | AC 1 |
| RP410 | 9.1 A, 220 Vac, $\cos\phi=1$, 360/h, 15% duty cycle | 2×10^5 | AC 1 |
| RP418 | 3.4 A ON, 0.42 A OFF, 220 Vac, $\cos\phi=0.6$ | $> 1.1 \times 10^6$ | |
| RP411 | 8 A, 250 Vac, $\cos\phi=1$, 50% duty cycle | 10^5 | AC 1 |
| RP412 | 8 A, 250 Vac, $\cos\phi=1$, 50% duty cycle | 10^5 | AC 1 |
| RP330 | 18.2 A, 250 Vac, $\cos\phi=1$, 600/h, 15% duty cycle | 1.1×10^5 | AC 1 |
| RP330 | 96 A ON, 16 A OFF, 250 Vac, $\cos\phi=0.6$, 450/h | $> 3 \times 10^4$ | VDE 0630 |

| Coil data | |
|--------------------|-------------|
| Nominal voltage | 5...110 Vdc |
| Nominal coil power | 500 mW |
| Operate category | 2 / b |

| Coil versions, DC-coil | | | | | | |
|------------------------|---------------------|---------------------|---------------------|---------------------|--------------------------|-----------------|
| Coil code | Nominal voltage Vdc | Pull-in voltage Vdc | Release voltage Vdc | Maximum voltage Vdc | Coil resistance Ω | Coil current mA |
| 005 | 5 | 3.5 | 0.5 | 9.0 | $54 \pm 10\%$ | 92.6 |
| 006 | 6 | 4.2 | 0.6 | 10.8 | $68 \pm 10\%$ | 88.2 |
| 012 | 12 | 8.4 | 1.2 | 21.6 | $270 \pm 10\%$ | 44.4 |
| 024 | 24 | 16.8 | 2.4 | 43.2 | $1100 \pm 15\%$ | 21.8 |
| 048 | 48 | 33.6 | 4.8 | 86.4 | $4400 \pm 15\%$ | 10.9 |
| 060 | 60 | 42.0 | 6.0 | 108.0 | $6540 \pm 15\%$ | 9.2 |
| 110 | 110 | 77.0 | 11.0 | 198.0 | $23100 \pm 15\%$ | 4.8 |

All figures are given for coil without preenergization, at ambient temperature +20°C
 Other coil voltages on request

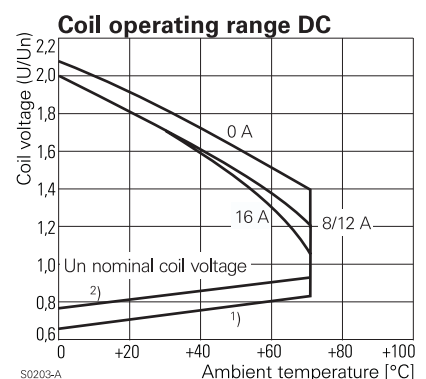
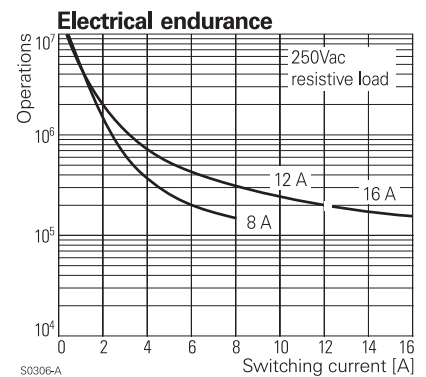
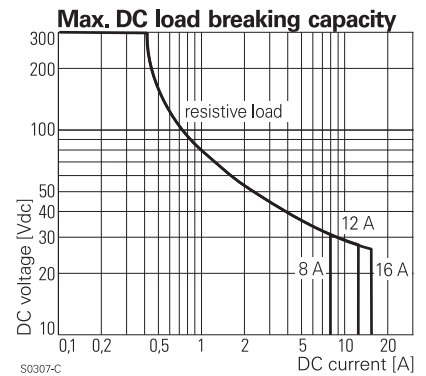

Power PCB Relay RP II/1

1 pole 8 / 12 / 16 A

| Insulation | | |
|---|----------------------|-----------------------|
| Dielectric strength | coil-contacts | 4000 V _{rms} |
| | open contact circuit | 1000 V _{rms} |
| Clearance / creepage | | 8 / 8 mm |
| Insulation to IEC 60664 | | |
| Voltage rating | | 250 V |
| Pollution degree | | 3 |
| Overvoltage category | | III |
| Insulation to VDE 0110b (2/79) | | |
| Insulation category / reference voltage | | C / 250 |

| Other data | |
|--|---|
| Ambient temperature | -40...+70 °C |
| Mechanical life | 30x10 ⁶ operations |
| Max. switching rate at rated- / minimum load | 10 min ⁻¹ / 1200 min ⁻¹ |
| Operate- / release time | typ. 8 / 2 ms |
| Bounce time N/O contact/N/C contact | typ. 2 / 4 ms |
| Vibration resistance N/O contact/N/C contact | >10 / 2 g, 30...300 Hz |
| Shock resistance (destruction) | 100 g |
| Category of protection (IEC 61810) | RT II - flux proof, RT III - wash tight |
| Relay weight | 18 g |
| Packaging unit | 20 / 500 pcs. |
| Accessories | see accessories RT and RT |

Dimensions

Dimensions in mm

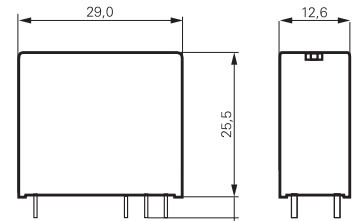

S0273-AA

View on solder pins

Dimensions in mm

PCB layout / terminal assignment

8 / 12 A, pinning 3.5 mm

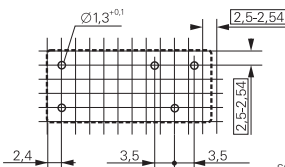

S0163-CQ

8 / 12 A, pinning 5 mm

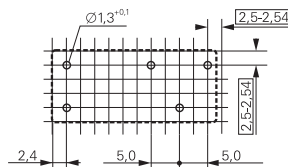

S0163-CP

16 A, pinning 5 mm

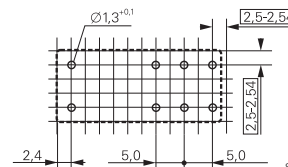

S0163-CO

1 C/O

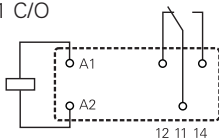

S0163-BG

1 C/O

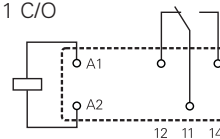

S0163-BC

1 C/O

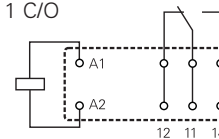

S0163-BE

1 N/O

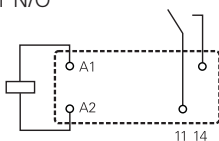

S0163-BH

1 N/O

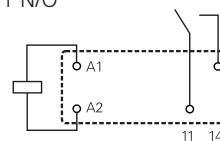

S0163-BD

1 N/O

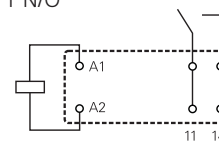

S0163-BF

Product key

Type

Version

3 16 A, flux proof **7 16 A, wash tight**
4 8/12 A, flux proof **8 8/12 A, wash tight**

Contacts

1 1 C/O contact **3 1 N/O contact**

Contact material

0 AgCdO, 16 A or 12 A, pinning 5 mm **2 AgNi 0.15, 8 A, pinning 3.5 mm**
1 AgNi 0.15, 8 A, pinning 5 mm **8 AgCdO, 12 A, pinning 3.5 mm**

Coil

Coil code: please refer to coil versions table

Preferred types in bold print

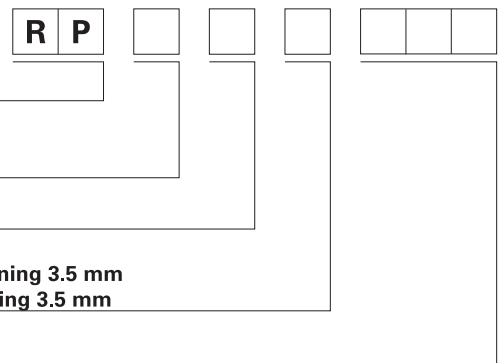

Power PCB Relay RP II/1

1 pole 8 / 12 / 16 A

| Product key | Version | Contacts | Contact material | Coil | Part number |
|-------------|------------|---------------|------------------|--------|-------------|
| RP310005 | 16 A | 1 C/O contact | AgCdO | 5 Vdc | 2-1393230-5 |
| RP310012 | flux proof | | pinning 5mm | 12 Vdc | 2-1393230-9 |
| RP310024 | | | | 24 Vdc | 3-1393230-2 |
| RP310048 | | | | 48 Vdc | 3-1393230-3 |
| RP330005 | | 1 N/O contact | | 5 Vdc | 4-1393230-5 |
| RP330012 | | | | 12 Vdc | 4-1393230-7 |
| RP330024 | | | | 24 Vdc | 4-1393230-9 |
| RP330048 | | | | 48 Vdc | 5-1393230-1 |
| RP410012 | 12 A | 1 C/O contact | AgCdO | 12 Vdc | 8-1393230-1 |
| RP410024 | flux proof | | pinning 5mm | 24 Vdc | 8-1393230-2 |
| RP411012 | 8 A | | AgNi 0.15 | 12 Vdc | 9-1393230-4 |
| RP411024 | flux proof | | pinning 5mm | 24 Vdc | 9-1393230-5 |
| RP412012 | | | AgNi 0.15 | 12 Vdc | 1-1393231-1 |
| RP412024 | | | pinning 3.5mm | 24 Vdc | 1-1393231-2 |
| RP418012 | 12 A | | AgCdO | 12 Vdc | 2-1393231-5 |
| RP418024 | flux proof | | pinning 3.5mm | 24 Vdc | 2-1393231-8 |
| RP438012 | | 1 N/O contact | | 12 Vdc | 5-1393231-0 |
| RP438024 | | | | 24 Vdc | 5-1393231-2 |
| RP710005 | 16 A | 1 C/O contact | AgCdO | 5 Vdc | 7-1393231-0 |
| RP710012 | wash tight | | pinning 5mm | 12 Vdc | 7-1393231-2 |
| RP710024 | | | | 24 Vdc | 7-1393231-5 |
| RP710048 | | | | 48 Vdc | 7-1393231-6 |
| RP730012 | | 1 N/O contact | | 12 Vdc | 8-1393231-2 |
| RP730024 | | | | 24 Vdc | 8-1393231-4 |
| RP812012 | 8 A | 1 C/O contact | AgNi 0.15 | 12 Vdc | 0-1393232-8 |
| RP812024 | wash tight | | pinning 3.5mm | 24 Vdc | 0-1393232-9 |
| RP818012 | 12 A | | AgCdO | 12 Vdc | 1-1393232-7 |
| RP818024 | wash tight | | pinning 3.5mm | 24 Vdc | 1-1393232-9 |
| RP838012 | | 1 N/O contact | | 12 Vdc | 2-1393232-6 |
| RP838024 | | | | 24 Vdc | 2-1393232-8 |

Special Load PCB Relay RP 3 SL

1 pole 16 A, for high inrush currents,
mono- or bistable



Features

- 1 N/O contact
- 120 A / 20 ms inrush peak current
- 4 kV / 8 mm coil-contact

Applications

Lighting control, timers, motor control, building automation



Technical data of approved types on request

F0147-A

Contact data

| | |
|---|--------------------|
| Configuration | 1 N/O contact |
| Type of contact | single contact |
| Rated current | 16 A |
| Rated voltage / max.breaking voltage AC | 250 Vac / 440 Vac |
| Maximum breaking capacity AC | 4000 VA |
| Make current (max. 4 s at duty cycle 10%) | 25 A |
| Peak inrush current | 120 A |
| Contact material | AgSnO ₂ |

Contact ratings

| Type | Load | Operations | Standard |
|-------|-------------------------------------|---------------------|----------|
| RP3SL | 12 A, 250 Vac, cosφ=1 | 3x10 ⁵ | |
| RP3SL | TV 8 | 25x10 ³ | UL 508 |
| RP3SL | 2500 W, 230 Vac, halogen lamps | >10 ⁴ | |
| RP3SL | 1000 W, 250 Vac, incandescent lamps | 2.3x10 ⁵ | |
| RP3SL | 3000 W, 250 Vac, incandescent lamps | 3.6x10 ⁴ | |
| RP3SL | 1500 VA, fluorescent lamps 163 μF | 10 ⁴ | |

Coil data monostable DC coil

| | |
|--------------------|-------------|
| Nominal voltage | 5...110 Vdc |
| Nominal coil power | 500 mW |
| Operate category | 2 / b |

Coil versions monostable DC coil

| Coil code | Nominal voltage Vdc | Pull-in voltage Vdc | Release voltage Vdc | Maximum voltage Vdc | Coil resistance Ω | Coil current mA |
|------------|---------------------|---------------------|---------------------|---------------------|-------------------|-----------------|
| 012 | 12 | 9.0 | 1.2 | 21.6 | 270±10% | 44.4 |
| 024 | 24 | 18.0 | 2.4 | 43.2 | 1100±15% | 21.8 |
| 048 | 48 | 36.0 | 4.8 | 86.4 | 4400±15% | 10.9 |
| 060 | 60 | 45.0 | 6.0 | 108.0 | 6540±15% | 9.2 |

All figures are given for coil without preenergization, at ambient temperature +20°C
Other coil voltages on request

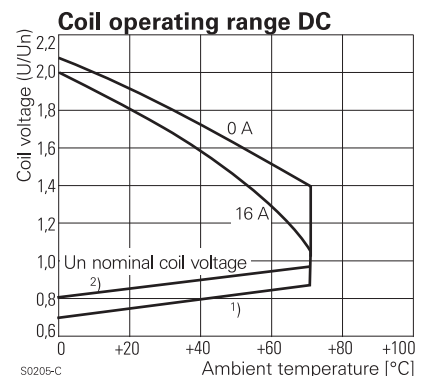
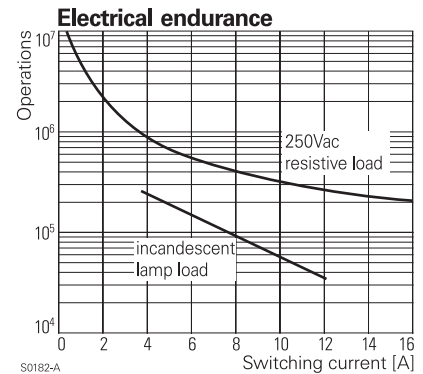
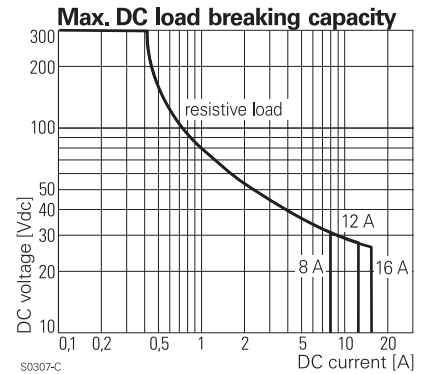

Special Load PCB Relay RP 3 SL

1 pole 16 A, for high inrush currents,
mono- or bistable

| Coil data bistable | 1 coil | 2 coils |
|---------------------------|-----------------|-----------------|
| Nominal voltage | 5...110 Vdc | 5...60 Vdc |
| Nominal coil power | 1.2...1.4 W | 1.2...1.5 W |
| Minimum energization time | 20 ms | |
| Reset voltage min. | 70 % U_{nom} | 75 % U_{nom} |
| Reset voltage max. | 110 % U_{nom} | 120 % U_{nom} |

Coil versions bistable

| Coil code | Nominal voltage Vdc | Pull-in voltage Vdc | Reset voltage Vdc | Reset R1 Ω / W | Coil resistance Ω | Coil current mA |
|--------------------------|---------------------|---------------------|-------------------|-----------------------|--------------------------|-----------------|
| bistable, 1 coil | | | | | | |
| A05 | 5 | 3.7 | 3.6 | 39 / 0.5 | 21 ± 10% | 238.1 |
| A12 | 12 | 9.0 | 8.7 | 220 / 0.5 | 115 ± 10% | 104.3 |
| A24 | 24 | 18.0 | 16.7 | 820 / 0.5 | 460 ± 10% | 52.2 |
| bistable, 2 coils | | | | | | |
| F12 | 12 | 9.0 | 9.0 | | 105 ± 15% | 114.3 |
| F24 | 24 | 18.0 | 18.0 | | 460 ± 15% | 52.2 |

All figures are given for coil without preenergization, at ambient temperature +20°C, duty cycle 20%

Other coil voltages on request

Insulation

| | | |
|---|----------------------|----------------|
| Dielectric strength | coil-contacts | 4000 V_{rms} |
| | open contact circuit | 2000 V_{rms} |
| Clearance / creepage | | 8 / 8 mm |
| Insulation to IEC 60664 | | |
| Voltage rating | | 250 V |
| Pollution degree | | 3 |
| Overvoltage category | | III |
| Insulation to VDE 0110b (2/79) | | |
| Insulation category / reference voltage | | C / 250 |

Other data

| | | |
|--|---|---------------|
| Ambient temperature | -40...+70 °C | |
| Mechanical life | 30x10 ⁶ operations | |
| Max. switching rate at rated- / minimum load | 10 min ⁻¹ / 1200 min ⁻¹ | |
| Operate- / release time monostable | typ. 8 / 2 ms | |
| Operate- / reset time bistable | typ. 6 / 2 ms | |
| Bounce time | typ. 2 ms | |
| Vibration resistance | 20 g, 30...300 Hz | |
| Shock resistance (destruction) | 100 g | |
| Protection category | RT II - flux proof, RT III - wash tight | |
| Relay weight | 18 g | |
| Packaging unit | 1 coil | 20 / 500 pcs. |
| | 2 coils | 25 / 100 pcs. |
| Accessories | see accessories RP | |

Coil operating range DC

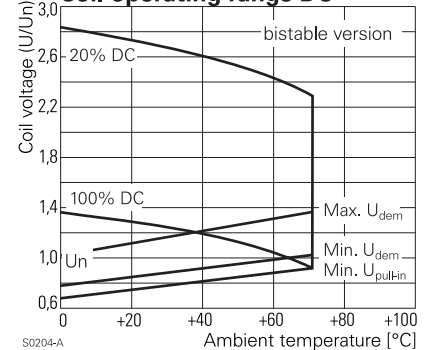

Circuit scheme for bistable 1 coil

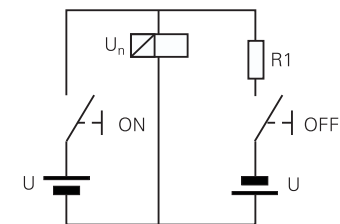

S0328-A

PCB layout / terminal assignment

View on solder pins
Dimensions in mm

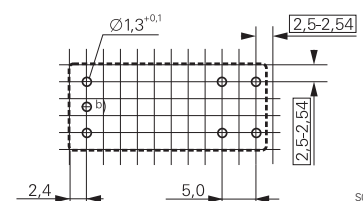

S0163-CR

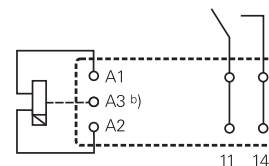

S0163-CS

Bistable versions:

Indicated contact position during or after coil energization with reset voltage.

2-coil versions:
Operate A2, A3
Reset A1, A3

b) for 2 coil version only

Special Load PCB Relay RP 3 SL

1 pole 16 A, for high inrush currents,
mono- or bistable

Dimensions

Dimensions in mm

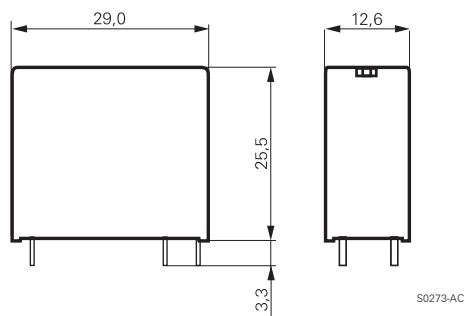

Product key

| | | | | | | | |
|--|---|----------|--|----------|----------|--|--|
| Type | R | P | | S | L | | |
| Version | 3 flux proof | | | | | | |
| Contacts / contact material | 7 wash tight | | | | | | |
| Coil | SL 1 N/O contact, AgSnO ₂ | | | | | | |
| Coil code: please refer to coil versions table | | | | | | | |

Preferred types in bold print

| Product key | Version | Contacts | Coil | Coil | Part number |
|-------------|------------|---------------|----------|--------|-------------|
| RP3SL005 | 16 A | 1 N/O contact | DC-coil | 5 Vdc | 0-1393230-7 |
| RP3SL012 | flux proof | AgSnO | | 12 Vdc | 0-1393230-9 |
| RP3SL024 | | | | 24 Vdc | 1-1393230-1 |
| RP3SLA12 | | | bistable | 12 Vdc | 0-1393230-3 |
| RP3SLA24 | | | 1-coil | 24 Vdc | 0-1393230-4 |
| RP3SLF12 | | | bistable | 12 Vdc | 0-1393230-5 |
| RP3SLF24 | | | 2-coils | 24 Vdc | 0-1393230-6 |
| RP7SL012 | 16 A | | DC-coil | 12 Vdc | 6-1393231-5 |
| RP7SL024 | wash tight | | | 24 Vdc | 6-1393231-6 |

Special Load PCB Relay 409 47, 409 67

1 pole 10 A, for high inrush currents,
mono- or bistable



F0249-A

Features

- Specifically designed to handle high inrush currents
- Tungsten prerun contact
- 500 A / 10 μ s inrush peak current
- 4 kV / 8 mm coil-contact
- meets protection class II requirements

Applications

Dimmer switches, movement sensors, filament loads, halogen bulbs, motors and electrovalves



Technical data of approved types on request

Contact data

| | |
|---|----------------------------|
| Configuration | 1 N/O contact |
| Type of contact | single contact |
| Rated current | 10 A |
| Rated voltage / max.breaking voltage AC | 250 Vac / 400 Vac |
| Maximum breaking capacity AC | 2500 VA |
| Make current (max. 4 s at duty cycle 10%) | 16 A |
| peak inrush current 10 μ s / 20 ms | 500 / 120 A |
| Contact material | W (prerun contact) + AgCdO |

Contact ratings

| Type | Load | Operations | Standard |
|------|--|---------------------|----------|
| 409 | 10 A, 250 Vac, resistive | 2.5x10 ⁵ | |
| 409 | 1300 W, fluorescent lamps, 140 μ F | 3x10 ⁴ | |
| 409 | 2500 W, incandescent lamps | 3x10 ⁴ | |
| 409 | 1000 W, Dulux lamps, 140 μ F | 3x10 ⁴ | |

Coil data

monostable DC coil

| | |
|--------------------|-------------|
| Nominal voltage | 5...110 Vdc |
| Nominal coil power | 820 mW |
| Operate category | 2 / b |

Coil versions monostable

| Coil code | Nominal voltage Vdc | Pull-in voltage Vdc | Release voltage Vdc | Maximum voltage Vdc | Coil resistance Ω | Coil current mA |
|------------|---------------------|---------------------|---------------------|---------------------|-------------------------------|-----------------|
| 031 | 12 | 7.5 | 0.9 | 14.2 | 170\pm10% | 71.0 |
| 027 | 24 | 18.0 | 1.8 | 34.6 | 880\pm15% | 27.0 |
| 024 | 48 | 34.5 | 3.6 | 60.6 | 2700 \pm 15% | 18.0 |
| 023 | 60 | 41.0 | 4.5 | 77.8 | 4400 \pm 15% | 14.0 |

All figures are given for coil without preenergization, at ambient temperature +20°C

Other coil voltages on request

Coil operating range DC

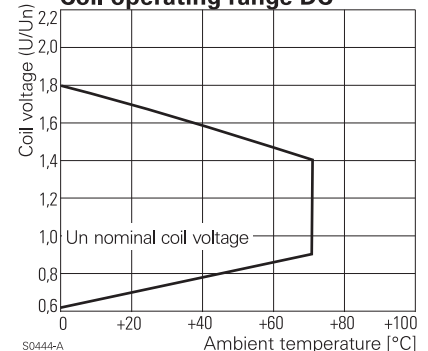

S0444-A

Special Load PCB Relay 409 47, 409 67

1 pole 10 A, for high inrush currents,
mono- or bistable

| | |
|---------------------------|-------------|
| Coil data bistable | 1 coil |
| Nominal voltage | 6...100 Vdc |
| Nominal coil power | 0.8...1 W |
| Minimum energization time | 20 ms |

Coil versions bistable, 1 coil

| Coil code | Nominal voltage Vdc | Pull-in voltage Vdc | Reset voltage min Vdc | Reset voltage max Vdc | Coil resistance Ω | Coil current mA |
|-----------|---------------------|---------------------|-----------------------|-----------------------|--------------------------|-----------------|
| 032 | 12 | 8.9 | 0.7 | 2.5 | 118 \pm 10% | 102.0 |
| 029 | 24 | 18.0 | 1.3 | 5.0 | 457 \pm 10% | 53.0 |

All figures are given for coil without preenergization, at ambient temperature +20°C, duty cycle 20%

Other coil voltages on request

Insulation

| | | |
|---|----------------------|-----------------------|
| Dielectric strength | coil-contacts | 4000 V _{rms} |
| | open contact circuit | 1000 V _{rms} |
| Clearance / creepage | | 8 / 8 mm |
| Insulation to VDE 0110b (2/79) | | |
| Insulation category / reference voltage | | C / 250 |
| Tracking resistance of relay base | | PTI 250 |

Other data

| | |
|--|---|
| Flammability class according to UL 94 | V-0 |
| Ambient temperature | -20...+70 °C |
| Mechanical life | 30x10 ⁶ operations |
| Max. switching rate at rated- / minimum load | 15 min ⁻¹ / 1200 min ⁻¹ |
| Operate- / release time | typ. 10 / 3 ms |
| Bounce time | typ. 3 ms |
| Vibration resistance | 20 g (30...300 Hz) |
| Shock resistance (destruction) | 100 g |
| Category of protection (IEC 61810) | RT II - flux proof |
| Relay weight | 16 g |
| Packaging unit | 25 / 250 pcs. |

PCB layout / terminal assignment

View on solder pins
Dimensions in mm

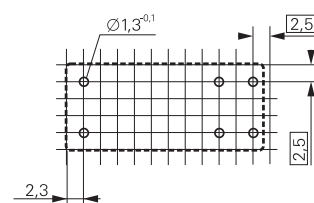

S0163-CX

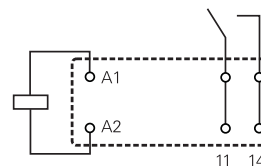

S0163-BF

Bistable versions:
Indicated contact position during or after coil energization with reset voltage.

Special Load PCB Relay 409 47, 409 67

1 pole 10 A, for high inrush currents,
mono- or bistable

Dimensions

Dimensions in mm

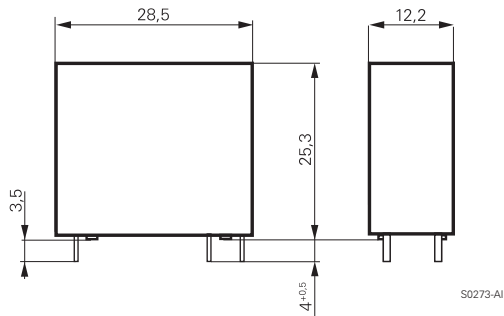

Product key

| | | | | | | | | | | | |
|----------|----------|----------|----------|--|----------|--|--|--|----------|----------|----------|
| 0 | 4 | 0 | 9 | | 7 | | | | 0 | 0 | 1 |
|----------|----------|----------|----------|--|----------|--|--|--|----------|----------|----------|

Type

Coil version

- 47** Monostable version
- 67** Bistable version

Coil

Coil code: Please refer to coil versions table, preferred types in bold print

Contact configuration

- 001** 1 N/O contact

Other types on request

| Product key | Version | Contacts | Coil | Coil | Part number |
|-----------------|------------|----------|----------|-------|-------------|
| 0409 47 031 001 | 10A | 1 N/O | DC-coil | 12Vdc | 1-1415403-6 |
| 0409 47 028 001 | flux proof | W prerun | | 24Vdc | 1-1415403-4 |
| 0409 67 032 001 | | AgCdO | bistable | 12Vdc | 0-1415405-0 |
| 0409 67 029 001 | | | 1 coil | 24Vdc | 0-1415405-1 |

Faston Power Relay IF 125°C

1 pole 16 A



Features

- 1 N/O or 1 N/C contact
- 16 A rated current
- Switching capacity 4000 VA
- Coil power 360 mW
- 4 kV / 8 mm coil-contact, insulation to VDE 0631 and 0700
- Ambient temperature up to 125°C
- Faston-terminals for load side

Applications

Oven control, electric heating, power supplies, air conditioning

F0148-B



Technical data of approved types on request

Contact data

| | |
|---|--------------------------------|
| Configuration | 1 N/O contact or 1 N/C contact |
| Type of contact | single contact |
| Rated current | 16 A |
| Rated voltage / max.breaking voltage AC | 250 Vac / 440 Vac |
| Maximum breaking capacity AC | 4000 VA |
| Make current (max. 4 s at duty cycle 10%) | 25 A |
| Contact material | AgCdO |
| Minimum contact load | 500 mA, 12 Vac |

Contact ratings

| Type | Load | Operations |
|-------|----------------------------------|-------------------|
| -A402 | 10 A, 400 Vac, resistive, 125 °C | 2x10 ⁵ |
| -A402 | 16 A, 250 Vac, resistive, 125 °C | 1x10 ⁵ |
| -A403 | 10 A, 400 Vac, resistive, 125 °C | 5x10 ⁴ |
| -A403 | 16 A, 250 Vac, resistive, 125 °C | 5x10 ⁴ |

Coil data

| | |
|--------------------|------------|
| Nominal voltage | 6...48 Vdc |
| Nominal coil power | 360 mW |
| Operate category | 1 / c |

Coil versions

| Coil code | Nominal voltage Vdc | Pull-in voltage Vdc | Release voltage Vdc | Maximum voltage Vdc | Coil resistance Ω | Coil current mA |
|-----------|---------------------|---------------------|---------------------|---------------------|-------------------|-----------------|
| 003 | 6 | 3.8 | 0.6 | 16.9 | 100±10% | 60.0 |
| 005 | 12 | 7.5 | 1.2 | 33.8 | 400±10% | 30.0 |
| 007 | 24 | 14.9 | 2.4 | 67.7 | 1600±10% | 15.0 |
| 009 | 48 | 30.0 | 4.8 | 135.3 | 6400±10% | 7.5 |

All figures are given for coil without preenergization, at ambient temperature +20°C

Other coil voltages on request

Insulation

| | | |
|-----------------------------------|---|-----------------------|
| Dielectric strength | coil-contacts | 4000 V _{rms} |
| | open contact circuit | 1000 V _{rms} |
| Clearance / creepage | | 8 / 8 mm |
| Insulation to IEC 60664 | | |
| | Voltage rating | 250 V |
| | Pollution degree | 3 |
| | Overtoltage category | III |
| Insulation to VDE 0110b (2/79) | | |
| | Insulation category / reference voltage | C / 250, B / 380 |
| Tracking resistance of relay base | | PTI 250 |

Max. DC load breaking capacity

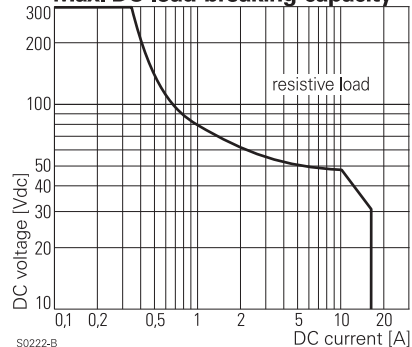

Electrical endurance

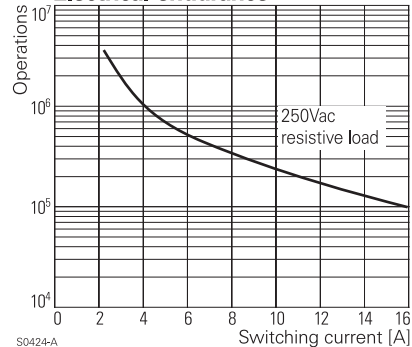

Coil operating range DC

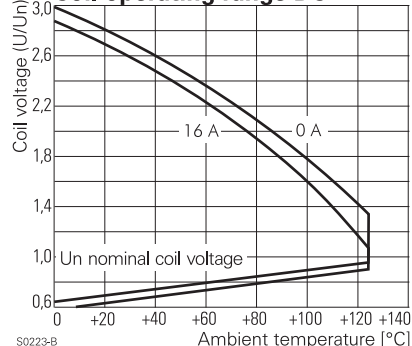

Faston Power Relay IF 125°C

1 pole 16 A

Other data

| | |
|--|---|
| Flammability class according to UL 94 | V-0 |
| Ambient temperature | -40...+125 °C |
| Mechanical life | 30x10 ⁶ operations |
| Max. switching rate at rated- / minimum load | 10 min ⁻¹ / 1200 min ⁻¹ |
| Operate- / release time | 10 / 2 ms |
| Bounce time N/O contact/N/C contact | 1 / 2 ms |
| Category of protection (IEC 61810) | RT II - flux proof |
| Relay weight | 26 g |
| Packaging unit | 15 / 300 pcs. |

PCB layout / terminal assignment

View on solder pins
Dimensions in mm

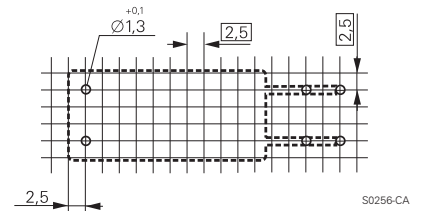

S0256-CA

Dimensions

Dimensions in mm

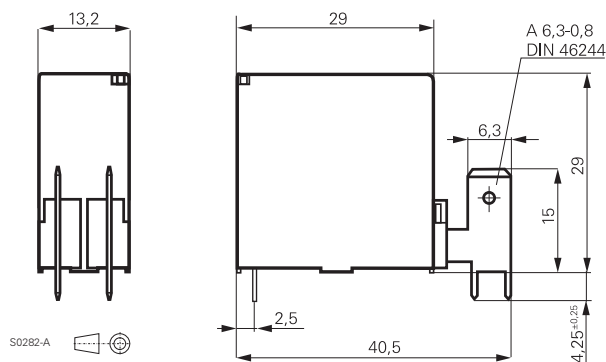

S0282-A

1 N/O contact

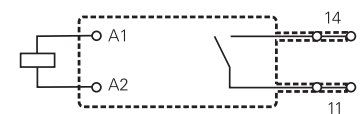

S0256-CB

1 N/C contact

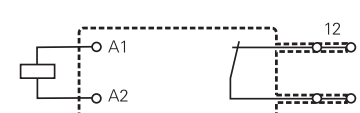

S0256-CC

Product key

V 2 3 0 7 7 - A 1 - A 4

Type

Version

A PCB terminals (coil) and
Faston terminals (contacts); flux proof

Version

1 standard

Coil

003 6 V **007** 24 V
005 12 V **009** 48 V

Contact type

A single contact

Contact material

4 AgCdO

Contact configuration

02 1 N/O contact **03** 1 N/C contact

Other types on request

| Product key | Version | Cont-material | Cont.configuration | Coil | Part number |
|-------------------|------------------|---------------|--------------------|--------|-------------|
| V23077-A1003-A402 | standard | AgCdO | 1 N/O contact | 6 Vdc | 0-1393199-4 |
| V23077-A1005-A402 | PCB terminals | | | 12 Vdc | 0-1393199-7 |
| V23077-A1005-A403 | Faston terminals | | 1 N/C contact | | 0-1393199-9 |
| V23077-A1007-A402 | flux proof | | 1 N/O contact | 24 Vdc | 1-1393199-2 |
| V23077-A1007-A403 | | | 1 N/C contact | | 1-1393199-3 |
| V23077-A1009-A402 | | | 1 N/O contact | 48 Vdc | 1-1393199-5 |
| V23077-A1009-A403 | | | 1 N/C contact | | 1-1393199-6 |

Faston Power Relay 410 63 125°C

1 pole 16 A



F0248-AA

Features

- 1 N/O or 1 N/C contact
- 16 A rated current
- Switching capacity 4000 VA
- Coil power 360 mW
- 4 kV / 8 mm coil-contact, insulation to VDE 0631 and 0700
- Ambient temperature up to 125°C
- Faston-terminals for load side

Applications

White goods appliances, oven control, electric heating, power supplies, air conditioning, motors, magnetic valves



Technical data of approved types on request

Contact data

| | |
|---|--------------------------------|
| Configuration | 1 N/O contact or 1 N/C contact |
| Type of contact | single contact |
| Rated current | 16 A |
| Rated voltage / max.breaking voltage AC | 250 Vac / 400 Vac |
| Maximum breaking capacity AC | 4000 VA |
| Make current (max. 4 s at duty cycle 10%) | 25 A |
| Contact material | AgCdO |

Contact ratings

| Type | Load | Operations |
|-----------|----------------------------------|---------------------|
| N/O cont. | 16 A, 250 Vac, resistive, 125 °C | 1x10 ⁵ |
| N/O cont. | 12 A, 250 Vac, resistive, 70 °C | 4.5x10 ⁵ |
| N/C cont. | 16 A, 250 Vac, resistive, 125 °C | 1.5x10 ⁵ |
| N/O cont. | 10 A, 400 Vac, resistive, 125 °C | 5x10 ⁴ |
| N/O cont. | 12 A, 250 Vac, cosφ=0.6, 125 °C | 5x10 ⁴ |

Coil data

| | |
|--------------------|------------|
| Nominal voltage | 6...60 Vdc |
| Nominal coil power | 360 mW |
| Operate category | 1 / b |

Coil versions

| Coil code | Nominal voltage Vdc | Pull-in voltage Vdc | Release voltage Vdc | Maximum voltage Vdc | Coil resistance Ω | Coil current mA |
|-----------|---------------------|---------------------|---------------------|---------------------|-------------------|-----------------|
| 054 | 6 | 3.6 | 0.45 | 17.0 | 100±10% | 60.0 |
| 050 | 12 | 7.3 | 0.9 | 35.0 | 400±10% | 30.0 |
| 046 | 24 | 14.6 | 1.8 | 67.0 | 1600±10% | 15.0 |
| 043 | 48 | 29.2 | 3.6 | 135.0 | 6400±10% | 7.5 |
| 042 | 60 | 36.5 | 4.5 | 168.0 | 10000±10% | 6.0 |

All figures are given for coil without preenergization, at ambient temperature +20°C
Other coil voltages on request

Insulation

| | | |
|-----------------------------------|---|-----------------------|
| Dielectric strength | coil-contacts | 4000 V _{rms} |
| | open contact circuit | 1000 V _{rms} |
| Clearance / creepage | | 8 mm |
| Insulation to IEC 60664 | | |
| | Voltage rating | 250 V |
| | Pollution degree | 3 |
| | Overvoltage category | III |
| Insulation to VDE 0110b (2/79) | | |
| | Insulation category / reference voltage | C / 250 |
| Tracking resistance of relay base | | PTI 250 |

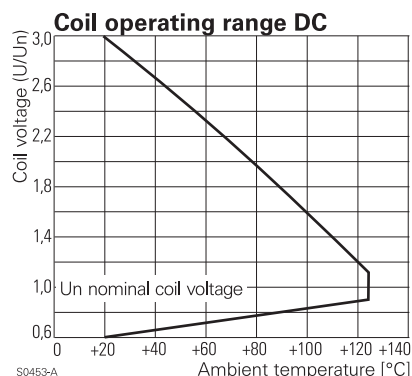
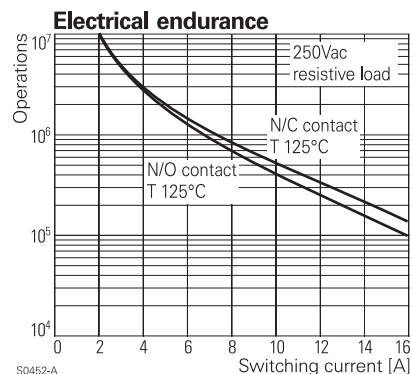

Faston Power Relay 410 63 125°C

1 pole 16 A

Other data

| | |
|--|--|
| Flammability class according to UL 94 | V-0 |
| Ambient temperature | -20...+125 °C |
| Mechanical life | 10x10 ⁶ operations |
| Max. switching rate at rated- / minimum load | 10 min ⁻¹ / 600 min ⁻¹ |
| Operate- / release time | typ. 10 / 5 ms |
| Bounce time | typ. 3 ms |
| Category of protection (IEC 61810) | RT II - flux proof |
| Relay weight | 24 g |
| Packaging unit | 20 / 75 / 1050 pcs. |

PCB layout / terminal assignment

View on solder pins
Dimensions in mm

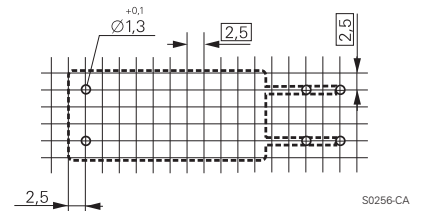

Dimensions

Dimensions in mm

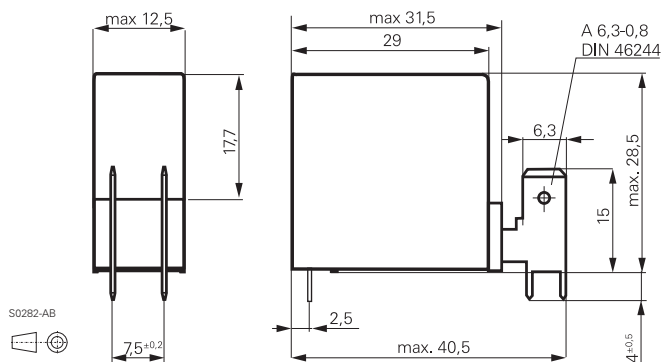

1 N/O contact

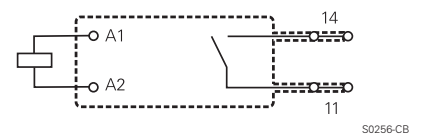

1 N/C contact

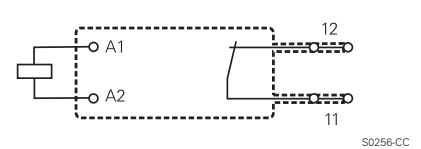

Product key

| | | | | | | | | | |
|---|---|---|---|---|---|--|--|--|--|
| 0 | 4 | 1 | 0 | 6 | 3 | | | | |
|---|---|---|---|---|---|--|--|--|--|

Type

Coil

Coil code: Please refer to coil versions table, preferred types in bold print

Version

001 1 N/O contact

002 1 N/C contact

Other types on request

| Product key | Version | Cont-material | Cont.configuration | Coil | Part number |
|-----------------|------------------|---------------|--------------------|-------|-------------|
| 0410 63 050 001 | standard | AgCdO | 1 N/O contact | 12Vdc | 3-1415410-4 |
| 0410 63 046 001 | PCB terminals | | | 24Vdc | 3-1415410-0 |
| 0410 63 050 002 | Faston terminals | | 1 C/O contact | 12Vdc | 3-1415410-5 |

Faston Power Relay 410 83 3 mm

1 pole 16 A, 3 mm contact gap



F0248-AB

Features

- 1 N/O bridging contact
- Contact gap > 3 mm
- 16 A rated current
- Switching capacity 4000 VA
- Coil power 360 mW
- 4 kV / 8 mm coil-contact, insulation to VDE 0631 and 0700
- Ambient temperature up to 85°C
- Faston-terminals for load side

Applications

Washing machines, tumble dryers, absolute safe power supply disconnection in other domestic applications



Technical data of approved types on request

Contact data

| | |
|---|----------------------------------|
| Configuration | 1 N/O contact |
| Type of contact | single contact, bridging contact |
| Rated current | 16 A |
| Rated voltage / max. breaking voltage AC | 250 Vac / 400 Vac |
| Maximum breaking capacity AC | 4000 VA |
| Make current (max. 4 s at duty cycle 10%) | 20 A |
| Contact material | AgNi |
| Contact gap | >3 mm |

Contact ratings

| Type | Load | Operations |
|--------|---------------------------------|-------------------|
| 410 83 | 16 A, 250 Vac, resistive, 85 °C | 3x10 ⁴ |
| 410 83 | 10 A, 250 Vac, resistive, 85 °C | 1x10 ⁵ |
| 410 83 | 10 A, 400 Vac, resistive, 85 °C | 1x10 ⁵ |

Coil data

| | |
|--------------------|------------|
| Nominal voltage | 6...60 Vdc |
| Nominal coil power | 360 mW |
| Operate category | 1 / c |

Coil versions

| Coil code | Nominal voltage Vdc | Pull-in voltage Vdc | Release voltage Vdc | Maximum voltage Vdc | Coil resistance Ω | Coil current mA |
|-----------|---------------------|---------------------|---------------------|---------------------|-------------------|-----------------|
| 054 | 6 | 3.9 | 0.45 | 13.2 | 100±10% | 60.0 |
| 050 | 12 | 7.9 | 0.9 | 26.4 | 400±10% | 30.0 |
| 046 | 24 | 15.8 | 1.8 | 53.0 | 1600±10% | 15.0 |
| 043 | 48 | 31.6 | 3.6 | 106.0 | 6400±10% | 7.5 |
| 042 | 60 | 39.5 | 4.5 | 132.0 | 10000±10% | 3.7 |

All figures are given for coil without preenergization, at ambient temperature +20°C

Other coil voltages on request

Insulation

| | | |
|---|----------------------|-----------------------|
| Dielectric strength | coil-contacts | 4000 V _{rms} |
| | open contact circuit | 2000 V _{rms} |
| Clearance / creepage | | 8 / 8 mm |
| Insulation to IEC 60664 | | |
| Voltage rating | | 250 V |
| Pollution degree | | 3 |
| Overvoltage category | | III |
| Insulation to VDE 0110b (2/79) | | |
| Insulation category / reference voltage | | C / 250 |
| Tracking resistance of relay base | | PTI 250 |

Max. DC load breaking capacity

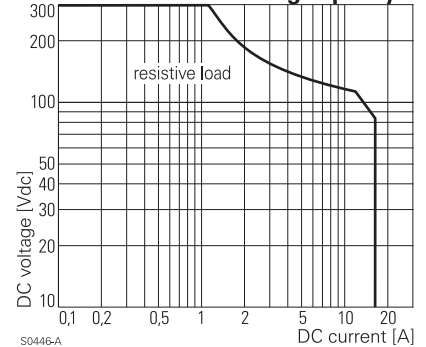

S0446-A

Electrical endurance

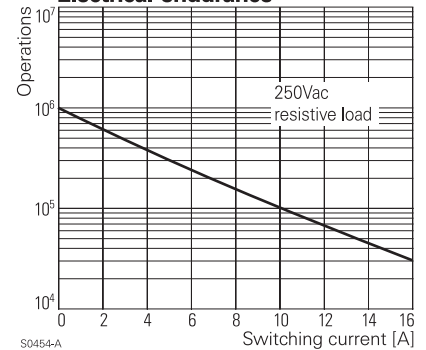

S0454-A

Coil operating range DC

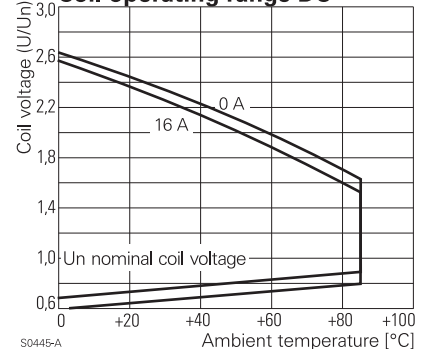

S0445-A

Faston Power Relay 410 83 3 mm

1 pole 16 A, 3 mm contact gap

Other data

| | |
|--|--|
| Flammability class according to UL 94 | V-0 |
| Ambient temperature | -20...+85 °C |
| Mechanical life | 1x10 ⁷ operations |
| Max. switching rate at rated- / minimum load | 10 min ⁻¹ / 600 min ⁻¹ |
| Operate- / release time | typ. 14 / 5 ms |
| Bounce time | typ. 3 ms |
| Vibration resistance | 10 g, 10...500 Hz |
| Shock resistance (destruction) | 100 g |
| Category of protection (IEC 61810) | RT II - flux proof |
| Relay weight | 24 g |
| Packaging unit | 20 / 75 / 1050 pcs. |

PCB layout / terminal assignment

View on solder pins
Dimensions in mm

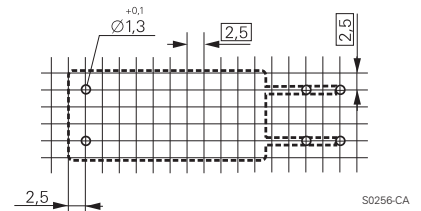

Dimensions

Dimensions in mm

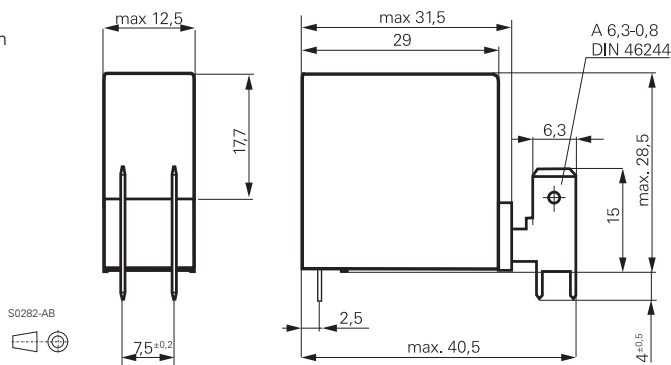

1 N/O bridging contact

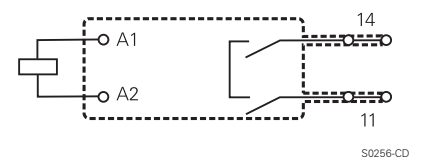

Product key

0 4 1 0 **8 3** **0 0 1**

Type

Coil

Coil code: Please refer to coil versions table, preferred types in bold print

Version

001 1 N/O contact

Other types on request

| Product key | Version | Cont-material | Cont.configuration | Coil | Part number |
|-----------------|------------|---------------|--------------------|-------|-------------|
| 0410 83 050 001 | standard | AgCdO | 1 N/O contact | 12Vdc | 4-1415410-9 |
| 0410 83 046 001 | PCB/Faston | | | 24Vdc | 4-1415410-8 |

Power PCB Relay RT2

2 pole 8 A, DC and AC-coil



F0149-B

Features

- 2 C/O or 2 N/O contacts
- Sensitive coil 400 mW
- DC- or AC-coil
- 5 kV / 10 mm coil-contact
- Protection class II (VDE 0700)
- Height 15.7 mm
- Sockets with PCB-type or screw-type terminals

Applications

Domestic appliances, heating control, emergency lighting, modems



Technical data of approved types on request

Contact data

| | |
|---|------------------------------------|
| Configuration | 2 C/O contact or 2 N/O contact |
| Type of contact | single contact |
| Rated current | 8 A |
| Rated voltage / max.breaking voltage AC | 250 Vac / 440 Vac |
| Maximum breaking capacity AC | 2000 VA |
| Make current (max. 4 s at duty cycle 10%) | 15 A |
| Contact material | AgNi 90/10, AgNi 90/10 gold plated |

Contact ratings

| Type | Load | Operations | Standard |
|--------|---|-------------------|----------|
| RT 424 | 4 A, 230 Vac, $\cos\phi=0.6$ | 1.5×10^5 | Standard |
| RT 424 | 6 (2) A, 250 Vac, on the N/O- N/C contact | | VDE 0631 |
| RT 424 | 1/2 hp / 240 Vac, 1/4 hp / 120 Vac | 6×10^3 | UL 508 |

Coil data

| Nominal voltage | DC coil | 5...110 Vdc |
|--------------------|---------|--------------|
| | AC coil | 24...230 Vac |
| Nominal coil power | DC coil | 400 mW |
| | AC coil | 0.75 VA |
| Operate category | | 2 / b |

Coil versions, DC-coil

| Coil code | Nominal voltage Vdc | Pull-in voltage Vdc | Release voltage Vdc | Maximum voltage Vdc | Coil resistance Ω | Coil current mA |
|-----------|---------------------|---------------------|---------------------|---------------------|--------------------------|-----------------|
| 005 | 5 | 3.5 | 0.5 | 12.7 | $62 \pm 10\%$ | 80.0 |
| 006 | 6 | 4.2 | 0.6 | 15.3 | $90 \pm 10\%$ | 66.7 |
| 012 | 12 | 8.4 | 1.2 | 30.6 | $360 \pm 10\%$ | 33.3 |
| 024 | 24 | 16.8 | 2.4 | 61.2 | $1440 \pm 10\%$ | 16.7 |
| 048 | 48 | 33.6 | 4.8 | 122.4 | $5520 \pm 10\%$ | 8.7 |
| 060 | 60 | 42.0 | 6.0 | 153.0 | $7340 \pm 12\%$ | 8.1 |
| 110 | 110 | 77.0 | 11.0 | 280.5 | $26600 \pm 12\%$ | 4.1 |

All figures are given for coil without preenergization, at ambient temperature +20°C Other coil voltages on request

Max. DC load breaking capacity

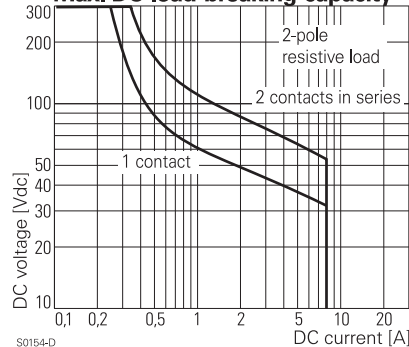

S0154-D

Electrical endurance

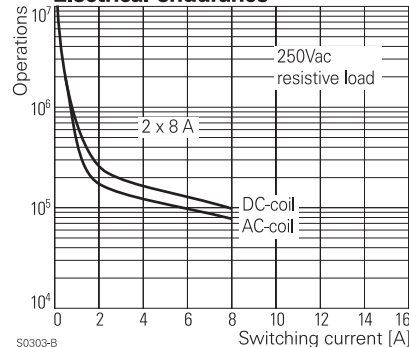

S0303-B

Coil operating range DC

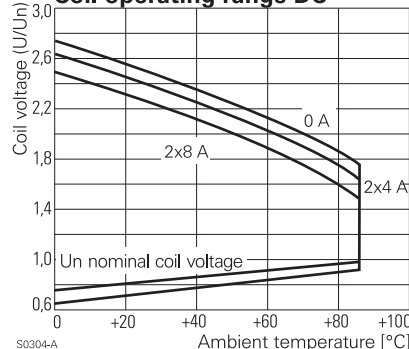

S0304-A

Power PCB Relay RT2

2 pole 8 A, DC and AC-coil

Coil versions, AC-coil

| Coil code | Nominal voltage Vac | Pull-in voltage Vac | Release voltage Vac | Maximum voltage Vac | Coil resistance Ω | Coil current mA |
|-----------|---------------------|---------------------|---------------------|---------------------|--------------------------|-----------------|
| 524 | 24 | 18.0 | 3.6 | 36.0 | 350 \pm 10% | 31.6 |
| 615 | 115 | 86.3 | 17.3 | 172.5 | 8100 \pm 15% | 6.6 |
| 730 | 230 | 172.5 | 34.5 | 345.0 | 32500 \pm 15% | 3.2 |

All figures are given for coil without preenergization, at ambient temperature +20°C

Insulation

| | | |
|---|----------------------|----------------|
| Dielectric strength | coil-contacts | 5000 V_{rms} |
| | open contact circuit | 1000 V_{rms} |
| | adjacent contacts | 2500 V_{rms} |
| Clearance / creepage | | 10 / 10 mm |
| Insulation to IEC 60664 | | |
| Voltage rating | | 250 V |
| Pollution degree | | 3 |
| Overvoltage category | | III |
| Insulation to VDE 0110b (2/79) | | |
| Insulation category / reference voltage | | C / 250 |

Other data

| | |
|--|---|
| Flammability class according to UL 94 | V-0 |
| Coil insulation system according to UL 1446 | Class F |
| Ambient temperature | -40...+70 °C |
| Mechanical life | DC-coil >30x10 ⁶ operations AC-coil >5x10 ⁶ operations |
| Max. switching rate at rated- / minimum load | 6 min ⁻¹ / 1200 min ⁻¹ |
| Operate- / release time DC-coil | typ. 7 / 2 ms |
| Bounce time N/O contact/N/C contact | typ. 1 / 3 ms |
| Vibration resistance N/O / N/C contact | 20 / 5 g, 30...300 Hz |
| Shock resistance (destruction) | 100 g |
| Category of protection (IEC 61810) | RT II - flux proof, RT III - wash tight |
| Relay weight | 13 g |
| Packaging unit | 20 / 500 pcs. |
| Accessories | see accessories RT |

Coil operating range AC

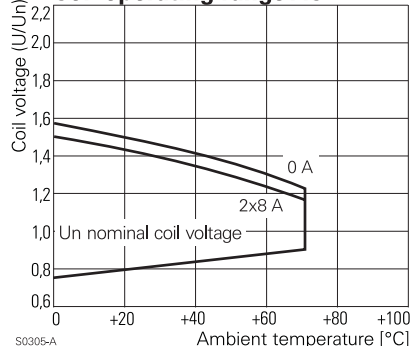

S0305-A

PCB layout / terminal assignment

View on solder pins
Dimensions in mm

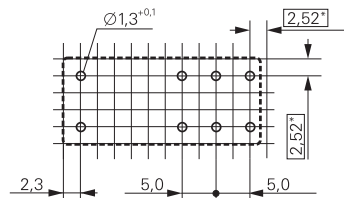

S0418-BA

*) With the recommended PCB hole sizes a grid pattern from 2.5 mm to 2.54 mm can be used.

Dimensions

Dimensions in mm

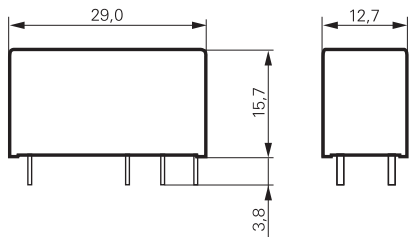

S0272-AA

2 C/O contacts

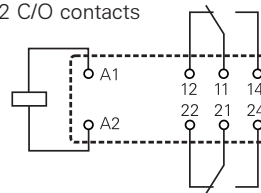

S0163-BJ

2 N/O contacts

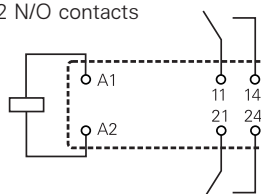

S0163-BK

Power PCB Relay RT2

2 pole 8 A, DC and AC-coil

Product key

| | | | | | | |
|----------|----------|----------|--|--|--|--|
| R | T | 4 | | | | |
|----------|----------|----------|--|--|--|--|

Type

Version

4 8 A, pinning 5 mm, flux proof

E 8 A, pinning 5 mm, wash tight

Contacts

2 2 C/O contacts **4 2 N/O contacts**

Contact material

4 AgNi 90/10 **5 AgNi 90/10 gold plated**

Coil

Coil code: please refer to coil versions table

Preferred types in bold print

| Product key | Version | Contacts | Cont. material | Coil | Coil | Part number |
|-------------|--------------|----------------|----------------|---------|---------|-------------|
| RT424005 | 8 A | 2 C/O contacts | AgNi 90/10 | DC-coil | 5 Vdc | 5-1393243-9 |
| RT424006 | pinning 5 mm | | | | 6 Vdc | 6-1393243-1 |
| RT424012 | flux proof | | | | 12 Vdc | 6-1393243-3 |
| RT424024 | | | | | 24 Vdc | 6-1393243-8 |
| RT424048 | | | | | 48 Vdc | 7-1393243-0 |
| RT424060 | | | | | 60 Vdc | 7-1393243-3 |
| RT424110 | | | | | 110 Vdc | 7-1393243-5 |
| RT424524 | | | | AC-coil | 24 Vac | 7-1393243-6 |
| RT424615 | | | | | 115 Vac | 7-1393243-8 |
| RT424730 | | | | | 230 Vac | 7-1393243-9 |
| RT425005 | | | AgNi 90/10 | DC-coil | 5 Vdc | 8-1393243-0 |
| RT425012 | | | gold plated | | 12 Vdc | 8-1393243-2 |
| RT425024 | | | | | 24 Vdc | 8-1393243-5 |
| RT425524 | | | | AC-coil | 24 Vac | 9-1393243-1 |
| RT425615 | | | | | 115 Vac | 9-1393243-2 |
| RT425730 | | | | | 230 Vac | 9-1393243-3 |
| RT444012 | | 2 N/O contacts | AgNi 90/10 | DC-coil | 12 Vdc | 9-1393243-7 |
| RT444024 | | | | | 24 Vdc | 9-1393243-9 |
| RTE24005 | 8 A | 2 C/O contacts | | | 5 Vdc | 0-1393243-1 |
| RTE24006 | pinning 5 mm | | | | 6 Vdc | 0-1393243-2 |
| RTE24012 | wash tight | | | | 12 Vdc | 0-1393243-4 |
| RTE24024 | | | | | 24 Vdc | 1-1393243-0 |
| RTE24048 | | | | | 48 Vdc | 1-1393243-1 |
| RTE24060 | | | | | 60 Vdc | 1-1393243-3 |
| RTE24110 | | | | | 110 Vdc | 1-1393243-4 |
| RTE24524 | | | | AC-coil | 24 Vac | 1-1393243-5 |
| RTE24615 | | | | | 115 Vac | 1-1393243-7 |
| RTE24730 | | | | | 230 Vac | 1-1393243-8 |
| RTE25005 | | | AgNi 90/10 | DC-coil | 5 Vdc | 1-1393243-9 |
| RTE25012 | | | gold plated | | 12 Vdc | 2-1393243-0 |
| RTE25024 | | | | | 24 Vdc | 2-1393243-1 |

Power PCB Relay RT2 bistable

2 pole 8 A, polarized bistable version



Features

- 2 C/O contacts
- Bistable with 1 or 2 coils
- 5 kV / 10 mm coil-contact
- Height 15.7 mm
- Cadmium-free contacts
- Protection class II (VDE 0700)

Applications

Battery powered equipment or applications with "memory function" (e.g. mains failure)

F0219-B



Technical data of approved types on request

Contact data

| | |
|---|-------------------|
| Configuration | 2 C/O contact |
| Type of contact | single contact |
| Rated current | 8 A |
| Rated voltage / max. breaking voltage AC | 250 Vac / 440 Vac |
| Maximum breaking capacity AC | 2000 VA |
| Make current (max. 4 s at duty cycle 10%) | 15 A |
| Contact material | AgNi 90/10 |

Coil data

| | 1 coil | 2 coils |
|---|--------------------------|-----------------|
| Nominal voltage | 5...24 Vdc | |
| Nominal coil power | typ. 400 mW | typ. 600 mW |
| Minimum energization time | 30 ms | |
| Information on reduced pulse duration with higher energization voltages on demand | | |
| Max. energization time for version with 2 coils | 1 min at <10% duty cycle | |
| Reset voltage min. | 70 % U_{nom} | 70 % U_{nom} |
| Reset voltage max. | 120 % U_{nom} | 150 % U_{nom} |

Coil versions, bistable

| Coil code | Nominal voltage Vdc | Pull-in voltage Vdc | Reset voltage Vdc | Coil resistance Ω | Coil current mA |
|--------------------------|---------------------|---------------------|-------------------|--------------------------|-----------------|
| bistable, 1 coil | | | | | |
| A05 | 5 | 3.5 | 3.5 | 62 ± 10% | 80.0 |
| A06 | 6 | 4.2 | 4.2 | 90 ± 10% | 66.7 |
| A12 | 12 | 8.4 | 8.4 | 360 ± 10% | 33.3 |
| A24 | 24 | 16.8 | 16.8 | 1440 ± 10% | 16.7 |
| bistable, 2 coils | | | | | |
| F05 | 5 | 3.5 | 3.5 | 42 ± 10% | 120.0 |
| F06 | 6 | 4.2 | 4.2 | 55 ± 10% | 110.0 |
| F12 | 12 | 8.4 | 8.4 | 240 ± 10% | 50.0 |
| F24 | 24 | 16.8 | 16.8 | 886 ± 10% | 27.0 |

All figures are given for coil without preenergization, at ambient temperature +20°C
Other coil voltages on request

Coils - operation

| Version | 1 coil | | 2 coils | | |
|----------------|--------|----|---------|----|----|
| Coil terminals | A1 | A2 | A1 | A3 | A2 |
| Pull-in | + | - | + | + | - |
| Reset | - | + | - | + | + |

Contact position not defined at delivery

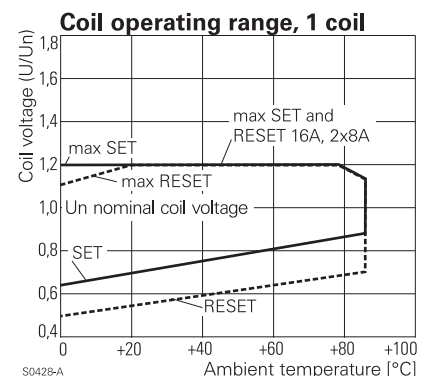
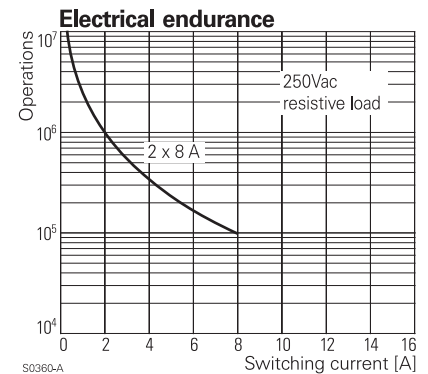
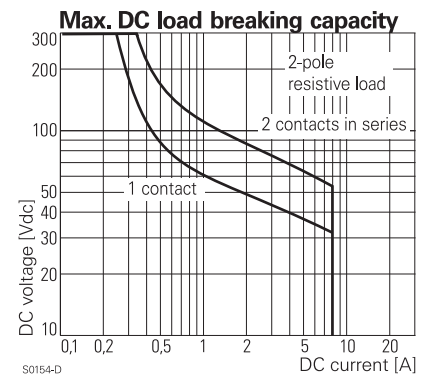

Power PCB Relay RT2 bistable

2 pole 8 A, polarized bistable version

Insulation

| | | |
|---|----------------------|-----------------------|
| Dielectric strength | coil-contacts | 5000 V _{rms} |
| | open contact circuit | 1000 V _{rms} |
| | adjacent contacts | 2500 V _{rms} |
| Clearance / creepage | | 10 / 10 mm |
| Insulation to IEC 60664 | | |
| Voltage rating | | 250 V |
| Pollution degree | | 3 |
| Overvoltage category | | III |
| Insulation to VDE 0110b (2/79) | | |
| Insulation category / reference voltage | | C / 250 |

Other data

| | |
|--|--|
| Flammability class according to UL 94 | V-0 |
| Coil insulation system according to UL 1446 | Class F |
| Ambient temperature | -40...+85 °C (UL: +70 °C) |
| Mechanical life | 2x10 ⁶ operations |
| Max. switching rate at rated- / minimum load | 6 min ⁻¹ / 600 min ⁻¹ |
| Operate- / release time | typ. 5 / 3 ms |
| Bounce time N/O contact/N/C contact | typ. 1 / 4 ms |
| Vibration resistance / shock resistance | |
| opening N/C contact | 3 / 5 g |
| opening closed N/O contact | 6 / 15 g |
| Shock resistance (destruction) | 100 g |
| Category of protection (IEC 61810) | RT II - flux proof |
| Relay weight | 13 g |
| Packaging unit | 1 coil 20 / 500 pcs. 2 coils 25 / 100 pcs. |
| Accessories | see accessories RT |

Dimensions

Dimensions in mm

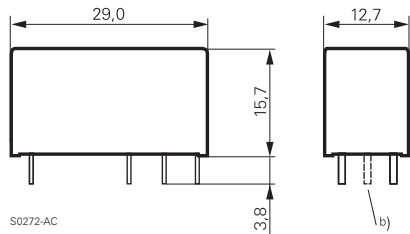

a) Indicated contact position while or after coil energization with reset voltage.

b) for 2 coil version only

Coil operating range, 2 coils

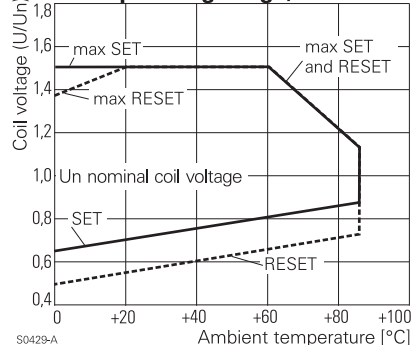

PCB layout / terminal assignment

View on solder pins
Dimensions in mm

8 A, Pinning 5 mm

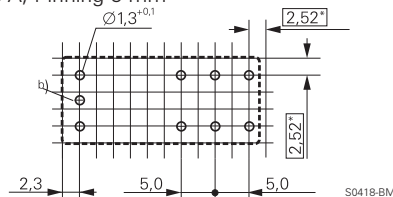

*) With the recommended PCB hole sizes a grid pattern from 2.5 mm to 2.54 mm can be used.

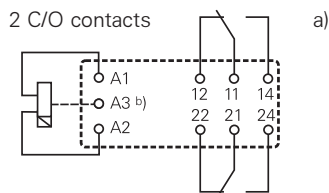

Product key

Type

Version

4 8 A, pinning 5 mm, flux proof

Contacts

2 2 C/O contacts

Contact material

4 AgNi 90/10

Coil

Coil code: please refer to coil versions table, preferred types in bold print

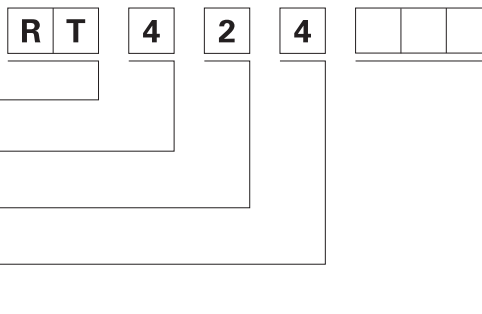

| Product key | Version | Contacts | Cont. material | Coil | Coil | Part number |
|-------------|--------------|----------------|----------------|----------|--------|-------------|
| RT424A12 | 8 A | 2 C/O contacts | AgNi 90/10 | bistable | 12 Vdc | 4-1393243-6 |
| RT424A24 | pinning 5 mm | | | 1 coil | 24 Vdc | 4-1393243-7 |
| RT424F12 | flux proof | | | bistable | 12 Vdc | 5-1393243-4 |
| RT424F24 | | | | 2 coils | 24 Vdc | 5-1393243-6 |

Power PCB Relay RP II/2

2 pole 8 A



Features

- 2 C/O or 2 N/O contacts
- 4 kV / 8 mm coil-contact
- Twin contacts available
- PCB-sockets

Applications

Domestic appliances, UPS's



Technical data of approved types on request

F0150-B

Contact data

| | |
|---|--------------------------------|
| Configuration | 2 C/O contact or 2 N/O contact |
| Type of contact | single contact |
| Rated current | 8 A (UL: 10 A) |
| Rated voltage / max.breaking voltage AC | 250 Vac / 440 Vac |
| Maximum breaking capacity AC | 2000 VA |
| Make current (max. 4 s at duty cycle 10%) | 14 A |
| Contact material | AgNi 0.15, AgCdO |

Contact ratings

| Type | Load | Operations | Standard |
|-------|--|-----------------------------|----------|
| RP440 | 64 A ON, 2 A OFF, 250 Vac | 1x10 ⁴ | VDE 0860 |
| RP421 | 2 A, 50 Vdc, resistive | approx. 2x10 ⁶ | |
| RP421 | 1/10hp, 240 Vac, per contact | | UL 508 |
| RP421 | 3 A, 380 Vac, AC11 | approx. 3x10 ⁴ | VDE 0660 |
| RP421 | 0.18 A, 110 Vdc, DC11 | approx. 1x10 ⁵ | VDE 0660 |
| RP420 | 0.6 A, 220 Vac, cosφ=0.8, single phase motor | approx. 1.3x10 ⁶ | |

Coil data

| | |
|--------------------|-------------|
| Nominal voltage | 5...110 Vdc |
| Nominal coil power | 500 mW |
| Operate category | 2 / b |

Coil versions, DC-coil

| Coil code | Nominal voltage Vdc | Pull-in voltage Vdc | Release voltage Vdc | Maximum voltage Vdc | Coil resistance Ω | Coil current mA |
|-----------|---------------------|---------------------|---------------------|---------------------|-------------------|-----------------|
| 005 | 5 | 3.5 | 0.5 | 9.0 | 54±10% | 92.6 |
| 006 | 6 | 4.2 | 0.6 | 10.8 | 68±10% | 88.2 |
| 012 | 12 | 8.4 | 1.2 | 21.6 | 270±10% | 44.4 |
| 024 | 24 | 16.8 | 2.4 | 43.2 | 1100±15% | 21.8 |
| 048 | 48 | 33.6 | 4.8 | 86.4 | 4400±15% | 10.9 |
| 060 | 60 | 42.0 | 6.0 | 108.0 | 6540±15% | 9.2 |
| 110 | 110 | 77.0 | 11.0 | 198.0 | 23100±15% | 4.8 |

All figures are given for coil without preenergization, at ambient temperature +20°C
Other coil voltages on request

Insulation

| | | |
|----------------------|----------------------|-----------------------|
| Dielectric strength | coil-contacts | 4000 V _{rms} |
| | open contact circuit | 1000 V _{rms} |
| | adjacent contacts | 2500 V _{rms} |
| Clearance / creepage | | 8 / 8 mm |

Max. DC load breaking capacity

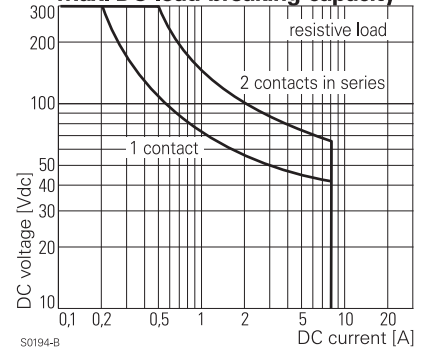

S0194-B

Electrical endurance

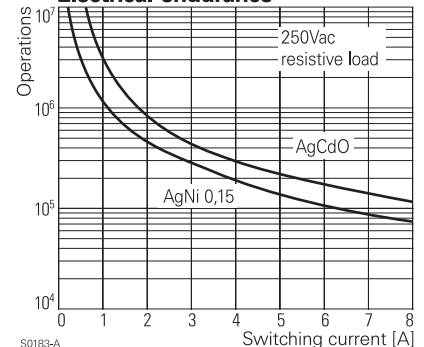

S0183-A

Coil operating range DC

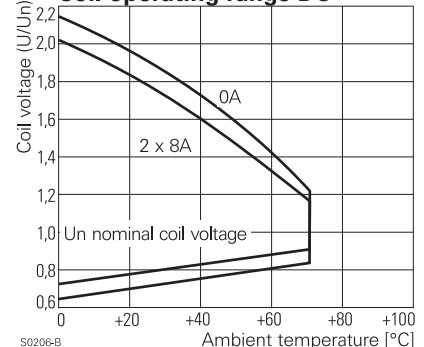

S0206-B

Power PCB Relay RP II/2

2 pole 8 A

Insulation

| | |
|---|---------|
| Insulation to IEC 60664 | |
| Voltage rating | 250 V |
| Pollution degree | 3 |
| Overvoltage category | III |
| Insulation to VDE 0110b (2/79) | |
| Insulation category / reference voltage | C / 250 |

Other data

| | |
|--|---|
| Ambient temperature | -40...+70 °C |
| Mechanical life | 20x10 ⁶ operations |
| Max. switching rate at rated- / minimum load | 10 min ⁻¹ / 1200 min ⁻¹ |
| Operate- / release time | typ. 9 / 3 ms |
| Bounce time N/O contact/N/C contact | typ. 2 / 3 ms |
| Vibration resistance N/O / N/C contact | 11 / 1.5 g, 30...150 Hz |
| Shock resistance (destruction) | 100 g |
| Category of protection (IEC 61810) | RT II - flux proof, RT III - wash tight |
| Relay weight | 18 g |
| Packaging unit | 20 / 500 pcs. |
| Accessories | see accessories RT and RP |

PCB layout / terminal assignment

View on solder pins
Dimensions in mm

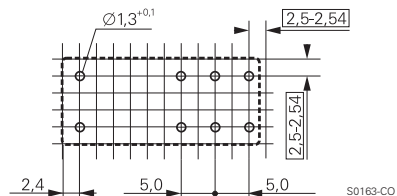

2 C/O contacts

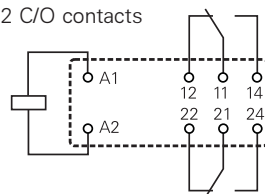

2 N/O contacts

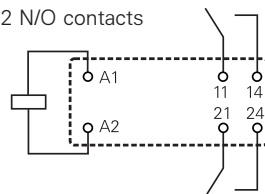

Dimensions

Dimensions in mm

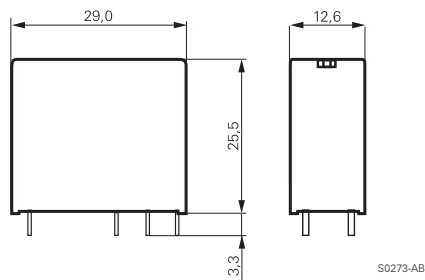

Product key

Type

Version

4 8 A, flux proof **8** 8 A, wash tight

Contacts

2 2 C/O contacts **4** 2 N/O contacts

Contact material

0 AgCdO **1** AgNi 0.15

Coil

Coil code: please refer to coil versions table

Preferred types in bold print

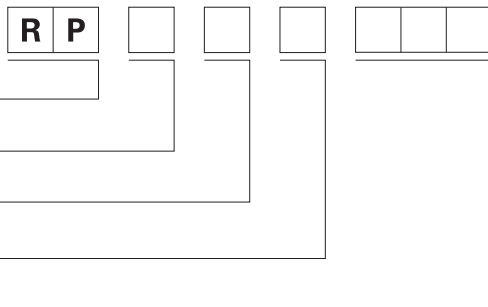

| Product key | Version | Contacts | Contact material | Coil | Part number | | | |
|-------------|-------------------|----------------|------------------|----------------|----------------|-----------|-------------|-------------|
| RP420005 | flux proof 8 A | 2 C/O contacts | AgCdO | 5 Vdc | 4-1393234-7 | | | |
| RP420006 | | | | 6 Vdc | 4-1393234-8 | | | |
| RP420012 | | | | 12 Vdc | 5-1393234-0 | | | |
| RP420024 | | | | 24 Vdc | 5-1393234-1 | | | |
| RP420048 | | | | 48 Vdc | 5-1393234-2 | | | |
| RP420110 | | | | 110 Vdc | 5-1393234-4 | | | |
| RP421012 | | | | AgNi 0.15 | 2 C/O contacts | 12 Vdc | 6-1393234-7 | |
| RP421024 | | | | | | 24 Vdc | 6-1393234-8 | |
| RP421048 | | | | | | 48 Vdc | 6-1393234-9 | |
| RP421060 | | | | | | 60 Vdc | 7-1393234-0 | |
| RP421110 | 110 Vdc | 7-1393234-1 | | | | | | |
| RP440012 | wash tight 8 A | 2 N/O contacts | AgCdO | | | 12 Vdc | 7-1393234-8 | |
| RP440024 | | | | 24 Vdc | 7-1393234-9 | | | |
| RP820006 | | | | 2 C/O contacts | AgCdO | 6 Vdc | 8-1393234-8 | |
| RP820012 | | | | | | 12 Vdc | 9-1393234-0 | |
| RP820024 | | | | | | 24 Vdc | 9-1393234-2 | |
| RP820048 | | | | | | 48 Vdc | 9-1393234-3 | |
| RP821012 | | | | | | AgNi 0.15 | 12 Vdc | 0-1393845-4 |
| RP821024 | | | | | | | 24 Vdc | 0-1393845-5 |
| RP840024 | | | | 2 N/O contacts | AgCdO | 24 Vdc | 1-1393845-8 | |
| RP841024 | | | | | | AgNi 0.15 | 24 Vdc | 5-1393235-3 |

Power PCB Relay Card E

1 pole 8 A



Features

- 1 C/O or 1 N/O contact
- 4 kV coil-contact
- Vertical and horizontal version
- Version with twin contacts
- Wash tight

Applications

I/O modules, heating control, timers

F0151-B



Technical data of approved types on request

Contact data

| | |
|---|--------------------------------|
| Configuration | 1 C/O contact or 1 N/O contact |
| Type of contact | standard: single contact |
| Rated current | 8 A / 5 A with AgNi 0.15 |
| Rated voltage / max.breaking voltage AC | 250 Vac / 440 Vac |
| Maximum breaking capacity AC | 2000 VA |
| Make current (max. 4 s at duty cycle 10%) | 15 A |
| Contact material | AgCdO, AgNi 20, AgNi 0.15 |

Contact ratings

| Type | Load | Operations |
|-------|-----------------------------------|-------------------|
| -A102 | 4 A, 30 Vdc, resistive | 2x10 ⁶ |
| -A102 | 1 A, 24 Vdc, inductive L / R=40ms | 2x10 ⁵ |
| -A402 | 1 A, 230 Vac, cosφ=0.4 | 5x10 ⁵ |

Coil data

| | |
|--------------------|--------------|
| Nominal voltage | 6...60 Vdc |
| Nominal coil power | 450...500 mW |
| Operate power | 240 mW |

Coil versions

| Coil code | Nominal voltage Vdc | Pull-in voltage Vdc | Release voltage Vdc | Maximum voltage Vdc | Coil resistance Ω | Coil current mA |
|-----------|---------------------|---------------------|---------------------|---------------------|-------------------|-----------------|
| 001 | 6 | 4.0 | 0.6 | 10.6 | 80±10% | 75.0 |
| 002 | 12 | 8.0 | 1.2 | 21.5 | 330±10% | 36.4 |
| 006 | 24 | 16.0 | 2.4 | 40.0 | 1200±15% | 20.0 |
| 013 | 48 | 32.0 | 4.8 | 79.0 | 4700±15% | 10.2 |
| 023 | 60 | 40.0 | 6.0 | 98.0 | 7200±15% | 8.3 |

All figures are given for coil without preenergization, at ambient temperature +20°C
Other coil voltages on request

Max. DC load breaking capacity

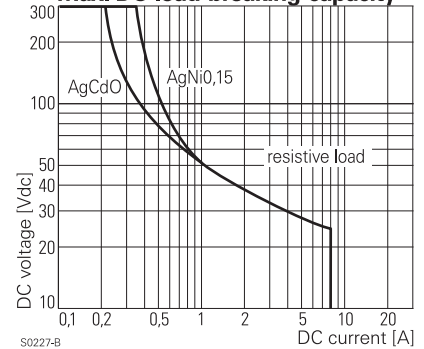

S0227-B

Electrical endurance

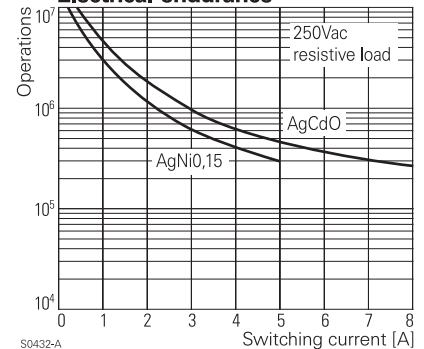

S0432-A

Coil operating range DC

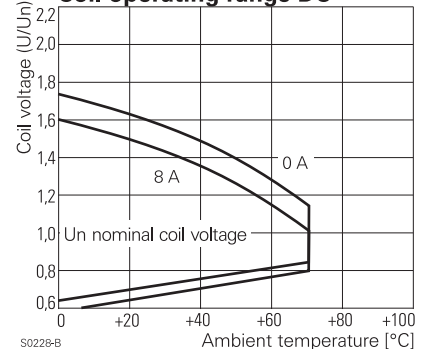

S0228-B

Power PCB Relay Card E

1 pole 8 A

| Insulation | | |
|---|----------------------|-----------------------|
| Dielectric strength | coil-contacts | 4000 V _{rms} |
| | open contact circuit | 1000 V _{rms} |
| Clearance / creepage | | 4 / 4 mm |
| Insulation to IEC 60664 | | |
| Voltage rating | | 250 V |
| Pollution degree | | 3 |
| Overvoltage category | | III |
| Insulation to VDE 0110b (2/79) | | |
| Insulation category / reference voltage | | C / 250 |
| Tracking resistance of relay base | | CTI 250 |

| Other data | |
|--|--|
| Flammability class according to UL 94 | V-0 |
| Ambient temperature | -40...+70 °C |
| Mechanical life | approx. 20x10 ⁶ operations |
| Max. switching rate at rated- / minimum load | 6 min ⁻¹ / 20 s ⁻¹ |
| Operate- / release time | 7 / 3 ms |
| Bounce time N/O contact/N/C contact | 0.5 / 3 ms |
| Category of protection (IEC 61810) | RT III - wash tight |
| Relay weight | 14 g |
| Packaging unit | 20 / 400 pcs. |
| Accessories | see accessories E |

Dimensions

Dimensions in mm

Vertical version

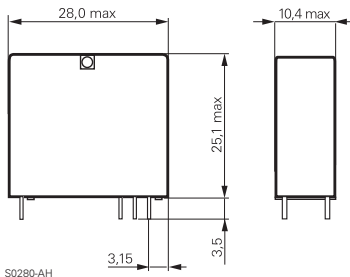

S0280-AH

Horizontal version

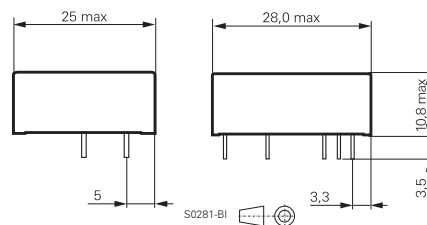

S0281-BI

PCB layout / terminal assignment

Vertical version

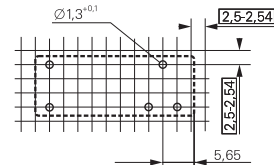

S0257-AH

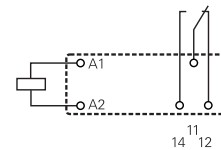

S0257-AB

Horizontal version

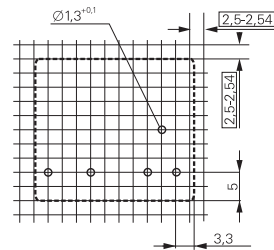

S0257-AI

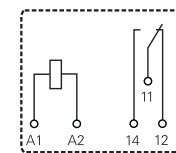

S0257-AE

View on solder pins
Dimensions in mm

Product key

V 2 3 0 5 7 - 0 - - - -

Type

Version

A horizontal **B** vertical

Version

0 standard

Coil

001 6 V **013** 48 V
002 12 V **023** 60 V
006 24 V

Contact type

A single contact **B** bifurcated contact (C/O only)

Contact material

1 AgNi0,15 **4** AgCdO
2 AgNi20

Contact configuration

01 1 C/O contact **02** 1 N/O contact

Other types on request

Power PCB Relay Card E

1 pole 8 A

| Product key | Version | Cont.type | Cont.material | Cont.config. | Coil | Part number |
|-------------------|------------|----------------|---------------|----------------|-----------|---------------|
| V23057-A0002-A101 | horizontal | single contact | AgNi 0.15 | 1 C/O contact | 12 Vdc | 0-1393215-4 |
| V23057-A0002-A401 | | | AgCdO | | | 0-1393215-9 |
| V23057-A0006-A101 | | | AgNi 0.15 | 1 N/O cont. | 24 Vdc | 2-1393215-1 |
| V23057-A0006-A401 | | | AgCdO | | | 2-1393215-5 |
| V23057-A0006-A402 | | | | | | 2-1393215-7 |
| V23057-A0013-A101 | | | AgNi 0.15 | 1 C/O contact | 48 Vdc | 3-1393215-8 |
| V23057-A0013-A401 | | | AgCdO | | | 4-1393215-0 |
| V23057-A0023-A101 | | | AgNi 0.15 | 1 C/O contact | 60 Vdc | 5-1393215-5 |
| V23057-A0023-A401 | | | AgCdO | | | 5-1393215-6 |
| V23057-B0002-A101 | | | vertical | single contact | AgNi 0.15 | 1 C/O contact |
| V23057-B0002-A401 | AgCdO | 7-1393215-1 | | | | |
| V23057-B0002-A402 | | 1 N/O cont. | | | | 7-1393215-2 |
| V23057-B0006-A101 | AgNi 0.15 | 1 C/O cont. | | | 24 Vdc | 7-1393215-5 |
| V23057-B0006-A102 | | 1 N/O cont. | | | | 7-1393215-9 |
| V23057-B0006-A401 | AgCdO | 1 C/O cont. | | | | 8-1393215-5 |
| V23057-B0006-A402 | | 1 N/O cont. | | | | 8-1393215-6 |
| V23057-B0013-A101 | AgNi 0.15 | 1 C/O contact | | | 48 Vdc | 9-1393215-4 |
| V23057-B0013-A401 | AgCdO | | | | | 9-1393215-6 |
| V23057-B0023-A101 | AgNi 0.15 | 1 C/O contact | | | 60 Vdc | 0-1393216-5 |
| V23057-B0023-A401 | AgCdO | | 0-1393216-6 | | | |

Power PCB Relay U/UB

1 pole 7 A, mono or bistable

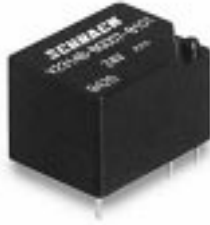

F0153-B

Features

- 1 C/O or 1 N/O or 1 N/C contact
- Bistable and DC-version
- Standard version with 230 mW pull-in power
- Sensitive version with 180 mW pull-in power
- Wash tight version
- Version for 10 A on request

Applications

Heating control, installation, battery powered equipment



Technical data of approved types on request

Contact data

| | |
|---|--|
| Configuration | 1 C/O, 1 N/O or 1 N/C contact |
| Type of contact | single contact |
| Rated current | 7 A standard and bistable 5 A sensitive |
| Rated voltage / max.breaking voltage AC | 250 Vac / 250 Vac |
| Maximum breaking capacity AC | 1750 VA standard and bistable 1250 VA sensitive |
| Make current (max. 4 s at duty cycle 10%) | 12 A |
| Contact material | AgNi 10 |

Contact ratings

| Type | Load | Operations |
|-----------------------|-------------------------|---------------------|
| standard and bistable | 7 A, 24 Vdc, resistive | 5x10 ⁴ |
| sensitive | 5 A, 24 Vdc, resistive | 3x10 ⁴ |
| standard and bistable | 7 A, 250 Vac, resistive | 5x10 ⁴ |
| standard | 5 A, 250 Vac, resistive | 1.5x10 ⁵ |
| sensitive | 5 A, 250 Vac, resistive | 1x10 ⁵ |
| bistable | 5 A, 250 Vac, resistive | 1x10 ⁵ |

Coil data

| | monostable | sensitive |
|--------------------|------------|-----------|
| Nominal voltage | 6...48 Vdc | |
| Nominal coil power | 3..24 Vdc | 450 mW |
| | 48 Vdc | 610 mW |
| Operate category | 1 / a | |

Coil versions, monostable

| Coil code | Nominal voltage Vdc | Pull-in voltage Vdc | Release voltage Vdc | Maximum voltage Vdc | Coil resistance Ω | Coil current mA |
|------------------|---------------------|---------------------|---------------------|---------------------|-------------------|-----------------|
| standard | | | | | | |
| 003 | 6 | 4.2 | 0.6 | 10.5 | 80±10% | 75.0 |
| 005 | 12 | 8.4 | 1.2 | 21.1 | 320±10% | 37.5 |
| 007 | 24 | 16.8 | 2.4 | 42.2 | 1280±10% | 18.8 |
| 008 | 48 | 33.6 | 4.8 | 72.4 | 3800±10% | 12.6 |
| sensitive | | | | | | |
| 103 | 6 | 4.4 | 0.6 | 12.6 | 110±10% | 54.6 |
| 105 | 12 | 8.8 | 1.2 | 25.3 | 440±10% | 27.3 |
| 107 | 24 | 17.5 | 2.4 | 50.6 | 1780±10% | 13.5 |
| 108 | 48 | 35.0 | 4.8 | 76.3 | 4000±10% | 12.0 |

All figures are given for coil without preenergization, at ambient temperature +20°C Other coil voltages on request

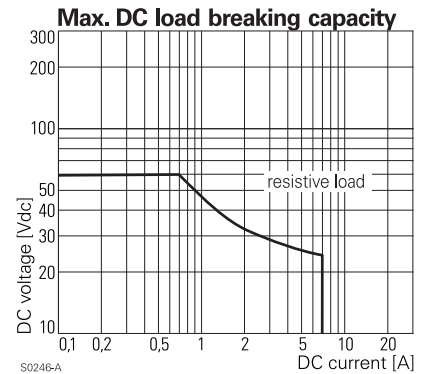

S0246-A

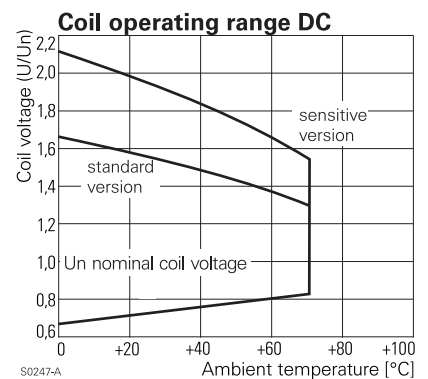

S0247-A

Power PCB Relay U/UB

1 pole 7 A, mono or bistable

| Coil data | bistable |
|------------------------------------|-----------------------|
| Nominal voltage | 6...48 Vdc |
| Operate power | 600...800 mW |
| Nominal energization power / -time | 900...1300 mW / 20 ms |
| Reset voltage min. | 25 % U_{nom} |
| Reset voltage max. | 45 % U_{nom} |

Bistable coil versions

| Coil code | Nominal voltage Vdc | Pull-in voltage Vdc | Reset voltage Vdc | Maximum voltage Vdc | Coil resistance Ω | Coil current mA |
|-----------|---------------------|---------------------|-------------------|---------------------|--------------------------|-----------------|
| 003 | 6 | 4.7 | 1.5 | 6.2 | $33 \pm 10\%$ | 181.8 |
| 005 | 12 | 9.4 | 3.0 | 12.4 | $119 \pm 10\%$ | 100.8 |
| 007 | 24 | 18.7 | 6.0 | 24.7 | $475 \pm 10\%$ | 50.5 |
| 008 | 48 | 37.4 | 12.0 | 49.4 | $1750 \pm 10\%$ | 27.4 |

All figures are given for coil without preenergization, at ambient temperature +20°C

Other coil voltages on request

Insulation

| | | |
|---|-----------------------------------|--|
| Dielectric strength | coil-contacts | 2000 V_{rms} version V23148-*0*** 4000 V_{rms} version V23148-*1*** |
| | open contact circuit | 1000 V_{rms} |
| Surge voltage resistance | coil-contacts | 5000 V_{rms} |
| Clearance / creepage | | 2.5 / 2.5 mm version V23148-*0*** 3.5 / 3.5 mm version V23148-*1*** |
| | Insulation to VDE 0110b (2/79) | |
| Insulation category / reference voltage | | B / 250 open contact circuit B / 125 contact/coil |
| | Tracking resistance of relay base | CTI 250 |

Other data

| | | |
|--|--|----------|
| Flammability class according to UL 94 | V-0 | |
| Ambient temperature | -25...+70 °C | |
| Mechanical life | 20×10^6 operations | |
| Max. switching rate at rated- / minimum load | $300 \text{ min}^{-1} / 10 \text{ min}^{-1}$ | |
| Operate- / release time | standard | 6 / 3 ms |
| | sensitive | 7 / 3 ms |
| Operate- / reset time | 5 / 3 ms | |
| Bounce time N/O contact/N/C contact | 2 / 10 ms | |
| Vibration resistance | 10 g, 10...55 Hz | |
| Shock resistance (function) | 10 g at 11 ms half sine | |
| Category of protection (IEC 61810) | RT III - wash tight | |
| Relay weight | 9.5 g | |
| Packaging unit | 25 / 500 pcs. | |

Dimensions

Dimensions in mm

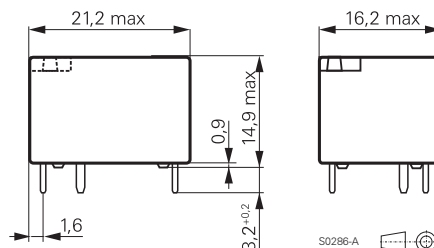

PCB layout / terminal assignment

View on solder pins
Dimensions in mm

Monostable and bistable 1 coil

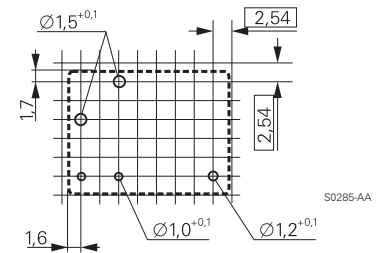

C/O contact

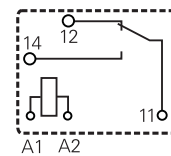

N/O contact

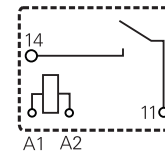

N/C contact

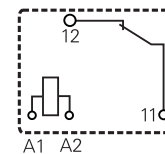

Low Profile PCB Relay PCD

1 pole 10 A



F0154-B

Features

- 1 N/O contact
- Low coil power 200 mW
- Height 10.2 mm
- Wash tight

Applications

Domestic appliances, coffee machines, irons, office equipment



Technical data of approved types on request

Contact data

| | |
|---|-------------------|
| Configuration | 1 N/O contact |
| Type of contact | single contact |
| Rated current | 10 A |
| Continuous thermal load | 15 A |
| Rated voltage / max.breaking voltage AC | 250 Vac / 250 Vac |
| Maximum breaking capacity AC | 2500 VA |
| Contact material | AgCdO |

Contact ratings

| | |
|------------|-------------------|
| Load | Operations |
| Rated load | 1x10 ⁵ |

Coil data

| | |
|--------------------|----------------|
| Nominal voltage | 6...24 Vdc |
| Nominal coil power | approx. 200 mW |

Coil versions

| Coil code | Nominal voltage Vdc | Pull-in voltage Vdc | Release voltage Vdc | Maximum voltage Vdc | Coil resistance Ω | Coil current mA |
|-----------|---------------------|---------------------|---------------------|---------------------|--------------------------|-----------------|
| 006 | 6 | 4.5 | 0.3 | 7.8 | 180 \pm 10% | 33.3 |
| 012 | 12 | 9.0 | 0.6 | 15.6 | 720 \pm 10% | 16.7 |
| 024 | 24 | 18.0 | 1.2 | 31.2 | 2880 \pm 10% | 8.3 |

All figures are given for coil without preenergization, at ambient temperature +20°C
Other coil voltages on request

Insulation

| | | |
|---|----------------------|-----------------------|
| Dielectric strength | coil-contacts | 2500 V _{rms} |
| | open contact circuit | 750 V _{rms} |
| Clearance / creepage | | 4 mm |
| Insulation to IEC 60664 | | |
| Voltage rating | | 250 V |
| Pollution degree | | 3 |
| Overvoltage category | | III |
| Insulation to VDE 0110b (2/79) | | |
| Insulation category / reference voltage | | C / 250 |

Electrical endurance

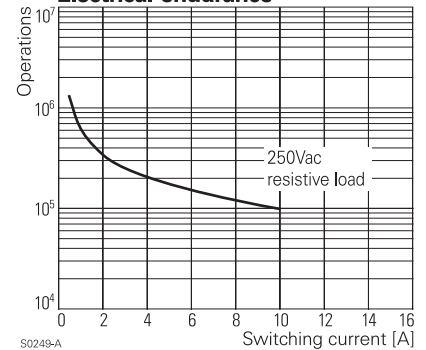

Coil operating range DC

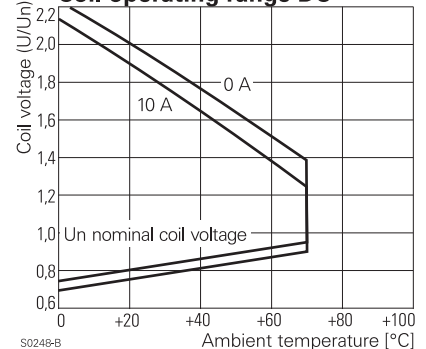

Low Profile PCB Relay PCD

1 pole 10 A

Other data

| | |
|--|--|
| Ambient temperature | -30...+70 °C |
| Mechanical life | >10x10 ⁶ operations |
| Max. switching rate at rated- / minimum load | 10 min ⁻¹ / 300 min ⁻¹ |
| Operate- / release time | 8 / 2 ms |
| Vibration resistance | 1.5 mm sine, 10...55 Hz |
| Shock resistance (function) | 10 g |
| Shock resistance (destruction) | 100 g |
| Category of protection (IEC 61810) | RT II - flux proof, RT III - wash tight |
| Relay weight | 9 g |
| Packaging unit | 1000 pcs. |

PCB layout / terminal assignment

View on solder pins

Dimensions in mm

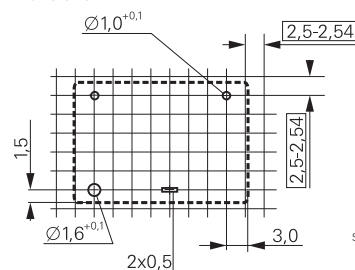

S0259-AA

Dimensions

Dimensions in mm

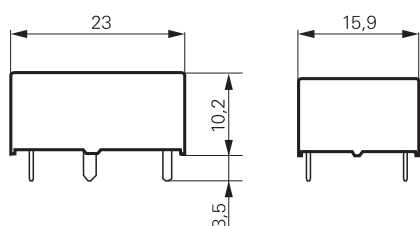

S0287-A

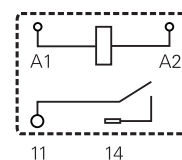

S0259-AB

Product key

P C D **1** **D** **1** **M**

Type

Number of contacts

1 1 N/O contact

Coil

6 6 V

12 12 V

24 24 V

Coil version

D standard 200 mW

Contact material

1 AgCdO

Contact configuration

M N/O contact

Version

- flux proof

H wash tight

Other types on request

| Product key | Version | Cont-material | Cont.configuration | Coil | Part number |
|--------------|----------------|---------------|--------------------|--------|-------------|
| PCD-105-D1MH | standard 200mW | AgCdO | 1 N/O contact | 5 Vdc | 3-1419126-6 |
| PCD-112-D1MH | washable | | | 12 Vdc | 4-1419126-2 |
| PCD-124-D1MH | | | | 24 Vdc | 4-1419126-8 |
| PCD-148-D1MH | | | | 48 Vdc | 0-1419146-7 |

Miniature Power PCB Relay PB

1pole 10 A



Features

- 1 C/O or 1 N/O contact
- Environmentally-friendly cadmium-free contacts
- Creepage/clearance to VDE 0435 and VDE 0700
- Class F coil available
- Compact and simple design gives high process security

Applications

White goods, small home appliances, heating temperature controllers

F0224-A



Technical data of approvals on request

Contact data

| | |
|---|---|
| Configuration | 1 C/O contact or 1 N/O contact |
| Type of contact | single contact |
| Rated current | C/O version: N/O 10 A; N/C 3 A N/O version: 10 A |
| Continuous thermal load | 10 A |
| Maximum switching voltage | 250 Vac / 100 Vdc |
| Maximum breaking capacity AC | 2500 VA |
| Make current (max. 4 s at duty cycle 10%) | 15 A |
| Contact material | AgNi 90/10 |

Contact ratings

| Type | Load | Operations |
|-------------|--------------------|---------------------|
| N/O contact | 10 A, 85 °C | 25x10 ³ |
| N/O contact | 6 A, 85 °C | 100x10 ³ |
| C/O contact | 10 A / 3 A, 85 °C | 25x10 ³ |
| C/O contact | 10 A / 10 A, 85 °C | 1x10 ³ |

Coil data

| | |
|----------------------|-----------------------|
| Nominal voltage | 5, 6, 12, 24 Vdc |
| Nominal coil power | 360 mW |
| Operate power | 200 mW |
| Operate category | 2 / c |
| Operate voltage max. | 75 % U _{nom} |
| Non-release voltage | 50 % U _{nom} |
| Release voltage min. | 10 % U _{nom} |

Coil versions, DC-coil

| Coil code | Nominal voltage Vdc | Pull-in voltage Vdc | Release voltage Vdc | Coil resistance Ω | Coil current mA |
|-----------|---------------------|---------------------|---------------------|-------------------|-----------------|
| 006 | 6 | 4.5 | 0.6 | 100±10% | 60.0 |
| 012 | 12 | 9 | 1.2 | 400±10% | 30.0 |
| 024 | 24 | 18 | 2.4 | 1600±10% | 15.0 |

All figures are given for coil without preenergization, at ambient temperature +20°C
Other coil voltages on request

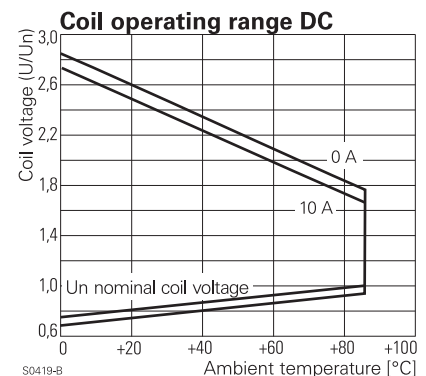
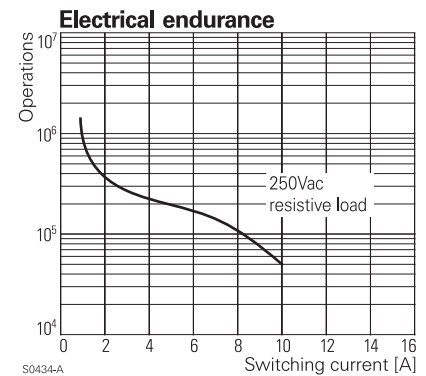
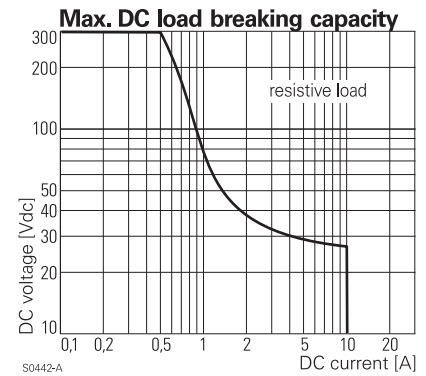

Miniature Power PCB Relay PB

1pole 10 A

| Insulation | | |
|---|----------------------|-----------------------|
| Dielectric strength | coil-contacts | 2500 V _{rms} |
| | open contact circuit | 1000 V _{rms} |
| Surge voltage resistance coil-contacts | | 4000 V _{rms} |
| Clearance / creepage | | 3 / 4 mm |
| Insulation to IEC 60664 | | |
| Voltage rating | | 250 V |
| Pollution degree | | 3 |
| Overtoltage category | | III |
| Insulation to VDE 0110b (2/79) | | |
| Insulation category / reference voltage | | C / 250 |
| Insulation resistance | | 100x10 ⁶ |
| Tracking resistance of relay base | PB1...CTI 250 | |
| | PB3...CTI 300 | |

| Other data | |
|--|--|
| Flammability class according to UL 94 | V-0 |
| Coil insulation system according to UL 1446 | Class F |
| Ambient temperature | -40...+85 °C (105 °C) |
| Mechanical life | > 5x10 ⁶ operations |
| Max. switching rate at rated- / minimum load | 60 min ⁻¹ / 600 min ⁻¹ |
| Operate- / release time | < 20 ms |
| Bounce time | < 15 ms |
| Vibration resistance 30...400 Hz | >4 g |
| Shock resistance (destruction) | >30 g |
| Category of protection (IEC 61810) | RT II - flux proof |
| Relay weight | 5.4 g |
| Soldering temperature / time, IEC 68-2-20 | max. 260 °C / 5s |
| Packaging unit | 35 / 1050 pcs. |

PCB layout / terminal assignment

View on solder pins
Dimensions in mm

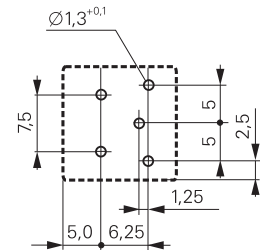

S0407-AA

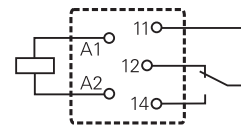

S0407-AB

Dimensions

Dimensions in mm

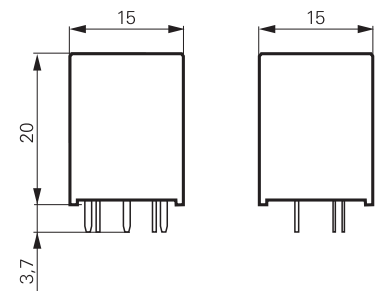

S0406-A

Product key

Type

Version

- 1** standard version, CTI 250
- 3** high CTI version, CTI 300

Contacts

- 1** 1 C/O contact
- 3** 1 N/O contact

Contact material

- 4** AgNi 90/10

Coil

Coil code: please refer to coil versions table

Other types on request

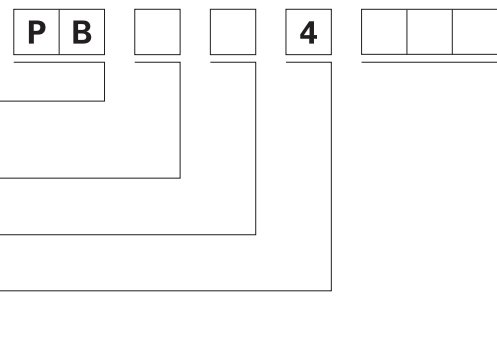

| Product key | Version | Contacts | Contact material | Coil | Part number |
|-------------|-----------------------------|---------------|------------------|-------------|-------------|
| PB114005 | standard CTI 250 | 1 C/O contact | AgNi 90/10 | 5 Vdc | 6-1415029-1 |
| PB114006 | | | | 6 Vdc | 7-1415029-1 |
| PB114012 | | | | 12 Vdc | 8-1415029-1 |
| PB114024 | | | | 24 Vdc | 9-1415029-1 |
| PB134005 | high CTI version CTI 300 | 1 N/O contact | 5 Vdc | 0-1415030-1 | |
| PB134006 | | | 6 Vdc | 1-1415030-1 | |
| PB134012 | | | 12 Vdc | 2-1415030-1 | |
| PB134024 | | | 24 Vdc | 3-1415030-1 | |
| PB314005 | | 1 C/O contact | 5 Vdc | 4-1415030-1 | |
| PB314006 | | | 6 Vdc | 5-1415030-1 | |
| PB314012 | | | 12 Vdc | 6-1415030-1 | |
| PB314024 | | | 24 Vdc | 7-1415030-1 | |
| PB334005 | 1 N/O contact | 5 Vdc | 8-1415030-1 | | |
| PB334006 | | 6 Vdc | 9-1415030-1 | | |
| PB334012 | | 12 Vdc | 0-1415031-1 | | |
| PB334024 | | 24 Vdc | 1-1415031-1 | | |

Miniature Power PCB Relay PBH 105°C

1pole 6 A



Features

- 1 C/O or 1 N/O contact
- Environmentally-friendly cadmium-free contacts
- Creepage/clearance to VDE 0435 and VDE 0700
- Class F coil standard
- For ambient temperatures up to 105°C

Applications

White goods, domestic appliances

F0224-BBC



Technical data of approvals on request

Contact data

| | |
|----------------------------------|--|
| Configuration | 1 C/O contact or 1 N/O contact |
| Type of contact | single contact |
| Rated current | 6 A (mounting distance 3 mm) 4 A (closely packed) |
| Continuous thermal load to 105°C | 6 A |
| Maximum switching voltage | 250 Vac |
| Maximum breaking capacity AC | 1500 VA |
| Contact material | AgNi 90/10 |

Contact ratings

| Type | Load | Operations |
|-------------|---------------------|---------------------|
| N/O contact | 2 A, 240 Vac, 105°C | 250x10 ³ |
| N/O contact | 5 A, 250 Vac, 105°C | 150x10 ³ |
| N/O contact | 6 A, 250 Vac, 105°C | 100x10 ³ |

Coil data

| | |
|----------------------|-----------------------------|
| Nominal voltage | 5...36 Vdc |
| Nominal coil power | 360 mW |
| Operate power | 200 mW |
| Operate category | 90...100 % U _{nom} |
| Non-release voltage. | 50 % U _{nom} |
| Release voltage min. | 10 % U _{nom} |

Coil versions, DC-coil

| Coil code | Nominal voltage Vdc | Pull-in voltage Vdc | Release voltage Vdc | Coil resistance Ω | Coil current mA |
|-----------|---------------------|---------------------|---------------------|-------------------|-----------------|
| 005 | 5 | 3.75 | 0.5 | 70±10% | 72.0 |
| 006 | 6 | 4.5 | 0.6 | 100±10% | 60.0 |
| 009 | 9 | 6.75 | 0.9 | 225±10% | 40.0 |
| 012 | 12 | 9.0 | 1.2 | 400±10% | 30.0 |
| 024 | 24 | 18.0 | 2.4 | 1600±10% | 15.0 |
| 036 | 36 | 27.0 | 3.6 | 3600±10% | 10.0 |

All figures are given for coil without preenergization, at ambient temperature +20°C

Other coil voltages on request

Miniature Power PCB Relay PBH 105°C

1pole 6 A

| Insulation | | |
|---|----------------------|------------------------------------|
| Dielectric strength | coil-contacts | 2500 V _{rms} |
| | open contact circuit | 1000 V _{rms} |
| Surge voltage resistance coil-contacts | | 4000 V _{rms} (1.2 / 50µs) |
| Clearance / creepage | | 3 / 4 mm |
| Insulation to IEC 60664 | | |
| Voltage rating | | 250 V |
| Pollution degree | | 3 |
| Overvoltage category | | III |
| Insulation to VDE 0110b (2/79) | | |
| Insulation category / reference voltage | | C / 250 |
| Insulation resistance | | 100x10 ⁶ Ω |
| Tracking resistance of relay base | | > CTI 250 |

| Other data | |
|--|--|
| Flammability class according to UL 94 | V-0 |
| Coil insulation system according to UL 1446 | Class F |
| Ambient temperature | -20...+105 °C |
| Mechanical life | > 2x10 ⁶ operations |
| Max. switching rate at rated- / minimum load | 60 min ⁻¹ / 600 min ⁻¹ |
| Operate- / release time max. | < 20 ms |
| Bounce time N/O contact / N/C contact typ. | < 15 ms |
| Vibration resistance 30...400 Hz | > 4 g |
| Shock resistance (destruction) | > 30 g |
| Category of protection (IEC 61810) | RT II - flux proof |
| Relay weight | 5.4 g |
| Soldering temperature / time, IEC 68-2-20 | max. 260 °C / 5s |
| Packaging unit | 35 / 1050 pcs. |

PCB layout / terminal assignment

View on solder pins
Dimensions in mm

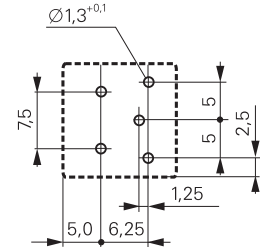

S0407-AA

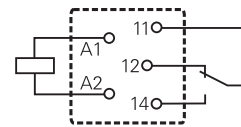

S0407-AB

Dimensions

Dimensions in mm

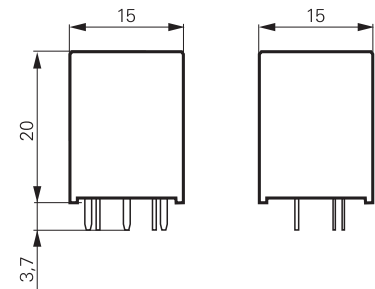

S0406-A

Product key

| | | | | | |
|------------------------|--|------------------------|----------|--|--|
| Type | P B | H | 4 | | |
| Version | H High temperature version | | | | |
| Contacts | 1 1 C/O contact | 3 1 N/O contact | | | |
| Contact material | 4 AgNi 90/10 | | | | |
| Coil | Coil code: please refer to coil versions table | | | | |
| Other types on request | | | | | |

| Product key | Version | Contacts | Contact material | Coil | Part number |
|-------------|-------------|---------------|------------------|--------|-------------|
| PBH14005 | high | 1 C/O contact | AgNi 90/10 | 5 Vdc | 9-1415356-1 |
| PBH14006 | temperature | | | 6 Vdc | 8-1415356-1 |
| PBH14009 | version | | | 9 Vdc | 7-1415356-1 |
| PBH14012 | | | | 12 Vdc | 6-1415356-1 |
| PBH14024 | | | | 24 Vdc | 6-1415355-1 |
| PBH34005 | | 1 N/O contact | | 5 Vdc | 5-1415356-1 |
| PBH34006 | | | | 6 Vdc | 4-1415356-1 |
| PBH34009 | | | | 9 Vdc | 3-1415356-1 |
| PBH34012 | | | | 12 Vdc | 2-1415356-1 |
| PBH34024 | | | | 24 Vdc | 1-1415356-1 |

Miniature Power PCB Relay T7N / T7N-WG

1pole 10A



F0189-B

Features

- 1C/O or 1N/O contact
- Creepage/clearance to VDE 0435 and VDE 0700
- Sensitive 360mW coil available
- Creepage/clearance to VDE 0435
- Version T7N-WG with tracking resistance CTI 325

Applications

Domestic appliances, heating control, building control, measurement&control

T7N: 

T7N-WG: 

Technical data of approved types on request

| Contact data | T7N | T7N-WG |
|---|--------------------------------|--------|
| Configuration | 1 C/O contact or 1 N/O contact | |
| Type of contact | single contact | |
| Rated current N/O contact / N/C contact | 10 / 5 A | |
| Continuous thermal load | 10 A | |
| Rated voltage / max.breaking voltage AC | 250 Vac / 250 Vac | |
| Maximum breaking capacity AC | 2500 VA | |
| Make current (max. 4 s at duty cycle 10%) | 35 A | |
| Contact material | AgCdO, AgSnO ₂ | AgCdO |

Contact ratings

| Type | Load | Operations |
|-------|-------------------------------|---------------------|
| AgCdO | 10 A, 240 Vac | 100x10 ³ |
| AgCdO | 5 A, 240 Vac, resistive | 2x10 ⁵ |
| AgCdO | 2 A, 120 Vac, cosφ=0.5, 60 °C | 1.4x10 ⁶ |

| Coil data | T7N standard | T7N-WG | T7N-WG sensitive |
|----------------------|-----------------------|-----------------------|-----------------------|
| Nominal voltage | 6...48 Vdc | 6...36 Vdc | 6...36 Vdc |
| Nominal coil power | 360 mW | 450 mW | 360 mW |
| Operate power | 176 mW | 253 mW | 176 mW |
| Operate category | 1 / c | 2 / b | 2 / b |
| Operate voltage max. | 70 % U _{nom} | 70 % U _{nom} | 70 % U _{nom} |
| Non-release voltage | 50 % U _{nom} | 50 % U _{nom} | 50 % U _{nom} |
| Release voltage min. | 10 % U _{nom} | 10 % U _{nom} | 10 % U _{nom} |

Coil versions

| Coil code | Nominal voltage Vdc | Pull-in voltage Vdc | Release voltage Vdc | Maximum voltage Vdc | Coil resistance Ω | Coil current mA |
|--|---------------------|---------------------|---------------------|---------------------|-------------------|-----------------|
| version T7N-WG | | | | | | |
| 12 | 12 | 8.4 | 1.2 | 25.0 | 320±10% | 37.5 |
| 24 | 24 | 16.8 | 2.4 | 50.0 | 1280±10% | 18.8 |
| 36 | 36 | 25.2 | 3.6 | 73.0 | 2880±10% | 12.5 |
| version T7N standard and T7N-WG sensitive | | | | | | |
| 06 | 6 | 4.2 | 0.6 | 12.5 | 100±10% | 60.0 |
| 12 | 12 | 8.4 | 1.2 | 25.0 | 400±10% | 30.0 |
| 24 | 24 | 16.8 | 2.4 | 50.0 | 1600±10% | 15.0 |
| 36 | 36 | 25.2 | 3.6 | 73.0 | 3600±10% | 10.0 |
| 48 | 48 | 33.6 | 4.8 | 100.0 | 6400±10% | 7.0 |

All figures are given for coil without preenergization, at ambient temperature +20°C
Other coil voltages on request

Max. DC load breaking capacity

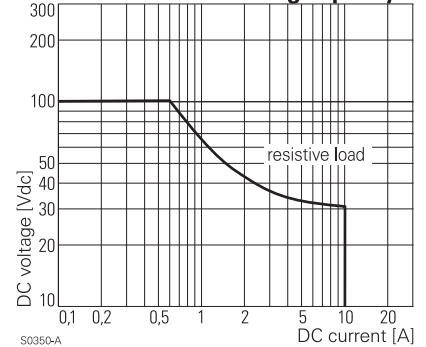

S0350-A

Electrical endurance

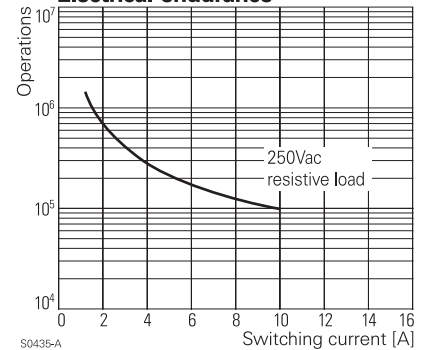

S0435-A

Coil operating range DC

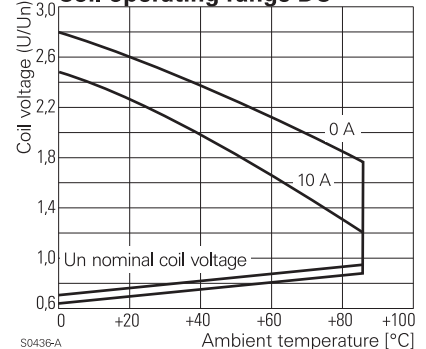

S0436-A

Miniature Power PCB Relay T7N / T7N-WG

1pole 10A

| Insulation | T7N | T7N-WG |
|---|--|--|
| Dielectric strength | coil-contacts open contact circuit | 2000 V _{rms} 1000 V _{rms} |
| Surge voltage resistance | coil-contacts 4000 V _{rms} (1.2 / 50µs) | |
| Clearance / creepage | 2 / 3 mm | 3 / 4 mm |
| Insulation to IEC 60664 | | |
| Voltage rating | 250 V | |
| Pollution degree | 3 | |
| Overvoltage category | III | |
| Insulation to VDE 0110b (2/79) | | |
| Insulation category / reference voltage | C / 250 | |
| Insulation resistance | 100x10 ⁶ Ω | |
| Tracking resistance of relay base | CTI 225 | CTI 325 |

| Other data | |
|--|--|
| Flammability class according to UL 94 | V-0 |
| Ambient temperature | -40...+85 °C (105 °C) |
| Mechanical life | 10x10 ⁶ operations |
| Max. switching rate at rated- / minimum load | 30 min ⁻¹ / 300 min ⁻¹ |
| Operate- / release time | 10 / 5 ms |
| Bounce time N/O contact / N/C contact | 0.6 / 17 ms |
| Vibration resistance | >10 g |
| Shock resistance (function) | >10 g |
| Shock resistance (destruction) | >100 g |
| Category of protection (IEC 61810) | RT III - wash tight |
| Relay weight | 11 g |
| Packaging unit | 500 pcs. |

PCB layout / terminal assignment

View on solder pins
Dimensions in mm

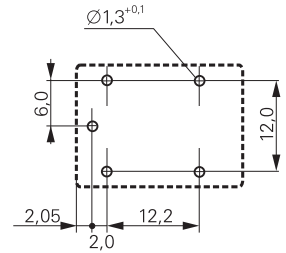

S0260-AA

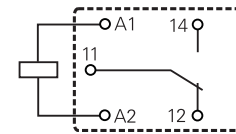

S0260-AB

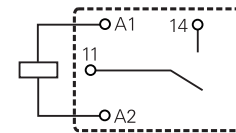

S0260-AC

Dimensions

Dimensions in mm

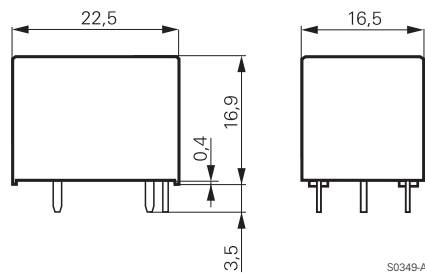

S0349-A

Product key



Type

Version

S wash tight

Contacts

1 1 N/O contact

5 1 C/O contact

Coil version

H DC coil 450mW

D DC coil 360mW

Contact material

1 AgCdO

4 AgSnO₂ (T7N standard version only)

Coil

coil code: please refer to coil versions table

Version

Blank

T7N standard version

WG-A

version for domestic appliances

Other types on request

Miniature Power PCB Relay T7N / T7N-WG

1pole 10A

| Product key | Version | Cont-material | Cont.configuration | Coil | Part number |
|-----------------|-----------------------|---------------|--------------------|--------|-------------|
| T7N S1D1-06 | wash tight CTI 225 | AgCdO | 1 N/O contact | 6 Vdc | 0-1393186-3 |
| T7N S1D1-12 | | | | 12 Vdc | 5-1440006-4 |
| T7N S1D1-24 | | | | 24 Vdc | 5-1440006-6 |
| T7N S1D1-48 | | | | 48 Vdc | 5-1440006-8 |
| T7N S1D4-06 | | AgSnO | | 6 Vdc | 6-1440005-2 |
| T7N S1D4-12 | | | | 12 Vdc | 7-1440006-2 |
| T7N S1D4-24 | | | | 24 Vdc | 7-1440006-4 |
| T7N S1D4-48 | | | | 48 Vdc | 7-1440006-6 |
| T7N S5D1-06 | | AgCdO | 1 C/O contact | 6 Vdc | 4-1440006-2 |
| T7N S5D1-12 | | | | 12 Vdc | 4-1440006-4 |
| T7N S5D1-24 | | | | 24 Vdc | 4-1440006-7 |
| T7N S5D1-48 | | | | 48 Vdc | 4-1440006-9 |
| T7N S5D4-06 | | AgSnO | | 6 Vdc | 6-1440006-1 |
| T7N S5D4-12 | | | | 12 Vdc | 6-1440006-3 |
| T7N S5D4-24 | | | | 24 Vdc | 6-1440006-5 |
| T7N S5D4-48 | | | | 48 Vdc | 6-1440006-7 |
| T7NS5H1-06-WG-A | wash tight CTI 325 | AgCdO | | 6 Vdc | 7-1440006-9 |
| T7NS5H1-12-WG-A | | | | 12 Vdc | 8-1440006-0 |
| T7NS5H1-24-WG-A | | | | 24 Vdc | 8-1440006-2 |
| T7NS5H1-36-WG-A | | | | 36 Vdc | 8-1440006-3 |
| T7NS5H1-48-WG-A | | | | 48 Vdc | 8-1440006-4 |

Power Relay T9A

1 pole 30 A



F0156-A



F0179-A

Features

- 1 N/O or 1 C/O contact
- High breaking capacity 7500 VA
- PCB- and PCB/Faston connections
- Chassis mount version with faston terminals
- UL-class F as standard
- Ambient temperature 85°C
- Open version available

Applications

HVAC, power supplies, domestic appliances, measurement&control



Technical data of approved types on request

Contact data

| | | |
|---|---------------------|---------------|
| Configuration | 1 C/O contact | 1 N/O contact |
| Type of contact | single contact | |
| Rated current on the N/O- N/C contact | 20 A / 10 A | 25 A |
| Rated voltage / max.breaking voltage AC | 240 Vac / 250 Vac | |
| Maximum breaking capacity AC | 4800 VA | 7200 VA |
| Contact material | AgCdO | |
| Minimum contact load | 1 A, 5 Vdc / 12 Vac | |

Contact ratings

| Type | Load | Operations | Standard |
|-------------|-------------------------------|-------------------|----------|
| N/O contact | 2 hp, 240 Vac, motor | 6x10 ³ | UL 508 |
| N/O contact | 5.4 A, 240 Vac, halogen | 6x10 ³ | UL 508 |
| N/O contact | 25 A, 240 Vac, resistive | 1x10 ⁵ | |
| C/O contact | 10 / 10 A, 240 Vac, resistive | 1x10 ⁵ | |
| C/O contact | 20 / 10 A, 28 Vdc, resistive | 1x10 ⁵ | |

Coil data

| | |
|--------------------|------------|
| Nominal voltage | 6...48 Vdc |
| Nominal coil power | 1 W |

Coil versions

| Coil code | Nominal voltage Vdc | Pull-in voltage Vdc | Release voltage Vdc | Maximum voltage Vdc | Coil resistance Ω | Coil current mA |
|-----------|---------------------|---------------------|---------------------|---------------------|-------------------|-----------------|
| 6 | 6 | 4.5 | 0.6 | 10.0 | 36±10% | 166.7 |
| 12 | 12 | 9.0 | 1.2 | 20.1 | 144±10% | 83.3 |
| 24 | 24 | 18.0 | 2.4 | 40.2 | 576±10% | 41.7 |
| 48 | 48 | 36.0 | 4.8 | 80.3 | 2304±10% | 20.8 |

All figures are given for coil without preenergization, at ambient temperature +20°C

Other coil voltages on request

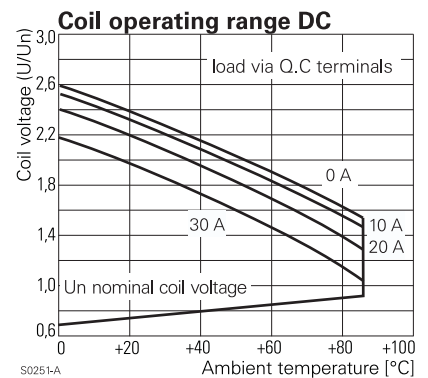
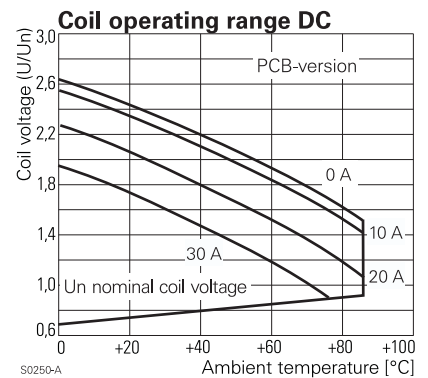

Power Relay T9A

1 pole 30 A

Insulation

| | | |
|--------------------------|----------------------|-------------------------------------|
| Dielectric strength | coil-contacts | 2500 V _{rms} |
| | open contact circuit | 1500 V _{rms} |
| Surge voltage resistance | coil-contacts | 6000 V _{rms,r} , 1.2/50 μs |
| Clearance / creepage | | 3.1 / 6.3 mm (UL508) |

Other data

| | |
|---------------------------------------|-------------------------------|
| Flammability class according to UL 94 | V-0 |
| Ambient temperature | -40...+85 °C |
| Mechanical life | 10x10 ⁶ operations |
| Vibration resistance | 1.65 mm, 10...55 Hz |
| Shock resistance (function) | 10 g at 11 ms half sine |
| Shock resistance (destruction) | 100 g |
| Category of protection (IEC 61810) | RT III - wash tight |
| Relay weight | 26 / 33 g |
| Packaging unit | 250 pcs. |

Dimensions

Dimensions in mm

PCB version

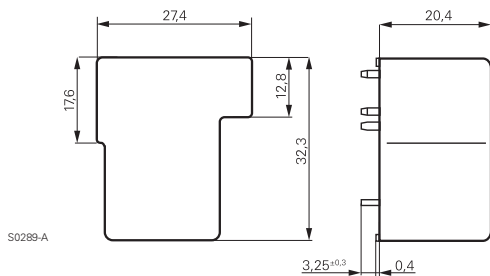

PCB-/Faston version

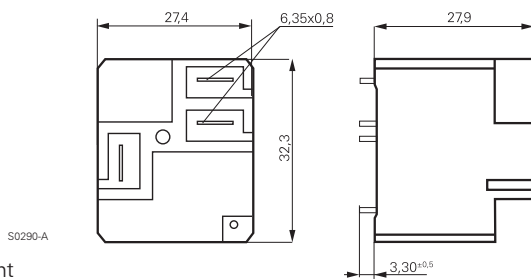

Flange mount

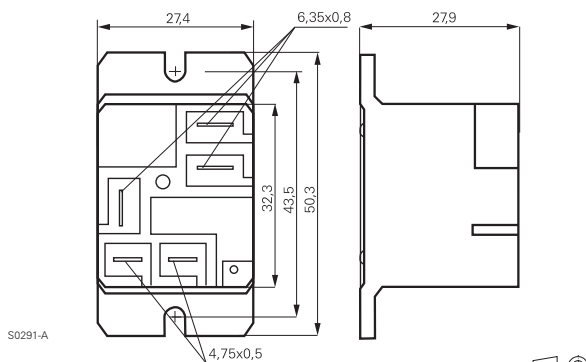

PCB layout / terminal assignment

View on solder pins
Dimensions in mm

PCB version

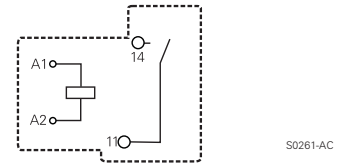
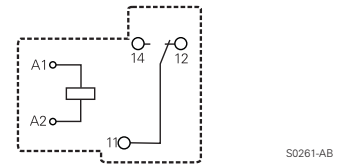
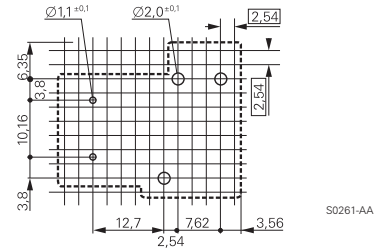

PCB-/Faston version

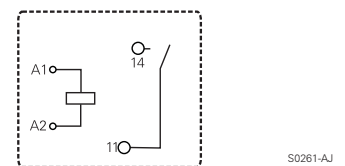
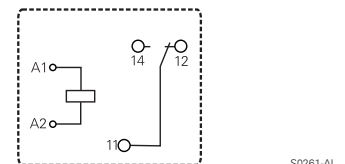
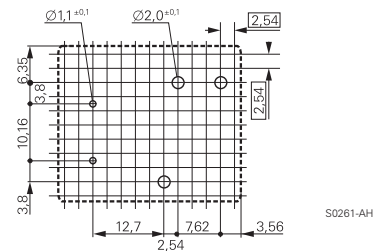

Power Relay T9A

1 pole 30 A

Product key

| | | | | | | | | | |
|---|---|---|--|--|---|--|---|--|--|
| T | 9 | A | | | D | | 2 | | |
|---|---|---|--|--|---|--|---|--|--|

Type

Enclosure

- P** dust protected (flange mount)
- S** wash tight (PCB- or PCB-/Faston-version)

Contact configuration

- 1** N/O contact
- 5** C/O contact

Coil version

- D** DC coil 1 Watt

Mounting

- 1** PCB-version
- 2** PCB-terminals for coil and contacts, Faston terminals for contacts
- 5** Flange mount, 4.75 Faston terminals for coil, 6.35 Faston terminal for contacts

Contact material

- 2** AgCdO

Coil

Coil code: please refer to coil versions table

Other types on request

| Product key | Version | Cont-material | Cont.configuration | Coil | Part number |
|-------------|------------------|---------------|--------------------|--------|-------------|
| T9AS1D12-12 | pcb-version | AgCdO | 1 N/O contact | 12 Vdc | 1-1393210-3 |
| T9AS1D12-18 | wash tight | | | 18 Vdc | 1-1393210-5 |
| T9AS1D22-12 | pcb terminals | | | 12 Vdc | 1-1419104-7 |
| T9AS1D22-24 | Faston terminals | | | 24 Vdc | 2-1419104-1 |
| T9AS5D22-12 | for contacts | | 1 C/O contact | 12 Vdc | 3-1419104-3 |
| T9AS5D22-24 | wash tight | | | 24 Vdc | 3-1419104-6 |

Power Relay T92

2 pole 30 A, DC- and AC-coil



F0167-A

Features

- 2 C/O or 2 N/O contacts
- Switching capacity 7500 VA (2 N/O)
- DC- or AC coil
- 4 kV / 8 mm coil-contact
- Insulation to VDE 0631 and VDE 0700
- PCB- or Faston connections or chassis mount
- Adapter for DIN-rail mounting

Applications

Power supplies, heating & ventilation, control equipment



Technical data of approved types on request

Contact data

| | |
|---|--------------------------------|
| Configuration | 2 C/O contact or 2 N/O contact |
| Type of contact | single contact |
| Rated current N/O contact/N/C contact | 30 / 3 A |
| Rated voltage / max.breaking voltage AC | 250 Vac / 440 Vac |
| Maximum breaking capacity AC | 7500 VA |
| Contact material | AgCdO |
| Minimum contact load | 500 mA, 12 Vac |

Contact ratings

| Type | Load | Operations |
|---------|------------|-------------------|
| AC-coil | rated load | 1x10 ⁵ |
| DC-coil | rated load | 3x10 ⁵ |

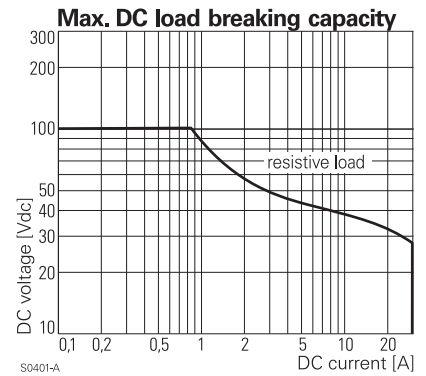

Coil data

| Nominal voltage | DC coil | 6...48 Vdc |
|--------------------|---------|--------------|
| Nominal voltage | AC coil | 24...240 Vac |
| Nominal coil power | DC coil | 1.7 W |
| | AC coil | 4.0 VA |
| Operate category | | 1 / a |

DC Coil versions

| Coil code | Nominal voltage Vdc | Pull-in voltage Vdc | Release voltage Vdc | Maximum voltage Vdc | Coil resistance Ω | Coil current mA |
|-----------|---------------------|---------------------|---------------------|---------------------|-------------------|-----------------|
| 12 | 12 | 9.0 | 1.2 | 22.2 | 86±10% | 139.5 |
| 24 | 24 | 18.0 | 2.4 | 44.4 | 350±10% | 68.6 |

All figures are given for coil without preenergization, at ambient temperature +20°C

Other coil voltages on request

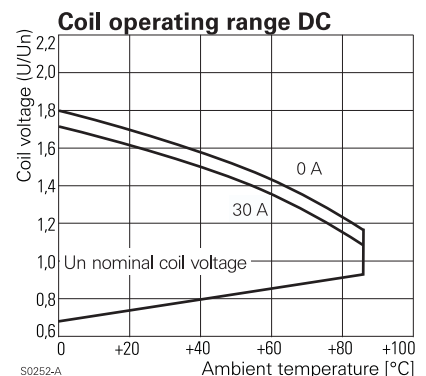

Power Relay T92

2 pole 30 A, DC- and AC-coil

AC Coil versions

| Coil code | Nominal voltage Vac | Pull-in voltage Vac | Release voltage Vac | Maximum voltage Vac | DC-Coil resistance Ω |
|-----------|---------------------|---------------------|---------------------|---------------------|-----------------------------|
| 24 | 24 | 19.2 | 2.4 | 11.1 | 44 \pm 10% |
| 240 | 220 / 240 | 192.0 | 24.0 | 22.2 | 3800 \pm 10% |

All figures are given for coil without preenergization, at ambient temperature +20°C
Other coil voltages on request

Insulation

| | | |
|---|----------------------|----------------|
| Dielectric strength | coil-contacts | 4000 V_{rms} |
| | open contact circuit | 1500 V_{rms} |
| | adjacent contacts | 2000 V_{rms} |
| Clearance / creepage | | 8 / 9.5 mm |
| Insulation to VDE 0110b (2/79) | | |
| Insulation category / reference voltage | | C / 380 |
| Tracking resistance of relay base | | PTI 100 |

Other data

| | |
|--|--|
| Flammability class according to UL 94 | V-0 |
| Ambient temperature | DC-coil -40...+85 °C AC-coil -40...+65 °C |
| Mechanical life | 5x10 ⁶ operations |
| Max. switching rate at rated- / minimum load | 14 min ⁻¹ |
| Operate- / release time | 15 / 10 ms |
| Vibration resistance | 1.65 mm, 10...55 Hz |
| Shock resistance (function) | 10g, 11 ms half sine |
| Shock resistance (destruction) | 100g, 11 ms half sine |
| Category of protection (IEC 61810) | RT I - dust protected, RT III - wash tight |
| Relay weight | 86 g |
| Packaging unit | 30 pcs. |

Coil operating range AC

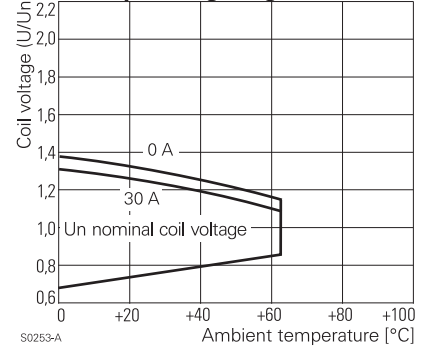

PCB layout / terminal assignment

View on solder pins
Dimensions in mm

PCB version

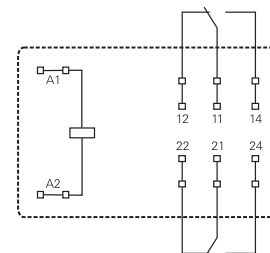
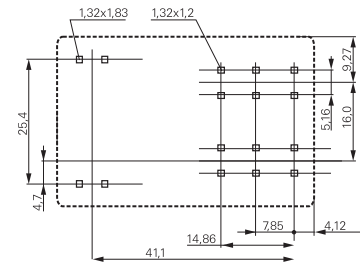

Dimensions

Dimensions in mm

PCB version

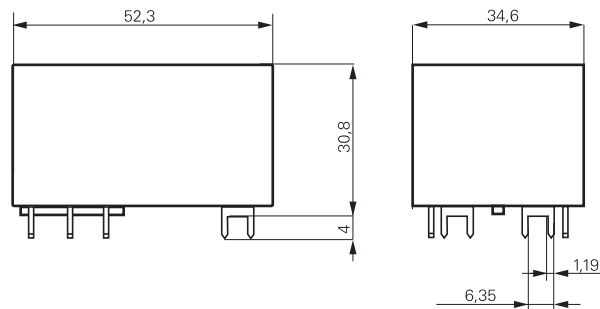

Power Relay T92

2 pole 30 A, DC- and AC-coil

Dimensions

Dimensions in mm

Flange mount

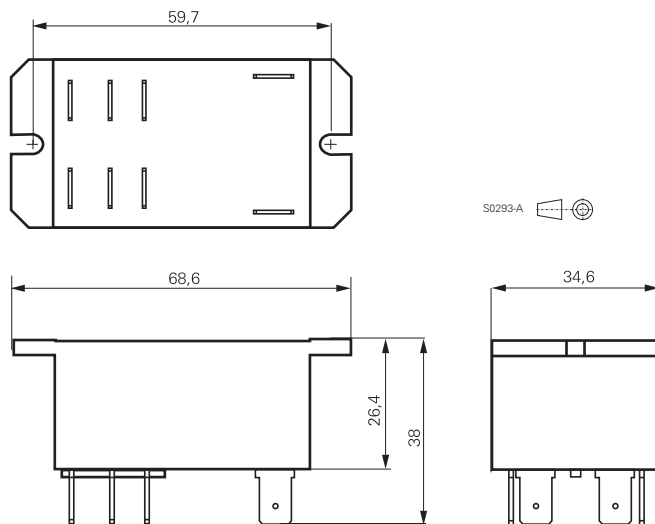

Product key

T 9 2 **2**

Type

Enclosure

P dust protected

S wash tight (PCB version only)

Contact configuration

7 2 N/O contacts

11 2 C/O contacts

Coil version

A AC-coil 50/60 Hz

D DC-coil

Mounting

1 PCB version

2 flange mount, 6.35 Faston terminals for contacts and coil

Contact material

2 AgCdO

Coil

Coil code: please refer to coil versions table

Other types on request

| Product key | Version | Mounting | Cont.configuration | Coil | Coil | Part number |
|---------------|----------------|--------------|--------------------|---------|---------|-------------|
| T92P7A22-240 | dust protected | flange mount | 2 N/O contacts | AC-coil | 240 Vac | 6-1393211-2 |
| T92P7D22-12 | | | | DC-coil | 12 Vdc | 6-1393211-9 |
| T92P7D22-24 | | | | | 24 Vdc | 7-1393211-1 |
| T92S11A22-240 | wash tight | | 2 C/O contacts | AC-coil | 240 Vac | 8-1393211-7 |
| T92S11D12-24 | | pcb-version | | DC-coil | 24 Vdc | 9-1393211-0 |
| T92S7A12-240 | | | 2 N/O contacts | AC-coil | 240 Vac | 9-1393211-9 |
| T92S7A22-240 | | flange mount | | | 240 Vac | 0-1393212-5 |
| T92S7D12-24 | | pcb-version | | DC-coil | 24 Vdc | 1-1393212-0 |

Power Relay 430 3 mm

1 pole 16 A, DC- and AC-coil



F0256-A

Features

- 1 N/O contact
- Safety mains isolation
- Contact gap > 3 mm
- 4 kV / 8 mm coil-contact, protection class II (VDE 0700)
- PCB mounting or Faston connectors
- Mounting brackets or snap mounting
- Version with arc blow magnet for high DC-loads

Applications

Domestic appliances, industrial appliances, industrial controls



Technical data of approved types on request

Contact data

| | |
|---|-------------------|
| Configuration | 1 N/O contact |
| Type of contact | single contact |
| Rated current | 16 A |
| Rated voltage / max.breaking voltage AC | 250 Vac / 400 Vac |
| Maximum breaking capacity AC | 4000 VA |
| Make current (max. 4 s at duty cycle 10%) | 25 A |
| Contact material | AgCdO, AgCu3 |
| Contact gap | >3 mm |

Contact ratings

| Type | Load | Operations |
|-------|----------------------------------|---------------------|
| 430x5 | 16 A, 250 Vac, resistive, 70 °C | 1.5x10 ⁵ |
| 430x5 | 10 A, 250 Vac, resistive, 105 °C | 1.5x10 ⁵ |

Coil data

| | | |
|--------------------|---------|-------------|
| Nominal voltage | DC coil | 6...110 Vdc |
| | AC coil | 6...240 Vac |
| Nominal coil power | DC coil | 1 W |
| | AC coil | 1.8 VA |
| Operate category | | 2 / b |

Coil versions, DC coil

| Coil code | Nominal voltage Vdc | Pull-in voltage Vdc | Release voltage Vdc | Maximum voltage Vdc | Coil resistance Ω | Coil current mA |
|-----------|---------------------|---------------------|---------------------|---------------------|-------------------|-----------------|
| 09 | 12 | 7.8 | 0.6 | 15.6 | 145±10% | 83.0 |
| 10 | 24 | 15.6 | 1.2 | 31.2 | 580±10% | 41.0 |
| 11 | 48 | 31.2 | 2.4 | 62.4 | 2200±10% | 22.0 |
| 13 | 110 | 71.5 | 5.5 | 143.0 | 13000±10% | 9.0 |

Coil versions, AC coil

| Coil code | Nominal voltage Vac | Pull-in voltage Vac | Release voltage Vac | Maximum voltage Vac | Coil resistance Ω | Coil current mA |
|-----------|---------------------|---------------------|---------------------|---------------------|-------------------|-----------------|
| 23 | 24 | 18 | 3.6 | 27.0 | 145±10% | 75.0 |
| 25 | 60 | 45 | 9.0 | 69.0 | 950±10% | 30.0 |
| 26 | 110 | 83 | 16.0 | 127.0 | 3100±10% | 16.0 |
| 27 | 230 | 175 | 35.0 | 253.0 | 11400±10% | 9.0 |

All figures are given for coil without preenergization, at ambient temperature +20°C
Other coil voltages on request

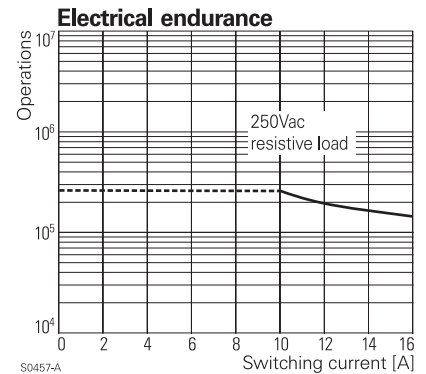
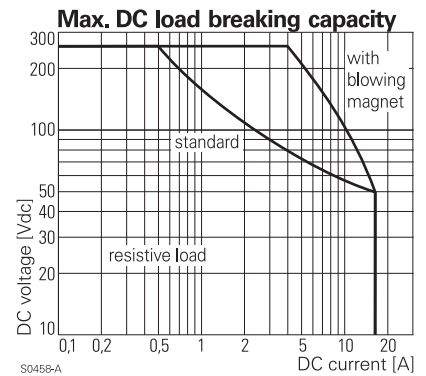

Power Relay 430 3 mm

1 pole 16 A, DC- and AC-coil

Insulation

| | | |
|---|----------------------|-----------------------|
| Dielectric strength | coil-contacts | 4000 V _{rms} |
| | open contact circuit | 2000 V _{rms} |
| Clearance / creepage | | 8 / 8 mm |
| Insulation to IEC 60664 | | |
| Voltage rating | | 250 V |
| Pollution degree | | 3 |
| Overvoltage category | | III |
| Insulation to VDE 0110b (2/79) | | |
| Insulation category / reference voltage | | C / 250 |
| Tracking resistance of relay base | | PTI 380H |

Other data

| | |
|--|--|
| Ambient temperature | -20...+70 °C |
| Mechanical life | >2.5x10 ⁵ operations |
| Max. switching rate at rated- / minimum load | 15 min ⁻¹ / 300 min ⁻¹ |
| Operate- / release time | typ. 15 / 8 ms |
| Bounce time | typ. 4 ms |
| Shock resistance (destruction) | 100 g |
| Category of protection (IEC 61810) | RT I - dust protected |
| Relay weight | 32 g |
| Packaging unit | 50 pcs. |

PCB layout / terminal assignment

View on solder pins
Dimensions in mm

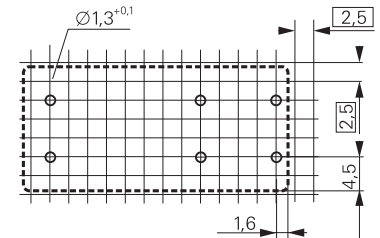

S0448-AE

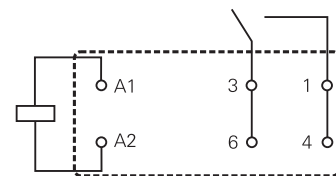

S0448-AF

Dimensions

Snap mounting

Dimensions in mm

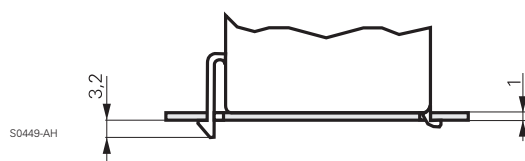
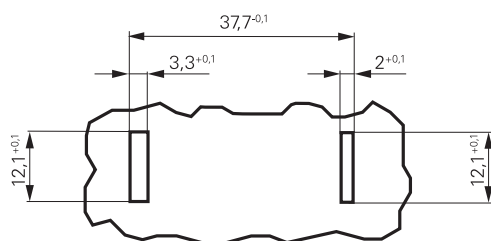
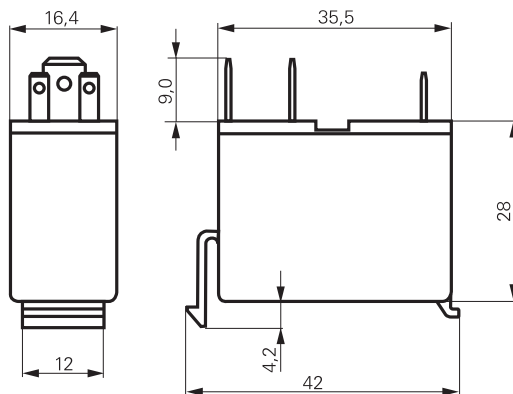

S0449-AH

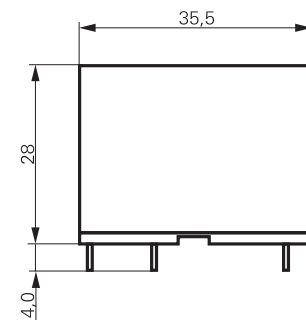

S0449-AB

Power Relay 430 3 mm

1 pole 16 A, DC- and AC-coil

Dimensions

Dimensions in mm

Mounting brackets

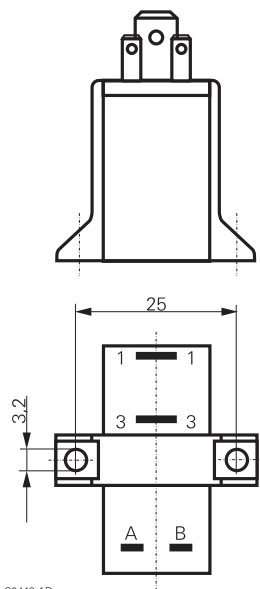

S0449-AD

Product key

0 4 3 0 [] [] [] [] 1 0 0

Type

Mounting

- 0 PCB version
- 1 mounting brackets
- 2 snap mounting
- 5 DIN rail mounting

Contact design

- 4 arc blowing magnet
- 5 standard

Coil

Coil code: Please refer to coil versions table

Contact material

- 0 AgCu3
- 1 AgCdO

Other types on request

| Product key | Version | Cont-material | Cont-config. | Coil | Coil | Part number |
|-----------------|---------------|---------------|---------------|---------|--------|-------------|
| 0430 25 0911 00 | snap mounting | AgCdO | 1 N/O contact | DC-coil | 12Vdc | 1-1415404-1 |
| 0430 25 1011 00 | 1.0mm plate | | | | 24Vdc | 1-1415404-3 |
| 0430 25 2811 00 | | | | AC-coil | 240Vac | 1-1415404-6 |

Power Relay 430

1 pole 16 A or 2 pole 10 A, DC- and AC-coil



F0257-A

Features

- 1 or 2 pole in N/O, C/O and N/C versions
- 4 kV / 8 mm coil-contact
- PCB mounting or Faston connectors
- Mounting brackets or snap mounting

Applications

Motors, electro valves



Technical data of approved types on request

| Contact data | 430 x6 | 430 x7 |
|---|-------------------|-----------------|
| Configuration | 1 N/O, C/O, N/C | 2 N/O, C/O, N/C |
| Type of contact | single contact | |
| Rated current | 16 A | 10 A |
| Rated voltage / max.breaking voltage AC | 250 Vac / 400 Vac | |
| Maximum breaking capacity AC | 4000 VA | 2500 VA |
| Make current (max. 4 s at duty cycle 10%) | 25 A | 15 A |
| Contact material | AgCdO, AgCu3 | |

Contact ratings

| Type | Load | Operations |
|--------|--------------------------|-------------------|
| 1 pole | 16 A, 250 Vac, resistive | 2.5×10^5 |
| 2 pole | 10 A, 250 Vac, resistive | 2.5×10^5 |

Coil data

| | | |
|--------------------|---------|-------------|
| Nominal voltage | DC coil | 6...110 Vdc |
| | AC coil | 6...240 Vac |
| Nominal coil power | DC coil | 1 W |
| | AC coil | 1.8 VA |
| Operate category | 2 / b | |

Coil versions, DC coil

| Coil code | Nominal voltage Vdc | Pull-in voltage Vdc | Release voltage Vdc | Maximum voltage Vdc | Coil resistance Ω | Coil current mA |
|-----------|---------------------|---------------------|---------------------|---------------------|--------------------------|-----------------|
| 09 | 12 | 7.8 | 0.6 | 15.6 | $145 \pm 10\%$ | 83.0 |
| 10 | 24 | 15.6 | 1.2 | 31.2 | $580 \pm 10\%$ | 41.0 |
| 11 | 48 | 31.2 | 2.4 | 62.4 | $2200 \pm 10\%$ | 22.0 |
| 13 | 110 | 71.5 | 5.5 | 143.0 | $13000 \pm 10\%$ | 9.0 |

Coil versions, AC coil

| Coil code | Nominal voltage Vac | Pull-in voltage Vac | Release voltage Vac | Maximum voltage Vac | Coil resistance Ω | Coil current mA |
|-----------|---------------------|---------------------|---------------------|---------------------|--------------------------|-----------------|
| 03 | 24 | 18.0 | 3.6 | 27.0 | $200 \pm 10\%$ | 75.0 |
| 05 | 60 | 45.0 | 9.0 | 69.0 | $1250 \pm 10\%$ | 30.0 |
| 06 | 110 | 83.0 | 16.0 | 127.0 | $4500 \pm 10\%$ | 16.0 |
| 07 | 230 | 170.0 | 35.0 | 253.0 | $17500 \pm 10\%$ | 10.0 |

All figures are given for coil without preenergization, at ambient temperature +20°C

Other coil voltages on request

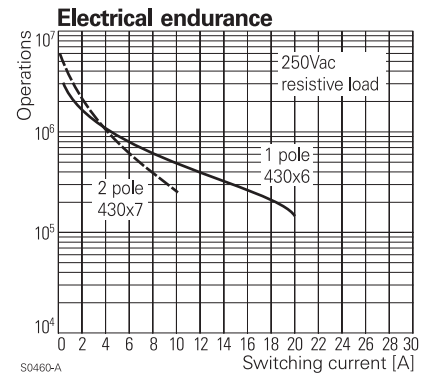
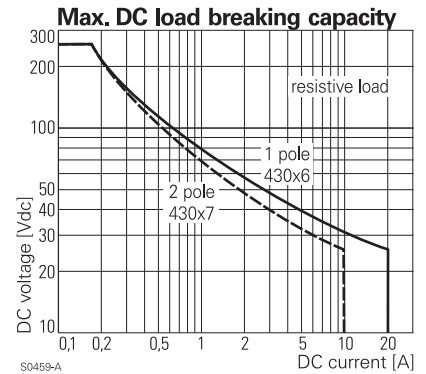

Power Relay 430

1 pole 16 A or 2 pole 10 A, DC- and AC-coil

Insulation

| | | |
|---|----------------------|-----------------------|
| Dielectric strength | coil-contacts | 4000 V _{rms} |
| | open contact circuit | 1000 V _{rms} |
| Clearance / creepage | | 8 / 8 mm |
| Insulation to IEC 60664 | | |
| Voltage rating | | 250 V |
| Pollution degree | | 3 |
| Overvoltage category | | III |
| Insulation to VDE 0110b (2/79) | | |
| Insulation category / reference voltage | | C / 250 |
| Tracking resistance of relay base | | PTI 380M |

Other data

| | |
|--|--|
| Ambient temperature | -20...+70 °C |
| Mechanical life | >2.5x10 ⁵ operations |
| Max. switching rate at rated- / minimum load | 15 min ⁻¹ / 600 min ⁻¹ |
| Operate- / release time | typ. 18 / 3 ms |
| Bounce time | typ. 3 ms |
| Shock resistance (destruction) | 100 g |
| Category of protection (IEC 61810) | RT I - dust protected |
| Relay weight | 32 g |
| Packaging unit | 50 pcs. |

PCB layout / terminal assignment

View on solder pins
Dimensions in mm

PCB version, 1 C/O contact

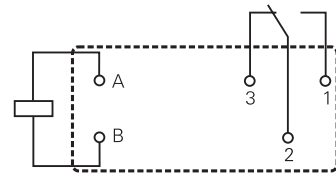
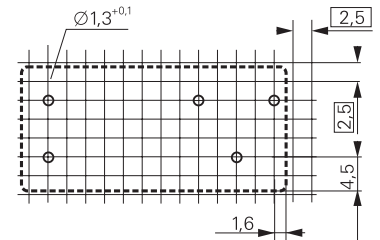

Dimensions

Dimensions in mm

Snap mounting

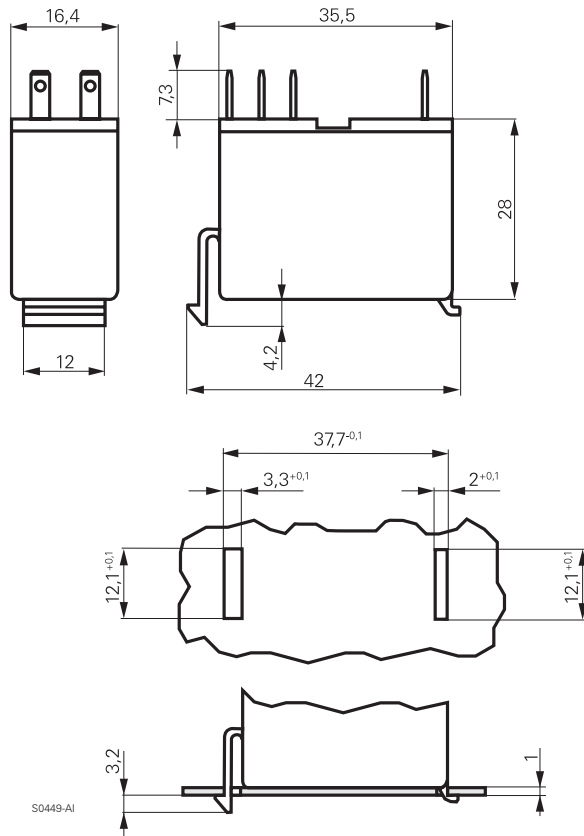

PCB version, 2 C/O contacts

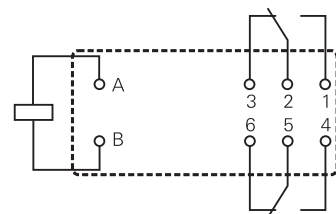
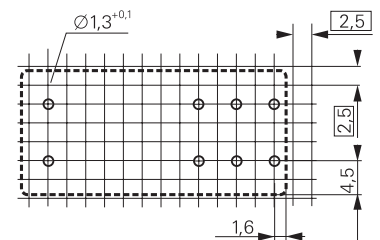

Dimensions

Dimensions in mm

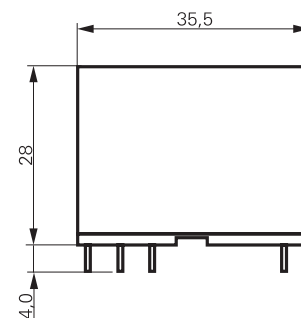

Power Relay 430

1 pole 16 A or 2 pole 10 A, DC- and AC-coil

Dimensions

Dimensions in mm

Mounting brackets

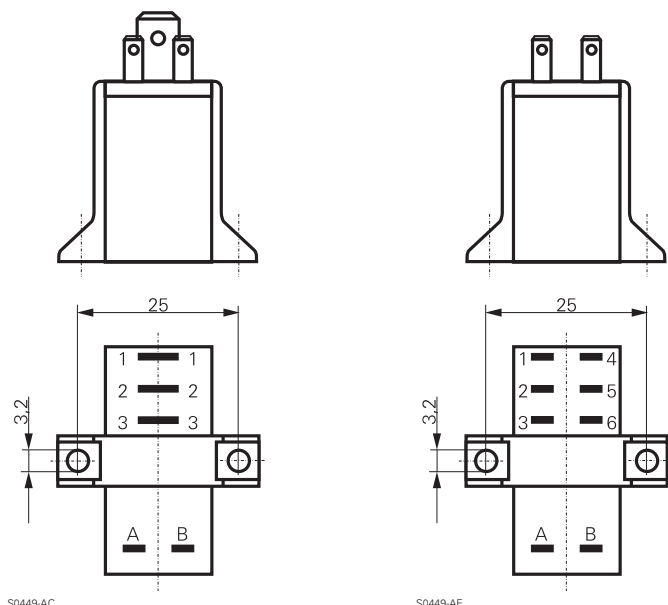

Product key

0 4 3 0 [] [] [] [] [] 0 0

Type

Mounting

- 0 PCB version
- 1 mounting brackets
- 2 snap mounting
- 5 DIN rail mounting

Version

- 6 1 pole
- 7 2 pole

Coil

Coil code: Please refer to coil versions table

Contact material

- 0 AgCu3
- 1 AgCdO

Contact configuration

- 1 1 N/O contact
- 2 1 N/C contact
- 3 1 C/O contact
- 4 2 N/O contacts
- 5 2 N/C contacts
- 6 2 C/O contacts

Other types on request

| Product key | Version | Cont-material | Cont.configuration | Coil | Coil | Part number |
|-----------------|---------------|---------------|--------------------|---------|--------|-------------|
| 0430 16 0911 00 | snap mounting | AgCdO | 1 N/O contact | DC-coil | 12Vdc | 8-1415430-1 |
| 0430 16 1011 00 | 1.0mm plate | | | | 24Vdc | 8-1415430-3 |
| 0430 16 1013 00 | | | 1 C/O contact | | | 8-1415430-5 |
| 0430 17 0916 00 | | | 2 C/O contacts | | 12Vdc | 0-1415404-1 |
| 0430 17 1016 00 | | | | | 24Vdc | 0-1415404-4 |
| 0430 26 0713 00 | | | 1 C/O contact | AC-coil | 220Vac | 2-1415404-3 |
| 0430 27 0716 00 | | | 2 C/O contacts | | 220Vac | 2-1415404-8 |

Rast 5 Power Relay 419 01

2 pole 16 A, DC- and AC-coil



F0255-A

Features

- Safety mains insulation
- Contact gap > 3 mm
- 4 kV / 8 mm coil-contact
- Ambient temperature up to 90°C
- Faston connectors (DIN 46244)
- Snap or screw mounting

Applications

Industrial and domestic appliances, absolute safe power supply disconnection



Technical data of approved types on request

Contact data

| | |
|---|-------------------|
| Configuration | 2 N/O contact |
| Type of contact | single contact |
| Rated current | 16 A |
| Rated voltage / max.breaking voltage AC | 250 Vac / 400 Vac |
| Maximum breaking capacity AC | 4000 VA |
| Make current (max. 4 s at duty cycle 10%) | 25 A |
| Contact material | AgCdO, AgNi |
| Contact gap | >3 mm |

Contact ratings

| Type | Load | Operations |
|------------|--------------------------|---------------------|
| DC-version | 16 A, 250 Vac, resistive | 2.5x10 ⁵ |
| DC-version | 12 A, 250 Vac, resistive | 2.5x10 ⁵ |
| AC-version | 16 A, 250 Vac, resistive | 1x10 ⁵ |
| AC-version | 12 A, 250 Vac, resistive | 1x10 ⁵ |

Coil data

| | | |
|--------------------|---------|---------------|
| Nominal voltage | DC coil | 6...24 Vdc |
| | AC coil | 120...400 Vac |
| Nominal coil power | DC coil | 1.3 W |
| | AC coil | 2.0...2.5 VA |
| Operate category | 2 / c | |

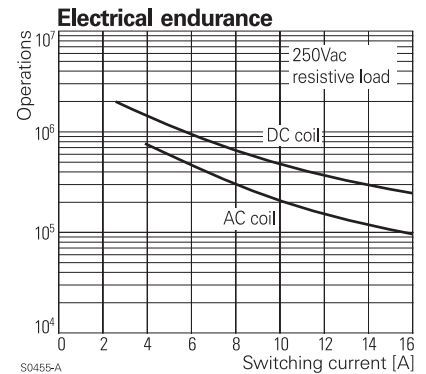

S0455-A

Coil versions, DC coil

| Coil code | Nominal voltage Vdc | Pull-in voltage Vdc | Release voltage Vdc | Maximum voltage Vdc | Coil resistance Ω | Coil current mA |
|-----------|---------------------|---------------------|---------------------|---------------------|-------------------|-----------------|
| 31 | 12 | 7.7 | 0.9 | 19.5 | 118±10% | 102.0 |
| 29 | 24 | 15.5 | 1.8 | 39.0 | 470±10% | 51.0 |

Coil versions, AC coil

| Coil code | Nominal voltage Vac, 50 Hz | Pull-in voltage Vac | Release voltage Vac | Maximum voltage Vac | Coil resistance Ω | Coil current mA |
|-----------|----------------------------|---------------------|---------------------|---------------------|-------------------|-----------------|
| 14 | 110...120 | 93.0 | 18.0 | 132.0 | 1650±10% | 20.0 |
| 10 | 220...240 | 187.0 | 36.0 | 264.0 | 6600±10% | 10.0 |
| 09 | 380...400 | 323.0 | 60.0 | 440.0 | 20000±10% | 6.0 |

All figures are given for coil without preenergization, at ambient temperature +20°C
Other coil voltages on request

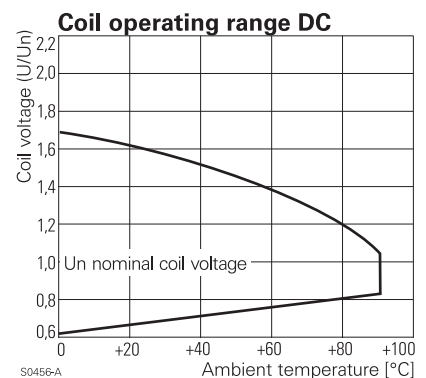

S0456-A

Rast 5 Power Relay 419 01

2 pole 16 A, DC- and AC-coil

| Insulation | | |
|---|----------------------|-----------------------|
| Dielectric strength | coil-contacts | 4000 V _{rms} |
| | open contact circuit | 2000 V _{rms} |
| Clearance / creepage | | 8 / 8 mm |
| Insulation to IEC 60664 | | |
| Voltage rating | | 250 V |
| Pollution degree | | 3 |
| Overvoltage category | | III |
| Insulation to VDE 0110b (2/79) | | |
| Insulation category / reference voltage | | C / 380 |
| Tracking resistance of relay base | | CTI 600M |

| Other data | |
|--|--|
| Ambient temperature | -20...+90 °C |
| Mechanical life | >2x10 ⁶ operations |
| Max. switching rate at rated- / minimum load | 15 min ⁻¹ / 600 min ⁻¹ |
| Operate- / release time | typ. 15 / 15 ms |
| Bounce time | typ. 4 ms |
| Vibration resistance | 2 g, 5...500 Hz |
| Shock resistance (destruction) | 80 g |
| Category of protection (IEC 61810) | RT I - dust protected |
| Relay weight | 90 g |
| Packaging unit | 42 pcs. |

Snap mounting / dimensions

Dimensions in mm

Terminal assignment

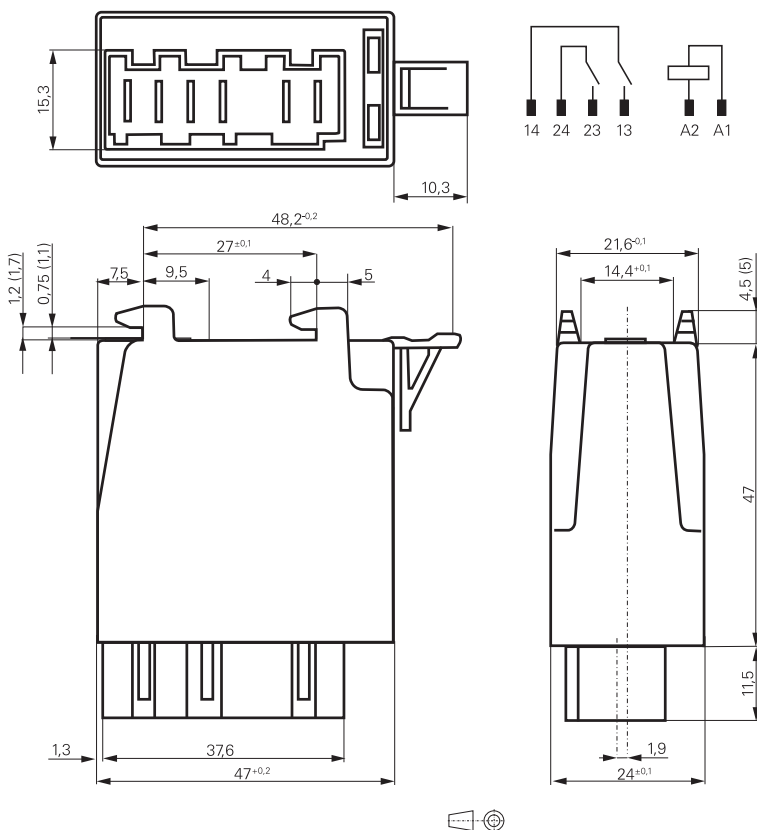

Rast 5 Power Relay 419 01

2 pole 16 A, DC- and AC-coil

Screw mounting / dimensions

Dimensions in mm

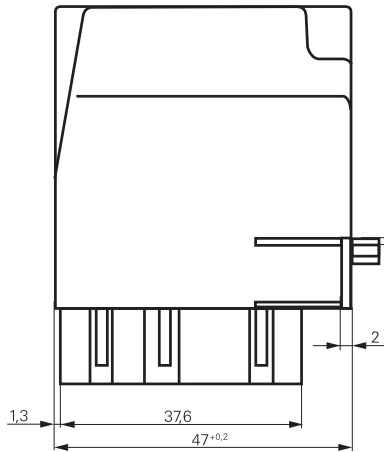
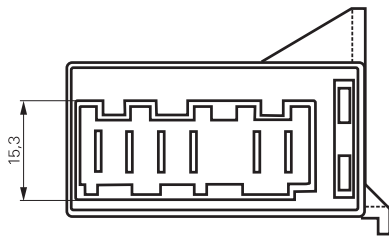

Terminal assignment

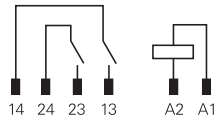

S0447-AB

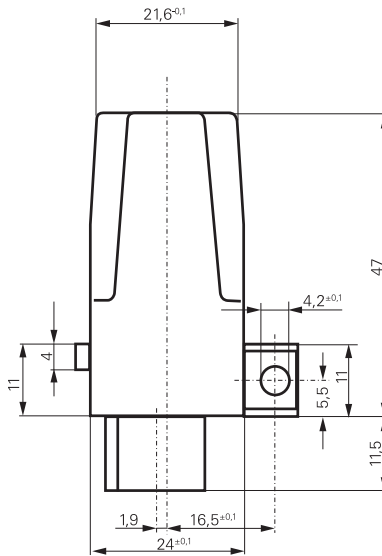

Product key

0 4 1 9 **0 1**

Type

Coil

Coil code: Please refer to coil versions table

Contact material

01 AgCdO

03 AgNi 90/10

Mounting

00 Snap mounting, 1.0 mm panel

01 Snap mounting, 1.5 mm panel

02 Screw mounting

Other types on request

| Product key | Version | Cont-material | Cont.configuration | Coil | Part number |
|-----------------|---------------------|---------------|--------------------|------------|-------------|
| 0419 01 2901 00 | snap mounting 1.0mm | AgCdO | 2 N/O contacts | 24Vdc | 2-1415419-6 |
| 0419 01 2901 01 | snap mounting 1.5mm | | | | 2-1415419-7 |
| 0419 01 2901 02 | screw mounting | | | | 2-1415419-8 |
| 0419 01 1001 00 | snap mounting 1.0mm | | | 220-240Vac | 0-1415419-7 |
| 0419 01 1001 01 | snap mounting 1.5mm | | | | 0-1415419-8 |
| 0419 01 1001 02 | screw mounting | | | | 0-1415419-9 |

Safety Relay SR2M

2 pole 6 A



Features

- Forcibly guided contacts according to EN 50205
- 2 pole safety relay with either 1N/O+1N/C or 2C/O contacts
- 6 kV surge resistance between poles

Applications

Emergency shut-off, machine control, elevator and escalator control, light barrier control

F0188-C



Technical data of approved types on request

Contact data

| | |
|--|---|
| Configuration | 1 N/C contact and 1 N/O contact or 2 C/O contact *) |
| Type of contact | single contact, forcibly guided |
| Rated current | 6 A |
| Rated voltage / max. breaking voltage AC | 250 Vac / 440 Vac |
| Maximum breaking capacity AC | 1500 VA |
| Contact material | AgNi |
| Minimum contact load | > 50 mW |
| Contact resistance | ≤ 100 mΩ / 1 A / 24 Vdc ≤ 2 Ω / 10 mA / 5 Vdc |

*) According EN50205 only 1N/O / 1N/C (11-14 and 22-21 or 12-11 and 21-24) shall be used as forcibly guided contacts.

Coil data

| | |
|--------------------|----------------|
| Nominal voltage | 5...110 Vdc |
| Nominal coil power | approx. 700 mW |
| Operative range | 2 |

Coil versions

| Coil code | Nominal voltage Vdc | Pull-in voltage Vdc | Release voltage Vdc | Coil resistance Ω | Coil current mA |
|-----------|---------------------|---------------------|---------------------|-------------------|-----------------|
| 005 | 5 | 3.8 | 0.5 | 35.7±10% | 140.0 |
| 006 | 6 | 4.5 | 0.6 | 51±10% | 117.6 |
| 009 | 9 | 6.75 | 0.9 | 116±10% | 77.6 |
| 012 | 12 | 9.0 | 1.2 | 206±10% | 58.3 |
| 018 | 18 | 13.5 | 1.8 | 483±10% | 37.3 |
| 021 | 21 | 15.8 | 2.1 | 630±10% | 33.3 |
| 024 | 24 | 18.0 | 2.4 | 823±10% | 29.2 |
| 036 | 36 | 27.0 | 3.6 | 1851±10% | 19.4 |
| 040 | 40 | 30.0 | 4.0 | 2286±10% | 17.5 |
| 048 | 48 | 36.0 | 4.8 | 3291±12% | 14.6 |
| 060 | 60 | 45.0 | 6.0 | 5142±12% | 11.7 |
| 080 | 80 | 60.0 | 8.0 | 9143±12% | 8.7 |
| 110 | 110 | 82.5 | 11.0 | 17285±12% | 6.4 |

All figures are given for coil without preenergization, at ambient temperature +20°C

$U_{op\ max}$: at 70 °C after preenergization with $1.1 \times U_{nom}$ the max. operate voltage is 85% of U_{nom} . U_{max} : at 70 °C the max. coil voltage is $1.1 \times U_{nom}$

Other coil voltages on request

Max. DC load breaking capacity

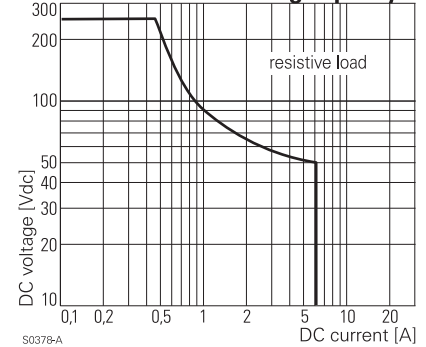

S0378-A

Electrical endurance

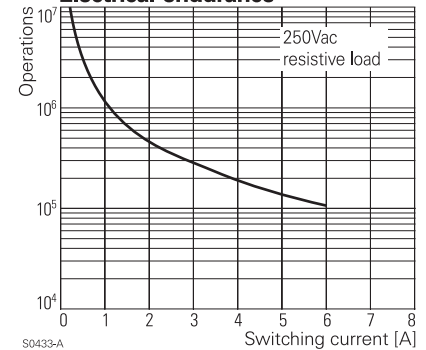

S0433-A

Coil operating range DC

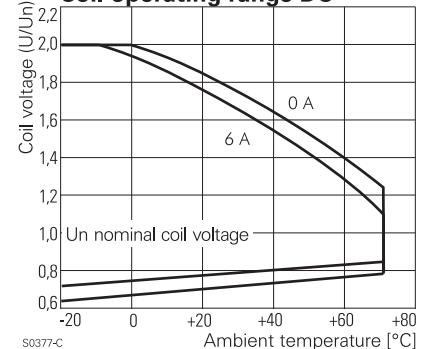

S0377-C

Safety Relay SR2M

2 pole 6 A

Insulation

| | | |
|-----------------------------------|----------------------|-----------------------|
| Dielectric strength | coil-contacts | 4000 V _{rms} |
| | open contact circuit | 1000 V _{rms} |
| | adjacent contacts | 3000 V _{rms} |
| Clearance / creepage | coil-contacts | 8 / 8 mm |
| | adjacent contacts | 5.5 / 5.5 mm |
| Insulation to IEC 60664 | | |
| | Voltage rating | 250 V |
| | Pollution degree | 2 |
| | Overvoltage category | III |
| Insulation resistance (500 Vdc) | | > 1x10 ⁶ Ω |
| Tracking resistance of relay base | | CTI 250 |

Other data

| | |
|--|---|
| Ambient temperature | -25...+70 °C |
| Mechanical life | 10x10 ⁶ operations |
| Max. switching rate at rated- / minimum load | 6 min ⁻¹ / 300 min ⁻¹ |
| Operate- / release time | typ. 10 / 4 ms |
| Vibration resistance N/O / N/C contact | > 10 / 2.5 g, 15...200 Hz |
| Shock resistance (function)N/O contact / N/C contact | > 10 / 5 g, 11 ms half sine |
| Category of protection (IEC 61810) | RT III - wash tight |
| Relay weight | 20 g |
| Packaging unit | 20 pcs. |
| Accessories | see accessories SR2M |

Dimensions

Dimensions in mm

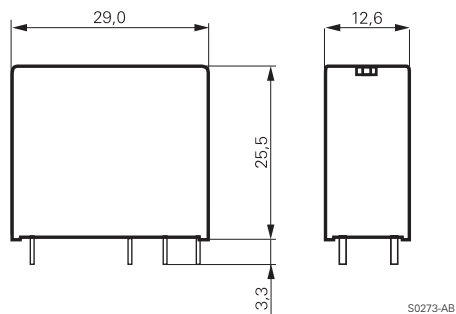

S0273-AB

PCB layout / terminal assignment

View on solder pins
Dimensions in mm

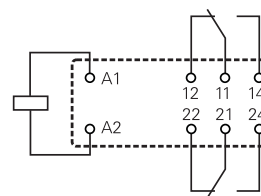
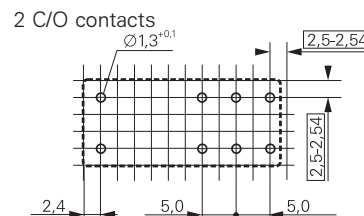

S0163-CO

S0163-CJ

1 N/O and 1 N/C contacts

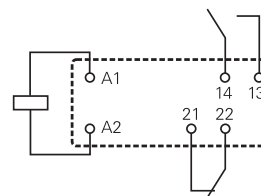
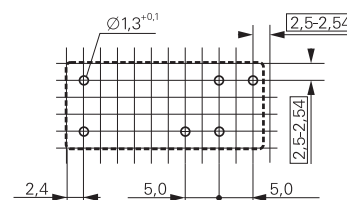

S0163-CU

S0163-CV

Product key

V 2 3 0 4 7 - A 1 - A 5

Type

Version

A1 standard

Coil

Coil code = nominal voltage (e.g. 024=24Vdc)

Contact type

A single contact

Contact material

5 AgNi

Contact configuration

01 2 C/O contacts

11 1 N/O and 1 N/C contact

Other types on request

Safety Relay SR2M

2 pole 6 A

| Product key | Version | Contact material | Configuration | Coil | Part number |
|-------------------|------------|------------------|----------------|--------|-------------|
| V23047-A1005-A501 | standard | AgNi | 2 C/O contacts | 5 Vdc | 0-1393258-2 |
| V23047-A1005-A511 | wash tight | | 1 N/O + 1 N/C | 5 Vdc | 7-1415006-1 |
| V23047-A1006-A501 | | | 2 C/O contacts | 6 Vdc | 3-1415011-1 |
| V23047-A1006-A511 | | | 1 N/O + 1 N/C | 6 Vdc | 6-1415011-1 |
| V23047-A1009-A501 | | | 2 C/O contacts | 9 Vdc | 0-1393258-3 |
| V23047-A1009-A511 | | | 1 N/O + 1 N/C | 9 Vdc | 7-1415011-1 |
| V23047-A1012-A501 | | | 2 C/O contacts | 12 Vdc | 0-1393258-4 |
| V23047-A1012-A511 | | | 1 N/O + 1 N/C | 12 Vdc | 0-1393258-5 |
| V23047-A1018-A501 | | | 2 C/O contacts | 18 Vdc | 0-1393258-8 |
| V23047-A1018-A511 | | | 1 N/O + 1 N/C | 18 Vdc | 0-1393258-9 |
| V23047-A1021-A501 | | | 2 C/O contacts | 21 Vdc | 1-1393258-1 |
| V23047-A1021-A511 | | | 1 N/O + 1 N/C | 21 Vdc | 1-1393258-2 |
| V23047-A1024-A501 | | | 2 C/O contacts | 24 Vdc | 1-1393258-5 |
| V23047-A1024-A511 | | | 1 N/O + 1 N/C | 24 Vdc | 1-1393258-7 |
| V23047-A1036-A501 | | | 2 C/O contacts | 36 Vdc | 2-1393258-0 |
| V23047-A1036-A511 | | | 1 N/O + 1 N/C | 36 Vdc | 8-1415011-1 |
| V23047-A1040-A501 | | | 2 C/O contacts | 40 Vdc | 2-1393258-1 |
| V23047-A1040-A511 | | | 1 N/O + 1 N/C | 40 Vdc | 2-1393258-2 |
| V23047-A1048-A501 | | | 2 C/O contacts | 48 Vdc | 3-1415006-1 |
| V23047-A1048-A511 | | | 1 N/O + 1 N/C | 48 Vdc | 9-1415011-1 |
| V23047-A1060-A511 | | | | 60 Vdc | 2-1393258-3 |

Safety Relay SR4 D/M

4 pole 8 A



Features

- Forcibly guided contacts according to EN 50205
- 4 pole safety relay with either
2 N/O+2 N/C or 3 N/O+1 N/C contacts
- Very small outlines

Available August 2002

Applications

Emergency shut-off, machine control, elevator and escalator control, light barrier control

F0244-A



Technical data of approved types on request

in preparation 

Contact data

| | |
|--|--|
| Configuration | 3 N/O contact and 1 N/C contact or 2 N/O contact and 2 N/C contact |
| Type of contact | single contact, forcibly guided |
| Continuous thermal load | 8 A |
| Rated voltage / max. breaking voltage AC | 250 Vac / 440 Vac |
| Maximum breaking capacity AC | 2000 VA |
| Contact material | AgSnO ₂ |
| Minimum contact load | > 50 mW |
| Contact resistance | ≤100 mΩ / 1 A / 24 Vdc ≤20 Ω / 10 mA / 5 Vdc |

Coil data

| | |
|--------------------|------------------------|
| Nominal voltage | 5...110 Vdc |
| Nominal coil power | 800 mW |
| Operative range | 2 |
| Max. coil voltage | 150 % U _{nom} |

Coil versions

| Coil code | Nominal voltage Vdc | Pull-in voltage Vdc | Release voltage Vdc | Maximum voltage Vdc | Coil resistance Ω | Coil current mA |
|-----------|---------------------|---------------------|---------------------|---------------------|-------------------|-----------------|
| 005 | 5 | 3.8 | 0.5 | 7.5 | 31±10% | 161.3 |
| 006 | 6 | 4.5 | 0.6 | 9.0 | 45±10% | 133.3 |
| 009 | 9 | 6.8 | 0.9 | 13.5 | 101±10% | 89.1 |
| 012 | 12 | 9.0 | 1.2 | 18.0 | 180±10% | 66.7 |
| 015 | 15 | 11.3 | 1.5 | 22.5 | 281±10% | 53.4 |
| 018 | 18 | 13.5 | 1.8 | 27.0 | 405±10% | 44.4 |
| 021 | 21 | 15.8 | 2.1 | 31.5 | 551±10% | 38.1 |
| 024 | 24 | 18.0 | 2.4 | 36.0 | 720±10% | 33.3 |
| 036 | 36 | 27.0 | 3.6 | 54.0 | 1620±10% | 22.2 |
| 040 | 40 | 30.0 | 4.0 | 60.0 | 2000±10% | 20.0 |
| 048 | 48 | 36.0 | 4.8 | 72.0 | 2880±10% | 16.7 |
| 060 | 60 | 45.0 | 6.0 | 90.0 | 4500±10% | 13.3 |
| 085 | 85 | 63.8 | 8.5 | 127.5 | 9031±10% | 9.4 |
| 110 | 110 | 82.5 | 11.0 | 165.0 | 15125±10% | 7.3 |

All figures are given for coil without preenergization, at ambient temperature +20°C

U_{op max}: at 70 °C after preenergization with 1.1 x U_{nom} the max. operate voltage is 85% of U_{nom}. U_{max}: at 70 °C the max. coil voltage is 1.1 x U_{nom}

Other coil voltages on request

Safety Relay SR4 D/M

4 pole 8 A

Insulation

| | | |
|-----------------------------------|----------------------|-----------------------|
| Dielectric strength | coil-contacts | 4000 V _{rms} |
| | open contact circuit | 1000 V _{rms} |
| | adjacent contacts | 2500 V _{rms} |
| Clearance / creepage | coil-contact | 10 / 10 mm |
| | adjacent contacts | 3 / 3.5 mm |
| Insulation to IEC 60664 | | |
| | Voltage rating | 250 V |
| | Pollution degree | 2 |
| | Overvoltage category | III |
| Insulation resistance (500 Vdc) | | > 1x10 ⁶ Ω |
| Tracking resistance of relay base | | CTI 250 |

Other data

| | |
|--|---|
| Ambient temperature | -25...+70 °C |
| Mechanical life | ≥ 10x10 ⁶ operations |
| Max. switching rate at rated- / minimum load | 6 min ⁻¹ / 300 min ⁻¹ |
| Operate- / release time | typ. 12 / 20 ms |
| Vibration resistance N/O / N/C contact | > 8 / 2.5 g, 10...200 Hz |
| Category of protection (IEC 61810) | RT III - wash tight |
| Relay weight | 16 g |
| Packaging unit | 10 pcs. |

PCB layout / terminal assignment

View on solder pins
Dimensions in mm

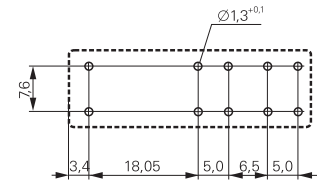

S0413-BC

2 N/O and 2 N/C contacts

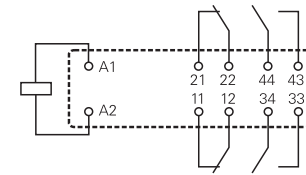

S0413-BB

3 N/O and 1 N/C contacts

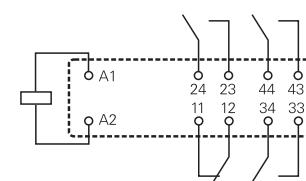

S0413-BA

Dimensions

Dimensions in mm

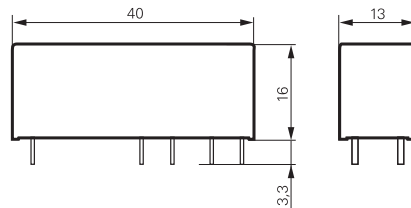

S0412-AH

Product key

Type

Contact configuration

D 2 N/O + 2 N/C contacts

M 3 N/O + 1 N/C contacts

Contact material

4 AgSnO₂

Coil

Coil code = nominal voltage (e.g. 024=24Vdc)

Other types on request

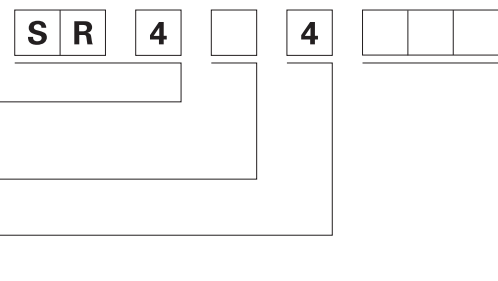

Safety Relay SR4 D/M

4 pole 8 A

| Product key | Type | Contact configuration | Contact material | Coil | Part number | | | |
|-------------|------------------------|---------------------------|------------------|---------------------------|-------------|--|-------|-------------|
| SR4D4005 | 4 pole safety relay | 2 N/O + 2 N/C contacts | AgSnO | 5 Vdc | 7-1415054-1 | | | |
| SR4D4006 | | | | 6 Vdc | 8-1415054-1 | | | |
| SR4D4009 | | | | 9 Vdc | 9-1415054-1 | | | |
| SR4D4012 | | | | 12 Vdc | 0-1415055-1 | | | |
| SR4D4018 | | | | 18 Vdc | 1-1415055-1 | | | |
| SR4D4021 | | | | 21 Vdc | 2-1415055-1 | | | |
| SR4D4024 | | | | 24 Vdc | 3-1415055-1 | | | |
| SR4D4036 | | | | 36 Vdc | 4-1415055-1 | | | |
| SR4D4040 | | | | 40 Vdc | 5-1415055-1 | | | |
| SR4D4048 | | | | 48 Vdc | 6-1415055-1 | | | |
| SR4D4060 | | | | 60 Vdc | 7-1415055-1 | | | |
| SR4D4085 | | | | 85 Vdc | 8-1415055-1 | | | |
| SR4D4110 | | | | 110 Vdc | 9-1415055-1 | | | |
| SR4M4005 | | | | 3 N/O + 1 N/C contacts | | | 5 Vdc | 5-1415053-1 |
| SR4M4006 | | | | | | | 6 Vdc | 6-1415053-1 |
| SR4M4009 | 9 Vdc | 7-1415053-1 | | | | | | |
| SR4M4012 | 12 Vdc | 8-1415053-1 | | | | | | |
| SR4M4018 | 18 Vdc | 9-1415053-1 | | | | | | |
| SR4M4021 | 21 Vdc | 0-1415054-1 | | | | | | |
| SR4M4024 | 24 Vdc | 4-1415053-1 | | | | | | |
| SR4M4036 | 36 Vdc | 1-1415054-1 | | | | | | |
| SR4M4040 | 40 Vdc | 2-1415054-1 | | | | | | |
| SR4M4048 | 48 Vdc | 3-1415054-1 | | | | | | |
| SR4M4060 | 60 Vdc | 4-1415054-1 | | | | | | |
| SR4M4085 | 85 Vdc | 5-1415054-1 | | | | | | |
| SR4M4110 | 110 Vdc | 6-1415054-1 | | | | | | |

Safety Relay SR6 D/M

4 pole 8 A



Features

- Forcibly guided contacts according to EN 50205
- 4 pole safety relay with either
2 N/O+2 N/C or 3 N/O+1 N/C
- High insulation distances for safe separation of electrical circuits

Applications

Emergency shut-off, press control, machine control, elevator and escalator control, safety modules



Technical data of approved types on request

Contact data

| | |
|--|--|
| Configuration | 3 N/O contact and 1 N/C contact or 2 N/O contact and 2 N/C contact |
| Type of contact | single contact, forcibly guided |
| Continuous thermal load | 8 A |
| Rated voltage / max. breaking voltage AC | 250 Vac / 440 Vac |
| Maximum breaking capacity AC | 2000 VA |
| Contact material | AgSnO ₂ |
| Minimum contact load | > 50 mW |
| Contact resistance | ≤100 mΩ / 1 A / 24 Vdc ≤20 Ω / 10 mA / 5 Vdc |

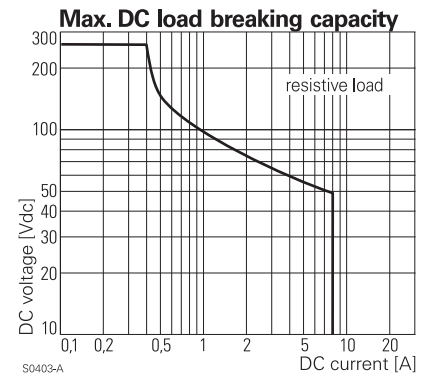

Coil data

| | |
|--------------------|------------------------|
| Nominal voltage | 5...110 Vdc |
| Nominal coil power | 1200 mW |
| Operative range | 2 |
| Max. coil voltage | 150 % U _{nom} |

Coil versions

| Coil code | Nominal voltage Vdc | Pull-in voltage Vdc | Release voltage Vdc | Maximum voltage Vdc | Coil resistance Ω | Coil current mA |
|-----------|---------------------|---------------------|---------------------|---------------------|-------------------|-----------------|
| 005 | 5 | 3.8 | 0.5 | 7.5 | 21±10% | 238.1 |
| 006 | 6 | 4.5 | 0.6 | 9.0 | 30±10% | 200.0 |
| 009 | 9 | 6.8 | 0.9 | 13.5 | 68±10% | 132.4 |
| 012 | 12 | 9.0 | 1.2 | 18.0 | 120±10% | 100.0 |
| 018 | 18 | 13.5 | 1.8 | 22.5 | 270±10% | 66.7 |
| 021 | 21 | 15.8 | 2.1 | 27.0 | 368±10% | 57.1 |
| 024 | 24 | 18.0 | 2.4 | 36.0 | 480±10% | 50.0 |
| 036 | 36 | 27.0 | 3.6 | 54.0 | 1080±10% | 33.3 |
| 040 | 40 | 30.0 | 4.0 | 60.0 | 1333±10% | 30.0 |
| 048 | 48 | 36.0 | 4.8 | 72.0 | 1920±10% | 25.0 |
| 060 | 60 | 45.0 | 6.0 | 90.0 | 3000±12% | 20.0 |
| 085 | 85 | 64.0 | 8.5 | 127.5 | 6021±12% | 14.1 |
| 110 | 110 | 82.5 | 11.0 | 165.0 | 10080±12% | 10.9 |

All figures are given for coil without preenergization, at ambient temperature +20°C
 U_{op max}: at 70 °C after preenergization with 1.1 x U_{nom} the max. operate voltage is 85% of U_{nom}. U_{max}: at 70 °C the max. coil voltage is 1.1 x U_{nom}
 Other coil voltages on request

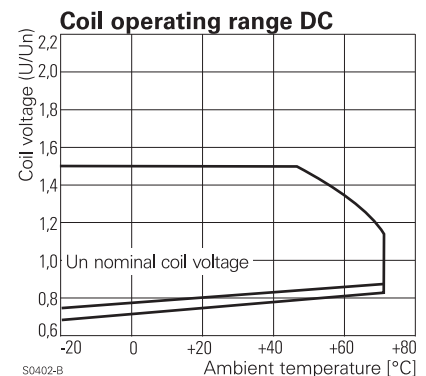

Safety Relay SR6 D/M

4 pole 8 A

Insulation

| | | |
|---|----------------------|--|
| Dielectric strength | coil-contacts | 3000 V _{rms} |
| | open contact circuit | 1000 V _{rms} |
| | adjacent contacts | 3000 V _{rms} / 4000 V _{rms} *) |
| Clearance / creepage | coil-contact | 5.5 / 5.5 mm |
| | adjacent contacts | 5.5 / 5.5 mm or 12 / 12 mm *) |
| Insulation to IEC 60664 | | |
| | Voltage rating | 250 V |
| | Pollution degree | 2 |
| | Overvoltage category | III |
| Insulation resistance (500 Vdc) | | > 1x10 ⁶ Ω |
| Tracking resistance of relay base *) in longitudinal direction | | CTI 250 |

Other data

| | |
|---|---|
| Ambient temperature | -25...+70 °C |
| Mechanical life | ≥ 10x10 ⁶ operations |
| Max. switching rate at rated- / minimum load | 6 min ⁻¹ / 300 min ⁻¹ |
| Operate- / release time | typ. 11 / 3 ms |
| Vibration resistance N/O / N/C contact | > 8 / 5 g, 10...200 Hz |
| Shock resistance (function) N/O contact / N/C contact | > 8 / 6 g, 16ms half sine |
| Category of protection (IEC 61810) | RT III - wash tight |
| Relay weight | 30 g |
| Packaging unit | 10 pcs. |

Dimensions

Dimensions in mm

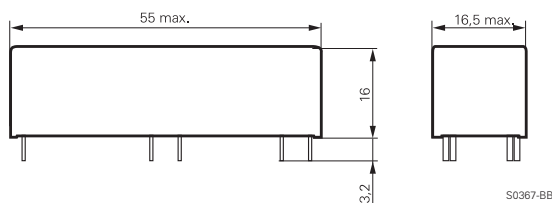

PCB layout / terminal assignment

View on solder pins
Dimensions in mm

2 N/O+2 N/C versions

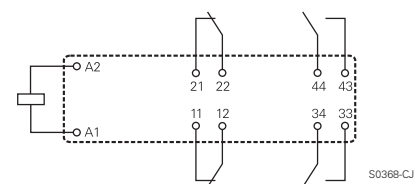
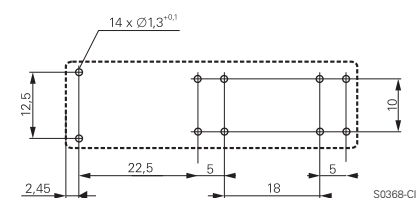

3 N/O + 1 N/C version

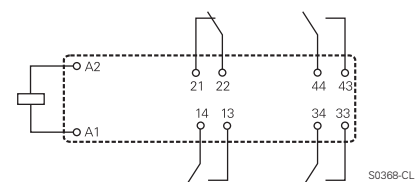
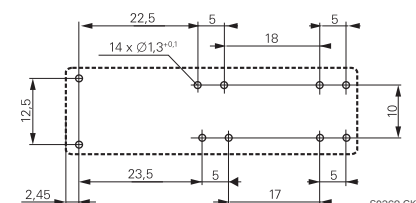

Product key

Type

Contact configuration

D 2 N/O + 2 N/C contacts

M 3 N/O + 1 N/C contacts

Contact material

4 AgSnO₂

Coil

Coil code = nominal voltage (e.g. 024=24Vdc)

Other types on request

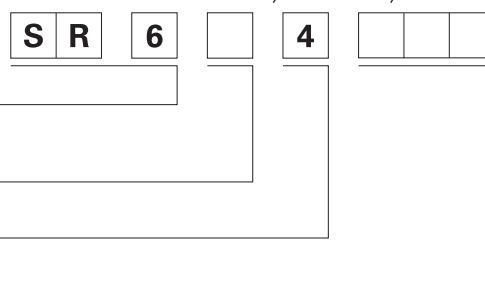

| Product key | Type | Contact configuration | Contact material | Coil | Part number |
|-------------|--------------|-----------------------|------------------|---------|-------------|
| SR6D4024 | 4-pole | 2 N/O + 2 N/C | AgSnO | 24 Vdc | 6-1415027-1 |
| SR6D4110 | safety relay | contacts | | 110 Vdc | 0-1415062-1 |

Safety Relay SR6

6 pole 8 A



Features

- Forcibly guided contacts according to EN50205
- Small 6 pole safety relay with either
4 N/O+2 N/C or 3 N/O+3 N/C or 5 N/O+1 N/C contacts
- 6 kV surge resistance between poles

Applications

Emergency shut-off, press control, machine control, elevator and escalator control, safety modules

F0206-B



Technical data of approved types on request

Contact data

| | |
|--|---|
| Configuration | 3 N/O contact and 3 N/C contact or 4 N/O contact and 2 N/C contact or 5 N/O contact and 1 N/C contact |
| Type of contact | single contact, forcibly guided |
| Continuous thermal load | 8 A |
| Rated voltage / max. breaking voltage AC | 250 Vac / 440 Vac |
| Maximum breaking capacity AC | 2000 VA |
| Minimum contact load | > 50 mW |
| Contact resistance | ≤100 mΩ / 1 A / 24 Vdc ≤20 Ω / 10 mA / 5 Vdc |

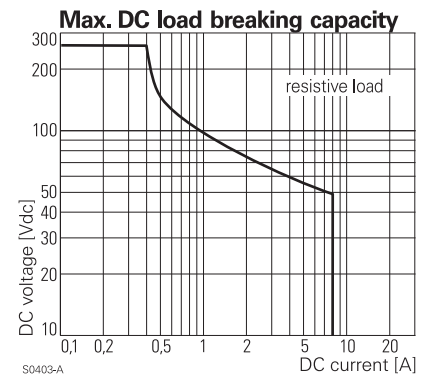

Coil data

| | |
|--------------------|-----------------|
| Nominal voltage | 5...110 Vdc |
| Nominal coil power | 1200 mW |
| Operative range | 2 |
| Max. coil voltage | 150 % U_{nom} |

Coil versions

| Coil code | Nominal voltage Vdc | Pull-in voltage Vdc | Release voltage Vdc | Maximum voltage Vdc | Coil resistance Ω | Coil current mA |
|-----------|---------------------|---------------------|---------------------|---------------------|-------------------|-----------------|
| 005 | 5 | 3.8 | 0.5 | 7.5 | 21±10% | 238.1 |
| 006 | 6 | 4.5 | 0.6 | 9.0 | 30±10% | 200.0 |
| 009 | 9 | 6.8 | 0.9 | 13.5 | 68±10% | 132.4 |
| 012 | 12 | 9.0 | 1.2 | 18.0 | 120±10% | 100.0 |
| 018 | 18 | 13.5 | 1.8 | 22.5 | 270±10% | 66.7 |
| 021 | 21 | 15.8 | 2.1 | 27.0 | 368±10% | 57.1 |
| 024 | 24 | 18.0 | 2.4 | 36.0 | 480±10% | 50.0 |
| 036 | 36 | 27.0 | 3.6 | 54.0 | 1080±10% | 33.3 |
| 040 | 40 | 30.0 | 4.0 | 60.0 | 1333±10% | 30.0 |
| 048 | 48 | 36.0 | 4.8 | 72.0 | 1920±10% | 25.0 |
| 060 | 60 | 45.0 | 6.0 | 90.0 | 3000±12% | 20.0 |
| 085 | 85 | 64.0 | 8.5 | 127.5 | 6021±12% | 14.1 |
| 110 | 110 | 82.5 | 11.0 | 165.0 | 10080±12% | 10.9 |

All figures are given for coil without preenergization, at ambient temperature +20°C
 $U_{op\ max}$: at 70 °C after preenergization with $1.1 \times U_{nom}$ the max. operate voltage is 85% of U_{nom} . U_{max} : at 70 °C the max. coil voltage is $1.1 \times U_{nom}$
 Other coil voltages on request

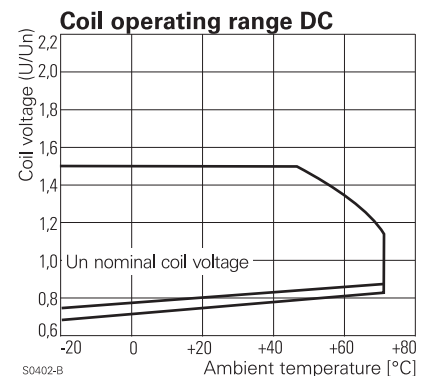

Safety Relay SR6

6 pole 8 A

Insulation

| | | |
|-----------------------------------|---------------------------------|-----------------------|
| Dielectric strength | coil-contacts | 3000 V _{rms} |
| | open contact circuit | 1000 V _{rms} |
| | adjacent contacts | 3000 V _{rms} |
| Clearance / creepage coil-contact | adjacent contacts | 5.5 / 5.5 mm |
| | adjacent contacts | 5.5 / 5.5 mm |
| Insulation to IEC 60664 | Voltage rating | 250 V |
| | Pollution degree | 2 |
| | Overvoltage category | III |
| | Insulation resistance (500 Vdc) | > 1x10 ⁶ Ω |
| Tracking resistance of relay base | | CTI 250 |

Other data

| | |
|---|---|
| Ambient temperature | -25...+70 °C |
| Mechanical life | ≥ 10x10 ⁶ operations |
| Max. switching rate at rated- / minimum load | 6 min ⁻¹ / 300 min ⁻¹ |
| Operate- / release time | typ. 11 / 3 ms |
| Vibration resistance N/O / N/C contact | > 8 / 5 g, 10...200 Hz |
| Shock resistance (function) N/O contact / N/C contact | > 8 / 6 g, 16ms half sine |
| Category of protection (IEC 61810) | RT III - wash tight |
| Relay weight | 30 g |
| Packaging unit | 10 pcs. |

Dimensions

Dimensions in mm

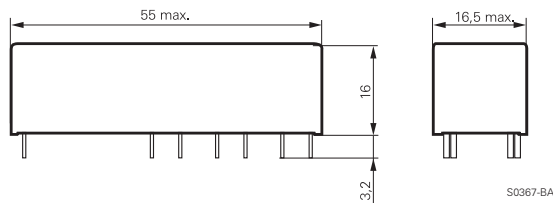

PCB layout / terminal assignment

View on solder pins
Dimensions in mm

4 N/O+2 N/C and 3 N/O+3 N/C versions

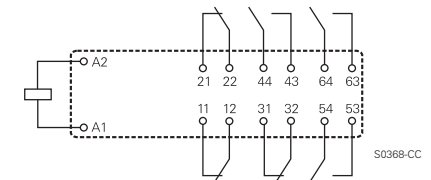
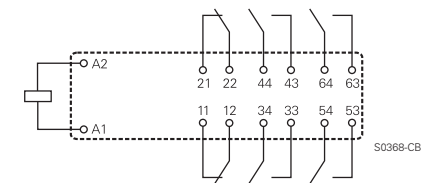
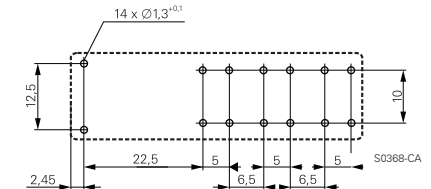

5 N/O + 1 N/C version

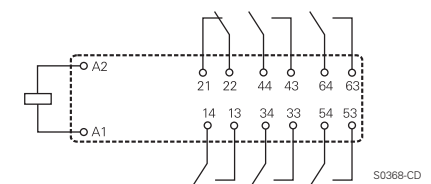
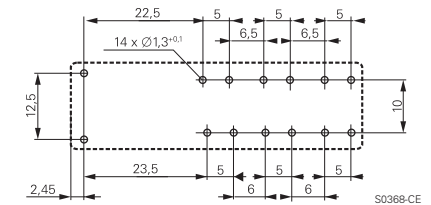

Product key

V 2 3 0 5 0 - A 1 - A 5

Type

Version

A1 standard

Coil

Coil code = nominal voltage (e.g. 024=24Vdc)

Contact type

A single contact

Contact material

5 AgSnO₂

Contact configuration

33 3 N/O and 3 N/C contacts

42 4 N/O and 2 N/C contacts

51 5 N/O and 1 N/C contacts

Other types on request

Safety Relay SR6

6 pole 8 A

| Product key | Version | Contact material | Configuration | Coil | Part number |
|-------------------|---------------|------------------|---------------|--------|-------------|
| V23050-A1005-A533 | standard | AgSnO | 3 N/O + 3 N/C | 5 Vdc | 8-1415017-1 |
| V23050-A1005-A542 | | | 4 N/O + 2 N/C | 5 Vdc | 0-1393260-1 |
| V23050-A1005-A551 | | | 5 N/O + 1 N/C | 5 Vdc | 2-1415017-1 |
| V23050-A1006-A533 | | | 3 N/O + 3 N/C | 6 Vdc | 9-1415017-1 |
| V23050-A1006-A542 | | | 4 N/O + 2 N/C | 6 Vdc | 0-1393260-2 |
| V23050-A1006-A551 | | | 5 N/O + 1 N/C | 6 Vdc | 3-1415017-1 |
| V23050-A1009-A533 | | | 3 N/O + 3 N/C | 9 Vdc | 0-1415018-1 |
| V23050-A1009-A542 | | | 4 N/O + 2 N/C | 9 Vdc | 0-1393260-3 |
| V23050-A1009-A551 | | | 5 N/O + 1 N/C | 9 Vdc | 4-1415017-1 |
| V23050-A1012-A533 | | | 3 N/O + 3 N/C | 12 Vdc | 1-1415015-1 |
| V23050-A1012-A542 | | | 4 N/O + 2 N/C | 12 Vdc | 0-1393260-4 |
| V23050-A1012-A551 | | | 5 N/O + 1 N/C | 12 Vdc | 1-1415017-1 |
| V23050-A1015-A533 | | | 3 N/O + 3 N/C | 15 Vdc | 1-1415018-1 |
| V23050-A1015-A542 | | | 4 N/O + 2 N/C | 15 Vdc | 6-1415014-1 |
| V23050-A1015-A551 | | | 5 N/O + 1 N/C | 15 Vdc | 5-1415017-1 |
| V23050-A1018-A533 | | | 3 N/O + 3 N/C | 18 Vdc | 2-1415018-1 |
| V23050-A1018-A542 | | | 4 N/O + 2 N/C | 18 Vdc | 0-1393260-5 |
| V23050-A1018-A551 | | | 5 N/O + 1 N/C | 18 Vdc | 6-1415017-1 |
| V23050-A1021-A533 | | | 3 N/O + 3 N/C | 21 Vdc | 3-1415018-1 |
| V23050-A1021-A542 | | | 4 N/O + 2 N/C | 21 Vdc | 0-1393260-6 |
| V23050-A1021-A551 | | | 5 N/O + 1 N/C | 21 Vdc | 7-1415017-1 |
| V23050-A1024-A533 | | | 3 N/O + 3 N/C | 24 Vdc | 0-1415015-1 |
| V23050-A1024-A542 | | | 4 N/O + 2 N/C | 24 Vdc | 0-1393260-7 |
| V23050-A1024-A551 | | | 5 N/O + 1 N/C | 24 Vdc | 0-1415017-1 |
| V23050-A1036-A533 | | | 3 N/O + 3 N/C | 36 Vdc | 4-1415018-1 |
| V23050-A1036-A542 | | | 4 N/O + 2 N/C | 36 Vdc | 0-1393260-8 |
| V23050-A1036-A551 | | | 5 N/O + 1 N/C | 36 Vdc | 0-1415019-1 |
| V23050-A1040-A533 | | | 3 N/O + 3 N/C | 40 Vdc | 5-1415018-1 |
| V23050-A1040-A542 | | | 4 N/O + 2 N/C | 40 Vdc | 0-1393260-9 |
| V23050-A1040-A551 | | | 5 N/O + 1 N/C | 40 Vdc | 1-1415019-1 |
| V23050-A1048-A533 | | | 3 N/O + 3 N/C | 48 Vdc | 6-1415018-1 |
| V23050-A1048-A542 | | | 4 N/O + 2 N/C | 48 Vdc | 1-1393260-0 |
| V23050-A1048-A551 | 5 N/O + 1 N/C | 48 Vdc | 2-1415019-1 | | |
| V23050-A1060-A533 | 3 N/O + 3 N/C | 60 Vdc | 7-1415018-1 | | |
| V23050-A1060-A542 | 4 N/O + 2 N/C | 60 Vdc | 1-1393260-1 | | |
| V23050-A1060-A551 | 5 N/O + 1 N/C | 60 Vdc | 3-1415019-1 | | |
| V23050-A1085-A533 | 3 N/O + 3 N/C | 85 Vdc | 8-1415018-1 | | |
| V23050-A1085-A542 | 4 N/O + 2 N/C | 85 Vdc | 1-1393260-2 | | |
| V23050-A1085-A551 | 5 N/O + 1 N/C | 85 Vdc | 4-1415019-1 | | |
| V23050-A1110-A533 | 3 N/O + 3 N/C | 110 Vdc | 9-1415018-1 | | |
| V23050-A1110-A542 | 4 N/O + 2 N/C | 110 Vdc | 1-1393260-3 | | |
| V23050-A1110-A551 | 5 N/O + 1 N/C | 110 Vdc | 5-1415019-1 | | |

Safety Relay SR6 sensitive

6 pole 8 A



F0206-B

Features

- Forcibly guided contacts according to EN50205
- polarized, monostable with 800 mW coil power consumption
- Smallest 6 pole safety relay with either 4 N/O+2 N/C or 3 N/O+3 N/C or 5 N/O+1 N/C contacts
- 6 kV surge resistance between poles

Applications

Emergency shut-off, press control, machine control, elevator and escalator control, safety modules



planned Technical data of approved types on request

Contact data

| | |
|---|---|
| Configuration | 3 N/O contact and 3 N/C contact or 4 N/O contact and 2 N/C contact or 5 N/O contact and 1 N/C contact |
| Type of contact | single contact, forcibly guided |
| Continuous thermal load | 8 A |
| Rated voltage / max.breaking voltage AC | 250 Vac / 440 Vac |
| Maximum breaking capacity AC | 2000 VA |
| Minimum contact load | > 50 mW |
| Contact resistance | ≤100 mΩ / 1 A / 24 Vdc ≤20 Ω / 10 mA / 5 Vdc |

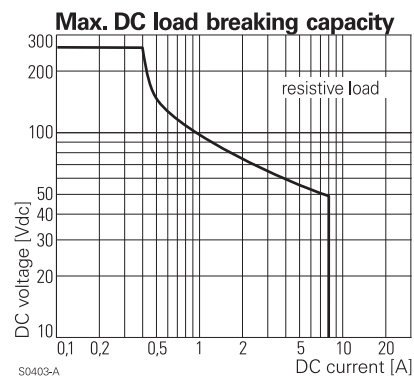

Coil data

| | |
|--------------------|------------------------|
| Nominal voltage | 5...48 Vdc |
| Nominal coil power | 800 mW |
| Operative range | 2 |
| Max. coil voltage | 150 % U _{nom} |

Coil versions

| Coil code | Nominal voltage Vdc | Pull-in voltage Vdc | Release voltage Vdc | Maximum voltage Vdc | Coil resistance Ω | Coil current mA |
|-----------|---------------------|---------------------|---------------------|---------------------|-------------------|-----------------|
| 05 | 5 | 3.8 | 0.5 | 7.5 | 31±10% | 161.3 |
| 06 | 6 | 4.5 | 0.6 | 9.0 | 45±10% | 133.3 |
| 09 | 9 | 6.8 | 0.9 | 13.5 | 101±10% | 89.1 |
| 12 | 12 | 9.0 | 1.2 | 18.0 | 180±10% | 66.7 |
| 15 | 15 | 11.3 | 1.5 | 22.5 | 281±10% | 53.4 |
| 18 | 18 | 13.5 | 1.8 | 27.0 | 405±10% | 44.4 |
| 21 | 21 | 15.8 | 2.1 | 31.5 | 551±10% | 38.1 |
| 24 | 24 | 18.0 | 2.4 | 36.0 | 720±10% | 33.3 |
| 36 | 36 | 27.0 | 3.6 | 54.0 | 1620±10% | 22.2 |
| 40 | 40 | 30.0 | 4.0 | 60.0 | 2000±10% | 20.0 |
| 48 | 48 | 36.0 | 4.8 | 72.0 | 2880±10% | 16.7 |

All figures are given for coil without preenergization, at ambient temperature +20°C
 U_{op max}: at 70 °C after preenergization with 1.1 x U_{nom} the max. operate voltage is 85% of U_{nom}. U_{max}: at 70 °C the max. coil voltage is 1.1 x U_{nom}
 Other coil voltages on request

Safety Relay SR6 sensitive

6 pole 8 A

| Insulation | | |
|-----------------------------------|----------------------|-----------------------|
| Dielectric strength | coil-contacts | 3000 V _{rms} |
| | open contact circuit | 1000 V _{rms} |
| | adjacent contacts | 3000 V _{rms} |
| Clearance / creepage | coil-contact | 5.5 / 5.5 mm |
| | adjacent contacts | 5.5 / 5.5 mm |
| Insulation to IEC 60664 | | |
| | Voltage rating | 250 V |
| | Pollution degree | 2 |
| | Overvoltage category | III |
| Insulation resistance (500 Vdc) | | > 1x10 ⁶ Ω |
| Tracking resistance of relay base | | CTI 250 |

| Other data | |
|---|---|
| Ambient temperature | -25...+70 °C |
| Mechanical life | ≥ 10x10 ⁶ operations |
| Max. switching rate at rated- / minimum load | 6 min ⁻¹ / 300 min ⁻¹ |
| Operate- / release time | typ. 11 / 3 ms |
| Vibration resistance N/O / N/C contact | > 8 / 5 g, 10...200 Hz |
| Shock resistance (function) N/O contact / N/C contact | > 8 / 6 g, 16ms half sine |
| Category of protection (IEC 61810) | RT III - wash tight |
| Relay weight | 30 g |
| Packaging unit | 10 pcs. |

Dimensions

Dimensions in mm

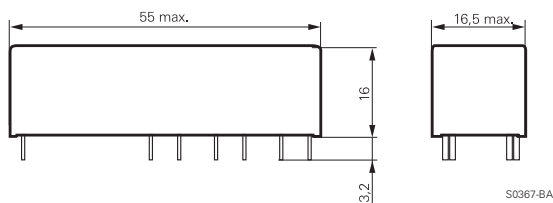

Release condition corresponds to the position shown. With positive potential on terminal A1 the relay changes to its operate position

PCB layout / terminal assignment

View on solder pins
Dimensions in mm

4 N/O+2 N/C and 3 N/O+3 N/C versions

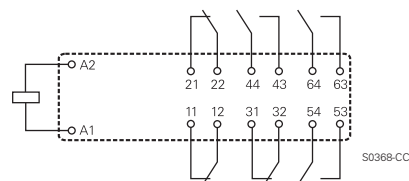
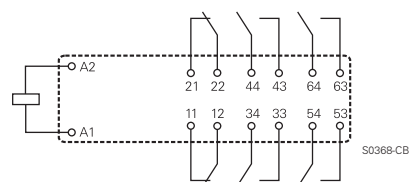
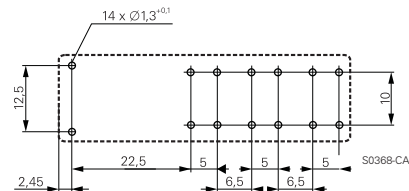

5 N/O + 1 N/C version

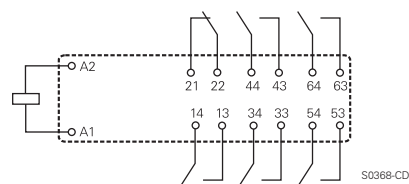
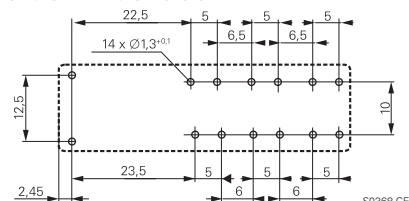

Product key



Type

Contact configuration

- A** 3 N/O + 3 N/C contacts
- B** 4 N/O + 2 N/C contacts
- C** 5 N/O + 1 N/C contacts

Contact material

4 AgSnO₂

Coil

S sensitive coil

Coil

DC coil code = nominal voltage (e.g. 24=24Vdc)

Other types on request

Safety Relay SR6 sensitive

6 pole 8 A

| Product key | Type | Contact configuration | Contact material | Coil | Part number | | | |
|-------------|-------------------------------------|---------------------------|------------------|---------------------------|-------------|--|--------|-------------|
| SR6A4S05 | sensitive 6 pole safety relay | 3 N/O + 3 N/C contacts | AgSnO | 5 Vdc | 0-1415057-1 | | | |
| SR6A4S06 | | | | 6 Vdc | 1-1415057-1 | | | |
| SR6A4S09 | | | | 9 Vdc | 2-1415057-1 | | | |
| SR6A4S12 | | | | 12 Vdc | 3-1415057-1 | | | |
| SR6A4S18 | | | | 18 Vdc | 4-1415057-1 | | | |
| SR6A4S21 | | | | 21 Vdc | 5-1415057-1 | | | |
| SR6A4S24 | | | | 24 Vdc | 6-1415057-1 | | | |
| SR6A4S36 | | | | 36 Vdc | 7-1415057-1 | | | |
| SR6A4S40 | | | | 40 Vdc | 8-1415057-1 | | | |
| SR6A4S48 | | | | 48 Vdc | 9-1415057-1 | | | |
| SR6B4S05 | | | | 4 N/O + 2 N/C contacts | | | 5 Vdc | 0-1415056-1 |
| SR6B4S06 | | | | | | | 6 Vdc | 1-1415056-1 |
| SR6B4S09 | | | | | | | 9 Vdc | 2-1415056-1 |
| SR6B4S12 | | | | | | | 12 Vdc | 3-1415056-1 |
| SR6B4S18 | | | | | | | 18 Vdc | 4-1415056-1 |
| SR6B4S21 | | | | | | | 21 Vdc | 5-1415056-1 |
| SR6B4S24 | | | | | | | 24 Vdc | 6-1415056-1 |
| SR6B4S36 | | | | | | | 36 Vdc | 7-1415056-1 |
| SR6B4S40 | 40 Vdc | 8-1415056-1 | | | | | | |
| SR6B4S48 | 48 Vdc | 9-1415056-1 | | | | | | |
| SR6C4S05 | 5 N/O + 1 N/C contacts | | | 5 Vdc | 0-1415058-1 | | | |
| SR6C4S06 | | | | 6 Vdc | 1-1415058-1 | | | |
| SR6C4S09 | | | | 9 Vdc | 2-1415058-1 | | | |
| SR6C4S12 | | | | 12 Vdc | 3-1415058-1 | | | |
| SR6C4S18 | | | | 18 Vdc | 4-1415058-1 | | | |
| SR6C4S21 | | | | 21 Vdc | 5-1415058-1 | | | |
| SR6C4S24 | | | | 24 Vdc | 6-1415058-1 | | | |
| SR6C4S36 | | | | 36 Vdc | 7-1415058-1 | | | |
| SR6C4S40 | | | | 40 Vdc | 8-1415058-1 | | | |
| SR6C4S48 | | | | 48 Vdc | 9-1415058-1 | | | |

Safety Relay on DIN-rail SR6 Z

6 pole 8 A

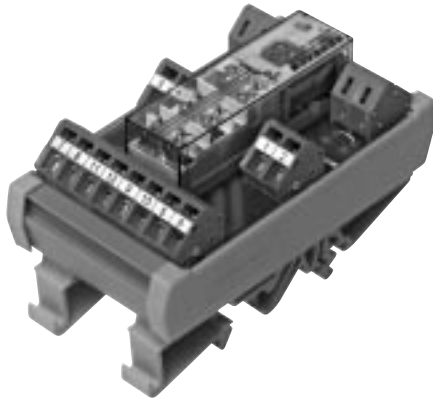

F0238-A

Features

- SR6 on printed circuit board
- AC/DC input
- Spring connectors
- Module width 46 mm

Applications

Elevator control, machine control



Technical data of approved types on request

Contact data

| | |
|---|---|
| Type of contact | single contact, forcibly guided |
| Maximum switching current / continuous thermal load | 8 A |
| Maximum switching voltage | 250 Vac / Vdc |
| Maximum breaking capacity AC | 2000 VA |
| Contact material | AgSnO ₂ |
| Minimum contact load | > 50 mW |
| Contact resistance | ≤100 mΩ / 1 A / 24 Vdc ≤20 Ω / 10 mA / 5 Vdc |

Terminal assignment

DC module, 4 N/O+2 N/C version

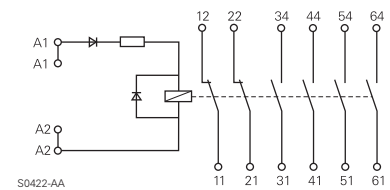

S0422-AA

Coil data

| | |
|---------------------------------------|--|
| DC energizing voltage Unom | 6, 12, 18, 21, 24, 36, 40, 48, 60, 115 Vdc |
| AC/DC energizing voltage Unom | 12, 21, 24, 40, 48, 60, 115 Vac/Vdc |
| AC energizing voltage Unom | 230 Vac |
| Input circuit | bridge rectifier, series resistor |
| Minimum operate voltage | 90% of Unom |
| Minimum release voltage (+23°C) | ≤10% of Unom |
| Maximum permissible operating voltage | 110% of Unom |

DC module, 3 N/O+3 N/C version

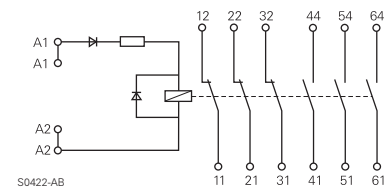

S0422-AB

Insulation

| | | |
|--|-----------------------|-----------------------|
| Surge voltage resistance coil-contacts | 3000 V _{rms} | |
| | open contact circuit | 1000 V _{rms} |
| | adjacent contacts | 2000 V _{rms} |
| Clearance / creepage | coil-contact | 5.5 / 5.5 mm |
| | adjacent contacts | 3 / 3 mm |
| Insulation to IEC 60664 | | |
| Voltage rating | 250 V | |
| Pollution degree | 2 | |
| Overvoltage category | III | |

DC module, 5 N/O+1 N/C version

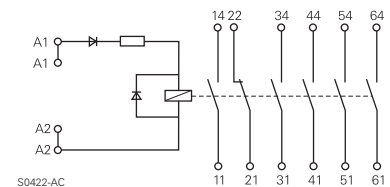

S0422-AC

AC/DC module, 4 N/O+2 N/C version

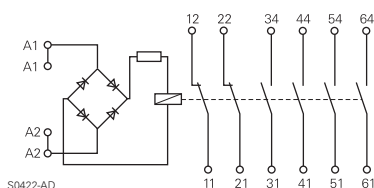

S0422-AD

AC/DC module, 3 N/O+3 N/C version

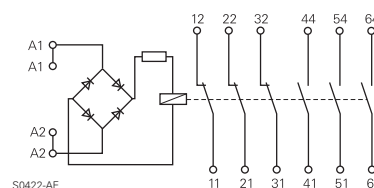

S0422-AE

AC/DC module, 5 N/O+1 N/C version

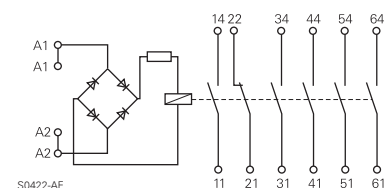

S0422-AF

Safety Relay on DIN-rail SR6 Z

6 pole 8 A

| Other data | |
|--|---|
| Flammability class according to UL 94 | |
| housing | V2 |
| housing cage clamp terminals | V0 |
| PCB | V0 |
| relay base | V0 |
| relay cover | V2 |
| Ambient temperature | -25...+50 °C |
| Mechanical life | ≥ 10x10 ⁶ operations |
| Max. switching rate at rated- / minimum load | 6 min ⁻¹ / 300 min ⁻¹ |
| Connections (according IEC) | |
| solid wire | 0.2...2.5 mm ² |
| stranded wire | 0.2...2.5 mm ² |
| AWG | 28...14 |
| Installation position | any |
| Mounting | in rows with zero spacing |
| Type of connection | spring clamp connection |
| Relay weight | 90 g |
| Packaging unit | 2 pcs. |

Dimensions

Dimensions in mm

Module width 46 mm
Module length 87 mm

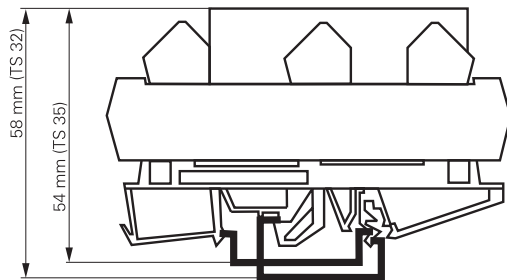

Fit onto mounting rails according to
DIN EN 50022 or DIN EN 50035

S0423-AA

Product key



Type

Contact configuration

- A** 3 N/O + 3 N/C contacts
- B** 4 N/O + 2 N/C contacts
- C** 5 N/O + 1 N/C contacts

Coil

DC coil code = nominal voltage (e.g. 024=24Vdc)
AC/DC coil code: 524=24Vac/dc, 615=115Vac/dc
AC coil code: 730=230Vac

Other types on request

| Product key | Type | Contact configuration | Contact material | Coil | Part number |
|-------------|----------------------------------|---------------------------|------------------|------------|-------------|
| SR6ZA024 | 6-pole safety relay module | 3 N/O + 3 N/C contacts | AgSnO | 24 Vdc | 7-1415033-1 |
| SR6ZA524 | | | | 24 Vac/dc | 9-1415059-1 |
| SR6ZA615 | | | | 115 Vac/dc | 0-1415060-1 |
| SR6ZA730 | | | | 230 Vac | 1-1415060-1 |
| SR6ZB024 | | 4 N/O + 2 N/C contacts | | 24 Vdc | 5-1415033-1 |
| SR6ZB524 | | | | 24 Vac/dc | 2-1415060-1 |
| SR6ZB615 | | | | 115 Vac/dc | 6-1415046-1 |
| SR6ZB730 | | | | 230 Vac | 3-1415060-1 |
| SR6ZC024 | | 5 N/O + 1 N/C contacts | | 24 Vdc | 3-1415042-1 |
| SR6ZC524 | | | | 24 Vac/dc | 4-1415060-1 |
| SR6ZC615 | | | | 115 Vac/dc | 5-1415060-1 |
| SR6ZC730 | | | | 230 Vac | 6-1415060-1 |

Slim Interface Relay SNR

1pole 6 A



F0222-B

Features

- Module width 5.08 mm
- Cadmium-free contacts
- Sensitive coil 170 mW
- 4 kV coil-contact, 6 / 8 mm clearance/creepage
- Protection class II (VDE 0601)
- Reduced system width for increased packing density on the DIN rail
- Jumper bar

Applications

Interface technology, panel boards, mechanical engineering, process control



Technical data of approved types on request

Contact data

| | |
|---|---|
| Configuration | 1 C/O contact |
| Type of contact | single contact |
| Rated current | 6 A |
| Rated voltage / max.breaking voltage AC | 250 Vac / 440 Vac |
| Maximum breaking capacity AC | 1500 VA |
| Contact material | AgSnO ₂ AgSnO ₂ gold plated |
| Minimum contact load | ≥100 mA, 12V ≥10 mA, 5 V |

Coil data

| | |
|--------------------|------------|
| Nominal voltage | 5...48 Vdc |
| Nominal coil power | 170 mW |
| Operate power | 75 mW |
| Operate category | 2 / b |

Coil versions

| Coil code | Nominal voltage Vdc | Pull-in voltage Vdc | Release voltage Vdc | Maximum voltage Vdc | Coil resistance Ω | Coil current mA |
|-----------|---------------------|---------------------|---------------------|---------------------|-------------------|-----------------|
| 005 | 5 | 3.5 | 0.25 | 11.2 | 147±10% | 34.0 |
| 012 | 12 | 8.4 | 0.6 | 26.8 | 848±10% | 14.2 |
| 024 | 24 | 16.8 | 1.2 | 53.7 | 3390±10% | 7.1 |
| 048 | 48 | 33.6 | 2.4 | 100.0 | 10600±15% | 4.5 |

All figures are given for coil without preenergization, at ambient temperature +20°C
Other coil voltages on request

Insulation

| | | |
|--|---|-----------------------|
| Dielectric strength | coil-contacts | 4000 V _{rms} |
| | open contact circuit | 1000 V _{rms} |
| Surge voltage resistance coil-contacts | | 6000 V (1.2 / 50 μs) |
| Clearance / creepage | | 6 / 8 mm |
| Insulation to IEC 60664 | Voltage rating | 250 V |
| | Pollution degree | 2 |
| | Overvoltage category | III |
| | Insulation to VDE 0110b (2/79) | |
| | Insulation category / reference voltage | C / 250 |
| Tracking resistance of relay base | | CTI 250 |

Max. DC load breaking capacity

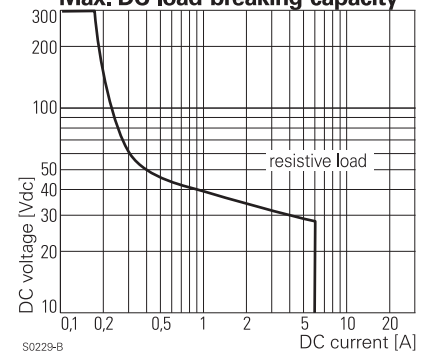

Electrical endurance

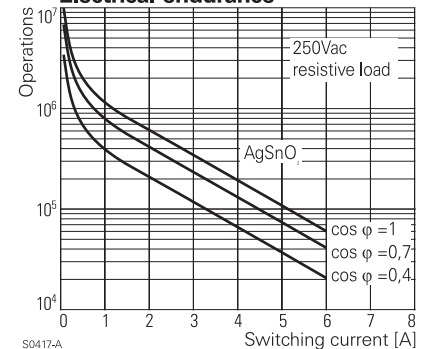

Coil operating range DC

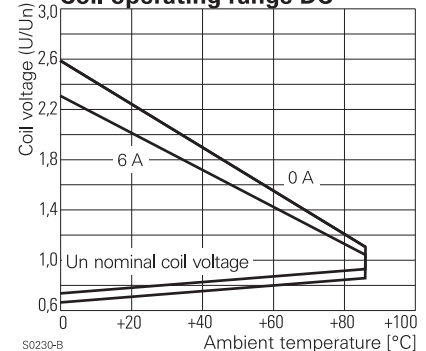

Slim Interface Relay SNR

1pole 6 A

| Other data | |
|--|--|
| Flammability class according to UL 94 | V-0 |
| Ambient temperature relay | -40...+85 °C |
| package | -20...+55 °C |
| Mechanical life | 10x10 ⁶ operations |
| Max. switching rate at rated- / minimum load | 6 min ⁻¹ / 1200 min ⁻¹ |
| Operate- / release time | 5 / 2.5 ms |
| Bounce time N/O contact/N/C contact | 1.5 / 5 ms |
| Category of protection (IEC 61810) | RT III |
| Relay weight | 6 g |
| Packaging unit relay | 20 pcs. |
| package | 10 pcs. |
| Accessories | see accessories SNR |

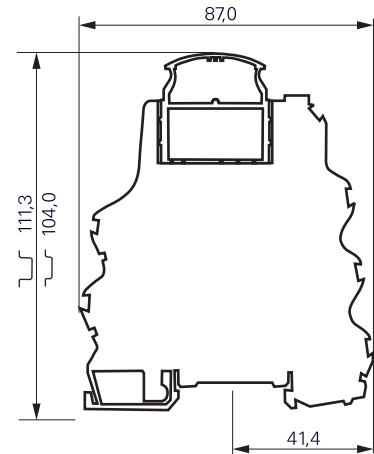

S0404-A

Product key

V 2 3 0 9 2 - A 1 - A 0 1

Type

Coil

Coil code: please refer to coil versions table

Contact material

2 AgSnO₂, gold plated **3** AgSnO₂

Contact configuration

01 1 C/O contact

Other types on request

| Product key | Version | Contacts | Cont. material | Coil | Part number |
|-------------------|------------------|---------------|--------------------|--------|-------------|
| V23092-A1005-A201 | plug-in | 1 C/O contact | AgSnO, gold plated | 5 Vdc | 0-1393236-1 |
| V23092-A1005-A301 | vertical version | | AgSnO | | 0-1393236-2 |
| V23092-A1012-A201 | wash tight | | AgSnO, gold plated | 12 Vdc | 0-1393236-4 |
| V23092-A1012-A301 | | | AgSnO | | 0-1393236-7 |
| V23092-A1024-A201 | | | AgSnO, gold plated | 24 Vdc | 2-1393236-1 |
| V23092-A1024-A301 | | | AgSnO | | 2-1393236-4 |
| V23092-A1048-A201 | | | AgSnO, gold plated | 48 Vdc | 3-1393236-5 |
| V23092-A1048-A301 | | | AgSnO | | 3-1393236-7 |

Available sets

Set consisting of: relay in mounting frame, mounted on socket

| Product code | | Part Number |
|-------------------|---|-------------|
| ST 1P3 024 | 24 Vdc, AgSnO ₂ contacts | 3-1415024-1 |
| ST 1P3 L12 | 12 Vdc, with LED, AgSnO ₂ contacts | 2-1415025-1 |
| ST 1P3 L24 | 24 Vdc, with LED, AgSnO ₂ contacts | 3-1415025-1 |
| ST 1P3 L48 | 48 Vdc, with LED, AgSnO ₂ contacts | 4-1415025-1 |
| ST 1P2 L24 | 24 Vdc, with LED, AgSnO ₂ gold plated contacts | 6-1415025-1 |

Interface Power Relay RT

1 pole 12 / 16 A, 2 pole 8 A, DC- or AC coil



F0250-A

Features

- 1 C/O 12 or 16 A or 2 C/O 8 A
- Sensitive coil 400 mW
- Cadmium-free contacts
- Protection class II (VDE 0700)
- 5 kV / 10 mm coil-contact
- 1pole 12 A with 3.5 or 5 mm pinning
- Plug-in relay with robust pins
- Recycleable packaging

Applications

Panel boards, mechanical engineering



Technical data of approved types on request

Contact data

| | | |
|---|-------------------|---------------|
| Configuration | 1 C/O contact | 2 C/O contact |
| Type of contact | single contact | |
| Rated current | 12 / 16 A | 8 A |
| Rated voltage / max.breaking voltage AC | 250 Vac / 440 Vac | |
| Maximum breaking capacity AC | 3000 / 4000 VA | 2000 VA |
| Make current (max. 4 s at duty cycle 10%) | 25 / 30 A | 15 A |
| Contact material | AgNi 90/10 | |
| Minimum contact load | 24 V, 10 mA | |

Contact ratings

| Type | Load | Operations | Standard |
|-------|----------------------------|-------------------|----------|
| RT314 | 16 A, 250 Vac, C/O contact | 3x10 ⁴ | VDE 0435 |

Coil data

| | | |
|--------------------|---------|--------------|
| Nominal voltage | DC coil | 6...110 Vdc |
| | AC coil | 24...230 Vac |
| Nominal coil power | DC coil | 400 mW |
| | AC coil | 0.75 VA |
| Operate category | 2 / b | |

Coil versions, DC-coil

| Coil code | Nominal voltage Vdc | Pull-in voltage Vdc | Release voltage Vdc | Maximum voltage Vdc | Coil resistance Ω | Coil current mA |
|------------|---------------------|---------------------|---------------------|---------------------|-------------------|-----------------|
| 006 | 6 | 4.2 | 0.6 | 15.3 | 90 ± 10% | 66.7 |
| 012 | 12 | 8.4 | 1.2 | 30.6 | 360 ± 10% | 33.3 |
| 024 | 24 | 16.8 | 2.4 | 61.2 | 1440 ± 10% | 16.7 |
| 048 | 48 | 33.6 | 4.8 | 122.4 | 5520 ± 10% | 8.7 |
| 060 | 60 | 42.0 | 6.0 | 153.0 | 7340 ± 12% | 8.1 |
| 110 | 110 | 77.0 | 11.0 | 280.5 | 26600 ± 12% | 4.1 |

All figures are given for coil without preenergization, at ambient temperature +20°C

Other coil voltages on request

Max. DC load breaking capacity

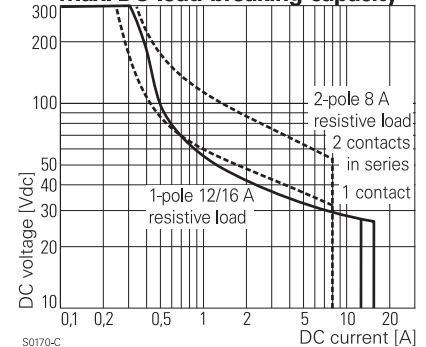

S0170-C

Electrical endurance

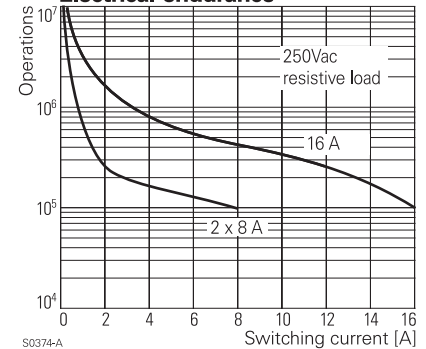

S0374-A

Coil operating range DC

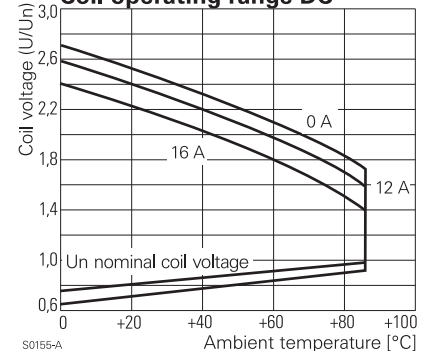

S0155-A

Interface Power Relay RT

1 pole 12 / 16 A, 2 pole 8 A, DC- or AC coil

Coil versions, AC-coil

| Coil code | Nominal voltage Vac | Pull-in voltage Vac | Release voltage Vac | Maximum voltage Vac | Coil resistance Ω | Coil current mA |
|------------|---------------------|---------------------|---------------------|---------------------|--------------------------|-----------------|
| 524 | 24 | 18.0 | 7.2 | 36.0 | 350 ± 10% | 31.6 |
| 615 | 115 | 86.3 | 34.5 | 172.5 | 8100 ± 15% | 6.6 |
| 730 | 230 | 172.5 | 69.0 | 345.0 | 32500 ± 15% | 3.2 |

All figures are given for coil without preenergization, at ambient temperature +20°C
Other coil voltages on request

Insulation

| | | |
|---|----------------------|-----------------------|
| Dielectric strength | coil-contacts | 5000 V _{rms} |
| | open contact circuit | 1000 V _{rms} |
| | adjacent contacts | 2500 V _{rms} |
| Clearance / creepage | | ≥ 10 / 10 mm |
| Insulation to IEC 60664 | | |
| Voltage rating | | 250 V |
| Pollution degree | | 3 |
| Overvoltage category | | III |
| Insulation to VDE 0110b (2/79) | | |
| Insulation category / reference voltage | | C / 250 |
| Tracking resistance of relay base | | CTI 250 |

Other data

| | 1 C/O contact | 2 C/O contact |
|--|--|--------------------------|
| Flammability class according to UL 94 | V-0 | |
| Ambient temperature | -40...+70°C | |
| Mechanical life DC-coil | >30x10 ⁶ ops. | >30x10 ⁶ ops. |
| AC-coil | >10x10 ⁶ ops. | >5x10 ⁶ ops. |
| Max. switching rate at rated- / minimum load | 6 min ⁻¹ / 1200 min ⁻¹ | |
| Operate- / release time DC-coil | typ. 7 / 3 ms | typ. 7 / 2 ms |
| Bounce time N/O contact/N/C contact | typ. 1 / 3 ms | typ. 1 / 3 ms |
| Vibration resistance N/O / N/C contact | >10 / 5 g; 30...150 Hz | |
| Shock resistance (destruction) | >100 g | |
| Category of protection (IEC 61810) | RT II | |
| Relay weight | 14 g | |
| Packaging unit | 20 / 500 pcs. | |
| Accessories | see accessories RT | |

Coil operating range AC

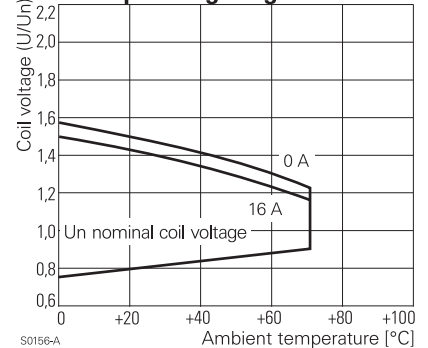

Terminal assignment

View on pins

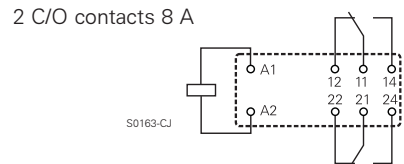
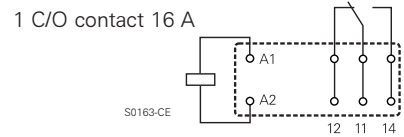
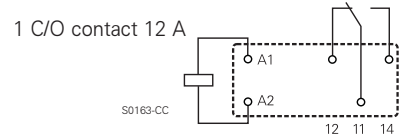

Dimensions

Dimensions in mm

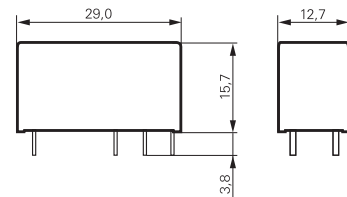

Product key

Type

Version

1 1-pole, 12 A, pinning 3.5 mm **3** 1-pole, 16 A, pinning 5 mm
2 1-pole, 12 A, pinning 5 mm **4** 2-pole, 8 A, pinning 5 mm

Contact configuration

1 1 C/O contact **2** 2 C/O contacts

Contact material

4 AgNi 90/10

Coil

Coil code: please refer to coil versions table, preferred types in bold print

Washable version on request

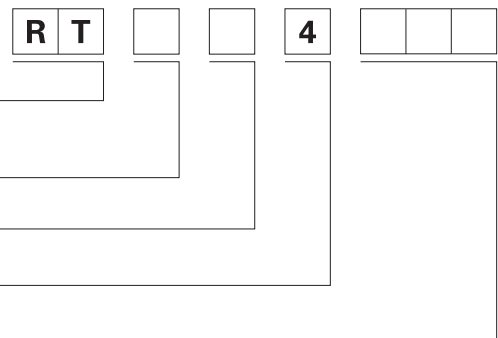

Interface Power Relay RT

1 pole 12 / 16 A, 2 pole 8 A, DC- or AC coil

| Product key | Version | Contacts | Cont. material | Coil | Coil | Part number |
|-------------|--------------------------------|----------------|----------------|---------|---------|-------------|
| RT114024 | 1-pole, 12 A pinning 3.5 mm | 1 C/O contact | AgNi 90/10 | DC-coil | 24 Vdc | 1-1393239-3 |
| RT114524 | | | | AC-coil | 24 Vac | 1-1393239-7 |
| RT114615 | | | | | 115 Vac | 1-1393239-8 |
| RT114730 | | | | | 230 Vac | 1-1393239-9 |
| RT214024 | 1-pole, 12 A pinning 5 mm | | | DC-coil | 24 Vdc | 5-1393239-5 |
| RT214524 | | | | AC-coil | 24 Vac | 5-1393239-9 |
| RT214615 | | | | | 115 Vac | 6-1393239-0 |
| RT214730 | | | | | 230 Vac | 0-1419108-6 |
| RT314024 | 1-pole, 16 A pinning 5 mm | | | DC-coil | 24 Vdc | 9-1393239-8 |
| RT314524 | | | | AC-coil | 24 Vac | 0-1393240-4 |
| RT314615 | | | | | 115 Vac | 0-1393240-6 |
| RT314730 | | | | | 230 Vac | 0-1393240-7 |
| RT424024 | 2-pole, 8 A pinning 5 mm | 2 C/O contacts | | DC-coil | 24 Vdc | 6-1393243-8 |
| RT424524 | | | | AC-coil | 24 Vac | 7-1393243-6 |
| RT424615 | | | | | 115 Vac | 7-1393243-8 |
| RT424730 | | | | | 230 Vac | 7-1393243-9 |

Miniature Relay PT

2 pole 12 A, 3 pole 10 A or 4 pole 6 A
DC- or AC-coil



F0191-A

Features

- 2, 3 or 4 C/O contacts
- Switching performance up to 3000 VA
- Relay height 29 mm
- Cadmium-free contact material
- Mechanical and electrical indicator
- Manual test tab, optionally lockable.
- White marking tabs

Applications

Universal use in control and automation



Technical data of approved types on request

| Contact data | PT2 | PT3 | PT5 |
|---|---------------------------------------|---------|---------|
| Configuration | 2 C/O | 3 C/O | 4 C/O |
| Type of contact | single contacts | | |
| Rated current | 12 A | 10 A | 6 A |
| Rated voltage / max.breaking voltage AC | 250 Vac | 250 Vac | 250 Vac |
| Maximum switching voltage | 440 Vac | 440 Vac | 250 Vac |
| Maximum breaking capacity AC | 3000 VA | 2500 VA | 1500 VA |
| Make current | 24 A | 20 A | 12 A |
| Contact material | AgNi 90/10, AgNi 90/10 gold plated | | |
| Minimum contact load | 24 V, 10 mA / 20 mV, 1 mA gold plated | | |

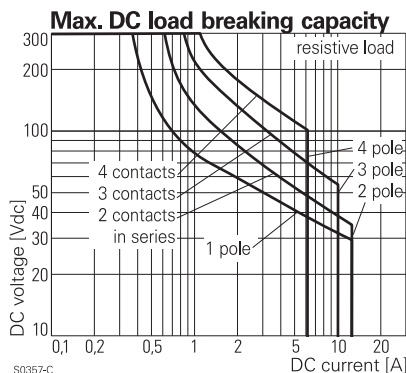

Contact ratings

| Type | Load | Operations | Standard |
|-------|----------------------------------|-------------------|----------|
| PT570 | 6 A, 250 Vac, on the C/O contact | 1x10 ⁵ | VDE 0435 |

Coil data

| | | |
|--|----------------------------|-------------|
| Nominal voltage | DC coil | 6...220 Vdc |
| | AC coil | 6...230 Vac |
| Nominal coil power | DC coil | typ. 0.75 W |
| | AC coil | typ. 1.0 VA |
| Operate category | 2 / b | |
| Operating range for AC coil 60Hz at 70°C | 90...110% U _{nom} | |

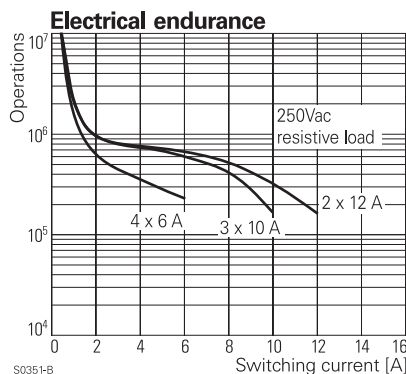

Coil versions, DC-coil

| Coil code | Nominal voltage | Pull-in voltage | Release voltage | Coil resistance | Coil current | |
|------------|-----------------|-----------------|-----------------|-----------------|----------------|-------------|
| Standard | LED bipolar | Vdc | Vdc | Ω | mA | |
| 006 | L06 | 6 | 4.5 | 0.6 | 48±10% | 125.0 |
| 012 | L12 | 12 | 9.0 | 1.2 | 192±10% | 62.5 |
| 024 | L24 | 24 | 18.0 | 2.4 | 777±10% | 31.3 |
| 048 | L48 | 48 | 36.0 | 4.8 | 3072±10% | 15.6 |
| 060 | L60 | 60 | 45.0 | 6.0 | 4845±12% | 12.5 |
| 110 | M10 | 110 | 82.5 | 11.0 | 16133±15% | 6.8 |
| 220 | N20 | 220 | 165.0 | 22.0 | 64533±15% | 3.4 |

All figures are given for coil without preenergization, at ambient temperature +20°C

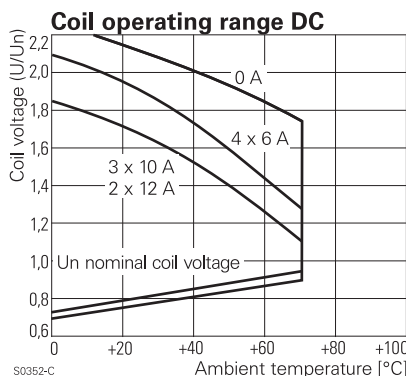

Miniature Relay PT

2 pole 12 A, 3 pole 10 A or 4 pole 6 A
DC- or AC-coil

Coil versions, AC-coil

| Coil code | | Nominal voltage | Pull-in voltage | Release voltage | Coil resistance | Coil current |
|------------|------------|-----------------|-----------------|-----------------|------------------------------------|--------------|
| Standard | LED | Vac | Vac | Vac | Ω | mA |
| 506 | R06 | 6 | 4.8 | 1.8 | $11 \pm 10\%$ | 166.5 |
| 512 | R12 | 12 | 9.6 | 3.6 | $48 \pm 10\%$ | 83.3 |
| 524 | R24 | 24 | 19.2 | 7.2 | $192 \pm 10\%$ | 41.6 |
| 548 | R48 | 48 | 38.4 | 14.4 | $777 \pm 10\%$ | 21.3 |
| 560 | R60 | 60 | 48.0 | 18.0 | $1306 \pm 10\%$ | 16.7 |
| 615 | S15 | 115 | 92.0 | 34.5 | $4845 \pm 12\%$ | 8.8 |
| 730 | T30 | 230 | 184.0 | 69.0 | $19465 \pm 15\%$ | 4.3 |

All figures are given for coil without preenergization, at ambient temperature +20°C

Coil operating range AC

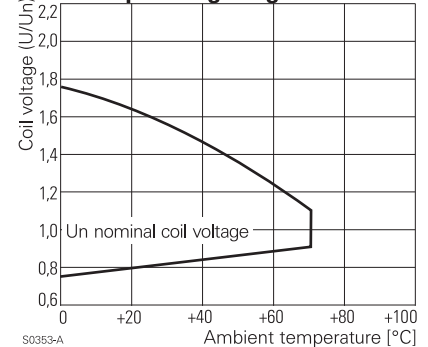

| Insulation | PT2 | PT3 | PT5 |
|---|-----------------------|-----------------------|-----------------------|
| Dielectric strength coil-contacts | 2500 V _{rms} | 2500 V _{rms} | 2500 V _{rms} |
| open contact circuit in unenergized position typ. adjacent contacts | 1500 V _{rms} | 1500 V _{rms} | 1500 V _{rms} |
| | 2500 V _{rms} | 2500 V _{rms} | 2000 V _{rms} |
| Clearance / creepage | 3 / 4 mm | 2.6 / 4 mm | 1.8 / 3 mm |
| Insulation to IEC 60664 | | | |
| Voltage rating | 240 V | 240 V | 240 V |
| Pollution degree | 3 | 3 | 2 |
| Overvoltage category | III | III | III |
| Insulation to VDE 0110b (2/79) | | | |
| Insulation category / ref. voltage | C / 250 | C / 250 | B / 250 |
| Tracking resistance of relay base | | CTI 175 | |

Other data

| | |
|---|--|
| Flammability class according to UL 94 | V-0 |
| Ambient temperature | DC-coil -40...+70 °C AC-coil -40...+70 °C |
| Mechanical life | DC-coil >30x10 ⁶ ops. AC-coil >20x10 ⁶ ops. |
| Max. switching rate at rated- / minimum load | 6 min ⁻¹ / 600 min ⁻¹ |
| Operate- / release time | 15 / 10 ms |
| Bounce time | 5 ms |
| Vibration resistance N/O contact/N/C contact | >7 / 4 g |
| Shock resistance (function) N/O contact/N/C contact | >20 / 5 g |
| Category of protection (IEC 61810) | RT II |
| Relay weight | 30 g |
| Packaging unit | 10 pcs. |
| Accessories | see accessories PT |

Miniature Relay PT

2 pole 12 A, 3 pole 10 A or 4 pole 6 A
DC- or AC-coil

PCB layout / terminal assignment

View on solder pins
Dimensions in mm

4-pole

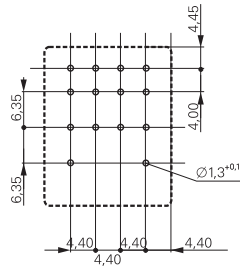

S0354-AA

3-pole

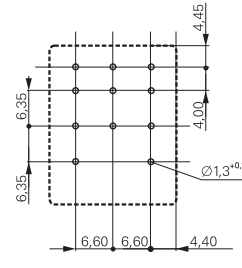

S0354-AB

2-pole

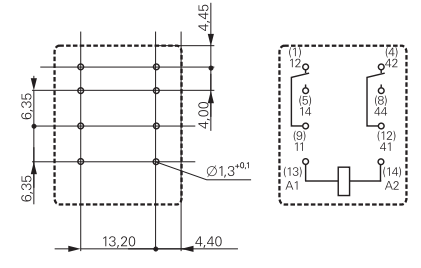

S0354-AE

S0354-AC

S0354-AF

Dimensions

Dimensions in mm

Solder- and plug-in terminals (standard version)

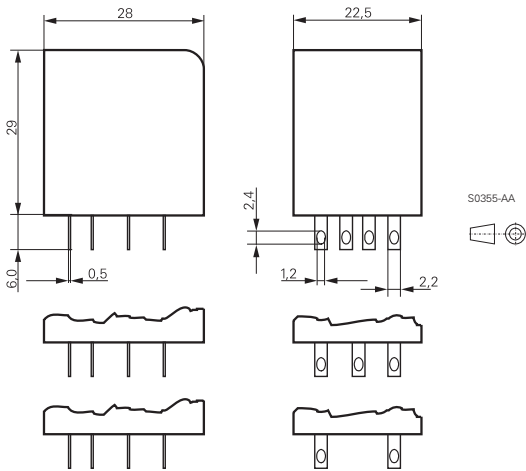

S0355-AA

PCB version

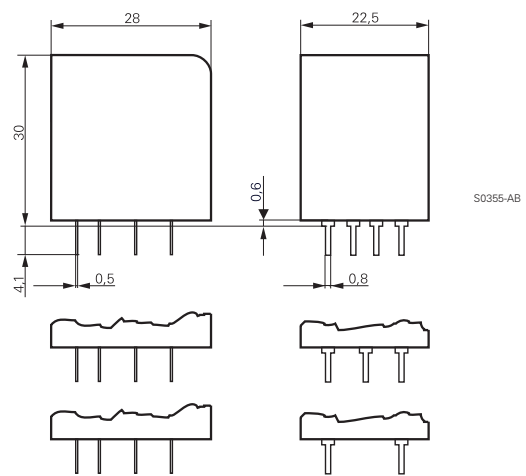

S0355-AB

Product key

Type

Contact configuration

- 2** 2 C/O contacts
- 3** 3 C/O contacts
- 5** 4 C/O contacts

Contact material

- 7** AgNi 90/10, with test button*)
- 8** AgNi 90/10, gold plated, with test button*)

Version

- 0** standard, AMP 2.8
- 1** PCB terminals

Coil

Coil code: please refer to coil versions table, preferred types in bold print

*) Version with closed cap without test button available on request.

Other types on request.

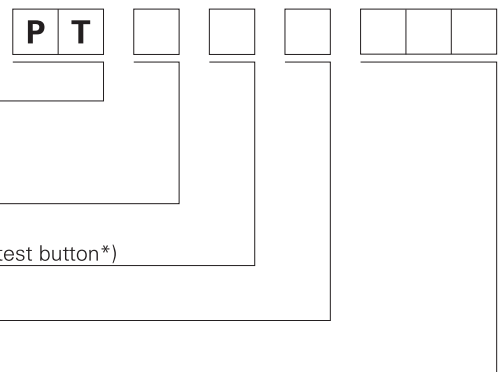

Miniature Relay PT

2 pole 12 A, 3 pole 10 A or 4 pole 6 A
DC- or AC-coil

| Product key | Cont. config. | Cont. material | Version | Coil | Coil | Part number | | | |
|-------------|----------------|--|-----------------------|-------------|---------------|---------------|-------------|-------------|-------------|
| PT270024 | 2 C/O contacts | AgNi 90/10 test button | AMP 2.8 connectors | DC coil | 24 Vdc | 4-1419111-2 | | | |
| PT270524 | | | | AC-coil | 24 Vac | 4-1419111-8 | | | |
| PT270615 | | | | | 115 Vac | 5-1419111-0 | | | |
| PT270730 | | | | | 230 Vac | 5-1419111-1 | | | |
| PT270L24 | | | | | DC coil+LED | 24 Vdc | 9-1415001-1 | | |
| PT270R24 | | | | | AC-coil+LED | 24 Vac | 0-1415002-1 | | |
| PT270S15 | | | | | | 115 Vac | 2-1415039-1 | | |
| PT270T30 | | | | | | 230 Vac | 3-1415002-1 | | |
| PT271024 | | | | | | PCB terminals | DC coil | 24 Vdc | 5-1419111-3 |
| PT271524 | | | | | | | AC-coil | 24 Vac | 5-1419111-6 |
| PT271615 | | | | | 115 Vac | 4-1419135-0 | | | |
| PT271730 | | | | | 230 Vac | 5-1419111-8 | | | |
| PT370024 | 3 C/O contacts | AgNi 90/10 test button | AMP 2.8 connectors | DC coil | 24 Vdc | 6-1419111-1 | | | |
| PT370524 | | | | AC-coil | 24 Vac | 6-1419111-6 | | | |
| PT370615 | | | | | 115 Vac | 6-1419111-8 | | | |
| PT370730 | | | | | 230 Vac | 6-1419111-9 | | | |
| PT370L24 | | | | | DC coil+LED | 24 Vdc | 5-1415002-1 | | |
| PT370R24 | | | | | AC-coil+LED | 24 Vac | 7-1415002-1 | | |
| PT370S15 | | | | | | 115 Vac | 9-1415039-1 | | |
| PT370T30 | | | | | | 230 Vac | 9-1415002-1 | | |
| PT371024 | | | | | | PCB terminals | DC coil | 24 Vdc | 7-1419111-1 |
| PT371524 | | | | | | | AC-coil | 24 Vac | 7-1419111-3 |
| PT371615 | | | | | 115 Vac | 0-1393154-8 | | | |
| PT371730 | | | | | 230 Vac | 7-1419111-5 | | | |
| PT570024 | 4 C/O contacts | AgNi 90/10 test button | AMP 2.8 connectors | DC coil | 24 Vdc | 1-1393154-2 | | | |
| PT570524 | | | | AC-coil | 24 Vac | 8-1419111-7 | | | |
| PT570615 | | | | | 115 Vac | 9-1419111-0 | | | |
| PT570730 | | | | | 230 Vac | 9-1419111-1 | | | |
| PT570L24 | | | | | DC coil+LED | 24 Vdc | 6-1415001-1 | | |
| PT570R24 | | | | | AC-coil+LED | 24 Vac | 7-1415001-1 | | |
| PT570S15 | | | | | | 115 Vac | 7-1415003-1 | | |
| PT570T30 | | | | | | 230 Vac | 8-1415001-1 | | |
| PT571024 | | | | | | PCB terminals | DC coil | 24 Vdc | 9-1419111-3 |
| PT571524 | | | | | | | AC-coil | 24 Vac | 9-1419111-6 |
| PT571615 | | | | | 115 Vac | 1-1393154-5 | | | |
| PT571730 | | | | | 230 Vac | 9-1419111-8 | | | |
| PT580024 | | AgNi 90/10 gold plated test button | AMP 2.8 connectors | DC coil | 24 Vdc | 1-1393154-7 | | | |
| PT580524 | AC-coil | | | 24 Vac | 2-1393154-1 | | | | |
| PT580730 | | | | 230 Vac | 2-1393154-2 | | | | |
| PT580L24 | | | | DC coil+LED | 24 Vdc | 5-1415026-1 | | | |
| PT580R24 | | | | AC-coil+LED | 24 Vac | 6-1415026-1 | | | |
| PT580T30 | | | | | 230 Vac | 7-1415026-1 | | | |
| PT581024 | | | | | PCB terminals | DC coil | 24 Vdc | 7-1419135-2 | |
| PT581730 | | | | | | AC-coil | 230 Vac | 2-1393154-3 | |

Miniature Power Relay PCLH

2 pole 10 A, DC- or AC-coil



Features

- 2 C/O contacts
- 10 A rated current
- DC- or AC-coil
- Plug-in version, PCB or chassis mount version

Applications

Panel boards, domestic appliances

F0162-A



Technical data of approved types on request

Contact data

| | |
|---|-------------------|
| Configuration | 2 C/O contact |
| Type of contact | single contact |
| Rated current | 10 A |
| Rated voltage / max.breaking voltage AC | 250 Vac / 250 Vac |
| Maximum breaking capacity AC | 2500 VA |
| Make current (max. 4 s at duty cycle 10%) | 15 A |
| Contact material | AgCdO |

Coil data

| | | |
|--------------------|---------|--------------|
| Nominal voltage | DC coil | 12...48 Vdc |
| | AC coil | 12...230 Vac |
| Nominal coil power | DC coil | 900 mW |
| | AC coil | 1.2 VA |

Electrical endurance

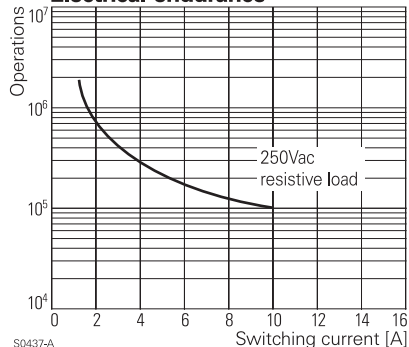

Coil versions, DC-coil

| Coil code | Nominal voltage Vdc | Pull-in voltage Vdc | Release voltage Vdc | Coil resistance Ω | Coil current mA |
|------------|---------------------|---------------------|---------------------|-------------------|-----------------|
| 02D | 12 | 9.6 | 1.2 | 160±10% | 75.0 |
| 03D | 24 | 19.2 | 2.4 | 650±10% | 37.2 |
| 04D | 48 | 38.4 | 4.8 | 2600±10% | 18.5 |

All figures are given for coil without preenergization, at ambient temperature +20°C

Coil versions, AC-coil

| Coil code | Nominal voltage Vac | Pull-in voltage Vac | Release voltage Vac | Coil resistance Ω | Coil current mA |
|------------|---------------------|---------------------|---------------------|-------------------|-----------------|
| 02A | 12 | 9.6 | 3.6 | 40±10% | 101.7 |
| 03A | 24 | 19.2 | 7.2 | 160±10% | 50.0 |
| 04A | 48 | 38.4 | 14.4 | 600±10% | 25.4 |
| 06A | 115 | 92.0 | 34.5 | 3400±10% | 10.5 |
| 08A | 230 | 184.0 | 69.0 | 13600±10% | 5.3 |

All figures are given for coil without preenergization, at ambient temperature +20°C

Coil operating range DC

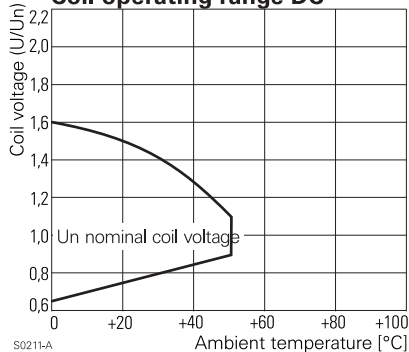

Insulation

| | | |
|----------------------|----------------------|-----------------------|
| Dielectric strength | coil-contacts | 1500 V _{rms} |
| | open contact circuit | 1000 V _{rms} |
| | adjacent contacts | 1500 V _{rms} |
| Clearance / creepage | | >1.2 / 1.2 mm |

Miniature Power Relay PCLH

2 pole 10 A, DC- or AC-coil

Other data

| | |
|--|--|
| Flammability class according to UL 94 | V-0 |
| Ambient temperature | -10...+55 °C |
| Mechanical life | >10x10 ⁶ operations |
| Max. switching rate at rated- / minimum load | 30 min ⁻¹ / 300 min ⁻¹ |
| Operate- / release time | 15 / 5 ms |
| Vibration resistance | 10...55 Hz, 1 mm double amplitude |
| Shock resistance (function) | >10 g |
| Shock resistance (destruction) | >100 g |
| Category of protection (IEC 61810) | RT I |
| Relay weight | 32 g |
| Packaging unit | 50 / 500 pcs. |
| Accessories | see accessories PCLH |

PCB layout / terminal assignment

View on solder pins
Dimensions in mm

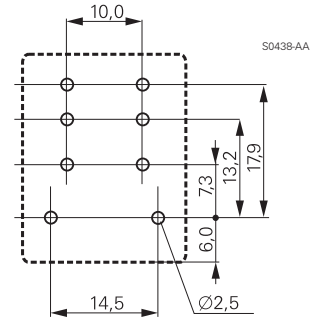

Dimensions

Dimensions in mm

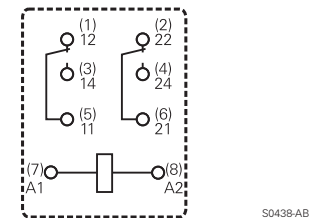
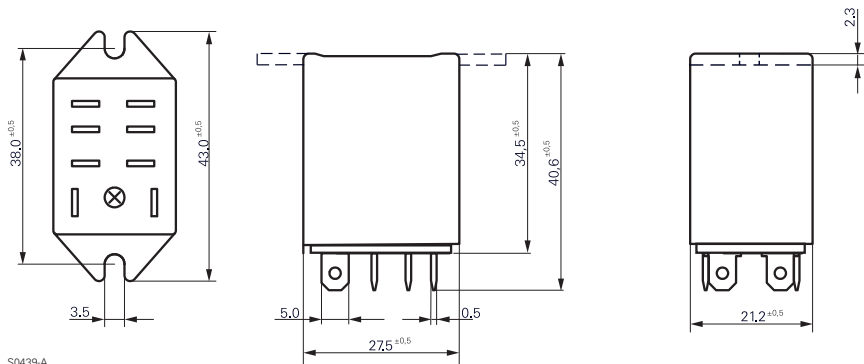

Product key



Type

Number of contacts

2 2 C/O contact, dust protected

Coil

Coil code: please refer to coil versions table

Contact material

1 AgCdO

Enclosure

- S** case with AMP-Faston 187 terminals
- F** case for flange mount, AMP-Faston 187
- SP** case with PCB terminals

Other types on request

| Product key | Cont. Config. | Cont. material | Enclosure | Coil | Coil | Part number | | | |
|--------------|----------------------------------|---------------------------|---|---------|---------------------------|---------------|---------|---------|-------------|
| PCLH-203D1S | 2 C/O contacts dust-protected | AgCdO Faston terminals | AMP 187 | DC-coil | 24 Vdc | 7-1440007-1 | | | |
| PCLH-203A1S | | | | AC-coil | 24 Vac | 6-1461068-3 | | | |
| PCLH-206A1S | AMP 187 Faston terminals | AgCdO Faston terminals | flange mount AMP 187 Faston terminals | DC-coil | 115 Vac | 5-1461068-8 | | | |
| PCLH-208A1S | | | | | 230 Vac | 7-1440007-5 | | | |
| PCLH-203D1F | | | | AC-coil | 24 Vdc | 5-1461068-0 | | | |
| PCLH-203A1F | | | | | 24 Vac | 4-1461068-2 | | | |
| PCLH-206A1F | 230 Vac | AgCdO Faston terminals | PCB terminals | DC-coil | 115 Vac | 4-1461068-5 | | | |
| PCLH-208A1F | | | | | 230 Vac | 1-1440009-6 | | | |
| PCLH-203D1SP | 2 C/O contacts dust-protected | AgCdO Faston terminals | AMP 187 Faston terminals | AC-coil | 24 Vdc | 5-1461059-5 | | | |
| PCLH-203A1SP | | | | | 24 Vac | 6-1461059-3 | | | |
| PCLH-206A1SP | | | | 230 Vac | AgCdO Faston terminals | PCB terminals | DC-coil | 115 Vac | 5-1461059-8 |
| PCLH-208A1SP | | | | | | | | 230 Vac | 6-1461059-0 |

Multimode Relay MT

2 / 3 pole 10 A, DC- or AC-coil



Features

- 2 C/O or 3 C/O contacts
- Cadmium-free contacts
- DC and AC coils
- Mechanical indicator as standard
- Electrical indicator
- New test system with front operated finger protected push-to-test button and integral locking test tab
- White write on panel

Applications

Mechanical engineering, plant control



Technical data of approved types on request

Contact data

| | | |
|---|---------------------------------------|---------------------|
| Configuration | 2 C/O contact or 3 C/O contact | |
| Type of contact | single contacts | bifurcated contacts |
| Rated current | 10 A | 4 A |
| Rated voltage / max.breaking voltage AC | 250 Vac / 440 Vac | |
| Maximum breaking capacity AC | 2500 VA | 500 VA |
| Make current (max. 4 s at duty cycle 10%) | 20 A | 8 A |
| Contact material | AgNi 90/10 | |
| Minimum contact load | 24 V, 10 mA / 20 mV, 1 mA gold plated | |

Contact ratings

| Type | Load | Operations | Standard |
|-------|----------------------------|-------------------|----------|
| MT321 | 10 A, 250 Vac, C/O contact | 1x10 ⁵ | VDE 0435 |

Coil data

| | | |
|--------------------|---------|-------------|
| Nominal voltage | DC coil | 6...220 Vdc |
| | AC coil | 6...230 Vac |
| Nominal coil power | DC coil | typ. 1.2 W |
| | AC coil | typ. 2.3 VA |
| Operate category | 1 / a | |

Coil versions, DC-coil

| Coil code standard | PD* | Nominal voltage Vdc | Pull-in voltage Vdc | Release voltage Vdc | Coil resistance Ω | Coil current mA |
|--------------------|------------|---------------------|---------------------|---------------------|-------------------|-----------------|
| 006 | 0A6 | 6 | 4.5 | 0.6 | 32±10% | 187.5 |
| 012 | 0B2 | 12 | 9.0 | 1.2 | 110±10% | 109.1 |
| 024 | 0C4 | 24 | 18.0 | 2.4 | 475±10% | 50.5 |
| 048 | 0E8 | 48 | 36.0 | 4.8 | 2000±10% | 24.0 |
| 060 | 0G0 | 60 | 45.0 | 6.0 | 2850±10% | 21.1 |
| 110 | 1B0 | 110 | 82.5 | 11.5 | 10000±12% | 11.0 |
| 220 | 2C0 | 220 | 165.0 | 22.0 | 40000±15% | 5.5 |

All figures are given for coil without preenergization, at ambient temperature +20°C

* Protection diode PD; standard polarity: 2-pole relays: +2 / -7, 3-pole relays: +2 / -10

Max. DC load breaking capacity

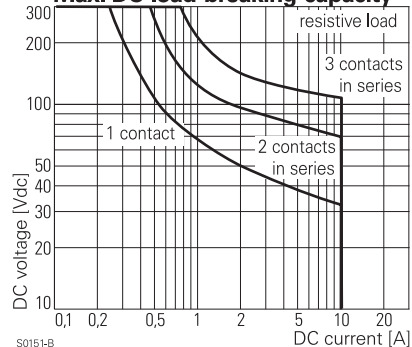

S0151-B

Electrical endurance

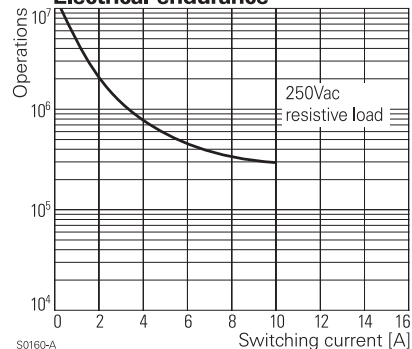

S0160-A

Coil operating range DC

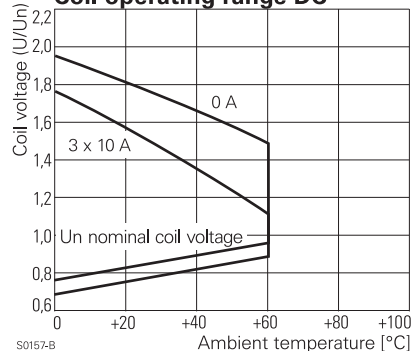

S0157-B

Multimode Relay MT

2 / 3 pole 10 A, DC- or AC-coil

Coil versions, AC-coil

| Coil code | Nominal voltage Vac | Pull-in voltage Vac | Release voltage Vac | Maximum voltage Vac | Coil resistance Ω | Coil current mA |
|------------|---------------------|---------------------|---------------------|---------------------|-----------------------------------|-----------------|
| 006 | 6 | 4.8 | 2.4 | 7.8 | $5.3 \pm 10\%$ | 381.7 |
| 012 | 12 | 9.6 | 4.8 | 15.6 | $24 \pm 10\%$ | 182.5 |
| 024 | 24 | 19.2 | 9.6 | 31.2 | $86 \pm 10\%$ | 94.2 |
| 048 | 48 | 38.4 | 19.2 | 62.4 | $345 \pm 10\%$ | 47.5 |
| 060 | 60 | 48.0 | 24.0 | 78.0 | $544 \pm 10\%$ | 37.8 |
| 115 | 115 | 92.0 | 46.0 | 149.5 | $2000 \pm 10\%$ | 20.6 |
| 230 | 230 | 184.0 | 92.0 | 299.0 | $8300 \pm 12\%$ | 10.1 |

All figures are given for coil without preenergization, at ambient temperature +20°C

Coil operating range AC

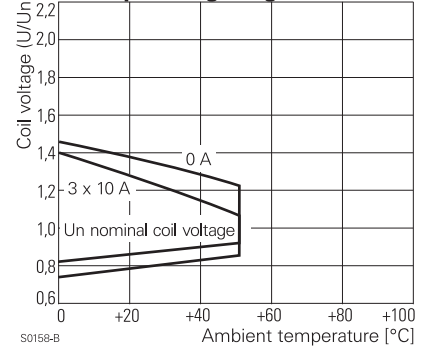

Insulation

| | | |
|-----------------------------------|----------------------|-----------------------|
| Dielectric strength | coil-contacts | 2500 V _{rms} |
| | open contact circuit | 1500 V _{rms} |
| | adjacent contacts | 2500 V _{rms} |
| Clearance / creepage | | 2.8 / 4 mm |
| Insulation to IEC 60664 | | |
| | Voltage rating | 250 V |
| | Pollution degree | 3 |
| | Overvoltage category | III |
| Insulation to VDE 0110b (2/79) | | C / 250 |
| Tracking resistance of relay base | | CTI 175 |

Other data

| | | |
|---|---------|--|
| Flammability class according to UL 94 | | V-0 |
| Ambient temperature | DC-coil | -45...+60 °C |
| | AC-coil | -45...+50 °C |
| Mechanical life | | >20x10 ⁶ operations |
| Max. switching rate at rated- / minimum load | | 20 min ⁻¹ / 100 min ⁻¹ |
| Operate- / release time | | 12 / 5 ms |
| Bounce time | | 4 ms |
| Vibration resistance N/O / N/C contact | | >5 / 2 g |
| Shock resistance (function) N/O contact / N/C contact | | >50 / 10 g |
| Category of protection (IEC 61810) | | RT I - dust protected |
| Relay weight | | 80 g |
| Packaging unit | | 25 pcs. |
| Accessories | | see accessories MT |

Terminal assignment

View on solder pins

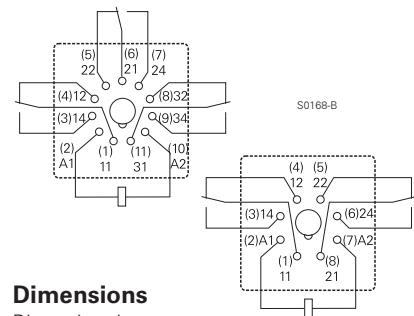

Dimensions

Dimensions in mm

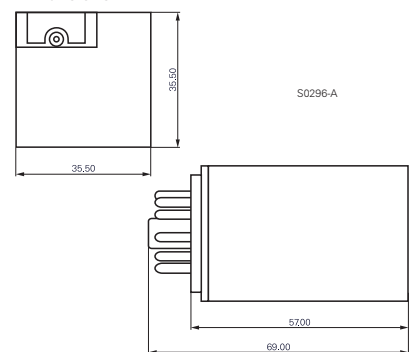

Product key

| Type | MT | | | | |
|------------------------|---|-------------------------------------|----------|--|--|
| Contact configuration | 2 | 2 C/O contacts, 8-pole | 3 | 3 C/O contacts, 11-pole | |
| Contact material | 2 | AgNi 90/10 | B | AgNi 90/10, bifurcated contacts, gold plated | |
| | 3 | AgNi 90/10, gold plated | | | |
| Version | 1 | DC with test button | 6 | AC with test button | |
| | 3 | DC with test button and bipolar LED | 8 | AC with test button and LED | |
| Coil | Coil code: please refer to coil versions table, preferred types in bold print | | | | |
| Other types on request | | | | | |

Multimode Relay MT

2 / 3 pole 10 A, DC- or AC-coil

| Product key | Contact configuration | Contact material | Version | Coil | Part number | | | | | |
|-------------|---------------------------|------------------|------------------------|-------------|------------------------|-------------|---------------------------|-------------|------------------------|-------------|
| MT221012 | 2 C/O contacts 8 pole | AgNi 90/10 | DC with test button | 12 Vdc | 4-1393090-9 | | | | | |
| MT221024 | | | | 24 Vdc | 5-1393090-0 | | | | | |
| MT221048 | | | | 48 Vdc | 5-1393090-1 | | | | | |
| MT221060 | | | | 60 Vdc | 5-1393090-2 | | | | | |
| MT221110 | | | | 110 Vdc | 5-1393090-3 | | | | | |
| MT221220 | | | 220 Vdc | 5-1393090-4 | | | | | | |
| MT223024 | | | DC+LED+test button | | AC test button | 24 Vdc | 5-1393090-7 | | | |
| MT226012 | | | | | | 12 Vac | 6-1393090-3 | | | |
| MT226024 | | | | | 24 Vac | 6-1393090-4 | | | | |
| MT226048 | | | | | 48 Vac | 6-1393090-5 | | | | |
| MT226115 | | | | | 115 Vac | 6-1393090-7 | | | | |
| MT226230 | | | | | 230 Vac | 6-1393090-8 | | | | |
| MT228024 | | | | | AC+LED test button | | 24 Vac | 6-1393090-9 | | |
| MT228115 | | | | | | | 115 Vac | 7-1393090-0 | | |
| MT228230 | | | | | | | 230 Vac | 7-1393090-1 | | |
| MT321012 | | | | | | | 3 C/O contacts 11 pole | AgNi 90/10 | DC with test button | 12 Vdc |
| MT321024 | | | 24 Vdc | 7-1393091-0 | | | | | | |
| MT321048 | 48 Vdc | 7-1393091-1 | | | | | | | | |
| MT321060 | 60 Vdc | 7-1393091-2 | | | | | | | | |
| MT321110 | 110 Vdc | 7-1393091-4 | | | | | | | | |
| MT321220 | 220 Vdc | 7-1393091-7 | | | | | | | | |
| MT323024 | DC+LED+test button | | DC+LED+PD+TB | 24 Vdc | 8-1393091-4 | | | | | |
| MT3230C4 | | | | 24 Vdc | 7-1393091-9 | | | | | |
| MT326012 | | | AC test button | | 12 Vac | 9-1393091-6 | | | | |
| MT326024 | | | | | 24 Vac | 9-1393091-7 | | | | |
| MT326048 | | | | | 48 Vac | 9-1393091-8 | | | | |
| MT326115 | | | | | 115 Vac | 0-1393092-1 | | | | |
| MT326230 | | | 230 Vac | 0-1393092-2 | | | | | | |
| MT328024 | | | AC+LED test button | | 24 Vac | 0-1393092-4 | | | | |
| MT328115 | | | | | 115 Vac | 0-1393092-7 | | | | |
| MT328230 | | | | | 230 Vac | 0-1393092-8 | | | | |
| MT331024 | AgNi 90/10 gold plated | | | | DC with test button | 24 Vdc | | | 1-1393092-1 | |
| MT331110 | | | 110 Vdc | 1-1393092-3 | | | | | | |
| MT331220 | | | 220 Vdc | 1-1393092-5 | | | | | | |
| MT333024 | | | DC+LED+test button | | DC+LED+PD+TB | 24 Vdc | 1-1393092-8 | | | |
| MT3330C4 | | | | | | 24 Vdc | 1-1393092-6 | | | |
| MT333110 | | | | | DC+LED test button | | 110 Vdc | 2-1393092-0 | | |
| MT333220 | | | | | | | 220 Vdc | 2-1393092-2 | | |
| MT336115 | | | | | | | AC test button | | 115 Vac | 2-1393092-5 |
| MT336230 | | | | | | | | | 230 Vac | 2-1393092-6 |
| MT338024 | | | | | AC+LED test button | | | | 24 Vac | 2-1393092-7 |
| MT338115 | | | | | | | 115 Vac | 8-1415025-1 | | |
| MT338230 | | | | | | | 230 Vac | 2-1393092-8 | | |

Power Relay RM 2/3/7

2 / 3 pole 10 / 16 A, DC- or AC-coil



Features

- 2 C/O or 3 C/O contacts
- Switching capacity up to 6000 VA
- DC- or AC-coil
- Mechanical indicator
- Push-to-test-button
- Plug-in version, PCB terminals, chassis- or DIN-rail mount

Applications

Elevator control, power supplies



Technical data of approved types on request

F0163-A

| Contact data | RM 2 | RM 3 | RM 7 |
|--|-------------------|---------|---------|
| Configuration | 2 C/O | 3 C/O | 3 C/O |
| Type of contact | single contact | | |
| Rated current | 16 A | 10 A | 16 A |
| Rated voltage / max. breaking voltage AC | 380 Vac / 440 Vac | | |
| Maximum breaking capacity AC | 6000 VA | 3800 VA | 6000 VA |
| Make current | 40 A | 40 A | 40 A |
| Contact material | AgCdO | | |

Contact ratings

| Type | Load | Standard |
|------|-------------------------------|----------|
| RM2 | 1hp, 240 Vac, per contact | UL 508 |
| RM7 | 1.5hp, 240 Vac, 3-phase | UL 508 |
| RM7 | 15 A, 250 Vac, per contact | UL 508 |
| RM3 | 1 / 2hp, 240 Vac, per contact | UL 508 |
| RM3 | 10 A, 240 Vac, per contact | UL 508 |

| Coil data | | RM 2 | RM 3 | RM 7 |
|--------------------|---------|--------|-------------|--------|
| Nominal voltage | DC coil | | 6...220 Vdc | |
| | AC coil | | 6...400 Vac | |
| Nominal coil power | DC coil | 1.2 W | 1.2 W | 1.6 W |
| | AC coil | 2.3 VA | 2.3 VA | 2.8 VA |

Coil versions, DC-coil, RM2, RM3

| Coil code | Nominal voltage | Pull-in voltage | Release voltage | Coil resistance | Coil current |
|------------------------|-----------------|-----------------|-----------------|-----------------|--------------|
| STD bipolar | Vdc | Vdc | Vdc | Ω | mA |
| 006 L06 OA6 LA6 | 6 | 4.5 | 0.6 | 32±10% | 187.5 |
| 012 L12 OB2 LB2 | 12 | 9.0 | 1.2 | 110±10% | 109.1 |
| 024 L24 OC4 LC4 | 24 | 18.0 | 2.4 | 475±10% | 50.5 |
| 048 L48 OE8 LE8 | 48 | 36.0 | 4.8 | 2000±10% | 24.0 |
| 060 L60 OG0 LG0 | 60 | 45.0 | 6.0 | 2850±10% | 21.1 |
| 110 M10 1B0 MB0 | 110 | 82.5 | 11.0 | 10000±12% | 11.0 |
| 221 N21 2C1 NC1 | 220 | 165.0 | 22.0 | 40000±15% | 5.5 |

Coil versions, DC-coil, RM7

| | | | | | |
|------------------------|-----------|-------------|------------|----------------|-------------|
| 006 L06 OA6 LA6 | 6 | 4.5 | 0.6 | 24±10% | 250.0 |
| 012 L12 OB2 LB2 | 12 | 9.0 | 1.2 | 86±10% | 139.5 |
| 024 L24 OC4 LC4 | 24 | 18.0 | 2.4 | 345±10% | 69.6 |
| 048 L48 OE8 LE8 | 48 | 36.0 | 4.8 | 1340±10% | 35.8 |
| 060 L60 OG0 LG0 | 60 | 45.0 | 6.0 | 2200±10% | 27.3 |
| 110 M10 1B0 MB0 | 110 | 82.5 | 11.0 | 7300±10% | 15.1 |
| 221 N21 2C1 NC1 | 220 | 165.0 | 22.0 | 30000±15% | 7.3 |

All figures are given for coil without preenergization, at ambient temperature +20°C

* Protection diode PD; standard polarity: +A1 / -A2

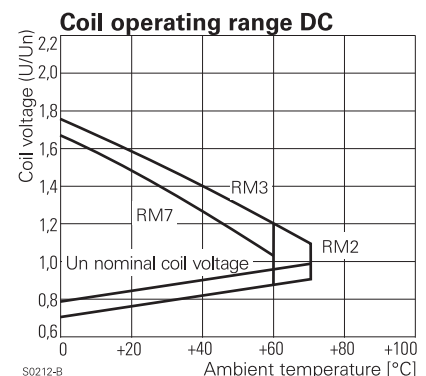
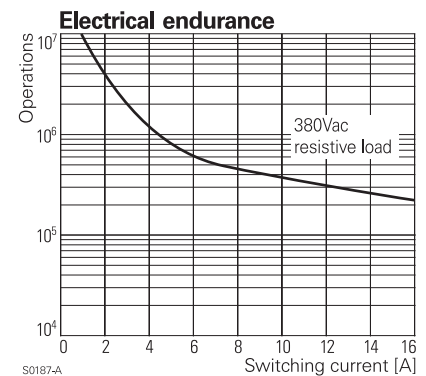
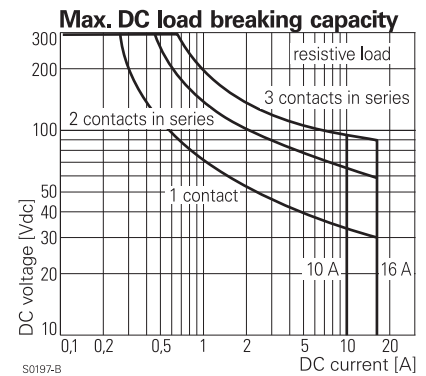

Power Relay RM 2/3/7

2 / 3 pole 10 / 16 A, DC- or AC-coil

Coil versions, AC-coil, RM2, RM3

| Coil code | LED | Nominal voltage Vac | Pull-in voltage Vac | Release voltage Vac | Coil resistance Ω | Coil current mA |
|------------|------------|---------------------|---------------------|---------------------|-----------------------------------|-----------------|
| 506 | R06 | 6 | 4.8 | 2.4 | $5.3 \pm 10\%$ | 381.7 |
| 512 | R12 | 12 | 9.6 | 4.8 | $24 \pm 10\%$ | 182.5 |
| 524 | R24 | 24 | 19.2 | 9.6 | $86 \pm 10\%$ | 94.2 |
| 548 | R48 | 48 | 38.4 | 19.2 | $345 \pm 10\%$ | 47.5 |
| 560 | R60 | 60 | 48.0 | 24.0 | $544 \pm 10\%$ | 37.8 |
| 615 | S15 | 115 | 92.0 | 46.0 | $2000 \pm 10\%$ | 20.6 |
| 730 | T30 | 230 | 184.0 | 92.0 | $8300 \pm 12\%$ | 10.1 |
| 900 | V00 | 400 | 320.0 | 160.0 | $27500 \pm 15\%$ | 5.8 |

Coil versions, AC-coil, RM7

| | | | | | | |
|------------|------------|------------|--------------|-------------|-----------------------------------|--------------|
| 506 | R06 | 6 | 4.8 | 2.4 | $4.7 \pm 10\%$ | 476.7 |
| 512 | R12 | 12 | 9.6 | 4.8 | $19.5 \pm 10\%$ | 225.8 |
| 524 | R24 | 24 | 19.2 | 9.6 | $80 \pm 10\%$ | 109.2 |
| 548 | R48 | 48 | 38.4 | 19.2 | $320 \pm 10\%$ | 54.2 |
| 560 | R60 | 60 | 48.0 | 24.0 | $500 \pm 10\%$ | 43.7 |
| 615 | S15 | 115 | 92.0 | 46.0 | $1850 \pm 10\%$ | 23.0 |
| 730 | T30 | 230 | 184.0 | 92.0 | $7500 \pm 10\%$ | 11.7 |
| 900 | V00 | 400 | 320.0 | 160.0 | $23500 \pm 15\%$ | 6.5 |

All figures are given for coil without preenergization, at ambient temperature +20°C

Coil operating range AC

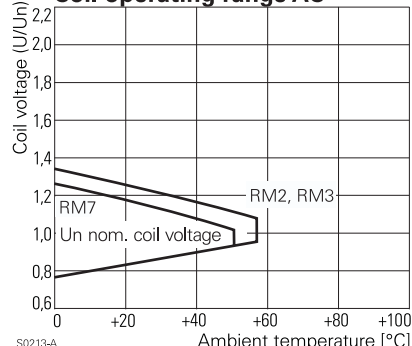

S0213-A

PCB layout / terminal assignment

View on solder pins
Dimensions in mm

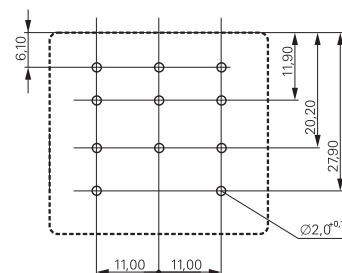

S0269-AA

Insulation

| | | |
|---|----------------------|---|
| Dielectric strength | coil-contacts | 2500 V_{rms} |
| | open contact circuit | 1500 V_{rms} |
| | adjacent contacts | 2500 V_{rms} |
| Clearance / creepage | | $\geq 3.5 / 6$ mm |
| Insulation to VDE 0110b (2/79) | | |
| Insulation category / reference voltage | | C / 400 with fully isolated Faston connectors |

Other data

| | RM 2 | RM 3 | RM 7 |
|--|--|--------------|--------------|
| Ambient temperature DC-coil | -45...+70 °C | -45...+60 °C | -45...+60 °C |
| AC-coil | -45...+55 °C | -45...+55 °C | -45...+50 °C |
| Mechanical life | $>20 \times 10^6$ operations | | |
| Max. switching rate at rated- / minimum load | 16 min^{-1} / 100 min^{-1} | | |
| Operate- / release time | approx. 15 / 10 ms | | |
| Bounce time | approx. 3 ms | | |
| Vibration resistance N/O / N/C contact | $>5 / 2$ g | $>5 / 2$ g | $>12 / 4$ g |
| Category of protection (IEC 61810) | RT I - dust protected | | |
| Relay weight | 81 g | | |
| Packaging unit | 10 / 25 pcs. | | |
| Accessories | see accessories RM | | |

3 C/O contacts

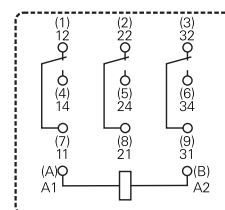

S0269-AB

2 C/O contacts

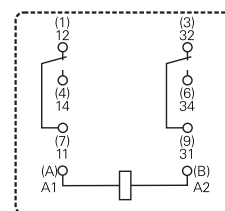

S0269-AD

Power Relay RM 2/3/7

2 / 3 pole 10 / 16 A, DC- or AC-coil

Dimensions

Dimensions in mm

Plain cover, plug-in version

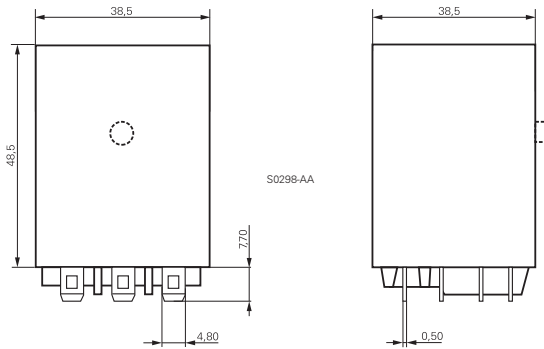

PCB version

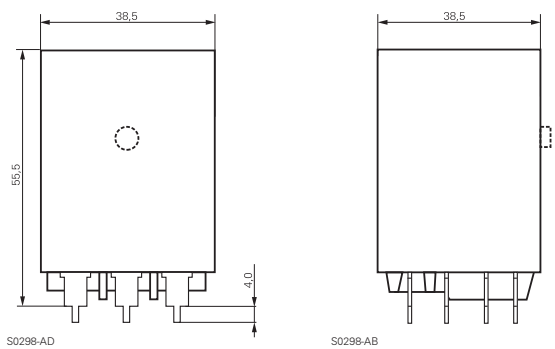

Cover with mounting brackets, FASTON 250 (187 available)

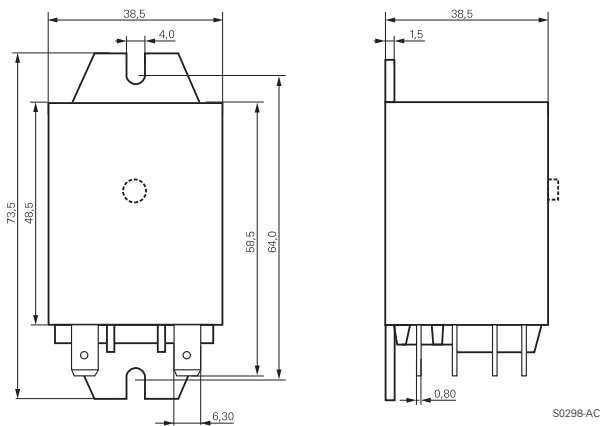

Cover with DIN-snap-on attachment (FASTON 250 only)
horizontal vertical

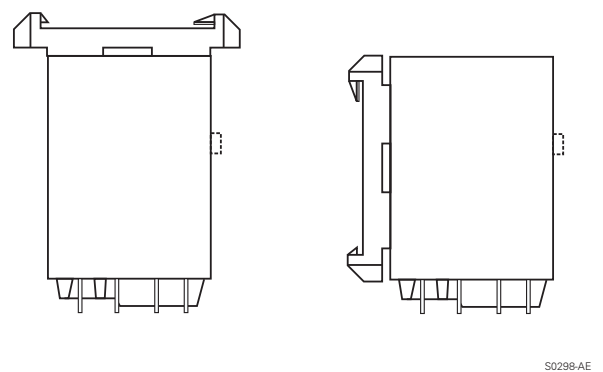

Product key

Type

Contacts

2 2 C/O contacts, 16 A

3 3 C/O contacts, 10 A

7 3 C/O contacts, 16 A

Version

0 without test button

3 with test button

Enclosure

2 plain cover, AMP-Faston 187

3 cover with mounting brackets, AMP-Faston 187

5 cover with mounting brackets, AMP-Faston 250

7 PCB version

8 cover with DIN-snap-on attachment, horizontal, AMP-Faston 250

9 cover with DIN-snap-on attachment, vertical, AMP-Faston 250

Coil

Coil code: please refer to coil versions table, preferred types in bold print

AMP-Faston 187 = 4.8 x 0.5 mm

AMP-Faston 250 = 6.3 x 0.8 mm

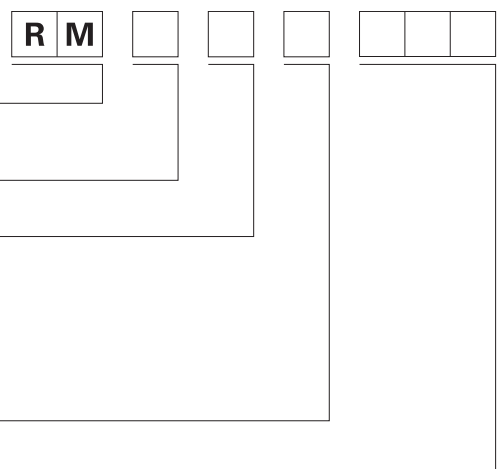

Power Relay RM 2/3/7

2 / 3 pole 10 / 16 A, DC- or AC-coil

| Product key | Contacts | Version | Enclosure | Coil | Coil | Part number |
|-------------|------------------------|------------------------|------------------------------|---------|---------|-------------|
| RM202024 | 2 C/O contacts 16 A | without test button | plain cover AMP 187 | DC-coil | 24 Vdc | 8-1393149-2 |
| RM202524 | | | | AC-coil | 24 Vac | 1-1393146-9 |
| RM202615 | | | | | 115 Vac | 2-1393146-0 |
| RM202730 | | | | | 230 Vac | 1-1393148-4 |
| RM203024 | | | mounting brackets AMP 187 | DC-coil | 24 Vdc | 1-1393148-6 |
| RM203524 | | | | AC-coil | 24 Vac | 2-1393146-5 |
| RM203615 | | | | | 115 Vac | 2-1393146-6 |
| RM203730 | | | | | 230 Vac | 2-1393146-8 |
| RM205024 | | | mounting brackets AMP 250 | DC-coil | 24 Vdc | 2-1393146-9 |
| RM205524 | | | | AC-coil | 24 Vac | 3-1393146-0 |
| RM205615 | | | | | 115 Vac | 3-1393146-1 |
| RM205730 | | | | | 230 Vac | 3-1393146-2 |
| RM207024 | | | PCB version | DC-coil | 24 Vdc | 3-1393146-3 |
| RM207615 | | | | AC-coil | 115 Vac | 8-1393149-5 |
| RM207730 | | | | | 230 Vac | 3-1393146-4 |
| RM208024 | | | DIN-snap-on horizontal | DC-coil | 24 Vdc | 3-1393146-5 |
| RM208730 | | | | AC-coil | 230 Vac | 8-1393149-6 |
| RM209730 | | | DIN vertical | | 230 Vac | 3-1393146-6 |
| RM232024 | with test button | | plain cover AMP 187 | DC-coil | 24 Vdc | 3-1393146-8 |
| RM232524 | | | | AC-coil | 24 Vac | 3-1393146-9 |
| RM232615 | | | | | 115 Vac | 4-1393146-0 |
| RM232730 | | | | | 230 Vac | 3-1393107-4 |
| RM233024 | | | mounting brackets AMP 187 | DC-coil | 24 Vdc | 3-1393107-5 |
| RM233615 | | | | AC-coil | 115 Vac | 4-1393146-2 |
| RM235024 | | | mounting brackets AMP 250 | DC-coil | 24 Vdc | 8-1393149-8 |
| RM235730 | | | | AC-coil | 230 Vac | 4-1393146-5 |
| RM239730 | | | DIN vertical | | 230 Vac | 4-1393148-7 |
| RM302024 | 3 C/O contacts 10 A | without test button | plain cover AMP 187 | DC-coil | 24 Vdc | 8-1393149-9 |
| RM302524 | | | | AC-coil | 24 Vac | 5-1393146-3 |
| RM302615 | | | | | 115 Vac | 5-1393146-4 |
| RM302730 | | | | | 230 Vac | 5-1419150-3 |
| RM303024 | | | | DC-coil | 24 Vdc | 6-1393148-4 |
| RM303615 | | | | AC-coil | 115 Vac | 5-1393146-5 |
| RM303730 | | | | | 230 Vac | 5-1393146-7 |
| RM307024 | | | PCB version | DC-coil | 24 Vdc | 7-1393148-2 |
| RM307730 | | | | AC-coil | 230 Vac | 5-1393146-9 |
| RM332024 | with test button | | mounting brackets AMP 187 | DC-coil | 24 Vdc | 9-1393149-2 |
| RM332524 | | | | AC-coil | 24 Vac | 9-1393149-3 |
| RM332730 | | | | | 230 Vac | 9-1393149-4 |
| RM333024 | | | | DC-coil | 24 Vdc | 9-1393149-6 |
| RM335730 | | | mount. Br AMP250 | AC-coil | 230 Vac | 6-1393107-1 |
| RM338730 | | | DIN horizontal | | 230 Vac | 7-1393148-7 |
| RM339730 | | | DIN vertical | | 230 Vac | 6-1393107-2 |
| RM702024 | 3 C/O contacts 16 A | without test button | plain cover AMP 187 | DC-coil | 24 Vdc | 8-1393146-5 |
| RM702524 | | | | AC-coil | 24 Vac | 0-1393844-9 |
| RM702615 | | | | | 115 Vac | 1-1393844-0 |
| RM702730 | | | | | 230 Vac | 1-1393844-1 |
| RM703024 | | | | DC-coil | 24 Vdc | 1-1393844-2 |
| RM703524 | | | | AC-coil | 24 Vac | 9-1393146-1 |
| RM703615 | | | | | 115 Vac | 9-1393146-2 |
| RM703730 | | | | | 230 Vac | 9-1393146-4 |
| RM705024 | | | mounting brackets AMP 250 | DC-coil | 24 Vdc | 9-1393146-6 |
| RM705524 | | | | AC-coil | 24 Vac | 9-1393146-7 |
| RM705615 | | | | | 115 Vac | 1-1393844-4 |
| RM705730 | | | | | 230 Vac | 1-1393844-5 |
| RM707024 | | | PCB version | DC-coil | 24 Vdc | 9-1393146-8 |
| RM707524 | | | | AC-coil | 24 Vac | 0-1393147-1 |
| RM707730 | | | | | 230 Vac | 0-1393147-2 |
| RM708024 | | | DIN-snap-on AMP 250 | DC-coil | 24 Vdc | 0-1393147-4 |
| RM708730 | | | | AC-coil | 230 Vac | 1-1419136-0 |
| RM709024 | | | | DC-coil | 24 Vdc | 2-1393149-2 |
| RM709730 | | | | AC-coil | 230 Vac | 0-1393147-5 |
| RM732024 | with test button | | mounting brackets AMP 187 | DC-coil | 24 Vdc | 1-1393844-7 |
| RM732524 | | | | AC-coil | 24 Vac | 1-1393147-0 |
| RM732615 | | | | | 115 Vac | 1-1393147-1 |
| RM732730 | | | | | 230 Vac | 1-1393844-8 |
| RM733730 | | | | | 230 Vac | 1-1393147-5 |
| RM735024 | | | mounting brackets AMP 250 | DC-coil | 24 Vdc | 3-1393149-6 |
| RM735524 | | | | AC-coil | 24 Vac | 3-1393149-7 |
| RM735730 | | | | | 230 Vac | 4-1393149-1 |
| RM737730 | | | PCB version | | 230 Vac | 2-1393147-0 |
| RM738024 | | | DIN-snap-on | DC-coil | 24 Vdc | 2-1393844-0 |
| RM738730 | | | horizontal | AC-coil | 230 Vac | 2-1393147-2 |
| RM739024 | | | DIN-snap-on | DC-coil | 24 Vdc | 4-1393149-5 |
| RM739730 | | | vertical | AC-coil | 230 Vac | 2-1393844-2 |

Power Relay RM 5/6

2 / 3 pole 10 / 16 A, DC- or AC-coil



Features

- 2 N/O or 3 N/O contacts
- 3 mm contact gap
- Push-to-test-button
- Plug-in version, PCB terminals, chassis- or DIN-rail mount

Applications

Power supplies, pump control

F0164-A



Technical data of approved types on request

| Contact data | RM 5 | RM 6 |
|---|-------------------|---------------|
| Configuration | 2 N/O contact | 3 N/O contact |
| Type of contact | single contact | |
| Rated current | 16 A | 10 A |
| Rated voltage / max.breaking voltage AC | 380 Vac / 440 Vac | |
| Maximum breaking capacity AC | 6000 VA | 3800 VA |
| Make current (max. 4 s at duty cycle 10%) | 25 A | 25 A |
| Contact material | AgCdO | |

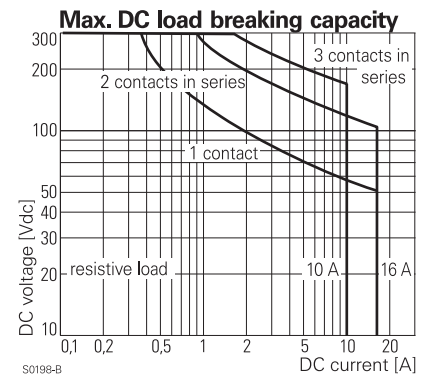

| Coil data | | |
|--------------------|---------|-------------|
| Nominal voltage | DC coil | 6...220 Vdc |
| | AC coil | 6...400 Vac |
| Nominal coil power | DC coil | 1.6 W |
| | AC coil | 2.8 VA |

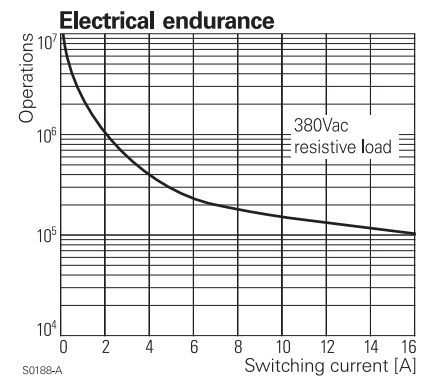

Coil versions, DC-coil, RM5, RM6

| Coil code | Nominal voltage | Pull-in voltage | Release voltage | Coil resistance | Coil current | | | |
|------------|-----------------|-----------------|-----------------|-----------------|--------------|------------|------------------|-------------|
| STD | LED | PD* | LED | Vdc | Vdc | Vdc | Ω | mA |
| bipolar | PD* | | | | | | | |
| 006 | L06 | 0A6 | LA6 | 6 | 4.5 | 0.6 | 24 ± 10% | 250.0 |
| 012 | L12 | 0B2 | LB2 | 12 | 9.0 | 1.2 | 86 ± 10% | 139.5 |
| 024 | L24 | 0C4 | LC4 | 24 | 18.0 | 2.4 | 345 ± 10% | 69.6 |
| 048 | L48 | 0E8 | LE8 | 48 | 36.0 | 4.8 | 1340 ± 10% | 35.8 |
| 060 | L60 | 0G0 | LG0 | 60 | 45.0 | 6.0 | 2200 ± 10% | 27.3 |
| 110 | M10 | 1B0 | MB0 | 110 | 82.5 | 11.0 | 7300 ± 10% | 15.1 |
| 221 | N21 | 2C1 | NC1 | 220 | 165.0 | 22.0 | 30000 ± 15% | 7.3 |

All figures are given for coil without preenergization, at ambient temperature +20°C

* Protection diode PD; standard polarity: +A1 / -A2

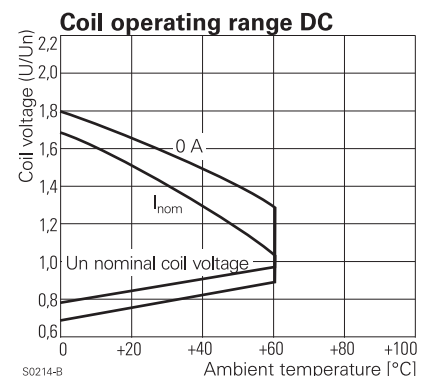

Power Relay RM 5/6

2 / 3 pole 10 / 16 A, DC- or AC-coil

Coil versions, AC-coil, RM5, RM6

| Coil code | LED | Nominal voltage Vac | Pull-in voltage Vac | Release voltage Vac | Coil resistance Ω | Coil current mA |
|------------|------------|------------------------|------------------------|------------------------|-----------------------------------|--------------------|
| 506 | R06 | 6 | 4.8 | 2.4 | $4.7 \pm 10\%$ | 476.7 |
| 512 | R12 | 12 | 9.6 | 4.8 | $19.5 \pm 10\%$ | 225.8 |
| 524 | R24 | 24 | 19.2 | 9.6 | $80 \pm 10\%$ | 109.2 |
| 548 | R48 | 48 | 38.4 | 19.2 | $320 \pm 10\%$ | 54.2 |
| 560 | R60 | 60 | 48.0 | 24.0 | $500 \pm 10\%$ | 43.7 |
| 615 | S15 | 115 | 92.0 | 46.0 | $1850 \pm 10\%$ | 23.0 |
| 730 | T30 | 230 | 184.0 | 92.0 | $7500 \pm 10\%$ | 11.7 |
| 900 | V00 | 400 | 320.0 | 160.0 | $23500 \pm 15\%$ | 6.5 |

All figures are given for coil without preenergization, at ambient temperature +20°C

Coil operating range AC

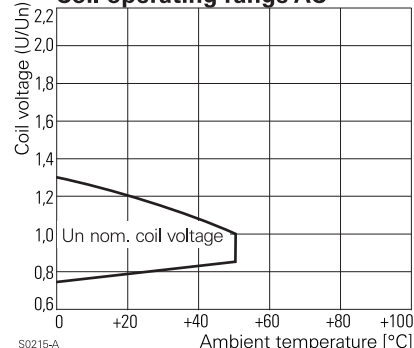

S0215-A

Insulation

| | | |
|---|----------------------|---|
| Dielectric strength | coil-contacts | 2500 V_{rms} |
| | open contact circuit | 2500 V_{rms} |
| | adjacent contacts | 2500 V_{rms} |
| Clearance / creepage | | $\geq 3.5 / 6$ mm |
| Insulation to VDE 0110b (2/79) | | |
| Insulation category / reference voltage | | C / 400 with fully isolated Faston connectors |

Other data

| | | |
|--|--|--------------|
| Ambient temperature | DC-coil | -45...+60 °C |
| | AC-coil | -45...+50 °C |
| Mechanical life | >20x10 ⁶ operations | |
| Max. switching rate at rated- / minimum load | 16 min ⁻¹ / 100 min ⁻¹ | |
| Operate- / release time | approx. 15 / 10 ms | |
| Bounce time | approx. 4 ms | |
| Vibration resistance | >12 g, 30...150 Hz | |
| Category of protection (IEC 61810) | RT I - dust protected | |
| Relay weight | 81 g | |
| Packaging unit | 10 / 25 pcs. | |
| Accessories | see accessories RM | |

PCB layout / terminal assignment

View on solder pins
Dimensions in mm

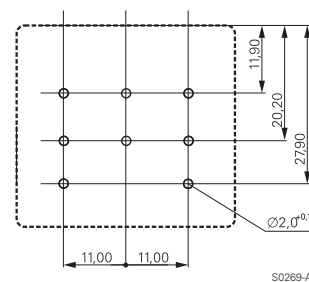

S0269-AF

3 N/O contacts

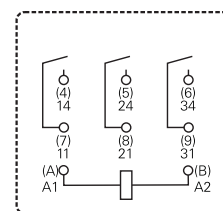

S0269-AC

2 N/O contacts

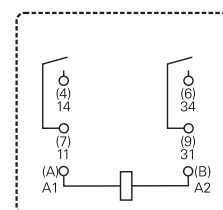

S0269-AE

Power Relay RM 5/6

2 / 3 pole 10 / 16 A, DC- or AC-coil

Dimensions

Dimensions in mm

Plain cover, plug-in version

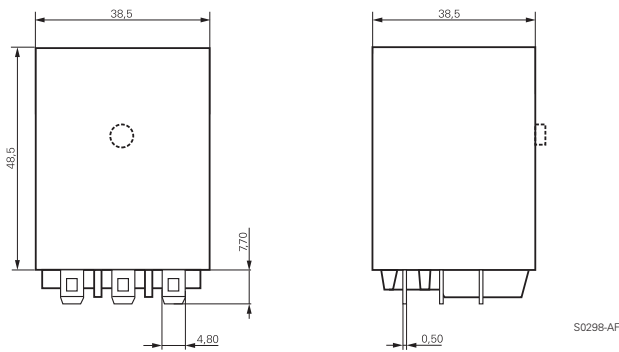

PCB version

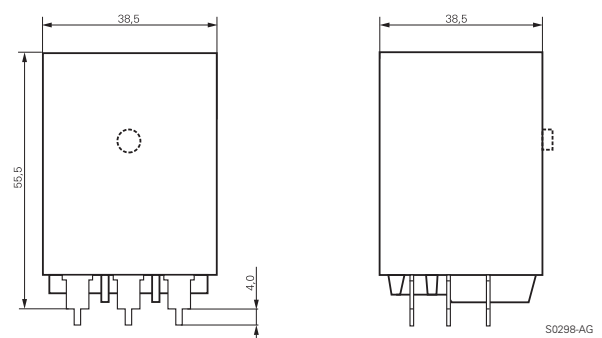

Cover with mounting brackets, FASTON 250 (187 available)

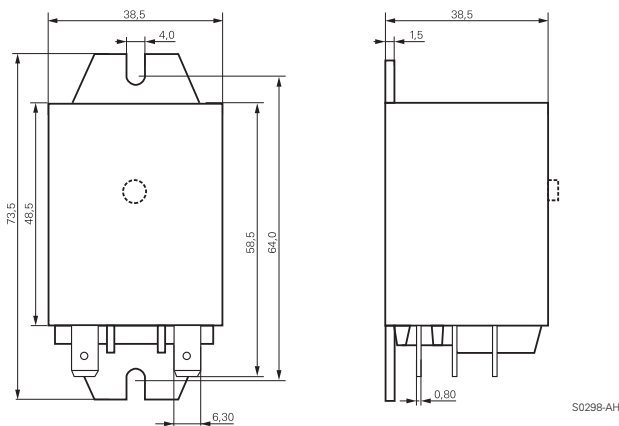

Cover with DIN-snap-on attachment (FASTON 250 only)

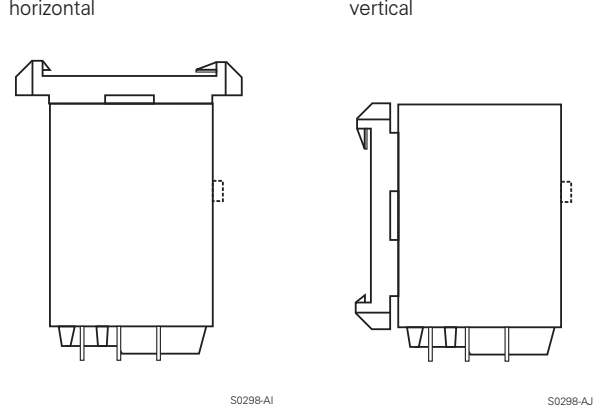

Product key

| | | | | | | | |
|----------|---|----------|--|--|---|--|----------------------|
| Type | R | M | | | | | |
| Contacts | 5 2 N/O contacts, 16 A | | 6 3 N/O contacts, 10 A | | | | |
| Version | 0 without test button, without mechanical indicator | | 3 with test button, without mechanical indicator | | | | |
| Mounting | 2 plain cover, AMP-Faston 187 | | 3 cover with mounting brackets, AMP-Faston 187 | | 5 cover with mounting brackets, AMP-Faston 250 | | 7 PCB version |
| | 8 cover with DIN-snap-on attachment, horizontal, AMP-Faston 250 | | 9 cover with DIN-snap-on attachment, vertical, AMP-Faston 250 | | | | |
| Coil | Coil code: please refer to coil versions table, preferred types in bold print | | | | | | |
| | AMP-Faston 187 = 4.8 x 0.5 mm | | AMP-Faston 250 = 6.3 x 0.8 mm | | | | |

Power Relay RM 5/6

2 / 3 pole 10 / 16 A, DC- or AC-coil

| Product key | Contacts | Version | Enclosure | Coil | Coil | Part number | |
|-------------|------------------------|-----------------|-------------------|-------------------|---------|-------------|-------------|
| RM502024 | 2 N/O contacts 16 A | without | plain cover | DC-coil | 24 Vdc | 6-1393146-1 | |
| RM502524 | | test button | AMP 187 | AC-coil | 24 Vac | 6-1393146-2 | |
| RM502615 | | without | | | 115 Vac | 6-1393146-3 | |
| RM502730 | | mech.indicator | | | 230 Vac | 6-1393146-4 | |
| RM503024 | | | | mounting brackets | DC-coil | 24 Vdc | 8-1393148-0 |
| RM503615 | | | | AMP 187 | AC-coil | 115 Vac | 6-1393146-5 |
| RM505024 | | | | mounting brackets | DC-coil | 24 Vdc | 8-1393148-3 |
| RM505615 | | | | AMP 250 | AC-coil | 115 Vac | 6-1393146-6 |
| RM505730 | | | | | | 230 Vac | 9-1393149-9 |
| RM507024 | | | | PCB version | DC-coil | 24 Vdc | 0-1393844-1 |
| RM507524 | | | | AC-coil | 24 Vac | 5-1415008-1 | |
| RM507615 | | | | | 115 Vac | 6-1415015-1 | |
| RM507730 | | | | | 230 Vac | 0-1415008-1 | |
| RM535024 | | test button | mounting brackets | DC-coil | 24 Vdc | 7-1393146-2 | |
| RM535524 | | mech.indicator | AMP 250 | AC-coil | 24 Vac | 9-1393148-0 | |
| RM602024 | 3 N/O contacts 10 A | without | plain cover | DC-coil | 24 Vdc | 0-1393844-4 | |
| RM602615 | | test button | AMP 187 | AC-coil | 115 Vac | 9-1393148-7 | |
| RM605730 | | without | mount.br.AMP250 | | 230 Vac | 7-1393146-6 | |
| RM607024 | | mechanical ind. | PCB version | DC-coil | 24 Vdc | 0-1393844-6 | |
| RM607524 | | | | | AC-coil | 24 Vac | 7-1393146-8 |
| RM607615 | | | | | | 115 Vac | 8-1415015-1 |
| RM607730 | | | | | | 230 Vac | 7-1393146-9 |
| RM632024 | | | with | plain cover | DC-coil | 24 Vdc | 8-1393146-0 |
| RM632730 | | | test button | AMP 187 | AC-coil | 230 Vac | 0-1393149-7 |
| RM635024 | | | with | mount.br.AMP250 | DC-coil | 24 Vdc | 7-1393107-7 |
| RM637024 | | mech.indicator | PCB version | | 24 Vdc | 0-1393149-9 | |

Power Relay RM 8

2 pole 25 A, DC- or AC-coil



Features

- 2 C/O contacts
- DC- or AC-coil
- Mechanical indicator
- Push-to-test-button
- Chassis- or DIN-rail mount

Applications

Cleaning equipment, heating and cooling equipment

F0165-A



Technical data of approved types on request

Contact data

| | |
|---|-------------------|
| Configuration | 2 C/O contact |
| Type of contact | single contact |
| Rated current | 25 A |
| Rated voltage / max.breaking voltage AC | 250 Vac / 440 Vac |
| Maximum breaking capacity AC | 6000 VA |
| Make current (max. 4 s at duty cycle 10%) | 60 A |
| Contact material | AgCdO |

Contact ratings

| | | |
|------|-----------------------------|----------|
| Type | Load | Standard |
| RM8 | 2hp, 240 Vac, per contact | UL 508 |
| RM8 | 1.5hp, 120 Vac, per contact | UL 508 |
| RM8 | 25 A, 240 Vac, per contact | UL 508 |

Coil data

| | | |
|--------------------|---------|-------------|
| Nominal voltage | DC coil | 6...220 Vdc |
| | AC coil | 6...400 Vac |
| Nominal coil power | DC coil | 1.2 W |
| | AC coil | 2.8 VA |

Coil versions, DC-coil, RM8

| Coil code | Nominal voltage | Pull-in voltage | Release voltage | Coil resistance | Coil current | |
|------------|----------------------------------|-----------------|-----------------|-----------------|----------------|-------------|
| STD | LED PD* | LED PD* | | | | |
| | bipolar | | | | | |
| 006 | L06 OA6 LA6 | 6 | 4.5 | 0.6 | 32±10% | 187.5 |
| 012 | L12 OB2 LB2 | 12 | 9.0 | 1.2 | 110±10% | 109.1 |
| 024 | L24 OC4 LC4 | 24 | 18.0 | 2.4 | 475±10% | 50.5 |
| 048 | L48 OE8 LE8 | 48 | 36.0 | 4.8 | 2000±10% | 24.0 |
| 060 | L60 OG0 LG0 | 60 | 45.0 | 6.0 | 2850±10% | 21.1 |
| 110 | M10 1B0 MB0 | 110 | 82.5 | 11.0 | 10000±12% | 11.0 |
| 221 | N21 2C1 NC1 | 220 | 165.0 | 22.0 | 40000±15% | 5.5 |

All figures are given for coil without preenergization, at ambient temperature +20°C

* Protection diode PD; standard polarity: +A1 / -A2

Max. DC load breaking capacity

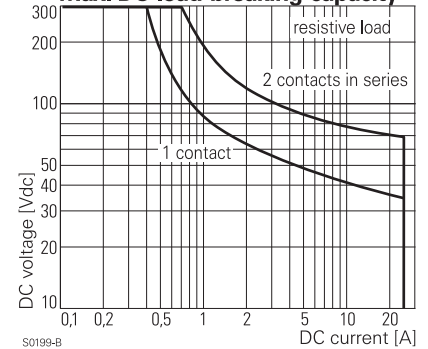

S0199-B

Electrical endurance

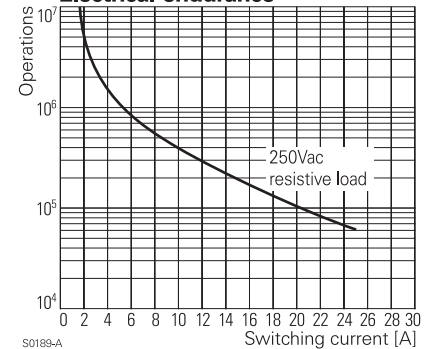

S0189-A

Coil operating range DC

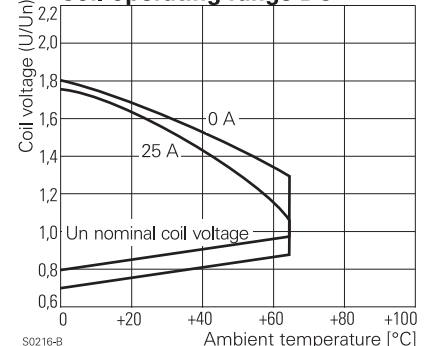

S0216-B

Power Relay RM 8

2 pole 25 A, DC- or AC-coil

Coil versions, AC-coil, RM8

| Coil code | LED | Nominal voltage Vac | Pull-in voltage Vac | Release voltage Vac | Coil resistance Ω | Coil current mA |
|------------|------------|------------------------|------------------------|------------------------|-----------------------------------|--------------------|
| 506 | R06 | 6 | 4.8 | 2.4 | $4.7 \pm 10\%$ | 476.7 |
| 512 | R12 | 12 | 9.6 | 4.8 | $19.5 \pm 10\%$ | 225.8 |
| 524 | R24 | 24 | 19.2 | 9.6 | $80 \pm 10\%$ | 109.2 |
| 548 | R48 | 48 | 38.4 | 19.2 | $320 \pm 10\%$ | 54.2 |
| 560 | R60 | 60 | 48.0 | 24.0 | $500 \pm 10\%$ | 43.7 |
| 615 | S15 | 115 | 92.0 | 46.0 | $1850 \pm 10\%$ | 23.0 |
| 730 | T30 | 230 | 184.0 | 92.0 | $7500 \pm 10\%$ | 11.7 |
| 900 | V00 | 400 | 320.0 | 160.0 | $23500 \pm 15\%$ | 6.5 |

All figures are given for coil without preenergization, at ambient temperature +20°C

Insulation

| | | |
|---|----------------------|---------------------------|
| Dielectric strength | coil-contacts | 2500 V_{rms} |
| | open contact circuit | 1500 V_{rms} |
| | adjacent contacts | 4000 V_{rms} |
| Clearance / creepage | | $\geq 2.8 / 4 \text{ mm}$ |
| Insulation to VDE 0110b (2/79) | | |
| Insulation category / reference voltage | | C / 250 |

Terminal assignment

View on solder pins
Dimensions in mm

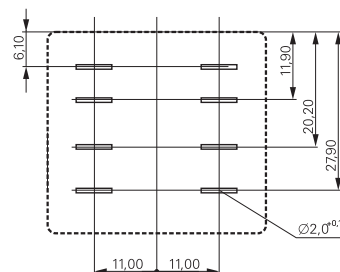

S0269-AG

Other data

| | | |
|--|--|--------------|
| Ambient temperature | DC-coil | -45...+65 °C |
| | AC-coil | -45...+40 °C |
| Mechanical life | > 10x10 ⁶ operations | |
| Max. switching rate at rated- / minimum load | 16 min ⁻¹ / 100 min ⁻¹ | |
| Operate- / release time | approx. 15 / 15 ms | |
| Bounce time | approx. 3 ms | |
| Vibration resistance N/O / N/C contact | > 10 / 5 g, 30...150 Hz | |
| Category of protection (IEC 61810) | RT I - dust protected | |
| Relay weight | 81 g | |
| Packaging unit | 10 / 25 pcs. | |

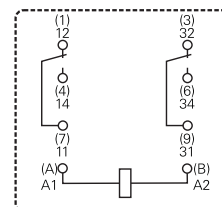

S0269-AD

Power Relay RM 8

2 pole 25 A, DC- or AC-coil

Dimensions

Dimensions in mm

Cover with mounting brackets, FASTON 250

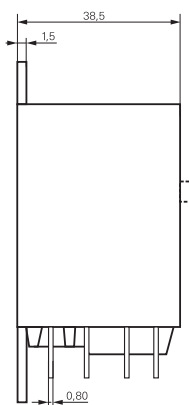
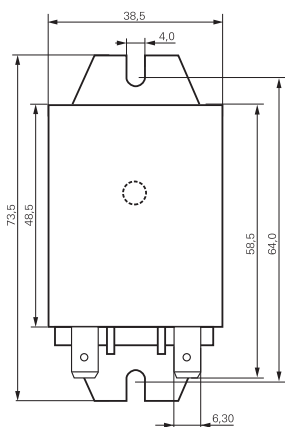

S0298-AC

Cover with DIN-snap-on attachment
horizontal

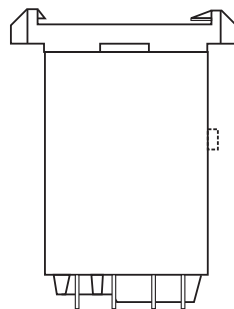

S0298-AD

vertical

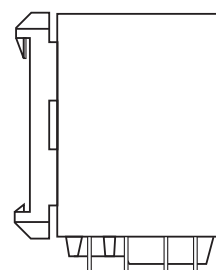

S0298-AE

Product key



Type

Contacts

8 2 C/O contacts, 25 A

Version

0 without test button **3** with test button

Mounting

5 cover with mounting brackets, AMP-Faston 250
8 cover with DIN-snap-on attachment, horizontal, AMP-Faston 250
9 cover with DIN-snap-on attachment, vertical, AMP-Faston 250

Coil

Coil code: please refer to coil versions table, preferred types in bold print

AMP-Faston 250 = 6.3 x 0.8 mm

| Product key | Contacts | Version | Enclosure | Coil | Coil | Part number |
|-------------|------------------------|------------------------|------------------------------|---------|---------|-------------|
| RM805024 | 2 C/O contacts 25 A | without test button | mounting brackets AMP 250 | DC-coil | 24 Vdc | 2-1393844-7 |
| RM805524 | | | | AC-coil | 24 Vac | 2-1393147-9 |
| RM805615 | | | | | 115 Vac | 3-1393147-1 |
| RM805730 | | | | | 230 Vac | 3-1393147-3 |
| RM808024 | | | DIN-snap-on horizontal | DC-coil | 24 Vdc | 2-1393844-9 |
| RM808524 | | | | AC-coil | 24 Vac | 3-1393147-7 |
| RM808730 | | | | | 230 Vac | 5-1393149-7 |
| RM809024 | | | DIN-snap-on vertical | DC-coil | 24 Vdc | 5-1393149-8 |
| RM809615 | | | | AC-coil | 115 Vac | 3-1393147-8 |
| RM809730 | | | | | 230 Vac | 3-1393147-9 |
| RM835024 | | with test button | mounting brackets AMP 250 | DC-coil | 24 Vdc | 4-1393147-1 |
| RM835524 | | | | AC-coil | 24 Vac | 4-1393147-3 |
| RM835615 | | | | | 115 Vac | 4-1393147-4 |
| RM835730 | | | | | 230 Vac | 4-1393147-6 |
| RM838024 | | | DIN-snap-on horizontal | DC-coil | 24 Vdc | 4-1393147-8 |
| RM838524 | | | | AC-coil | 24 Vac | 5-1393147-0 |
| RM838730 | | | | | 230 Vac | 5-1393147-1 |
| RM839024 | | | DIN-snap-on vertical | DC-coil | 24 Vdc | 5-1393147-4 |
| RM839524 | | | | AC-coil | 24 Vac | 5-1393147-5 |
| RM839730 | | | | | 230 Vac | 5-1393147-6 |

Power Relay RM C/D

1 pole 30 A, DC- or AC-coil



F0166-A

Features

- 1 N/O or 1 N/O + 1 N/C contact
- Switching capacity up to 7200 VA
- DC- or AC-coil
- Push-to-test-button
- Chassis mount

Applications

Battery chargers, heating control

| Contact data | RMC | RMD |
|---|----------------------------------|-------|
| Configuration | 1 N/O and 1N/C | 1 N/O |
| Type of contact | single contact, bridging contact | |
| Rated current | 30 A | |
| Rated voltage / max.breaking voltage AC | 250 Vac / 380 Vac / 440 Vac | |
| Maximum breaking capacity AC | 7500 VA | |
| Make current (max. 4 s at duty cycle 10%) | 60 A | |
| Contact material | AgCdO | |

| Coil data | | |
|--------------------|---------|-------------|
| Nominal voltage | DC coil | 6...220 Vdc |
| | AC coil | 6...400 Vac |
| Nominal coil power | DC coil | 1.2 W |
| | AC coil | 2.8 VA |

Coil versions, DC-coil, RMC, RMD

| Coil code | Nominal voltage | Pull-in voltage | Release voltage | Coil resistance | Coil current |
|-------------|-----------------|-----------------|-----------------|-----------------|--------------|
| STD | Vdc | Vdc | Vdc | Ω | mA |
| LED bipolar | Vdc | Vdc | Vdc | Ω | mA |
| 006 | 6 | 4.5 | 0.6 | 32±10% | 187.5 |
| 012 | 12 | 9.0 | 1.2 | 110±10% | 109.1 |
| 024 | 24 | 18.0 | 2.4 | 475±10% | 50.5 |
| 048 | 48 | 36.0 | 4.8 | 2000±10% | 24.0 |
| 060 | 60 | 45.0 | 6.0 | 2850±10% | 21.1 |
| 110 | 110 | 82.5 | 11.0 | 10000±12% | 11.0 |
| 221 | 220 | 165.0 | 22.0 | 40000±15% | 5.5 |

All figures are given for coil without preenergization, at ambient temperature +20°C

* Protection diode PD; standard polarity: +A1 / -A2

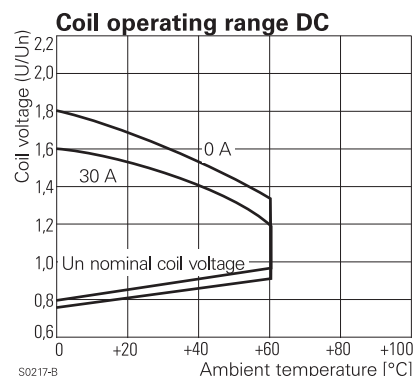
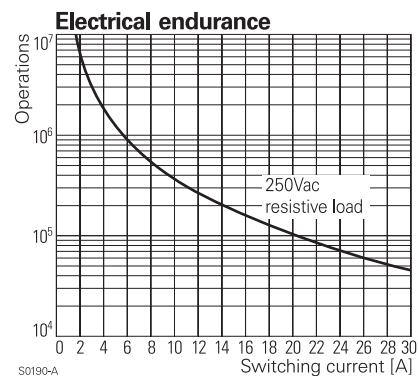
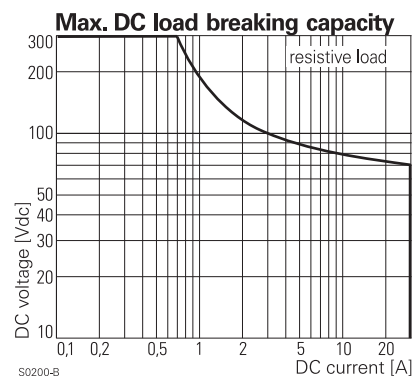

Power Relay RM C/D

1 pole 30 A, DC- or AC-coil

Coil versions, AC-coil, RMC, RMD

| Coil code | LED | Nominal voltage Vac | Pull-in voltage Vac | Release voltage Vac | Coil resistance Ω | Coil current mA |
|------------|------------|---------------------|---------------------|---------------------|--------------------------|-----------------|
| 524 | R24 | 24 | 19.2 | 9.6 | 80 ± 10% | 109.2 |
| 548 | R48 | 48 | 38.4 | 19.2 | 320 ± 10% | 54.2 |
| 560 | R60 | 60 | 48.0 | 24.0 | 500 ± 10% | 43.7 |
| 615 | S15 | 115 | 92.0 | 46.0 | 1850 ± 10% | 23.0 |
| 730 | T30 | 230 | 184.0 | 92.0 | 7500 ± 10% | 11.7 |
| 900 | V00 | 400 | 320.0 | 160.0 | 23500 ± 15% | 6.5 |

All figures are given for coil without preenergization, at ambient temperature +20°C

Insulation

| | | |
|---|----------------------|-----------------------|
| Dielectric strength | coil-contacts | 2500 V _{rms} |
| | open contact circuit | 1500 V _{rms} |
| | adjacent contacts | 4000 V _{rms} |
| Clearance / creepage | | ≥ 2.8 / 4 mm |
| Insulation to VDE 0110b (2/79) | | |
| Insulation category / reference voltage | | C / 250 |

Other data

| | | |
|--|---------|--|
| Ambient temperature | DC-coil | -45...+60 °C |
| | AC-coil | -45...+40 °C |
| Mechanical life | | >10x10 ⁶ operations |
| Max. switching rate at rated- / minimum load | | 16 min ⁻¹ / 100 min ⁻¹ |
| Operate- / release time | | approx. 17 / 18 ms |
| Bounce time | | approx. 4 ms |
| Vibration resistance N/O / N/C contact | | >10 / 5 g, 30...150 Hz |
| Category of protection (IEC 61810) | | RT I - dust protected |
| Relay weight | | 81 g |
| Packaging unit | | 10 pcs. |

Terminal assignment

View on solder pins
Dimensions in mm

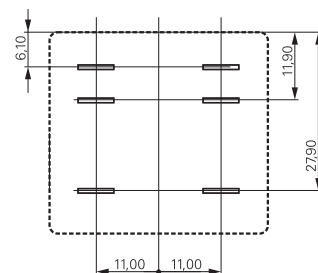

S0269-AK

1 N/O and 1 N/C contact, RMC

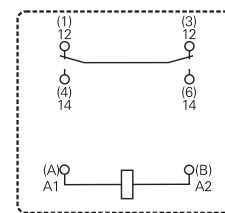

S0269-AH

1 N/O contact, RMD

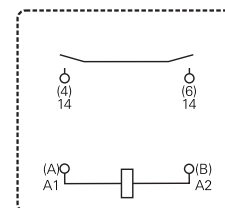

S0269-AI

Power Relay RM C/D

1 pole 30 A, DC- or AC-coil

Dimensions

Dimensions in mm

Cover with mounting brackets, FASTON 250

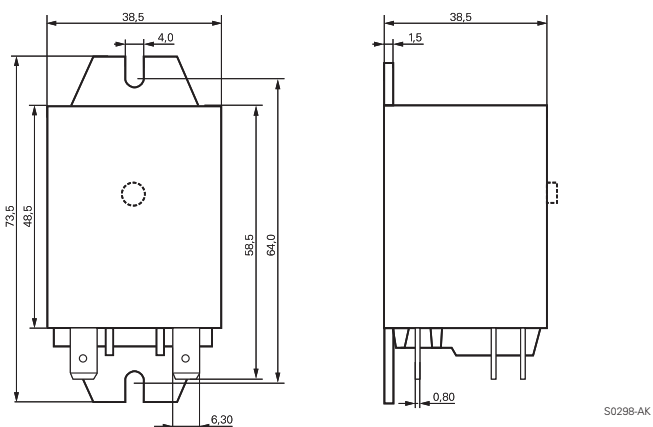

Product key

R M **5**

Type

Contacts

C 1 N/O contact and 1 N/C contact, 30 A

D 1 N/O contact, 30 A

Version

0 without test button

3 with test button

Mounting

5 cover with mounting brackets, AMP-Faston 250

Coil

Coil code: please refer to coil versions table, preferred types in bold print

AMP-Faston 250 = 6.3 x 0.8 mm

| Product key | Contacts | Version | Enclosure | Coil | Coil | Part number |
|-------------|--------------------------------|---------------------|------------------------------|---------|---------|-------------|
| RMC05024 | 1 N/O + 11 N/C contact 30 A | without test button | mounting brackets AMP 250 | DC-coil | 24 Vdc | 4-1393844-5 |
| RMC05524 | | with test button | | AC-coil | 24 Vac | 0-1393146-5 |
| RMC05615 | | | | | | 115 Vac |
| RMC05730 | | | | | 230 Vac | 0-1393146-6 |
| RMC35024 | | with test button | | DC-coil | 24 Vdc | 0-1393146-7 |
| RMD05024 | 1 N/O contact 30 A | without test button | | | 24 Vdc | 0-1393146-9 |
| RMD05524 | | with test button | | AC-coil | 24 Vac | 1-1393146-1 |
| RMD05615 | | | | | 115 Vac | 0-1415009-1 |
| RMD05730 | | | | | 230 Vac | 4-1393844-7 |
| RMD35024 | | with test button | | DC-coil | 24 Vdc | 2-1419136-2 |
| RMD35730 | | with test button | | AC-coil | 230 Vac | 0-1393097-5 |

Sockets and Accessories

Sockets and accessories for DIN rail

| relay | socket | | plastic retaining clip | | | | metal retaining clip | | module | marking tag |
|-----------------------|------------|---------|------------------------|---------|---------|---------|----------------------|---------|----------|-------------|
| | | | | | | | | | | |
| SNR | ST1F000 | ST16016 | | | | | | | | ST16040 |
| | rel.height | 12.3mm | 15.7mm | 25.5mm | | | | | | |
| RY pinning 3.2 | RY78626 | RY16046 | | | | | | | RPMxxxxx | RY16040 |
| RY pinning 5.0 | | | | | | | | | | |
| E pinning 2.5 | RP78623 | | | RP16104 | | | | | RPMxxxxx | RY16040 |
| RT pinning 3.5 | RT78724 | | RT17016 | | | | | | PTMxxxxx | RT17040 |
| | RT78624 | | RT16016 | | | | | | RPMxxxxx | RY16040 |
| RT pinning 5.0 | RT78726 | | RT17016 | | | | | | PTMxxxxx | RT17040 |
| | RT78625 | | RT16016 | | | | | | RPMxxxxx | RY16040 |
| | RT78626 | | RT16016 | | | | | | RPMxxxxx | RY16040 |
| RP pinning 3.5 | RT78724 | | | RT17016 | | | | | PTMxxxxx | RT17040 |
| | RT78624 | | | RP16104 | | | | | RPMxxxxx | RY16040 |
| RP pinning 5.0 | RT78726 | | | RT17016 | | | | | PTMxxxxx | RT17040 |
| | RT78625 | | | RP16104 | | | | | RPMxxxxx | RY16040 |
| | RT78626 | | | RP16104 | | | | | RPMxxxxx | RY16040 |
| | rel.height | 29mm | 34.6mm | 35.2mm | 36.6mm | 37.6mm | 29mm | 36mm | | |
| PT2 | PT78720 | PT17016 | PT17017 | PT17018 | PT17019 | PT17020 | PT28800 | ZG28801 | PTMxxxxx | PT17040 |
| | PT78702 | PT16016 | | | | | PT28800 | ZG28801 | RPMxxxxx | PT16040 |
| | PT78741 | PT17016 | PT17017 | PT17018 | PT17019 | PT17020 | PT28800 | ZG28801 | PTMT00A0 | PT17040 |
| PT3 | PT78730 | PT17016 | PT17017 | PT17018 | PT17019 | PT17020 | PT28800 | ZG28801 | PTMxxxxx | PT17040 |
| | PT78703 | PT16016 | | | | | PT28800 | ZG28801 | RPMxxxxx | PT16040 |
| PT5 | PT78740 | PT17016 | PT17017 | PT17018 | PT17019 | PT17020 | PT28800 | ZG28801 | PTMxxxxx | PT17040 |
| | PT78741 | PT17016 | PT17017 | PT17018 | PT17019 | PT17020 | PT28800 | ZG28801 | PTMT00A0 | PT17040 |
| | PT78704 | PT16016 | | | | | PT28800 | ZG28801 | RPMxxxxx | PT16040 |
| MT2 | MT78755 | | | | | | MT28800 | | | |
| | MT78745 | | | | | | MT28800 | | MTMxxxxx | |
| MT3 | MT78750 | | | | | | MT28800 | | | |
| | MT78760 | | | | | | MT28800 | | | |
| | MT78740 | | | | | | MT28800 | | MTMxxxxx | |
| PCLH | TM78700 | | | | | | TM28800 | | | |
| RMxx2 | RM78704 | | | | | | | | | |
| | RM78705 | | | | | | | | | |

Sockets and Accessories for printed circuit board

| relay | socket | | plastic retaining clip | | metal retaining clip | | in mounting plate | | marking tag |
|-----------------------|------------|---------|------------------------|---------|----------------------|---------|-------------------|----------------------|-------------|
| | | | | | | | socket | metal retaining clip | |
| | rel.height | 12.3mm | 15.7mm | 25.5mm | 15.7mm | 25.5mm | | | |
| RY pinning 3.2 | RY78600 | RY16037 | | | | | | | |
| RY pinning 5.0 | RY78602 | RY16037 | | | | | | | |
| E pinning 2.5 | RP78600 | | | RP16100 | | RP28500 | | | |
| RT pinning 3.5 | RP78601 | | RT16041 | | RT28516 | | | | |
| RT pinning 5.0 | RP78602 | | RT16041 | | RT28516 | | | | |
| RP pinning 3.5 | RP78601 | | | RP16100 | | RP28500 | | | |
| RP pinning 5.0 | RP78602 | | | RP16100 | | RP28500 | | | |
| | rel.height | | | | 29mm | 36mm | | 29mm | 36mm |
| PT2 | PT78604 | | | | PT28802 | ZG28800 | PT78600 | PT28802 | ZG28800 |
| | PT78602 | | | | PT28802 | ZG28800 | PT78601 | PT28802 | ZG28800 |
| PT3 | PT78603 | | | | PT28802 | ZG28800 | | | |
| PT5 | PT78604 | | | | PT28802 | ZG28800 | PT78600 | PT28802 | ZG28800 |
| | | | | | | | PT78601 | PT28802 | ZG28800 |
| MT2 | MT78602 | | | | | | MT78612 | | |
| MT3 | MT78603 | | | | | | MT78613 | | |
| PCLH | | | | | | | | | |
| RMxx2 | RM78702 | | | | RM28802 | | RM78700 | RM28802 | |
| | | | | | | | RM78701 | RM28802 | |

All sockets in this catalog have been tested and approved with the Tyco Electronics Schrack product range. For combination of sockets with other relays with similar design and pinning we cannot take responsibility for any malfunction.

Accessories Slim Interface Relay SNR



F0222-B

Features

- Module width 5.08 mm
- Reduced system width for increased packing density on the DIN rail
- Jumper bars

Dimensions in mm



Technical data

| | |
|--|---------------------------|
| Rated current / rated voltage | 6 A / 250 Vac |
| Dielectric strength coil-contact | >4000 V _{rms} |
| Insulation category (VDE 0110b) | C / 250 |
| Ambient temperature | -20...55 °C |
| Protection category | IP 20 |
| Protection against accidental contact meets | VBG 4 |
| Wire cross section with/without bootlace crimp | 0.22...2.5mm ² |
| Terminal torque nom./max. | 0.4 / 0.6 Nm |
| Packaging unit | 10 pcs. |

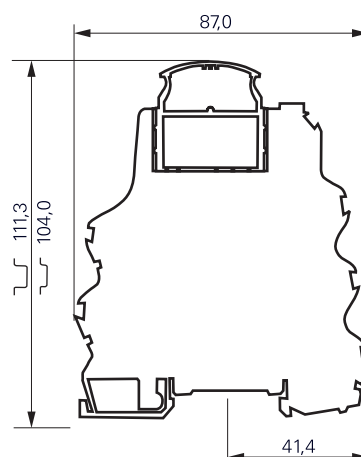

Accessories

| Product code | | Part Number |
|------------------|---|-------------|
| ST 1F 000 | Socket without LED | 4-1415024-1 |
| ST 1F L24 | Socket with LED, 12...24 Vdc | 5-1415024-1 |
| ST 16 016 | Mounting frame for relay, without marking | 6-1415024-1 |
| ST 17 002 | Jumper bar 2 pole | 7-1415024-1 |
| ST 17 005 | Jumper bar 5 pole | 8-1415024-1 |
| ST 17 010 | Jumper bar 10 pole | 9-1415024-1 |
| ST 16 040 | Marking plate, consisting of 100 marking tags | 0-1415025-1 |



Available sets

Set consisting of: relay in mounting frame, mounted on socket

| Product code | | Part Number |
|-------------------|---|-------------|
| ST 1P3 024 | 24 Vdc, AgSnO ₂ contacts | 3-1415024-1 |
| ST 1P3 L12 | 12 Vdc, with LED, AgSnO ₂ contacts | 2-1415025-1 |
| ST 1P3 L24 | 24 Vdc, with LED, AgSnO ₂ contacts | 3-1415025-1 |
| ST 1P3 L48 | 48 Vdc, with LED, AgSnO ₂ contacts | 4-1415025-1 |
| ST 1P2 L24 | 24 Vdc, with LED, AgSnO ₂ gold plated contacts | 6-1415025-1 |

Accessories Miniature PCB Relay RYII

and similar design: pinning 3.2 / 5 mm



Features

- Socket with PCB- or screw terminals
- No reduction of protection class or creepage/clearance with plastic retainer
- Easy replacement of relays
- Socket can be used as connector for diagnosis function
- Not suitable for MSR-type

Dimensions in mm
View on solder pins

RYII Socket with screw-type terminals for DIN-rail mounting

F0127-A

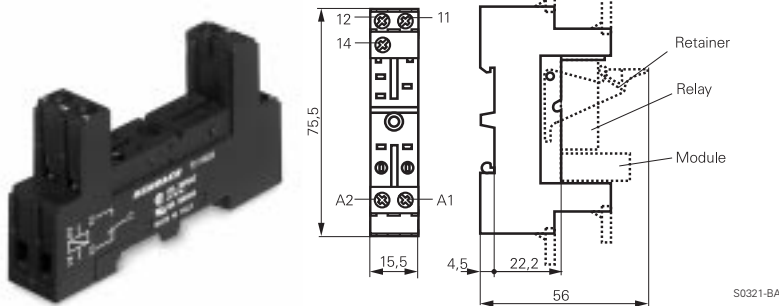

RY 78 626 Socket with screw-type terminals for DIN-rail mounting, pinning 3.2 mm



Technical data

| | |
|---|--|
| Rated current | 12 A |
| Rated voltage | 300 Vac |
| Dielectric strength coil/cont. | >4000 V _{rms} |
| Insulation cat. (VDE 0110b) | C / 250 Vac |
| Ambient temperature | -25...+85 °C |
| Protection category | IP 20 |
| Protection against accidental contact meets | VBG 4 |
| Wire cross section with bootlace crimp | 2 x 2.5 mm ² 2 x 1.5 mm ² |
| Packaging unit | 10 pcs. |

Socket with screw-type terminals for DIN-rail mounting

| Type | Part Number |
|---|-------------|
| RY 78 626 Socket with screw-type terminals for DIN-rail mounting, pinning 3.2 mm | 7-1393161-8 |

Accessories for RY 78 626

| | |
|--|-------------|
| RY 16 046 Plastic retaining clip | 7-1393161-1 |
| RY 16 040 Marking tag | 6-1393161-8 |
| RPM Modules see accessories RT / RP | |

RYII Socket with PCB terminals

RY 78 600 pinning 3.2 mm



F0125-A

RY 78 602 pinning 5 mm



F0126-A

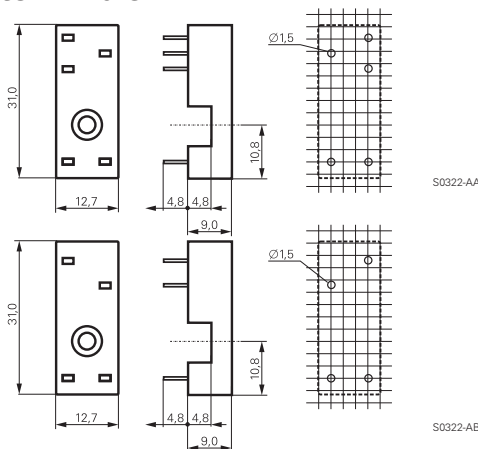

RY 78 600 Socket with PCB terminals, pinning 3.2 mm

RY 78 602 Socket with PCB terminals, pinning 5 mm



Technical data

| | |
|--------------------------------|------------------------|
| Rated current | 12 A |
| Rated voltage | 300 Vac |
| Dielectric strength coil/cont. | >5000 V _{rms} |
| Insulation cat. (VDE 0110b) | C / 250 Vac |
| Ambient temperature | -40...+80 °C |
| Packaging unit | 100 pcs. |

Socket with PCB terminals

| Type | Part Number |
|--|-------------|
| RY 78 600 Socket with PCB terminals, pinning 3.2 mm | 7-1393161-3 |
| RY 78 602 Socket with PCB terminals, pinning 5 mm | 7-1393161-4 |

Accessories for RY 78 600, RY 78 602

| | |
|---|-------------|
| RY 16 037 Plastic retaining clip | 6-1393161-5 |
|---|-------------|

Accessories PCB Relay Card Relay E

and similar design: pinning 2.5 mm

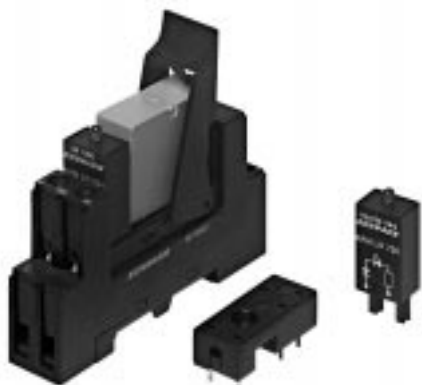

F0227-A

Features

- Socket with PCB- or screw terminals
- No reduction of protection class or creepage / clearance with plastic retainer
- Easy replacement of relays
- Socket can be used as connector for diagnosis function

Dimensions in mm
View on solder pins

Socket with screw-type terminals for DIN-rail mounting

F0118-A

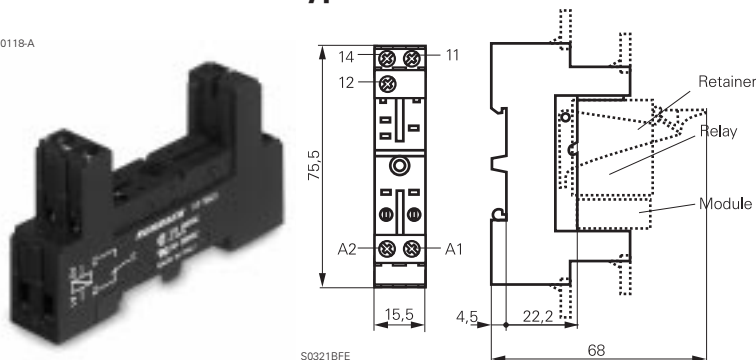

S0321BFE

RP 78 623 Socket with screw-type terminals, pinning 2.5 mm, for DIN-rail mounting



Technical data

| | |
|---|-------------------------|
| Rated current | 12 A |
| Rated voltage | 300 Vac |
| Dielectric strength coil/cont. | >4000 V _{rms} |
| Insulation cat. (VDE 0110b) | C / 250 Vac |
| Ambient temperature | -25...+85 °C |
| Protection category | IP 20 |
| Protection against accidental contact meets | VBG 4 |
| Wire cross section | 2 x 2.5 mm ² |
| with bootlace crimp | 2 x 1.5 mm ² |
| Packaging unit | 10 pcs. |

Socket with screw-type terminals for DIN-rail mounting

| Product code | Part Number |
|---|-------------|
| RP 78 623 Socket with screw-type terminals, pinning 2.5 mm for DIN-rail mounting | 8-1393234-6 |

Accessories for RP 78 623

| Ordering code | Type | Part Number |
|------------------|---------------------------------|-------------|
| RP 16 104 | Plastic retaining clip | 1-1393161-8 |
| RY 16 040 | Marking tag | 6-1393161-8 |
| RP M | Modules see accessories RT / RP | |

Socket with PCB terminals



F0137-A

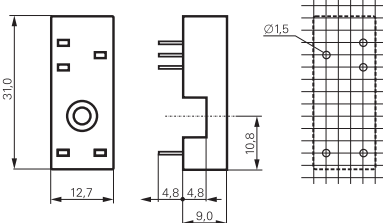

S0322-AE

RP 78 600 Socket with PCB terminals, pinning 2.5 mm



Technical data

| | |
|--------------------------------|------------------------|
| Rated current | 12 A |
| Rated voltage | 300 Vac |
| Dielectric strength coil/cont. | >5000 V _{rms} |
| Insulation cat. (VDE 0110b) | C / 250 Vac |
| Ambient temperature | -40...+80 °C |
| Packaging unit | 100 pcs. |

Socket with PCB terminals

| Product code | Part Number |
|--|-------------|
| RP 78 600 Socket with PCB terminals, pinning 2.5 mm | 8-1393234-3 |

Accessories for RP 78 600

| Product code | Type | Part Number |
|------------------|------------------------|-------------|
| RP 16 100 | Plastic retaining clip | 1-1393161-7 |
| RP 28 500 | Metal retaining clip | 1-1393161-9 |

Accessories Industrial Power Relay RT / RP / SR2M

and similar design: pinnings 3.5mm / 5mm; relay heights 15.7 / 25.5mm



F0228-A

Features

- New retainer clip with ejection function
- Easy replacement of relays on a densely packed DIN rail
- High quality rising clamp terminals
- Captive combination terminal screws
- No reduction of protection class or creepage/clearance with plastic retainer
- Simple plug-in indicator- and protection modules
- White snap-on tags
- Not suitable for bistable relays with 2 coils

Accessories for sockets:

- Rejector
- LED- and protection modules
- Marking tags

Dimensions in mm

Socket with screw-type terminals for DIN rail mounting



F0229-A

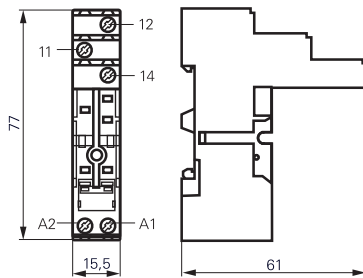

S0416-AA

RT 78 724 Socket with screw-type terminals, pinning 3.5 mm for DIN rail mounting



Technical data

| | |
|-----------------------------|-------------------------|
| Rated current | 12 A |
| Rated voltage | 250 Vac |
| Insulation cat. (VDE 0110b) | C / 250 Vac |
| Ambient temperature | -25...85 °C |
| Protection category | IP 20 |
| Wire cross section | 2 x 2.5 mm ² |
| with bootlace crimp | 2 x 1.5 mm ² |
| Terminal torque | 0.5 Nm |
| max. | 0.7 Nm |
| Packaging unit | 10 pcs. |

RT 78 724 and RT 78 726

- Logical setup of connections (input / output)
- Safe separation to VDE 0106



F0230-A

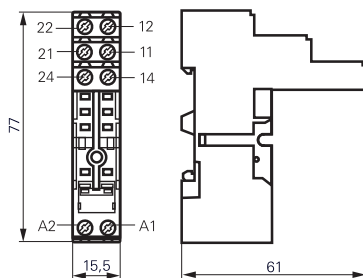

S0416-AB

RT 78 726 Socket with screw-type terminals, pinning 5 mm for DIN rail mounting



Technical data

| | | |
|-----------------------------|-------------------------|----------|
| Rated current | 1 pole | 12 A *) |
| | 2 pole | 2 x 12 A |
| Rated voltage | 250 Vac | |
| Insulation cat. (VDE 0110b) | C / 250 Vac | |
| Ambient temperature | -25...85 °C | |
| Protection category | IP 20 | |
| Wire cross section | 2 x 2.5 mm ² | |
| with bootlace crimp | 2 x 1.5 mm ² | |
| Terminal torque | 0.5 Nm | |
| max. | 0.7 Nm | |
| Packaging unit | 10 pcs. | |

*) For 1 pole relays (16 A) the relay terminals 11-21, 12-22 and 14-24 have to be bridged
For 1 pole relays (12 A) the relay terminals 11-12-14 have to be connected to the socket terminals 21-12-24

Socket with screw-type terminals for DIN rail mounting

| Type | | Part Number |
|------------------|--|-------------|
| RT 78 724 | Socket with screw-type terminals, pinning 3.5 mm for DIN rail mounting | 8-1415035-1 |
| RT 78 726 | Socket with screw-type terminals, pinning 5 mm for DIN rail mounting | 6-1415035-1 |

Accessories Industrial Power Relay RT / RP / SR2M

and similar design: pinnings 3.5mm / 5mm; relay heights 15.7 / 25.5mm

Accessories for RT 78 724, RT 78 726

| Type | | Part Number |
|------------------|---|-------------|
| RT 17 016 | Plastic retaining clip, relay height 15.7 and 25.5 mm | 1-1415038-1 |
| RT 17 040 | Marking tag | 2-1415038-1 |

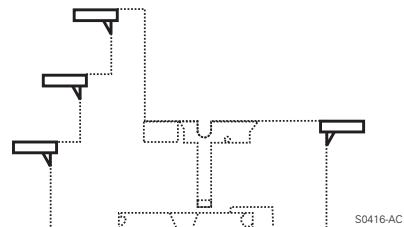

Marking tags

- White marking area 15.5 x 6 mm
- Snaps on socket in up to 4 positions

LED- and Protection Modules for RT 78 724, RT 78 726

Easy insertion of module into the socket

Wiring in parallel to the coil

| Type | | Part Number |
|-------------------|-----------------------------|-------------|
| PTM T0 0A0 | Protection diode (A1+, A2-) | 9-1415036-1 |
| PTM T0 0L0 | Protection diode (A1-, A2+) | 0-1415037-1 |
| PTM U0 524 | RC-network 6...60 Vac | 1-1415037-1 |
| PTM U0 730 | RC-network 110...230 Vac | 2-1415037-1 |
| PTM V0 524 | Varistor 24 Vac | 3-1415037-1 |
| PTM V0 730 | Varistor 230 Vac | 4-1415037-1 |

LED

| | | |
|-------------------|---|-------------|
| PTM L0 524 | red LED 6...24 Vdc/Vac | 6-1415036-1 |
| PTM G0 524 | green LED 6...24 Vdc/Vac | 3-1415036-1 |
| PTM L0 024 | red LED 6...24 Vdc w. prot.diode (A1+, A2-) | 5-1415036-1 |
| PTM G0 024 | green LED 6...24 Vdc w. prot.diode (A1+, A2-) | 2-1415036-1 |
| PTM L1 024 | red LED 6...24 Vdc w. prot. diode (A1-, A2+) | 8-1415036-1 |
| PTM L0 730 | red LED 110...230 Vac | 7-1415036-1 |
| PTM G0 730 | green LED 110...230 Vac | 4-1415036-1 |



F0231-A



F0232-A

Accessories Industrial Power Relay RT / RP / SR2M

and similar design: pinning 3.5mm / 5mm; relay heights 15.7 / 25.5mm

Dimensions in mm

RT 78 624 Socket with screw-type terminals, pinning 3.5 mm for DIN rail mounting

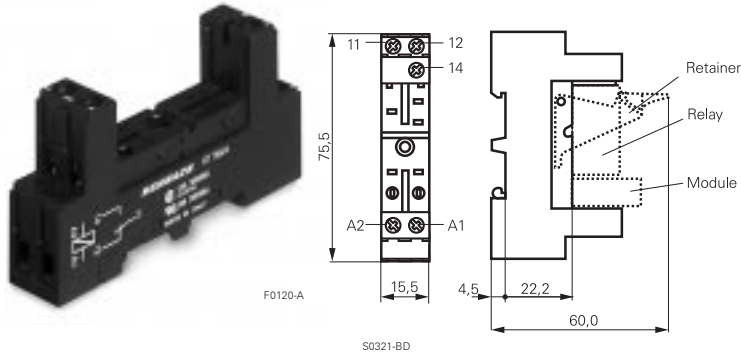

Technical data

| | |
|---|-------------------------|
| Rated current | 12 A |
| Rated voltage | 300 Vac |
| Dielectric strength coil/cont. | >4000 V _{rms} |
| Insulation cat. (VDE 0110b) | C / 250 Vac |
| Ambient temperature | -25...+85 °C |
| Protection category | IP 20 |
| Protection against accidental contact meets | VBG 4 |
| Wire cross section | 2 x 2.5 mm ² |
| with bootlace crimp | 2 x 1.5 mm ² |
| Packaging unit | 10 pcs. |

RT 78 625 Socket with screw-type terminals, pinning 5 mm for DIN rail mounting

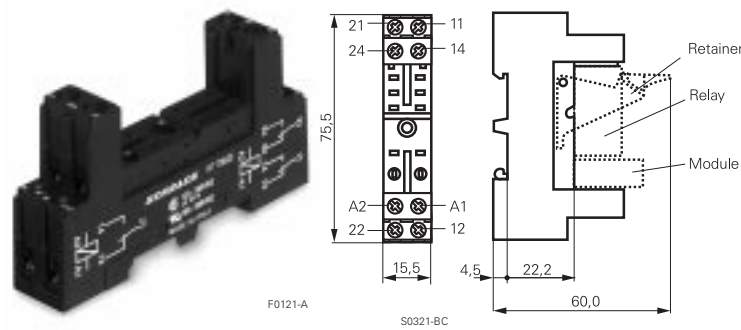

Technical data

| | |
|---|-------------------------|
| Rated current | 1 pole 12 A *) |
| | 2 pole 2 x 12 A |
| Rated voltage | 300 Vac |
| Dielectric strength coil/cont. | >4000 V _{rms} |
| Insulation cat. (VDE 0110b) | C / 250 Vac |
| Ambient temperature | -25...+80 °C |
| Protection category | IP 20 |
| Protection against accidental contact meets | VBG 4 |
| Wire cross section | 2 x 2.5 mm ² |
| with bootlace crimp | 2 x 1.5 mm ² |
| Packaging unit | 10 pcs. |

RT 78 624 and RT 78 626

- Logical setup of connections (input / output)
- Safe separation to VDE 0106

*) For 1 pole relays (16 A) the terminals 11-21, 12-22 and 14-24 have to be bridged
For 1 pole relays (12 A) the terminals 11-12-14 have to be connected to the socket terminals 21-12-24

RT 78 626 Socket with screw-type terminals, pinning 5 mm for DIN rail mounting

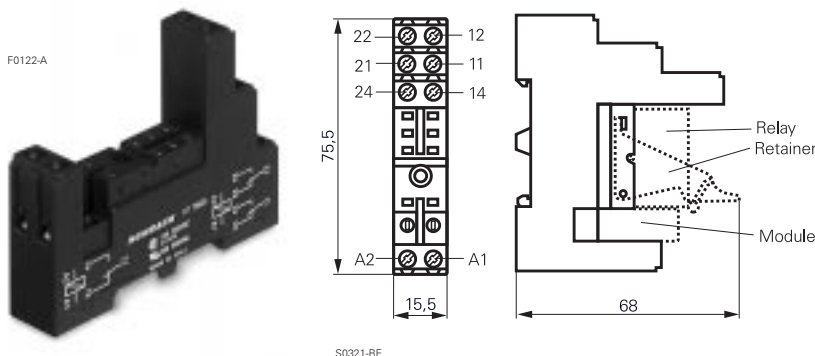

Technical data

| | |
|---|-------------------------|
| Rated current | 1 pole 12 A *) |
| | 2 pole 2 x 12 A |
| Rated voltage | 300 Vac |
| Dielectric strength coil/cont. | >4000 V _{rms} |
| Insulation cat. (VDE 0110b) | C / 250 Vac |
| Ambient temperature | -25...+80 °C |
| Protection category | IP 20 |
| Protection against accidental contact meets | VBG 4 |
| Wire cross section | 2 x 2.5 mm ² |
| with bootlace crimp | 2 x 1.5 mm ² |
| Packaging unit | 10 pcs. |

*) For 1 pole relays (16 A) the terminals 11-21, 12-22 and 14-24 have to be bridged
For 1 pole relays (12 A) the terminals 11-12-14 have to be connected to the socket terminals 21-12-24

Socket with screw-type terminals, for DIN rail mounting

| Type | Part Number |
|-----------|---|
| RT 78 624 | Socket with screw-type terminals, pinning 3.5 mm for DIN rail mounting 2-1419108-1 |
| RT 78 625 | Socket with screw-type terminals, pinning 5 mm for DIN rail mounting 2-1419108-2 |
| RT 78 626 | Socket with screw-type terminals, pinning 5 mm for DIN rail mounting 2-1419108-3 |

Accessories Industrial Power Relay RT / RP / SR2M

and similar design: pinnings 3.5mm / 5mm; relay heights 15.7 / 25.5mm

Dimensions in mm
View on solder pins

Accessories for RT 78 624, RT 78 625, RT 78 626

| Type | | Part Number |
|------------------|---|-------------|
| RT 16 016 | Plastic retaining clip RT, relay height 15.7 mm | 3-1393161-3 |
| RP 16 104 | Plastic retaining clip RP, relay height 25.5 mm | 1-1393161-8 |
| RY 16 040 | Marking tag | 6-1393161-8 |

LED- and Protection Modules for RT 78 624, RT 78 625, RT 78 626 and RP 78 623, RY 78 626

Easy insertion of module into the socket

Wiring in parallel to the coil

| Type | | Part Number |
|-------------------|---------------------------------------|-------------|
| RPM T0 0A0 | Protection diode 1N4007 ¹⁾ | 1-1393161-1 |
| RPM U0 548 | RC-network 24...48 Vac | 1-1393161-3 |
| RPM U0 730 | RC-network 110...230 Vac | 1-1393161-4 |

LED

| | | |
|-------------------|---|-------------|
| RPM L0 024 | red LED 12...24 Vdc w.prot.diode ¹⁾ | 0-1393161-4 |
| RPM G0 024 | green LED 12...24 Vdc w.prot.diode ¹⁾ | 0-1393161-3 |
| RPM L0 524 | red LED 12...48 Vdc / Vac | 0-1393161-7 |
| RPM G0 524 | green LED 12...48 Vdc / Vac | 2-1419152-4 |
| RPM L0 110 | red LED 60...110 Vdc w.prot.diode ¹⁾ | 0-1393161-6 |
| RPM G0 110 | green LED 60...110 Vdc w.prot.diode ¹⁾ | 2-1419152-3 |
| RPM L0 730 | red LED 110...230 Vac | 0-1393161-8 |
| RPM G0 730 | green LED 110...230 Vac | 2-1419152-5 |

¹⁾ Standard polarity: A1:+, A2:-

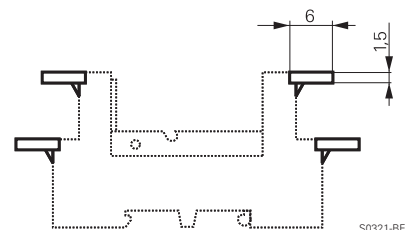

Marking tags

- White marking area 15.5 x 6 mm
- Snaps on socket in up to 4 positions

F0123-A



Socket with PCB terminals

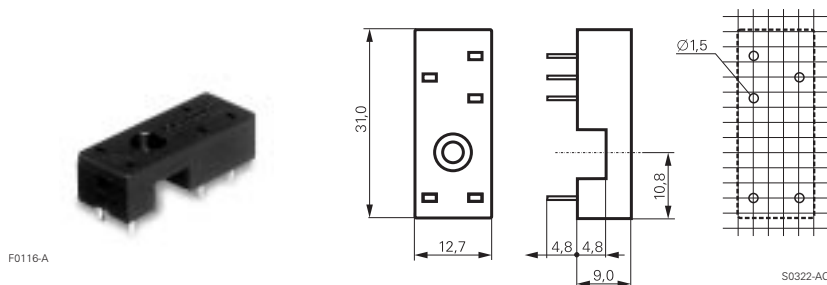

RP 78 601 Socket with PCB terminals, pinning 3.5 mm



Technical data

| | |
|--------------------------------|------------------------|
| Rated current | 12 A |
| Rated voltage | 300 Vac |
| Dielectric strength coil/cont. | >5000 V _{rms} |
| Insulation cat. (VDE 0110b) | C / 250 Vac |
| Ambient temperature | -40...+80 °C |
| Packaging unit | 100 pcs. |

F0116-A

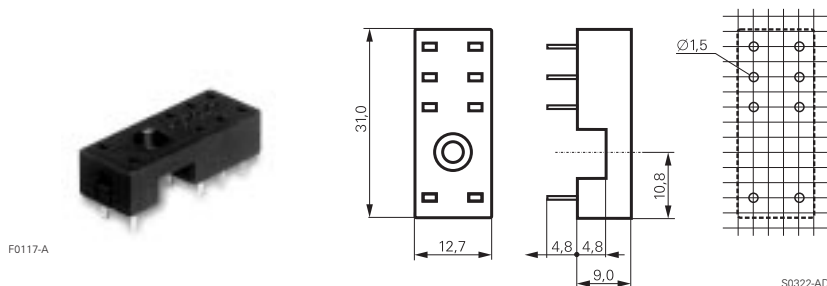

RP 78 602 Socket with PCB terminals, pinning 5 mm



Technical data

| | | |
|--------------------------------|--------|------------------------|
| Rated current | 1 pole | 12 A |
| | 2 pole | 2 x 12 A |
| Rated voltage | | 300 Vac |
| Dielectric strength coil/cont. | | >5000 V _{rms} |
| Insulation cat. (VDE 0110b) | | C / 250 Vac |
| Ambient temperature | | -40...+80 °C |
| Packaging unit | | 100 pcs. |

F0117-A

Socket with PCB terminals

| Type | | Part Number |
|------------------|---|-------------|
| RP 78 601 | Socket with PCB terminals, pinning 3.5 mm | 8-1393234-4 |
| RP 78 602 | Socket with PCB terminals, pinning 5 mm | 8-1393234-5 |

Accessories for RP 78 601, RP 78 602

| Type | | Part Number |
|------------------|---|-------------|
| RT 16 041 | Plastic retaining clip RT, relay height 15.7 mm | 3-1393161-4 |
| RP 16 100 | Plastic retaining clip RP, relay height 25.5 mm | 1-1393161-7 |
| RT 28 516 | Metal retaining clip RT, relay height 15.7 mm | 0-1419108-7 |
| RP 28 500 | Metal retaining clip RP, relay height 25.5 mm | 1-1393161-9 |

Accessories Miniature Relay PT

and similar design: relay heights 29 / 34.6 / 35.2 / 36.6 / 37.6mm



F0233-A

Features

- Easy replacement of relays on a densely packed DIN rail
- High quality rising clamp terminals
- Captive combination terminal screws
- No reduction of protection class or creepage/clearance with plastic retainer
- Simple plug-in indicator- and protection modules
- White snap-on tags

Accessories for sockets:

- Retaining clip
- LED- and protection modules
- Marking tags

Dimensions in mm

PT DIN-rail socket with screw type terminals



F0234-A

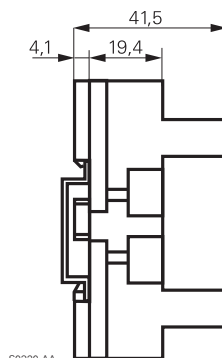
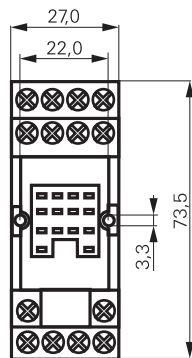

S0320-AA



Technical data

| | | |
|---|---|------|
| Rated current | 4-pole | 6 A |
| | 3-pole | 10 A |
| | 2-pole | 12 A |
| Rated voltage | 250 Vac | |
| Insulation cat. (VDE 0110b) | C / 250 Vac | |
| Ambient temperature | -45...+70 °C | |
| Protection category | IP 20 | |
| Protection against accidental contact meets | VBG 4 | |
| Wire cross section | 2 x 2.5 mm ² | |
| | with bootlace crimp 2 x 1.5 mm ² | |
| Terminal torque | 0.5 Nm | |
| | max. 0.7 Nm | |
| Packaging unit | 10 pcs. | |

DIN-rail socket with screw type terminals

| Type | | Part Number |
|------------------|--|-------------|
| PT 78 720 | DIN-rail socket with screw type terminals, 2 pole | 6-1415034-1 |
| PT 78 730 | DIN-rail socket with screw type terminals, 3 pole | 9-1415071-1 |
| PT 78 740 | DIN-rail socket with screw type terminals, 4 pole | 4-1415033-1 |
| PT 78 741 | DIN-rail socket with screw type terminals, 4 pole package with protection diode module | 5-1415034-1 |

Accessories for PT 78 720, PT 78 730, PT 78 740, PT 78 741

| Type | | Part Number |
|------------------|---|-------------|
| PT 17 016 | Plastic retaining clip PT, relay height 29 mm | 5-1415037-1 |
| PT 17 017 | Plastic retaining clip, relay height 34.6 mm | 7-1415037-1 |
| PT 17 018 | Plastic retaining clip, relay height 35.2 mm | 8-1415037-1 |
| PT 17 019 | Plastic retaining clip, relay height 36.6 mm | 9-1415037-1 |
| PT 17 020 | Plastic retaining clip, relay height 37.6 mm | 0-1415038-1 |
| PT 28 800 | Metal retaining clip PT, relay height 29 mm | 5-1419111-9 |
| ZG 28 801 | Metal retaining clip, relay height 36 mm | 1-1393162-5 |
| PT 17 040 | Marking tag | 6-1415037-1 |

Accessories Miniature Relay PT

and similar design: relay heights 29 / 34.6 / 35.2 / 36.6 / 37.6mm

LED- and Protection Modules for PT 78 720, PT 78 730 and PT 78 740

Easy insertion of module into the socket

Wiring in parallel to the coil

| Type | | Part Number |
|-------------------|-----------------------------|-------------|
| PTM T0 0A0 | Protection diode (A1+, A2-) | 9-1415036-1 |
| PTM T0 0L0 | Protection diode (A1-, A2+) | 0-1415037-1 |
| PTM U0 524 | RC-network 6...60 Vac | 1-1415037-1 |
| PTM U0 730 | RC-network 110...230 Vac | 2-1415037-1 |
| PTM V0 524 | Varistor 24 Vac | 3-1415037-1 |
| PTM V0 730 | Varistor 230 Vac | 4-1415037-1 |

LED

| | | |
|-------------------|---|-------------|
| PTM L0 524 | red LED 6...24 Vdc/Vac | 6-1415036-1 |
| PTM G0 524 | green LED 6...24 Vdc/Vac | 3-1415036-1 |
| PTM L0 024 | red LED 6...24 Vdc w. prot.diode (A1+, A2-) | 5-1415036-1 |
| PTM G0 024 | green LED 6...24 Vdc w. prot.diode (A1+, A2-) | 2-1415036-1 |
| PTM L1 024 | red LED 6...24 Vdc w. prot. diode (A1-, A2+) | 8-1415036-1 |
| PTM L0 730 | red LED 110...230 Vac | 7-1415036-1 |
| PTM G0 730 | green LED 110...230 Vac | 4-1415036-1 |



F0231-A



F0232-A

Accessories Miniature Relay PT

and similar design: relay heights 29 / 34.6 / 35.2 / 36.6 / 37.6mm

Dimensions in mm

PT DIN-rail socket with screw type terminals



F0192-A

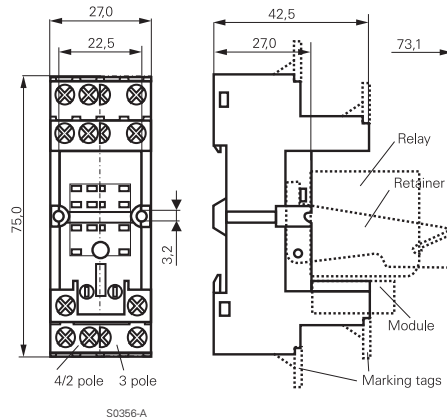

S0356-A

Technical data

| | |
|---|-----------------------------|
| Rated current | 4 x 6 A, 3 x 10 A, 2 x 12 A |
| Rated voltage | 300 Vac |
| Dielectric strength coil/cont. | >4000 V _{eff} |
| Insulation category (VDE 0110b) | C / 250 Vac |
| Ambient temperature | -45...+70 °C ¹⁾ |
| Protection category | IP 20 |
| Protection against accidental contact meets | VBG 4 |
| Wire cross section | 2 x 2.5 mm ² |
| with bootlace crimp | 2 x 1.5 mm ² |
| Terminal torque | 0.5 Nm |
| max. | 0.8 Nm |
| Packaging unit | 10 pcs. |

¹⁾ at rated current to +40 °C, up to +70 °C at 70% of rated current

DIN-rail socket with screw type terminals

| Type | | Part Number |
|------------------|---|-------------|
| PT 78 702 | DIN-rail socket with screw type terminals, 2 pole | 9-1419111-9 |
| PT 78 703 | DIN-rail socket with screw type terminals, 3 pole | 0-1419112-1 |
| PT 78 704 | DIN-rail socket with screw type terminals, 4 pole | 0-1419112-2 |

Accessories for PT 78 702, PT 78 703, PT 78 704

| Type | | Part Number |
|------------------|---|-------------|
| PT 16 016 | Plastic retaining clip PT, relay height 29 mm | 3-1419111-8 |
| PT 28 800 | Metal retaining clip PT, relay height 29 mm | 5-1419111-9 |
| ZG 28 801 | Metal retaining clip, relay height 36 mm | 1-1393162-5 |
| PT 16 040 | Marking tag | 3-1419111-9 |

LED- and Protection Modules for PT 78 702, PT 78 703, PT 78 704

Easy insertion of module into the socket

Wiring in parallel to the coil

| Type | | Part Number |
|-------------------|---------------------------------------|-------------|
| RPM T0 0A0 | Protection diode 1N4007 ¹⁾ | 1-1393161-1 |
| RPM U0 548 | RC-network 24...48 Vac | 1-1393161-3 |
| RPM U0 730 | RC-network 110...230 Vac | 1-1393161-4 |

LED

| | | |
|-------------------|---|-------------|
| RPM L0 024 | red LED 12...24 Vdc w.prot.diode ¹⁾ | 0-1393161-4 |
| RPM G0 024 | green LED 12...24 Vdc w.prot.diode ¹⁾ | 0-1393161-3 |
| RPM L0 524 | red LED 12...48 Vdc / Vac | 0-1393161-7 |
| RPM G0 524 | green LED 12...48 Vdc / Vac | 2-1419152-4 |
| RPM L0 110 | red LED 60...110 Vdc w.prot.diode ¹⁾ | 0-1393161-6 |
| RPM G0 110 | green LED 60...110 Vdc w.prot.diode ¹⁾ | 2-1419152-3 |
| RPM L0 730 | red LED 110...230 Vac | 0-1393161-8 |
| RPM G0 730 | green LED 110...230 Vac | 2-1419152-5 |

¹⁾ Standard polarity: A1+, A2-

F0123-A



Accessories Miniature Relay PT

and similar design: relay heights 29 / 34.6 / 35.2 / 36.6 / 37.6mm

Dimensions in mm
View on solder pins

PT 78 600 Socket with solder terminals, 4 pole



F0132-A

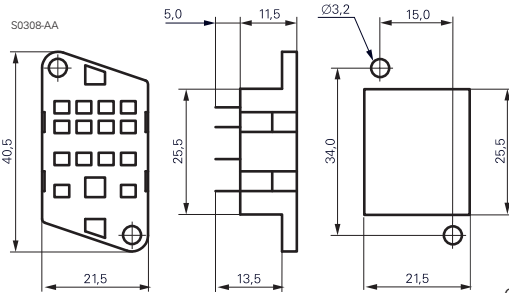

Chassis cut-out

Technical data

| | |
|--------------------------------|------------------------|
| Rated current | 10 A |
| Rated voltage | 250 Vac |
| Dielectric strength coil/cont. | >1500 V _{rms} |
| Ambient temperature | -40...+70 °C |
| Packaging unit | 25 pcs. |

PT 78 604 4 pole Socket with PCB terminals

PT 78 603 3 pole

PT 78 602 2 pole



F0133-A

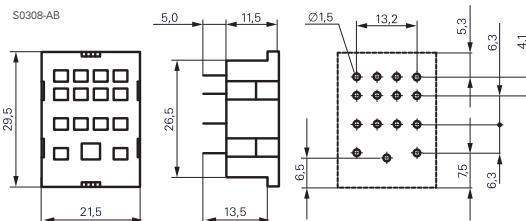

Technical data

| | |
|--------------------------------|------------------------|
| Rated current | 10 A |
| Rated voltage | 250 Vac |
| Dielectric strength coil/cont. | >1500 V _{rms} |
| Ambient temperature | -40...+70 °C |
| Packaging unit | 25 pcs. |

PT 78 601 Socket with solder terminals, 4 pole



F0134-A

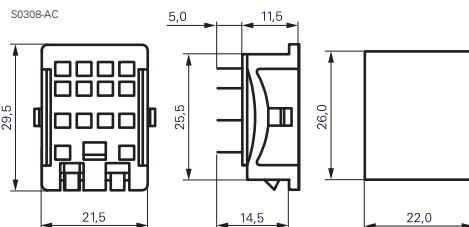

Chassis cut-out

Technical data

| | |
|--------------------------------|------------------------|
| Rated current | 10 A |
| Rated voltage | 250 Vac |
| Dielectric strength coil/cont. | >1500 V _{rms} |
| Ambient temperature | -40...+70 °C |
| Packaging unit | 25 pcs. |

PT sockets

| Type | | Part Number |
|------------------|--------------------------------------|-------------|
| PT 78 600 | Socket with solder terminals, 4 pole | 4-1415043-1 |
| PT 78 602 | Socket with PCB terminals, 2 pole | 5-1415043-1 |
| PT 78 603 | Socket with PCB terminals, 3 pole | 0-1393162-5 |
| PT 78 604 | Socket with PCB terminals, 4 pole | 3-1415043-1 |
| PT 78 601 | Socket with solder terminals, 4 pole | 6-1415043-1 |

Accessories for PT 78 600, PT 78 601, PT 78 602, PT 78 603, PT 78 604

| Type | | Part Number |
|------------------|---|-------------|
| PT 28 802 | Metal retaining clip PT, relay height 29 mm | 0-1393162-1 |
| ZG 28 800 | Metal retaining clip, relay height 36 mm | 1-1393162-4 |

Accessories Multimode Relay MT

and similar design: octal / undecal



F0235-A

Features

- Snap-on mounting on DIN-rail
- Screw mounting
- Pozidrive screws with rising clamp terminals
- Logical layout of input/output connections
- White marking area

Dimensions in mm

MT DIN-rail sockets with screw-type terminals

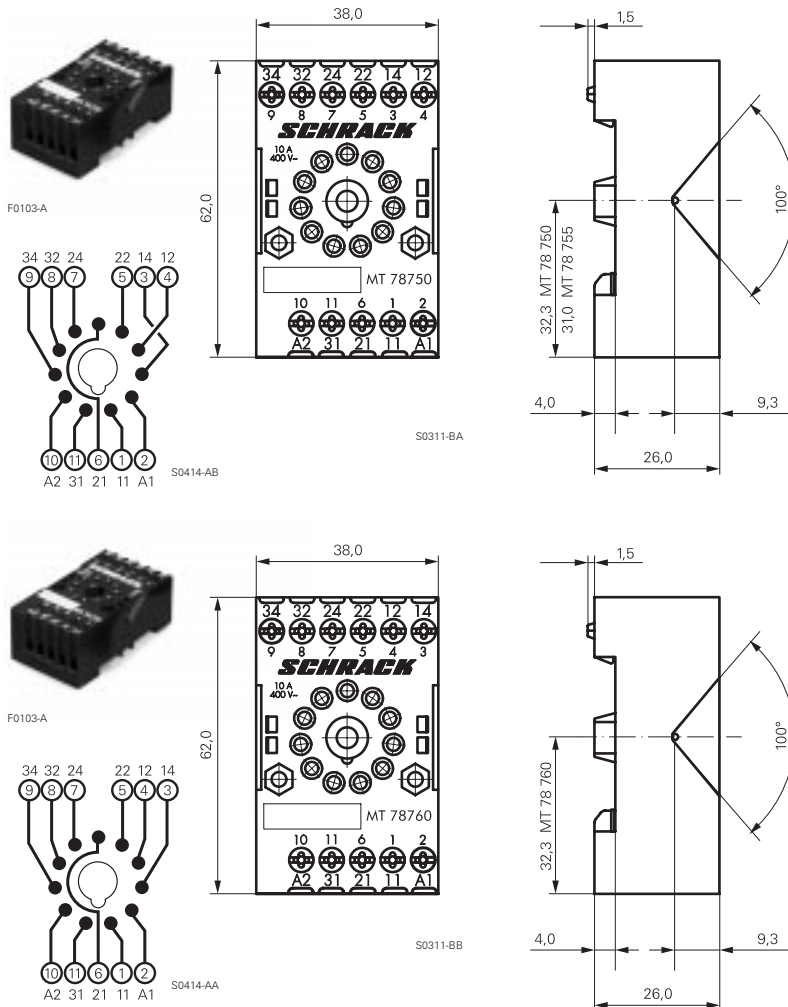

F0103-A

S0414-AB

S0311-BA

F0103-A

S0414-AA

S0311-BB

MT 78 750 MT3 DIN-rail socket with screw-type terminals 11 pole

MT 78 755 MT2 DIN-rail socket with screw-type terminals 8 pole



Technical data

| | |
|---|-------------------------|
| Rated current | 10 A |
| Rated voltage | 400 Vac |
| Dielectric strength coil/cont. | >3500 V _{rms} |
| Insulation cat. (VDE 0110b) | C / 400 Vac |
| Tracking resistance | CTI 300 |
| Ambient temperature | +80 °C |
| Protection category | IP 20 |
| Protection against accidental contact meets | VBG 4 |
| Mounting | DIN 50024 / 22 |
| Wire cross section | 2 x 2.5 mm ² |
| Terminal torque | 0.8 Nm |
| max. | 1.0 Nm |
| Packaging unit | 25 pcs. |

MT 78 760 MT3 DIN-rail socket with screw-type terminals 11 pole



Technical data

| | |
|---|-------------------------|
| Rated current | 10 A |
| Rated voltage | 400 Vac |
| Dielectric strength coil/cont. | >3500 V _{rms} |
| Insulation cat. (VDE 0110b) | C / 400 Vac |
| Tracking resistance | CTI 300 |
| Ambient temperature | +80 °C |
| Protection category | IP 20 |
| Protection against accidental contact meets | VBG 4 |
| Mounting | DIN 50024 / 22 |
| Wire cross section | 2 x 2.5 mm ² |
| Terminal torque | 0.8 Nm |
| max. | 1.0 Nm |
| Packaging unit | 25 pcs. |

DIN-rail sockets with screw-type terminals

| Type | | Part Number |
|------------------|---|-------------|
| MT 78 750 | MT3 DIN-rail socket with screw-type terminals 11 pole | 0-1415035-1 |
| MT 78 755 | MT2 DIN-rail socket with screw-type terminals 8 pole | 3-1415035-1 |
| MT 78 760 | MT3 DIN-rail socket with screw-type terminals 11 pole | 8-1415034-1 |

Accessories for MT 78 750, MT 78 755, MT 78 760

| | | |
|------------------|-------------------------|-------------|
| MT 28 800 | Metal retaining clip MT | 8-1393163-0 |
|------------------|-------------------------|-------------|

Accessories Multimode Relay MT

and similar design: octal / undecal

Dimensions in mm

MT 78 740 MT3 DIN-rail socket with screw-type terminals 11 pole

MT 78 745 MT2 DIN-rail socket with screw-type terminals 8 pole

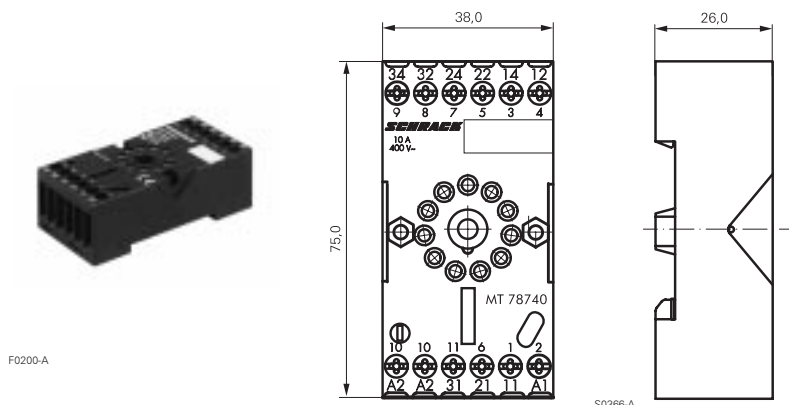

Technical Data

| | |
|---|------------------------|
| Rated current | 10 A |
| Rated voltage | 400 Vac |
| Dielectric strength coil/cont. | >3000 V _{eff} |
| Ambient temperature | +80 °C |
| Protection category | IP 20 |
| Protection against accidental contact meets | VBG 4 |
| Mounting/DIN rail | DIN50022 |
| Wire cross section | 2 x 2,5mm ² |
| Terminal torque | 0.8 Nm |
| Packaging unit | 10 Stk. |

DIN-rail socket with screw-type terminals

| Type | | Part Number |
|-----------------|--|-------------|
| MT78 740 | DIN-rail socket with screw-type terminals, 11 pole | 8-1393163-3 |
| MT78 745 | DIN-rail socket with screw-type terminals, 8 pole | 8-1393163-4 |

Socket system MT 78 740 and MT 78 745

- 8/11 pin socket for MT2 / MT3
- Double A2 screw for simple further connection of coil supply

Accessories for MT 78 740, MT 78 745

| Type | | Part Number |
|------------------|-------------------------|-------------|
| MT 28 800 | Metal retaining clip MT | 8-1393163-0 |

LED and Protection modules for MT 78 740, MT 78 745

| Type | | Part Number |
|-------------------|--------------------------|-------------|
| MTM T0 0A0 | Protection diode 1N4007 | 7-1393163-6 |
| MTM U0 524 | RC-network 6...24 Vac | 7-1393163-7 |
| MTM U0 730 | RC-network 110...230 Vac | 7-1393163-8 |

LED

| | | |
|-------------------|-------------------------------|-------------|
| MTM L0 024 | red LED 24 Vac / Vdc | 7-1393163-4 |
| MTM G0 024 | green LED 24 Vac / Vdc | 6-1419149-6 |
| MTM L0 730 | red LED 110...230 Vac / Vdc | 7-1393163-5 |
| MTM G0 730 | green LED 110...230 Vac / Vdc | 6-1419149-7 |

Function modules for MT 78 740, MT 78 745

| Type | | Part Number |
|-------------------|---------------|-------------|
| MTM Z0 W00 | Delay ON | 7-1393163-9 |
| MTM F0 W00 | Multifunction | 7-1393163-3 |



F0201-A

F0202-A

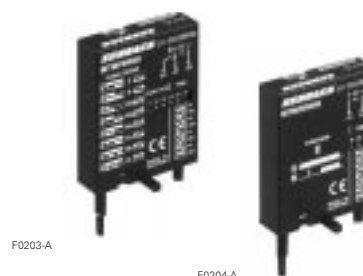

F0203-A

F0204-A

Technical data - Function modules

| | |
|---------------------------|--------------------------|
| Nominal voltage | 24...240 Vdc / Vac |
| Mains frequency | 48...63 Hz |
| Precision of time setting | ± 0,5 % |
| Readiness for repetition | ≤ 0,5 % or 5 ms |
| Influence of temperature | ≤ 0,1 %/°C |
| Time range switchable | 0,05s...240h in 8 ranges |
| Ambient temperature | -25...+55 °C |

Accessories Multimode Relay MT

and similar design: octal / undecal

Dimensions in mm
View on solder pins

| Function modules for MT 78 740, MT 78 745 | |
|---|--|
| Function | |
| Delay ON | |
| Delay OFF | |
| single shot leading edge | |
| single shot trailing edge | |
| Delay ON triggered by signal contact | |
| single shot | |
| flasher starting with pause | |
| flasher starting with pulse | |

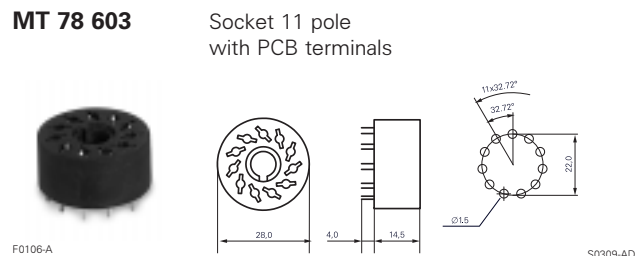
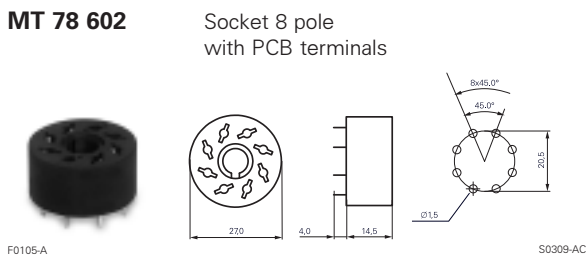
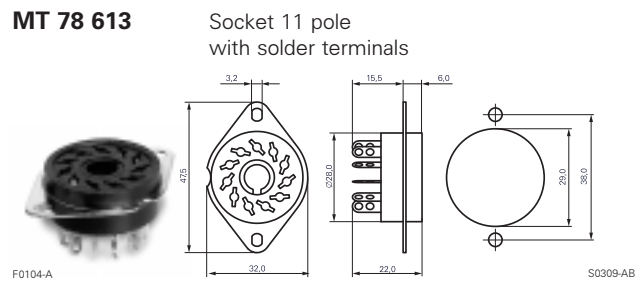
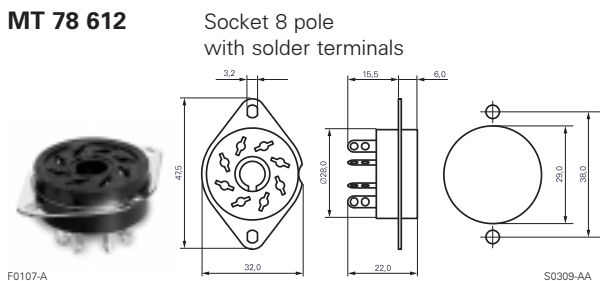

| Sockets with solder and PCB terminals | | Part Number |
|---------------------------------------|--------------------------------------|-------------|
| Type | | |
| MT 78 612 | Socket 8 pole with solder terminals | 7-1415043-1 |
| MT 78 613 | Socket 11 pole with solder terminals | 8-1415043-1 |
| MT 78 602 | Socket 8 pole with PCB terminals | 9-1415043-1 |
| MT 78 603 | Socket 11 pole with PCB terminals | 0-1415044-1 |

| Technical data MT78602...MT78613 | |
|----------------------------------|------------------------|
| Rated current | 10 A |
| Rated voltage | 250 Vac |
| Dielectric strength coil/cont. | >2500 V _{rms} |
| Ambient temperature | -40...+70 °C |
| Packaging unit | 25 pcs |

Accessories Miniature Power Relay PCLH and similar design

Dimensions in mm



F0236-A

PCLH socket with screw-type terminals

TM 78 700 Socket with screw-type terminals

F0129-A

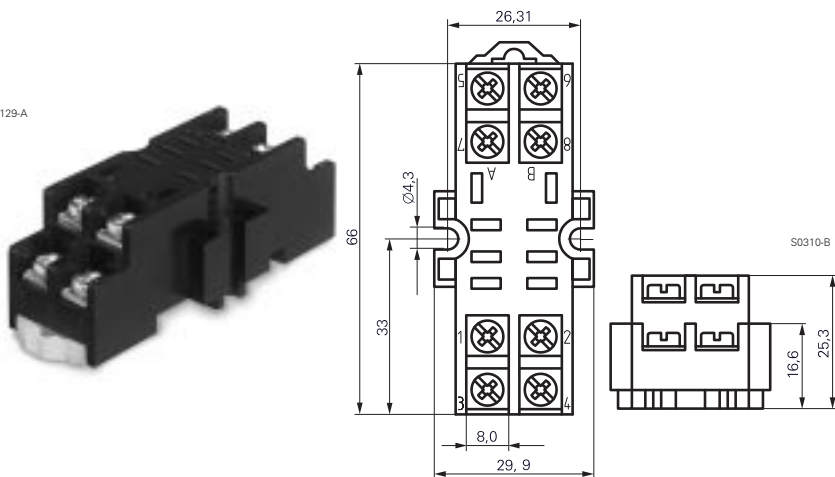

| Technical data | |
|---------------------|----------|
| Rated current | 10 A |
| Rated voltage | 300 Vac |
| Protection category | IP 20 |
| Packaging unit | 100 pcs. |

| Socket with screw-type terminals | | |
|----------------------------------|----------------------------------|-------------|
| Type | | Part Number |
| TM 78 700 | Socket with screw-type terminals | 0-1393164-2 |

| Accessories for TM 78 700 | | |
|---------------------------|-------------------------------|-------------|
| Type | | Part Number |
| TM 28 800 | Metal retaining clip for PCLH | 0-1393164-1 |

Accessories Power Relay RM

2 / 3 pole, 10 / 16 A

Dimensions in mm



F0237-A

RM Sockets with screw-type terminals

RM 78704 Socket with screw-type terminals



F0113-A

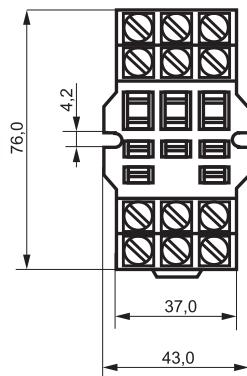

S0317-A

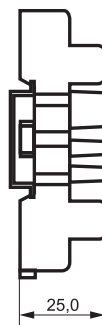

Technical data

| | |
|--------------------------------|------------------------|
| Rated current | 16 A |
| Rated voltage | 380 Vac |
| Dielectric strength coil/cont. | >2500 V _{rms} |
| Ambient temperature | -40...+50 °C |
| Terminal torque | 0.8 Nm |
| max. | 1.2 Nm |
| Packaging unit | 100 pcs. |

RM 78 705 Socket with screw-type terminals



F0114-A

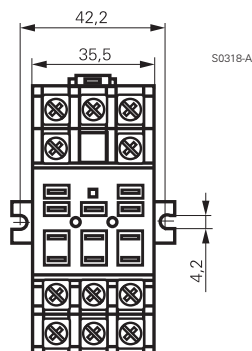

S0318-A

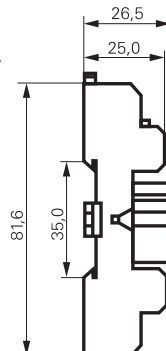

Technical data

| | |
|--------------------------------|------------------------|
| Rated current | 16 A |
| Rated voltage | 250 Vac |
| Dielectric strength coil/cont. | >2500 V _{rms} |
| Ambient temperature | -40...+40 °C |
| Terminal torque | 0.8 Nm |
| max. | 1.2 Nm |
| Packaging unit | 100 pcs. |

Socket with screw-type terminals

| Type | | Part Number |
|------------------|----------------------------------|-------------|
| RM 78 704 | Socket with screw-type terminals | 2-1393844-4 |
| RM 78 705 | Socket with screw-type terminals | 2-1393844-5 |

Accessories Power Relay RM

2 / 3 pole, 10 / 16 A

Dimensions in mm
View on solder pins

RM 78 700 Socket with Faston terminals



F0110-A

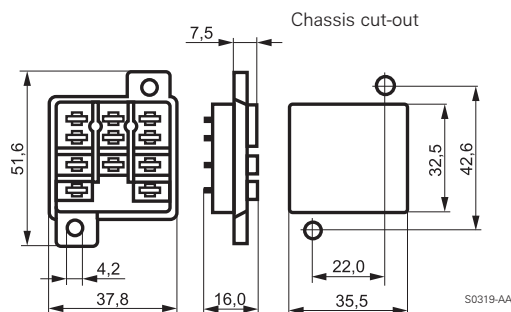

RM 78 701 Socket with solder terminals



F0111-A

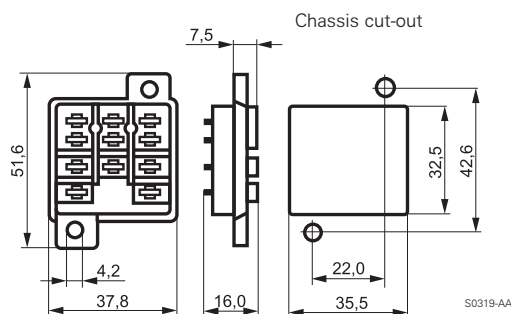

RM 78 702 Socket with PCB terminals

 300 Vac / 10 A



F0112-A

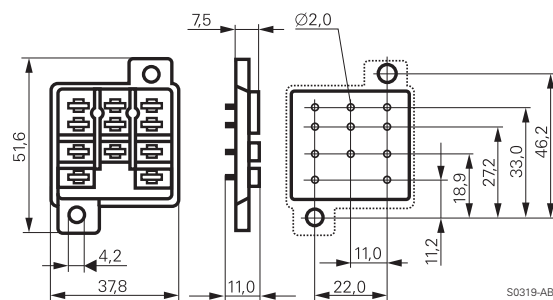

Sockets

| Type | | Part Number |
|------------------|------------------------------|-------------|
| RM 78 700 | Socket with Faston terminals | 0-1419118-6 |
| RM 78 701 | Socket with solder terminals | 4-1393149-9 |
| RM 78 702 | Socket with PCB terminals | 2-1393844-3 |

Accessories for RM 78 700, RM 78 701, RM 78 702

| Type | | Part Number |
|------------------|-------------------------|-------------|
| RM 28 802 | Metal retaining clip RM | 0-1419118-5 |

Relay Package SNR

1 pole 6 A, DC coil



F0252-A

Features

- Relay package consisting of DIN-rail socket, mounting frame and relay and optional LED
- Module width only 5.08 mm
- Reduced system width for increased packing density on the DIN rail



Technical data of approved types on request

Package data

| | |
|-----------------------------------|--------------------------|
| Configuration | 1 C/O contact |
| Rated current | 6 A |
| Nominal voltage | 24...48 Vdc |
| Dielectric strength coil-contacts | 4 kV / 8 mm |
| Module width | 5.08 mm |
| Packaging unit | 10 pcs. |
| Complete relay data see | Slim Interface Relay SNR |
| Data on sockets | see accessories SNR |

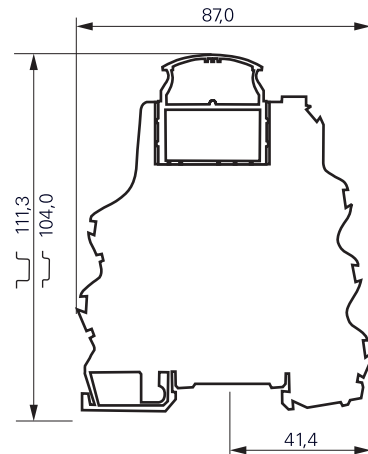

F0404-A

Product key



Type

Version

1P 1 C/O contact, 6 A

Contact material

2 AgSnO₂ gold plated

3 AgSnO₂

Electrical indicator

0 without indicator

L LED

Coil

DC coil code = nominal voltage (e.g. 24=24Vdc)

Other types on request

| Product key | Socket | Mtg. frame | Relay | Coil | Part number |
|-------------|---------|------------|-------------------|--------|-------------|
| ST1P2L24 | ST1FL24 | ST16016 | V23092-A1024-A201 | 24 Vdc | 6-1415025-1 |
| ST1P3024 | ST1F000 | | V23092-A1024-A301 | | 3-1415024-1 |
| ST1P3L12 | ST1FL24 | | V23092-A1012-A301 | 12 Vdc | 2-1415025-1 |
| ST1P3L24 | | | V23092-A1024-A301 | 24 Vdc | 3-1415025-1 |
| ST1P3L48 | | | V23092-A1048-A301 | 48 Vdc | 4-1415025-1 |

Relay Package RT

1 pole 16 A, 2 pole 8 A, DC- or AC coil



F0251-A

Features

- Relay package consisting of RT relay, DIN-rail socket, plastic retaining clip, module and marking tag
- 1 C/O or 1 N/O with 16 A or 2 C/O with 8 A rated load
- Sensitive DC- or AC coil
- Protection class II / VDE 0700, safe separation to VDE 0106



Technical data of approved types on request

Package data

| | | |
|-----------------------------------|--------------------------|-------|
| Configuration | 1 C/O, 1 N/O | 2 C/O |
| Rated current | 16 A | 8 A |
| Nominal voltage | 24 Vdc 24, 230 Vac | |
| Dielectric strength coil-contacts | 4 kV / 8 mm | |
| Module width | 15.5 mm | |
| Packaging unit | 10 pcs. | |
| Complete relay data see | Interface Power Relay RT | |
| Data on sockets | see accessories RT | |

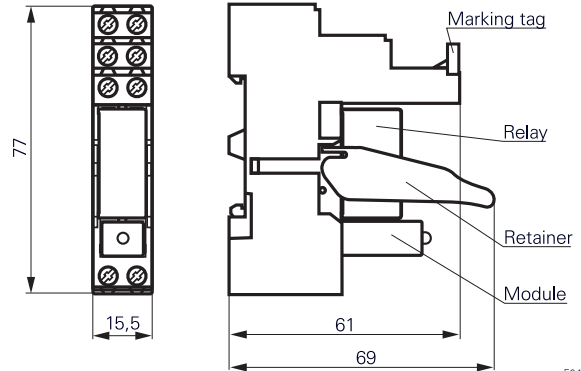

F0430-A

Product key

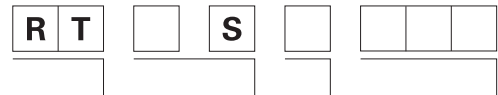

Type

Version

3S Relay set: RT 1-pole C/O or N/O, 16 A, red LED

4S Relay set: RT 2-pole C/O, 8 A, red LED

Contact material

4 AgNi 90/10, C/O contact

K AgNi 90/10 inrush, N/O contact

5 AgNi 90/10 gold plated, C/O contact

L AgSnO₂ inrush, N/O contact

Coil

LC4 24 Vdc

R24 24 Vac

T30 730 Vac

Other types on request

| Product key | Socket | Retainer | Marking tag | Module | Relay | Coil | Part number |
|-------------|---------|----------|-------------|----------|----------|---------|-------------|
| RT3S4LC4 | RT78726 | RT17016 | RT17040 | PTML0024 | RT314024 | 24 Vdc | 4-1415073-1 |
| RT3S4R24 | | | | PTML0524 | RT314524 | 24 Vac | 5-1415073-1 |
| RT3S4T30 | | | | PTML0730 | RT314730 | 230 Vac | 6-1415073-1 |
| RT3S5LC4 | | | | PTML0024 | RT315024 | 24 Vdc | 7-1415073-1 |
| RT3S5R24 | | | | PTML0524 | RT315524 | 24 Vac | 8-1415073-1 |
| RT3S5T30 | | | | PTML0730 | RT315730 | 230 Vac | 9-1415073-1 |
| RT3SKLC4 | | | | PTML0024 | RT33K024 | 24 Vdc | 3-1415074-1 |
| RT3SLLC4 | | | | | RT33L024 | | 4-1415074-1 |
| RT4S4LC4 | | | | | RT424024 | | 1-1415073-1 |
| RT4S4R24 | | | | PTML0524 | RT424524 | 24 Vdc | 2-1415073-1 |
| RT4S4T30 | | | | PTML0730 | RT424730 | 230 Vac | 3-1415073-1 |
| RT4S5LC4 | | | | PTML0024 | RT425024 | 24 Vdc | 0-1415074-1 |
| RT4S5R24 | | | | PTML0524 | RT425524 | 24 Vac | 1-1415074-1 |
| RT4S5T30 | | | | PTML0730 | RT425730 | 230 Vac | 2-1415074-1 |

Relay Package PT

2 pole 12 A, 3 pole 10 A or 4 pole 6 A
DC- or AC coil



F0253-A

Features

- Relay package consisting of PT relay, DIN-rail socket, plastic retaining clip, module and marking tag
- 2, 3 or 4 C/O
- Mechanical and electrical indicator
- Manual test tab, optionally lockable



Technical data of approved types on request

Package data

| | | | |
|-------------------------|---------------------------|-------|-------|
| Configuration | 2 C/O | 3 C/O | 2 C/O |
| Rated current | 12 A | 10 A | 6 A |
| Nominal voltage | 12, 24 Vdc 24, 230 Vac | | |
| Module width | 27.0 mm | | |
| Packaging unit | 5 pcs. | | |
| Complete relay data see | Miniature Relay PT | | |
| Data on sockets | see accessories PT | | |

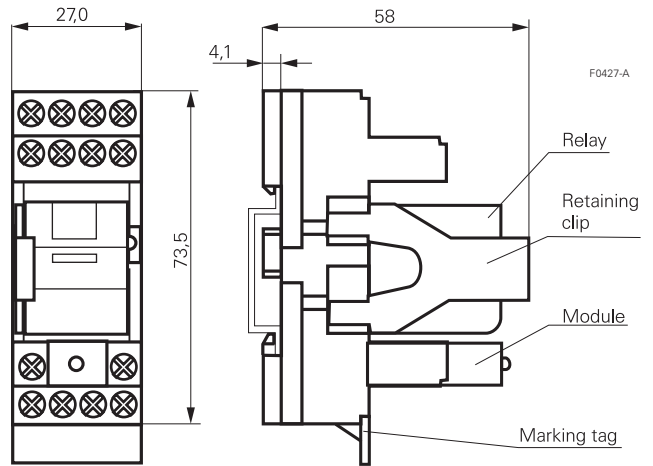

F0427-A

Product key

Type

Contact configuration

- 2S** Relay set: PT 2 C/O contacts, red LED
- 3S** Relay set: PT 3 C/O contacts, red LED
- 5S** Relay set: PT 4 C/O contacts, red LED

Contact material

- 7** AgNi 90/10, with test button
- 8** AgNi 90/10, gold plated, with test button

Coil

- LB2** 12 Vdc
- RC4** 24 Vac
- LC4** 24 Vdc
- TD0** 230 Vac

Other types on request.

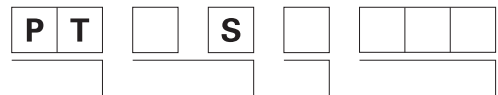

| Product key | Socket | Retainer | Marking tag | Module | Relay | Coil | Part number | |
|-------------|---------|----------|-------------|----------|----------|----------|-------------|-------------|
| PT2S7LB2 | PT78720 | PT17016 | PT17040 | PTML0024 | PT270012 | 12 Vdc | 7-1415074-1 | |
| PT2S7LC4 | | | | | PT270024 | 24 Vdc | 8-1415074-1 | |
| PT2S7RC4 | | | | PT78730 | PTMV0524 | PT270R24 | 24 Vac | 5-1415074-1 |
| PT2S7TD0 | | | | | PTMV0730 | PT270T30 | 230 Vac | 6-1415074-1 |
| PT3S7LB2 | PT78730 | PT17016 | PT17040 | PTML0024 | PT370012 | 12 Vdc | 1-1415075-1 | |
| PT3S7LC4 | | | | | PT370024 | 24 Vdc | 2-1415075-1 | |
| PT3S7RC4 | | | | PT78740 | PTMV0524 | PT370R24 | 24 Vac | 9-1415074-1 |
| PT3S7TD0 | | | | | PTMV0730 | PT370T30 | 230 Vac | 0-1415075-1 |
| PT5S7LB2 | PT78740 | PT17016 | PT17040 | PTML0024 | PT570012 | 12 Vdc | 9-1415075-1 | |
| PT5S7LC4 | | | | | PT570024 | 24 Vdc | 0-1415076-1 | |
| PT5S7RC4 | | | | PT78740 | PTMV0524 | PT570R24 | 24 Vac | 7-1415075-1 |
| PT5S7TD0 | | | | | PTMV0730 | PT570T30 | 230 Vac | 8-1415075-1 |
| PT5S8LB2 | PT78740 | PT17016 | PT17040 | PTML0024 | PT580012 | 12 Vdc | 5-1415075-1 | |
| PT5S8LC4 | | | | | PT580024 | 24 Vdc | 6-1415075-1 | |
| PT5S8RC4 | | | | PT78740 | PTMV0524 | PT580R24 | 24 Vac | 3-1415075-1 |
| PT5S8TD0 | | | | | PTMV0730 | PT580T30 | 230 Vac | 4-1415075-1 |

Thermal Circuit Breaker W28



F0214-A

Features

- Approved to international standards (push to reset type)
- Labor-saving snap-in mounting
- tested to EN 60934



Technical data of approved types on request

Electrical data

| | | |
|------------------------------|--------------------|--|
| Calibration | | will continuously carry 100% of rating |
| | 0.25...2 A models: | may trip at 101...174%, but must trip at 175% of rating within one hour at +25°C |
| | 3...16 A models: | may trip at 101...134%, but must trip at 135% of rating within one hour at +25°C |
| Maximum operating voltage | | 32 Vdc; 250 Vac 50/60 Hz |
| Interrupt capacity | | 1000 A at 250 Vac, 50/60 Hz; 32 Vdc in accordance with UL 1077 |
| Resettable overload capacity | | |
| | 0.25...2 A models: | 6x rated current |
| | 3...16 A models: | 10x rated current |
| Reset time | | |
| | 0.25...2 A models: | max 180 s |
| | 3...16 A models: | 110...60 s |
| Dielectric strength | | 1500 Vrms |

Typical resistance vs. current rating

| Current rating | Typical resistance | Current rating | Typical resistance | Current rating | Typical resistance |
|----------------|--------------------|----------------|--------------------|----------------|--------------------|
| A | Ω | A | Ω | A | Ω |
| 0.25 | 14.0 | 5.0 | 0.030 | 12.0 | 0.009 |
| 0.50 | 3.55 | 6.0 | 0.026 | 13.0 | 0.009 |
| 0.75 | 2.0 | 7.0 | 0.017 | 14.0 | 0.007 |
| 1.0 | 0.89 | 8.0 | 0.016 | 15.0 | 0.007 |
| 2.0 | 0.17 | 9.0 | 0.014 | 16.0 | 0.007 |
| 3.0 | 0.069 | 10.0 | 0.011 | | |
| 4.0 | 0.043 | 11.0 | 0.010 | | |

Data for ambient temperature +25°C

Time vs. current trip curve

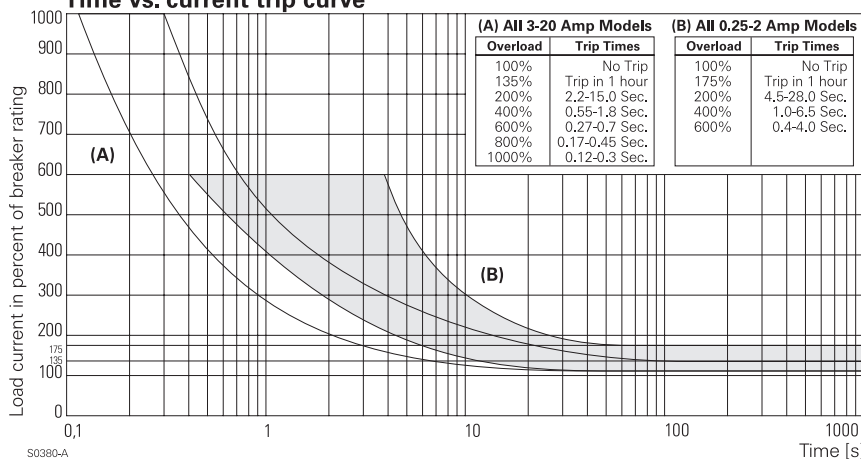

Ambient compensation chart

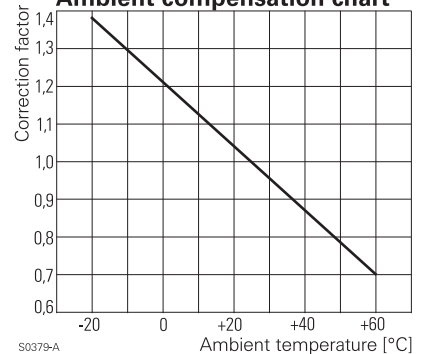

How to use the correction: Multiply the breaker rating by correction factor to determine the compensated rating. Calculate the overloads in terms of the compensated rating to use the published trip curve.

Thermal Circuit Breaker W28

| Other data | |
|---------------------|---|
| Ambient temperature | -20...+60°C |
| Terminals | 6.35mm (.250") quick connects soldering to terminals not recommended |
| Mounting | snaps into panel from front |
| Weight | 10 g |
| Packaging unit | 100 pcs. |

Dimensions

Dimensions in mm

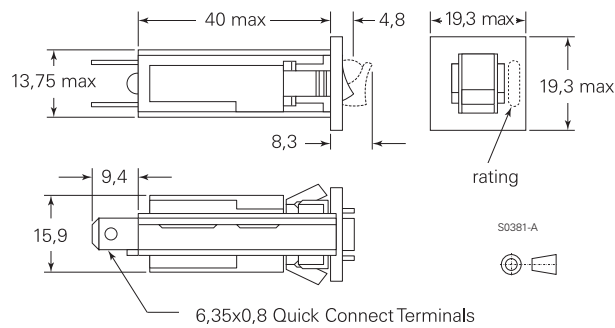

Recommended panel cutouts

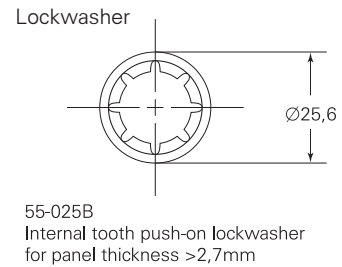
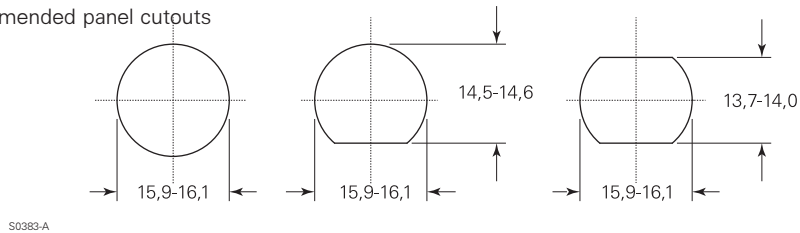

55-025B
Internal tooth push-on lockwasher
for panel thickness >2,7mm

Product key

W 2 8 - **X** **1** **A** -

Type

Circuit function

X series trip, push-to-reset button

Terminal type and mounting

Q 6,35mm Quick Connect for panel thickness 0.8...1.6mm

T 6,35mm Quick Connect for panel thickness 1.9...2.7mm
for panels other than above, order "Q" type and 55-025B internal
tooth push-on lockwasher

Front color

1 black with white rating marking

Button color

A black

Current rating

0.25, 0.50, 0.75, 1, 2, 3, 4, 5, 6, 7, 8, 9,
10, 11, 12, 13, 14, 15, 16

Preferred types in bold print. Other types on request.

Thermal Circuit Breaker W58



F0215-A

Features

- 0.5...25 A ratings
- Cannot be manually tripped
- Push button to reset breaker

 Recognized as supplementary protectors
 Technical data of approved types on request

| Electrical data | |
|------------------------------|--|
| Calibration | will continuously carry 100% of rating may trip at 101...144%, but must trip at 145% of rating at +25°C |
| Maximum operating voltage | 50 Vdc; 250 Vac 50/60Hz |
| Interrupt capacity | 2000 A at 50 Vdc 1000 A at 250 Vac 50/60Hz |
| Resettable overload capacity | 10x rated current |
| Dielectric strength | > 1500 Vrms |

Typical resistance vs. current rating

| Current rating | Max. resistance | Current rating | Max. resistance | Current rating | Max. resistance |
|----------------|-----------------|----------------|-----------------|----------------|-----------------|
| A | Ω | A | Ω | A | Ω |
| 0.5 | 5.0 | 5.0 | 0.026 | 10.0 | 0.014 |
| 1.0 | 1.35 | 6.0 | 0.026 | 12.0 | 0.010 |
| 2.0 | 0.32 | 7.0 | 0.020 | 15.0 | 0.010 |
| 3.0 | 0.18 | 8.0 | 0.020 | 20.0 | 0.006 |
| 4.0 | 0.10 | 9.0 | 0.020 | 25.0 | 0.005 |

Data for ambient temperature +25°C

Time vs. current trip curve

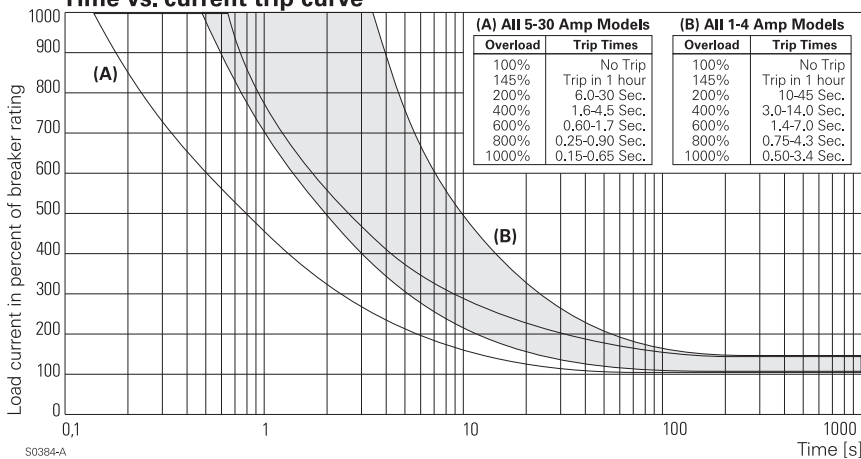

Ambient compensation chart

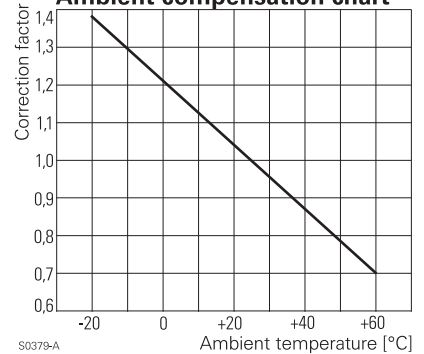

How to use the correction: Multiply the breaker rating by correction factor to determine the compensated rating. Calculate the overloads in terms of the compensated rating to use the published trip curve.

Thermal Circuit Breaker W58

| Other data | |
|----------------------|-------------------------------------|
| Ambient temperature | -20...+60°C |
| Endurance cycling | > 1000 operations at 200% of rating |
| Vibration resistance | 10g at 10...55 Hz |
| Weight | 42 g |
| Packaging unit | 100 pcs. |

Mounting Hardware

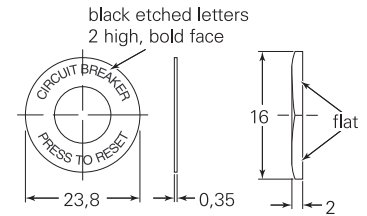

S0386-A

Dimensions

Dimensions in mm

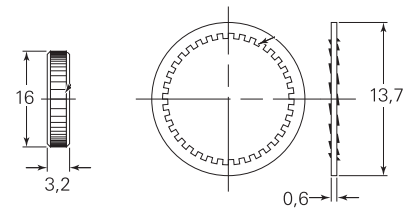
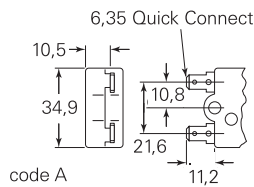
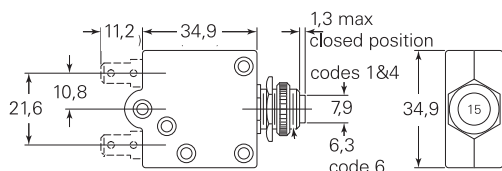

Mounting bushing

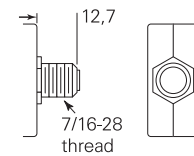
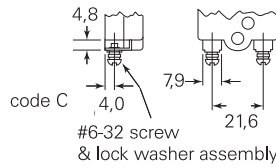
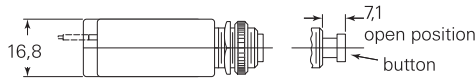

panel cutout

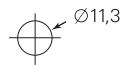

S0387-A

S0385-A



Ordering key

W 5 8 - X B 1 [] [] A - []

Type

Circuit function

X series trip

Button

B white with red rating marking, red trip band

Mounting bushing

1 7/16"x0.5" (12,7mm) long

Terminals

A Quick Connect 6.35mm straight

C 6/32 screw 90° (screws installed)

Mounting hardware

4 knurled nut/hex nut

12 knurled nut/lock washer

Mounting hardware packaging

A assembled to bushing

Current rating in Amps

0.5, 1, 2, 3, 4, 5, 6, 7, 8, 9, 10, 12, 15, 20, 25

Preferred types in bold print. Other types on request

Magnetic Hydraulic Circuit Breaker W6 / W9



F0216-A

Features

- UL, CSA and VDE approved
- Ratings to 50 A
- Heavy duty stud connections
- Several delay curve options
- Trip free operation
- tested to EN 60934



Technical data of approved types on request

Electrical data

| | |
|-----------------------|---|
| Calibration | will hold 100% of rated current may trip at 101...124% of rated load (134% for AC/DC units). must trip at 125% of rated load and above (135% for AC/DC units) |
| Endurance | 10x10 ³ on/off cycles - 6000 at rated load, 4000 without load tested at 6 cycles/min, 1 s on and 9 s off at 25°C |
| Dielectric strength | 50/60 Hz: 1500 Vrms DC: 1100 Vdc |
| Insulation resistance | 100x10 ⁶ Ohm |

Typical resistance and impedance

| Current rating | DC resistance | 50/60 Hz Impedance |
|----------------|---------------|--------------------|
| A | Ω | Ω |
| 0.2 | 90 | 90 |
| 1.0 | 1.2 | 1.2 |
| 2.0 | 0.28 | 0.28 |
| 5.0 | 0.04 | 0.04 |
| 10.0 | 0.013 | 0.013 |
| 20.0 | 0.004 | 0.005 |
| 30.0 | 0.0027 | 0.004 |
| 40.0 | 0.002 | 0.002 |
| 50.0 | 0.0015 | 0.0015 |

Data for ambient temperature +25°C

Approval and ratings

W6 series

| Max Voltage | Frequency | Phase | Current Rating | Interruption Capacity |
|-------------|-----------|-------|----------------|-----------------------|
| V | Hz | | A | A |
| 65 | DC | - | 0.2...50 | 2000 |
| 250 | 50/60 | 1 | 0.2...30 | 5000 |
| 250 | 50/60 | 1 | 31...50 | 2000 |
| 415/240 | 50/60 | 3 | 0.2...30 | 5000 |

Approval and ratings

W9 series

| Max Voltage | Frequency | Phase | Current Rating | Interruption Capacity |
|-------------|-----------|-------|----------------|-----------------------|
| V | Hz | | A | A |
| 65 | DC | - | 0.2...50 | 2000 |
| 250 | 50/60 | 1 | 0.2...30 | 5000 |
| 250 | 50/60 | 1 | 31...50 | 2000 |
| 415/240 | 50/60 | 3 | 0.2...30 | 5000 |

Magnetic Hydraulic Circuit Breaker W6 / W9

Other data

| | | | |
|--------------------------------|--|-------------------------|--|
| Ambient temperature | -40...+85 °C | | |
| Humidity | meets requirements of Mil-STD-202 method 103 | | |
| Fungus and moisture resistance | special moisture resistant finish applied to all ferrous parts, plastic parts are made of inherently fungus resistant material | | |
| Vibration resistance | 1.52 mm, 10...55 Hz, tested to Mil-STD-202, method 201 | | |
| Shock resistance | 100 g, 6 ms, tested to Mil-STD-202, method 213, C | | |
| Marking | W6 units have ON and OFF molded on the rocker ('0','1' for VDE) | | |
| Mounting | screw mount in panels (#6-32 or M3x0.5) to maintain published performance, units should not be mounted more than 45° from their upright position | | |
| Weight | W6: appr. 60 g per pole | W9: appr. 90 g per pole | |
| Packaging unit | W67: 72 pcs. | W91: 55 pcs. | |
| | W68: 36 pcs. | W92: 30 pcs. | |
| | W69: 24 pcs. | W93: 20 pcs. | |
| | W70: 9 pcs. | W94: 9 pcs. | |

Time vs. current trip curves for W6 and W9 series

AC

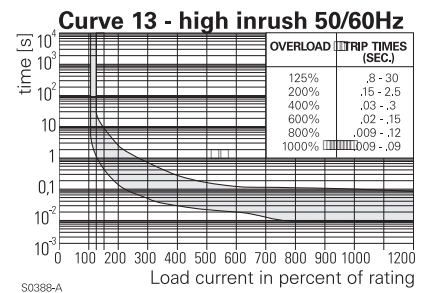
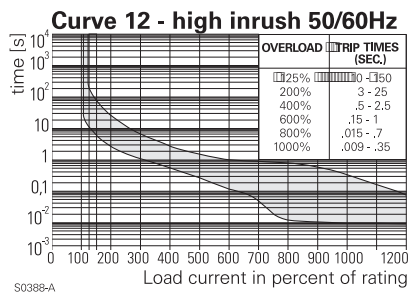
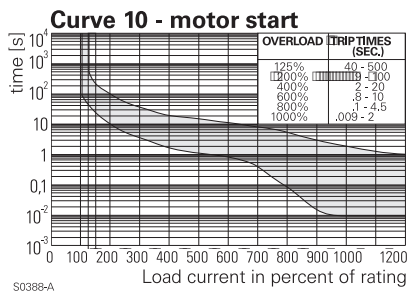
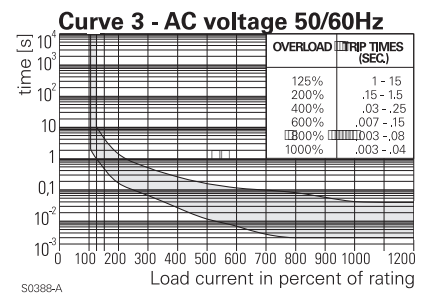
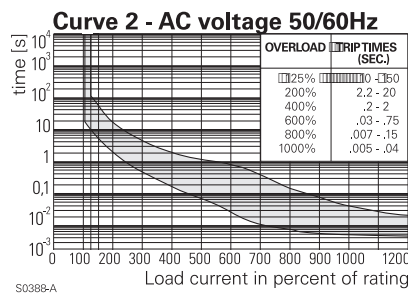
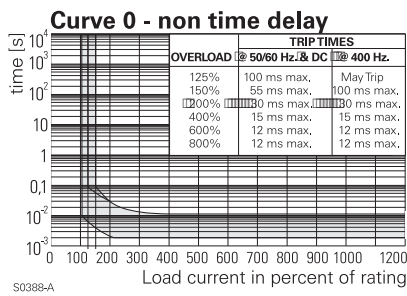

DC; AC/DC

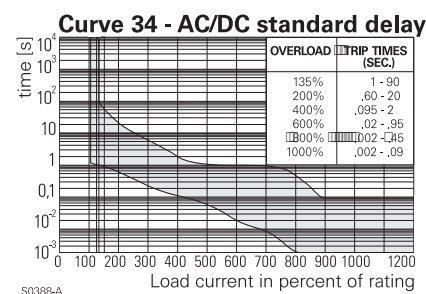
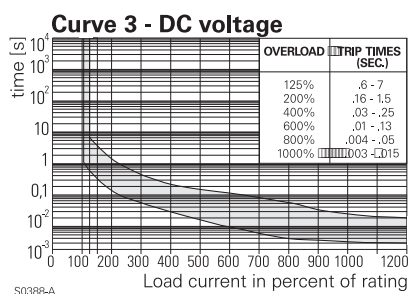
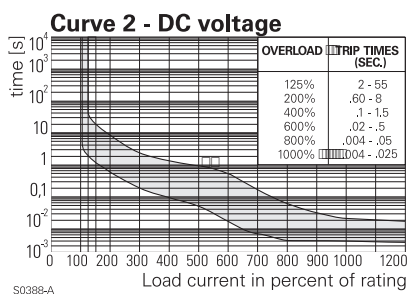

Magnetic Hydraulic Circuit Breaker W6 / W9

Pulse tolerance specifications

| Voltage | Time delay curve | Pulse tolerance value | |
|------------|------------------|-----------------------|---------------|
| | | Standard | Inertia delay |
| AC 50/60Hz | 2 | 7.5 | 18 |
| AC 50/60Hz | 3 | 6 | 18 |
| AC 50/60Hz | 10 | 18 | 30 |
| AC 50/60Hz | 12 | 18 | 30 |
| AC 50/60Hz | 13 | 18 | 30 |

Pulse tolerance is defined as a single pulse of a half sine wave (1/2 cycle or 8ms) that will not trip the breaker. An inertia wheel for increased pulse tolerance is available by specifying 'P' after the time delay curve number in the ordering key. The table at left lists pulse tolerance values of standard and inertia delay models.

To determine pulse tolerance multiply breaker rating by value in table. For example, a 2 A breaker with time delay curve 3 has a standard pulse tolerance of 12 A (2x6 A). The same breaker with an inertia delay has a pulse tolerance of 36 A (2 Ax18).

Dimensions

Dimensions in mm

W6 series

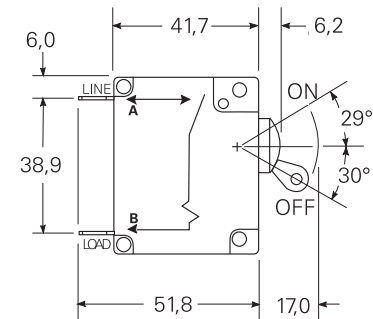

S0389-A

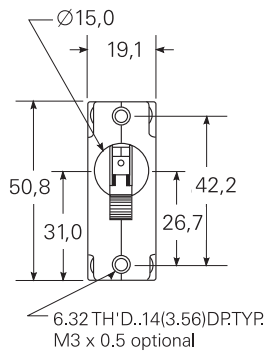

S0390-A

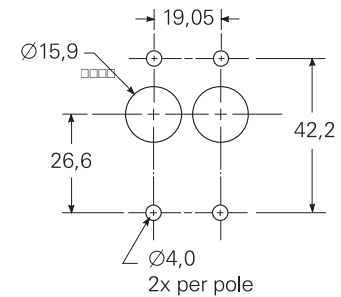

S0394-A

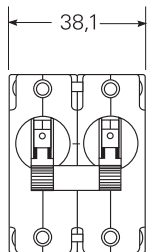

S0391-A

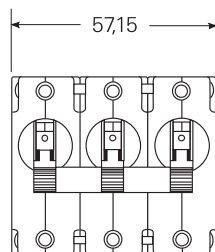

S0392-A

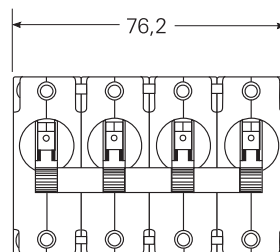

S0393-A

VDE models with screw terminals

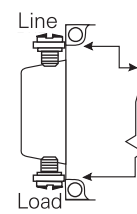

S0395-A

UL/CSA models with screw terminals

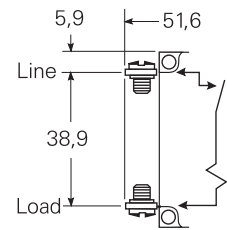

S0396-A

W9 series

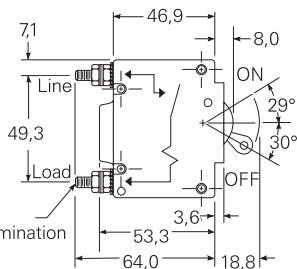

S0397-A

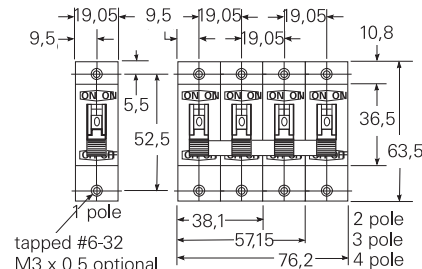

S0398-A

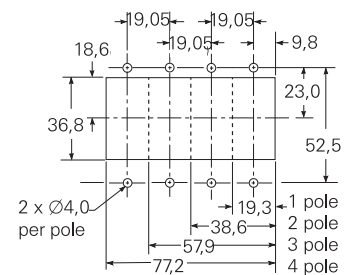

S0399-A

Magnetic Hydraulic Circuit Breaker W6 / W9

Ordering key W6 series

-
X

2

-

Type

- W** #6-32 mounting threads
- M** M3 x 0.5 mounting thread

Number of poles

- 67** 1 pole **68** 2 pole
- 69** 3 pole **70** 4 pole

Circuit function

- X** Series trip

Actuator (per pole)

- 2** white toggle

Terminals

- Q** 6.35mm Quick Connect (DIN 46244) max. 25A for VDE
- S** #8-32 screw

Max voltage

- 1** 250Vac, 415/240Vac **5** 65 Vdc
- 7** 250Vac or 65Vdc (only with delay curve 34)

Time delay curve

- 0** instantaneous **10** AC high inrush (motor start)
- 2** standard delay **12** AC high inrush version #2
- 3** short delay **13** AC high inrush version #3
- 34** combination AC/DC standard delay

Amp Rating

- 0.2, 0.25, 0.5, 0.75, 1, 1.5, 2, 2.5, 3, 3.5, 4, 5, 6, 7, 8, 9, 10, 11, 12, 15, 20, 25, 30, 35, 40, 45, 50**

Approvals

- V** VDE blank UL and CSA without VDE

Other types on request

Ordering key W9 series

9

-
X

1

-

Type

- W** #6-32 mounting threads
- M** M3 x 0.5 mounting thread

Number of poles

- 91** 1 pole **92** 2 pole
- 93** 3 pole **94** 4 pole

Circuit function

- X** Series trip

Actuator (per pole)

- 1** black toggle

Max voltage

- 1** 250Vac, 415/240Vac **5** 65 Vdc
- 7** 250Vac or 65Vdc (only with delay curve 34)

Time delay curve

- 0** instantaneous **10** AC high inrush (motor start)
- 2** standard delay **12** AC high inrush version #2
- 3** short delay **13** AC high inrush version #3
- 34** combination AC/DC standard delay

Amp Rating

- 0.2, 0.25, 0.5, 0.75, 1, 1.5, 2, 2.5, 3, 3.5, 4, 5, 6, 7, 8, 9, 10, 11, 12, 15, 20, 25, 30, 35, 40, 45, 50**

Approvals

- V** VDE blank UL and CSA without VDE

Other types on request

Safety Relays / Definitions

Relays with forcibly guided contacts

General information

Relays with forced guidance contacts play a decisive role in avoiding accidents on machines and in systems. Safety control circuits enable to switch into the fail safe state. Forcibly guided contacts monitor the function of the safety control circuits. For this safety function, all the assumed faults that can occur must already have been taken into consideration and their effects examined. Standard EN 50205 "Relays with forcibly guided contacts" contains current internationally-defined design requirements. Relays with forcibly guided contacts that comply with EN 50205 are also referred as "safety" relays.

Function

Power relays with forcibly guided (linked) contacts: Power relays with at least one break contact and at least one make contact designed that by mechanical means make and break contacts can never be simultaneously in the closed position.

Contact gaps shall never be less than 0.5 mm over the operating life, not only under normal operating conditions, but also when a fault occurs.

This requirement allows the respective exclusive-or contact to detect the fault of a contact to open. For example, the welding of a make contact is indicated by the non-closing of the break contact when the energization is switched off.

To fulfill the specifications of the standard, the assumed faults must be considered:

| Assumed fault | Effect |
|--|---|
| Failure of the contact to open due to welding | The failure of any make contact to open has the effect that none of the break contacts close even when the relay is not energized. The failure of any break contact to open has the effect that none of the make contacts close when the relay is energized. |
| Failure of the contact to open due to failure of the drive | The drive has no effect on the forcibly guided contact operation. |
| Breakage of the contact spring | Simultaneous closing of the break and make contacts is not possible even as a result of breakage. Completely insulated contact chambers (SR2, SR4, SR6) or barriers (SR2M) guarantee a contact gap of 0.5 mm. |

Safety Relays / Definitions

Application example

The configuration of safety control circuits is basically only possible with specified fault conditions. Safety relays have the characteristic that make and break contacts can never both be closed at the same time.

The following circuit diagram shows an emergency stop control circuit consisting of three 4-pole safety relays.

The first fault to occur

- does not cause the safety function to fail because more components are used than required for the circuit to function (redundancy).
- prevents an restart and can be detected as a result (self monitoring)

Operation

- Closing the "ON" switch causes the K1 relay to be pulled in

- The K2 and K3 relays are energized via the make contacts K1-1 and K1-2 and hold themselves via K2-2 or K3-2
- The break contacts K2-1 and K3-1 cause the drop-out of K1 where the load circuit is released via the break contacts of K1-3 or K1-4.

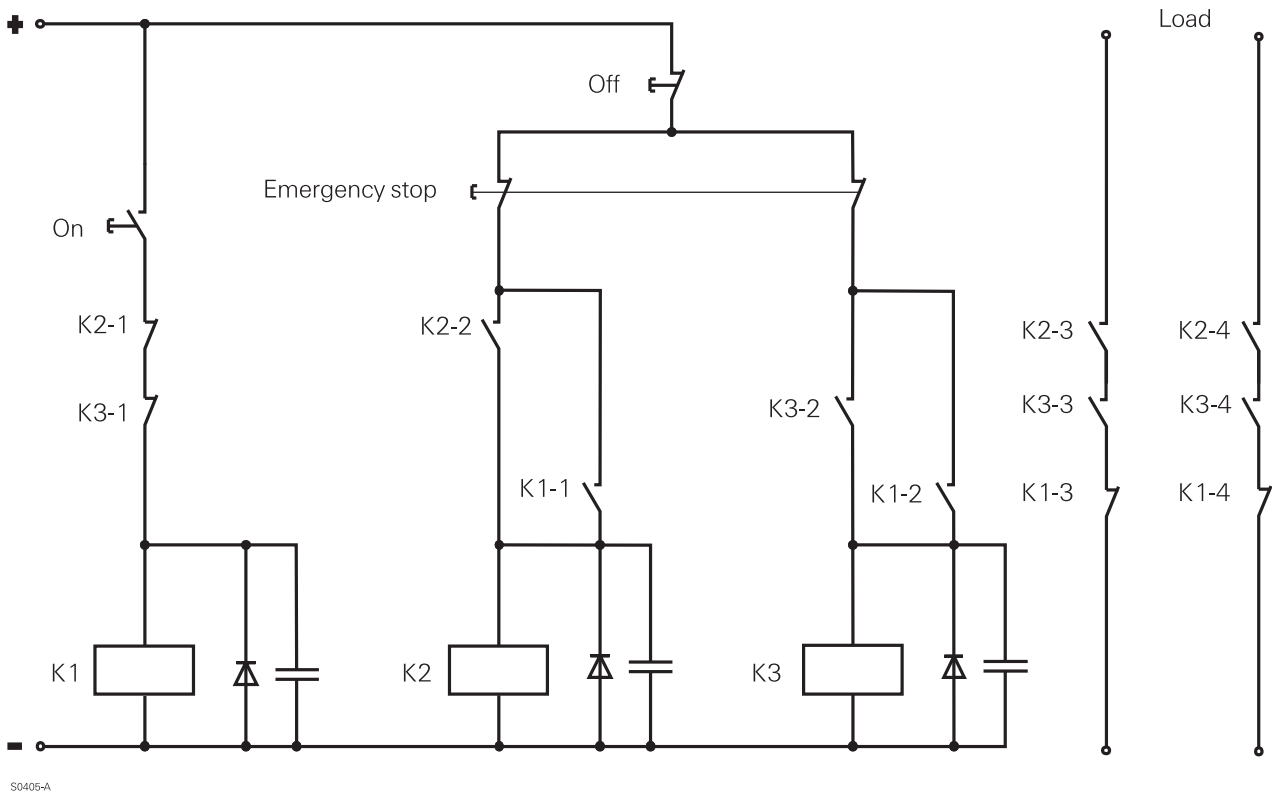

Fault analysis (examples):

| Type of fault | Is there any danger arising from the fault? | Is a restart possible? |
|---------------------------------|---|---|
| Failure of contact K2-3 to open | No, K3-3 opens when the emergency stop switch is actuated | No, K2-1 and K2-3 cannot be closed at the same time (fault excluded by forcibly guided). "ON" button does not cause K1 to close |
| Failure of contact K1-3 to open | No, K2-3 and K3-3 open when the emergency stop switch is actuated | No, K1-1 and K1-2 cannot close due to closed K1-3. K2 and K3 are not energized |

Definitions

AC-coil

Relays for direct energization with AC supply. The data is given for a 50 Hz supply.

Unless otherwise stated, the AC-coils may be used with 50 and 60 Hz supply. For 60 Hz data please contact our application support.

Ambient temperature

The temperature in the vicinity of the relay. The minimum ambient temperature is the minimum operating temperature, the maximum ambient temperature is the maximum operating temperature for the use of the relay. This temperature should not be exceeded. Ambient temperature range according to IEC 61810-1.

Approvals

The approvals confirm that the relay corresponds to the respective regulation for electrical components and equipment. The approvals are quoted for the respective relay types. However, they do not always refer to the entire spectrum of types of a relay.

| | | |
|---|---------|---|
|  | BEAB | British Electrotechnical Approvals Board, England |
|  | CECCE | VDE-Prüfstelle Offenbach als nationale Überwachungsstelle, Deutschland |
|  | CSA | Canadian Standards Association, Kanada |
|  | DEMKO | Danmarks Elektriske Materielkontrol, Danmark |
|  | KEMA | Naamloze Venootschap tot Keuring van Electrotechnische Materialen, Niederlande |
|  | LLOYD's | Lloyd's Register of Shipping |
|  | NEMKO | Norges Elektriske Materielkontroll, Norwegen |
|  | ÖVE | Österreichischer Verband für Elektrotechnik, Österreich |
|  | SEMKO | Svenska Elektriska Materielkontrollanstalten AB, Schweden |
|  | SETI | Sähköarkastuskeskus Elinspektionscentralen, Finnland |
|  | SEV | Eidgenössisches Starkstrominspektorat, Schweiz |
|  | TÜV | Technischer Überwachungs-Verein, Deutschland |
|  | UL | Underwriters Laboratories, Inc., USA; UL Component Recognition Mark for the United States |
|  | UL | UL Component Recognition Mark for Canada |
|  | UL | UL Component Recognition Mark for the United States and Canada |
|  | VDE | VDE-Prüfstelle, Deutschland (Gutachten mit Fertigungsüberwachung) |

Bistable relay, switching characteristics

In a bistable relay, the contacts remain in the last switching position after the input voltage is disconnected.

Bistable, polarized relay

A polarized bistable relay adopts one switching position on energizing in a particular direction and the other switching

position when the energizing is in the opposite direction. In a bistable relay with one winding, the opposite energizing is created by a voltage with opposite polarity being applied to the same winding.

In a bistable relay with two windings, the opposing energizing is created by a voltage being applied to the second winding with opposite winding sense.

Bistable, remanent relay (remanence relay)

A remanent, bistable relay adopts a particular switching position at an energizing direct current in any direction and is held in this position by the remanence in the magnetic circuit, i.e. through the magnetization of parts of the magnetic circuit. The contacts shift to the other switching position on a small energizing current of limited amplitude in the opposite direction. This demagnetizes the magnetic circuit.

Bounce

An unintentional phenomenon that can occur during the making or breaking of a contact circuit when the contact elements touch successively and separate again before they have reached their final position.

Bounce time

The time (typ.) from the first to the last closing or opening of a relay contact. The indicated times are for energization with nominal voltage (without any components in series or parallel to the coil) and at reference temperature.

Break contact

A contact that is closed in the rest state of the relay and open in the operating state.

Bridging contact

Compound contact with two simultaneously operating make contacts connected in series.

Category of protection (IEC61810)

The 'Relay Technology Categories' describe the degree of sealing of the relay case or its contact unit:

| | |
|---------|--|
| RT 0: | unenclosed relay Relay not provided with a protective case |
| RT I: | dust protected relay Relay provided with a case which protects its mechanism from dust |
| RT II: | flux proof relay Relay capable of being automatically soldered without allowing the migration of solder fluxes beyond the intended areas. These are the contacts, movable parts of the magnetic system and their immediate environment. |
| RT III: | wash tight (washable) relay Relay capable of being automatically soldered and subsequently undergoing a washing process to remove flux residues without allowing the ingress of flux or washing solvents. The test to evaluate the sealing of the case for wash tight relays and is performed according to the IEC 68-2-17, Qc test. |

NOTE - In service this type of relay is sometimes vented to the atmosphere after soldering or washing process; in this case the requirements with respect to clearances and creepage distances can change.

| | |
|--------|---------------------------|
| RT IV: | sealed relay |
| RT V: | hermetically sealed relay |

Definitions

Changeover contact

Compound contact consisting of a make contact and a break contact with a common terminal. On changing the switch position, the contact previously closed opens first followed by the closing of the contact that was previously open.

Clearance distance

Shortest distance in air between two conductive elements.

Coil operating range

Permissible range for the energizing voltage as function of the ambient temperature. The operating range is defined by the maximum voltage and the operate-/minimal voltage U_{min} (coil without preenergization) and/or the operate-/minimal voltage U_1 (preenergized coil).

Coil operating range for monostable relays with DC- or AC-coil:

- curve 1: operate-/minimal voltage U_0 (without preenergization)
- curve 2: operate-/minimal voltage U_1 (preenergized coil)
- curve 3: maximum voltage U_2 at contact current = 0A
- curve 4: maximum voltage U_2 at rated contact load I_{nom}

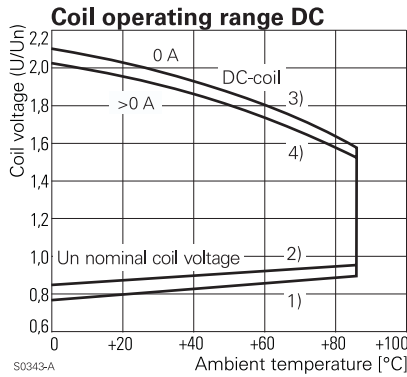

Coil operation range for bistable relays (remanence version)

- curve 1: operate voltage at coil temperature equal to ambient temperature (no preenergization or pulsed operation)
- curve 2: minimum reset/demagnetization voltage
- curve 3: maximum reset/demagnetization voltage at full contact load
- curve 4: maximum voltage at full contact load
- curve 5: maximum voltage at full contact load and pulsed operation (duty cycles)

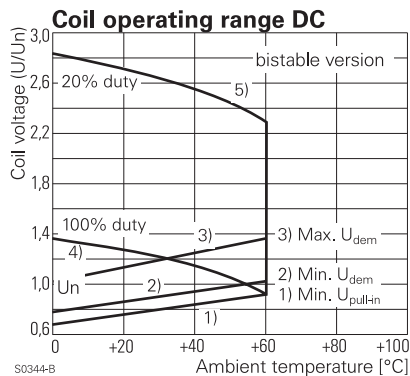

Coil resistance

Electrical resistance of the relay coil at reference temperature.

Contact configuration

According to the different switching functions of the relay contacts the various contact configurations, design and description are specified in DIN 41020. See:

- make contact (N/O)
- break contact (N/C)
- changeover contact (C/O)

| Contact | Reference | | | Circuit diagr. |
|-------------------------------|-----------|----|---------|----------------|
| | D | GB | USA | |
| N/O contact make cont. | 1 | A | SPST-NO | |
| N/C contact break cont. | 2 | B | SPST-NC | |
| C/O contact changeover c. | 21 | C | SPDT | |
| Bridging N/O | 1 | X | SPST-NO | |
| Bridging N/O/ Bridging N/C | | X | DM-DB | |

Contact material

The list gives an overview of the most important plating- and contact materials. The switching capacity of the contacts and the respective electrical endurance depends not only on the contact material but also to a high degree on the relay design. Decisive for the application therefore is the optimal combination of the mechanical system and the contact material. The characteristics for certain relay types cannot be transferred to other designs.

1) Plating materials:

Fine gold

- best corrosion resistance, not used as solid material because too soft, high tendency towards cold-welding
- gold platings $\leq 1 \mu\text{m}$ (hv), only as storage protection, no protection against aggressive atmosphere.

Hard gold / gold plated (htv)

- very good corrosion resistance, low and stable contact resistance at lowest loads, low tendency to cold welding
- dry-circuit switching (switching without current/voltage), recommended range of application 1 V...60 V, 1 mA...100 mA

Definitions

2) Contact materials:

Fine-grain silver AgNi0,15 / AgNi0.15 gold flashed

- relatively low contact resistance, low resistance against aggressive atmosphere
- universally applicable in medium and low load range, especially in DC-circuits, $\geq 12\text{ V}$, 10 mA

Silver-Nickel AgNi90/10

- high resistance against electrical wear, low welding tendency, higher contact resistance than AgNi0,15
- circuits with medium to high loads, DC- and AC-circuits, range of application $\geq 12\text{ V}$, 10 mA

Silver-Cadmium-Oxide AgCdO

- low welding tendency, high wear resistivity
- particularly suited for switching of inductive loads, AC-circuits, $\geq 12\text{ V}$, 100 mA

Silver-Tin-Oxide AgSnO₂

- low welding tendency, very high wear resistivity with heavy loads, low material transfer
- circuits with high requirements to make- and break currents, DC- and AC loads, $\geq 12\text{ V}$, 100 mA

Tungsten W

- highest melting point, high wear resistivity, for high switching rates and low ON-time
- as pre-contact in circuits with highest make- and break loads, $\geq 60\text{ V}$, 1 A

Contact resistance

Electrical resistance between the relay terminals of a closed contact, measured with indicated measuring current and voltage. The specified contact resistance is reached reliably only above a particular load. Considerably increased contact resistances can occur with smaller loads.

According to IEC 61810-7 the following measurement parameters based on the actual switching load are applied:

Contact type

See
- single contact

| Category | Load | | Measurement | |
|----------|-----------|------------|-------------|------|
| | V | A | V | A |
| cat. 0 | 0.03 | 0.01 | 0.03 | 0.01 |
| cat. 1 | 0.03...60 | 0.01...0.1 | 0.1 | 0.01 |
| cat. 2 | 5...250 | 0.1...1 | 24 | 0.1 |
| cat. 3 | 5...600 | 0.1...100 | 24 | 1.0 |

- twin contact
- bridging contact
- forcibly guided contacts

Creepage distance

Shortest distance on the surface of an insulating material between two conductive elements.

C/O contact

See > changeover contact

Dielectric strength / dielectric test voltage

Voltage (rms value in AC voltage, 50Hz 1min) the insulation can withstand between relay elements that are insulated from one another.

Dust-proof relay

Relay with a case to protect against dust penetration.

Duty cycle

Ratio of the duration of energization to the total period of intermittent duty.

Drawings, Dimensions

Unless otherwise stated (see symbol below) technical drawings for product dimensions are using ISO Method E projection (European projection) according to ISO / R 128.

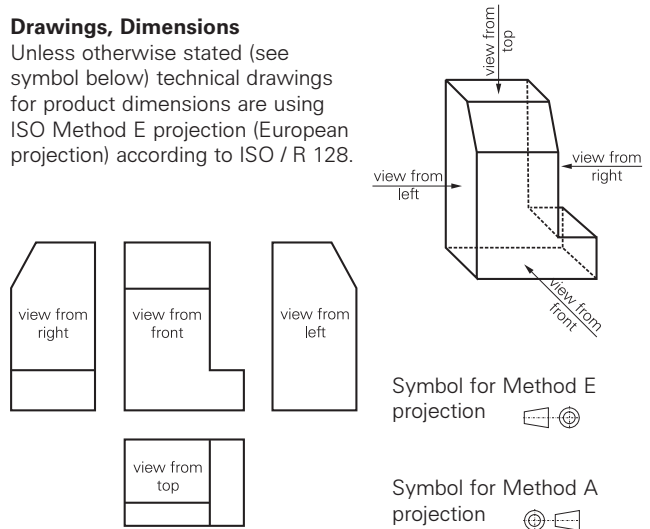

Electrical endurance/contact endurance/electrical life

Number of switching operations of a relay with electrical contact load defined under specified conditions without contact fault. The reference values specified for the endurance apply, unless otherwise specified, to a resistive load. The electrical endurance is reduced with an inductive ac load as a function of the power factor $\cos\phi$ (ϕ is the phase angle between the voltage and current. See reduction factor diagram).

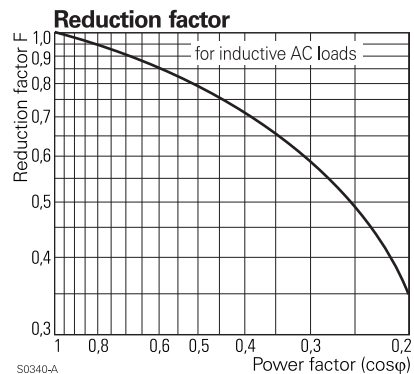

Electrical life

See > Electrical endurance

Definitions

Flammability according to UL

Data of the flammability class according to the UL 94 (Underwriters Laboratories, Inc., USA) specification. This test for technical plastic is widespread. According to the burning characteristics 4 incendiary classes are classified: UL 94 HB, V-2, V-1, V-0.

flux proof/suitable for processing on soldering lines

See 'Category of protection (IEC 61810) - RT II
Relays for processing on soldering lines; a suitable sealing of the relay on the printed circuit board side prevents any flux entering the case.

Forcibly guided contacts

Contact configuration in which break and make contacts within the complete spring set are never closed at the same time even in case of malfunction as a result of contact welding. These relays are implemented in the control of safety technology for the protection against damage to persons or objects.

Immersion cleanable / wash tight

See 'Category of protection (IEC 61810) - RT III
Relays that can be cleaned, lacquered or cast-in together with the printed circuit board after soldering. The washing requires a suitable solvent.
The term "immersion cleanable / wash tight" is not identical with "hermetically sealed"!

Insulation according to IEC 60 664

Data for insulation co-ordination on:
- rated voltage (the voltage value above which the creepage distance is measured)
- pollution degree (classification of the pollution from external materials that affect the insulation)
- overvoltage category (classification of electrical equipment (here: relays) to the overvoltage to be expected)

Insulation according to VDE0110b (2/79)

Data for insulation co-ordination on:
- insulation category (classification of equipment according to environment and utilization conditions)
- reference voltage

Insulation resistance

Electrical resistance (initial condition) measured by applying a DC voltage of 500 V between two elements of a relay that are insulated from one another.

Limiting continuous current / continuous thermal load

The highest value of the current (effective value for alternating current) that the previously closed output circuit can permanently carry under specified conditions.

Make contact

A contact that is open in the rest state and closed in the operating state.

Make current / max. make current

The current a relay can switch on closing contacts under specified conditions. Unless otherwise stated the data refers to the current for a duration of max. 4s with a duty cycle of 10%.

Max. DC load breaking capacity / Load limit curve

Switching of loads at switching voltage and switching current below the load limit curve can be switched off reliably, i.e. the arc is extinguished (max. arc duration 10 ms at resistive load). The load limit curve is affected in both position and shape by the contact materials and relay construction (contact distance, break speed of the contacts, etc.). No statement on the electrical endurance is connected with these curves.

Maximum breaking voltage DC / AC

Maximum voltage that may occur between the switching contacts before closing or after opening the contact. (DC refers to direct current; AC refers to alternating current)
Data given for AC refer to a grounded 3-phase supply with 230 / 400 Vac.

Maximum voltage U_2 (coil).

The highest permissible input voltage at the reference temperature at which the relay, with continuous energization, heats up to its max. permissible coil temperature.

Mechanical endurance

Number of switching operations without contact load during which the relay remains within the specified characteristics.

Minimum switching power

Product of the switching current and switching voltage for reliable switching. Low contact resistance is reached reliably only above a particular load. Considerably increased contact resistances can occur with smaller loads.

Monostable relays, switching characteristics

A relay is called monostable when its contacts return automatically to the rest position after the input voltage is disconnected.

Monostable, neutral relay, non-polarized relay

A neutral, monostable relay operates independently of the direction of the energizing direct current.

Monostable, polarized relay

A polarized, monostable relay only operates in a specific direction of energization. It then adopts the operating state.

Mounting position

Normally the relay can be mounted in any position if no restricting specifications are given.

Nominal power

Power consumption of the coil at nominal voltage and nominal coil resistance.

Nominal voltage (coil), Rated coil voltage

Nominal voltage at which the relay displays the operating characteristics.

Non-release voltage

The value of the input voltage at which a monostable relay does not release.

N/C contact

See > break contact

N/O contact

See > make contact

Definitions

Operate

Process in which a relay shifts from the rest state to the operating state.

Operate category

According to IEC 61810.

Operate power

Coil power at which the relay operates.

Operate time

The time interval that elapses from energizing a relay in the rest state with the nominal voltage (pulse or square signal) to the moment when the last output circuit is closed or opened (bounce time not included).

Operate voltage/Minimum voltage U_1 , preenergized

The lowest permissible input voltage at which the relay operates reliably at the reference temperature even after continuous energization (preenergizing) and brief de-energizing.

Operate voltage / Minimum voltage U_0 , without preenergizing

Minimum permissible voltage at the winding at which the relay operates, for a coil temperature of the reference temperature (20°C coil temperature without preenergizing).

Operation

Single activation and release of a relay.

Packaging unit

Minimum delivery quantity (e.g. plastic bar) and quantity per box.

Plug-in relays

Relays that are held in the socket by flat plug-in terminals (round pins for MT) where electrical contact is established simultaneously.

Print relays

Relays designed for soldering into printed circuits.

Protection category / sealing

For definition of relay protection see 'Category of protection (IEC 61810) - Relay Technology Categories

Rated coil voltage

Nominal voltage at which the relay displays the operating characteristics.

Rated current (contacts)

Current a relay can switch on and off under specified conditions.

Rated voltage (contacts)

Voltage between the switching contacts before closing or after opening of the contact. (DC refers to direct current; AC refers to alternating current)

Rated voltage (insulation)

The reference voltage for the measurement of the creepage distance according to IEC 60 664-1 and VDE0110b.

Relay cycles (dynamic response)

Due to the self induction of the coil and the inertia of the parts to be moved, on activating a relay the operations do not take place suddenly. The function diagram below shows the different cycles for the most important relay configurations of undelayed power relays. The cycles specified apply to energizing with nominal voltage (without any components in series or parallel to the coil) and at the reference temperature.

- operate time
- release time/reset time
- bounce time
- transit time
- minimum energization time

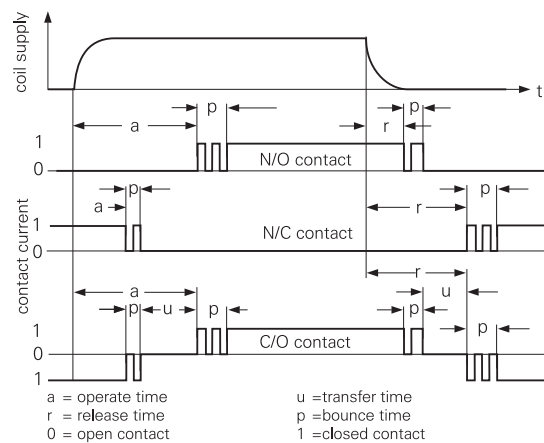

Relay Technology Categories

The 'Relay Technology Categories' describe the degree of sealing of the relay case or its contact unit. See 'Categories of protection'

Release

Process in which a monostable relay shifts from the operating state back to the rest state.

Release time

The time interval (typ.) that elapses from the point of time at which a monostable relay in the operating state has the nominal voltage disconnected to the point of time at which the last output circuit has closed or opened (not including the bounce time). The indicated times are valid for energization with nominal voltage (without any components in series or parallel to the coil) and at reference temperature.

Release voltage

The input voltage at which a monostable relay returns to the rest state at the reference temperature.

Reset

Process in which a bistable relay returns from the operating state back to the rest state.

Definitions

Reset time

The time interval (typ.) that elapses from the point of time at which a bistable relay in the operating state has the nominal voltage applied in the opposite direction to the point of time at which the last output circuit has closed or opened (not including the bounce time).

Reset voltage

The lowest input voltage at which a bistable relay shifts from the operating state into the rest state at the reference temperature.

Rest state

Switch position of a monostable relay in the unenergized state. In bistable relays this is the switch position specified by the manufacturer. The contact position is not defined at delivery.

Safety relays

The compliance with regulations for the safety of persons and material is imperative in our technical world. National and international regulations take various risks into account. These safety standards also make demands on components which share with their function the safety level of a plant, machine or the equipment. For safety relays the demand for forcibly guided contact system according ZH1/457, issued by the professional association applies; the contacts have to be linked mechanically in a way, that N/O and N/C contacts may not be closed at the same time. It has to be ensured that over the entire life and even in case of malfunction (e.g. contact welding) the contact gap will be at least 0.5mm. If specified they also comply with the wider requirements according to prEN 50205 "relays with forcibly guided contacts"

Shock resistance (destruction)

This test is used to evaluate the resistance of the relay to mechanical shocks such as those that could occur in transport or during operation (no permanent damage to the relay). This test is performed according to the IEC 68-2-27, Ea test.

Shock resistance (function)

This test is used to evaluate the resistance of the relay to mechanical shocks such as those that could occur in transport or during operation (no opening of closed relay contacts or closing of open relay contacts with a duration $>10 \mu\text{s}$ is allowed to occur during the test). This test is performed according to the IEC 68-2-27, Ea test.

Single contact

Contact system with one contact piece per contact spring.

Surge voltage / test surge voltage

Amplitude of a voltage impulse of short duration with a specified impulse form and polarity that is applied to test insulation paths in the relay.

Switching current

Current a relay can switch on and off under specified conditions.

Switching power

Product of the switching current and switching voltage (in W for direct current, in VA for alternating current).

Switching rate

Number of operations per unit of time.

Switching voltage

Voltage between the switching contacts before closing or after opening of the contact. (DC refers to direct current; AC refers to alternating current)

Tracking resistance

Evaluation of insulating materials by determining their creepage distance formation, specified by the so-called comparative number of creepage formation (CTI) according to IEC 112.

Twin contact

A compound contact consisting of two simultaneously operating make contacts with a common contact spring. Twin contacts increase the contact reliability considerably, especially when switching low currents and voltages (dry circuits).

Vibration resistance (function)

This test is used to evaluate the resistance of the relay to harmonic mechanical oscillations such as those that could occur in transport or during operation (no opening of closed relay contacts or closing of open relay contacts with a duration $>10 \mu\text{s}$ is allowed to occur during the test). This test is performed according to the IEC 68-2-6, Fc test.

Processing

Mounting

Unless otherwise stated the relay can be mounted in any position. The relays can be further processed in all of the usual commercial soldering and cleaning plants.

Insertion

No pressure should be exerted on the terminal pins after the relay has been inserted in the printed circuit board. After insertion in the printed circuit board, the terminal pins should not be bent in order to fix them. Bending the terminal pins in relays sealed against washing can damage the sealing and could alter the relay parameters. However, if fixing must be carried out before soldering, use a pressure plate or similar.

Fluxing

The fluxing process should be set up so that the flux wets only the underside of the printed circuit board. The flux should only be visible as foam flux through any open perforations in the printed circuit board. If the printed circuit board is flooded by foam flux, bursting flux bubbles can lead to contamination in open relays and, consequently, to failures. To protect against corrosion, no acidiferous flux should be used. The recommended flux types are 1.1.3, 1.2.3 or 2.2.3 according to DIN EN 29454 T.1.

Preheating

In the normal preheating of flux, the temperature of the upper surface of the printed circuit board should not exceed 100°C. Ensure that any not completely dry flux exploding on being submerged in the solder wave does not penetrate the insides of open relays.

Soldering

PIN version

The relays in the PIN version are soldered according to the S-Sn60Pb40 or S-Sn63Pb37 solder types in accordance with DIN EN 29453. The solder bath temperature should be max. 260°C with a solder duration of approx. 3 s.

SMD version

The soldering processes approved for relays of the SMD version are condensation soldering (vapour phase), infrared soldering (radiation and/or convection) and full wave soldering.

| Approved Soldering Techniques | Max. sold. duration | Max. sold. temp. |
|---------------------------------------|---------------------|------------------|
| Condensation soldering (vapour phase) | 40 s | 215°C |
| Infrared soldering | 40 s | 215°C |
| Full wave soldering | 10 s | 260°C |

Refer to the recommendations of CECC 00802 for the complete soldering profile.

Manual soldering

For manual soldering, we recommend a soldering temperature of 300 to 350 °C for a maximum soldering time of 2 s. The recommended solder type is pipe solder 1 DIN 8516-LSnPb zh/F-SW 32 to 34 (1 mm , 2.5 percentage by weight flux portion).

Cooling

The thermal loading resulting from the soldering process can be reduced at the end of the process by cooling.

Cleaning

We recommend avoiding washing processes in order to protect the environment. The fluxes we specify render a wash process unnecessary. If cleaning is required for other reasons, the following points must be observed independently of the washing process:

- the printed circuit boards must be washed immediately after the soldering process!
- the washing process must be set up so that any accumulation of washing fluid inside the relay is avoided!
- the individual wash stations must be separate from one another to prevent cross-contamination!
- after the final washing process, the printed circuit boards must be cleaned again using a clean washing medium!
- After washing, compressed air should be used to blow off the printed circuit board to speed up the drying process.

Protective lacquering

For the protective lacquering of the mounted printed circuit boards, we recommend single-component lacquer that is applied by immersion.

The maximum drying temperature should be 70 °C.

Part number reference list

| Part No | Relay | Product key | Page | Part No | Relay | Product key | Page | Part No | Relay | Product key | Page |
|-------------|-------------|-------------------|------|-------------|---------|-------------------|------|-------------|--------------|-------------------|------|
| 0-1393092-1 | MT | MT326115 | 129 | 0-1393216-6 | Card E | V23057-B0023-A401 | 74 | 0-1393240-7 | RT1 dc/ac | RT314730 | 37 |
| 0-1393092-2 | MT | MT326230 | 129 | 0-1393216-7 | Card E | V23057-B0023-B101 | 74 | 0-1393240-8 | RT1 bistable | RT315F03 | 40 |
| 0-1393092-3 | MT | MT328012 | 129 | 0-1393216-8 | Card E | V23057-B0023-B601 | 74 | 0-1393240-9 | RT1 | RT315005 | 37 |
| 0-1393092-4 | MT | MT328024 | 129 | 0-1393216-9 | Card E | V23057-B0028-A401 | 74 | 0-1393243-1 | RT2 dc/ac | RTE24005 | 67 |
| 0-1393092-5 | MT | MT328048 | 129 | 0-1393217-1 | RE | RE030005 | 26 | 0-1393243-2 | RT2 dc/ac | RTE24006 | 67 |
| 0-1393092-7 | MT | MT328115 | 129 | 0-1393217-2 | RE | RE030006 | 26 | 0-1393243-3 | RT2 dc/ac | RTE24009 | 67 |
| 0-1393092-8 | MT | MT328230 | 129 | 0-1393217-3 | RE | RE030009 | 26 | 0-1393243-4 | RT2 dc/ac | RTE24012 | 67 |
| 0-1393092-9 | MT | MT329115 | 129 | 0-1393217-4 | RE | RE030012 | 26 | 0-1393243-6 | RT2 dc/ac | RTE24018 | 67 |
| 0-1393097-5 | RMC/RMD | RMD35730 | 143 | 0-1393217-7 | RE | RE030018 | 26 | 0-1393243-7 | RT2 dc/ac | RTE24020 | 67 |
| 0-1393146-1 | RMC/RMD | RMC05012 | 143 | 0-1393217-8 | RE | RE030024 | 26 | 0-1393243-8 | RT2 dc/ac | RTE24022 | 67 |
| 0-1393146-2 | RMC/RMD | RMC05048 | 143 | 0-1393219-3 | PE | PE014005 | 22 | 0-1393244-2 | RT2 dc/ac | RT444048 | 67 |
| 0-1393146-3 | RMC/RMD | RMC05060 | 143 | 0-1393219-4 | PE | PE014006 | 22 | 0-1393244-3 | RT2 dc/ac | RT444110 | 67 |
| 0-1393146-4 | RMC/RMD | RMC05221 | 143 | 0-1393219-5 | PE | PE014009 | 22 | 0-1393244-4 | RT2 dc/ac | RT444524 | 67 |
| 0-1393146-5 | RMC/RMD | RMC05524 | 143 | 0-1393219-6 | PE | PE014012 | 22 | 0-1393244-5 | RT2 dc/ac | RT444615 | 67 |
| 0-1393146-6 | RMC/RMD | RMC05730 | 143 | 0-1393219-8 | PE | PE014018 | 22 | 0-1393244-7 | RT2 dc/ac | RT444730 | 67 |
| 0-1393146-7 | RMC/RMD | RMC35024 | 143 | 0-1393219-9 | PE | PE014021 | 22 | 0-1393244-8 | RT2 dc/ac | RT445009 | 67 |
| 0-1393146-8 | RMC/RMD | RMD05012 | 143 | 0-1393222-1 | MSR | V23061-A1001-A202 | 34 | 0-1393244-9 | RT2 dc/ac | RT445024 | 67 |
| 0-1393146-9 | RMC/RMD | RMD05024 | 143 | 0-1393222-2 | MSR | V23061-A1001-A302 | 34 | 0-1393249-7 | W58 | W58-XB1A4A-10 | 169 |
| 0-1393147-1 | RM 2/3/7 | RM707524 | 132 | 0-1393222-3 | MSR | V23061-A1002-A202 | 34 | 0-1393249-8 | W58 | W58-XB1A4A-12 | 169 |
| 0-1393147-2 | RM 2/3/7 | RM707730 | 132 | 0-1393222-4 | MSR | V23061-A1002-A302 | 34 | 0-1393249-9 | W58 | W58-XB1A4A-15 | 169 |
| 0-1393147-3 | RM 2/3/7 | RM7080C4 | 132 | 0-1393222-5 | MSR | V23061-A1002-A402 | 34 | 0-1393250-3 | W28 | W28-SQ1A-15 | 167 |
| 0-1393147-4 | RM 2/3/7 | RM708024 | 132 | 0-1393222-6 | MSR | V23061-A1002-A502 | 34 | 0-1393250-8 | W28 | W28-SQ11A-15 | 167 |
| 0-1393147-5 | RM 2/3/7 | RM709730 | 132 | 0-1393222-9 | MSR | V23061-A1003-A302 | 34 | 0-1393258-2 | SR2 M | V23047-A1005-A501 | 102 |
| 0-1393147-6 | RM 2/3/7 | RM732L2C4 | 132 | 0-1393224-1 | RY II | RYA30005 | 31 | 0-1393258-3 | SR2 M | V23047-A1009-A501 | 102 |
| 0-1393147-7 | RM 2/3/7 | RM732L48 | 132 | 0-1393224-2 | RY II | RYA30006 | 31 | 0-1393258-4 | SR2 M | V23047-A1012-A501 | 102 |
| 0-1393147-8 | RM 2/3/7 | RM7320C4 | 132 | 0-1393224-3 | RY II | RYA30009 | 31 | 0-1393258-5 | SR2 M | V23047-A1012-A511 | 102 |
| 0-1393147-9 | RM 2/3/7 | RM732060 | 132 | 0-1393224-4 | RY II | RYA30012 | 31 | 0-1393258-8 | SR2 M | V23047-A1018-A501 | 102 |
| 0-1393149-2 | RM 5/6 | RM632L2C4 | 136 | 0-1393224-5 | RY II | RYA30019 | 31 | 0-1393258-9 | SR2 M | V23047-A1018-A511 | 102 |
| 0-1393149-4 | RM 5/6 | RM632221 | 136 | 0-1393224-6 | RY II | RYA30024 | 31 | 0-1393260-1 | SR6 | V23050-A1005-A542 | 110 |
| 0-1393149-7 | RM 5/6 | RM632730 | 136 | 0-1393224-7 | RY II | RYA31005 | 31 | 0-1393260-2 | SR6 | V23050-A1006-A542 | 110 |
| 0-1393149-9 | RM 5/6 | RM637024 | 136 | 0-1393224-8 | RY II | RYA31006 | 31 | 0-1393260-3 | SR6 | V23050-A1009-A542 | 110 |
| 0-1393154-1 | PT | PT230024 | 123 | 0-1393224-9 | RY II | RYA31012 | 31 | 0-1393260-4 | SR6 | V23050-A1012-A542 | 110 |
| 0-1393154-2 | PT | PT270512 | 123 | 0-1393225-1 | RY II | RY551018 | 31 | 0-1393260-5 | SR6 | V23050-A1012-A542 | 110 |
| 0-1393154-3 | PT | PT280024 | 123 | 0-1393225-2 | RY II | RY551024 | 31 | 0-1393260-6 | SR6 | V23050-A1021-A542 | 110 |
| 0-1393154-4 | PT | PT280524 | 123 | 0-1393225-3 | RY II | RY552012 | 31 | 0-1393260-7 | SR6 | V23050-A1024-A542 | 110 |
| 0-1393154-5 | PT | PT280730 | 123 | 0-1393225-4 | RY II | RY553009 | 31 | 0-1393260-8 | SR6 | V23050-A1036-A542 | 110 |
| 0-1393154-6 | PT | PT281730 | 123 | 0-1393225-5 | RY II | RY553012 | 31 | 0-1393260-9 | SR6 | V23050-A1040-A542 | 110 |
| 0-1393154-7 | PT | PT370006 | 123 | 0-1393225-6 | RY II | RY553024 | 31 | 0-1393844-1 | RM 5/6 | RM507024 | 136 |
| 0-1393154-8 | PT | PT371615 | 123 | 0-1393225-7 | RY II | RY610005 | 31 | 0-1393844-2 | RM 5/6 | RM509L24 | 136 |
| 0-1393154-9 | PT | PT380024 | 123 | 0-1393225-8 | RY II | RY610006 | 31 | 0-1393844-3 | RM 5/6 | RM602012 | 136 |
| 0-1393161-2 | Acc. RP,RT | RPME10L0 | 150 | 0-1393225-9 | RY II | RY610009 | 31 | 0-1393844-4 | RM 5/6 | RM602024 | 136 |
| 0-1393161-3 | Acc. RP,RT | RPMG0024 | 150 | 0-1393230-1 | RP3SL | RP3SLA05 | 55 | 0-1393844-6 | RM 5/6 | RM607024 | 136 |
| 0-1393161-4 | Acc. RP,RT | RPML0024 | 150 | 0-1393230-2 | RP3SL | RP3SLA06 | 55 | 0-1393844-7 | RM 2/3/7 | RM702012 | 132 |
| 0-1393161-5 | Acc. RP,RT | RPML0048 | 150 | 0-1393230-3 | RP3SL | RP3SLA12 | 55 | 0-1393844-8 | RM 2/3/7 | RM702048 | 132 |
| 0-1393161-6 | Acc. RP,RT | RPML0110 | 150 | 0-1393230-4 | RP3SL | RP3SLA21 | 55 | 0-1393844-9 | RM 2/3/7 | RM702524 | 132 |
| 0-1393161-7 | Acc. RP,RT | RPML0524 | 150 | 0-1393230-5 | RP3SL | RP3SLF12 | 55 | 0-1393845-1 | RP II/2 | RP820F12 | 72 |
| 0-1393161-8 | Acc. RP,RT | RPML0730 | 150 | 0-1393230-6 | RP3SL | RP3SLF24 | 55 | 0-1393845-2 | RP II/2 | RP820F48 | 72 |
| 0-1393162-1 | Acc. PT | PT28802 | 154 | 0-1393230-7 | RP3SL | RP3SL005 | 55 | 0-1393845-3 | RP II/2 | RP821006 | 72 |
| 0-1393162-5 | Acc. PT | PT78603 | 154 | 0-1393230-8 | RP3SL | RP3SL006 | 55 | 0-1393845-4 | RP II/2 | RP821012 | 72 |
| 0-1393162-7 | Acc. PT | RA78728 | 154 | 0-1393230-9 | RP3SL | RP3SL012 | 55 | 0-1393845-5 | RP II/2 | RP821024 | 72 |
| 0-1393164-1 | Acc. PCLH | TM28800 | 161 | 0-1393231-1 | RP II/1 | RP411615 | 52 | 0-1393845-6 | RP II/2 | RP821048 | 72 |
| 0-1393164-2 | Acc. PCLH | TM78700 | 161 | 0-1393231-2 | RP II/1 | RP411730 | 52 | 0-1393845-7 | RP II/2 | RP821060 | 72 |
| 0-1393186-3 | T7N/T7N-VWG | T7N51D1-06 | 84 | 0-1393231-3 | RP II/1 | RP412A48 | 52 | 0-1393845-8 | RP II/2 | RP821524 | 72 |
| 0-1393199-1 | IF | V23077-A1001-A402 | 61 | 0-1393231-4 | RP II/1 | RP412A60 | 52 | 0-1393845-9 | RP II/2 | RP821615 | 72 |
| 0-1393199-2 | IF | V23077-A1002-A402 | 61 | 0-1393231-5 | RP II/1 | RP412F05 | 52 | 0-1415002-1 | PT | PT270R24 | 123 |
| 0-1393199-3 | IF | V23077-A1002-A403 | 61 | 0-1393231-6 | RP II/1 | RP412F12 | 52 | 0-1415006-1 | PT | PT520L24 | 123 |
| 0-1393199-4 | IF | V23077-A1003-A402 | 61 | 0-1393231-7 | RP II/1 | RP412F24 | 52 | 0-1415008-1 | RM 5/6 | RM507730 | 136 |
| 0-1393199-6 | IF | V23077-A1004-A402 | 61 | 0-1393231-8 | RP II/1 | RP412005 | 52 | 0-1415009-1 | RMC/RMD | RMD05615 | 143 |
| 0-1393199-7 | IF | V23077-A1005-A402 | 61 | 0-1393231-9 | RP II/1 | RP412006 | 52 | 0-1415012-1 | SR2 M | V23047-A1060-A501 | 102 |
| 0-1393199-9 | IF | V23077-A1005-A403 | 61 | 0-1393232-1 | RP II/1 | RP811524 | 52 | 0-1415013-1 | MT | MT228012 | 129 |
| 0-1393203-1 | U/UB | V23148-A0002-A101 | 77 | 0-1393232-2 | RP II/1 | RP811615 | 52 | 0-1415015-1 | SR6 | V23050-A1024-A533 | 110 |
| 0-1393203-2 | U/UB | V23148-A0002-B101 | 77 | 0-1393232-3 | RP II/1 | RP811730 | 52 | 0-1415017-1 | SR6 | V23050-A1024-A551 | 110 |
| 0-1393203-3 | U/UB | V23148-A0002-C101 | 77 | 0-1393232-4 | RP II/1 | RP812F05 | 52 | 0-1415018-1 | SR6 | V23050-A1009-A533 | 110 |
| 0-1393203-4 | U/UB | V23148-A0003-A101 | 77 | 0-1393232-5 | RP II/1 | RP812F24 | 52 | 0-1415019-1 | SR6 | V23050-A1036-A551 | 110 |
| 0-1393203-5 | U/UB | V23148-A0003-B101 | 77 | 0-1393232-6 | RP II/1 | RP812005 | 52 | 0-1415025-1 | Acc. SNR | ST16040 | 147 |
| 0-1393203-6 | U/UB | V23148-A0003-C101 | 77 | 0-1393232-7 | RP II/1 | RP812009 | 52 | 0-1415026-1 | PT | PT280R24 | 123 |
| 0-1393203-7 | U/UB | V23148-A0004-A101 | 77 | 0-1393232-8 | RP II/1 | RP812012 | 52 | 0-1415029-1 | RT1 inrush | RT31KA12 | 44 |
| 0-1393203-8 | U/UB | V23148-A0005-A101 | 77 | 0-1393232-9 | RP II/1 | RP812024 | 52 | 0-1415030-1 | PB | PB134005 | 82 |
| 0-1393203-9 | U/UB | V23148-A0005-B101 | 77 | 0-1393234-2 | RP II/1 | RP81A615 | 52 | 0-1415031-1 | PB | PB334012 | 82 |
| 0-1393204-1 | U/UB | V23148-B0001-A101 | 77 | 0-1393234-5 | RP II/1 | RP810006 | 52 | 0-1415034-1 | MT | MT325110 | 129 |
| 0-1393204-2 | U/UB | V23148-B0002-A101 | 77 | 0-1393235-2 | RP II/2 | RP42A024 | 72 | 0-1415035-1 | Acc. MT | MT78750 | 158 |
| 0-1393204-3 | U/UB | V23148-B0002-B101 | 77 | 0-1393235-3 | RP II/2 | RP42A048 | 72 | 0-1415037-1 | A. PT,RP,RT | PTMT00L0 | 150 |
| 0-1393204-4 | U/UB | V23148-B0003-A101 | 77 | 0-1393235-4 | RP II/2 | RP42A060 | 72 | 0-1415038-1 | Acc. PT | PT17020 | 154 |
| 0-1393204-5 | U/UB | V23148-B0003-B101 | 77 | 0-1393235-5 | RP II/2 | RP42A080 | 72 | 0-1415039-1 | RTH | RTH34024 | 50 |
| 0-1393204-6 | U/UB | V23148-B0003-C101 | 77 | 0-1393235-6 | RP II/2 | RP42A110 | 72 | 0-1415040-1 | A. PT,RP,RT | PTMT00T0 | 150 |
| 0-1393204-7 | U/UB | V23148-B0005-A101 | 77 | 0-1393235-7 | RP II/2 | RP42A730 | 72 | 0-1415041-1 | SR6 | SR6F4110 | 110 |
| 0-1393204-8 | U/UB | V23148-B0005-B101 | 77 | 0-1393235-8 | RP II/2 | RP42C020 | 72 | 0-1415044-1 | Acc. MT | MT78603 | 158 |
| 0-1393204-9 | U/UB | V23148-B0005-C101 | 77 | 0-1393235-9 | RP II/2 | RP42C024 | 72 | 0-1415048-1 | PT | PT270R48 | 123 |
| 0-1393210-2 | T9A | T9AN1D12-24 | 87 | 0-1393236-1 | SNR | V23092-A1005-A201 | 28 | 0-1415054-1 | SR4 D/M | SR4M4021 | 105 |
| 0-1393212-2 | T92 | T92S7A22-120 | 90 | 0-1393236-2 | SNR | V23092-A1005-A301 | 28 | 0-1415055-1 | SR4 D/M | SR4D4012 | 105 |
| 0-1393212-4 | T92 | T92S7A22-24 | 90 | 0-1393236-3 | SNR | V23092-A1006-A301 | 28 | 0-1415056-1 | SR6sensitive | SR6B4S05 | 113 |
| 0-1393212-5 | T92 | T92S7A22-240 | 90 | 0-1393236-4 | SNR | V23092-A1012-A201 | 28 | 0-1415057-1 | SR6sensitive | SR6A4S05 | 113 |
| 0-1393212-7 | T92 | T92S7D12-110 | 90 | 0-1393236-5 | SNR | V23092-A1012-A202 | 28 | 0-1415058-1 | SR6sensitive | SR6C4S05 | 113 |
| 0-1393212-8 | T92 | T92S7D12-12 | 90 | 0-1393236-6 | SNR | V23092-A1012-A203 | 28 | 0-1415060-1 | SR6 Z | SR6Z4615 | 116 |
| 0-1393215-1 | Card E | V23057-A0001-A101 | 74 | 0-1393236-7 | SNR | V23092-A1012-A301 | 28 | 0-1415062-1 | SR6 D/M | SR6D4110 | 108 |
| 0-1393215-2 | Card E | V23057-A0001-A201 | 74 | 0-1393236-8 | SNR | V23092-A1012-A302 | 28 | 0-1415064-1 | PE | PE014C24 | 22 |
| 0-1393215-3 | Card E | V23057-A0001-A401 | 74 | 0-1393236-9 | SNR | V23092-A1012-A303 | 28 | | | | |

Part number reference list

| Part No | Relay | Product key | Page | Part No | Relay | Product key | Page | Part No | Relay | Product key | Page |
|-------------|--------------|-----------------|------|-------------|------------|-------------------|------|-------------|-----------|-------------------|------|
| 0-1415403-9 | 409 dc | 0409 47 008 000 | 58 | 1-1393154-2 | PT | PT570024 | 123 | 1-1393225-0 | RY II | RY610012 | 31 |
| 0-1415404-1 | 430 1/2pole | 0430 17 0916 00 | 96 | 1-1393154-3 | PT | PT570125 | 123 | 1-1393225-1 | RY II | RY610015 | 31 |
| 0-1415404-2 | 430 1/2pole | 0430 17 0916 03 | 96 | 1-1393154-4 | PT | PT571252 | 123 | 1-1393225-2 | RY II | RY610018 | 31 |
| 0-1415404-3 | 430 1/2pole | 0430 17 1006 00 | 96 | 1-1393154-5 | PT | PT571615 | 123 | 1-1393225-3 | RY II | RY610021 | 31 |
| 0-1415404-4 | 430 1/2pole | 0430 17 1016 00 | 96 | 1-1393154-6 | PT | PT580012 | 123 | 1-1393225-4 | RY II | RY610024 | 31 |
| 0-1415404-5 | 430 1/2pole | 0430 17 6506 04 | 96 | 1-1393154-7 | PT | PT580024 | 123 | 1-1393225-5 | RY II | RY610048 | 31 |
| 0-1415404-6 | 430 1/2pole | 0430 17 6606 04 | 96 | 1-1393154-8 | PT | PT580048 | 123 | 1-1393225-6 | RY II | RY610060 | 31 |
| 0-1415404-7 | 430 1/2pole | 0430 17 6706 05 | 96 | 1-1393154-9 | PT | PT580060 | 123 | 1-1393225-7 | RY II | RY611005 | 31 |
| 0-1415404-8 | 430 1/2pole | 0430 17 7306 10 | 96 | 1-1393161-1 | Acc. RP,RT | RPMT00A0 | 150 | 1-1393225-8 | RY II | RY611006 | 31 |
| 0-1415404-9 | 430 1/2pole | 0430 17 9216 01 | 96 | 1-1393161-3 | Acc. RP,RT | RPMU0548 | 150 | 1-1393225-9 | RY II | RY611012 | 31 |
| 0-1415405-0 | 409 bistable | 0409 67 032 001 | 58 | 1-1393161-4 | Acc. RP,RT | RPMU0730 | 150 | 1-1393230-0 | RP3SL | RP3SL018 | 55 |
| 0-1415405-1 | 409 bistable | 0409 67 029 001 | 58 | 1-1393161-7 | Acc. RP | RP16100 | 150 | 1-1393230-1 | RP3SL | RP3SL024 | 55 |
| 0-1415410-1 | 410 125°C | 0410 63 001 000 | 63 | 1-1393161-8 | Acc. RP | RP16104 | 150 | 1-1393230-2 | RP3SL | RP3SL048 | 55 |
| 0-1415410-2 | 410 125°C | 0410 63 003 000 | 63 | 1-1393161-9 | Acc. RP | RP28500 | 150 | 1-1393230-3 | RP3SL | RP3SL060 | 55 |
| 0-1415410-3 | 410 125°C | 0410 63 004 000 | 63 | 1-1393199-2 | IF | V23077-A1007-A402 | 61 | 1-1393230-4 | RP3SL | RP3SL110 | 55 |
| 0-1415410-4 | 410 125°C | 0410 63 008 000 | 63 | 1-1393199-3 | IF | V23077-A1007-A403 | 61 | 1-1393230-5 | RP II/1 | RP31D024 | 52 |
| 0-1415410-5 | 410 125°C | 0410 63 009 000 | 63 | 1-1393199-5 | IF | V23077-A1009-A402 | 61 | 1-1393230-6 | RP II/1 | RP310A06 | 52 |
| 0-1415410-6 | 410 125°C | 0410 63 010 000 | 63 | 1-1393199-6 | IF | V23077-A1009-A403 | 61 | 1-1393230-7 | RP II/1 | RP310A12 | 52 |
| 0-1415410-7 | 410 125°C | 0410 63 011 000 | 63 | 1-1393199-7 | IF | V23077-A1012-A402 | 61 | 1-1393230-8 | RP II/1 | RP310A60 | 52 |
| 0-1415410-8 | 410 125°C | 0410 63 012 000 | 63 | 1-1393203-0 | U/UB | V23148-A0005-C101 | 77 | 1-1393230-9 | RP II/1 | RP310F05 | 52 |
| 0-1415410-9 | 410 125°C | 0410 63 013 001 | 63 | 1-1393203-1 | U/UB | V23148-A0007-A101 | 77 | 1-1393231-0 | RP II/1 | RP412010 | 52 |
| 0-1415419-1 | 419 | 0419 01 0305 03 | 99 | 1-1393203-2 | U/UB | V23148-A0007-B101 | 77 | 1-1393231-1 | RP II/1 | RP412012 | 52 |
| 0-1415419-2 | 419 | 0419 01 0701 02 | 99 | 1-1393203-3 | U/UB | V23148-A0007-C101 | 77 | 1-1393231-2 | RP II/1 | RP412024 | 52 |
| 0-1415419-3 | 419 | 0419 01 0701 06 | 99 | 1-1393203-4 | U/UB | V23148-A0008-A101 | 77 | 1-1393231-3 | RP II/1 | RP412048 | 52 |
| 0-1415419-4 | 419 | 0419 01 0701 09 | 99 | 1-1393203-5 | U/UB | V23148-A0102-A101 | 77 | 1-1393231-4 | RP II/1 | RP412060 | 52 |
| 0-1415419-5 | 419 | 0419 01 0901 00 | 99 | 1-1393203-6 | U/UB | V23148-A0102-B101 | 77 | 1-1393231-5 | RP II/1 | RP412110 | 52 |
| 0-1415419-6 | 419 | 0419 01 0901 01 | 99 | 1-1393203-7 | U/UB | V23148-A0102-C101 | 77 | 1-1393231-6 | RP II/1 | RP412524 | 52 |
| 0-1415419-7 | 419 | 0419 01 1001 00 | 99 | 1-1393203-8 | U/UB | V23148-A0103-A101 | 77 | 1-1393231-7 | RP II/1 | RP412615 | 52 |
| 0-1415419-8 | 419 | 0419 01 1001 01 | 99 | 1-1393203-9 | U/UB | V23148-A0103-B101 | 77 | 1-1393231-8 | RP II/1 | RP412730 | 52 |
| 0-1415419-9 | 419 | 0419 01 1001 02 | 99 | 1-1393204-0 | U/UB | V23148-B0007-A101 | 77 | 1-1393231-9 | RP II/1 | RP418A12 | 52 |
| 0-1415430-1 | 430 3mm | 0430 04 0911 00 | 93 | 1-1393204-1 | U/UB | V23148-B0007-B101 | 77 | 1-1393232-0 | RP II/1 | RP812110 | 52 |
| 0-1415430-2 | 430 3mm | 0430 04 0911 01 | 93 | 1-1393204-2 | U/UB | V23148-B0007-C101 | 77 | 1-1393232-1 | RP II/1 | RP812615 | 52 |
| 0-1415430-3 | 430 3mm | 0430 04 1011 00 | 93 | 1-1393204-3 | U/UB | V23148-B0008-A101 | 77 | 1-1393232-2 | RP II/1 | RP812730 | 52 |
| 0-1415430-4 | 430 3mm | 0430 04 1311 00 | 93 | 1-1393204-4 | U/UB | V23148-B0010-A101 | 77 | 1-1393232-3 | RP II/1 | RP818A05 | 52 |
| 0-1415430-5 | 430 3mm | 0430 05 0901 00 | 93 | 1-1393210-2 | T9A | T9AS1D12-110 | 87 | 1-1393232-4 | RP II/1 | RP818F24 | 52 |
| 0-1415430-6 | 430 3mm | 0430 05 0911 00 | 93 | 1-1393210-3 | T9A | T9AS1D12-12 | 87 | 1-1393232-5 | RP II/1 | RP818005 | 52 |
| 0-1415430-7 | 430 3mm | 0430 05 1001 00 | 93 | 1-1393210-4 | T9A | T9AS1D12-15 | 87 | 1-1393232-6 | RP II/1 | RP818006 | 52 |
| 0-1415430-8 | 430 3mm | 0430 05 1011 00 | 93 | 1-1393210-5 | T9A | T9AS1D12-18 | 87 | 1-1393232-7 | RP II/1 | RP818012 | 52 |
| 0-1415430-9 | 430 3mm | 0430 05 1021 00 | 93 | 1-1393210-8 | T9A | T9AS1D12-24 | 87 | 1-1393232-8 | RP II/1 | RP818018 | 52 |
| 0-1419105-2 | RM 2/3/7 | RM703627 | 132 | 1-1393210-9 | T9A | T9AS1D12-48 | 87 | 1-1393232-9 | RP II/1 | RP818024 | 52 |
| 0-1419108-1 | RT1 dc/ac | RT114012 | 37 | 1-1393212-0 | T92 | T92S7D12-24 | 90 | 1-1393234-3 | RP II/1 | RP818A12 | 52 |
| 0-1419108-6 | RT1 dc/ac | RT214730 | 37 | 1-1393212-1 | T92 | T92S7D12-48 | 90 | 1-1393234-5 | RP II/1 | RP818F12 | 52 |
| 0-1419108-7 | Acc. RT | RT28516 | 150 | 1-1393212-3 | T92 | T92S7D22-110 | 90 | 1-1393234-6 | RP II/1 | RP818524 | 52 |
| 0-1419112-1 | Acc. PT | PT78703 | 154 | 1-1393212-7 | T92 | T92S7D22-24 | 90 | 1-1393234-7 | RP II/1 | RP818615 | 52 |
| 0-1419112-2 | Acc. PT | PT78704 | 154 | 1-1393215-0 | Card E | V23057-A0002-A901 | 74 | 1-1393235-0 | RP II/2 | RP42C060 | 72 |
| 0-1419118-5 | Acc. RM | RM28802 | 162 | 1-1393215-1 | Card E | V23057-A0002-B101 | 74 | 1-1393235-1 | RP II/2 | RP420F05 | 72 |
| 0-1419118-6 | Acc. RM | RM78700 | 162 | 1-1393215-2 | Card E | V23057-A0002-B601 | 74 | 1-1393235-2 | RP II/2 | RP420F48 | 72 |
| 0-1419136-6 | RM 2/3/7 | RM205048 | 132 | 1-1393215-4 | Card E | V23057-A0004-A401 | 74 | 1-1393235-4 | RP II/2 | RP420004 | 72 |
| 0-1419136-7 | RM 5/6 | RM502900 | 136 | 1-1393215-5 | Card E | V23057-A0005-A401 | 74 | 1-1393235-5 | RP II/2 | RP420018 | 72 |
| 0-1419136-8 | RM 5/6 | RM505740 | 136 | 1-1393215-6 | Card E | V23057-A0005-A402 | 74 | 1-1393235-6 | RP II/2 | RP420034 | 72 |
| 0-1419136-9 | RM 2/3/7 | RM705110 | 132 | 1-1393215-7 | Card E | V23057-A0005-A901 | 74 | 1-1393235-7 | RP II/2 | RP420036 | 72 |
| 0-1419143-2 | RP II/1 | RP459012 | 52 | 1-1393215-9 | Card E | V23057-A0005-A902 | 74 | 1-1393235-8 | RP II/2 | RP420080 | 72 |
| 0-1419143-3 | RP II/1 | RP45B024 | 52 | 1-1393216-0 | Card E | V23057-B0028-B101 | 74 | 1-1393235-9 | RP II/2 | RP421A12 | 72 |
| 0-1419144-8 | RT2 dc/ac | RT444005 | 67 | 1-1393216-1 | Card E | V23057-B0028-B601 | 74 | 1-1393236-3 | SNR | V23092-A1012-A801 | 28 |
| 0-1419146-7 | PCD | PCD-148-D1MH | 80 | 1-1393216-2 | Card E | V23057-B0030-A401 | 74 | 1-1393236-8 | SNR | V23092-A1018-A201 | 28 |
| 0-1419151-2 | RP II/2 | RP421548 | 72 | 1-1393216-5 | Card E | V23057-B1006-A401 | 74 | 1-1393236-9 | SNR | V23092-A1018-A301 | 28 |
| 0-1419151-4 | RP II/2 | RP421F48 | 72 | 1-1393217-0 | RE | RE030036 | 26 | 1-1393238-1 | RT1 dc/ac | RTB14003 | 37 |
| 0-1419151-9 | RP II/2 | RP427A12 | 72 | 1-1393217-1 | RE | RE030048 | 26 | 1-1393238-2 | RT1 dc/ac | RTB14005 | 37 |
| 1-1393092-1 | MT | MT331024 | 129 | 1-1393217-2 | RE | RE031003 | 26 | 1-1393238-3 | RT1 dc/ac | RTB14006 | 37 |
| 1-1393092-2 | MT | MT331048 | 129 | 1-1393217-3 | RE | RE031006 | 26 | 1-1393238-4 | RT1 dc/ac | RTB14009 | 37 |
| 1-1393092-3 | MT | MT331110 | 129 | 1-1393217-4 | RE | RE031009 | 26 | 1-1393238-5 | RT1 dc/ac | RTB14012 | 37 |
| 1-1393092-5 | MT | MT331220 | 129 | 1-1393217-5 | RE | RE031012 | 26 | 1-1393238-6 | RT1 dc/ac | RTB14015 | 37 |
| 1-1393092-6 | MT | MT3330C4 | 129 | 1-1393217-6 | RE | RE031018 | 26 | 1-1393238-7 | RT1 dc/ac | RTB14018 | 37 |
| 1-1393092-8 | MT | MT333024 | 129 | 1-1393217-7 | RE | RE031021 | 26 | 1-1393238-8 | RT1 dc/ac | RTB14020 | 37 |
| 1-1393092-9 | MT | MT3331B0 | 129 | 1-1393217-8 | RE | RE031024 | 26 | 1-1393238-9 | RT1 dc/ac | RTB14024 | 37 |
| 1-1393107-5 | RM 2/3/7 | RM202L48 | 132 | 1-1393217-9 | RE | RE032005 | 26 | 1-1393239-1 | RT1 dc/ac | RT114018 | 37 |
| 1-1393107-6 | RM 2/3/7 | RM202M10 | 132 | 1-1393219-0 | PE | PE014024 | 22 | 1-1393239-2 | RT1 dc/ac | RT114020 | 37 |
| 1-1393107-7 | RM 2/3/7 | RM202006 | 132 | 1-1393219-2 | PE | PE014036 | 22 | 1-1393239-3 | RT1 dc/ac | RT114024 | 37 |
| 1-1393146-0 | RMC/RMD | RMD05048 | 143 | 1-1393219-3 | PE | PE014048 | 22 | 1-1393239-4 | RT1 dc/ac | RT114048 | 37 |
| 1-1393146-1 | RMC/RMD | RMD05524 | 143 | 1-1393219-4 | PE | PE015012 | 22 | 1-1393239-5 | RT1 dc/ac | RT114060 | 37 |
| 1-1393146-5 | RM 2/3/7 | RM202110 | 132 | 1-1393219-5 | PE | PE015024 | 22 | 1-1393239-6 | RT1 dc/ac | RT114110 | 37 |
| 1-1393146-6 | RM 2/3/7 | RM202221 | 132 | 1-1393219-6 | PE | PE015048 | 22 | 1-1393239-7 | RT1 dc/ac | RT114524 | 37 |
| 1-1393146-7 | RM 2/3/7 | RM202506 | 132 | 1-1393219-7 | PE | PE514005 | 22 | 1-1393239-8 | RT1 dc/ac | RT114615 | 37 |
| 1-1393146-8 | RM 2/3/7 | RM202512 | 132 | 1-1393219-8 | PE | PE514006 | 22 | 1-1393239-9 | RT1 dc/ac | RT114730 | 37 |
| 1-1393146-9 | RM 2/3/7 | RM202524 | 132 | 1-1393219-9 | PE | PE514009 | 22 | 1-1393240-0 | RT1 dc/ac | RT315006 | 37 |
| 1-1393147-0 | RM 2/3/7 | RM732524 | 132 | 1-1393222-2 | MSR | V23061-A1003-A402 | 34 | 1-1393240-1 | RT1 dc/ac | RT315012 | 37 |
| 1-1393147-1 | RM 2/3/7 | RM732615 | 132 | 1-1393222-3 | MSR | V23061-A1003-A502 | 34 | 1-1393240-2 | RT1 dc/ac | RT315015 | 37 |
| 1-1393147-3 | RM 2/3/7 | RM732720 | 132 | 1-1393222-5 | MSR | V23061-A1004-A302 | 34 | 1-1393240-3 | RT1 dc/ac | RT315018 | 37 |
| 1-1393147-4 | RM 2/3/7 | RM732880 | 132 | 1-1393222-6 | MSR | V23061-A1004-A402 | 34 | 1-1393240-4 | RT1 dc/ac | RT315024 | 37 |
| 1-1393147-5 | RM 2/3/7 | RM733730 | 132 | 1-1393222-7 | MSR | V23061-A1004-A502 | 34 | 1-1393240-5 | RT1 dc/ac | RT315036 | 37 |
| 1-1393147-6 | RM 2/3/7 | RM733740 | 132 | 1-1393222-8 | MSR | V23061-A1004-A602 | 34 | 1-1393240-6 | RT1 dc/ac | RT315048 | 37 |
| 1-1393147-8 | RM 2/3/7 | RM735012 | 132 | 1-1393223-1 | MSR | V23061-B1006-A301 | 34 | 1-1393240-7 | RT1 dc/ac | RT315060 | 37 |
| 1-1393147-9 | RM 2/3/7 | RM735548 | 132 | 1-1393223-2 | MSR | V23061-B1006-A401 | 34 | 1-1393240-8 | RT1 dc/ac | RT315080 | 37 |
| 1-1393148-1 | RM 2/3/7 | RM202L24 | 132 | 1-1393223-4 | MSR | V23061-B1006-A501 | 34 | 1-1393240-9 | RT1 dc/ac | RT315110 | 37 |
| 1-1393148-2 | RM 2/3/7 | RM202048 | 132 | 1-1393223-5 | MSR | V23061-B1006-A601 | 34</ | | | | |

Part number reference list

| Part No | Relay | Product key | Page | Part No | Relay | Product key | Page | Part No | Relay | Product key | Page |
|-------------|---------------|-------------------|------|-------------|-----------|-------------------|------|-------------|---------|-------------------|------|
| 1-1393249-9 | W58 | W58-XB1A4A-5 | 169 | 1-1415419-9 | 419 | 0419 01 1503 08 | 99 | 2-1393217-2 | RE | RE032012 | 26 |
| 1-1393250-9 | W28 | W28-XQ1A-0.25 | 167 | 1-1415430-0 | 430 3mm | 0430 05 1111 00 | 93 | 2-1393217-3 | RE | RE032018 | 26 |
| 1-1393252-7 | W6 | W67-A2Q12-10 | 171 | 1-1415430-1 | 430 3mm | 0430 05 1301 00 | 93 | 2-1393217-4 | RE | RE032024 | 26 |
| 1-1393252-8 | W6 | W67-A2Q12-5 | 171 | 1-1415430-2 | 430 3mm | 0430 05 1311 00 | 93 | 2-1393217-5 | RE | RE032048 | 26 |
| 1-1393258-1 | SR2 M | V23047-A1021-A501 | 102 | 1-1415430-3 | 430 3mm | 0430 05 2301 00 | 93 | 2-1393217-6 | RE | RE036006 | 26 |
| 1-1393258-2 | SR2 M | V23047-A1021-A511 | 102 | 1-1415430-4 | 430 3mm | 0430 05 2701 00 | 93 | 2-1393217-7 | RE | RE036012 | 26 |
| 1-1393258-5 | SR2 M | V23047-A1024-A501 | 102 | 1-1415430-5 | 430 3mm | 0430 05 2711 00 | 93 | 2-1393219-0 | PE | PE514012 | 22 |
| 1-1393258-7 | SR2 M | V23047-A1024-A511 | 102 | 1-1415430-6 | 430 3mm | 0430 05 2711 07 | 93 | 2-1393219-1 | PE | PE514018 | 22 |
| 1-1393260-0 | SR6 | V23050-A1048-A542 | 110 | 1-1415430-7 | 430 3mm | 0430 05 2811 00 | 93 | 2-1393219-2 | PE | PE514024 | 22 |
| 1-1393260-1 | SR6 | V23050-A1060-A542 | 110 | 1-1415430-8 | 430 3mm | 0430 05 3211 01 | 93 | 2-1393219-3 | PE | PE514036 | 22 |
| 1-1393260-2 | SR6 | V23050-A1085-A542 | 110 | 1-1415430-9 | 430 3mm | 0430 05 3611 04 | 93 | 2-1393222-0 | MSR | V23061-A1005-A302 | 34 |
| 1-1393260-3 | SR6 | V23050-A1110-A542 | 110 | 1-1419104-6 | T9A | T9AS1D22-110 | 87 | 2-1393222-3 | MSR | V23061-A1005-A402 | 34 |
| 1-1393844-0 | RM 2/3/7 | RM702615 | 132 | 1-1419104-7 | T9A | T9AS1D22-12 | 87 | 2-1393222-7 | MSR | V23061-A1005-A502 | 34 |
| 1-1393844-1 | RM 2/3/7 | RM702730 | 132 | 1-1419104-8 | T9A | T9AS1D22-15 | 87 | 2-1393222-8 | MSR | V23061-A1005-A602 | 34 |
| 1-1393844-2 | RM 2/3/7 | RM703024 | 132 | 1-1419104-9 | T9A | T9AS1D22-18 | 87 | 2-1393223-1 | MSR | V23061-B1007-A401 | 34 |
| 1-1393844-3 | RM 2/3/7 | RM703110 | 132 | 1-1419108-1 | RT1 dc/ac | RT315730 | 37 | 2-1393223-5 | MSR | V23061-B1007-A501 | 34 |
| 1-1393844-4 | RM 2/3/7 | RM705615 | 132 | 1-1419136-0 | RM 2/3/7 | RM708730 | 132 | 2-1393223-6 | MSR | V23061-B1007-A601 | 34 |
| 1-1393844-5 | RM 2/3/7 | RM705730 | 132 | 1-1419136-1 | RM 2/3/7 | RM709548 | 132 | 2-1393224-0 | RY II | RYA33021 | 31 |
| 1-1393844-7 | RM 2/3/7 | RM732024 | 132 | 1-1419151-0 | RP II/2 | RP42A524 | 72 | 2-1393224-1 | RY II | RYA33024 | 31 |
| 1-1393844-8 | RM 2/3/7 | RM732730 | 132 | 1-1419151-3 | RP II/1 | RP430060 | 52 | 2-1393224-2 | RY II | RYA33060 | 31 |
| 1-1393844-9 | RM 2/3/7 | RM737012 | 132 | 1-1419151-4 | RP II/1 | RP430060 | 52 | 2-1393224-3 | RY II | RYA50005 | 31 |
| 1-1393845-0 | RP II/2 | RP821F12 | 72 | 1-1419151-5 | RP II/1 | RP430110 | 52 | 2-1393224-4 | RY II | RYA50012 | 31 |
| 1-1393845-2 | RP II/2 | RP827012 | 72 | 1-1419151-6 | RP II/1 | RP430730 | 52 | 2-1393224-5 | RY II | RYA50024 | 31 |
| 1-1393845-3 | RP II/2 | RP827024 | 72 | 1-1419151-7 | RP II/1 | RP430A06 | 52 | 2-1393224-6 | RY II | RYA51005 | 31 |
| 1-1393845-4 | RP II/2 | RP82A024 | 72 | 1-1419151-8 | RP II/1 | RP430A12 | 52 | 2-1393224-7 | RY II | RYA51012 | 31 |
| 1-1393845-5 | RP II/2 | RP82C012 | 72 | 1-1419151-9 | RP II/1 | RP438005 | 52 | 2-1393224-8 | RY II | RYA51024 | 31 |
| 1-1393845-6 | RP II/2 | RP840005 | 72 | 1-1440009-6 | PCLH | PCLH-208A1F | 157 | 2-1393224-9 | RY II | RYA52009 | 31 |
| 1-1393845-7 | RP II/2 | RP840012 | 72 | 2-1393092-0 | MT | MT333110 | 129 | 2-1393225-0 | RY II | RY611019 | 31 |
| 1-1393845-8 | RP II/2 | RP840024 | 72 | 2-1393092-2 | MT | MT333220 | 129 | 2-1393225-1 | RY II | RY611024 | 31 |
| 1-1414034-0 | Card E | V23057-A0015-A102 | 74 | 2-1393092-4 | MT | MT336048 | 129 | 2-1393225-2 | RY II | RY611048 | 31 |
| 1-1415012-1 | SR2 M | V23047-A1110-A501 | 102 | 2-1393092-5 | MT | MT336115 | 129 | 2-1393225-3 | RY II | RY612005 | 31 |
| 1-1415013-1 | MT | MT228048 | 129 | 2-1393092-6 | MT | MT336230 | 129 | 2-1393225-4 | RY II | RY612006 | 31 |
| 1-1415014-1 | MT | MT328110 | 129 | 2-1393092-7 | MT | MT338024 | 129 | 2-1393225-5 | RY II | RY612009 | 31 |
| 1-1415015-1 | SR6 | V23050-A1012-A533 | 110 | 2-1393092-8 | MT | MT338230 | 129 | 2-1393225-6 | RY II | RY612012 | 31 |
| 1-1415017-1 | SR6 | V23050-A1012-A551 | 110 | 2-1393146-0 | RM 2/3/7 | RM202615 | 132 | 2-1393225-7 | RY II | RY612018 | 31 |
| 1-1415018-1 | SR6 | V23050-A1015-A533 | 110 | 2-1393146-1 | RM 2/3/7 | RM202720 | 132 | 2-1393225-8 | RY II | RY612021 | 31 |
| 1-1415019-1 | SR6 | V23050-A1040-A551 | 110 | 2-1393146-2 | RM 2/3/7 | RM203006 | 132 | 2-1393225-9 | RY II | RY612024 | 31 |
| 1-1415021-1 | PT | PT570L48 | 123 | 2-1393146-3 | RM 2/3/7 | RM203110 | 132 | 2-1393230-0 | RP II/1 | RP310F06 | 52 |
| 1-1415026-1 | PT | PT280T30 | 123 | 2-1393146-4 | RM 2/3/7 | RM203125 | 132 | 2-1393230-1 | RP II/1 | RP310F12 | 52 |
| 1-1415030-1 | PB | PB134006 | 82 | 2-1393146-5 | RM 2/3/7 | RM203524 | 132 | 2-1393230-2 | RP II/1 | RP310F24 | 52 |
| 1-1415031-1 | PB | PB334024 | 82 | 2-1393146-6 | RM 2/3/7 | RM203615 | 132 | 2-1393230-3 | RP II/1 | RP310F48 | 52 |
| 1-1415034-1 | MT | MT320220 | 129 | 2-1393146-7 | RM 2/3/7 | RM203627 | 132 | 2-1393230-4 | RP II/1 | RP310W20 | 52 |
| 1-1415037-1 | A, PT, RP, RT | PTMU0524 | 150 | 2-1393146-8 | RM 2/3/7 | RM203730 | 132 | 2-1393230-5 | RP II/1 | RP310005 | 52 |
| 1-1415039-1 | PT | PT570R48 | 123 | 2-1393146-9 | RM 2/3/7 | RM205024 | 132 | 2-1393230-6 | RP II/1 | RP310006 | 52 |
| 1-1415041-1 | SR6 | SR6E4012 | 110 | 2-1393147-0 | RM 2/3/7 | RM737030 | 132 | 2-1393230-7 | RP II/1 | RP310009 | 52 |
| 1-1415044-1 | RM 2/3/7 | RM232LC4 | 132 | 2-1393147-1 | RM 2/3/7 | RM738012 | 132 | 2-1393230-8 | RP II/1 | RP310010 | 52 |
| 1-1415048-1 | PT | PT370R48 | 123 | 2-1393147-2 | RM 2/3/7 | RM738730 | 132 | 2-1393230-9 | RP II/1 | RP310012 | 52 |
| 1-1415054-1 | SR4 D/M | SR4M4036 | 105 | 2-1393147-3 | RM 2/3/7 | RM739221 | 132 | 2-1393231-0 | RP II/1 | RP418F12 | 52 |
| 1-1415055-1 | SR4 D/M | SR4D4018 | 105 | 2-1393147-4 | RM 8 | RM805LC4 | 140 | 2-1393231-1 | RP II/1 | RP418F24 | 52 |
| 1-1415056-1 | SR6sensitive | SR6B4S06 | 113 | 2-1393147-5 | RM 8 | RM805054 | 140 | 2-1393231-2 | RP II/1 | RP418005 | 52 |
| 1-1415057-1 | SR6sensitive | SR6A4S06 | 113 | 2-1393147-6 | RM 8 | RM805048 | 140 | 2-1393231-3 | RP II/1 | RP418006 | 52 |
| 1-1415058-1 | SR6sensitive | SR6C4S06 | 113 | 2-1393147-7 | RM 8 | RM805072 | 140 | 2-1393231-4 | RP II/1 | RP418009 | 52 |
| 1-1415059-1 | SNR | V23092-A1024-A901 | 28 | 2-1393147-8 | RM 8 | RM805512 | 140 | 2-1393231-5 | RP II/1 | RP418012 | 52 |
| 1-1415060-1 | SR6 Z | SR6Z4730 | 116 | 2-1393147-9 | RM 8 | RM805524 | 140 | 2-1393231-6 | RP II/1 | RP418013 | 52 |
| 1-1415064-1 | PE | PE014C12 | 22 | 2-1393148-3 | RM 2/3/7 | RM205070 | 132 | 2-1393231-7 | RP II/1 | RP418020 | 52 |
| 1-1415068-1 | SNR | V23092-A1005-A801 | 28 | 2-1393148-5 | RM 2/3/7 | RM207110 | 132 | 2-1393231-8 | RP II/1 | RP418024 | 52 |
| 1-1415073-1 | RT Package | RT4S4LC4 | 165 | 2-1393148-6 | RM 2/3/7 | RM207220 | 132 | 2-1393231-9 | RP II/1 | RP418034 | 52 |
| 1-1415074-1 | RT Package | RT4S5R24 | 165 | 2-1393148-7 | RM 2/3/7 | RM207720 | 132 | 2-1393232-0 | RP II/1 | RP818048 | 52 |
| 1-1415075-1 | PT Package | PT357LB2 | 166 | 2-1393149-2 | RM 2/3/7 | RM709024 | 132 | 2-1393232-1 | RP II/1 | RP818110 | 52 |
| 1-1415403-0 | 409 dc | 0409 47 022 001 | 58 | 2-1393149-8 | RM 2/3/7 | RM732048 | 132 | 2-1393232-2 | RP II/1 | RP818730 | 52 |
| 1-1415403-1 | 409 dc | 0409 47 023 001 | 58 | 2-1393154-0 | PT | PT580110 | 123 | 2-1393232-3 | RP II/1 | RP831730 | 52 |
| 1-1415403-2 | 409 dc | 0409 47 026 001 | 58 | 2-1393154-1 | PT | PT580524 | 123 | 2-1393232-4 | RP II/1 | RP832012 | 52 |
| 1-1415403-3 | 409 dc | 0409 47 027 001 | 58 | 2-1393154-2 | PT | PT580730 | 123 | 2-1393232-5 | RP II/1 | RP838006 | 52 |
| 1-1415403-4 | 409 dc | 0409 47 028 001 | 58 | 2-1393154-3 | PT | PT581730 | 123 | 2-1393232-6 | RP II/1 | RP838012 | 52 |
| 1-1415403-5 | 409 dc | 0409 47 030 001 | 58 | 2-1393203-0 | U/UB | V23148-A0103-C101 | 77 | 2-1393232-7 | RP II/1 | RP838020 | 52 |
| 1-1415403-6 | 409 dc | 0409 47 031 001 | 58 | 2-1393203-1 | U/UB | V23148-A0105-A101 | 77 | 2-1393232-8 | RP II/1 | RP838024 | 52 |
| 1-1415403-7 | 409 dc | 0409 47 034 001 | 58 | 2-1393203-2 | U/UB | V23148-A0105-B101 | 77 | 2-1393232-9 | RP II/1 | RP838048 | 52 |
| 1-1415404-0 | 430 3mm | 0430 25 0811 03 | 93 | 2-1393203-3 | U/UB | V23148-A0105-C101 | 77 | 2-1393234-2 | RP II/2 | RP82C005 | 72 |
| 1-1415404-1 | 430 3mm | 0430 25 0911 00 | 93 | 2-1393203-4 | U/UB | V23148-A0107-A101 | 77 | 2-1393234-3 | RP II/2 | RP82C615 | 72 |
| 1-1415404-2 | 430 3mm | 0430 25 0911 05 | 93 | 2-1393203-5 | U/UB | V23148-A0107-B101 | 77 | 2-1393234-4 | RP II/2 | RP820A12 | 72 |
| 1-1415404-3 | 430 3mm | 0430 25 1011 00 | 93 | 2-1393203-6 | U/UB | V23148-A0107-C101 | 77 | 2-1393234-6 | RP II/2 | RP820F06 | 72 |
| 1-1415404-4 | 430 3mm | 0430 25 2711 00 | 93 | 2-1393203-7 | U/UB | V23148-A1005-A101 | 77 | 2-1393234-7 | RP II/2 | RP820W19 | 72 |
| 1-1415404-5 | 430 3mm | 0430 25 2711 01 | 93 | 2-1393203-8 | U/UB | V23148-A1007-A101 | 77 | 2-1393235-0 | RP II/2 | RP421A24 | 72 |
| 1-1415404-6 | 430 3mm | 0430 25 2811 00 | 93 | 2-1393203-9 | U/UB | V23148-A1105-A101 | 77 | 2-1393235-1 | RP II/2 | RP421B10 | 72 |
| 1-1415404-7 | 430 3mm | 0430 25 2811 04 | 93 | 2-1393210-0 | T9A | T9AS1D12-5 | 87 | 2-1393235-2 | RP II/2 | RP421F06 | 72 |
| 1-1415404-8 | 430 3mm | 0430 25 5711 08 | 93 | 2-1393210-2 | T9A | T9AS1D12-9 | 87 | 2-1393235-3 | RP II/2 | RP421W19 | 72 |
| 1-1415404-9 | 430 3mm | 0430 25 8911 10 | 93 | 2-1393210-4 | T9A | T9AS1L12-12 | 87 | 2-1393235-4 | RP II/2 | RP421018 | 72 |
| 1-1415410-0 | 410 125°C | 0410 63 014 000 | 63 | 2-1393210-5 | T9A | T9AS1L12-24 | 87 | 2-1393235-5 | RP II/2 | RP421080 | 72 |
| 1-1415410-1 | 410 125°C | 0410 63 016 000 | 63 | 2-1393215-1 | Card E | V23057-A0006-A101 | 74 | 2-1393235-6 | RP II/2 | RP421524 | 72 |
| 1-1415410-2 | 410 125°C | 0410 63 017 000 | 63 | 2-1393215-2 | Card E | V23057-A0006-A102 | 74 | 2-1393235-7 | RP II/2 | RP421730 | 72 |
| 1-1415410-3 | 410 125°C | 0410 63 020 000 | 63 | 2-1393215-3 | Card E | V23057-A0006-A201 | 74 | 2-1393235-8 | RP II/2 | RP427F24 | 72 |
| 1-1415410-4 | 410 125°C | 0410 63 022 000 | 63 | 2-1393215-4 | Card E | V23057-A0006-A202 | 74 | 2-1393235-9 | RP II/2 | RP440005 | 72 |
| 1-1415410-5 | 410 125°C | 0410 63 022 001 | 63 | 2-1393215-5 | Card E | V23057-A0006-A401 | 74 | 2-1393236-1 | SNR | V23092-A1024-A201 | 28 |
| 1-1415410-6 | 410 125°C | 0410 63 022 002 | 63 | 2-1393215-7 | Card E | V23057-A0006-A402 | 74 | 2-1393236-2 | SNR | V23092-A1024-A202 | 28 |
| 1-1415410-7 | 410 125°C | 0410 63 023 000 | 63 | 2-1393215-8 | | | | | | | |

Part number reference list

| Part No | Relay | Product key | Page | Part No | Relay | Product key | Page | Part No | Relay | Product key | Page |
|-------------|--------------|-------------------|------|-------------|--------------|-------------------|------|-------------|-----------|-------------------|------|
| 2-1393238-9 | RT1 dc/ac | RTB34005 | 37 | 2-1415410-1 | 410 125°C | 0410 63 026 000 | 63 | 3-1393215-6 | Card E | V23057-A0011-A201 | 74 |
| 2-1393239-1 | RT1 dc/ac | RT115024 | 37 | 2-1415410-2 | 410 125°C | 0410 63 027 000 | 63 | 3-1393215-8 | Card E | V23057-A0013-A101 | 74 |
| 2-1393239-2 | RT1 dc/ac | RT115110 | 37 | 2-1415410-3 | 410 125°C | 0410 63 028 000 | 63 | 3-1393215-9 | Card E | V23057-A0013-A201 | 74 |
| 2-1393239-3 | RT1 dc/ac | RT134005 | 37 | 2-1415410-4 | 410 125°C | 0410 63 029 000 | 63 | 3-1393216-1 | Card E | V23057-D0002-A102 | 74 |
| 2-1393239-4 | RT1 dc/ac | RT134006 | 37 | 2-1415410-5 | 410 125°C | 0410 63 030 000 | 63 | 3-1393216-2 | Card E | V23057-D0002-A402 | 74 |
| 2-1393239-5 | RT1 dc/ac | RT134009 | 37 | 2-1415410-6 | 410 125°C | 0410 63 031 000 | 63 | 3-1393216-3 | Card E | V23057-D0002-A403 | 74 |
| 2-1393239-6 | RT1 dc/ac | RT134012 | 37 | 2-1415410-7 | 410 125°C | 0410 63 042 001 | 63 | 3-1393216-4 | Card E | V23057-D0006-A102 | 74 |
| 2-1393239-8 | RT1 dc/ac | RT134018 | 37 | 2-1415410-8 | 410 125°C | 0410 63 043 001 | 63 | 3-1393216-5 | Card E | V23057-D0006-A402 | 74 |
| 2-1393239-9 | RT1 dc/ac | RT134020 | 37 | 2-1415410-9 | 410 125°C | 0410 63 044 001 | 63 | 3-1393216-6 | Card E | V23057-D0011-A402 | 74 |
| 2-1393240-0 | RT1 dc/ac | RT315524 | 37 | 2-1415410-0 | 419 | 0419 01 1601 09 | 99 | 3-1393216-8 | Card E | V23057-D0011-A403 | 74 |
| 2-1393240-1 | RT1 intrush | RT33KA05 | 44 | 2-1415419-1 | 419 | 0419 01 1601 10 | 99 | 3-1393216-9 | Card E | V23057-D0023-A102 | 74 |
| 2-1393240-2 | RT1 intrush | RT33K005 | 44 | 2-1415419-2 | 419 | 0419 01 1603 07 | 99 | 3-1393222-4 | MSR | V23061-A1006-A302 | 34 |
| 2-1393240-3 | RT1 intrush | RT33LF12 | 44 | 2-1415419-3 | 419 | 0419 01 1603 08 | 99 | 3-1393222-5 | MSR | V23061-A1006-A402 | 34 |
| 2-1393240-4 | RT1 intrush | RT33K024 | 44 | 2-1415419-4 | 419 | 0419 01 1603 10 | 99 | 3-1393222-6 | MSR | V23061-A1006-A502 | 34 |
| 2-1393240-5 | RT1 intrush | RT33K048 | 44 | 2-1415419-5 | 419 | 0419 01 1603 11 | 99 | 3-1393222-7 | MSR | V23061-A1006-A602 | 34 |
| 2-1393240-6 | RT1 intrush | RT33LA06 | 44 | 2-1415419-6 | 419 | 0419 01 2901 00 | 99 | 3-1393222-9 | MSR | V23061-A1007-A302 | 34 |
| 2-1393240-7 | RT1 intrush | RT33LA12 | 44 | 2-1415419-7 | 419 | 0419 01 2901 01 | 99 | 3-1393223-5 | MSR | V23061-B1008-A401 | 34 |
| 2-1393240-8 | RT1 intrush | RT33LF12 | 44 | 2-1415419-8 | 419 | 0419 01 2901 02 | 99 | 3-1393223-6 | MSR | V23061-B1008-A501 | 34 |
| 2-1393240-9 | RT1 intrush | RT33LF24 | 44 | 2-1415419-9 | 419 | 0419 01 3103 04 | 99 | 3-1393223-7 | MSR | V23061-B1009-A301 | 34 |
| 2-1393243-0 | RT2 dc/ac | RTE25012 | 67 | 2-1415430-0 | 430 1/2pole | 0430 06 0303 00 | 96 | 3-1393223-8 | MSR | V23061-B1009-A401 | 34 |
| 2-1393243-1 | RT2 dc/ac | RTE25024 | 67 | 2-1415430-1 | 430 1/2pole | 0430 06 0311 00 | 96 | 3-1393223-9 | MSR | V23061-B1009-A501 | 34 |
| 2-1393243-2 | RT2 dc/ac | RTE25060 | 67 | 2-1415430-2 | 430 1/2pole | 0430 06 0611 01 | 96 | 3-1393224-0 | RY II | RYA52012 | 31 |
| 2-1393243-3 | RT2 dc/ac | RTE25110 | 67 | 2-1415430-3 | 430 1/2pole | 0430 06 0613 00 | 96 | 3-1393224-1 | RY II | RY210005 | 31 |
| 2-1393243-4 | RT2 dc/ac | RTE25524 | 67 | 2-1415430-4 | 430 1/2pole | 0430 06 0701 00 | 96 | 3-1393224-2 | RY II | RY210006 | 31 |
| 2-1393243-6 | RT2 dc/ac | RTE25615 | 67 | 2-1415430-5 | 430 1/2pole | 0430 06 0703 00 | 96 | 3-1393224-3 | RY II | RY210009 | 31 |
| 2-1393243-8 | RT2 dc/ac | RTE25730 | 67 | 2-1415430-6 | 430 1/2pole | 0430 06 0703 04 | 96 | 3-1393224-4 | RY II | RY210010 | 31 |
| 2-1393250-1 | W28 | W28-XQ1A-0.50 | 167 | 2-1415430-7 | 430 1/2pole | 0430 06 0711 00 | 96 | 3-1393224-5 | RY II | RY210012 | 31 |
| 2-1393250-3 | W28 | W28-XQ1A-1 | 167 | 2-1415430-8 | 430 1/2pole | 0430 06 0711 09 | 96 | 3-1393224-6 | RY II | RY210015 | 31 |
| 2-1393250-5 | W28 | W28-XQ1A-10 | 167 | 2-1415430-9 | 430 1/2pole | 0430 06 0713 00 | 96 | 3-1393224-7 | RY II | RY210018 | 31 |
| 2-1393250-7 | W28 | W28-XQ1A-12 | 167 | 2-1416000-0 | MSR | V23061-A1016-A302 | 34 | 3-1393224-8 | RY II | RY210024 | 31 |
| 2-1393250-8 | W28 | W28-XQ1A-13 | 167 | 2-1419104-1 | T9A | T9AS1D22-24 | 87 | 3-1393224-9 | RY II | RY210032 | 31 |
| 2-1393258-0 | SR2 M | V23047-A1036-A501 | 102 | 2-1419104-2 | T9A | T9AS1D22-48 | 87 | 3-1393225-0 | RY II | RY612048 | 31 |
| 2-1393258-1 | SR2 M | V23047-A1040-A501 | 102 | 2-1419108-1 | Acc. RT | RT78624 | 150 | 3-1393225-1 | RY II | RY613012 | 31 |
| 2-1393258-2 | SR2 M | V23047-A1040-A511 | 102 | 2-1419108-2 | Acc. RT | RT78625 | 150 | 3-1393225-2 | RY II | RY613018 | 31 |
| 2-1393258-3 | SR2 M | V23047-A1060-A511 | 102 | 2-1419108-3 | Acc. RT | RT78626 | 150 | 3-1393225-3 | RY II | RY613024 | 31 |
| 2-1393844-0 | RM 2/3/7 | RM738024 | 132 | 2-1419135-1 | PE | PE014015 | 22 | 3-1393225-4 | RY II | RY613048 | 31 |
| 2-1393844-1 | RM 2/3/7 | RM7380C4 | 132 | 2-1419136-2 | RMC/RMD | RMD35024 | 143 | 3-1393225-5 | RY II | RY613060 | 31 |
| 2-1393844-2 | RM 2/3/7 | RM739730 | 132 | 2-1419136-5 | RP II/1 | RP31D524 | 52 | 3-1393230-0 | RP II/1 | RP310018 | 52 |
| 2-1393844-3 | Acc. RM | RM78702 | 162 | 2-1419136-6 | RP II/1 | RP330009 | 52 | 3-1393230-1 | RP II/1 | RP310020 | 52 |
| 2-1393844-4 | Acc. RM | RM78704 | 162 | 2-1419136-7 | RP II/2 | RP42C110 | 72 | 3-1393230-2 | RP II/1 | RP310024 | 52 |
| 2-1393844-5 | Acc. RM | RM78705 | 162 | 2-1419136-8 | RP II/1 | RP818028 | 52 | 3-1393230-3 | RP II/1 | RP310048 | 52 |
| 2-1393844-6 | RM 8 | RM805012 | 140 | 2-1419142-2 | PE | PE014003 | 22 | 3-1393230-4 | RP II/1 | RP310060 | 52 |
| 2-1393844-7 | RM 8 | RM805024 | 140 | 2-1419142-3 | RE | RE032021 | 26 | 3-1393230-5 | RP II/1 | RP310110 | 52 |
| 2-1393844-8 | RM 8 | RM805720 | 140 | 2-1419143-0 | RP3SL | RP75L005 | 55 | 3-1393230-7 | RP II/1 | RP310524 | 52 |
| 2-1393844-9 | RM 8 | RM808024 | 140 | 2-1419143-1 | RP3SL | RP75L110 | 55 | 3-1393230-8 | RP II/1 | RP310548 | 52 |
| 2-1415004-1 | RY II | RY533036 | 31 | 2-1419143-2 | RP II/1 | RP811006 | 52 | 3-1393230-9 | RP II/1 | RP310615 | 52 |
| 2-1415006-1 | RP II/2 | RP421030 | 72 | 2-1419143-3 | RP II/1 | RP811110 | 52 | 3-1393231-0 | RP II/1 | RP418048 | 52 |
| 2-1415008-1 | PT | PT531615 | 123 | 2-1419143-4 | RP II/1 | RP811F05 | 52 | 3-1393231-1 | RP II/1 | RP418060 | 52 |
| 2-1415009-1 | RM 2/3/7 | RM705048 | 132 | 2-1419143-5 | RP II/1 | RP812006 | 52 | 3-1393231-2 | RP II/1 | RP418110 | 52 |
| 2-1415012-1 | SR2 M | V23047-A1110-A511 | 102 | 2-1419143-6 | RP II/1 | RP812048 | 52 | 3-1393231-3 | RP II/1 | RP418524 | 52 |
| 2-1415013-1 | MT | MT228110 | 129 | 2-1419143-7 | RP II/1 | RP812060 | 52 | 3-1393231-4 | RP II/1 | RP418548 | 52 |
| 2-1415014-1 | MT | MT328127 | 129 | 2-1419143-8 | RP II/1 | RP812127 | 52 | 3-1393231-5 | RP II/1 | RP418615 | 52 |
| 2-1415017-1 | SR6 | V23050-A1005-A551 | 110 | 2-1419151-0 | RP II/1 | RP438018 | 52 | 3-1393231-6 | RP II/1 | RP418730 | 52 |
| 2-1415018-1 | SR6 | V23050-A1018-A533 | 110 | 2-1419151-3 | RP II/2 | RP440110 | 72 | 3-1393231-7 | RP II/1 | RP419012 | 52 |
| 2-1415019-1 | SR6 | V23050-A1048-A551 | 110 | 2-1419151-7 | RP II/2 | RP440F24 | 72 | 3-1393231-8 | RP II/1 | RP419024 | 52 |
| 2-1415020-1 | RM 5/6 | RM505512 | 136 | 2-1419152-3 | Acc. RP,RT | RPMG0110 | 150 | 3-1393231-9 | RP II/1 | RP419110 | 52 |
| 2-1415021-1 | RT1 bistable | RT234F12 | 40 | 2-1419152-4 | Acc. RP,RT | RPMG0524 | 150 | 3-1393232-0 | RP II/1 | RP838110 | 52 |
| 2-1415024-1 | RT1 bistable | RT315F12 | 40 | 2-1419152-5 | Acc. RP,RT | RPMG0730 | 150 | 3-1393232-1 | RP II/1 | RP852024 | 52 |
| 2-1415025-1 | SNR Package | ST1P3L12 | 164 | 2-1419152-6 | RT1 bistable | RT334F24 | 40 | 3-1393233-1 | RP II/1 | RP310A04 | 52 |
| 2-1415026-1 | PT | PT380L24 | 123 | 3-1393107-2 | RM 2/3/7 | RM232048 | 132 | 3-1393233-2 | RP II/1 | RP310A05 | 52 |
| 2-1415028-1 | SR6 | SR6F4024 | 110 | 3-1393107-4 | RM 2/3/7 | RM232730 | 132 | 3-1393233-3 | RP II/1 | RP310B10 | 52 |
| 2-1415030-1 | PB | PB134012 | 82 | 3-1393107-5 | RM 2/3/7 | RM233024 | 132 | 3-1393233-4 | RP II/1 | RP310F60 | 52 |
| 2-1415036-1 | A. PT,RP,RT | PTMG0024 | 150 | 3-1393107-8 | RM 2/3/7 | RM302LC4 | 132 | 3-1393233-5 | RP II/1 | RP300012 | 52 |
| 2-1415037-1 | A. PT,RP,RT | PTMU0730 | 150 | 3-1393146-0 | RM 2/3/7 | RM205524 | 132 | 3-1393234-5 | RP II/1 | RP830524 | 52 |
| 2-1415039-1 | PT | PT270S15 | 123 | 3-1393146-1 | RM 2/3/7 | RM205615 | 132 | 3-1393234-7 | RP II/1 | RP832615 | 52 |
| 2-1415040-1 | SR6 | SR6E4024 | 110 | 3-1393146-2 | RM 2/3/7 | RM205730 | 132 | 3-1393234-9 | RP II/1 | RP838524 | 52 |
| 2-1415041-1 | SR6 | SR6E4048 | 110 | 3-1393146-3 | RM 2/3/7 | RM207024 | 132 | 3-1393235-0 | RP II/2 | RP440006 | 72 |
| 2-1415042-1 | SR6 Z | SR6ZA036 | 116 | 3-1393146-4 | RM 2/3/7 | RM207730 | 132 | 3-1393235-1 | RP II/2 | RP440009 | 72 |
| 2-1415044-1 | RP II/1 | RP31L048 | 52 | 3-1393146-5 | RM 2/3/7 | RM208024 | 132 | 3-1393235-2 | RP II/2 | RP441F05 | 72 |
| 2-1415045-1 | PT | PT571220 | 123 | 3-1393146-6 | RM 2/3/7 | RM209730 | 132 | 3-1393235-3 | RP II/2 | RP441012 | 72 |
| 2-1415054-1 | SR4 D/M | SR4M4040 | 105 | 3-1393146-8 | RM 2/3/7 | RM232024 | 132 | 3-1393235-4 | RP II/2 | RP441060 | 72 |
| 2-1415055-1 | SR4 D/M | SR4D4021 | 105 | 3-1393146-9 | RM 2/3/7 | RM232524 | 132 | 3-1393235-5 | RP II/2 | RP441090 | 72 |
| 2-1415056-1 | SR6sensitive | SR6B4S09 | 113 | 3-1393147-0 | RM 8 | RM805548 | 140 | 3-1393235-6 | RP II/2 | RP460F24 | 72 |
| 2-1415057-1 | SR6sensitive | SR6A4S09 | 113 | 3-1393147-1 | RM 8 | RM805615 | 140 | 3-1393235-7 | RP II/2 | RP82AF24 | 72 |
| 2-1415058-1 | SR6sensitive | SR6C4S09 | 113 | 3-1393147-2 | RM 8 | RM805627 | 140 | 3-1393235-8 | RP II/2 | RP82AF48 | 72 |
| 2-1415060-1 | SR6 Z | SR6ZB524 | 116 | 3-1393147-3 | RM 8 | RM805730 | 140 | 3-1393235-9 | RP II/2 | RP82A012 | 72 |
| 2-1415062-1 | RM 8 | RM8351B0 | 140 | 3-1393147-4 | RM 8 | RM805900 | 140 | 3-1393236-0 | SNR | V23092-A1024-A801 | 28 |
| 2-1415064-1 | PE | PE014C06 | 22 | 3-1393147-6 | RM 8 | RM808012 | 140 | 3-1393236-5 | SNR | V23092-A1048-A201 | 28 |
| 2-1415068-1 | SNR | V23092-A1012-A802 | 28 | 3-1393147-7 | RM 8 | RM808824 | 140 | 3-1393236-6 | SNR | V23092-A1048-A202 | 28 |
| 2-1415073-1 | RT Package | RT454R24 | 165 | 3-1393147-8 | RM 8 | RM809615 | 140 | 3-1393236-7 | SNR | V23092-A1048-A301 | 28 |
| 2-1415074-1 | RT Package | RT455T30 | 165 | 3-1393147-9 | RM 8 | RM809730 | 140 | 3-1393236-8 | SNR | V23092-A1048-A302 | 28 |
| 2-1415075-1 | PT Package | PT3S7LC4 | 166 | 3-1393148-9 | RM 2/3/7 | RM235012 | 132 | 3-1393236-9 | SNR | V23092-A1048-A801 | 28 |
| 2-1415403-7 | 409 bistable | 0409 67 001 000 | 58 | 3-1393149-6 | RM 2/3/7 | RM735024 | 132 | 3-1393238-0 | RT1 dc/ac | RTB34012 | 37 |
| 2-1415403-8 | 409 bistable | 0409 67 002 000 | 58 | 3-1393149-7 | RM 2/3/7 | RM735524 | 132 | 3-1393238-1 | RT1 dc/ac | RTB34015 | 37 |
| 2-1415403-9 | 409 bistable | 0409 67 003 000 | 58 | 3-1393161-3 | Acc. RT | RT16016 | 150 | 3-1393238-2 | RT1 dc/ac | RTB34018 | 37 |
| 2-1415404 | | | | | | | | | | | |

Part number reference list

| Part No | Relay | Product key | Page | Part No | Relay | Product key | Page | Part No | Relay | Product key | Page |
|-------------|---------------|-------------------|------|-------------|---------------|-------------------|------|-------------|---------------|-------------------|------|
| 3-1393239-5 | RT1 dc/ac | RT134730 | 37 | 3-1415419-1 | 419 | 0419 01 3103 12 | 99 | 4-1393230-9 | RP II/1 | RP330024 | 52 |
| 3-1393239-6 | RT1 sensitive | RT174005 | 42 | 3-1415419-2 | 419 | 0419 01 5803 07 | 99 | 4-1393231-0 | RP II/1 | RP430F12 | 52 |
| 3-1393239-7 | RT1 sensitive | RT174006 | 42 | 3-1415419-3 | 419 | 0419 01 6003 07 | 99 | 4-1393231-1 | RP II/1 | RP430012 | 52 |
| 3-1393239-8 | RT1 sensitive | RT174012 | 42 | 3-1415430-0 | 430 1/2pole | 0430 06 0721 07 | 96 | 4-1393231-2 | RP II/1 | RP430024 | 52 |
| 3-1393239-9 | RT1 sensitive | RT174024 | 42 | 3-1415430-1 | 430 1/2pole | 0430 06 0901 00 | 96 | 4-1393231-3 | RP II/1 | RP430524 | 52 |
| 3-1393240-0 | RT1 inrush | RT33L005 | 44 | 3-1415430-2 | 430 1/2pole | 0430 06 0903 00 | 96 | 4-1393231-4 | RP II/1 | RP430615 | 52 |
| 3-1393240-1 | RT1 inrush | RT33L006 | 44 | 3-1415430-3 | 430 1/2pole | 0430 06 0911 00 | 96 | 4-1393231-5 | RP II/1 | RP431012 | 52 |
| 3-1393240-2 | RT1 inrush | RT33L009 | 44 | 3-1415430-4 | 430 1/2pole | 0430 06 0911 06 | 96 | 4-1393231-6 | RP II/1 | RP431024 | 52 |
| 3-1393240-3 | RT1 inrush | RT33L012 | 44 | 3-1415430-5 | 430 1/2pole | 0430 06 0913 00 | 96 | 4-1393231-7 | RP II/1 | RP432012 | 52 |
| 3-1393240-4 | RT1 inrush | RT33L018 | 44 | 3-1415430-6 | 430 1/2pole | 0430 06 1003 00 | 96 | 4-1393231-8 | RP II/1 | RP432024 | 52 |
| 3-1393240-5 | RT1 inrush | RT33L024 | 44 | 3-1415430-7 | 430 1/2pole | 0430 06 1011 00 | 96 | 4-1393231-9 | RP II/1 | RP438009 | 52 |
| 3-1393240-6 | RT1 inrush | RT33L048 | 44 | 3-1415430-8 | 430 1/2pole | 0430 06 1013 00 | 96 | 4-1393233-0 | RP II/1 | RP330A24 | 52 |
| 3-1393240-7 | RT1 inrush | RT33L060 | 44 | 3-1415430-9 | 430 1/2pole | 0430 06 1101 00 | 96 | 4-1393233-1 | RP II/1 | RP330018 | 52 |
| 3-1393240-8 | RT1 bistable | RT334F05 | 40 | 3-1419104-3 | T9A | T9AS5D22-12 | 87 | 4-1393233-5 | RP II/1 | RP410F06 | 52 |
| 3-1393240-9 | RT1 bistable | RT334F12 | 40 | 3-1419104-6 | T9A | T9AS5D22-24 | 87 | 4-1393233-6 | RP II/1 | RP411A05 | 52 |
| 3-1393243-0 | RT2 bistable | RTE44A24 | 70 | 3-1419108-5 | RT1 dc/ac | RTD34012 | 37 | 4-1393233-8 | RP II/1 | RP412009 | 52 |
| 3-1393243-1 | RT2 dc/ac | RTE44009 | 67 | 3-1419108-8 | RT1 dc/ac | RTD34024 | 37 | 4-1393234-0 | RP II/1 | RP838615 | 52 |
| 3-1393243-2 | RT2 dc/ac | RTE44012 | 67 | 3-1419111-8 | Acc. PT | PT16016 | 154 | 4-1393234-9 | RP II/2 | RP840009 | 72 |
| 3-1393243-3 | RT2 dc/ac | RTE44024 | 67 | 3-1419111-9 | Acc. PT | PT16040 | 154 | 4-1393234-5 | RP II/2 | RP840524 | 72 |
| 3-1393243-4 | RT2 dc/ac | RTE44615 | 67 | 3-1419126-6 | PCD | PCD-105-D1MH | 80 | 4-1393234-6 | RP II/2 | RP858615 | 52 |
| 3-1393243-5 | RT2 dc/ac | RTE44730 | 67 | 3-1419136-7 | RT1 sensitive | RT174036 | 42 | 4-1393234-7 | RP II/2 | RP420005 | 72 |
| 3-1393250-0 | W28 | W28-XQ1A-15 | 167 | 3-1419136-9 | RT1 inrush | RT31LA06 | 44 | 4-1393234-8 | RP II/2 | RP420006 | 72 |
| 3-1393250-1 | W28 | W28-XQ1A-16 | 167 | 3-1419143-0 | RP II/1 | RP81A110 | 52 | 4-1393234-9 | RP II/2 | RP420009 | 72 |
| 3-1393250-2 | W28 | W28-XQ1A-2 | 167 | 3-1419143-8 | RP II/1 | RP831110 | 52 | 4-1393235-0 | RP II/2 | RP82A048 | 72 |
| 3-1393250-3 | W28 | W28-XQ1A-20 | 167 | 3-1419143-9 | RP II/1 | RP831615 | 52 | 4-1393235-1 | RP II/2 | RP82A730 | 72 |
| 3-1393250-4 | W28 | W28-XQ1A-3 | 167 | 3-1419151-2 | RP II/2 | RP441730 | 72 | 4-1393235-2 | RP II/2 | RP82C024 | 72 |
| 3-1393250-7 | W28 | W28-XQ1A-4 | 167 | 3-1419151-9 | RP II/1 | RP710010 | 52 | 4-1393235-3 | RP II/2 | RP82C730 | 72 |
| 3-1393250-8 | W28 | W28-XQ1A-5 | 167 | 4-1393090-8 | MT | MT221006 | 129 | 4-1393235-4 | RP II/2 | RP82F24 | 72 |
| 3-1393250-9 | W28 | W28-XQ1A-6 | 167 | 4-1393090-9 | MT | MT221012 | 129 | 4-1393235-5 | RP II/2 | RP820015 | 72 |
| 3-1393252-7 | W6 | W67-X2Q10-2 | 171 | 4-1393091-4 | MT | MT311060 | 129 | 4-1393235-6 | RP II/2 | RP821A24 | 72 |
| 3-1393253-2 | W6 | W68-X2Q12-15 | 171 | 5-1419150-3 | RM 2/3/7 | RM302730 | 132 | 4-1393235-7 | RP II/2 | RP821F60 | 72 |
| 3-1393253-4 | W6 | W68-X2Q12-20 | 171 | 4-1393146-0 | RM 2/3/7 | RM232615 | 132 | 4-1393235-8 | RP II/2 | RP821005 | 72 |
| 3-1393253-7 | W6 | W68-X2Q12-30 | 171 | 4-1393146-2 | RM 2/3/7 | RM233615 | 132 | 4-1393235-9 | RP II/2 | RP821110 | 72 |
| 3-1393253-8 | W6 | W68-X2Q12-5 | 171 | 4-1393146-4 | RM 2/3/7 | RM235048 | 132 | 4-1393236-2 | SNR | V23092-A1060-A201 | 28 |
| 3-1393844-0 | RM 8 | RM809012 | 140 | 4-1393146-5 | RM 2/3/7 | RM235730 | 132 | 4-1393236-3 | SNR | V23092-A1060-A301 | 28 |
| 3-1393844-1 | RM 8 | RM835012 | 140 | 4-1393146-6 | RM 2/3/7 | RM235740 | 132 | 4-1393236-4 | SNR | V23092-A1060-A302 | 28 |
| 3-1415001-1 | RT1 bistable | RT314A60 | 40 | 4-1393146-7 | RM 2/3/7 | RM238012 | 132 | 4-1393238-0 | RT1 dc/ac | RTB34730 | 37 |
| 3-1415002-1 | PT | PT270T30 | 123 | 4-1393146-8 | RM 2/3/7 | RM302LE8 | 132 | 4-1393238-1 | RT1 dc/ac | RTB35730 | 37 |
| 3-1415006-1 | SR2 M | V23047-A1048-A501 | 102 | 4-1393146-9 | RM 2/3/7 | RM302MBO | 132 | 4-1393238-2 | RT1 sensitive | RTB74005 | 42 |
| 3-1415007-1 | RY II | RYA30021 | 31 | 4-1393147-0 | RM 8 | RM835L12 | 140 | 4-1393238-3 | RT1 sensitive | RTB74009 | 42 |
| 3-1415011-1 | SR2 M | V23047-A1006-A501 | 102 | 4-1393147-1 | RM 8 | RM835024 | 140 | 4-1393238-4 | RT1 sensitive | RTB74012 | 42 |
| 3-1415013-1 | MT | MT228127 | 129 | 4-1393147-2 | RM 8 | RM835048 | 140 | 4-1393238-5 | RT1 sensitive | RTB74018 | 42 |
| 3-1415015-1 | RM 2/3/7 | RM232V00 | 132 | 4-1393147-3 | RM 8 | RM835524 | 140 | 4-1393238-6 | RT1 sensitive | RTB74024 | 42 |
| 3-1415017-1 | SR6 | V23050-A1006-A551 | 110 | 4-1393147-4 | RM 8 | RM835615 | 140 | 4-1393238-7 | RT1 sensitive | RTB84009 | 42 |
| 3-1415018-1 | SR6 | V23050-A1021-A533 | 110 | 4-1393147-5 | RM 8 | RM835720 | 140 | 4-1393238-8 | RT1 dc/ac | RTC14006 | 37 |
| 3-1415019-1 | SR6 | V23050-A1060-A551 | 110 | 4-1393147-6 | RM 8 | RM835730 | 140 | 4-1393238-9 | RT1 dc/ac | RTC14012 | 37 |
| 3-1415020-1 | PT | PT570N20 | 123 | 4-1393147-7 | RM 8 | RM838012 | 140 | 4-1393239-0 | RT1 sensitive | RT174048 | 42 |
| 3-1415021-1 | SR2 M | V23047-A1080-A501 | 102 | 4-1393147-8 | RM 8 | RM838024 | 140 | 4-1393239-1 | RT1 sensitive | RT174060 | 42 |
| 3-1415022-1 | RT1 inrush | RTD3KF05 | 44 | 4-1393147-9 | RM 8 | RM838048 | 140 | 4-1393239-2 | RT1 sensitive | RT175005 | 42 |
| 3-1415024-1 | SNR Package | ST1P3024 | 164 | 4-1393148-4 | RM 2/3/7 | RM235720 | 132 | 4-1393239-3 | RT1 sensitive | RT175012 | 42 |
| 3-1415025-1 | SNR Package | ST1P3L24 | 164 | 4-1393148-7 | RM 2/3/7 | RM239730 | 132 | 4-1393239-4 | RT1 sensitive | RT175024 | 42 |
| 3-1415026-1 | PT | PT380R24 | 123 | 4-1393149-1 | RM 2/3/7 | RM735730 | 132 | 4-1393239-5 | RT1 sensitive | RT184005 | 42 |
| 3-1415028-1 | PT | PT570L12 | 123 | 4-1393149-5 | RM 2/3/7 | RM739024 | 132 | 4-1393239-6 | RT1 sensitive | RT184006 | 42 |
| 3-1415030-1 | PB | PB134024 | 82 | 4-1393149-9 | Acc. RM | RM78701 | 162 | 4-1393239-7 | RT1 sensitive | RT184012 | 42 |
| 3-1415035-1 | Acc. MT | MT178755 | 158 | 4-1393211-0 | T92 | T92P11A22-120 | 90 | 4-1393239-8 | RT1 sensitive | RT184018 | 42 |
| 3-1415036-1 | A. PT,RP,RT | PTMG0524 | 150 | 4-1393211-3 | T92 | T92P11A22-24 | 90 | 4-1393239-9 | RT1 sensitive | RT184024 | 42 |
| 3-1415037-1 | A. PT,RP,RT | PTMV0524 | 150 | 4-1393211-4 | T92 | T92P11A22-240 | 90 | 4-1393240-0 | RT1 dc/ac | RT334005 | 37 |
| 3-1415040-1 | SR6 | SR6F4018 | 110 | 4-1393215-0 | Card E | V23057-A0013-A401 | 74 | 4-1393240-1 | RT1 dc/ac | RT334006 | 37 |
| 3-1415041-1 | SR6 | SR6E4110 | 110 | 4-1393215-2 | Card E | V23057-A0013-A901 | 74 | 4-1393240-3 | RT1 dc/ac | RT334009 | 37 |
| 3-1415042-1 | SR6 Z | SR6ZC024 | 116 | 4-1393215-6 | Card E | V23057-A0014-A401 | 74 | 4-1393240-5 | RT1 dc/ac | RT334012 | 37 |
| 3-1415043-1 | Acc. PT | PT78604 | 154 | 4-1393215-7 | Card E | V23057-A0015-A201 | 74 | 4-1393240-6 | RT1 dc/ac | RT334015 | 37 |
| 3-1415044-1 | RM 8 | RM809548 | 140 | 4-1393215-8 | Card E | V23057-A0015-A401 | 74 | 4-1393240-7 | RT1 dc/ac | RT334018 | 37 |
| 3-1415046-1 | PT | PT581012 | 123 | 4-1393215-9 | Card E | V23057-A0015-B101 | 74 | 4-1393240-8 | RT1 dc/ac | RT334024 | 37 |
| 3-1415053-1 | PE | PE014A06 | 22 | 4-1393216-1 | Card E | V23057-E0006-A201 | 74 | 4-1393240-9 | RT1 dc/ac | RT334036 | 37 |
| 3-1415054-1 | SR4 D/M | SR4M4048 | 105 | 4-1393216-2 | Card E | V23057-F0006-A201 | 74 | 4-1393243-2 | RT2 dc/ac | RT423024 | 67 |
| 3-1415055-1 | SR4 D/M | SR4D4024 | 105 | 4-1393216-3 | Card E | V23057-F0008-A201 | 74 | 4-1393243-3 | RT2 dc/ac | RT423730 | 67 |
| 3-1415056-1 | SR6sensitive | SR6B4S12 | 113 | 4-1393222-2 | MSR | V23061-A1007-A402 | 34 | 4-1393243-4 | RT2 bistable | RT424A05 | 70 |
| 3-1415057-1 | SR6sensitive | SR6A4S12 | 113 | 4-1393222-6 | MSR | V23061-A1007-A502 | 34 | 4-1393243-5 | RT2 bistable | RT424A06 | 70 |
| 3-1415058-1 | SR6sensitive | SR6C4S12 | 113 | 4-1393222-7 | MSR | V23061-A1007-A602 | 34 | 4-1393243-6 | RT2 bistable | RT424A12 | 70 |
| 3-1415060-1 | SR6 Z | SR6ZB730 | 116 | 4-1393223-0 | MSR | V23061-B1009-A601 | 34 | 4-1393243-7 | RT2 bistable | RT424A24 | 70 |
| 3-1415064-1 | PE | PE014C05 | 22 | 4-1393223-2 | MSR | V23061-B1010-A401 | 34 | 4-1393243-9 | RT2 bistable | RT424A36 | 70 |
| 3-1415068-1 | SNR | V23092-A1048-A802 | 28 | 4-1393223-3 | MSR | V23061-B1010-A501 | 34 | 4-1393250-0 | W28 | W28-XQ1A-7 | 167 |
| 3-1415073-1 | RT Package | RT4S4T30 | 165 | 4-1393223-4 | MSR | V23061-B1010-A601 | 34 | 4-1393250-1 | W28 | W28-XQ1A-8 | 167 |
| 3-1415074-1 | RT Package | RT3SKLC4 | 165 | 4-1393223-7 | MSR | V23061-B1011-A401 | 34 | 4-1393250-5 | W28 | W28-XQ1B-3 | 167 |
| 3-1415075-1 | PT Package | PT5S8RC4 | 166 | 4-1393223-8 | MSR | V23061-B1013-A401 | 34 | 4-1393254-7 | W9 | W91-X152-35 | 171 |
| 3-1415404-0 | 430 3mm | 0430 45 2811 01 | 93 | 4-1393223-9 | MSR | V23061-B1014-A501 | 34 | 4-1393844-5 | RMC/RMD | RMC05024 | 143 |
| 3-1415404-1 | 430 3mm | 0430 45 2811 03 | 93 | 4-1393224-0 | RY II | RY210036 | 31 | 4-1393844-6 | RMC/RMD | RMC05048 | 143 |
| 3-1415404-2 | 430 1/2pole | 0430 46 0711 01 | 96 | 4-1393224-1 | RY II | RY210048 | 31 | 4-1393844-7 | RMC/RMD | RMD05730 | 143 |
| 3-1415404-3 | 430 1/2pole | 0430 46 0712 01 | 96 | 4-1393224-2 | RY II | RY211005 | 31 | 4-1415007-1 | RTHsensitive | RTB84005 | 48 |
| 3-1415404-4 | 430 1/2pole | 0430 46 0713 01 | 96 | 4-1393224-3 | RY II | RY211006 | 31 | 4-1415011-1 | MT | MT221125 | 129 |
| 3-1415404-5 | 430 1/2pole | 0430 46 5811 02 | 96 | 4-1393224-4 | RY II | RY211008 | 31 | 4-1415014-1 | MT | MT226127 | 129 |
| 3-1415404-6 | 430 1/2pole | 0430 46 5812 02 | 96 | 4-1393224-5 | RY II | RY211009 | 31 | 4-1415017-1 | SR6 | V23050-A1009-A551 | 110 |
| 3-1415404-7 | 430 1/2pole | 0430 46 5813 02 | 96 | 4-1393224-6 | RY II | RY211012 | 31 | 4-1415018-1 | SR6 | V23050-A1036-A533 | 110 |
| 3-1415404-8 | 430 1/2pole | 0430 46 6811 03 | 96 | 4-1393224-7 | RY II | RY211018 | 31 | 4-1415019-1 | SR6 | V23050-A1085-A551 | 110 |
| 3-1415404-9 | 430 3mm | 0430 55 1001 00 | 93 | 4-1393224-8 | RY II | RY211021 | 31 | 4-1415021-1 | SR2 M | V23047-A1080-A511 | 102 |
| 3-1415410-0 | 410 125°C | 0410 63 046 001 | 63 | 4-1393224-9 | RY II | RY211024 | 31 | 4- | | | |

© Tyco Electronics Austria GmbH 2002. All Rights Reserved.

All technical data listed is for description purposes only and does not guarantee characteristics. All drawings, photos and descriptions are subject to change without prior notice.

We are not able to guarantee that the specified circuits, descriptions and tables are not covered by rights of third parties.

Terms of delivery and rights to change design reserved.

Mouser Electronics

Authorized Distributor

Click to View Pricing, Inventory, Delivery & Lifecycle Information:

[TE Connectivity:](#)

[1393216-9](#) [1-1393204-4](#)

Компания «Океан Электроники» предлагает заключение долгосрочных отношений при поставках импортных электронных компонентов на взаимовыгодных условиях!

Наши преимущества:

- Поставка оригинальных импортных электронных компонентов напрямую с производств Америки, Европы и Азии, а так же с крупнейших складов мира;
- Широкая линейка поставок активных и пассивных импортных электронных компонентов (более 30 млн. наименований);
- Поставка сложных, дефицитных, либо снятых с производства позиций;
- Оперативные сроки поставки под заказ (от 5 рабочих дней);
- Экспресс доставка в любую точку России;
- Помощь Конструкторского Отдела и консультации квалифицированных инженеров;
- Техническая поддержка проекта, помощь в подборе аналогов, поставка прототипов;
- Поставка электронных компонентов под контролем ВП;
- Система менеджмента качества сертифицирована по Международному стандарту ISO 9001;
- При необходимости вся продукция военного и аэрокосмического назначения проходит испытания и сертификацию в лаборатории (по согласованию с заказчиком);
- Поставка специализированных компонентов военного и аэрокосмического уровня качества (Xilinx, Altera, Analog Devices, Intersil, Interpoint, Microsemi, Actel, Aeroflex, Peregrine, VPT, Syfer, Eurofarad, Texas Instruments, MS Kennedy, Miteq, Cobham, E2V, MA-COM, Hittite, Mini-Circuits, General Dynamics и др.);

Компания «Океан Электроники» является официальным дистрибьютором и эксклюзивным представителем в России одного из крупнейших производителей разъемов военного и аэрокосмического назначения «JONHON», а так же официальным дистрибьютором и эксклюзивным представителем в России производителя высокотехнологичных и надежных решений для передачи СВЧ сигналов «FORSTAR».



JONHON

«JONHON» (основан в 1970 г.)

Разъемы специального, военного и аэрокосмического назначения:

(Применяются в военной, авиационной, аэрокосмической, морской, железнодорожной, горно- и нефтедобывающей отраслях промышленности)

«FORSTAR» (основан в 1998 г.)

ВЧ соединители, коаксиальные кабели, кабельные сборки и микроволновые компоненты:

(Применяются в телекоммуникациях гражданского и специального назначения, в средствах связи, РЛС, а так же военной, авиационной и аэрокосмической отраслях промышленности).



Телефон: 8 (812) 309-75-97 (многоканальный)

Факс: 8 (812) 320-03-32

Электронная почта: ocean@oceanchips.ru

Web: <http://oceanchips.ru/>

Адрес: 198099, г. Санкт-Петербург, ул. Калинина, д. 2, корп. 4, лит. А